

HP Notebook PC User Guide

© Copyright 2009 Hewlett-Packard
Development Company, L.P.

Bluetooth is a trademark owned by its proprietor and used by Hewlett-Packard Company under license. Microsoft and Windows are U.S. registered trademarks of Microsoft Corporation. SD Logo is a trademark of its proprietor.

The information contained herein is subject to change without notice. The only warranties for HP products and services are set forth in the express warranty statements accompanying such products and services. Nothing herein should be construed as constituting an additional warranty. HP shall not be liable for technical or editorial errors or omissions contained herein.

Second Edition: December 2009

First Edition: September 2009

Document Part Number: 586038-002

Product notice

This user guide describes features that are common to most models. Some features may not be available on your computer.

To obtain the latest information in the *HP Notebook PC User Guide*, go to the HP Web site at <http://www.hp.com/support>.

Safety warning notice

-
- ⚠ **WARNING!** To reduce the possibility of heat-related injuries or of overheating the computer, do not place the computer directly on your lap or obstruct the computer air vents. Use the computer only on a hard, flat surface. Do not allow another hard surface, such as an adjoining optional printer, or a soft surface, such as pillows or rugs or clothing, to block airflow. Also, do not allow the AC adapter to contact the skin or a soft surface, such as pillows or rugs or clothing, during operation. The computer and the AC adapter comply with the user-accessible surface temperature limits defined by the International Standard for Safety of Information Technology Equipment (IEC 60950).
-

Table of contents

1 Using HP QuickWeb (select models only)

| | |
|--|---|
| Starting HP QuickWeb | 2 |
| Disabling and enabling HP QuickWeb | 2 |

2 Hardware features

| | |
|--------------------------------------|----|
| Identifying the hardware | 3 |
| Top components | 4 |
| TouchPad | 4 |
| Lights | 5 |
| Buttons | 6 |
| Keys | 7 |
| Front components | 8 |
| Right-side components | 9 |
| Left-side components | 10 |
| Display components | 11 |
| Bottom components | 12 |
| Wireless antennas | 13 |
| Additional hardware components | 14 |
| Identifying the labels | 15 |

3 Wireless and local area network

| | |
|--|----|
| Using wireless devices | 16 |
| Identifying wireless and network status icons | 17 |
| Using the wireless controls | 17 |
| Using the wireless button | 18 |
| Using Wireless Assistant software (select models only) | 18 |
| Using HP Connection Manager (select models only) | 19 |
| Using operating system controls | 19 |
| Using a WLAN | 20 |
| Setting up a WLAN | 20 |
| Protecting your WLAN | 21 |
| Connecting to a WLAN | 22 |
| Roaming to another network | 22 |
| Using HP Mobile Broadband (select models only) | 23 |

| | |
|---|----|
| Inserting a SIM | 24 |
| Removing a SIM | 25 |
| Using Bluetooth wireless devices | 26 |
| Bluetooth and Internet Connection Sharing (ICS) | 26 |
| Troubleshooting wireless connection problems | 27 |
| Cannot connect to a WLAN | 27 |
| Cannot connect to a preferred WLAN network | 28 |
| Network icon for WLAN is not displayed | 28 |
| Current WLAN network security codes are unavailable | 28 |
| WLAN connection is very weak | 29 |
| Cannot connect to the wireless router | 29 |
| Connecting to a local area network (LAN) | 30 |

4 Multimedia

| | |
|--|----|
| Multimedia features | 31 |
| Identifying your multimedia components | 32 |
| Adjusting the volume | 33 |
| Multimedia software | 35 |
| Using preinstalled multimedia software | 35 |
| Installing multimedia software from the Internet | 35 |
| Audio | 36 |
| Connecting external audio devices | 36 |
| Checking your audio functions | 36 |
| Video | 37 |
| Connecting an external monitor or projector | 37 |
| Connecting an HDMI device | 38 |
| Configuring audio for HDMI (select models only) | 38 |
| Webcam | 39 |

5 Drives and external devices

| | |
|--|----|
| Drives | 40 |
| Identifying installed drives | 40 |
| Handling drives | 41 |
| Improving hard drive performance | 42 |
| Using Disk Defragmenter | 42 |
| Using Disk Cleanup | 42 |
| Replacing the hard drive in the hard drive bay | 43 |
| Using external drives | 46 |
| Connecting optional external drives | 47 |
| Sharing optical drives | 47 |
| External devices | 48 |
| Using a USB device | 48 |
| Connecting a USB device | 48 |

| | |
|--------------------------------------|----|
| Removing a USB device | 49 |
| Using Digital Media Slot cards | 49 |
| Inserting a digital card | 49 |
| Removing a digital card | 50 |

6 Memory modules

7 Pointing devices and keyboard

| | |
|---|----|
| Setting pointing device preferences | 55 |
| Using pointing devices | 55 |
| Using the TouchPad | 55 |
| Connecting an external mouse | 55 |
| Using the keyboard | 56 |
| Using hotkeys | 56 |
| Initiating Sleep | 57 |
| Switching the screen image | 57 |
| Decreasing screen brightness | 58 |
| Increasing screen brightness | 58 |
| Initiating QuickLock | 58 |
| Muting speaker sound | 58 |
| Decreasing speaker volume | 58 |
| Increasing speaker volume | 58 |

8 Power management

| | |
|---|----|
| Setting power options | 59 |
| Using power-saving states | 59 |
| Initiating and exiting Sleep | 59 |
| Initiating and exiting Hibernation | 60 |
| Using the battery meter | 60 |
| Using power plans | 61 |
| Viewing the current power plan | 61 |
| Selecting a different power plan | 61 |
| Customizing power plans | 61 |
| Setting password protection on wakeup | 61 |
| Using external AC power | 62 |
| Connecting the AC adapter | 63 |
| Testing an AC adapter | 63 |
| Using battery power | 64 |
| Finding battery information in Help and Support | 64 |
| Using Battery Check | 64 |
| Displaying the remaining battery charge | 65 |
| Inserting or removing the battery | 65 |
| Charging a battery | 66 |

| | |
|---|----|
| Maximizing battery discharge time | 67 |
| Managing low battery levels | 67 |
| Identifying low battery levels | 67 |
| Resolving a low battery level | 68 |
| Resolving a low battery level when external power is available | 68 |
| Resolving a low battery level when a charged battery is available | 68 |
| Resolving a low battery level when no power source is available | 68 |
| Resolving a low battery level when the computer cannot exit Hibernation | 68 |
| Calibrating a battery | 69 |
| Step 1: Fully charge the battery | 69 |
| Step 2: Disable Hibernation and Sleep | 69 |
| Step 3: Discharge the battery | 70 |
| Step 4: Fully recharge the battery | 70 |
| Step 5: Reenable Hibernation and Sleep | 71 |
| Conserving battery power | 72 |
| Storing a battery | 72 |
| Disposing of a used battery | 72 |
| Shutting down the computer | 73 |

9 Security

| | |
|--|----|
| Protecting the computer | 74 |
| Using passwords | 75 |
| Setting passwords in Windows | 75 |
| Setting passwords in Setup Utility | 76 |
| Administrator password | 76 |
| Managing an administrator password | 76 |
| Entering an administrator password | 77 |
| Power-on password | 77 |
| Managing a power-on password | 77 |
| Entering a power-on password | 77 |
| Using antivirus software | 78 |
| Using firewall software | 78 |
| Installing critical updates | 79 |

10 Software updates

| | |
|-------------------------------------|----|
| Updating the BIOS | 81 |
| Determining the BIOS version | 81 |
| Downloading a BIOS update | 81 |
| Updating programs and drivers | 83 |

11 Setup Utility (BIOS)

| | |
|---|----|
| Starting Setup Utility | 84 |
| Using Setup Utility | 85 |
| Changing the language of Setup Utility | 85 |
| Navigating and selecting in Setup Utility | 85 |
| Displaying system information | 86 |
| Restoring default settings in Setup Utility | 86 |
| Exiting Setup Utility | 87 |
| Setup Utility menus | 87 |
| Main menu | 87 |
| Security menu | 87 |
| System Configuration menu | 88 |
| Diagnostics menu | 88 |

| | |
|--------------------|-----------|
| Index | 89 |
|--------------------|-----------|

1 Using HP QuickWeb (select models only)

Your computer's main operating system is Windows®. Your computer may also feature HP QuickWeb (select models only).

- The Microsoft® Windows operating system displays the desktop on the display and controls your computer's hardware, peripherals, and software programs.
- If your computer includes HP QuickWeb, it allows you to quickly browse the Internet, view digital photos, listen to music, or keep in touch using e-mail, instant messages, or Skype (select models only), without having to start your main operating system. HP QuickWeb is also referred to as Instant-On Software (IOS).

 **NOTE:** You can access the software Help when you are in HP QuickWeb by clicking the Help icon in the notification area.

Starting HP QuickWeb

To start HP QuickWeb:

1. Turn on your computer. The HP QuickWeb screen opens.
2. Click an icon on the HP QuickWeb screen to start a program.

To start HP QuickWeb from Microsoft Windows:

- ▲ Select **Start**, click the arrow next to the Shut down button, and then click **Restart**. Your computer restarts and displays the HP QuickWeb home page.



NOTE: To learn more about HP QuickWeb, refer to the HP QuickWeb software Help.

Disabling and enabling HP QuickWeb

To disable or reenable HP QuickWeb from within the Windows operating system:

1. Click **Start**, click **All Programs**, and then click **HP QuickWeb**. The **HP QuickWeb Installer** folder displays. Click **HP QuickWeb Configuration Tool**.
2. Select the Enable **HP QuickWeb** check box.
3. Click **OK**.



NOTE: The HP QuickWeb Configuration Tool can also be accessed by clicking **Start**, clicking **Control Panel**, and then clicking the **View by** arrow. Select **Large icons** or **Small icons** to locate the HP QuickWeb Configuration Tool.

2 Hardware features

Identifying the hardware

Components included with the computer may vary by region and model. The illustrations in this chapter identify the standard features on most computer models.

To see a list of hardware installed in the computer:

1. Select **Start > Control panel > System and Security**.
2. In the System area, click **Device Manager**.

You can also add hardware or modify device configurations using Device Manager.

Top components

TouchPad





| Component | Description |
|----------------------------|---|
| (1) TouchPad* | Moves the pointer and selects or activates items on the screen. |
| (2) Left TouchPad button* | Functions like the left button on an external mouse. |
| (3) Right TouchPad button* | Functions like the right button on an external mouse. |
| (4) TouchPad scroll zone | Scrolls up or down. |

*This table describes factory settings. To view or change pointing device preferences, select **Start > Devices and Printers**. Then, right-click the device representing your computer, and select **Mouse**.

Lights



| Component | Description |
|--|--|
| (1) Caps lock light | On: Caps lock is on. |
| (2)  Power light | <ul style="list-style-type: none">On: The computer is on.Blinking: The computer is in the Sleep state.Off: The computer is off or in Hibernation. |
| (3)  Wireless light | <ul style="list-style-type: none">On: An integrated wireless device, such as a wireless local area network (WLAN) device and/or a Bluetooth® device, is on.Off: All wireless devices are off. |

Buttons





| Component | Description |
|---------------------|---|
| (1) Power button* | <ul style="list-style-type: none">• When the computer is off, press the button to turn on the computer.• When the computer is on, press the button briefly to initiate Sleep.• When the computer is in the Sleep state, press the button briefly to exit Sleep.• When the computer is in Hibernation, press the button briefly to exit Hibernation. <p>If the computer has stopped responding and Windows® shutdown procedures are ineffective, press and hold the power button for at least 5 seconds to turn off the computer.</p> <p>To learn more about your power settings, select Start > Control Panel > System and Security > Power Options.</p> |
| (2) Wireless button | <p>Turns the wireless feature on or off but does not create a wireless connection.</p> <p>NOTE: To establish a wireless connection, a wireless network must already be set up.</p> |

*This table describes factory settings. For information about changing factory settings, refer to the user guides located in Help and Support.

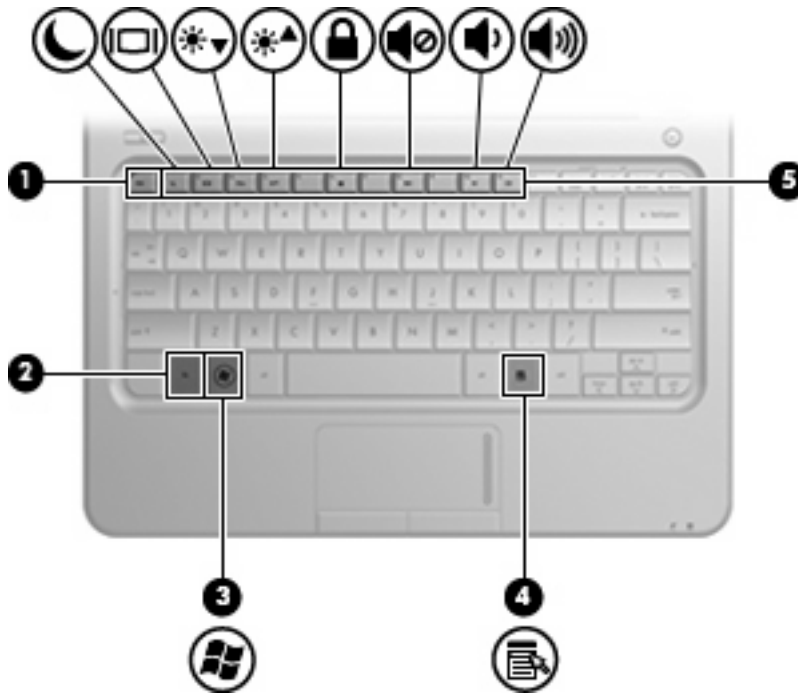

Keys



| Component | Description |
|--|--|
| (1) <code>esc</code> key | Displays system information when pressed in combination with the <code>fn</code> key. |
| (2) <code>fn</code> key | Executes frequently used system functions when pressed in combination with a function key. |
| (3)  Windows® logo key | Displays the Windows Start menu. |
| (4)  Windows applications key | Displays a shortcut menu for items beneath the pointer. |
| (5) Function keys | Execute frequently used system functions when pressed in combination with the <code>fn</code> key. |





Front components

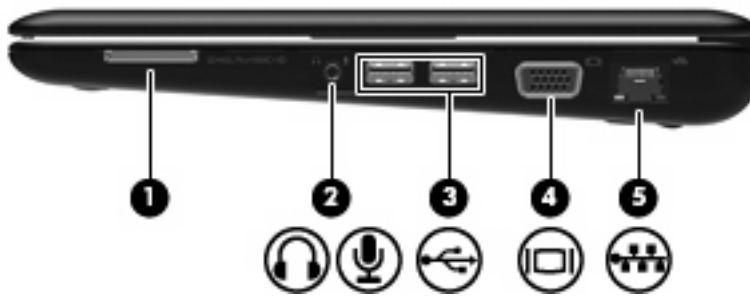

| Component | Description |
|---|---|
| (1) Speakers (2) | Produce sound. |
| (2)  Battery light | <ul style="list-style-type: none">• On: A battery is charging.• Blinking: A battery that is the only available power source has reached a low battery level. When the battery reaches a critical battery level, the battery light begins blinking rapidly.• Off: If the computer is plugged into an external power source, the light turns off when all batteries in the computer are fully charged. If the computer is not plugged into an external power source, the light stays off until the battery reaches a low battery level. |
| (3)  Drive light | Blinking: The hard drive or flash drive is being accessed. |



Right-side components

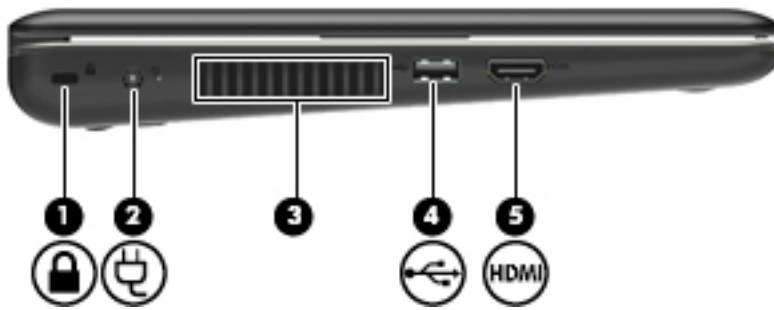

| Component | Description |
|---|--|
| (1) Digital Media Slot | Supports the following optional digital card formats: <ul style="list-style-type: none"> • Memory Stick (MS) • Memory Stick Pro (MS/Pro) • MultiMediaCard (MMC) • Secure Digital (SD) Memory Card • xD-Picture card |
| (2)  Audio-out (headphone) jack/Audio-in (microphone) jack | Produces sound when connected to optional powered stereo speakers, headphones, earbuds, a headset, or television audio. Also connects an optional headset microphone. <p>NOTE: When a device is connected to the jack, the computer speakers are disabled.</p> The audio component cable must have a 4-conductor connector. |
| (3)  USB ports (2) | Connect optional USB devices. |
| (4)  External monitor port | Connects an external VGA monitor or projector. |
| (5)  RJ-45 (network) jack | Connects a network cable. |

Left-side components



| Component | Description |
|---|---|
| (1)  Security cable slot | Attaches an optional security cable to the computer. NOTE: The security cable is designed to act as a deterrent, but it may not prevent the computer from being mishandled or stolen. |
| (2)  Power connector | Connects an AC adapter. |
| (3) Vent | Enables airflow to cool internal components. NOTE: The computer fan starts up automatically to cool internal components and prevent overheating. It is normal for the internal fan to cycle on and off during routine operation. |
| (4)  USB port | Connects an optional USB device. |
| (5) HDMI port | Connects an optional video or audio device, such as a high-definition television, or any compatible digital or audio component. NOTE: Depending on your computer model, the computer may include an HDMI port or a USB port at this location. |





Display components

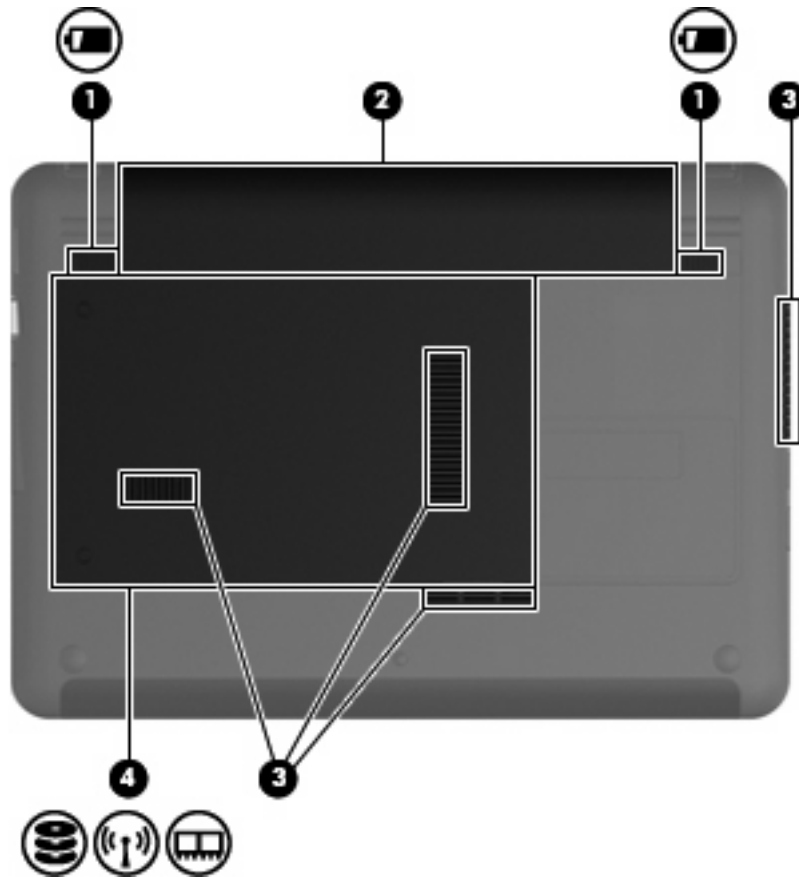

| Component | Description |
|-----------------------------|--|
| (1) Internal display switch | Turns off the display if the display is closed while the power is on. |
| (2) Webcam light | On: The webcam is in use. |
| (3) Webcam | Captures still photographs and videos. NOTE: To capture videos, you must install additional webcam software. |
| (4) Internal microphone | Records sound. |

Bottom components



| Component | Description |
|--|---|
| (1)  Battery release latches (2) | Release the battery from the battery bay. |
| (2) Battery bay | Holds the battery. |
| (3) Vents (4) | Enable airflow to cool internal components. NOTE: The computer fan starts up automatically to cool internal components and prevent overheating. It is normal for the internal fan to cycle on and off during routine operation. |
| (4)    Hard drive bay | Contains the hard drive, the wireless LAN module slot, and the memory module slot. CAUTION: To prevent an unresponsive system, replace the wireless module only with a wireless module authorized for use in the computer by the governmental agency that regulates wireless devices in your country or region. If you replace the module and then receive a warning message, remove the module to restore computer functionality, and then contact technical support through Help and Support. |

Wireless antennas

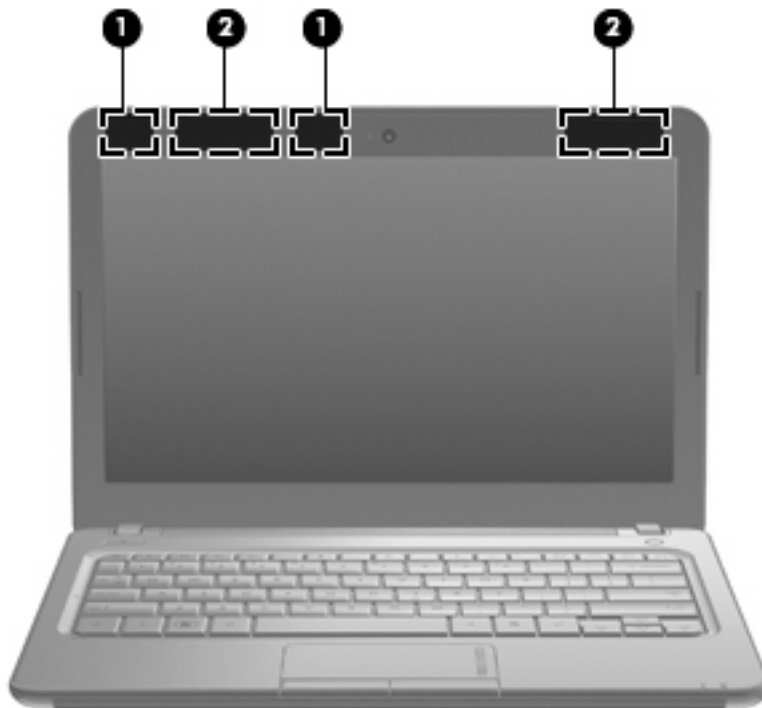

| Component | Description |
|---|---|
| (1) WLAN antennas (2)* | Send and receive wireless signals to communicate with wireless local area networks (WLANs). |
| (2) WWAN antennas (2) (select models only)* | Send and receive wireless signals to communicate with wireless wide-area networks (WWANs). |

*The antennas are not visible from the outside of the computer. For optimal transmission, keep the areas immediately around the antennas free from obstructions.

To see wireless regulatory notices, refer to the section of the *Regulatory, Safety and Environmental Notices* that applies to your country or region. These notices are located in Help and Support.

Additional hardware components



| Component | Description |
|-----------------|---|
| (1) Power cord* | Connects an AC adapter to an AC outlet. |
| (2) Battery* | Powers the computer when the computer is not plugged into external power. |
| (3) AC adapter | Converts AC power to DC power. |

*Batteries and power cords vary in appearance by country or region.

Identifying the labels

The labels affixed to the computer provide information you may need when you troubleshoot system problems or travel internationally with the computer.

- Service tag—Provides important information including the following:



- Product name **(1)**. This is the product name affixed to the front of your computer.
- Serial number (s/n) **(2)**. This is an alphanumeric identifier that is unique to each product.
- Part Number/Product number (p/n) **(3)**. This number provides specific information about the hardware components of the product. The part number helps a service technician to determine what components and parts are needed.
- Model description **(4)**. This is the alphanumeric identifier you use to locate documents, drivers, and support for your computer.
- Warranty period **(5)**. This number describes the duration (in years) of the warranty period for this computer.

Have this information available when you contact technical support. The service tag label is affixed to the bottom of the computer.

- Microsoft® Certificate of Authenticity—Contains the Windows® Product Key. You may need the Product Key to update or troubleshoot the operating system. This certificate is affixed to the bottom of the computer.
- Regulatory label—Provides regulatory information about the computer, including the following:
 - Information about optional wireless devices and the approval markings of some of the countries or regions in which the devices have been approved for use. An optional device may be a wireless local area network (WLAN) device. You may need this information when traveling internationally.
 - The serial number of your HP Mobile Broadband Module.

The regulatory label is affixed inside the battery bay.

3 Wireless and local area network

Using wireless devices

Wireless technology transfers data across radio waves instead of wires. Your computer may be equipped with one or more of the following wireless devices:

- Wireless local area network (WLAN) device—Connects the computer to wireless local area networks (commonly referred to as Wi-Fi networks, wireless LANs, or WLANs) in corporate offices, your home, and public places such as airports, restaurants, coffee shops, hotels, and universities. In a WLAN, each mobile wireless device communicates with a wireless router or a wireless access point.
- HP Mobile Broadband Module—A wireless wide area network (WWAN) device that provides access to information wherever mobile network operator service is available. In a WWAN, each mobile device communicates to a mobile network operator's base station. Mobile network operators install networks of base stations (similar to cell phone towers) throughout large geographic areas, effectively providing coverage across entire states, regions, or even countries.
- Bluetooth® device—Creates a personal area network (PAN) to connect to other Bluetooth-enabled devices such as computers, phones, printers, headsets, speakers, and cameras. In a PAN, each device communicates directly with other devices, and devices must be relatively close together—typically within 10 meters (approximately 33 feet) of each other.

Computers with WLAN devices support one or more of the following IEEE industry standards:









- 802.11b, the first popular standard, supports data rates of up to 11 Mbps and operates at a frequency of 2.4 GHz.
- 802.11g supports data rates of up to 54 Mbps and operates at a frequency of 2.4 GHz. An 802.11g WLAN device is backward compatible with 802.11b devices, so they can operate on the same network.
- 802.11a supports data rates of up to 54 Mbps and operates at a frequency of 5 GHz.

 **NOTE:** 802.11a is not compatible with 802.11b and 802.11g.

- 802.11n supports data rates of up to 450 Mbps and may operate at 2.4 GHz or 5 GHz, making it backward compatible with 802.11a, b, and g.

For more information on wireless technology, refer to the information and Web site links provided in Help and Support.

Identifying wireless and network status icons

| Icon | Name | Description |
|---|---------------------------------------|--|
|  | Wireless (connected) | Identifies the location of the wireless lights and the wireless buttons on the computer. Also identifies the HP Wireless Assistant software on the computer and indicates that one or more of the wireless devices are on. |
|  | Wireless (disconnected) | Identifies the HP Wireless Assistant software on the computer and indicates that all of the wireless devices are off. |
|  | HP Connection Manager | Opens HP Connection Manager, which enables you to create a connection with an HP Mobile Broadband device (select models only). |
|  | Wired network (connected) | Indicates that one or more network drivers are installed, and one or more network devices are connected to a wired network. |
|  | Wired network (disabled/disconnected) | Indicates that one or more network drivers are installed, but no network devices are connected (or all network devices are disabled in Windows® Control Panel). |
|  | Network (connected) | Indicates that one or more network drivers are installed, and one or more network devices are connected to a wireless network. |
|  | Network (disconnected) | Indicates that one or more network drivers are installed and wireless connections are available, but no network devices are connected to a wireless network. |
|  | Network (disabled/disconnected) | Indicates that one or more network drivers are installed, but no wireless connections are available (or all wireless network devices are disabled by the wireless button or HP Wireless Assistant). |

Using the wireless controls

You can control the wireless devices in your computer using these features:

- Wireless button or wireless switch
- Wireless Assistant software (select models only)
- HP Connection Manager software (select models only)
- Operating system controls

Using the wireless button

The computer has a wireless button, one or more wireless devices, and one or two wireless lights, depending on the model. All of the wireless devices on your computer are enabled at the factory, so the wireless light is on (blue) when you turn on the computer.

The wireless light indicates the overall power state of your wireless devices, not the status of individual devices. If the wireless light is blue, at least one wireless device is on. If the wireless light is off, all wireless devices are off.

 **NOTE:** On some models, the wireless light is amber when all wireless devices are off.

Because the wireless devices are enabled at the factory, you can use the wireless button to turn on or turn off the wireless devices simultaneously. Individual wireless devices can be controlled through Wireless Assistant software (select models only).

Using Wireless Assistant software (select models only)

A wireless device can be turned on or off using the Wireless Assistant software. If a wireless device is disabled in Setup Utility, it must be reenabled in Setup Utility before it can be turned on or off using Wireless Assistant.

 **NOTE:** Enabling or turning on a wireless device does not automatically connect the computer to a network or a Bluetooth-enabled device.

To view the state of the wireless devices, click the **Show hidden icons** icon, the arrow at the left of the notification area, and position the mouse pointer over the wireless icon.

If the wireless icon is not displayed in the notification area, complete the following steps to change Wireless Assistant properties:

1. Select **Start > Control Panel > Hardware and Sound > Windows Mobility Center**.
2. Click the wireless icon in the Wireless Assistant tile, which is located in the bottom row of Windows® Mobility Center.
3. Click **Properties**.
4. Select the check box next to **HP Wireless Assistant icon in notification area**.
5. Click **Apply**.
6. Click **Close**.

For more information, refer to the Wireless Assistant software Help:

1. Open Wireless Assistant by clicking the wireless icon in Windows Mobility Center.
2. Click the **Help** button.

Using HP Connection Manager (select models only)

You can use HP Connection Manager to connect to WWANs using the HP Mobile Broadband device in your computer (select models only).

To start Connection Manager, click the **Connection Manager** icon in the notification area, at the far right of the taskbar.

– or –

Select **Start > All Programs > HP Connection Manager > HP Connection Manager**.

For more details about using Connection Manager, refer to the Connection Manager software Help.

Using operating system controls

Some operating systems also offer a way to manage integrated wireless devices and the wireless connection. For example, Windows provides the Network and Sharing Center that allows you to set up a connection or network, connect to a network, manage wireless networks, and diagnose and repair network problems.

To access the Network and Sharing Center, select **Start > Control Panel > Network and Internet > Network and Sharing Center**.

For more information, select **Start > Help and Support**.

Using a WLAN

With a WLAN device, you can access a wireless local area network (WLAN), which is composed of other devices and accessories that are linked by a wireless router or a wireless access point.

 **NOTE:** The terms *wireless router* and *wireless access point* are often used interchangeably.

- A large-scale WLAN, such as a corporate or public WLAN, typically uses wireless access points that can accommodate a large number of devices and accessories and can separate critical network functions.
- A home or small office WLAN typically uses a wireless router, which allows several wireless and wired computers to share an Internet connection, a printer, and files without requiring additional pieces of hardware or software.

To use the WLAN device in your computer, you must connect to a WLAN infrastructure (provided through a service provider or a public or corporate network).

Setting up a WLAN

To set up a WLAN and connect to the Internet, you need the following equipment:

- A broadband modem (either DSL or cable) **(1)** and high-speed Internet service purchased from an Internet service provider (ISP)
- A wireless router (purchased separately) **(2)**
- The computer, equipped with a wireless device **(3)**

The illustration below shows an example of a wireless network installation that is connected to the Internet.

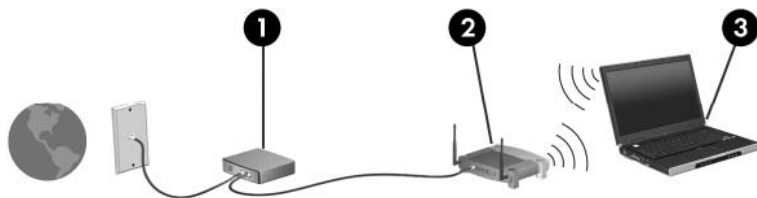

As your network grows, additional wireless and wired computers can be connected to the network to access the Internet.

For help in setting up your WLAN, refer to the information provided by your router manufacturer or your ISP.

Protecting your WLAN

Because the WLAN standard was designed with only limited security capabilities—basically to foil casual eavesdropping rather than more powerful forms of attack—it is essential to understand that WLANs are vulnerable to well-known and well-documented security weaknesses.

WLANs in public areas, or “hotspots,” like coffee shops and airports may not provide any security. New technologies are being developed by wireless manufacturers and hotspot service providers that make the public environment more secure and anonymous. If you are concerned about the security of your computer in a hotspot, limit your network activities to noncritical e-mail and basic Internet surfing.

When you set up a WLAN or access an existing WLAN, always enable security features to protect your network from unauthorized access. The common security levels are Wi-Fi Protected Access (WPA)-Personal and Wired Equivalent Privacy (WEP). Because wireless radio signals travel outside the network, other WLAN devices can pick up unprotected signals and either connect to your network (uninvited) or capture information being sent across it. However, you can take precautions to protect your WLAN:

- **Use a wireless transmitter with built-in security.**

Many wireless base stations, gateways, or routers provide built-in security features such as wireless security protocols and firewalls. With the correct wireless transmitter, you can protect your network from the most common wireless security risks.

- **Work behind a firewall.**

A firewall is a barrier that checks both data and requests for data that are sent to your network, and discards any suspicious items. Firewalls are available in many varieties, both software and hardware. Some networks use a combination of both types.

- **Use wireless encryption.**

A variety of sophisticated encryption protocols is available for your WLAN. Find the solution that works best for your network security:

- **Wired Equivalent Privacy (WEP).** is a wireless security protocol that encodes or encrypts all network data before it is transmitted using a WEP key. Usually, you can allow the network to assign the WEP key. Alternatively, you can set up your own key, generate a different key, or choose other advanced options. Without the correct key, others are not able to use the WLAN.
- **WPA (Wi-Fi Protected Access).** like WEP, uses security settings to encrypt and decrypt data that is transmitted over the network. However, instead of using one static security key for encryptions as WEP does, WPA uses “temporal key integrity protocol” (TKIP) to dynamically generate a new key for every packet. It also generates different sets of keys for each computer on the network.

Connecting to a WLAN

To connect to the WLAN, follow these steps:

1. Be sure that the WLAN device is on. If it is on, the wireless light is blue. If the wireless light is amber, press the wireless button.
2. Click the network icon in the notification area, at the far right of the taskbar.
3. Select your WLAN from the list.
4. Click **Connect**.

If the network is a security-enabled WLAN, you are prompted to enter a network security key, which is a security code. Type the code, and then click **OK** to complete the connection.

 **NOTE:** If no WLANs are listed, you are out of range of a wireless router or access point.

NOTE: If you do not see the network you want to connect to, click **Open Network and Sharing Center**, and then click **Set up a new connection or network**. A list of options is displayed. You can choose to manually search for and connect to a network or to create a new network connection.

After the connection is made, place the mouse pointer over the network icon in the notification area, at the far right of the taskbar, to verify the name and status of the connection.

 **NOTE:** The functional range (how far your wireless signals travel) depends on WLAN implementation, router manufacturer, and interference from other electronic devices or structural barriers such as walls and floors.

More information about using a WLAN is available through the following resources:

- Information from your ISP and the manufacturer's instructions included with your wireless router and other WLAN equipment
- Information and Web site links provided in Help and Support

For a list of public WLANs near you, contact your ISP or search the Web. Web sites that list public WLANs include Cisco Internet Mobile Office Wireless Locations, Hotspotlist, and Geektools. Check with each public WLAN location for cost and connection requirements.

Roaming to another network

When you move your computer within range of another WLAN, Windows attempts to connect to that network. If the attempt is successful, your computer is automatically connected to the new network. If Windows does not recognize the new network, follow the same procedure you used initially to connect to your WLAN.

Using HP Mobile Broadband (select models only)

HP Mobile Broadband enables your computer to use wireless wide area networks (WWANs) to access the Internet from more places and over larger areas than it can by using WLANs. Using HP Mobile Broadband requires a network service provider (called a *mobile network operator*), which in most cases is a mobile phone network operator. Coverage for HP Mobile Broadband is similar to mobile phone voice coverage.

When used with mobile network operator service, HP Mobile Broadband gives you the freedom to stay connected to the Internet, send e-mail, or connect to your corporate network whether you are on the road or outside the range of Wi-Fi hotspots.

HP Mobile Broadband supports the following technologies:

- HSPA (High Speed Packet Access), which provides access to networks based on the Global System for Mobile Communications (GSM) telecommunications standard.
- EV-DO (Evolution Data Optimized), which provides access to networks based on the code division multiple access (CDMA) telecommunications standard.

You may need the HP Mobile Broadband Module serial number to activate mobile broadband service. The serial number is printed on a label inside the battery bay of your computer.

Some mobile network operators require the use of a subscriber identity module (SIM). A SIM contains basic information about you, such as a personal identification number (PIN), as well as network information. Some computers include a SIM that is preinstalled in the battery bay. If the SIM is not preinstalled, it may be included with the HP Mobile Broadband information provided with your computer, or the mobile network operator may provide it separately from the computer.

For information on inserting and removing the SIM, refer to the “Inserting a SIM” and “Removing a SIM” sections in this chapter.

For information on HP Mobile Broadband and how to activate service with a preferred mobile network operator, refer to the HP Mobile Broadband information included with your computer. For additional information, see the HP Web site at <http://www.hp.com/go/mobilebroadband> (US only).

Inserting a SIM

To insert a SIM:

1. Shut down the computer. If you are not sure whether the computer is off or in Hibernation, turn the computer on by pressing the power button. Then shut down the computer through the operating system.
2. Close the display.
3. Disconnect all external devices connected to the computer.
4. Unplug the power cord from the AC outlet.
5. Turn the computer upside down on a flat surface, with the battery bay toward you.
6. Remove the battery.

△ **CAUTION:** When inserting a SIM, position the card with the slanted corner as shown in the illustration. If a SIM is inserted backwards or upside down, the battery may not snap into place properly and could damage the SIM and the SIM connector.

To prevent damage to the connectors, use minimal force when inserting a SIM.

7. Insert the SIM into the SIM slot, and gently push the SIM into the slot until it is firmly seated.

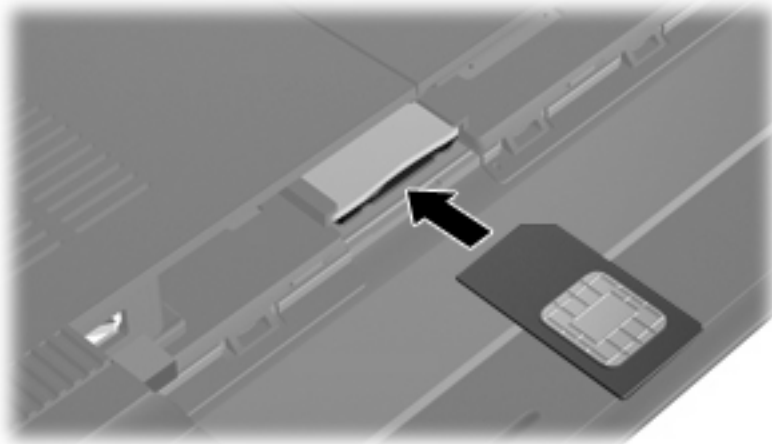

8. Replace the battery.

📄 **NOTE:** HP Mobile Broadband is disabled if the battery is not replaced.

9. Reconnect external power.
10. Reconnect external devices.
11. Turn on the computer.

Removing a SIM

To remove a SIM:

1. Shut down the computer. If you are not sure whether the computer is off or in Hibernation, turn the computer on by pressing the power button. Then shut down the computer through the operating system.
2. Close the display.
3. Disconnect all external devices connected to the computer.
4. Unplug the power cord from the AC outlet.
5. Turn the computer upside down on a flat surface, with the battery bay toward you.
6. Remove the battery.
7. Press in on the SIM (1), and then remove it from the slot (2).

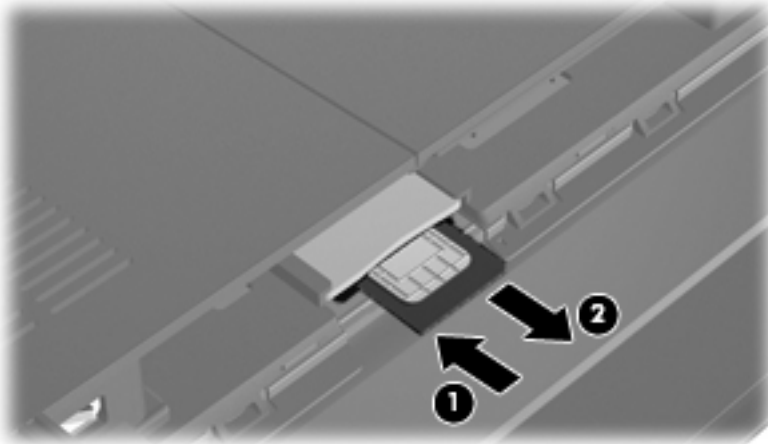

8. Replace the battery.
9. Reconnect external power.
10. Reconnect external devices.
11. Turn on the computer.

Using Bluetooth wireless devices

A Bluetooth device provides short-range wireless communications that replace the physical cable connections that traditionally link electronic devices such as the following:

- Computers (desktop, notebook, PDA)
- Phones (cellular, cordless, smart phone)
- Imaging devices (printer, camera)
- Audio devices (headset, speakers)

Bluetooth devices provide peer-to-peer capability that allows you to set up a personal area network (PAN) of Bluetooth devices. For information on configuring and using Bluetooth devices, refer to the Bluetooth software Help.

Bluetooth and Internet Connection Sharing (ICS)

HP does **not** recommend setting up one computer with Bluetooth as a host and using it as a gateway through which other computers may connect to the Internet. When two or more computers are connected using Bluetooth, and Internet Connection Sharing (ICS) is enabled on one of the computers, the other computers may not be able to connect to the Internet using the Bluetooth network.

The strength of Bluetooth is in synchronizing information transfers between your computer and wireless devices including cellular phones, printers, cameras, and PDAs. The inability to consistently connect two or more computers to share the Internet through Bluetooth is a limitation of Bluetooth and the Windows operating system.

Troubleshooting wireless connection problems

Some possible causes for wireless connection problems include the following:

- Network configuration (SSID or security) has been changed.
- Wireless device is not installed correctly or has been disabled.
- Wireless device or router hardware has failed.
- Wireless device encountered interference from other devices.

 **NOTE:** Wireless networking devices are included with select computer models only. If wireless networking is not listed in the feature list on the side of the original computer package, you may add wireless networking capability to the computer by purchasing a wireless networking device.

Before working your way through the sequence of possible solutions to your network connection problem, be sure that device drivers are installed for all wireless devices.

Use the procedures in this chapter to diagnose and repair a computer that does not connect to the network you want to use.

Cannot connect to a WLAN

If you have a problem connecting to a WLAN, confirm that the integrated WLAN device is properly installed on your computer:

 **NOTE:** Windows includes the User Account Control feature to improve the security of your computer. You may be prompted for your permission or password for tasks such as installing software, running utilities, or changing Windows settings. Refer to Help and Support for more information.

1. Select **Start > Control Panel > System and Security**.
2. In the **System** area, click **Device Manager**.
3. Click the arrow next to **Network adapters** to expand the list and show all adapters.
4. Identify the WLAN device from the Network adapters list. The listing for a WLAN device may include the terms *wireless*, *wireless LAN*, *WLAN*, *Wi-Fi*, or *802.11*.

If no WLAN device is listed, either your computer does not have an integrated WLAN device, or the driver of the WLAN device is not properly installed.

For more information on troubleshooting WLANs, refer to the Web site links provided in Help and Support.

Cannot connect to a preferred WLAN network

Windows can automatically repair a corrupted WLAN connection:

- If there is a network icon in the notification area, at the far right of the taskbar, right-click the icon, and then click **Troubleshoot problems**.

Windows resets your network device and attempts to reconnect to one of the preferred networks.

- If there is no network icon in the notification area, follow these steps:
 1. Select **Start > Control Panel > Network and Internet > Network and Sharing Center**.
 2. Click **Troubleshoot problems** and select the network you wish to repair.

Network icon for WLAN is not displayed

If the network icon is not displayed in the notification area after you configure the WLAN, the software driver is either missing or corrupted. A Windows “Device not Found” error message may also be displayed. The driver must be reinstalled.

Get the latest version of the WLAN computer software and drivers for your computer from the HP Web site at <http://www.hp.com>.

 **NOTE:** If the WLAN device you are using was purchased separately, consult the manufacturer’s Web site for the latest software.

To get the latest version of the WLAN computer software for your computer, follow these steps:

1. Open your Internet browser and go to <http://www.hp.com/support>.
2. Select your country or region.
3. Click the option for software and driver downloads, and then type your computer model number in the search box.
4. Press **enter**, and then follow the on-screen instructions.

Current WLAN network security codes are unavailable

If you are prompted for a network key or a name (SSID) when connecting to a WLAN, the network is protected by security. You must have the current codes to make a connection on a secure network. The SSID and network key are alphanumeric codes that identify your computer to the network.

- For a network connected to your personal wireless router, review the router user guide for instructions on setting up the same codes on both the router and the WLAN device.
- For a private network, such as a network in an office or at a public Internet chat room, contact the network administrator to obtain the codes, and then enter the codes when prompted to do so.

Some networks change the SSID or network keys used in their routers or access points on a regular basis to improve security. You must change the corresponding code in your computer accordingly.

If you are provided with new wireless network keys and SSID for a network, and if you have previously connected to that network, follow the steps below to connect to the network:

1. Select **Start > Control Panel > Network and Internet > Network and Sharing Center**.

2. Click **Manage wireless networks** in the left panel.

A list showing the available WLANs is displayed. If you are in a hotspot where several WLANs are active, several are displayed.

3. Select the network in the list, right-click the network, and then click **Properties**.

 **NOTE:** If the network you want is not listed, check with the network administrator to be sure that the router or access point is operating.

4. Click the **Security** tab and enter the correct wireless encryption data into the **Network security key** box.

5. Click **OK** to save these settings.

WLAN connection is very weak

If the connection is very weak, or if your computer cannot make a connection to a WLAN, minimize interference from other devices, as follows:

- Move your computer closer to the wireless router or access point.
- Temporarily disconnect devices such as a microwave, cordless phone, or cellular phone to be sure that other devices are not interfering.

If the connection does not improve, try forcing the device to reestablish all connection values:

1. Select **Start > Control Panel > Network and Internet > Network and Sharing Center**.

2. Click **Manage wireless networks** in the left panel.

A list showing the available WLANs is displayed. If you are in a hotspot where several WLANs are active, several are displayed.

3. Click a network, and then click **Remove**.

Cannot connect to the wireless router

If you are trying to connect to the wireless router and are unsuccessful, reset the wireless router by removing power from the router for 10 to 15 seconds.

If the computer still cannot make a connection to a WLAN, restart the wireless router. For details, refer to the router manufacturer's instructions.

Connecting to a local area network (LAN)

Connecting to a local area network (LAN) requires an 8-pin, RJ-45 network cable (purchased separately). If the network cable contains noise suppression circuitry (1), which prevents interference from TV and radio reception, orient the circuitry end of the cable (2) toward the computer.



To connect the network cable:

⚠ WARNING! To reduce the risk of electric shock, fire, or damage to the equipment, do not plug a modem cable or telephone cable into an RJ-45 (network) jack.

1. Plug the network cable into the network jack (1) on the computer.
2. Plug the other end of the cable into a network wall jack (2).

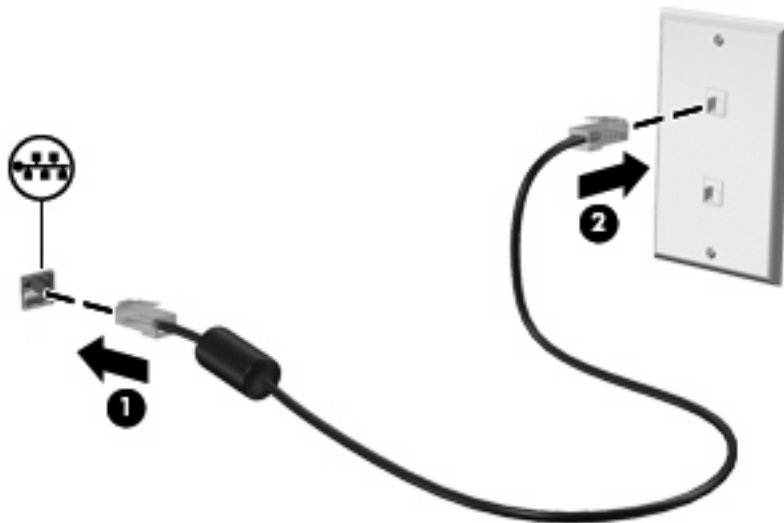

4 Multimedia

Multimedia features

Your computer includes multimedia features that allow you to listen to music, watch movies, and view pictures. Your computer may include the following multimedia components:

- Integrated speakers for listening to music
- Integrated microphone for recording your own audio
- Integrated webcam that allows you to capture photographs and videos
- Preinstalled multimedia software that allows you to play and manage your music, movies, and pictures



NOTE: Your computer may not include all of the components listed.



The following sections explain how to identify and use the multimedia components included with your computer.

Identifying your multimedia components

The following illustration and table describe the multimedia features of the computer.



| Component | Description |
|---|--|
| (1) Webcam light | On: The webcam is in use. |
| (2) Webcam | Captures still photographs and videos. NOTE: To capture videos, you must install additional webcam software. |
| (3) Internal microphone | Records sound. |
| (4)  Audio-out (headphone) jack/Audio-in (microphone) jack | Produces sound when connected to optional powered stereo speakers, headphones, earbuds, a headset, or television audio. Also connects an optional headset microphone. WARNING! To reduce the risk of personal injury, adjust the volume before putting on headphones, earbuds, or a headset. For additional safety information, refer to the <i>Regulatory, Safety and Environmental Notices</i> . NOTE: When a device is connected to the jack, the computer speakers are disabled. The audio component must have a 4-conductor connector. |
| (5) Speakers (2) | Produce sound. |

| Component | Description |
|--|---|
| (6)  Volume mute hotkey | Mutes speaker sound when pressed in combination with the fn key. |
| (7)  Volume down hotkey | Decreases speaker sound when pressed in combination with the fn key. |
| (8)  Volume up hotkey | Increases speaker sound when pressed in combination with the fn key. |

Adjusting the volume

You can adjust the volume using the following controls:

- Computer volume hotkey—A combination of the **fn** key (1) and either the **f8** (2), **f10** (3), or **f11** (4) function key:
 - To mute or restore volume, press **fn+f8**.
 - To decrease volume, press **fn+f10**.
 - To increase volume, press **fn+f11**.



- Windows volume control:
 - a. Click the **Speakers** icon in the notification area, at the far right of the taskbar.
 - b. Increase or decrease the volume by moving the slider up or down. Click the **Mute Speakers** icon to mute the volume.

– or –

 - a. Right-click the **Speakers** icon in the notification area, and then click **Open Volume Mixer**.
 - b. In the Volume Control column, you can increase or decrease the volume by moving the slider up or down. You can also mute the volume by clicking the **Mute Speakers** icon.

If the Speakers icon is not displayed in the notification area, follow these steps to add it:

- a. Right-click the **Show hidden icons** icon (the arrow at the left side of the notification area).
 - b. Click **Customize notification icons**.
 - c. Under **Behaviors**, select **Show icon and notifications for the Volume icon**.
 - d. Click **OK**.
- Program volume control:

Volume can also be adjusted within some programs.

Multimedia software

Your computer includes preinstalled multimedia software that allows you to play music, watch movies, and view pictures.

Using preinstalled multimedia software

To locate other preinstalled multimedia software:

- ▲ Select **Start > All Programs**, and then open the multimedia program you want to use. For example, if you want to use Windows Media Player (select models only), click **Windows Media Player**.

 **NOTE:** Some programs may be located in subfolders.

Installing multimedia software from the Internet

- ▲ To install multimedia software from the Internet, go to the software manufacturer's Web site and follow the instructions.

 **NOTE:** Software downloaded from the Internet may contain viruses. Refer to the "Security" chapter for more information.

Audio

Your computer has a variety of audio features that allow you to:

- Play music using your computer speakers and/or connected external speakers.
- Record sound using the internal microphone or an optional external headset microphone.
- Download music from the Internet.
- Create multimedia presentations using audio and images.
- Transmit sound and images with instant messaging programs.

Connecting external audio devices

 **WARNING!** To reduce the risk of personal injury, adjust the volume before putting on headphones, earbuds, or a headset. For additional safety information, refer to the *Regulatory, Safety and Environmental Notices*.

To connect external devices such as external speakers, headphones, or a headset microphone, refer to the information provided with the device. For best results, remember the following tips:

- Be sure that the device cable has a 4-conductor connector that supports both audio-out (headphone) and audio-in (microphone).
- Be sure that the device cable is securely connected to the correct jack on your computer. (Cable connectors are normally color-coded to match the corresponding jacks on the computer.)
- Be sure to install any drivers required by the external device.

 **NOTE:** A driver is a required program that acts like a translator between the device and the programs that use the device.

Checking your audio functions

To check the system sound on your computer, follow these steps:

1. Select **Start > Control Panel**.
2. Click **Hardware and Sound**.
3. Click **Sound**.
4. When the Sound and Audio Device Properties window opens, click the **Sounds** tab. Under **Program Events**, select any sound event, such as a beep or alarm, and click the arrow button to check the sound.

You should hear sound through the speakers or through connected headphones.

To check the record functions of the computer, follow these steps:

1. Select **Start > All Programs > Accessories > Sound Recorder**.
2. Click **Start Recording** and speak into the microphone. Save the file to your desktop.
3. Open a multimedia program and play back the sound.

 **NOTE:** For best results when recording, speak directly into the microphone and record sound in a setting free of background noise.

To confirm or change the audio settings on your computer, select **Start > Control Panel > Hardware and Sound > Sound**.

Video

Your computer enables you to use a variety of video features:

- Watch movies
- Play games over the Internet
- Edit pictures and video to create presentations
- Connect external video devices

Connecting an external monitor or projector

Use a VGA cable (purchased separately) to connect an external display, such as a monitor or projector, to the external monitor port on the computer.

To connect an external monitor or projector:

1. Connect the optional VGA cable to the external monitor port on the computer.

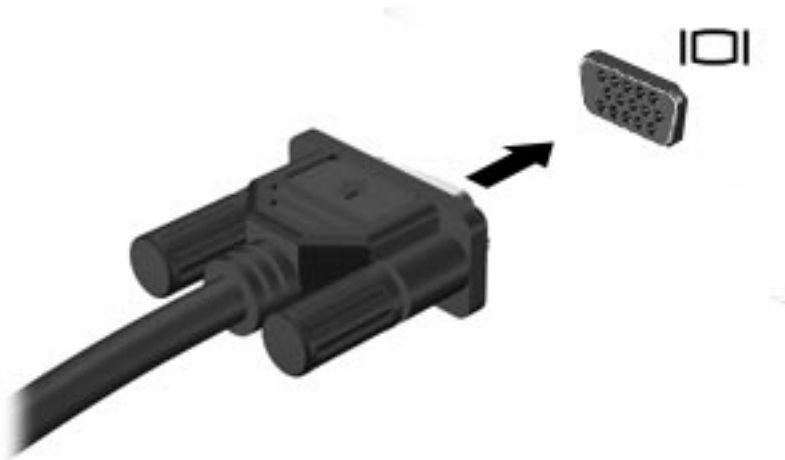

2. Connect the external monitor or projector to the other end of the cable.

 **NOTE:** If a properly connected external monitor or projector does not display a screen image, press **fn+f2** to transfer the image to the external display. Repeatedly pressing **fn+f2** alternates the screen image between the external display and the computer.

Connecting an HDMI device

The computer includes an HDMI (High Definition Multimedia Interface) port. The HDMI port connects the computer to an optional video or audio device, such as a high-definition television, or any compatible digital or audio component.

 **NOTE:** To transmit video signals through the HDMI port, you need an HDMI cable (purchased separately).

The computer can support one HDMI device connected to the HDMI port, while simultaneously supporting an image on the computer display or any other supported external display.

To connect a video or audio device to the HDMI port:

1. Connect one end of the HDMI cable to the HDMI port on the computer.

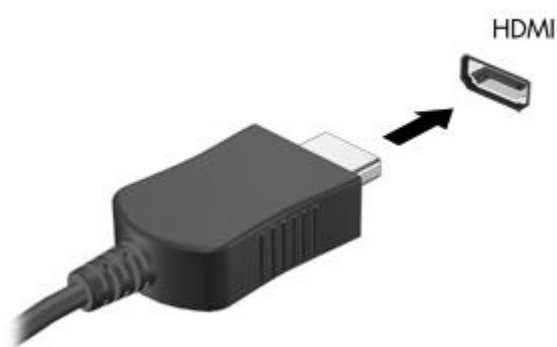

2. Connect the other end of the cable to the video device, according to the device manufacturer's instructions.
3. Press **fn+f2** on the computer to switch the image between the display devices connected to the computer.

Configuring audio for HDMI (select models only)

To configure HDMI audio, first connect an audio or video device, such as a high-definition TV, to the HDMI port on your computer. Then configure the default audio playback device as follows:

1. Right-click the **Speakers** icon in the notification area, at far right of the taskbar, and then click **Playback devices**.
2. On the **Playback** tab, click either **Digital Output** or **Digital Output Device (HDMI)**.
3. Click **Set Default**, and then click **OK**.

To return audio to the computer speakers, follow these steps:

1. Right-click the **Speakers** icon in the notification area, at far right of the taskbar, and then click **Playback devices**.
2. On the **Playback** tab, click **Speakers**.
3. Click **Set Default**, and then click **OK**.

Webcam

Your computer includes an integrated webcam, located at the top of the display. The webcam is an input device that allows you to capture and share video.

To access the webcam:

1. Select **Start > All programs > ArcSoft WebCam Companion 3 > WebCam Companion 3**.
2. Click **Capture > Take pictures**.



NOTE: The picture is automatically saved in the **My Documents** folder.

5 Drives and external devices

Drives

Identifying installed drives

Your computer includes a hard drive (with a rotating disc) or a solid state-drive (SSD) with solid-state memory. Because an SSD has no moving parts, it does not generate as much heat as a hard drive.

To view the drives installed on the computer, select **Start > Computer**.

Handling drives

Drives are fragile computer components that must be handled with care. Refer to the following cautions before handling drives. Additional cautions are included with the procedures to which they apply.

- △ **CAUTION:** To reduce the risk of damage to the computer, damage to a drive, or loss of information, observe these precautions:

Before you move a computer that is connected to an external hard drive, initiate Sleep and allow the screen to clear, or properly disconnect the external hard drive.

Before handling a drive, discharge static electricity by touching the unpainted metal surface of the drive.

Do not touch the connector pins on a removable drive or on the computer.

Handle a drive carefully; do not drop a drive or place items on it.

Before removing or inserting a drive, shut down the computer. If you are unsure whether the computer is off, in the Sleep state, or in Hibernation, turn the computer on and then shut it down through the operating system.

Do not use excessive force when inserting a drive into a drive bay.

Do not type on the keyboard or move the computer while the optical drive (select models only) is writing to a disc. The write process is sensitive to vibration.

When the battery is the only source of power, be sure that the battery is sufficiently charged before writing to media.

Avoid exposing a drive to temperature or humidity extremes.

Avoid exposing a drive to liquids. Do not spray the drive with cleaning products.

Remove media from a drive before removing the drive from the drive bay, or traveling with, shipping, or storing a drive.

If a drive must be mailed, place the drive in a bubble-pack mailer or other suitable protective packaging and label the package "FRAGILE."

Avoid exposing a drive to magnetic fields. Security devices with magnetic fields include airport walk-through devices and security wands. The airport security devices that check carry-on luggage, such as conveyor belts, use X-rays instead of magnetism and will not damage a drive.

Improving hard drive performance

Using Disk Defragmenter

As you use the computer, files on the hard drive become fragmented. Disk Defragmenter consolidates the fragmented files and folders on the hard drive so that the system can run more efficiently.

To run Disk Defragmenter:

1. Select **Start > All Programs > Accessories > System Tools > Disk Defragmenter**.
2. Click **Defragment now**.

 **NOTE:** Windows® includes the User Account Control feature to improve the security of your computer. You may be prompted for your permission or password for tasks such as installing applications, running utilities, or changing Windows settings. Refer to Help and Support for more information.

For additional information, access the Disk Defragmenter software Help.

Using Disk Cleanup

Disk Cleanup searches the hard drive for unnecessary files that you can safely delete to free up disk space and help the computer to run more efficiently.

To run Disk Cleanup:

1. Select **Start > All Programs > Accessories > System Tools > Disk Cleanup**.
2. Follow the on-screen instructions.

Replacing the hard drive in the hard drive bay

△ **CAUTION:** To prevent information loss or an unresponsive system:

Shut down the computer before removing the hard drive from the hard drive bay. Do not remove the hard drive while the computer is on, in the Sleep state, or in Hibernation.

If you are not sure whether the computer is off or in Hibernation, turn the computer on by pressing the power button. Then shut down the computer through the operating system.

To remove the hard drive:

1. Save your work.
2. Shut down the computer and close the display.
3. Disconnect all external devices connected to the computer.
4. Unplug the power cord from the AC outlet.
5. Turn the computer upside down on a flat surface.
6. Remove the battery from the computer.
7. With the hard drive bay toward you, loosen the 2 hard drive cover screws **(1)**.
8. Lift the hard drive cover away from the computer **(2)**.

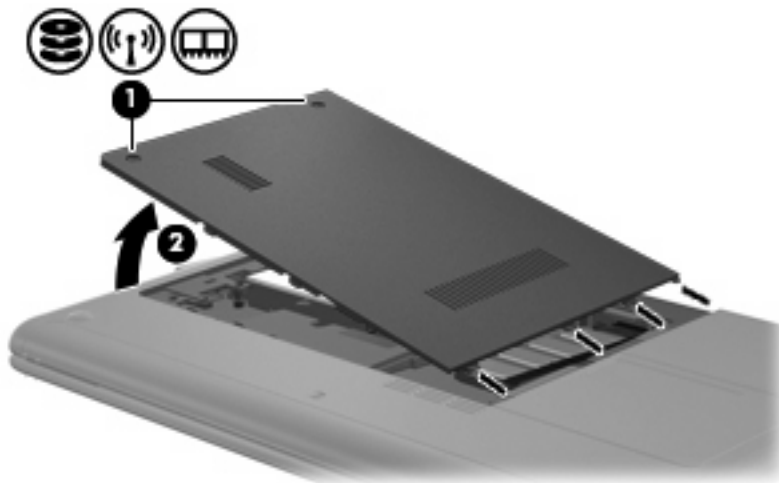

9. Disconnect the hard drive cable **(1)** that secures the hard drive to the computer.

10. Pull the hard drive tab (2) up and lift the hard drive (3) out of the hard drive bay.

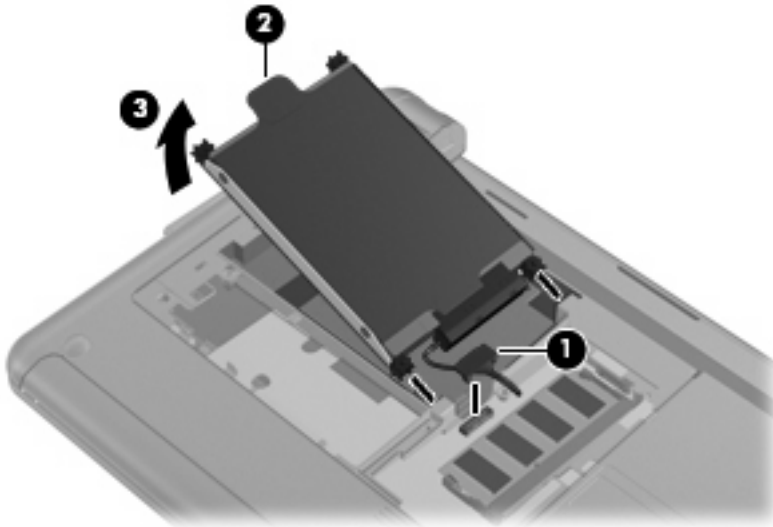

To install a hard drive:

1. Grasp the hard drive tab (1) and insert the hard drive (2) into the hard drive bay, until the rubber stops slide into place.
2. Reconnect the hard drive cable (3).

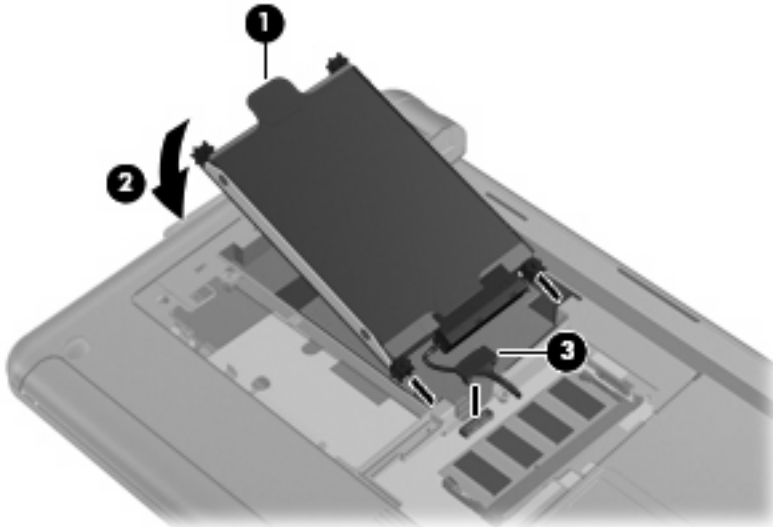

3. Align the tabs on the hard drive cover with the notches on the computer, and then close the cover (1).

4. Tighten the 2 hard drive cover screws (2).

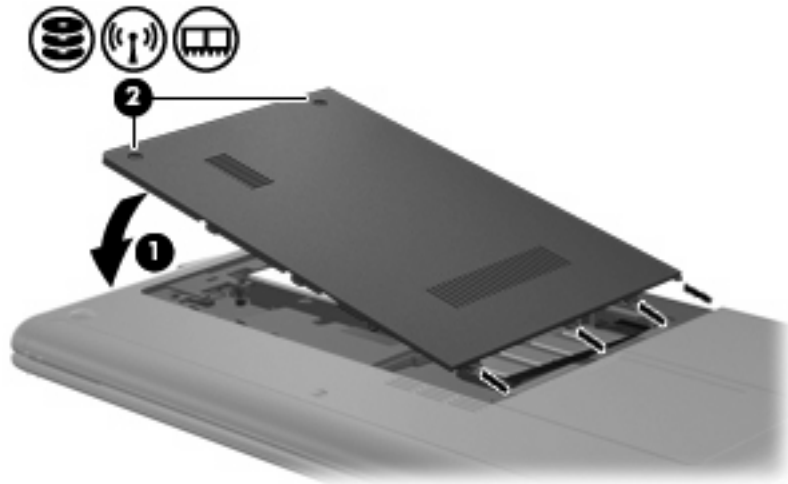

Using external drives

Removable external drives expand your options for storing and accessing information.

USB drives include the following types:

- 1.44-megabyte diskette drive
- Hard drive module (a hard drive with an adapter attached)
- DVD-ROM Drive
- DVD/CD-RW Combo Drive
- DVD±RW and CD-RW Combo Drive
- DVD±RW and CD-RW SuperMulti Double-Layer Combo Drive
- DVD±RW and CD-RW SuperMulti Double-Layer Combo Drive with LightScribe
- Blu-ray ROM DVD±R/RW SuperMulti DL Drive
- Blu-ray ROM with LightScribe DVD±R/RW SuperMulti DL Drive
- HD DVD drive

Connecting optional external drives

 **NOTE:** For more information about required software and drivers, or to learn which computer port to use, refer to the manufacturer's instructions.

To connect an external drive to the computer:

 **CAUTION:** To reduce the risk of damage to the equipment when connecting a powered drive, be sure that the drive is turned off and the AC power cord is unplugged.

1. Connect the drive to the computer.

 **NOTE:** The external optical drive must be connected to the USB port *on the computer*, not to a USB port on another external device, such as a hub or docking station.

2. If you are connecting a powered drive, plug the drive power cord into a grounded AC outlet.

3. Turn on the drive.

To disconnect an unpowered external drive, turn off the drive, and then disconnect it from the computer. To disconnect a powered external drive, turn off the drive, disconnect it from the computer, and then unplug the AC power cord.

Sharing optical drives

Although your computer does not have an installed optical drive, you can easily access software, as well as install applications and access data, by sharing an optical drive from another computer that has an optical drive and is on the same wired or wireless network. Sharing drives is a feature of the Windows operating system that allows a drive on another computer to be made available for other people to use on a network.

 **NOTE:** For information on setting up a home network and sharing a drive, refer to Help and Support.

NOTE: Some discs, such as DVD movies and game discs, may be copy-protected and therefore unusable through DVD or CD sharing.

External devices

Using a USB device

Universal Serial Bus (USB) is a hardware interface that can be used to connect an optional external device, such as a USB keyboard, mouse, drive, printer, scanner, or hub. Devices can be connected to the system, an optional docking device, or an optional expansion product.

Some USB devices may require additional support software, which is usually included with the device. For more information about device-specific software, refer to the manufacturer's instructions.

The computer has 3 or 4 USB ports, which support USB 1.0, USB 1.1, and USB 2.0 devices. An optional USB hub, optional docking device, or an optional expansion product provides additional USB ports that can be used with the computer.

Connecting a USB device

△ **CAUTION:** To prevent damage to a USB connector, use minimal force to connect a USB device.

▲ To connect a USB device to the computer, connect the USB cable for the device to the USB port.



You will hear a sound when the device has been detected.

📄 **NOTE:** When you connect a USB device, you may see a message in the notification area to let you know that the device is recognized by the system.

Removing a USB device

△ **CAUTION:** To prevent loss of information or an unresponsive system, use the following procedure to safely remove the USB device.

CAUTION: To prevent damage to a USB connector, do not pull on the cable to remove the USB device.

To remove a USB device:

1. Click the **Safely Remove Hardware and Eject Media** icon in the notification area, at the far right of the taskbar.

 **NOTE:** To display the **Safely Remove Hardware and Eject Media** icon, click the **Show hidden icons** icon (the arrow at the left of in the notification area).

2. Click the name of the device in the list.

 **NOTE:** You are informed that it is safe to remove the hardware device.

3. Remove the device.

Using Digital Media Slot cards

Optional digital cards provide secure data storage and convenient data sharing. These cards are often used with digital media–equipped cameras and PDAs as well as with other computers.

The Digital Media Slot supports the following digital card formats:

- Memory Stick (MS)
- Memory Stick Pro (MS/Pro)
- MultiMediaCard (MMC)
- Secure Digital (SD) Memory Card
- Secure Digital High Capacity (SDHC) Memory Card
- xD-Picture Card (XD)
- xD-Picture Card (XD) Type H
- xD-Picture Card (XD) Type M

Inserting a digital card

△ **CAUTION:** To avoid damaging the digital card or the computer, do not insert any type of adapter into the Digital Media Slot.

CAUTION: To prevent damage to the digital card connectors, use minimal force to insert a digital card.

1. Hold the digital card label-side up, with the connectors facing the computer.

2. Insert the card into the Digital Media Slot, and then push in on the card until it is firmly seated.

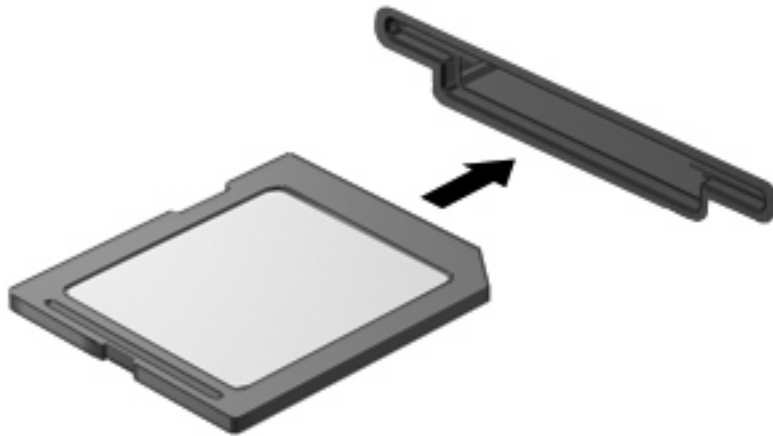

You will hear a sound when the device has been detected, and a menu of options may be displayed.

Removing a digital card

△ **CAUTION:** To prevent loss of data or an unresponsive system, use the following procedure to safely remove the digital card.

1. Save your information and close all programs associated with the digital card.

📄 **NOTE:** To stop a data transfer, click **Cancel** in the operating system Copying window.

2. To remove a digital card:

- a. Click the **Safely Remove Hardware and Eject Media** icon in the notification area, at the far right of the taskbar.

📄 **NOTE:** To display the Safely Remove Hardware and Eject Media icon, click the **Show Hidden Icons** icon (the arrow at the left of the notification area).

- b. Click the name of the digital card in the list.

📄 **NOTE:** You are informed that it is safe to remove the hardware device.

- c. Click **Stop**, and then click **OK**.

3. Press in on the digital card (1), and then remove the card from the slot (2).

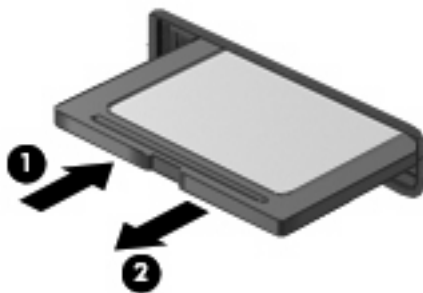

6 Memory modules

The computer has one memory module slot, which is located inside the hard drive bay. The memory capacity of the computer can be upgraded by replacing the existing memory module.

- △ **WARNING!** To reduce the risk of electric shock and damage to the equipment, unplug the power cord and remove all batteries before installing a memory module.
- △ **CAUTION:** Electrostatic discharge (ESD) can damage electronic components. Before beginning any procedure, ensure that you are discharged of static electricity by touching a grounded metal object.

To replace a memory module:

1. Save your work.
2. Shut down the computer and close the display.

If you are not sure whether the computer is off or in Hibernation, turn the computer on by pressing the power button. Then shut down the computer through the operating system.

3. Disconnect all external devices connected to the computer.
4. Unplug the power cord from the AC outlet.
5. Turn the computer upside down on a flat surface.
6. Remove the battery from the computer.
7. Using a small Phillips screwdriver, loosen the 2 hard drive cover screws **(1)**.

8. Lift the hard drive cover (2) away from the computer.

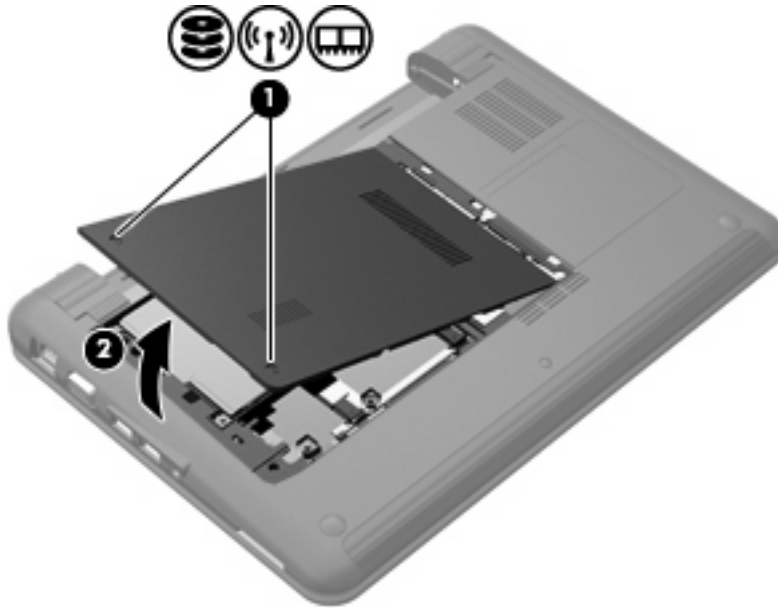

9. Remove the existing memory module:

- a. Pull away the retention clips (1) on each side of the memory module.

The memory module tilts up.

△ **CAUTION:** To prevent damage to the memory module, hold the memory module by the edges only. Do not touch the components on the memory module.

- b. Grasp the edge of the memory module (2), and gently pull the module out of the memory module slot.

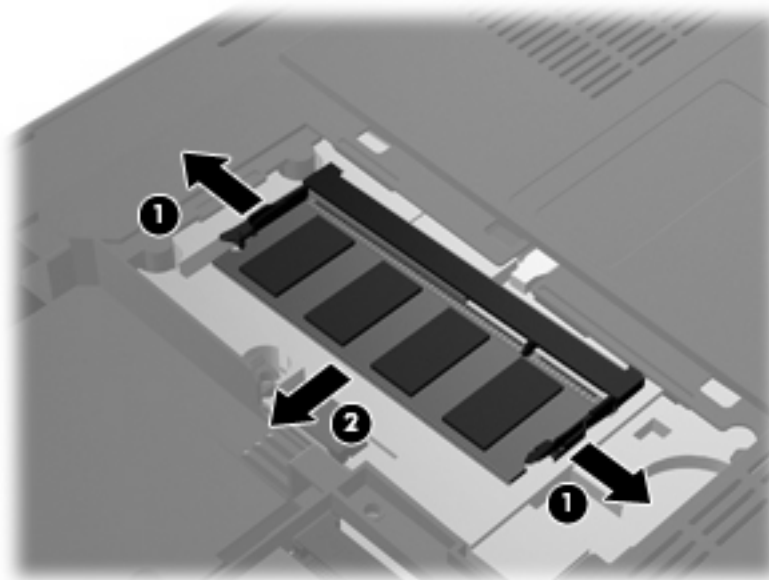

To protect a memory module after removal, place it in an electrostatic-safe container.

10. Insert a new memory module:

△ **CAUTION:** To prevent damage to the memory module, hold the memory module by the edges only. Do not touch the components on the memory module, and do not bend the memory module.

- a. Align the notched edge **(1)** of the memory module with the tab in the memory module slot.
- b. With the memory module at a 45-degree angle from the surface of the hard drive bay, press the module **(2)** into the memory module slot until it is seated.
- c. Gently press the memory module **(3)** down, applying pressure to both the left and right edges of the memory module, until the retention clips snap into place.

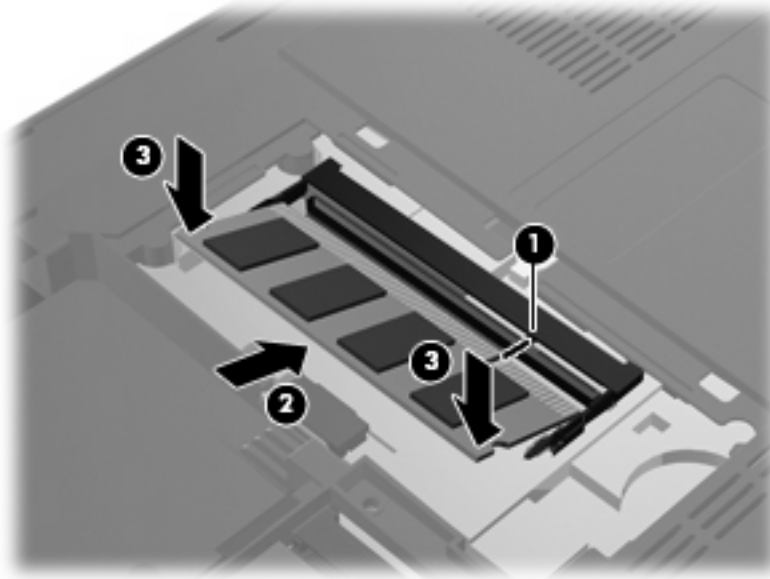

- 11.** Align the tabs on the hard drive cover with the notches on the computer **(1)**, and then close the cover **(2)**.

12. Tighten the 2 hard drive cover screws (3).

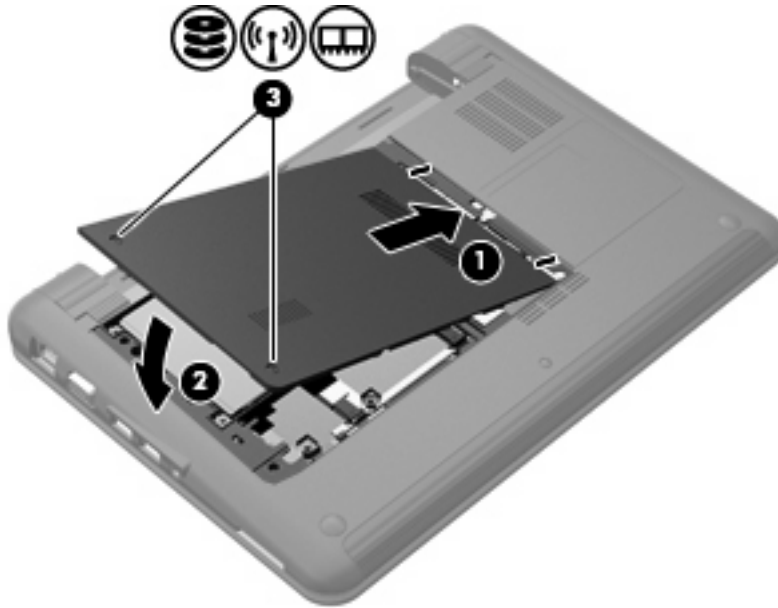

13. Replace the battery.
14. Turn the computer right-side up, and then reconnect external power and external devices.
15. Turn on the computer.

7 Pointing devices and keyboard

Setting pointing device preferences

To access Mouse Properties, select **Start > Devices and Printers**. Then, right-click the device representing your computer, and select **Mouse**.

Use Mouse Properties in Windows® to customize settings for pointing devices, such as button configuration, click speed, and pointer options.

Using pointing devices

Using the TouchPad

To move the pointer, slide your finger across the TouchPad surface in the direction you want the pointer to go. Use the TouchPad buttons like the corresponding buttons on an external mouse. To scroll up and down using the TouchPad vertical scroll zone, slide your finger up or down over the lines.

 **NOTE:** If you are using the TouchPad to move the pointer, you must lift your finger off the TouchPad before moving it to the scroll zone. Simply sliding your finger from the TouchPad to the scroll zone will not activate the scrolling function.

Connecting an external mouse

You can connect an external USB mouse to the computer using one of the USB ports on the computer.

Using the keyboard

Using hotkeys

Hotkeys are combinations of the **fn** key **(1)** and one of the function keys **(2)**.

The icons on the **f1** through **f4**, and **f6**, **f8**, **f10**, and **f11** keys represent the hotkey functions. Hotkey functions and procedures are discussed in the following sections.



| Function | Hotkey |
|--|--------|
|  Initiate Sleep. | fn+f1 |
|  Switch the image. | fn+f2 |
|  Decrease screen brightness. | fn+f3 |
|  Increase screen brightness. | fn+f4 |
|  Initiate QuickLock. | fn+f6 |
|  Mute or restore speaker sound. | fn+f8 |
|  Decrease device volume. | fn+f10 |
|  Increase device volume. | fn+f11 |

To use a hotkey command on the device keyboard, follow either of these steps:

- Briefly press the **fn** key, and then briefly press the second key of the hotkey command.
– or –
- Press and hold down the **fn** key, briefly press the second key of the hotkey command, and then release both keys at the same time.

Initiating Sleep

△ **CAUTION:** To reduce the risk of information loss, save your work before initiating Sleep.

Press **fn+f1** to initiate Sleep.

When Sleep is initiated, your information is stored in memory, the screen is cleared, and power is conserved. While the device is in the Sleep state, the power light blinks.

The device must be on before you can initiate Sleep.

△ **CAUTION:** If a critical battery level occurs while the device is in the Sleep state, the device initiates Hibernation and the information stored in memory is saved to the hard drive. The factory setting for critical battery action is Hibernate, but this setting can be changed using Power Options in Windows Control Panel.

To exit Sleep, briefly press the power button.

The function of the **fn+f1** hotkey can be changed. For example, you can set the **fn+f1** hotkey to initiate Hibernation instead of Sleep.

 **NOTE:** In all Windows operating system windows, references to the *sleep button* apply to the **fn+f1** hotkey.

Switching the screen image

Press **fn+f2** to switch the screen image among display devices connected to the system. For example, if a monitor is connected to the computer, pressing **fn+f2** alternates the screen image from computer display to monitor display to simultaneous display on both the computer and the monitor.

 **NOTE:** You must use a VGA cable (purchased separately) to connect an external display, such as a monitor or projector, to the external monitor port on the computer.

Most external monitors receive video information from the computer using the external VGA video standard. The **fn+f2** hotkey can also alternate images among other devices receiving video information from the computer.

The following video transmission types, with examples of devices that use them, are supported by the **fn+f2** hotkey:

- LCD (computer display)
- External VGA (most external monitors)
- HDMI (televisions, camcorders, DVD players, VCRs, and video capture cards with HDMI ports)

Decreasing screen brightness

Press **fn+f3** to decrease screen brightness. Hold down the hotkey to decrease the brightness level incrementally.

Increasing screen brightness

Press **fn+f4** to increase screen brightness. Hold down the hotkey to increase the brightness level incrementally.

Initiating QuickLock

Press **fn+f6** to initiate the QuickLock security feature.

QuickLock protects your information by displaying the operating system Log On window. While the Log On window is displayed, the computer cannot be accessed until a Windows user password or a Windows administrator password is entered.

 **NOTE:** Before you can use QuickLock, you must set a Windows user password or a Windows administrator password. For instructions, refer to Help and Support.

To use QuickLock, press **fn+f6** to display the Log On window and lock the computer. Then follow the instructions on the screen to enter your Windows user password or your Windows administrator password and access the computer.

Muting speaker sound

Press **fn+f8** to mute speaker sound. Press the hotkey again to restore speaker sound.

Decreasing speaker volume

Press **fn+f10** to decrease speaker sound. Hold down the hotkey to decrease speaker sound incrementally.

Increasing speaker volume

Press **fn+f11** to increase speaker sound. Hold down the hotkey to increase speaker sound incrementally.

8 Power management

Setting power options

Using power-saving states

The computer has two power-saving states enabled at the factory: Sleep and Hibernation.

When Sleep is initiated, the power lights blink and the screen clears. Your work is saved to memory, letting you exit Sleep faster than exiting Hibernation. If the computer is in the Sleep state for an extended period or if the battery reaches a critical battery level while in the Sleep state, the computer initiates Hibernation.

When Hibernation is initiated, your work is saved to a hibernation file on the hard drive and the computer turns off.

△ **CAUTION:** To prevent possible audio and video degradation, loss of audio or video playback functionality, or loss of information, do not initiate Sleep or Hibernation while reading from or writing to a disc or an external media card.

📝 **NOTE:** You cannot initiate any type of networking connection or perform any computer functions while the computer is in the Sleep state or in Hibernation.

Initiating and exiting Sleep

The system is set at the factory to initiate Sleep after 15 minutes of inactivity when running on battery power and 30 minutes of inactivity when running on external power.

Power settings and timeouts can be changed using Power Options in Windows® Control Panel.

With the computer on, you can initiate Sleep in any of the following ways:

- Press **fn+f1**.
- Briefly press the power button.
- Close the display.
- Click **Start**, click the arrow next to the Shut down button, and then click **Sleep**.

You can exit Sleep in any of the following ways:

- Briefly press the power button.
- If the display is closed, open the display.

- Press a key on the keyboard or button on the remote control (select models only).
- Activate the TouchPad.

When the computer exits Sleep, the power light turns on and your work returns to the screen where you stopped working.

 **NOTE:** If you have set a password to be required on wakeup, you must enter your Windows password before your work will return to the screen.

Initiating and exiting Hibernation

The system is set at the factory to initiate Hibernation after 1,080 minutes (18 hours) of inactivity when running on both battery power and external power, or when the battery reaches a critical battery level.

Power settings and timeouts can be changed using Power Options in Windows Control Panel.

To initiate Hibernation:

- ▲ Click **Start**, click the arrow next to the Shut down button, and then click **Hibernate**.

To exit Hibernation:

- ▲ Briefly press the power button.

The power light turns on and your work returns to the screen where you stopped working.

 **NOTE:** If you have set a password to be required on wakeup, you must enter your Windows password before your work will return to the screen.

Using the battery meter

The battery meter is located in the notification area, at the far right of the taskbar. The battery meter allows you to quickly access power settings, view remaining battery charge, and select a different power plan.

- To display the percentage of remaining battery charge and the current power plan, move the pointer over the battery meter icon.
- To access Power Options, or to change the power plan, click the battery meter icon and select an item from the list.

Different battery meter icons indicate whether the computer is running on battery or external power. The icon also displays a message if the battery has reached a low battery level, critical battery level, or reserve battery level.

To hide or display the battery meter icon:

1. Right-click the **Show hidden icons** icon (the arrow at the left side of the notification area).
2. Click **Customize notification icons**.
3. Under **Behaviors**, select **Show icons and notifications** for the Power icon.
4. Click **OK**.

Using power plans

A power plan is a collection of system settings that manages how the computer uses power. Power plans can help you conserve power or maximize performance.

You can change power plan settings or create your own power plan.

Viewing the current power plan

▲ Click the battery meter icon in the notification area, at the far right of the taskbar.

– or –

Select **Start > Control Panel > System and Security > Power Options**.

Selecting a different power plan

▲ Click the battery meter icon in the notification area, and then select a power plan from the list.

– or –

Select **Start > Control Panel > System and Security > Power Options**, and then select a power plan from the list.

Customizing power plans

1. Click the battery meter icon in the notification area and then click **More power options**.

– or –

Select **Start > Control Panel > System and Security > Power Options**.

2. Select a power plan, and then click **Change plan settings**.

3. Change the settings as needed.

4. To change additional settings, click **Change advanced power settings** and make your changes.

Setting password protection on wakeup

To set the computer to prompt for a password when the computer exits Sleep or Hibernation, follow these steps:

1. Select **Start > Control Panel > System and Security > Power Options**.

2. In the left pane, click **Require a password on wakeup**.

3. Click **Change Settings that are currently unavailable**.

4. Click **Require a password (recommended)**.

5. Click **Save changes**.

Using external AC power

External AC power is supplied through one of the following devices:

⚠ **WARNING!** To reduce potential safety issues, use only the AC adapter provided with the computer, a replacement AC adapter provided by HP, or a compatible AC adapter purchased from HP.

- Approved AC adapter
- Optional docking device or expansion product

Connect the computer to external AC power under any of the following conditions:

⚠ **WARNING!** Do not charge the computer battery while you are onboard aircraft.

- When you are charging or calibrating a battery
- When you are installing or modifying system software
- When you are writing information to a CD or DVD

When you connect the computer to external AC power, the following events occur:

- The battery begins to charge.
- If the computer is turned on, the battery meter icon in the notification area changes appearance.

When you disconnect external AC power, the following events occur:

- The computer switches to battery power.
- The display brightness is automatically decreased to save battery life. To increase display brightness, press the **fn+f4** hotkey or reconnect the AC adapter.

Connecting the AC adapter

⚠ **WARNING!** To reduce the risk of electric shock or damage to the equipment:

Plug the power cord into an AC outlet that is easily accessible at all times.

Disconnect power from the computer by unplugging the power cord from the AC outlet (not by unplugging the power cord from the computer).

If provided with a 3-pin attachment plug on the power cord, plug the cord into a grounded (earthed) 3-pin outlet. Do not disable the power cord grounding pin, for example, by attaching a 2-pin adapter. The grounding pin is an important safety feature.

To connect the computer to external AC power:

1. Plug the AC adapter into the power connector **(1)** on the computer.
2. Plug the power cord into the AC adapter **(2)**.
3. Plug the other end of the power cord into an AC outlet **(3)**.

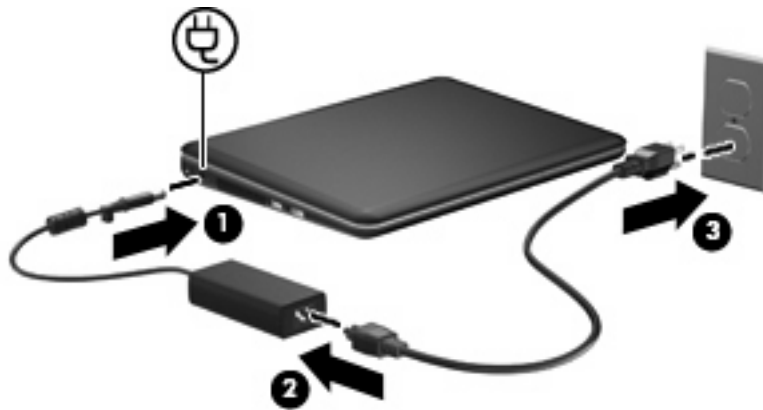

Testing an AC adapter

Test the AC adapter if the computer exhibits any of the following symptoms when it is connected to AC power:

- The computer will not turn on.
- The display does not turn on.
- The power light is off.

To test the AC adapter:

1. Remove the battery from the computer.
2. Connect the AC adapter to the computer, and then plug it into an AC outlet.
3. Turn on the computer.

If the power light turns **on**, the AC adapter is working properly.

Contact technical support for information on obtaining a replacement AC power adapter. Select **Start > Help and Support > Get assistance**.

Using battery power

When a charged battery is in the computer and the computer is not plugged into external power, the computer runs on battery power. When the computer is plugged into external AC power, the computer runs on AC power.

If the computer contains a charged battery and is running on external AC power supplied through the AC adapter, the computer switches to battery power if the AC adapter is disconnected from the computer.

 **NOTE:** The display brightness is decreased to save battery life when you disconnect AC power. To increase display brightness, use the **fn+f4** hotkey or reconnect the AC adapter.

You can keep a battery in the computer or in storage, depending on how you work. Keeping the battery in the computer whenever the computer is plugged into AC power charges the battery and also protects your work in case of a power outage. However, a battery in the computer slowly discharges when the computer is off and unplugged from external power.

 **WARNING!** To reduce potential safety issues, use only the battery provided with the computer, a replacement battery provided by HP, or a compatible battery purchased from HP.

Computer battery life varies, depending on power management settings, programs running on the computer, display brightness, external devices connected to the computer, and other factors.

Finding battery information in Help and Support

Help and Support provides the following tools and information about the battery:

- Battery Check tool to test battery performance
- Information on calibration, power management, and proper care and storage to maximize battery life
- Information on battery types, specifications, life cycles, and capacity

To access battery information:

- ▲ Select **Start > Help and Support > Learn > Power Plans: Frequently Asked Questions**.

Using Battery Check

Help and Support provides information on the status of the battery installed in the computer.

To run Battery Check:

1. Connect the AC adapter to the computer.

 **NOTE:** The computer must be connected to external power for Battery Check to function properly.

2. Select **Start > Help and Support > Troubleshoot > Power, Thermal and Mechanical**.
3. Click the **Power** tab, and then click **Battery Check**.

Battery Check examines the battery and its cells to see if they are functioning properly, and then reports the results of the examination.

Displaying the remaining battery charge

- ▲ Move the pointer over the battery meter icon in the notification area, at the far right of the taskbar.

Inserting or removing the battery

- △ **CAUTION:** Removing a battery that is the sole power source may cause loss of information. To prevent loss of information, save your work and initiate Hibernation or shut down the computer through Windows before removing the battery.
-

To insert the battery:

1. Turn the computer upside down on a flat surface.
2. Align the tabs on the battery with the notches on the computer (1), and then insert the battery into the battery bay. The battery release latches (2) automatically lock the battery into place.

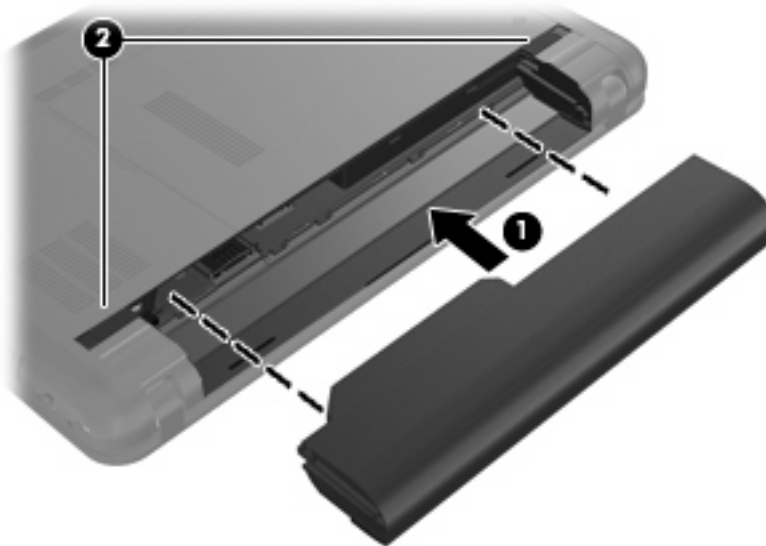

To remove the battery:

1. Turn the computer upside down on a flat surface.

2. Slide the battery release latches (1) to release the battery, and then remove the battery (2).

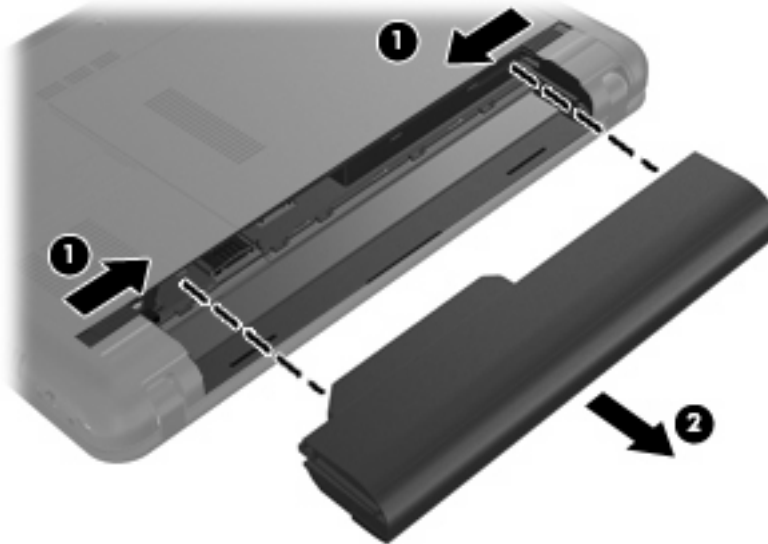

Charging a battery

⚠ WARNING! Do not charge the computer battery while you are onboard aircraft.

The battery charges whenever the computer is plugged into external power through an AC adapter, an optional power adapter, or an optional expansion product.

The battery charges whether the computer is off or in use, but it charges faster when the computer is off.

Charging may take longer if a battery is new, has been unused for 2 weeks or more, or is much warmer or cooler than room temperature.

To prolong battery life and optimize the accuracy of battery charge displays, follow these recommendations:

- If you are charging a new battery, charge it fully before turning on the computer.
- Charge the battery until the battery light turns off.

📝 NOTE: If the computer is on while the battery is charging, the battery meter in the notification area may show 100 percent charge before the battery is fully charged.

- Allow the battery to discharge below 5 percent of a full charge through normal use before charging it.
- If the battery has been unused for one month or more, calibrate the battery instead of simply charging it.

The battery light displays charge status:

- On: The battery is charging.
- Blinking: The battery that is the only available power source has reached a low battery level. When the battery reaches a critical battery level, the battery light begins blinking rapidly.
- Off: The battery is fully charged, in use, or not installed.

Maximizing battery discharge time

Battery discharge time varies depending on the features you use while on battery power. Maximum discharge time gradually shortens, as the battery storage capacity naturally degrades.

Tips for maximizing battery discharge time:

- Lower the brightness on the display.
- Check the **Power saver** setting in Power Options.
- Remove the battery from the computer when it is not being used or charged.
- Store the battery in a cool, dry location.

Managing low battery levels

The information in this section describes the alerts and system responses set at the factory. Some low-battery alerts and system responses can be changed using Power Options in Windows Control Panel. Preferences set using Power Options do not affect lights.

Identifying low battery levels

When a battery that is the sole power source for the computer reaches a low battery level, the battery light blinks.

If a low battery level is not resolved, the computer enters a critical battery level, and the battery light begins blinking rapidly.

The computer takes the following actions for a critical battery level:

- If Hibernation is enabled and the computer is on or in the Sleep state, the computer initiates Hibernation.
- If Hibernation is disabled and the computer is on or in the Sleep state, the computer remains briefly in the Sleep state, and then shuts down and loses any unsaved information.

Resolving a low battery level

△ **CAUTION:** To reduce the risk of losing information when the computer reaches a critical battery level and has initiated Hibernation, do not restore power until the power lights turn off.

Resolving a low battery level when external power is available

- ▲ Connect one of the following devices:
 - AC adapter
 - Optional expansion product or docking device
 - Optional power adapter

Resolving a low battery level when a charged battery is available

1. Turn off the computer or initiate Hibernation.
2. Remove the discharged battery, and then insert a charged battery.
3. Turn on the computer.

Resolving a low battery level when no power source is available

- ▲ Initiate Hibernation.
 - or –
 - Save your work and shut down the computer.

Resolving a low battery level when the computer cannot exit Hibernation

When the computer lacks sufficient power to exit Hibernation, follow these steps:

1. Insert a charged battery or plug the computer into external power.
2. Exit Hibernation by briefly pressing the power button.

Calibrating a battery

Calibrate a battery under the following conditions:

- When battery charge displays seem inaccurate
- When you observe a significant change in battery run time

Even if a battery is heavily used, it should not need to be calibrated more than once a month. It is also not necessary to calibrate a new battery.

Step 1: Fully charge the battery

 **WARNING!** Do not charge the computer battery while you are onboard aircraft.

 **NOTE:** The battery charges whether the computer is off or in use, but it charges faster when the computer is off.

To fully charge the battery:

1. Insert the battery into the computer.
2. Connect the computer to an AC adapter, optional power adapter, optional expansion product, or optional docking device, and then plug the adapter or device into external power.

The battery light on the computer turns on.

3. Leave the computer plugged into external power until the battery is fully charged.

The battery light on the computer turns off.

Step 2: Disable Hibernation and Sleep

1. Click the battery meter icon in the notification area, and then click **More power options**.

– or –

Select **Start > Control Panel > System and Security > Power Options**.

2. Under the current power plan, click **Change plan settings**.
3. Record the **Turn off the display** settings listed in the **On battery** column so that you can reset them after the calibration.
4. Change the **Turn off the display** settings to **Never**.
5. Click **Change advanced power settings**.
6. Click the plus sign next to **Sleep**, and then click the plus sign next to **Hibernate after**.
7. Record the **On battery** setting under **Hibernate after** so that you can reset it after the calibration.
8. Change the **On battery** setting to **Never**.
9. Click **OK**.
10. Click **Save changes**.

Step 3: Discharge the battery

The computer must remain on while the battery is being discharged. The battery can discharge whether or not you are using the computer, but the battery will discharge faster while you are using it.

- If you plan to leave the computer unattended during the discharge, save your information before beginning the discharge procedure.
- If you use the computer occasionally during the discharge procedure and have set energy-saving timeouts, expect the following performance from the system during the discharge process:
 - The monitor will not turn off automatically.
 - Hard drive speed will not decrease automatically when the computer is idle.
 - System-initiated Hibernation will not occur.

To discharge a battery:

1. Unplug the computer from its external power source, but do *not* turn off the computer.
2. Run the computer on battery power until the battery is discharged. The battery light begins to blink when the battery has discharged to a low battery level. When the battery is discharged, the battery light turns off and the computer shuts down.

Step 4: Fully recharge the battery

To recharge the battery:

1. Plug the computer into external power and maintain external power until the battery is fully recharged. When the battery is recharged, the battery light on the computer turns off.

You can use the computer while the battery is recharging, but the battery will charge faster if the computer is off.

2. If the computer is off, turn it on when the battery is fully charged and the battery light has turned off.

Step 5: Reenable Hibernation and Sleep

△ **CAUTION:** Failure to reenable Hibernation after calibration may result in a full battery discharge and information loss if the computer reaches a critical battery level.

1. Click the battery meter icon in the notification area, and then click **More power options**.

– or –

Select **Start > Control Panel > System and Security > Power Options**.

2. Under the current power plan, click **Change plan settings**.
3. Reenter the settings that you recorded for the items in the **On battery** column.
4. Click **Change advanced power settings**.
5. Click the plus sign next to **Sleep**, and then click the plus sign next to **Hibernate after**.
6. Reenter the setting that you recorded for **On battery**.
7. Click **OK**.
8. Click **Save changes**.

Conserving battery power

- Select **Start > Control Panel > System and Security > Power Options > Power saver**.
- Turn off wireless and local area network (LAN) connections and exit modem applications when you are not using them.
- Disconnect external devices that are not plugged into an external power source, when you are not using them.
- Stop, disable, or remove any external media cards that you are not using.
- Use the **fn+f3** and **fn+f4** hotkeys to adjust screen brightness as needed.
- If you leave your work, initiate Sleep or Hibernation, or shut down the computer.

Storing a battery

△ **CAUTION:** To prevent damage to a battery, do not expose it to high temperatures for extended periods of time.

If a computer will be unused and unplugged from external power for more than 2 weeks, remove the battery and store it separately.

To prolong the charge of a stored battery, place it in a cool, dry place.

Calibrate a battery before using it if it has been stored for one month or more.

Disposing of a used battery

△ **WARNING!** To reduce the risk of fire or burns, do not disassemble, crush, or puncture; do not short external contacts; do not dispose of in fire or water.

For additional information, refer to the *Regulatory, Safety and Environmental Notices* included with this computer.

Shutting down the computer

△ **CAUTION:** Unsaved information will be lost when the computer is shut down.

The Shut down command closes all open programs, including the operating system, and then turns off the display and computer.

Shut down the computer under any of the following conditions:

- When you need to replace the battery or access components inside the computer
- When you are connecting an external hardware device that does not connect to a USB port
- When the computer will be unused and disconnected from external power for an extended period

Although you can shut down the computer with the power button, the recommended procedure is to use the Windows Shut down command.

To shut down the computer:

📝 **NOTE:** If the computer is in the Sleep state or in Hibernation, you must first exit Sleep or Hibernation before shutdown is possible.

1. Save your work and close all open programs.
2. Click **Start**.
3. Click **Shut down**.

If the computer is unresponsive and you are unable to use the preceding shutdown procedures, try the following emergency procedures in the sequence provided:

- Press **ctrl+alt+delete**, and then click the **Power** button.
- Press the power button and hold for at least 5 seconds.
- Disconnect the computer from external power and remove the battery.

9 Security

Protecting the computer

Standard security features provided by the Windows operating system and the non-Windows Setup Utility can protect your personal settings and data from a variety of risks.

Follow the procedures in this chapter to use the following features:

- Passwords
- Firewall software
- Antivirus support (Norton Internet Security)
- Critical security updates

 **NOTE:** Security solutions are designed to act as deterrents, but they may not deter software attacks or prevent the computer from being mishandled or stolen.

NOTE: Before you send your computer for service, remove all password settings.

| Computer risk | Security feature |
|--|---|
| Unauthorized use of the computer | <ul style="list-style-type: none">• QuickLock• Power-on password |
| Unauthorized access to data | <ul style="list-style-type: none">• Firewall software• Windows updates |
| Unauthorized access to Setup Utility, BIOS settings, and other system identification information | Administrator password |
| Ongoing or future threats to the computer | Critical security updates from Microsoft |
| Unauthorized access to a Windows user account | User password |

Using passwords

A password is a group of characters that you choose to secure your computer information. Several types of passwords can be set, depending on how you want to control access to your information. Passwords can be set in Windows or in the non-Windows Setup Utility preinstalled on the computer.

△ **CAUTION:** To prevent being locked out of the computer, record each password you set. Because most passwords are not displayed as they are set, changed, or deleted, it is essential to record each password immediately and store it in a secure place.

You can use the same password for a Setup Utility feature and for a Windows security feature. You can also use the same password for more than one Setup Utility feature.

Use the following guidelines when setting a password in Setup Utility:

- A password can be any combination of up to 8 letters and numbers and is case sensitive.
- A password set in Setup Utility must be entered at a Setup Utility prompt. A password set in Windows must be entered at a Windows prompt.

Use the following tips for creating and saving passwords:

- When creating passwords, follow requirements set by the program.
- Write down your passwords and store them in a secure place away from the computer.
- Do not store passwords in a file on the computer.
- Do not use your name or other personal information that could be easily discovered by an outsider.

The following sections list Windows and Setup Utility passwords and describe their functions. For additional information about Windows passwords, such as screen-saver passwords, select **Start > Help and Support**.

Setting passwords in Windows

| Password | Function |
|------------------------|---|
| Administrator password | Protects administrator-level access to computer contents. NOTE: This password cannot be used to access Setup Utility contents. |
| User password | Protects access to a Windows user account. It also protects access to the computer contents and must be entered when you exit Sleep or Hibernation. |
| QuickLock | Protects the computer by requiring a password to be entered in the Windows Log On dialog box before you access the computer. After you set a user or administrator password, follow these steps: <ol style="list-style-type: none">1. Initiate QuickLock by pressing fn+f6.2. Exit QuickLock by entering your Windows user or administrator password. |

Setting passwords in Setup Utility

| Password | Function |
|-------------------------|--|
| Administrator password* | <ul style="list-style-type: none">• Protects access to Setup Utility.• After this password is set, it must be entered each time you access Setup Utility. <p>CAUTION: If you forget your administrator password, you cannot access Setup Utility.</p> |
| Power-on password* | <ul style="list-style-type: none">• Protects access to the computer contents.• After this password is set, it must be entered each time you turn on or restart the computer, or exit Hibernation. <p>CAUTION: If you forget your power-on password, you cannot turn on or restart the computer, or exit Hibernation.</p> |

*For details about each of these passwords, refer to the following topics.

Administrator password

Your administrator password protects the configuration settings and system identification information in Setup Utility. After this password is set, you must enter it each time you access Setup Utility.

Your administrator password is not interchangeable with an administrator password set in Windows, nor is it displayed as it is set, entered, changed, or deleted. Be sure that you record your password and store it in a safe place.

Managing an administrator password

To set, change, or delete this password, follow these steps:

1. Open Setup Utility by turning on or restarting the computer. While the “Press the ESC key for Startup Menu” message is displayed in the lower-left corner of the screen, press **f10**.

– or –

Open Setup Utility by turning on or restarting the computer. While the “Press the ESC key for Startup Menu” message is displayed in the lower-left corner of the screen, press **esc**. When the Startup Menu is displayed, press **f10**.

2. Use the arrow keys to select **Security > Set Administrator Password**, and then press **enter**.
 - To set an administrator password, type your password in the **Enter New Password** and **Confirm New Password** fields, and then press **enter**.
 - To change an administrator password, type your current password in the **Enter Current Password** field, type a new password in the **Enter New Password** and **Confirm New Password** fields, and then press **enter**.
 - To delete an administrator password, type your current password in the **Enter Password** field, and then press **enter** 4 times.
3. To save your changes and exit Setup Utility, use the arrow keys to select **Exit > Exit Saving Changes**.

Your changes go into effect when the computer restarts.

Entering an administrator password

At the **Enter Password** prompt, type your administrator password, and then press [enter](#). After 3 unsuccessful attempts to enter the administrator password, you must restart the computer and try again.

Power-on password

Your power-on password prevents unauthorized use of the computer. After this password is set, it must be entered each time you turn on or restart the computer, or exit Hibernation. A power-on password is not displayed as it is set, entered, changed, or deleted.

Managing a power-on password

To set, change, or delete this password, follow these steps:

1. Open Setup Utility by turning on or restarting the computer. While the “Press the ESC key for Startup Menu” message is displayed in the lower-left corner of the screen, press [f10](#).
– or –
Open Setup Utility by turning on or restarting the computer. While the “Press the ESC key for Startup Menu” message is displayed in the lower-left corner of the screen, press [esc](#). When the Startup Menu is displayed, press [f10](#).
2. Use the arrow keys to select **Security > Set Power-On Password**, and then press [enter](#).
 - To set a power-on password, type your password in the **Enter New Password** and **Confirm New Password** fields, and then press [enter](#).
 - To change a power-on password, type your current password in the **Enter Current Password** field, type a new password in the **Enter New Password** and **Confirm New Password** fields, and then press [enter](#).
 - To delete a power-on password, type your current password in the **Enter Current Password** field, and then press [enter](#) 4 times.
3. To save your changes and exit Setup Utility, use the arrow keys to select **Exit > Exit Saving Changes**.

Your changes go into effect when the computer restarts.

Entering a power-on password

At the **Enter Password** prompt, type your password, and then press [enter](#). After 3 unsuccessful attempts to enter the password, you must restart the computer and try again.

Using antivirus software

When you use the computer for e-mail or Internet access, you expose it to computer viruses that can disable the operating system, programs, or utilities or cause them to function abnormally.

 **NOTE:** HP recommends that you install antivirus software to help protect your computer.

Antivirus software can detect most viruses, destroy them, and in most cases, repair damage they have caused. To provide ongoing protection against newly discovered viruses, antivirus software must be kept up to date.

Norton Internet Security, an antivirus program, is preinstalled on the computer.

- Your version of Norton Internet Security includes 60 days of free updates. It is strongly recommended that you protect the computer against new viruses beyond 60 days by purchasing extended update service. Instructions for using and updating Norton Internet Security software and for purchasing extended update service are provided within the program.
- To access Norton Internet Security, or to get more information about it, click **Start > All Programs > Norton Internet Security**.

 **NOTE:** HP recommends that you always update the antivirus software to help protect your computer.

NOTE: For more information about computer viruses, type `viruses` in the Search box in Help and Support.

Using firewall software

When you use the computer for e-mail, network, or Internet access, unauthorized persons may be able to gain access to the computer, your personal files, and information about you. Use the firewall software preinstalled on the computer to protect your privacy.

Firewall features include logging and reporting of network activity, and automatic monitoring of all incoming and outgoing traffic. Refer to the firewall user guide or contact your firewall manufacturer for more information.

 **NOTE:** Under some circumstances a firewall can block access to Internet games, interfere with printer or file sharing on a network, or block authorized e-mail attachments. To temporarily resolve the problem, disable the firewall, perform the task that you want to perform, and then reenable the firewall. To permanently resolve the problem, reconfigure the firewall.

Installing critical updates

△ **CAUTION:** Microsoft sends alerts regarding critical updates. To protect the computer from security breaches and computer viruses, install all critical updates from Microsoft as soon as you receive an alert.

Updates to the operating system and other software may have become available after the computer was shipped. To be sure that all available updates are installed on the computer, observe these guidelines:

- Run Windows Update as soon as possible after you set up your computer. Use the update link at **Start > All Programs > Windows Update**.
- Run Windows Update at regular intervals, such as once a month.
- Obtain updates to Windows and other Microsoft programs, as they are released, from the Microsoft Web site and through the updates link in Help and Support.

10 Software updates

Updated versions of the software provided with your computer may be available on the HP Web site.

Most software and BIOS updates on the HP Web site are packaged in compressed files called *SoftPags*.

Some download packages contain a file named Readme.txt, which contains information regarding installing and troubleshooting the file.

To update the software, follow these steps, which are explained in the remainder of this guide:

1. Identify your computer model, product category, and series or family. Prepare for a system BIOS update by identifying the BIOS version currently installed on the computer.

If your computer is connected to a network, consult the network administrator before installing any software updates, especially system BIOS updates.

 **NOTE:** The computer system BIOS is stored on the system ROM. The BIOS initializes the operating system, determines how the computer will interact with the hardware devices, and provides for data transfer among hardware devices, including the time and date.

2. Access the updates on the HP Web site at <http://www.hp.com>.
3. Install the updates.

Updating the BIOS

To update the BIOS, first determine what BIOS version you currently have and then download and install the new BIOS.

Determining the BIOS version

To determine whether available BIOS updates contain later BIOS versions than those currently installed on the computer, you need to know the version of the system BIOS currently installed.

BIOS version information (also known as *ROM date* and *System BIOS*) can be displayed by opening Setup Utility.

To display the BIOS information:

1. Open Setup Utility by turning on or restarting the computer. While the “Press the ESC key for Startup Menu” message is displayed in the lower-left corner of the screen, press **f10**.

– or –

Open Setup Utility by turning on or restarting the computer. While the “Press the ESC key for Startup Menu” message is displayed in the lower-left corner of the screen, press **esc**. When the Startup Menu is displayed, press **f10**.

2. If Setup Utility does not open with the system information displayed, use the arrow keys to select the **Main** menu.

When the Main menu is selected, BIOS and other system information is displayed.

3. To exit Setup Utility, use the arrow keys to select **Exit > Exit Discarding Changes**, and then press **enter**.

Downloading a BIOS update

- △ **CAUTION:** To prevent damage to the computer or an unsuccessful installation, download and install a BIOS update only when the computer is connected to reliable external power using the AC adapter. Do not download or install a BIOS update while the computer is running on battery power, docked in an optional docking device, or connected to an optional power source. During the download and installation, follow these instructions:

Do not disconnect power from the computer by unplugging the power cord from the AC outlet.

Do not shut down the computer or initiate Sleep or Hibernation.

Do not insert, remove, connect, or disconnect any device, cable, or cord.

To download a BIOS update:

1. Access the page on the HP Web site that provides software for your computer:
Select **Start > Help and Support > Maintain > Software Updates**.
2. Follow the instructions on the screen to identify your computer and access the BIOS update you want to download.
3. At the download area, follow these steps:
 - a. Identify the BIOS update that is later than the BIOS version currently installed on your computer. Make a note of the date, name, or other identifier. You may need this information to locate the update later, after it has been downloaded to your hard drive.
 - b. Follow the instructions on the screen to download your selection to the hard drive.

Make a note of the path to the location on your hard drive where the BIOS update is to be downloaded. You must access this path when you are ready to install the update.

 **NOTE:** If you connect your computer to a network, consult the network administrator before installing any software updates, especially system BIOS updates.

BIOS installation procedures vary. Follow any instructions that are displayed on the screen after the download is complete. If no instructions are displayed, follow these steps:

1. Open Windows Explorer by selecting **Start > Computer**.
2. Double-click your hard drive designation. The hard drive designation is typically Local Disk (C:).
3. Using the hard drive path you recorded earlier, open the folder on your hard drive that contains the update.
4. Double-click the file that has an .exe extension (for example, *filename.exe*).

The BIOS installation begins.
5. Complete the installation by following the instructions on the screen.

 **NOTE:** After a message on the screen reports a successful installation, you can delete the downloaded file from your hard drive.

Updating programs and drivers

To download and install software other than a BIOS update, follow these steps:

1. Access the page on the HP Web site that provides software for your computer:
Select **Start > Help and Support**, and then select the software and drivers update.
2. Follow the instructions on the screen to find the software you want to update.
3. At the download area, select the software you want to download and follow the instructions on the screen.

 **NOTE:** Make a note of the path to the location on your hard drive where the software is to be downloaded. You must access this path when you are ready to install the software.

4. When the download is complete, open Windows Explorer by selecting **Start > Computer**.
5. Double-click your hard drive designation. The hard drive designation is typically Local Disk (C:).
6. Using the hard drive path you recorded earlier, open the folder on your hard drive that contains the update.
7. Double-click the file that has an .exe extension (for example, *filename.exe*).
The installation begins.
8. Complete the installation by following the instructions on the screen.

 **NOTE:** After a message on the screen reports a successful installation, you can delete the downloaded file from your hard drive.

11 Setup Utility (BIOS)

Starting Setup Utility

Setup Utility is a ROM-based information and customization utility that can be used even when your Windows® operating system is not working.

The utility reports information about the computer and provides settings for startup, security, and other preferences.

To start Setup Utility:

- ▲ Open Setup Utility by turning on or restarting the computer. While the “Press the ESC key for Startup Menu” message is displayed in the lower left corner of the screen, press **f10**.

– or –

1. Open Setup Utility by turning on or restarting the computer. While the “Press the ESC key for Startup Menu” message is displayed in the lower left corner of the screen, press **esc**.
2. When the Startup Menu is displayed, press **f10**.

Using Setup Utility

Changing the language of Setup Utility

The following procedure explains how to change the language of Setup Utility. If Setup Utility is not already running, begin at step 1. If Setup Utility is already running, begin at step 2.

1. Open Setup Utility by turning on or restarting the computer. While the “Press the ESC key for Startup Menu” message is displayed in the lower left corner of the screen, press **f10**.

– or –

Open Setup Utility by turning on or restarting the computer. While the “Press the ESC key for Startup Menu” message is displayed in the lower left corner of the screen, press **esc**. When the Startup Menu is displayed, press **f10**.

2. Use the arrow keys to select **System Configuration > Language**, and then press **enter**.
3. Use the arrow keys to select a language, and then press **enter**.
4. When a confirmation prompt with your language selected is displayed, press **enter**.
5. To save your change and exit Setup Utility, use the arrow keys to select **Exit > Exit Saving Changes**, and then press **enter**.

Your change goes into effect immediately.

Navigating and selecting in Setup Utility

Because Setup Utility is not Windows-based, it does not support the TouchPad. Navigation and selection are by keystroke.

- To choose a menu or a menu item, use the arrow keys.
- To choose an item in a list or to toggle a field, for example an Enable/Disable field, use either the arrow keys or **f5** or **f6**.
- To select an item, press **enter**.
- To close a text box or return to the menu display, press **esc**.
- To display additional navigation and selection information while Setup Utility is open, press **f1**.

Displaying system information

You can use Setup Utility to view such information as the system time and date and information that identifies the computer. The following procedure explains how to do this. If Setup Utility is not open, begin at step 1. If Setup Utility is open, begin at step 2.

1. Open Setup Utility by turning on or restarting the computer. While the “Press the ESC key for Startup Menu” message is displayed in the lower left corner of the screen, press **f10**.

– or –

Open Setup Utility by turning on or restarting the computer. While the “Press the ESC key for Startup Menu” message is displayed in the lower left corner of the screen, press **esc**. When the Startup Menu is displayed, press **f10**.

2. Select the **Main** menu.
3. To exit Setup Utility without changing any settings, use the arrow keys to select **Exit > Exit Discarding Changes**, and then press **enter**.

Restoring default settings in Setup Utility

The following procedure explains how to restore Setup Utility default settings. If Setup Utility is not already running, begin at step 1. If Setup Utility is already running, begin at step 2.

1. Open Setup Utility by turning on or restarting the computer. While the “Press the ESC key for Startup Menu” message is displayed in the lower left corner of the screen, press **f10**.

– or –

Open Setup Utility by turning on or restarting the computer. While the “Press the ESC key for Startup Menu” message is displayed in the lower left corner of the screen, press **esc**. When the Startup Menu is displayed, press **f10**.

2. Use the arrow keys to select **Exit > Load Setup Defaults**, and then press **enter**.
3. When the Setup Confirmation is displayed, press **enter**.
4. To save your change and exit Setup Utility, use the arrow keys to select **Exit > Exit Saving Changes**, and then press **enter**.

Setup Utility default settings go into effect when the computer restarts.

 **NOTE:** Your password, security, and language settings are not changed when you restore the factory default settings.

Exiting Setup Utility

You can exit Setup Utility with or without saving changes.

- To exit Setup Utility and save your changes from the current session:

If the Setup Utility menus are not visible, press **esc** to return to the menu display. Then use the arrow keys to select **Exit > Exit Saving Changes**, and then press **enter**.

- To exit Setup Utility without saving your changes from the current session:

If the Setup Utility menus are not visible, press **esc** to return to the menu display. Then use the arrow keys to select **Exit > Exit Discarding Changes**, and then press **enter**.

After either choice, the computer restarts in Windows.

Setup Utility menus

The menu tables in this section provide an overview of Setup Utility options.

 **NOTE:** Some of the Setup Utility menu items listed in this chapter may not be supported by your computer.

Main menu

| Select | To do this |
|--------------------|---|
| System information | <ul style="list-style-type: none">• View and change the system time and date.• View identification information about the computer.• View specification information about the processor, memory size, system BIOS, and keyboard controller version (select models only). |

Security menu

| Select | To do this |
|------------------------|---|
| Administrator password | Enter, change, or delete an administrator password. |
| Power-On Password | Enter, change, or delete a power-on password. |

System Configuration menu

| Select | To do this |
|--|---|
| Language Support | Change the language of Setup Utility. |
| Virtualization Technology (select models only) | Enable/disable the processor Virtualization Technology. |
| LAN Power Saving (select models only) | Enable/disable LAN Power Saving. When enabled, saves power when the computer is in DC mode. |
| Fan Always On | Enabled/disable Fan Always On. When enabled, the computer fan will always be on. |
| Boot Options | <p>Set the following boot options:</p> <ul style="list-style-type: none">• POST (power-on self test) f10 and f12 Delay (sec.)—Set the delay for the f10 and f12 functions of Setup Utility in intervals of 5 seconds each (0, 5, 10, 15, 20).• HP QuickWeb—Enable/disable the HP QuickWeb Boot Menu during POST.<ul style="list-style-type: none">◦ Delay to boot Windows—Set the delay for the HP QuickWeb Boot Menu to 2, 3, 5, 10, 15, or 30 seconds.• CD-ROM Boot—Enable/disable boot from CD-ROM.• Floppy Boot—Enable/disable boot from diskette.• Internal Network Adapter Boot—Enable/disable boot from the internal network adapter.• Boot Order—Set the boot order for:<ul style="list-style-type: none">◦ Notebook Hard Drive◦ USB Diskette on Key/USB Hard Drive◦ USB CD/DVD ROM Drive◦ USB Floppy◦ Network Adapter |

Diagnostics menu

| Select | To do this |
|-----------------------------|--|
| Primary Hard Disk Self Test | <p>Run a comprehensive self-test on the hard drive.</p> <p>NOTE: On models with two hard drives, this menu option is called the Primary Hard Disk Self Test.</p> |
| Memory Test | Run a diagnostic test on the system memory. |

Index

A

- AC adapter
 - connecting 63
 - identifying 14
 - testing 63
- administrator password
 - creating 76
 - entering 77
 - managing 76
- airport security devices 41
- antennas 13
- applications key, Windows 7
- audio devices, connecting
 - external 36
- audio functions, checking 36
- audio-in (microphone) jack 9, 32
- audio-out (headphone) jack 9, 32

B

- battery
 - calibrating 69
 - charging 66, 69
 - conserving power 72
 - discharging 67
 - disposing 72
 - identifying 14
 - inserting 65
 - low battery levels 67
 - recharging 70
 - removing 65
 - storing 72
- battery bay, identifying 12
- Battery Check 64
- battery light 8, 66, 67
- battery power 64
- battery release latches 12, 65
- battery temperature 72
- bay, battery 12
- BD drive 46

- BIOS, updating 81
- Blu-ray Disc ROM with SuperMulti DVD±R/RW Double Layer 46
- Bluetooth device 16
- boot options 88
- boot order 88
- buttons
 - left TouchPad 4
 - power 6
 - right TouchPad 4
 - wireless 6

C

- cables
 - LAN 30
 - USB 48
 - VGA 37
- caps lock light, identifying 5
- CD drive 46
- changing the language of Setup Utility 85
- charging batteries 66, 69
- checking audio functions 36
- components
 - additional hardware 14
 - bottom 12
 - display 11
 - front 8
 - left-side 10
 - right-side 9
 - TouchPad 4
- connecting to a WLAN 22
- connection, external power 63
- conservation, power 72
- cord, power 14
- corporate WLAN connection 22
- critical battery level 67

D

- Diagnostics menu 88

- digital card
 - inserting 49
 - removing 50
 - stopping 50
 - supported formats 49
- Digital Media Slot, identifying 9
- Disk Cleanup software 42
- Disk Defragmenter software 42
- diskette drive 46
- display
 - image, switching 57
 - screen brightness hotkeys 58
- display switch, identifying 11
- displaying system information 86
- drive light, identifying 8
- drive media 59
- drives
 - boot order 88
 - connecting external 47
 - diskette 46
 - external 46
 - hard 43, 44, 46
 - optical 46
- DVD drive 46

E

- earbuds 9, 32
- encryption 21
- entering a power-on password 77
- entering an administrator password 77
- esc key 7
- exiting Setup Utility 87
- external audio devices, connecting 36
- external drive 46
- external monitor port 37
- external monitor port, identifying 9

- F**
- fan always on 88
- firewall 21
- fn key 7, 56
- function keys 7, 56
- H**
- hard disk drive
 - external 46
 - installing 44
 - removing 43
 - replacing 43
- hard drive
 - external 46
 - installing 44
 - removing 43
 - replacing 43
- hard drive bay, identifying 12
- hard drive cover
 - removing 52
 - replacing 53
- hard drive self test 88
- hardware, identifying 3
- HDMI port 38
- HDMI port, identifying 10
- HDMI, connecting 38
- headphone (audio-out) jack 9, 32
- headphones 9, 32
- Hibernation
 - exiting 60
 - initiated during critical battery level 67
 - initiating 60
- high-definition devices, connecting 38
- hotkeys
 - decreasing screen brightness 58
 - decreasing speaker sound 58
 - decreasing speaker volume 33
 - description 56
 - increasing screen brightness 58
 - increasing speaker volume 33, 58
 - initiating QuickLock 58
 - initiating Sleep 57
 - muting speaker sound 58
 - muting speaker volume 33
 - switching screen image 57
 - using 57
- HP Connection Manager software 19
- HP Mobile Broadband Module 23, 24
- HP QuickWeb Setup Utility 88
 - using 1
- HP USB Ethernet Adapter, connecting 30
- hubs 48
- I**
- icons
 - network 17, 28
 - wireless 17
- installed drives, identifying 40
- interference, minimizing 29
- internal display switch, identifying 11
- internal microphone, identifying 11, 32
- Internet connection setup 20
- J**
- jacks
 - audio-in (microphone) 9, 32
 - audio-out (headphone) 9, 32
 - RJ-45 (network) 9
- K**
- keyboard hotkeys, identifying 56
- keys
 - esc 7
 - fn 7
 - function 7
 - Windows applications 7
 - Windows logo 7
- L**
- labels
 - Microsoft Certificate of Authenticity 15
 - regulatory 15
 - service tag 15
- LAN Power Saving 88
- language support 88
- latches, battery release 12
- left TouchPad button, identifying 4
- lights
 - battery 8
 - caps lock 5
 - drive 8
 - power 5
 - webcam 11
 - wireless 5
- local area network (LAN)
 - cable required 30
 - connecting cable 30
- low battery level 67
- M**
- Main menu 87
- maintenance
 - Disk Cleanup 42
 - Disk Defragmenter 42
- managing a power-on password 77
- managing an administrator password 76
- memory module
 - inserting 53
 - removing 52
- memory module slot 12
- memory test 88
- microphone (audio-in) jack 9, 32
- minimizing interference 29
- monitor port, external 9
- monitor, connecting 37
- mouse, external
 - connecting 55
 - setting preferences 55
- multimedia components, identifying 32
- multimedia software
 - installing 35
 - using 35
- mute hotkey, identifying 33
- N**
- navigating in Setup Utility 85
- network cable
 - connecting 30
 - noise suppression circuitry 30
- network cable, connecting 30
- network icon 17, 28
- network jack, identifying 9

- network key 28
- network security codes
 - network key 28
 - SSID 28
- noise suppression circuitry, network cable 30

O

- operating system 73
- optical drive
 - sharing 47

P

- passwords
 - administrator 76
 - power-on 77
 - set in Setup Utility 76
 - set in Windows 75
- ports
 - external monitor 9, 37
 - HDMI 10, 38
 - USB 9, 10, 48
- power
 - connecting 63
 - conserving 72
- power button, identifying 6
- power connector, identifying 10
- power cord, identifying 14
- power light, identifying 5
- power-on password
 - creating 77
 - entering 77
 - managing 77
- product name and number, computer 15
- programs, updating 83
- projector, connecting 37
- public WLAN connection 22

Q

- QuickLock 75
- QuickLock hotkey 58

R

- readable media 59
- regulatory information
 - HP Mobile Broadband Module
 - serial number 15
 - regulatory label 15
 - wireless 15

- release latches
 - battery 12, 66
- restoring default settings 86
- right TouchPad button, identifying 4
- RJ-45 (network) jack, identifying 9

S

- screen brightness hotkeys 58
- screen image, switching 57
- security cable slot, identifying 10
- Security menu 87
- security, wireless 21
- selecting in Setup Utility 85
- serial number, computer 15
- service tag 15
- setup of WLAN 20
- Setup Utility, passwords set in 76
- setup, computer 3
- shared drives 47
- shutdown 73
- shutting down 73
- SIM
 - inserting 24
 - removing 25
- Sleep
 - exiting 59
 - initiating 59
- Sleep hotkey 57
- slots
 - security cable 10
- software
 - Disk Cleanup 42
 - Disk Defragmenter 42
 - HP Connection Manager 19
 - installing 35
 - multimedia 35
 - Windows Media Player 35
 - Wireless Assistant 18
- solid-state drive (SSD) 40
- speakers, identifying 8, 32
- starting Setup Utility 84
- storing battery 72
- System Configuration menu 88
- system information 87

T

- temperature 72

- TouchPad
 - buttons 4
 - identifying 4
 - using 55
- TouchPad scroll zone, identifying 4
- traveling with the computer 72
- turning off the computer 73

U

- unresponsive system 73
- USB cable, connecting 48
- USB devices
 - connecting 48
 - description 48
 - removing 49
 - stopping 49
- USB hubs 48
- USB ports, identifying 9, 10, 48
- using Setup Utility 85

V

- vents, identifying 10, 12
- video transmission types 57
- Virtualization Technology 88
- volume down hotkey, identifying 33
- volume up hotkey, identifying 33
- volume, adjusting 33

W

- webcam light, identifying 11, 32
- webcam, identifying 11, 32
- Windows applications key, identifying 7
- Windows logo key, identifying 7
- Windows, passwords set in 75
- wireless antennas 13
- Wireless Assistant software 17, 18
- wireless button, identifying 6
- wireless controls
 - button 17
 - HP Connection Manager 17
 - operating system 17
 - Wireless Assistant software 17
- wireless function key 17
- wireless icon 17
- wireless light 17
- wireless light, identifying 5

- wireless network (WLAN)
 - connecting 22
 - corporate WLAN
 - connection 22
 - equipment needed 20
 - functional range 22
 - public WLAN connection 22
 - security 21
- WLAN 12
- WLAN antennas, identifying 13
- WLAN device 16
- writable media 59
- WWAN antennas, identifying 13
- WWAN device 23

