



# HP V5040U

Digital Camcorder

User Manual

# Contents

<b>Section 1</b>	<b>Getting to Know Your Camera.....</b>	<b>2</b>
<b>Section 2</b>	<b>Getting Started.....</b>	<b>5</b>
<b>Section 3</b>	<b>Enjoying the Record Mode .....</b>	<b>7</b>
<b>Section 4</b>	<b>Enjoying the Playback Mode .....</b>	<b>17</b>
<b>Section 5</b>	<b>Setting Your Camera .....</b>	<b>25</b>
<b>Section 6</b>	<b>Viewing Pictures and Movies on a TV .....</b>	<b>29</b>
<b>Section 7</b>	<b>Viewing Pictures and Movies on PC.....</b>	<b>30</b>
<b>Section 8</b>	<b>Burning the Recorded Clip into DVD.....</b>	<b>31</b>
<b>Section 9</b>	<b>Uploading Video Files to YouTube.....</b>	<b>33</b>
<b>Section 10</b>	<b>Specifications and System Requirement .....</b>	<b>37</b>
<b>Section 11</b>	<b>Troubleshooting.....</b>	<b>39</b>
<b>Section 12</b>	<b>Getting Help .....</b>	<b>40</b>

# Section 1

## Getting to Know Your Camera

### Overview

**About this Manual:** This manual is designed to assist you in using your new digital camera. All information presented is as accurate as possible but is subject to change without notice.

For the latest revision, please visit HYPERLINK <http://www.hp.com/support> .

This camera contains a 5 Mega Pixel sensor that produces H.264 video files. By way of using H.264 technology, more videos can be taken within certain amount of memory. High quality images with up to 12 mega-pixels can also be delivered smoothly. With a color LCD monitor, users can compose images and examine them easily.

This camera also features video recording at HD resolution of 1440x1080. You can also connect it to an HDTV via HDMI cable, and easily playback recorded high-definition videos on the screen HDTV.

Moreover, the camera has an advanced uploading feature. With the exclusive built-in YouTube Direct application, you can upload the videos captured by the camera to YouTube more effortlessly.

ISO speed and color balance can either be adjusted automatically or allowed to be changed manually. A 4x digital zoom increases you control over the movies and pictures you take.

The built-in memory allows you to take pictures and video without memory card. However, it is strongly recommended to use a SD or SDHC memory card to fully enjoy the capabilities of this video camcorder. The SD/SDHC memory card slot located on the top of the camera easily allows you to expand the storage capacity.



#### **Note**

*Some of the built-in memory is used for Firmware code.*

### Standard Accessories

Unpack the package and make sure all standard accessories listed are included:

- HP V5040u Digital Camcorder
- AC Adapter
- Lithium-ion Rechargeable Battery (NP60)
- USB Cable
- AV Cable
- HDMI Cable
- CD-ROM ( Software and User's Manual)
- CD-ROM (Nero 9 software)
- Quick Start Guide
- Warranty Card
- Declaration of Conformity card
- Strap
- Pouch
- Cleaning cloth
- 4G SD Card

## Front View

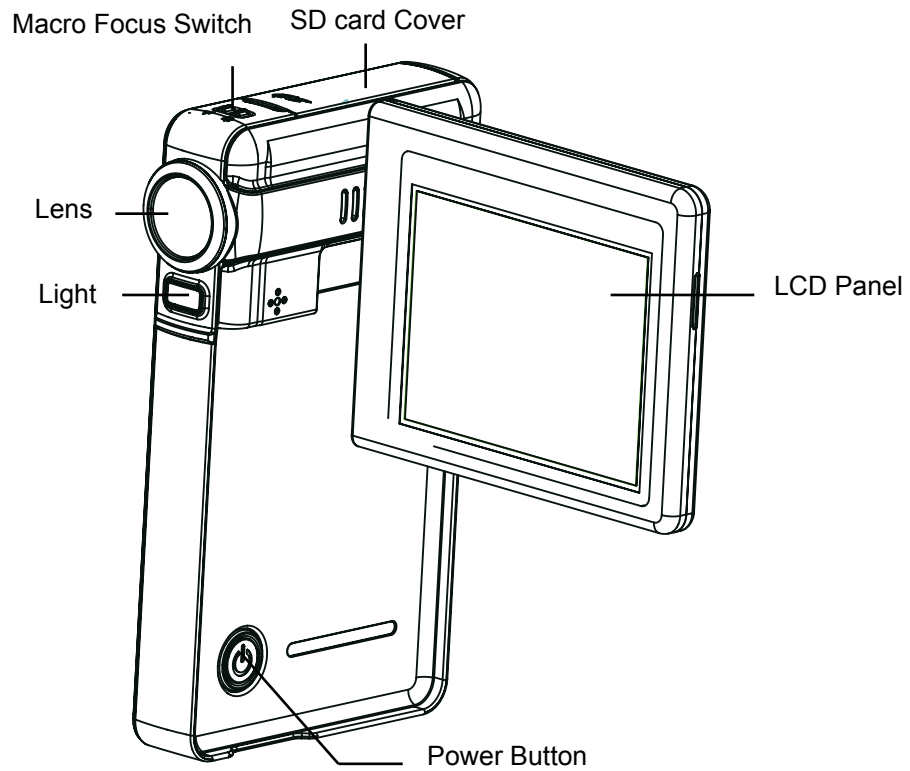

## Rear View

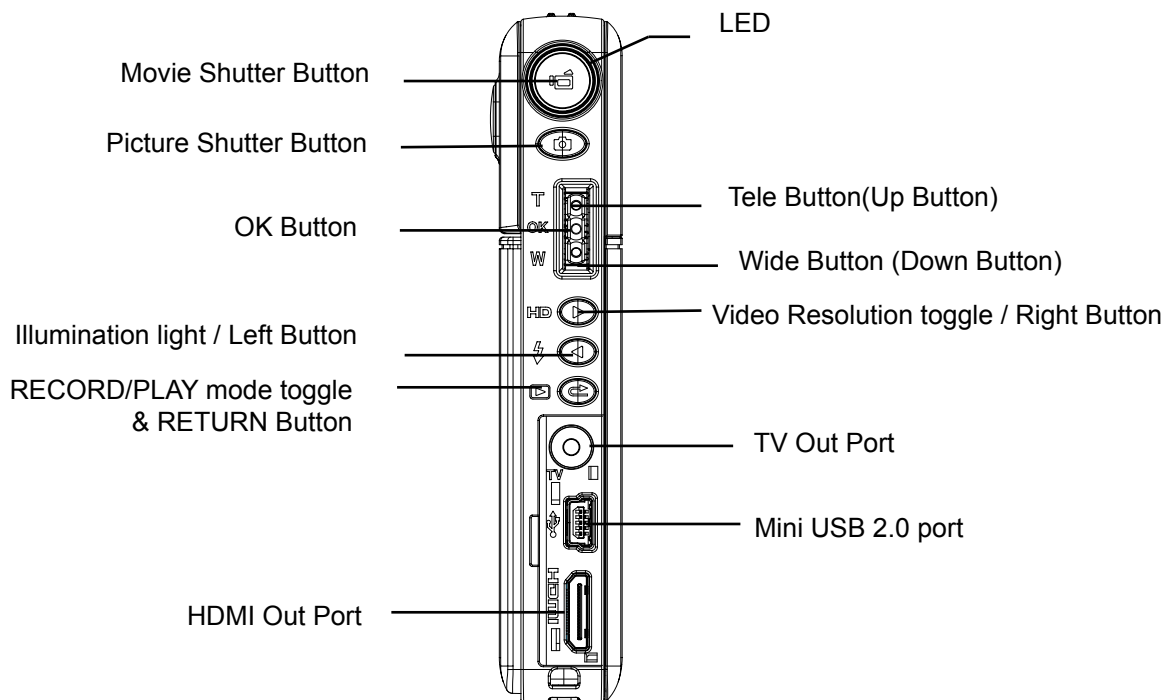

## Side View

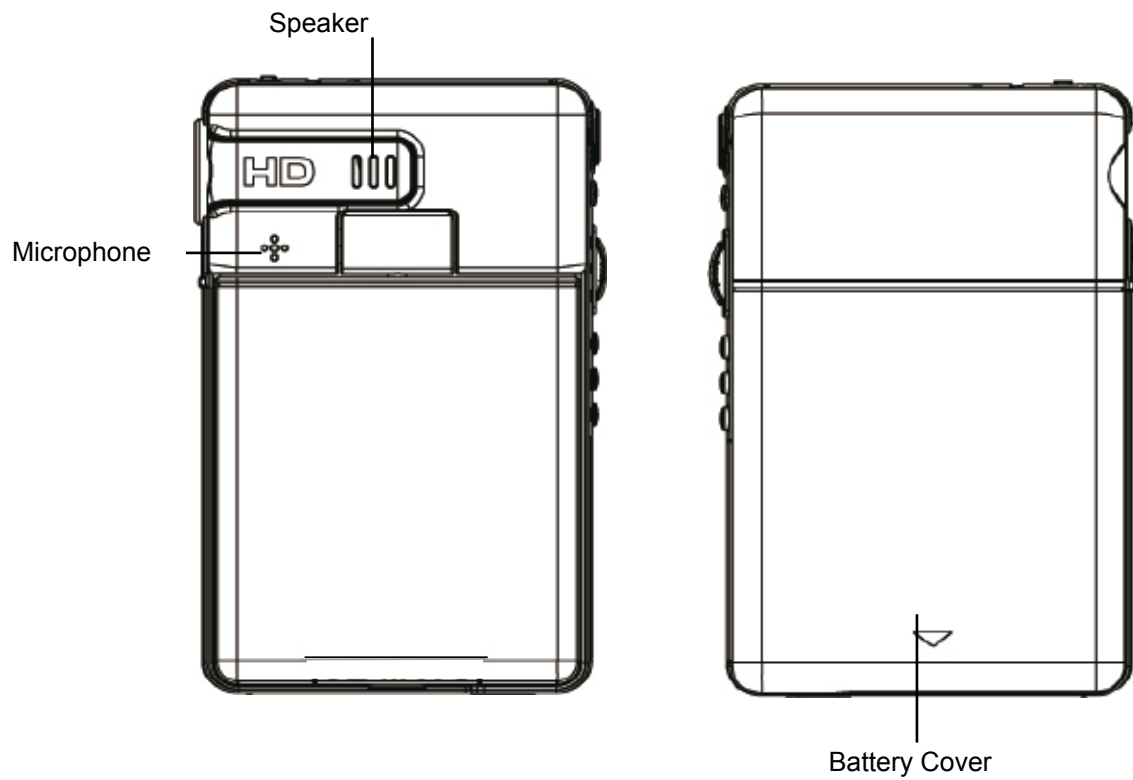

## Bottom View

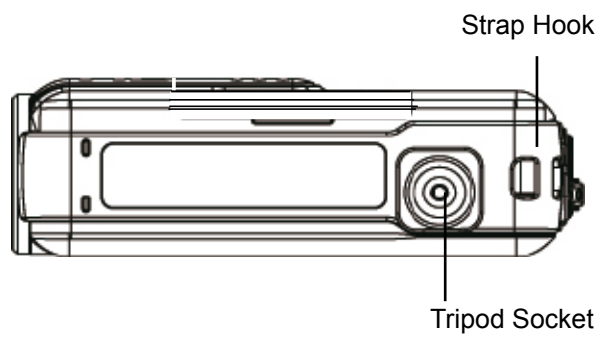

## Section 2 Getting Started

### Loading the Battery

Before using the camera, users must load Lithium-ion rechargeable battery.

1. Follow the arrow A direction and slide to eject the battery cover.
2. Insert the battery following to the correct polarity marks ( + or -).
3. Close the battery cover firmly.

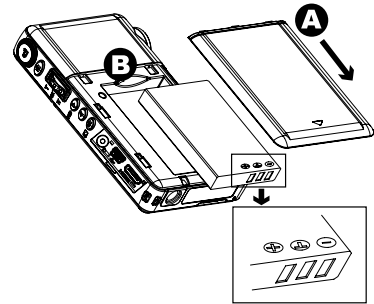

### Inserting and Removing an SD Card

The camera comes with internal memory which allows you to store pictures and movies. You can expand the memory capacity by using an SD memory card.

1. Insert the memory card into the right position. Please refer to the figure.
2. To remove an installed SD card, press the card inwards to release it.
3. When the card pops out, gently remove it from its slot.
4. Recommended memory capacity: 1GB above

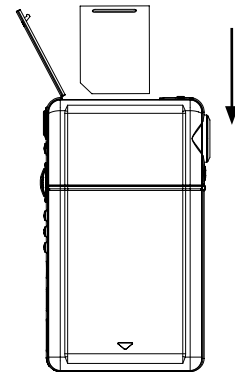

#### Note

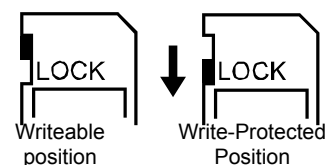

- When a memory card is fitted, movies/pictures are saved on card rather than on the built-in memory.
- *Protecting data on an SD card: SD card is read-only by locking the SD card. No pictures and movies can be recorded when the SD card is locked. Make sure the lock is on writeable position before recording any media.*

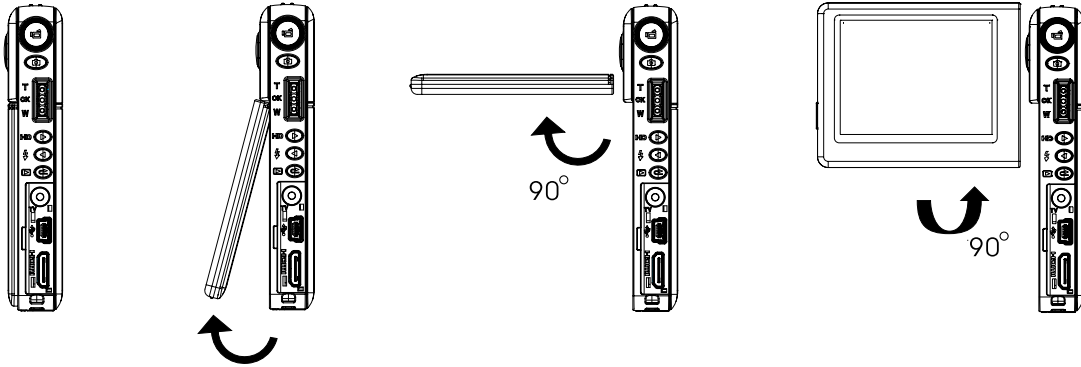

## Turning the Camera On and Getting Started

- To turn on the camera:
  1. Flip out the LCD panel; the camera will turn on automatically.
  2. Or press Power Button for one second to turn on it.



- To take a movie, press the Movie Shutter Button (  ).
- To take a picture, press the Picture Shutter Button (  ).
- To view stored movies and pictures, press RECORD/PLAY mode toggle and RETURN Button (  ) once to switch to Playback Mode. Press a second time to return to Record Mode.







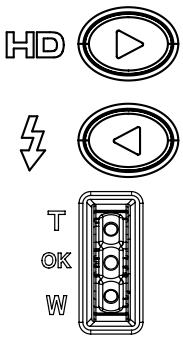

## Turning the Camera Off

- To turn off the camera, you can either press the Power Button for one second, or you can place the LCD panel back to its original position.

## Section 3

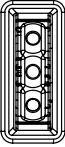
# Enjoying the Record Mode

### Button Function

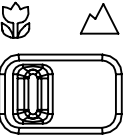
 <p>HD </p> <p> </p> <p>T OK W </p>	<p><b>Direction Button:</b></p> <p><b>Right Button:</b> HD(1080p)/WVGA mode switch</p> <p><b>Left Button:</b> Digital Light On/ Light On/ Light OFF</p> <p><b>Tele Button(Up Button) :</b> Digital Zoom In</p> <p><b>Wide Button(Down Button) :</b> Digital Zoom out</p> <p><b>OK Button:</b> Menu ON/Validate the setting</p>
	<p><b>Power Button:</b> Press down for one second to turn on or turn off the camera.</p>
	<p><b>RECORD/PLAY mode toggle and RETURN Button functions:</b></p> <ol style="list-style-type: none"> <li>1. Switch between Record /Playback Mode</li> <li>2. Return to the previous page</li> <li>3. For quick review, press it after recording</li> </ol>
	<p><b>Movie Shutter Button:</b></p> <ol style="list-style-type: none"> <li>1. Start to take movie.</li> <li>2. To stop recording, press it again.</li> </ol>
	<p><b>Picture Shutter Button:</b> Start to take picture.</p>
	<p><b>Macro Focus Switch:</b> Use this to switch between Macro/ close lens focus mode and Normal lens focus Mode.</p>







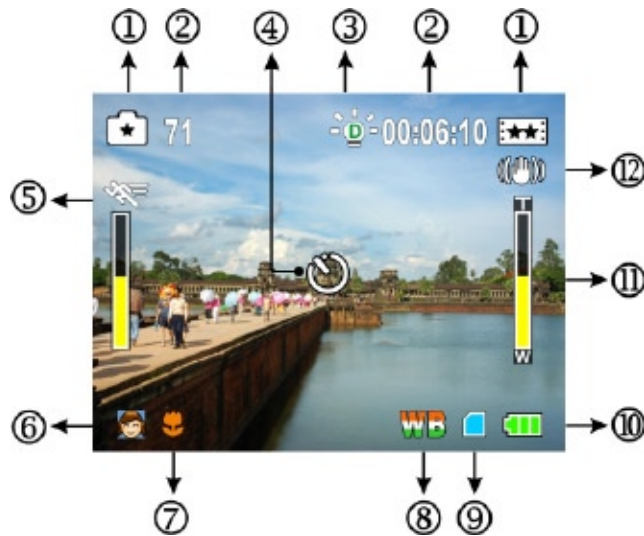







## LCD Monitor Information

The indicator shown below may display on LCD when movies and pictures are recorded:



(1)	Movie Resolution	
		HD (1080p) (30fps)
		HD (720p) (30fps)
		WVGA (60fps)
		VGA (30fps)
		QVGA (30fps)
	Picture Resolution	
		High
		Standard
	Low	
(2)	<b>71</b>	Number of images that can still be taken at current resolution
	<b>00:06:10</b>	Recording time of movie that can still be taken at current resolution
(3)		Digital Light On
		Light On
(4)		Self timer enabled



(5)		Motion Detection
(6)	Scene	
		Skin
		Night
		Backlight
(7)		Macro Position Focusing
(8)	<b>WB</b>	Manual White Balance
(9)		SD Card inserted
(10)		Battery: full power
		Battery: medium power
		Battery: low power
		Battery: power empty
(11)		Zoom meter: HD(1080p):2X (2X Digital zoom) Other video resolution:1X~4X (4X Digital zoom)
(12)		Stabilization







### Note

Scene: B/W / Classic / Negative effect can be previewed immediately without indicator on the LCD

## Movie Recording

- Press Movie Shutter Button (  ) to start recording. When a movie is recording, a time indicator will display on LCD monitor. To stop recording, press Movie Shutter Button (  ) again.
- Press RECORD/PLAY mode toggle and RETURN Button (  ) to view the recorded movie.
- Five resolution settings are available:

Video Quality	
	HD (1080p) (30fps)
	HD (720p) (30fps)
	WVGA (60fps)
	VGA (30fps)

	QVGA (30fps)
--	--------------

## Picture Recording

- Press the Picture Shutter Button ( ) to take a picture.
- Press RECORD/PLAY mode toggle and RETURN Button( ) to view the picture.
- Three resolution settings are available:

Image Quality	
	<b>High Quality:</b> 12 Mega Pixels
	<b>Standard Quality:</b> 5 Mega Pixels
	<b>Low Quality:</b> 3 Mega Pixels

## Taking Close up Pictures

- Slide the macro switch to change the focus range for different distances of objects
- To take close-up pictures:
  - 1.Slide the macro switch to Macro ( ) for object located at about 20cm (0.67 feet).
  - 2.Press Picture Shutter Button ( ) to take the picture.
- In Macro Mode, the macro icon( ) will appear on the LCD monitor.



### Note

Remember to turn the macro switch back to Normal ( ) when you are not taking close-up pictures.

## Using Digital Light or Light Function

- To use light function:
  1. Press Left Button, the Digital Light icon ( ) will appear on the screen to extend dynamic range for backlight and high contrast sense so that the objects will be brighter and clearer.
  2. Press again, the Light icon( ) will appear on the screen. The light will be turned on and keeps providing light.
  3. Press Movie Shutter Button ( ) to start recording or press the Picture Shutter Button ( ) to take picture.
  4. Press Left Button again to suspend the light.



### Note

The light will be disabled automatically when battery power is low ( ) .



## Using Digital Zoom

- The digital zoom magnifies images, when recording movies or taking pictures.
  - 1.To zoom in/out, press the Tele/Wide Button.
  - 2.The digital zoom can be set from 2x (1080p)/ 1x to 4x(for other video resolution).

## Options for Record Menu

Movie Mode	Picture Mode	Effect
<ul style="list-style-type: none"> <li>• Resolution</li> <li>• Stabilization</li> <li>• Motion Detect</li> </ul>	<ul style="list-style-type: none"> <li>• Resolution</li> <li>• Self-timer</li> </ul>	<ul style="list-style-type: none"> <li>• Scene</li> <li>• WB (White Balance)</li> <li>• ISO</li> </ul>

## Operations for Record Mode

Operation	Display Screen
1. Press OK Button when in Record Mode.	
<p>2. Use Right/Left Buttons to move between main menu options, which are Movie Mode, Picture Mode, and Effect.</p> <p>3. Press Down Button to enter the folder of main option you select.</p> <p>4. Press Right/Left Button to select the setting options, then press OK Button to validate.</p> <p>5. Press RECORD/PLAY mode toggle and RETURN Button(  ) to exit.</p>	

## Movie Mode Submenu Setting

Operation	Display Screen
<ol style="list-style-type: none"> <li>1. In Record Mode, press OK Button to enter record menu screen.</li> <li>2. Use Right/Left Buttons to select Movie Mode.</li> <li>3. The Movie Mode submenu contains 3 options-- Resolution, Stabilization, and Motion Detect--for you to adjust the camera setting.</li> </ol>	

### Movie Resolution

Operation	Display Screen
<ol style="list-style-type: none"> <li>1. In Movie Mode submenu, press Down Button to enter Resolution.</li> <li>2. Use Right/Left Buttons to move between five settings.</li> <li>3. Press OK Button to validate the setting.</li> </ol>	

### Stabilization



Operation	Display Screen
<ol style="list-style-type: none"> <li>1. In Movie Mode submenu, press Up/Down Button to enter Stabilization.</li> <li>2. Use Right/Left Buttons to choose On or Off.</li> <li>3. Press OK Button to validate the setting.</li> </ol>	



#### Note

Stabilization doesn't support HD(1080p) and WVGA(60fps).

## Motion Detection

Operation	Display Screen
<ol style="list-style-type: none"> <li>1. In Movie Mode submenu, press Up/Down Buttons to select Motion Detect.</li> <li>2. Use Right/Left Buttons to choose On or Off.</li> <li>3. Press Menu/OK Button to validate the setting then press RECORD/PLAY mode toggle and RETURN Button (  ) to back to Record mode.</li> <li>4. Camera will start to record video automatically if it detects a movement. Stop recording if it does not detect a movement.</li> </ol>	 <p>The screenshot shows a camera's menu interface with a blue background. At the top, there are four icons: a camera, a camera with a checkmark, a camera with a magnifying glass, and a camera with a vertical line. Below the icons, the menu items are listed: 'Resolution' set to 'HD(720)p', 'Stabilization' set to 'Off', and 'Motion Detect' set to 'Off'. The 'Motion Detect' option is highlighted with a blue bar. At the bottom of the screen, there are two buttons: 'OK OK' and 'Exit'.</p>

## Picture Mode Submenu Setting

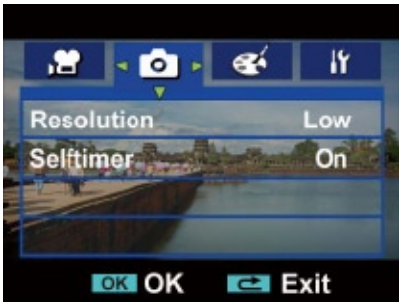
Operation	Display Screen
<ol style="list-style-type: none"> <li>1. In Record Mode, press OK Button to enter record menu screen.</li> <li>2. Use Right/Left Buttons to select Picture Mode.</li> <li>3. The Picture Mode submenu contains 2 options, Resolution, and Self-timer, for you to adjust the camera setting.</li> </ol>	

### Picture Resolution

Operation	Display Screen
<ol style="list-style-type: none"> <li>1. In Picture Mode submenu, press Down Button to enter Resolution.</li> <li>2. Use Right/Left Buttons to move between three settings.</li> <li>3. Press OK Button to validate the setting.</li> </ol>	

### Self-timer

The self-timer allows you to take pictures with a ten-second time delay. The self-timer light on the front of the camera will also blink. The speed of blinking will increase just before the picture is taken.

Operation	Display Screen
<ol style="list-style-type: none"> <li>1. In Picture Mode submenu, press Up/Down Buttons to select Self-timer.</li> <li>2. Use Right/Left Buttons to choose On or Off.</li> <li>3. Press OK Button to validate the setting.</li> </ol>	

## Effect Submenu Setting

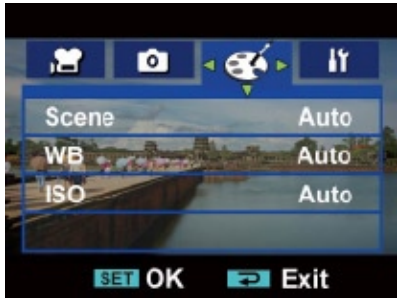
Operation	Display Screen
<ol style="list-style-type: none"> <li>1. In Record Mode, press OK Button to enter record menu screen.</li> <li>2. Use Right/Left Buttons to select Effect.</li> <li>3. The Effect submenu contains 3 options, Scene, WB(White Balance), and ISO for you to adjust the camera setting.</li> </ol>	

### Scene

You can select the mode according to the scene condition.

- **Auto:** Shoot without any special effect on the image.
- **Skin:** Shoot with an effect that makea skin tones more natural
- **Night:** Use Night mode for night scenes or low light conditions.
- **Backlight:** You can take shots when bright light is behind the subject.
- **B/W:** The image is converted to black-and-white.
- **Classic:** The image is converted to sepia look is applied to the image.
- **Negative:** The image is converted as the negative of the normal

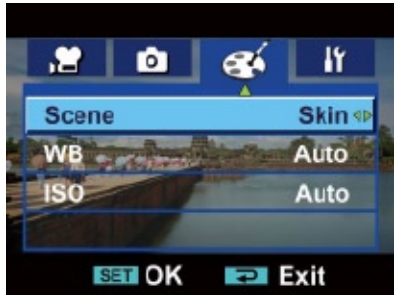
Operation	Display Screen
<ol style="list-style-type: none"> <li>1. In Effect submenu, press Up/Down Button to select Scene.</li> <li>2. Use Right/Left Buttons to move between 7 settings.</li> <li>3. Press OK Button to validate the setting.</li> </ol>	



### Note

To avoid blurry pictures, place the camera on a flat, steady surface, or use a tripod when taking shots in Night mode.



## WB (White Balance)

The camera adjusts the color balance of images automatically. Three manual white balance settings are available:

- **Auto:** The camera automatically adjusts white balance.
- **Daylight:** Under outdoors.
- **Fluorescent:** Under fluorescent light condition.
- **Tungsten:** Under tungsten light condition.

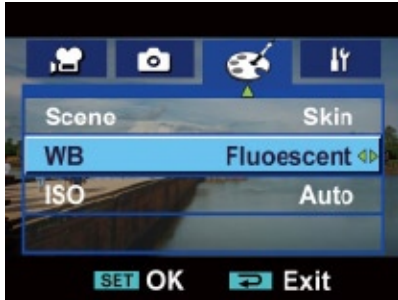
Operation	Display Screen
<ol style="list-style-type: none"> <li>1. In Effect submenu, press Up/Down Button to select WB.</li> <li>2. Use Right/Left Buttons to move between four settings. The change can be previewed immediately.</li> <li>3. Press OK Button to validate the setting.</li> </ol>	

## ISO

The camera adjust the ISO sensitivity of images automatically. Two manual ISO sensitivity settings are available. The larger the number, the higher the sensitivity.

- **Auto:** The camera automatically adjusts ISO sensitivity.
- **ISO 800**
- **ISO 1600**

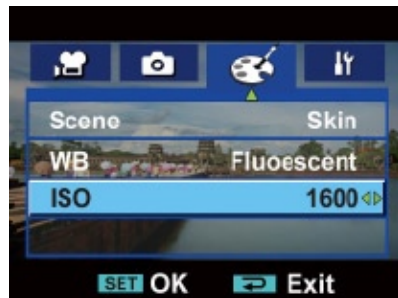

Operation	Display Screen
<ol style="list-style-type: none"> <li>1. In Effect Submenu, press Up/Down buttons to select ISO.</li> <li>2. Use Right/Left Buttons to move between 3 settings.</li> <li>3. Press Menu/OK Button to validate the setting then press RECORD/PLAY mode toggle and RETURN Button (  ) to back to Record mode.</li> </ol>	

## Section 4

# Enjoying the Playback Mode

### Button Function

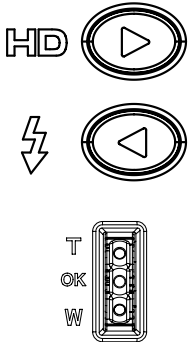
The Buttons have the following functions in Movie and Picture Playback Modes.

	<p><b>Direction Button:</b></p> <p><b>Right Button:</b> Go to the next movie/picture. Fast forward</p> <p><b>Left Button:</b> Go to the previous movie/picture. Fast rewind</p> <p><b>Tele Button(Up Button) :</b> Zoom in/Volume increase.</p> <p><b>Wide Button(Down Button) :</b> Zoom out/Volume reduce</p> <p><b>OK Button:</b> Menu ON/Validate the setting.</p>
	<p><b>RECORD/PLAY mode toggle and RETURN Button functions:</b></p> <ol style="list-style-type: none"> <li>1. Switch between Record and Playback modes.</li> <li>2. Return to the previous page.</li> </ol>
	<p><b>Movie Shutter Button:</b></p> <p>Start playing the recorded movie.</p>

## LCD Monitor Information

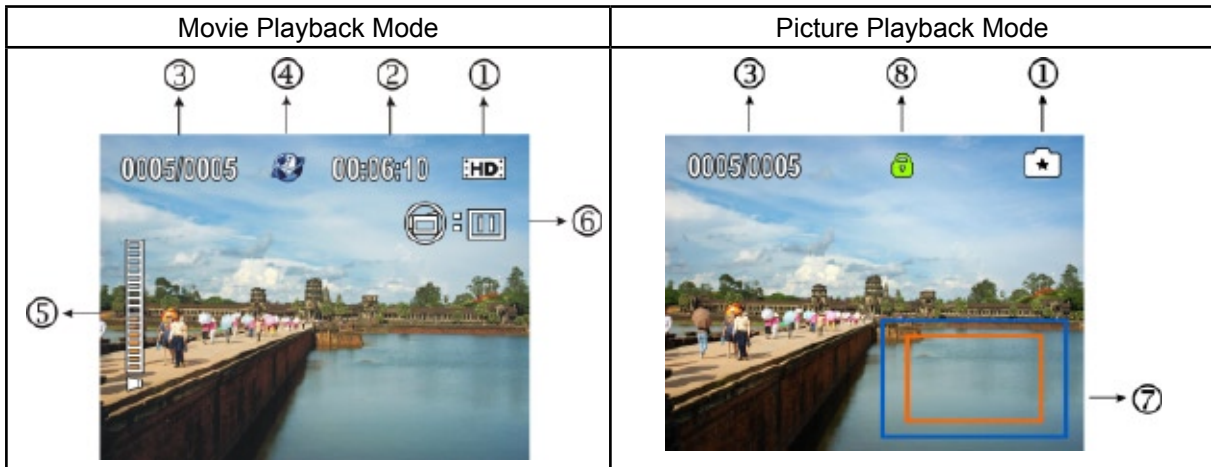

Indicators on the LCD screen while in Playback Mode:





(1)		HD (1080p) (30fps)
		HD (720p) (30fps)
		WVGA (60fps)
		VGA (30fps)
		QVGA (30fps)
		High
		Standard
		Low
(2)	<b>00:06:10</b>	Movie playback time counter
(3)	<b>0005/0005</b>	Current Number/ Total number of movie or picture.
(4)		Movies is selected to upload to YouTube
(5)		Volume
(6)		Indicate the screen is in movie playback mode:Play/Pause
(7)		Magnification Indicator.
(8)		Indicate the selected picture is locked.

## Operations for Playback Mode

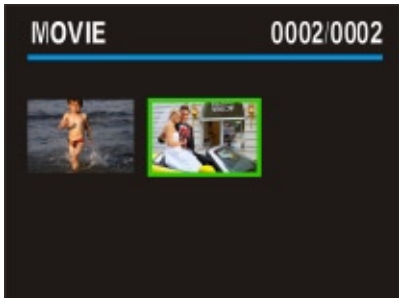
The Playback Mode is for viewing and managing movies and pictures on the built-in memory or on an SD card.

Operation	Display Screen
<ol style="list-style-type: none"> <li>1. Press RECORD/PLAY mode toggle and RETURN Button (  ) to switch from Record Mode to Playback Mode Main Menu. There are 2 options in the Playback Mode, Movie and Picture.</li> <li>2. Press Direction Button to select the specific option.</li> </ol>	
<ol style="list-style-type: none"> <li>3. Press Menu/OK Button to enter Movie/ Picture thumbnail preview folder.</li> <li>4. Use direction buttons to locate the movies/ picture you want to view.</li> <li>5. Press Menu/OK button to view the movies/ picture.</li> </ol>	

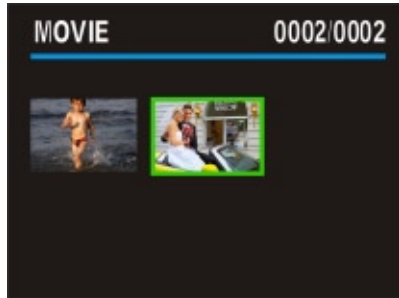



## Movie Playback

Operation	Display Screen
<ol style="list-style-type: none"> <li>1. In movie thumbnail preview folder, use direction buttons to locate the movies you want to view.</li> <li>2. Press Menu/OK button to play the movies.</li> </ol>	
<ol style="list-style-type: none"> <li>3. While playing movie, press Right/Left Buttons to fast forward/rewind, then release the button to stop.</li> <li>4. Use Up/Down Buttons to adjust volume.</li> </ol>	

## Movie Playback Mode Menu

Operation	Display Screen
<ol style="list-style-type: none"> <li>1. In Movie Playback Mode, press Menu/OK Button to enter Movie Playback menu screen.</li> <li>2. Use Up/Down Buttons to select four options, Delete, YouTube Direct, Repeat One, and Repeat All.</li> </ol>	

## Delete Movies

Operation	Display Screen
<ol style="list-style-type: none"> <li>1. Use Up/Down Buttons to select the Delete option.</li> </ol>	
<ol style="list-style-type: none"> <li>2. Press Menu/OK Button to go to the Delete menu.</li> <li>3. Use Right/Left Buttons to select the movie.</li> <li>4. Use Up Button to delete all movies or Down Button to delete single movie. Or Press RECORD/PLAY mode toggle and RETURN Button(  ) to exit.</li> <li>5. Before a movie is deleted, a confirmation screen will appear; choosing "Yes" will execute the operation and "No" will cancel the operation.</li> </ol>	
<ol style="list-style-type: none"> <li>6. Press Menu/OK Button to validate the setting.</li> </ol>	





### Note

- If a memory card is inserted, you can delete only those movies stored on the card.
- Movies on a written-protected memory card cannot be deleted.

## YouTube Direct

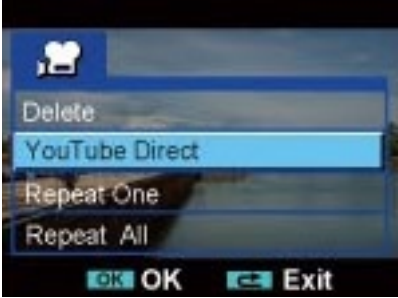
(For more detailed operational instructions, please refer to Section 9.)



Operation	Display Screen
<ol style="list-style-type: none"> <li>1. Use Up/Down Buttons to select the YouTube Direct option.</li> <li>2. Press Menu/OK Button to go to the YouTube Direct menu.</li> </ol>	
<ol style="list-style-type: none"> <li>3. Use Right/Left Buttons to select the movie.</li> <li>4. Use Up Button to select all movies or Down Button to select single movie.</li> <li>5. Press RECORD/PLAY mode toggle and RETURN Button(  ) to exit.</li> </ol>	

## Repeat Movies

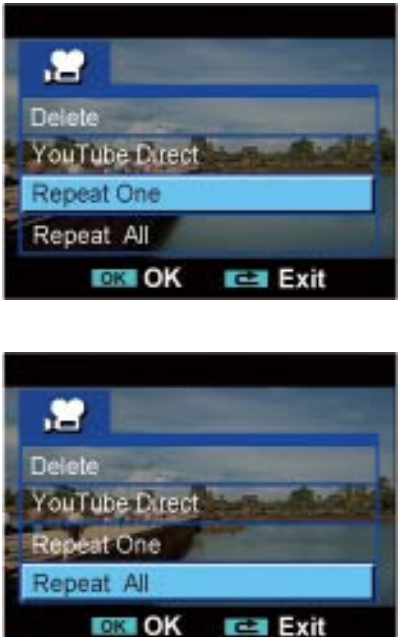
This function automatically repeats playing single movie or all movies in order.

Operation	Display Screen
<ol style="list-style-type: none"> <li>1. Use Up/Down Buttons to select the Repeat One option or Repeat All option.</li> <li>2. Press Menu/OK Button to start repeating, press it again to stop and return to the previous page.</li> </ol>	

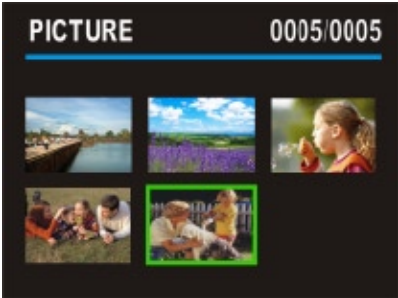

## Picture Playback

Operation	Display Screen
<ol style="list-style-type: none"> <li>In Picture thumbnail preview folder, use Direction Buttons to locate the picture you want to view.</li> <li>Press OK Button to view the picture.</li> </ol>	
<ol style="list-style-type: none"> <li>Use Right/Left Buttons to go to the next or last picture.</li> <li>While the picture is selected, use Tele Button to magnify.</li> <li>To navigate the magnified picture, press OK Button to enter navigation mode (The inner Magnification Indicator turns orange). Use Direction Buttons to navigate the magnified picture. Press OK Button again to exit navigation mode.</li> </ol>	

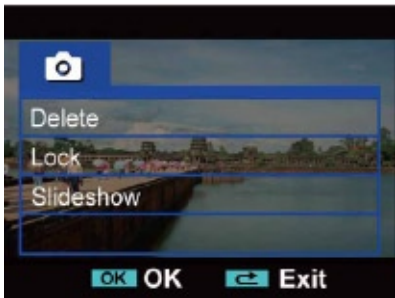
## Picture Playback Mode Menu

Operation	Display Screen
<ol style="list-style-type: none"> <li>1. In Picture Playback Mode, press OK Button to enter Picture Playback menu screen.</li> <li>2. Use Up/Down Buttons to select three options, Delete, Lock, and Slideshow.</li> </ol>	

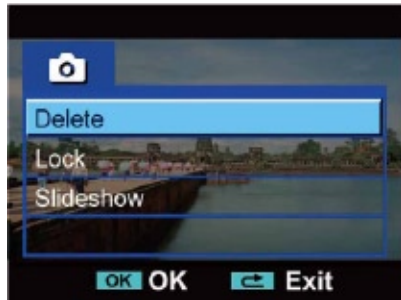
### Delete Picture

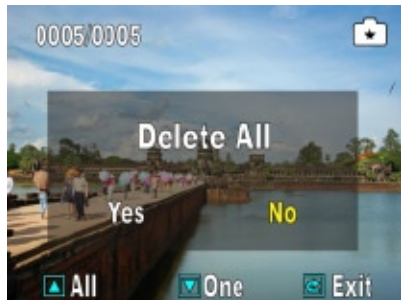
Operation	Display Screen
<ol style="list-style-type: none"> <li>1. Use Down Buttons to select the Delete option.</li> </ol>	
<ol style="list-style-type: none"> <li>2. Press OK Button to go to the Delete menu.</li> <li>3. Use Right/Left Buttons to select the picture.</li> <li>4. Use Up Button to delete all pictures or Down Button to delete single picture. Or Press RECORD/PLAY mode toggle and RETURN Button(  ) to exit.</li> <li>5. Before a picture is deleted, a confirmation screen will appear; choosing "Yes" will execute the operation, "No" will cancel the operation.</li> <li>6. Press OK Button to validate the setting.</li> </ol>	 





#### Note

- If a memory card is inserted, you can delete only those pictures stored on the card.
- Pictures on a written-protected memory card cannot be deleted.
- The delete function will only erase unlocked pictures. Locked pictures must be unlocked before being deleted.

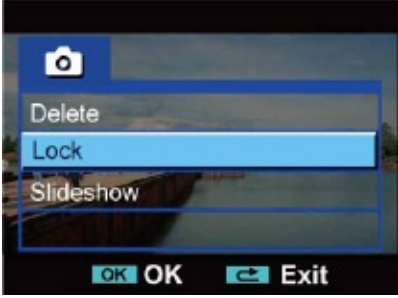

## Lock Pictures

Single or all pictures can be locked. This function can prevent the pictures from being deleted accidentally.

Operation	Display Screen
1. Use Up/Down Buttons to select the Lock option.	 <p>A screenshot of a camera's menu interface. At the top left is a camera icon. Below it are three options: 'Delete', 'Lock', and 'Slideshow'. The 'Lock' option is highlighted with a blue bar. At the bottom, there are two 'OK' buttons and an 'Exit' button with a back arrow icon.</p>
2. Press OK Button to go to the Lock menu. 3. Use Right/Left Buttons to select the picture. 4. Use Up Button to lock/unlock all pictures or Down Button to lock/unlock single picture. 5. Press RECORD/PLAY mode toggle and RETURN Button (  ) to exit.	 <p>A screenshot of the camera's lock menu. At the top left, it shows '0005/0005' and a green lock icon. At the top right is a camera icon. The main area shows a landscape photo of a bridge over water. At the bottom, there are three options: 'All' (with an up arrow), 'One' (with a down arrow), and 'Exit' (with a back arrow).</p>

## Make Slide Show

This function automatically repeats all pictures in order.

Operation	Display Screen
1. Use Up/Down Buttons to select the Slideshow option. 2. Press OK Button to start the slide show; press it again to stop and return to the previous page.	 <p>A screenshot of a camera's menu interface, similar to the first screenshot. At the top left is a camera icon. Below it are three options: 'Delete', 'Lock', and 'Slideshow'. The 'Slideshow' option is highlighted with a blue bar. At the bottom, there are two 'OK' buttons and an 'Exit' button with a back arrow icon.</p>

## Section 5 Setting Your Camera

### Setting Menu

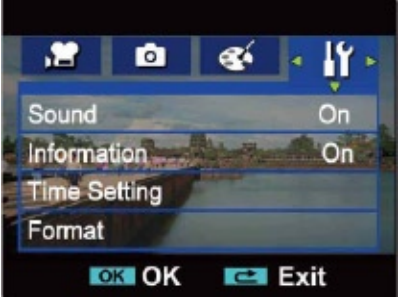
Operation	Display Screen
<ol style="list-style-type: none"> <li>1. In Record Mode, press OK Button to enter record menu screen.</li> <li>2. Use Right/Left Buttons to select Setting.</li> <li>3. The Setting submenu contains 7 options for configuring your camera set up. They are Sound (operation sound), Information, Time Setting, Format, TV, Language, and Default Setting.</li> </ol>	

### Sound

Enable or disable KeyPad tone and operation sound.

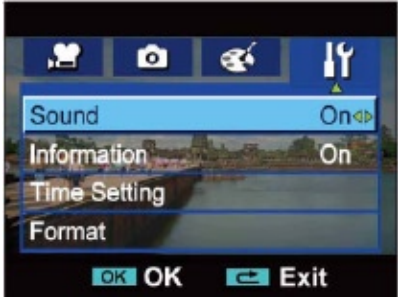
Operation	Display Screen
<ol style="list-style-type: none"> <li>1. In setting submenu, press Down Button to enter Sound.</li> <li>2. Use Right/Left Buttons to choose On or Off.</li> <li>3. Press OK Button to validate the setting.</li> </ol>	

### Information



To change Information setting by either hot key (Up Button) or Option Setting:

On: Show the indicator(s) on the LCD screen.

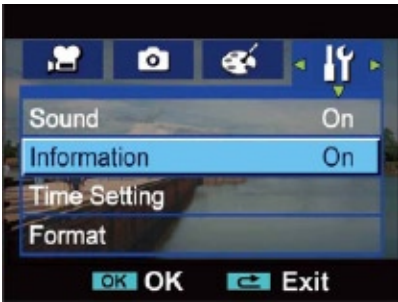
Off: Do not show the indicator(s) on the LCD screen.

Operation	Display Screen
<ol style="list-style-type: none"> <li>1. In setting submenu, press Up/Down Button to enter Information.</li> <li>2. Use Right/Left Buttons to choose On or Off.</li> <li>3. Press OK Button to validate the setting.</li> </ol>	

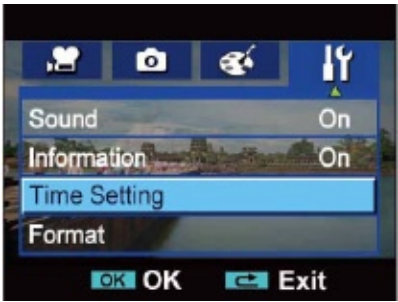
## Time Setting

Operation	Display Screen
<ol style="list-style-type: none"> <li>1. In setting submenu, press Up/Down Button to select Time Setting.</li> <li>2. Press OK Button to go to the Time Setting menu.</li> </ol>	
<ol style="list-style-type: none"> <li>3. Move between Year, Month, Day, Hour and Minute by using Right/Left Buttons. Adjust the numeric value by using Up/Down Buttons.</li> <li>4. Press OK Button to validate the setting. Or Press RECORD/PLAY mode toggle and RETURN Button (↩) to leave Time Setting without any change.</li> </ol>	

## Format

**Yes:** Format the built-in memory ( When there is no SD Card in the camera ) / SD Card (When there is an SD Card in the camera).

**No:** Do not format the built-in memory ( When there is no SD Card in the camera ) / SD Card (When there is an SD Card in the camera).

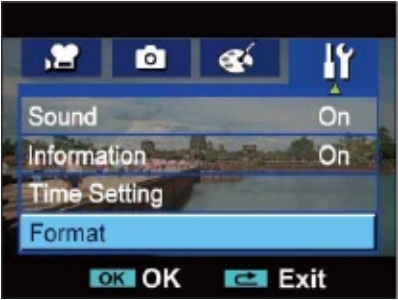
Operation	Display Screen
<ol style="list-style-type: none"> <li>1. In setting submenu, press Up/Down Button to select Format.</li> <li>2. Press OK Button to go to the Format confirmation screen.</li> </ol>	
<ol style="list-style-type: none"> <li>3. Use Right/Left Buttons to choose Yes or No.</li> <li>4. Confirmation screen will appear; choosing "Yes" will execute the operation, "No" will cancel the operation.</li> <li>5. Press OK Button to validate the setting.</li> </ol>	



### Note

All video and picture files will be erased if the SD card is formatted. Make sure all desired video and picture files are backed-up to PC before formatting SD card.

## TV

Ensure that the appropriate TV standard of your area is selected – either NTSC or PAL.

Wrong TV system setting may cause image flicker.

**NTSC standard:** USA, Canada, Japan, South Korea and Taiwan etc.

**PAL standard:** UK, Europe, China, Australia, Singapore and Hong Kong etc.

Operation	Display Screen
<ol style="list-style-type: none"><li>1. In setting submenu, press Up/Down Button to enter TV.</li><li>2. Use Right/Left Buttons to choose NTSC(60Hz) or PAL(50Hz).</li><li>3. Press OK Button to validate the setting.</li></ol>	 A screenshot of a television's settings menu. At the top, there are four icons: a person, a camera, a globe, and a wrench. Below these icons, the menu is divided into sections. The first section is 'TV', which is currently set to 'NTSC(60Hz)'. Below this, there are two more sections: 'Language' set to 'English' and 'Default Setting'. At the bottom of the screen, there are three buttons: 'OK', 'OK', and 'Exit'.



## Language

Use this option to select the language of user interface which you want.

Operation	Display Screen
<ol style="list-style-type: none"><li>1. In setting submenu, press Up/Down Button to enter Language.</li><li>2. Use Right/Left Buttons to choose the language options.</li><li>3. Press OK Button to validate the setting.</li></ol>	 A screenshot of a television's settings menu, similar to the one above. The 'TV' section is still set to 'NTSC(60Hz)'. However, the 'Language' section is now highlighted, and it is set to 'English'. The 'Default Setting' section is still visible below it. The bottom buttons 'OK', 'OK', and 'Exit' are also present.

## Default Setting

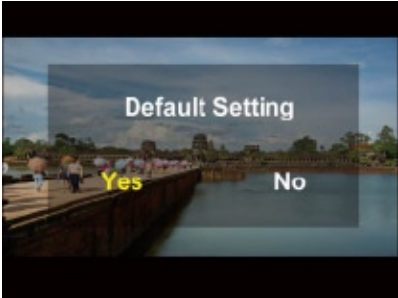
To restore the default factory setting, select this option.

Operation	Display Screen
<ol style="list-style-type: none"> <li>In setting submenu, press Down Button to select Default Setting.</li> <li>Press OK Button to go to the Default Setting confirmation screen.</li> </ol>	
<ol style="list-style-type: none"> <li>Use Right/Left Buttons to choose Yes or No.</li> <li>Choosing "Yes" will execute the operation, "No" will cancel the operation.</li> <li>Press OK Button to validate the setting.</li> </ol>	

The following table indicates the camera's default setting

Setting	Default Factory Setting
<b>Resolution</b>	HD (1080p) for Movie Standard for Picture
<b>Stabilization</b>	Off
<b>Motion Detect</b>	Off
<b>Self-timer</b>	Off
<b>Scene</b>	Auto
<b>ISO</b>	Auto
<b>WB (White Balance)</b>	Auto
<b>Sound</b>	On
<b>Information</b>	On
<b>TV</b>	Depends on shipping area
<b>Language</b>	Depends on shipping area
<b>Volume</b>	Level 12

## Section 6

# Viewing Pictures and Movies on a TV

### Connecting to a High-Definition 16:9(Wide) TV

1. Connect one end of the HDMI cable to your camera's HDMI Out port.
2. Connect the other end of the cable to a television.
3. Set video input source of a TV to "HDMI" option.
4. The steps for viewing stored pictures and movie on a TV are exactly the same as for viewing them on the LCD monitor.

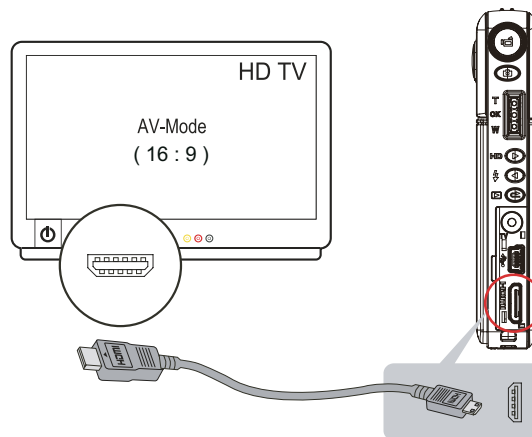

#### Note

The camera can not run movie recording and picture taking when it is connected to an HDTV. The LCD Panel does not display when the camera is connected to an HDTV.

### Connecting to a Non-High-Definition 4:3 TV

1. Connect one end of the AV cable to your camera's AV Out port.
2. Connect the other end of the cable to a television.
3. The steps for viewing stored pictures and movie on a TV are exactly the same as for viewing them on the LCD monitor.

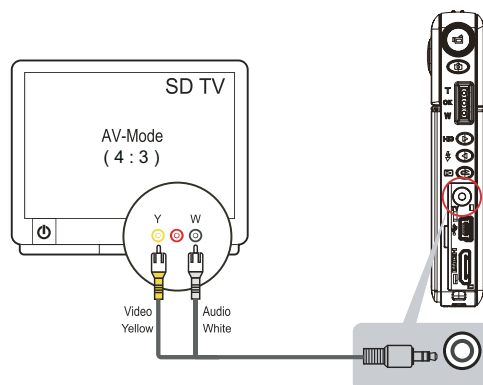

#### Note

The LCD Panel does not display when the camera is connected to a TV.

## Section 7

# Viewing Pictures and Movies on PC

### Installing Bundled Software

The CD-ROM supplied with this camera contains 2 pieces of software.

- **ArcSoft MediaImpression** is a user-friendly application that helps you managing your media, burning your video into DVD, and uploading your videos to YouTube easily.
- **Adobe Reader** is a popular program that you need to have installed to read the User's Manual. Many computer users will find they already have this software installed on their computer.

To install the bundled software:

1. Insert the CD-ROM into your computer's CD-ROM drive. The autorun screen appears.
2. Click **Install Application Software**. Follow the on-screen instructions to complete the installation.



#### **Note**

*The detailed information can be found in online help of all the bundled software.*

### Transferring Video and Pictures to a Computer

You can transfer pictures or movies stored on your camera to a computer and send them in emails to friends or post them on websites.

To do this you should:

1. Connect the computer and camera with the supplied mini USB 2.0 cable. The LED will light up and blink.
2. After the LED stops blinking, movies and pictures can be found on your computer at "My Computer\Removable Disk\DCIM\100HPDVC"
3. Under this folder, you can view, delete, move, or copy any movie/picture you want.
4. Use the bundled ArcSoft application software to edit the movies or pictures.

## Section 8

# Burning the Recorded Clip into DVD

Bundled software CD contains ArcSoft MediaImpression features burning the movie clip into DVD. You can share this DVD movie with family and friends by using regular DVD player.

To create a DVD:

1. Install ArcSoft MediaImpression (Refer to Section 7)
2. Click Windows [ Start ] → [ (All) Programs ] → [ ArcSoft MediaImpression ]
3. ArcSoft MediaImpression main Screen will appear on your desktop.
4. Click [ Make Movie ] .

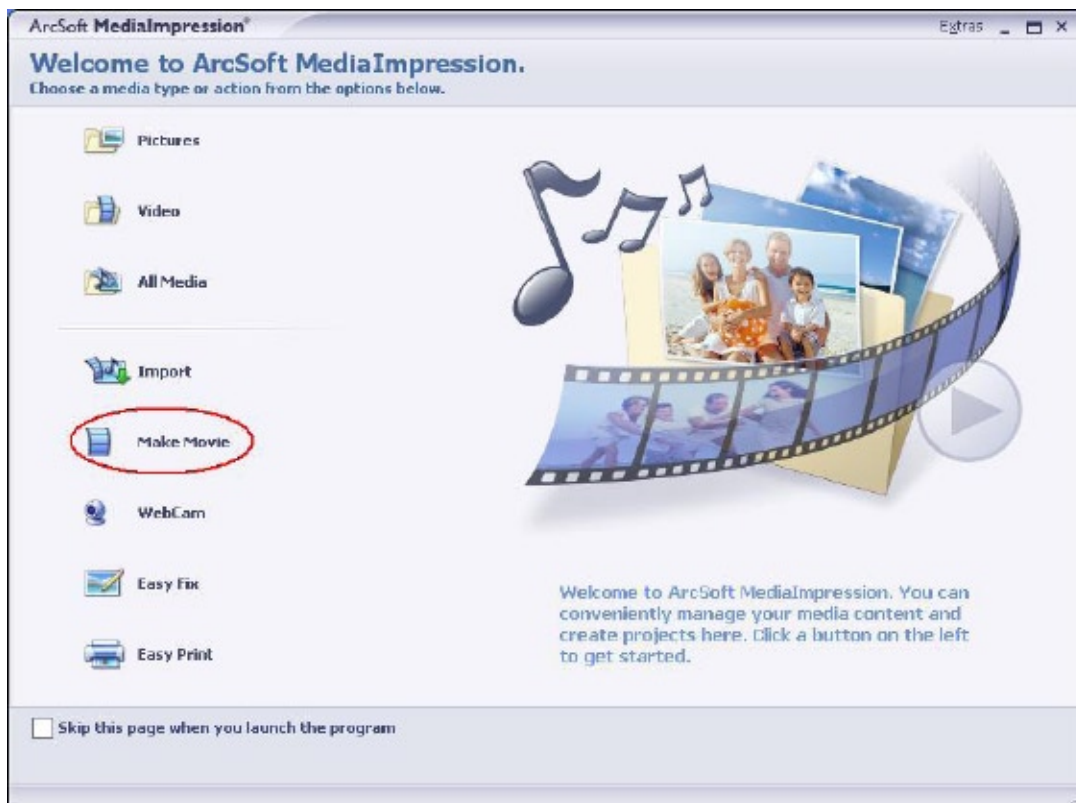



5. The operation screen will appear:

- Select the folder that contains the video files you want to burn.
- Select the files
- Click button to add the files into slide
- Click [Burn to Disc]

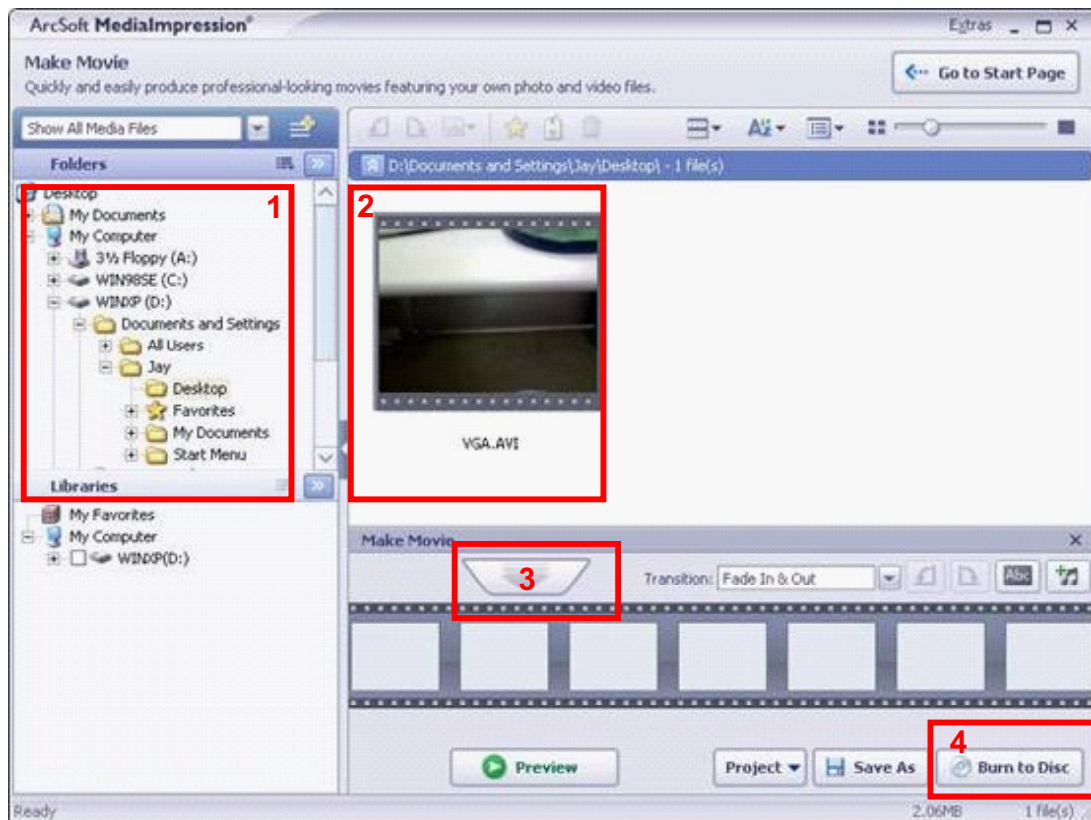

6. Click [ Start ] to start DVD burning.



## Section 9

# Uploading Video Files to YouTube

The built-in **YouTube Direct** application offers you an easy way to upload your video clips to YouTube instantly. It helps you share them with your family and friends on YouTube website.

To upload video files to YouTube:

1. Select the video clips in Movie Playback Mode.
2. Connect the camera and computer with the supplied USB cable.

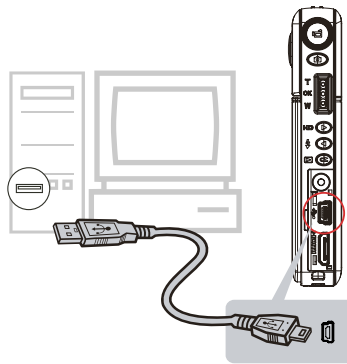

3. After making a USB connection, the auto-run screen will appear. Click [YouTube Direct]→ [OK] as the main screen appears automatically on the desktop.



### Note

If the auto-run screen does not appear. Click [My Computer]→[DV(X:)]→[dvap.exe] to execute the application.

- Preview the video: double click on the video clip in thumbnail screen. Click Play/Pause icon to play/pause. Click Return icon to back to thumbnail preview screen.



#### 5. Upload video clip

- Upload single video clip or selected video clips: In thumbnail screen, click up/down icon to change the pages. Click on the video clip you want to upload (+ Ctrl Button to select two or more video clips), and then click [Upload selected videos to youtube] icon.

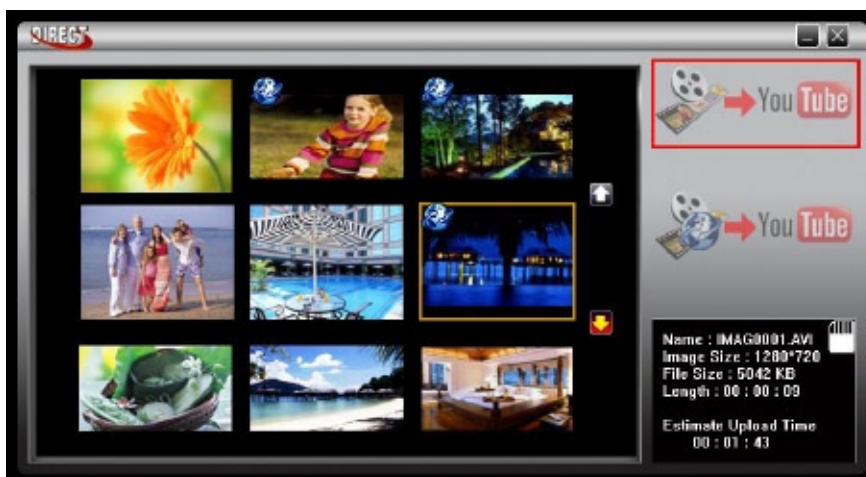

- Upload the video clips which are selected in the camera earlier: Click [Upload DV-selected videos to youtube] icon.

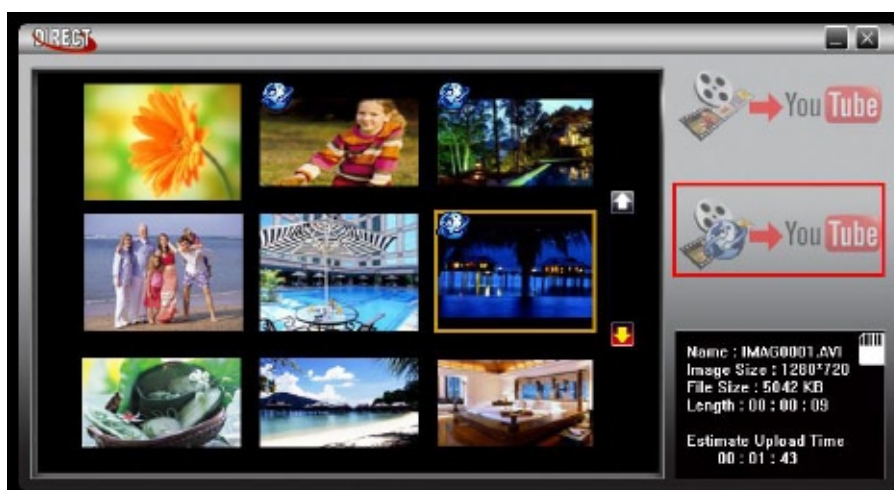

6. Fill in the information in the blanks.

The screenshot shows the 'YouTube Link' application window. It is divided into three main sections: 'User Info', 'Upload Info', and 'File Info'. The 'User Info' section contains fields for 'User Name' (test1) and 'Password' (\*\*\*\*\*), with 'SignUp' and 'Save User Info.' buttons to the right. The 'Upload Info' section shows 'Total-Upload: 1/1', a dropdown menu with 'IMAG0004.AVI', and a thumbnail image of a flower. The 'File Info' section includes fields for 'Title' (IMAG0004.AVI), 'Description' (20090123 21:06:01), 'tags' (MyDV), 'Video Category' (Autos & Vehicles), and 'Broadcast Option' (Public selected). At the bottom, there is an 'Upload Videos...' button, an 'Exit' button, and a note: 'click "Upload Videos..." to start upload file'.

7. If you do not have a YouTube account, click [SignUp] to register a new YouTube account firstly. Then, the YouTube sign-up screen will appear. Please follow the instruction on YouTube website. If you want to save the user's name and password, click [Save User Info].

This screenshot is identical to the previous one, but with a red rectangular box highlighting the 'SignUp' and 'Save User Info.' buttons in the 'User Info' section.

8. Click [Upload Videos] to upload the video(s).

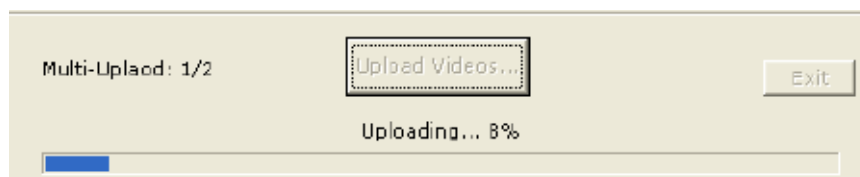
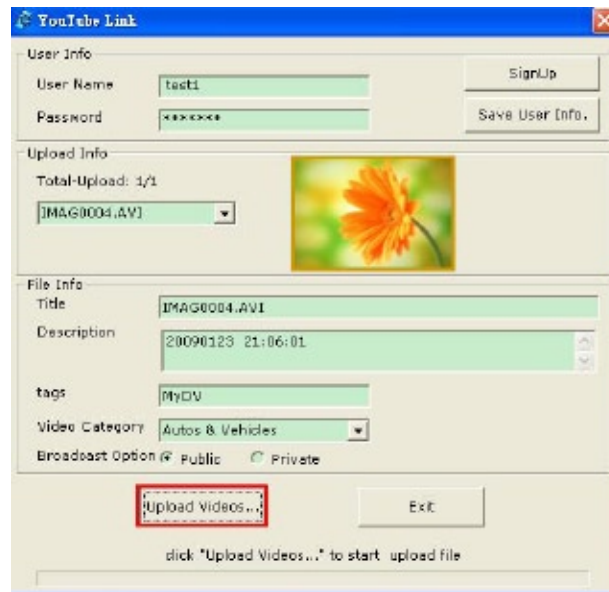

## Section 10

# Specifications and System Requirement

<b>Specifications</b>	
Image Sensor	5 Mega Pixel CMOS Sensor
Operation Modes	Movie Record, Picture Record
Lens	F3.2 (f = 7.2mm)
Focus Range	200cm (6.7 feet)~infinite (Normal Mode) Center: 20 cm (0.67 feet) (Macro Mode)
Digital Zoom	1080p:2X Other video resolution:4X
Shutter	Electronic
LCD monitor	2.5"LCD
Storage Media	Built-in 128MB Memory (partial memory is used for Firmware code,and around 73 MB is useable for videos and pictures); SD/SDHC Card Slot support
Image Resolution	High 4000x3000 (12M Pixels) Std 2592x1944 (5M Pixels) Low 2048x1536 (3M Pixels)
Movie Resolution	HD(1080p) 1440X1080(30fps) HD(720p) 1280X720(30fps) WVGA 848X480(60fps) VGA 640X480(30fps) QVGA 320X240(30fps)
Light	Digital light On/Light On/Off
White Balance	Auto/Manual (Daylight, Fluorescent, Tungsten)
ISO	Auto/800/1600
Self timer	10 second delay
File Format	Picture: JPG Movie: AVI
Image play	Single Image/Slideshow
PC Interface	Mini USB 2.0 Port
TV out	NTSC/PAL Selectable, HDMI
Battery	Lithium-ion Rechargeable Battery
Dimension	100(H) * 57(W) * 17.9(T) mm
Weight	87g (without battery)

## System Requirement

Windows 2000/XP/Vista, Windows 7

Pentium III 800 MHz above

512 MB RAM

CD ROM

300MB free HDD space

Available USB port

16-bit Color Display



### **Note**

*The LCD screen is manufactured using extremely high-precision technology so over 99.99% of the pixels are operational for effective use. However, some tiny black and/or bright dots (white, red, blue or green) may appear on the LCD screen. These dots are a normal result of the manufacturing process, and do not affect the recording.*

# Section 11

## Troubleshooting

### Troubleshooting

#### 1.If the LCD image is not clear when shooting, how can the focus be adjusted?

Try to switch between Macro and Normal Mode. Macro Mode: For object in distance about 20 cm (0.67 feet) , Normal Mode: For object in distance beyond 200cm (6.7 feet).

#### 2.The files on the memory card do not display smoothly when the LCD shows the “!” marking.

The “!” means the SD card is low speed or has wrong content inside. The way to solve this condition is to format SD card by camera instead of PC.(Please read the detail Format instruction in Section 5).You may use a higher speed SD/SDHC card.

Rating	Speed (MB/s)	SD Class
6x	0.9	n/a
10x	1.5	n/a
13x	2.0	2
26x	4.0	4
32x	4.8	4
40x	6.0	6
66x	10.0	6
100x	15.0	6
133x	20.0	6
150x	22.5	6
200x	30.0	6
266x	40.0	6
300x	45.0	6

#### 3.Why do some of my indoor pictures look blurry and dark?

Camera extends pictures exposure time under low light/ indoor condition. Keep camera (and photographed subject) steady for several seconds when taking pictures. Shutter will sound when picture has been taken.

#### 4.How do I charge battery?

You must use the supplied AC charger or USB cable.

Camera must be turned OFF; blinking light confirms charging, but light is constant when charging has been completed.



## Section 12 Getting Help

Should your HP Branded Product require service within the Warranty period, please contact the original point of purchase or an authorized HP reseller in your country. If service is not available at those locations, please contact an HP Branded Product warranty agent from the support contact list provided on this document. Supported languages are: English, French, German, Italian, Portuguese and Spanish. A warranty agent will work with you to troubleshoot your issue and if necessary, issue a Return Material Authorization (RMA) number in order to replace your HP Branded Product. For warranty claims, you will be required to provide a copy of your original dated sales receipt as proof of purchase and the issued RMA number. End User customer shall be responsible for shipping charges when shipping the product to the service center. The service agent will provide you with an address and you will also be responsible for any shipping charges to the warranty service center. Once your product is received by this service center, a replacement unit will be shipped back to you within 5 business days.

Email Support:	
Language	Email Address
English	english@hpodd.com
Français	francais@hpodd.com
Italiano	italiano@hpodd.com
Espanol	espanol@hpodd.com
Portuguese	portugues@hpodd.com
Dutch	hollands@hpodd.com
Deutsch	deutsch@hpodd.com
Svensk	svensk@hpodd.com
Chinese	trad.chinese@hpodd.com
	simp.chinese@hpodd.com

Contact/Phone Support:		
Country	Language	Number
België	Dutch and German	+ 32 2700 1724
Français	French	+ 33 171230454
Deutschland	German	+ 49 6950073896
Ireland	English	+ 353 1850882016
Italia	Italian	+ 39 269682189
Netherlands	Dutch	+ 31 202015093
Espana	Spanish	+ 34 914533458
Switzerland	German/French/Italian	+ 41 18009686
UK	English	+ 44 2073652400
North America		
United States	English	+ 1-866-694-7633
Canada	English & French	+ 1-866-694-7633

