

# Notebook PC User Guide

© Copyright 2010 Hewlett-Packard  
Development Company, L.P.

Bluetooth is a trademark owned by its proprietor and used by Hewlett-Packard Company under license. Microsoft and Windows are U.S. registered trademarks of Microsoft Corporation. SD Logo is a trademark of its proprietor.

The information contained herein is subject to change without notice. The only warranties for HP products and services are set forth in the express warranty statements accompanying such products and services. Nothing herein should be construed as constituting an additional warranty. HP shall not be liable for technical or editorial errors or omissions contained herein.

First Edition: March 2010

Document Part Number: 597890-001

#### **Product notice**

This user guide describes features that are common to most models. Some features may not be available on your computer.

## Safety warning notice

- 
- ⚠ **WARNING!** To reduce the possibility of heat-related injuries or of overheating the computer, do not place the computer directly on your lap or obstruct the computer air vents. Use the computer only on a hard, flat surface. Do not allow another hard surface, such as an adjoining optional printer, or a soft surface, such as pillows or rugs or clothing, to block airflow. Also, do not allow the AC adapter to contact the skin or a soft surface, such as pillows or rugs or clothing, during operation. The computer and the AC adapter comply with the user-accessible surface temperature limits defined by the International Standard for Safety of Information Technology Equipment (IEC 60950).
-



---

# Table of contents

## 1 Features

Identifying hardware .....	1
Components .....	2
Top components .....	2
TouchPad .....	2
Lights .....	3
Button and speakers .....	4
Keys .....	5
Right-side components .....	6
Left-side components .....	7
Bottom components .....	8
Display components .....	9
Wireless antennas .....	9
Additional hardware components .....	11
Labels .....	12

## 2 Wireless, local area network, and modem

Using wireless devices .....	13
Identifying wireless and network status icons .....	14
Using the wireless controls .....	14
Using the wireless action key .....	14
Using HP Wireless Assistant .....	15
Using operating system controls .....	15
Using a WLAN .....	16
Setting up a WLAN .....	16
Protecting your WLAN .....	17
Connecting to a WLAN .....	18
Roaming to another network .....	18
Using Bluetooth wireless devices (select models only) .....	19
Bluetooth and Internet Connection Sharing (ICS) .....	19
Troubleshooting wireless connection problems .....	20
Cannot connect to a WLAN .....	20
Cannot connect to a preferred network .....	21
Network icon is not displayed .....	21

Current network security codes are unavailable .....	21
WLAN connection is very weak .....	22
Cannot connect to the wireless router .....	22
Using the modem (select models only) .....	23
Connecting a modem cable .....	23
Connecting a country-specific modem cable adapter .....	24
Selecting a location setting .....	24
Viewing the current location selection .....	24
Adding new locations when traveling .....	25
Solving travel connection problems .....	26
Connecting to a local area network .....	27

### 3 Pointing devices and keyboard

Turning the TouchPad on and off .....	29
Using the TouchPad .....	29
Using TouchPad gestures .....	29
Scrolling .....	29
Pinching .....	30
Rotating .....	30
Setting pointing device preferences .....	31
Using the keyboard .....	32
Using keypads .....	34
Using an optional external numeric keypad .....	34
Cleaning the TouchPad and keyboard .....	35

### 4 Multimedia

Multimedia features .....	36
Identifying your multimedia components .....	37
Adjusting the volume .....	38
Using the media activity functions .....	39
Using the media activity action keys .....	39
Multimedia software .....	40
Using CyberLink PowerDVD software .....	40
Using other preinstalled multimedia software .....	40
Installing multimedia software from a disc .....	40
Audio .....	41
Connecting external audio devices .....	42
Checking your audio functions .....	42
Video .....	42
Connecting an HDMI device (select models only) .....	43
Configuring audio for HDMI (select models only) .....	44
Optical drive .....	45
Webcam (select models only) .....	46

Webcam tips .....	46
Adjusting webcam properties .....	46
Troubleshooting .....	48
The optical disc tray does not open for removal of a CD, DVD, or BD .....	48
A disc does not play automatically .....	48
A DVD movie stops, skips, or plays erratically .....	49
A DVD movie is not visible on an external display .....	49
The process of burning a disc does not begin, or it stops before completion .....	49
A DVD playing in Windows Media Player produces no sound or display .....	50
A device driver must be reinstalled .....	50
Obtaining the latest HP device drivers .....	50
Obtaining the latest Windows device drivers .....	51

## 5 Power management

Setting power options .....	52
Using power-saving states .....	52
Initiating and exiting Sleep .....	53
Initiating and exiting Hibernation .....	53
Using the battery meter .....	54
Using power plans .....	54
Viewing the current power plan .....	54
Selecting a different power plan .....	54
Customizing power plans .....	54
Setting password protection on wakeup .....	55
Using external AC power .....	56
Connecting the AC adapter .....	57
Testing an AC adapter .....	58
Using battery power .....	59
Finding battery information in Help and Support .....	59
Using Battery Check .....	59
Displaying the remaining battery charge .....	60
Inserting or removing the battery .....	60
Charging a battery .....	61
Maximizing battery discharge time .....	62
Managing low battery levels .....	62
Identifying low battery levels .....	62
Resolving a low battery level .....	63
Resolving a low battery level when external power is available .....	63
Resolving a low battery level when a charged battery is available .....	63
Resolving a low battery level when no power source is available .....	63
Resolving a low battery level when the computer cannot exit Hibernation .....	63

Calibrating a battery .....	63
Step 1: Fully charge the battery .....	63
Step 2: Disable Hibernation and Sleep .....	64
Step 3: Discharge the battery .....	65
Step 4: Fully recharge the battery .....	65
Step 5: Reenable Hibernation and Sleep .....	66
Conserving battery power .....	66
Storing a battery .....	66
Disposing of a used battery .....	67
Replacing the battery .....	67
Shutting down the computer .....	68

## 6 Drives

Handling drives .....	69
Optical drive .....	70
Identifying the installed optical drive .....	70
Using optical discs .....	71
Selecting the right disc (CDs, DVDs, and BDs) .....	72
CD-R discs .....	72
CD-RW discs .....	72
DVD±R discs .....	72
DVD±RW discs .....	72
LightScribe DVD+R discs .....	73
Blu-ray Disc (BD) .....	73
Playing a CD, DVD, or BD .....	73
Configuring AutoPlay .....	75
Changing DVD region settings .....	75
Observing the copyright warning .....	76
Copying a CD, DVD, or BD .....	76
Creating (burning) a CD or DVD .....	77
Removing a CD, DVD, or BD .....	78
Using external drives .....	78
Improving hard drive performance .....	80
Using Disk Defragmenter .....	80
Using Disk Cleanup .....	80
Replacing the hard drive .....	81

## 7 External devices and external media cards

Using a USB device .....	85
Connecting a USB device .....	85
Removing a USB device .....	86
Using Digital Media Slot cards .....	87
Inserting a digital card .....	87



Removing a digital card .....	88
-------------------------------	----

## 8 Adding or replacing a memory module

## 9 Security

Protecting the computer .....	92
Using passwords .....	93
Setting passwords in Windows .....	93
Setting passwords in Setup Utility .....	93
Administrator password .....	94
Managing an administrator password .....	94
Entering an administrator password .....	94
Power-on password .....	95
Managing a power-on password .....	95
Entering a power-on password .....	95
Using antivirus software .....	96
Using firewall software .....	96
Installing critical security updates .....	97
Installing an optional security cable .....	97

## Appendix A Setup Utility (BIOS)

Starting Setup Utility .....	98
Using Setup Utility .....	99
Changing the language of Setup Utility .....	99
Navigating and selecting in Setup Utility .....	99
Displaying system information .....	100
Restoring default settings in Setup Utility .....	100
Exiting Setup Utility .....	101
Setup Utility menus .....	101
Main menu .....	101
Security menu .....	101
System Configuration menu .....	102
Diagnostics menu .....	102

## Appendix B Software updates

Updating the BIOS .....	104
Determining the BIOS version .....	104
Downloading a BIOS update .....	105
Updating programs and drivers .....	106

## Appendix C Backup and recovery

Creating recovery disc .....	108
Backing up your information .....	109

Using Windows Backup and Restore .....	110
Using system restore points .....	111
When to create restore points .....	111
Create a system restore point .....	111
Restore to a previous date and time .....	111
Performing a recovery .....	112
Recovering using the recovery discs .....	112
Recovering using the dedicated recovery partition (select models only) .....	112
<b>Index .....</b>	<b>113</b>

---

# 1 Features

## Identifying hardware

To see a list of hardware installed in the computer:

- ▲ Select **Start > Control Panel > System and Security**. Then in the **System** area, click **Device Manager**.

You can also add hardware or modify device configurations using Device Manager.

 **NOTE:** Windows® includes the User Account Control feature to improve the security of your computer. You may be prompted for your permission or password for tasks such as installing software, running utilities, or changing Windows settings. Refer to Help and Support for more information.

# Components

## Top components

### TouchPad

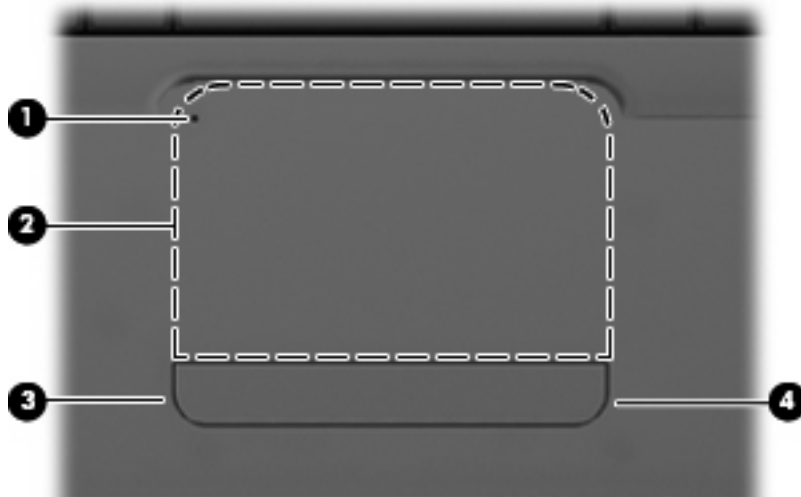

Component	Description
(1) TouchPad off indicator	<ul style="list-style-type: none"><li>• When the TouchPad zone is active, the light is off.</li><li>• When the TouchPad zone is inactive, the light is amber.</li><li>• To switch between active and inactive, quickly double-tap the TouchPad off indicator.</li></ul>
(2) TouchPad zone	Moves the pointer and selects or activates items on the screen.
(3) Left TouchPad control	Use the left side of the TouchPad control button like the left button on an external mouse.
(4) Right TouchPad control	Use the right side of the TouchPad control button like the right button on an external mouse.

There is an unmarked scroll zone inside the right edge of the TouchPad. To scroll up and down using the TouchPad vertical scroll zone, slide your finger up or down along the right edge of the TouchPad.

For more information about TouchPad features, refer to [Using the TouchPad on page 29](#).

## Lights

 **NOTE:** Your computer may look slightly different from the illustration in this section.

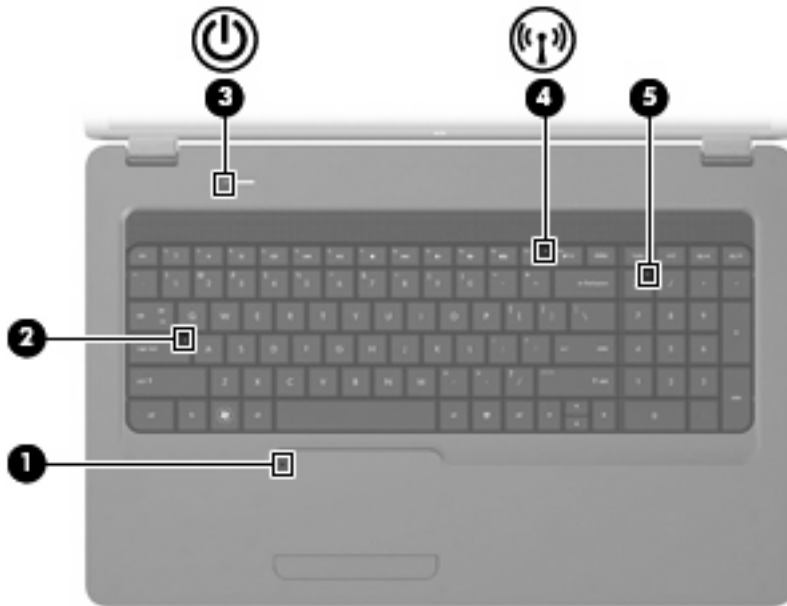

Component	Description
(1) TouchPad off indicator	<ul style="list-style-type: none"><li>Off: TouchPad is enabled.</li><li>Amber: TouchPad is disabled.</li></ul> <p>To switch the Touchpad on and off, quickly double-tap the Touchpad off indicator.</p>
(2) Caps lock light	On: Caps lock is on.
(3) Power light	<ul style="list-style-type: none"><li>On: The computer is on.</li><li>Blinking: The computer is in the Sleep state.</li><li>Off: The computer is off or in Hibernation.</li></ul>
(4) Wireless light	<ul style="list-style-type: none"><li>White: An integrated wireless device, such as a wireless local area network (WLAN) device and/or a Bluetooth® device, is on.</li><li>Amber: All wireless devices are off.</li></ul>
(5) num lk light	On: The numeric function of the keypad is enabled. Off: The navigation function of the keypad is enabled.

## Button and speakers

 **NOTE:** Your computer may look slightly different from the illustration in this section.

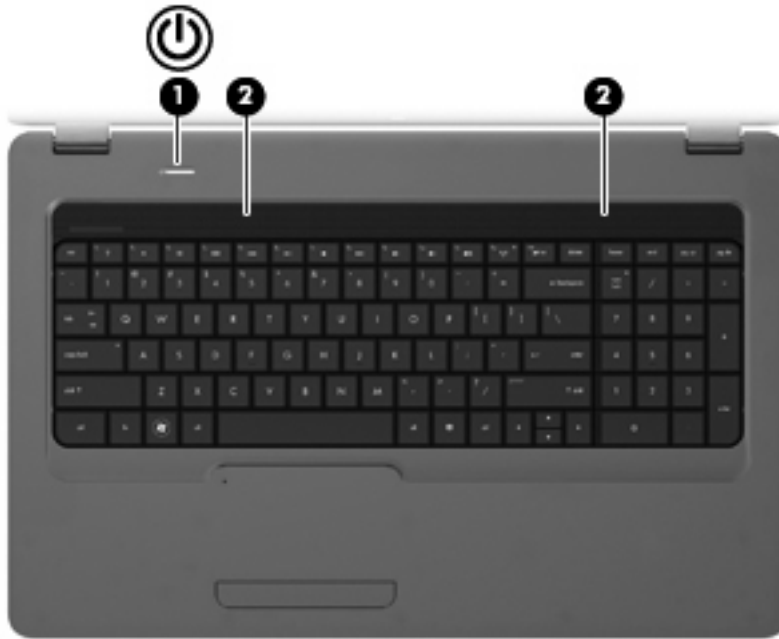

Component	Description
<b>(1)</b> Power button	<ul style="list-style-type: none"><li>• When the computer is off, press the button to turn on the computer.</li><li>• When the computer is on, press the button briefly to initiate Sleep.</li><li>• When the computer is in the Sleep state, press the button briefly to exit Sleep.</li><li>• When the computer is in Hibernation, press the button briefly to exit Hibernation.</li></ul> <p>If the computer has stopped responding and Windows shutdown procedures are ineffective, press and hold the power button for at least 5 seconds to turn off the computer.</p> <p>To learn more about your power settings, select <b>Start &gt; Control Panel &gt; System and Security &gt; Power Options</b>.</p>
<b>(2)</b> Speakers (2)	Produce sound.

## Keys

 **NOTE:** Your computer may look slightly different from the illustration in this section.

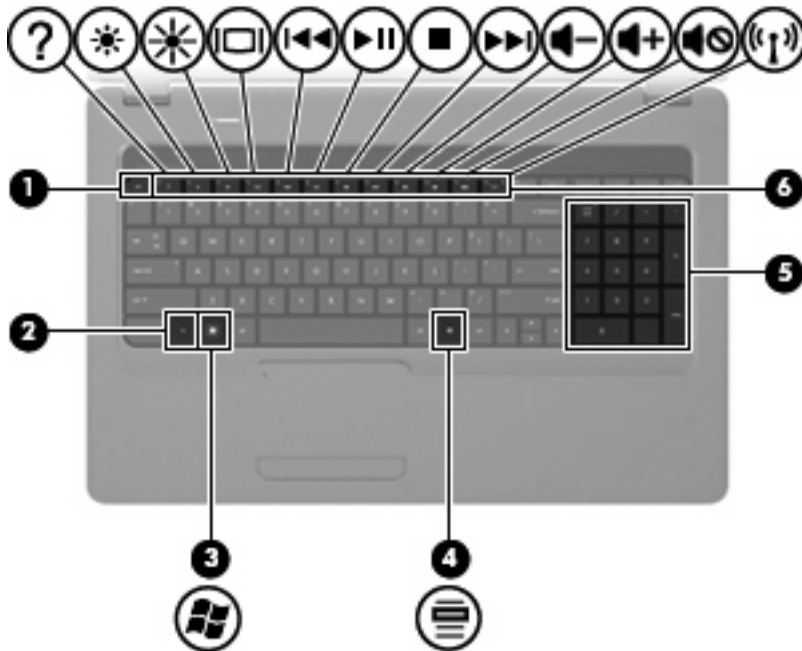

Component	Description
(1) <code>esc</code> key	Displays system information when pressed in combination with the <code>fn</code> key.
(2) <code>fn</code> key	Displays system information when pressed in combination with the <code>esc</code> key.
(3) Windows logo key	Displays the Windows Start menu.
(4) Windows applications key	Displays a shortcut menu for items beneath the pointer.
(5) Integrated numeric keypad keys	Can be used like the keys on an external numeric keypad.
(6) Action keys	Execute frequently used system actions.

Refer to [Using the keyboard on page 32](#) for information about using action keys.

## Right-side components

 **NOTE:** Your computer may look slightly different from the illustration in this section.

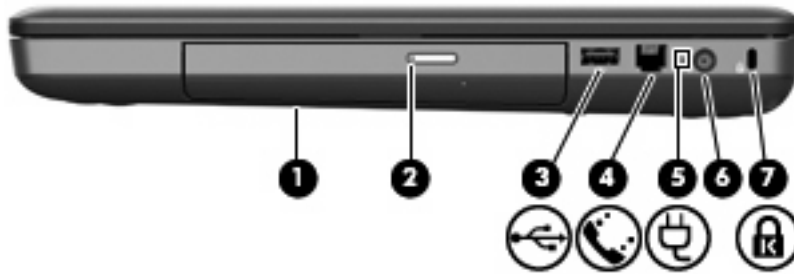

Component	Description
(1) Optical drive	Reads optical discs and, on select models, also writes to optical discs.
(2) Optical drive light on release button	Blinking: The optical drive is being accessed.
(3) USB port	Connects an optional USB device.
(4) RJ-11 (modem) jack (select models only)	Connects a modem cable (purchased separately).
(5) AC adapter light	<ul style="list-style-type: none"><li>Blinking white: The computer is in the Sleep state.</li><li>On white: The computer is connected to external power.</li><li>Amber: The battery is charging.</li><li>Off: The computer is not connected to external power.</li></ul>
(6) Power connector	Connects an AC adapter.
(7) Security cable slot	Attaches an optional security cable to the computer. <b>NOTE:</b> The security cable is designed to act as a deterrent, but it may not prevent the computer from being mishandled or stolen.



## Left-side components

 **NOTE:** Your computer may look slightly different from the illustration in this section.

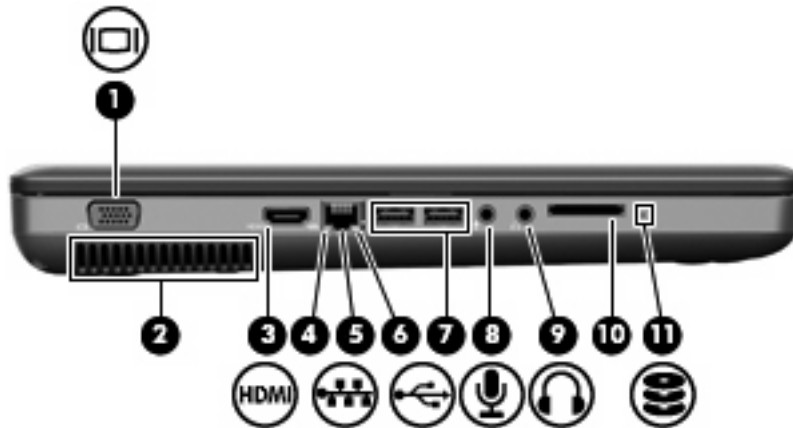

Component	Description
(1) External monitor port	Connects an external VGA monitor or projector.
(2) Vent	Enables airflow to cool internal components.  <b>NOTE:</b> The computer fan starts up automatically to cool internal components and prevent overheating. It is normal for the internal fan to cycle on and off during routine operation.
(3) HDMI port (select models only)	Connects an optional video or audio device, such as a high-definition television, or any compatible digital or audio component.
(4) Network connection light	White: The computer is connected to the network.
(5) RJ-45 (network) jack	Connects a network cable.
(6) Network activity light	Amber: Data is being transmitted over the network.
(7) USB ports (2)	Connect optional USB devices.
(8) Audio-in (microphone) jack	Connects an optional computer headset microphone, stereo array microphone, or monaural microphone.
(9) Audio-out (headphone) jack	Produces sound when connected to optional powered stereo speakers, headphones, earbuds, a headset, or television audio.
(10) Digital Media Slot (select models only)	Supports the following optional digital card formats: <ul style="list-style-type: none"> <li>• Memory Stick (MS)</li> <li>• Memory Stick Pro (MSP)</li> <li>• MultiMediaCard (MMC)</li> <li>• Secure Digital (SD) Memory Card</li> <li>• xD-Picture Card (XD)</li> </ul>
(11) Drive light	On: The hard drive is in use.

## Bottom components

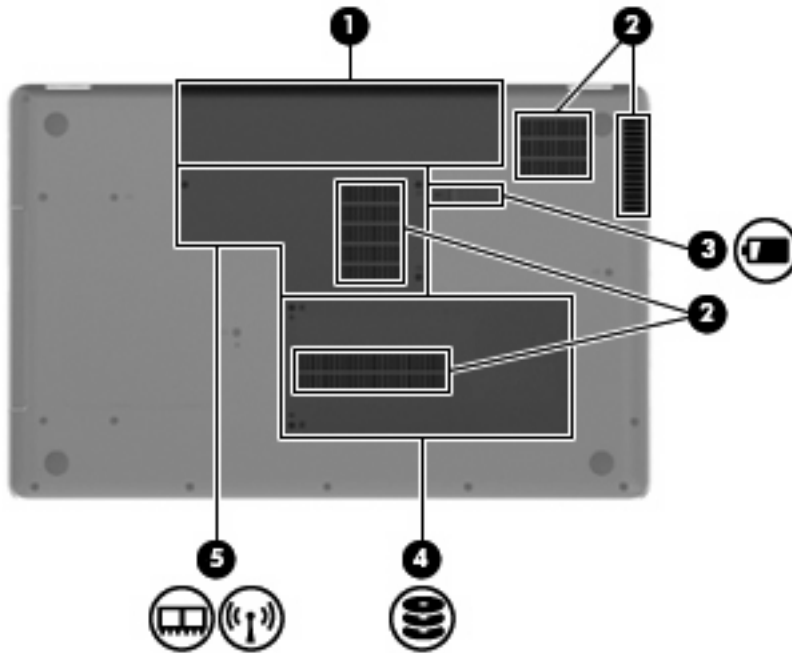

Component	Description
(1) Battery bay	Holds the battery.
(2) Vents (4)	Enable airflow to cool internal components. <b>NOTE:</b> The computer fan starts up automatically to cool internal components and prevent overheating. It is normal for the internal fan to cycle on and off during routine operation.
(3) Battery release latch	Releases the battery from the battery bay.
(4) Hard drive bay	Holds the hard drive.
(5) Memory bay	Holds two memory modules and the wireless local area network (WLAN) module. <b>CAUTION:</b> To prevent an unresponsive system, replace the wireless module only with a wireless module authorized for use in the computer by the governmental agency that regulates wireless devices in your country or region. If you replace the module and then receive a warning message, remove the module to restore computer functionality, and then contact technical support through Help and Support.

## Display components



Component	Description
(1) Internal microphone	Records sound.
(2) Webcam (select models only)	Records video and captures still photographs.
(3) Webcam light (select models only)	On: The webcam is in use.

## Wireless antennas

Your computer model has two antennas that send and receive signals from one or more wireless devices. These antennas are not visible from the outside of the computer.



---

 **NOTE:** For optimal transmission, keep the areas immediately around the antennas free from obstructions.

---

To see wireless regulatory notices, refer to the section of the *Regulatory, Safety and Environmental Notices* that applies to your country or region. These notices are located in Help and Support.

## Additional hardware components



Component	Description
(1) Power cord*	Connects an AC adapter to an AC outlet.
(2) AC adapter	Converts AC power to DC power.
(3) Battery	Powers the computer when the computer is not plugged into external power.

\*Power cords vary in appearance by country or region.

# Labels

The labels affixed to the computer provide information you may need when you troubleshoot system problems or travel internationally with the computer.

- Integrated regulatory, wireless certification, and service tag label—Provides regulatory information about the computer, wireless certification information, and the computer model number, serial number, and warranty information. This label is affixed inside the battery bay.

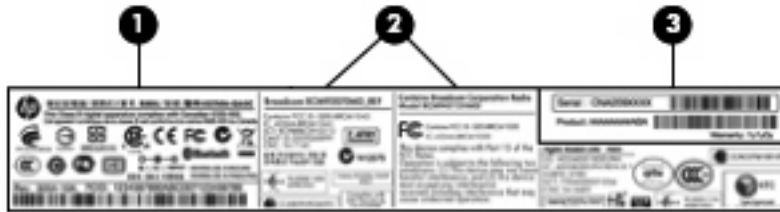

---

## Component

---

(1)	Regulatory information	Provides regulatory information about the computer.
(2)	Wireless certification information	Provides information about optional wireless devices and the approval markings of some of the countries or regions in which the devices have been approved for use. An optional device may be a wireless local area network (WLAN) device or an optional Bluetooth® device. If your computer model includes one or more wireless devices, the certification information is included with your computer. You may need this information when traveling internationally.
(3)	Service tag*	Provides the serial number for this product, as well as the product number and warranty information.

---

\*Have this information available when you contact technical support:

- The serial number is an alphanumeric identifier unique to this product.
  - The product number provides specific information about the product's hardware components, which helps a service technician to determine what components and parts are needed.
  - The warranty number describes the duration of the warranty period for this product.
- 
- Microsoft® Certificate of Authenticity—Contains the Windows Product Key. You may need the Product Key to update or troubleshoot the operating system. This certificate is affixed to the bottom of the computer.
  - Modem approval label (select models only)—Provides regulatory information about the modem and lists the agency approval markings required by some of the countries or regions in which the modem has been approved for use. You may need this information when traveling internationally. The modem approval label is affixed inside the hard drive bay.

---

## 2 Wireless, local area network, and modem

### Using wireless devices

Wireless technology transfers data across radio waves instead of wires. Your computer may be equipped with one or more of the following wireless devices:

- Wireless local area network (WLAN) device—Connects the computer to wireless local area networks (commonly referred to as Wi-Fi networks, wireless LANs, or WLANs) in corporate offices, your home, and public places such as airports, restaurants, coffee shops, hotels, and universities. In a WLAN, each mobile wireless device communicates with a wireless router or a wireless access point.
- Bluetooth® device (select models only)—Creates a personal area network (PAN) to connect to other Bluetooth-enabled devices such as computers, phones, printers, headsets, speakers, and cameras. In a PAN, each device communicates directly with other devices, and devices must be relatively close together, typically within **10 meters** (approximately 33 feet) of each other.

Computers with WLAN devices support one or more of the following IEEE industry standards:

- 802.11b, the first popular standard, supports data rates of up to 11 Mbps and operates at a frequency of 2.4 GHz.
- 802.11g supports data rates of up to 54 Mbps and operates at a frequency of 2.4 GHz. An 802.11g WLAN device is backward compatible with 802.11b devices, so they can operate on the same network.
- 802.11a supports data rates of up to 54 Mbps and operates at a frequency of 5 GHz.

---







 **NOTE:** 802.11a is not compatible with 802.11b and 802.11g.

---

- 802.11n supports data rates of up to 450 Mbps and may operate at 2.4 GHz or 5 GHz, making it backward compatible with 802.11a, b, and g.

For more information on wireless technology, refer to the information and Web site links provided in Help and Support.

## Identifying wireless and network status icons

Icon	Name	Description
	Wireless (connected)	Identifies the location of the wireless light and the wireless action key (f12) on the computer. Also identifies the HP Wireless Assistant software on the computer and indicates that one or more of the wireless devices are on.
	Wireless (disconnected)	Identifies the HP Wireless Assistant software on the computer and indicates that all of the wireless devices are off.
	Wired network (connected)	Indicates that one or more network drivers are installed, and one or more network devices are connected to a wired network.
	Wired network (disabled/disconnected)	Indicates that one or more network drivers are installed, but no network devices are connected (or all network devices are disabled in Windows Control Panel).
	Network (connected)	Indicates that one or more network drivers are installed, and one or more network devices are connected to a wireless network.
	Network (disconnected)	Indicates that one or more network drivers are installed and wireless connections are available, but no network devices are connected to a wireless network.
	Network (disabled/disconnected)	Indicates that one or more network drivers are installed, but no wireless connections are available (or all wireless network devices are turned off by the wireless action key [f12] or HP Wireless Assistant).

## Using the wireless controls

You can control the wireless devices in your computer using these features:

- The wireless action key (f12)
- HP Wireless Assistant software
- Operating system controls

## Using the wireless action key

The computer has a wireless action key (f12), one or more wireless devices, and a wireless light. All of the wireless devices on your computer are enabled at the factory, so the wireless light is on (white) when you turn on the computer.

The wireless light indicates the overall power state of your wireless devices, not the status of individual devices. If the wireless light is white, at least one wireless device is on. If the wireless light is amber, all wireless devices are off.

Because the wireless devices are enabled at the factory, you can use the wireless action key (f12) to turn on or turn off all of the wireless devices simultaneously. Individual wireless devices can be controlled through HP Wireless Assistant.



## Using HP Wireless Assistant

A wireless device can be turned on or off using HP Wireless Assistant. If a wireless device is disabled in Setup Utility, it must be reenabled in Setup Utility before it can be turned on or off using Wireless Assistant.

 **NOTE:** Enabling or turning on a wireless device does not automatically connect the computer to a network or a Bluetooth-enabled device.

To view the state of the wireless devices, click the **Show hidden icons** icon, the arrow at the left of the notification area, and then position the mouse pointer over the wireless icon.

If the wireless icon is not displayed in the notification area, complete the following steps to change Wireless Assistant properties:

1. Select **Start > Control Panel > Hardware and Sound > Windows Mobility Center**.
2. Click the wireless icon in the Wireless Assistant tile, which is located in the bottom row of Windows Mobility Center. Wireless Assistant opens.
3. Click **Properties**.
4. Select the check box next to **HP Wireless Assistant icon in notification area**.
5. Click **Apply**.
6. Click **Close**.

For more information, refer to the Wireless Assistant software Help:

1. Open Wireless Assistant by clicking the wireless icon in Windows Mobility Center.
2. Click the **Help** button.

## Using operating system controls

Some operating systems also offer a way to manage integrated wireless devices and the wireless connection. For example, Windows provides the Network and Sharing Center that allows you to set up a connection or network, connect to a network, manage wireless networks, and diagnose and repair network problems.

To access the Network and Sharing Center, select **Start > Control Panel > Network and Internet > Network and Sharing Center**.

For more information, select **Start > Help and Support**.

## Using a WLAN

With a WLAN device, you can access a wireless local area network (WLAN), which is composed of other computers and accessories that are linked by a wireless router or a wireless access point.

 **NOTE:** The terms *wireless router* and *wireless access point* are often used interchangeably.

- A large-scale WLAN, such as a corporate or public WLAN, typically uses wireless access points that can accommodate a large number of computers and accessories and can separate critical network functions.
- A home or small office WLAN typically uses a wireless router, which allows several wireless and wired computers to share an Internet connection, a printer, and files without requiring additional pieces of hardware or software.

To use the WLAN device in your computer, you must connect to a WLAN infrastructure (provided through a service provider or a public or corporate network).

## Setting up a WLAN

To set up a WLAN and connect to the Internet, you need the following equipment:

- A broadband modem (either DSL or cable) **(1)** and high-speed Internet service purchased from an Internet service provider (ISP)
- A wireless router (purchased separately) **(2)**
- The wireless computer **(3)**

The illustration below shows an example of a wireless network installation that is connected to the Internet.

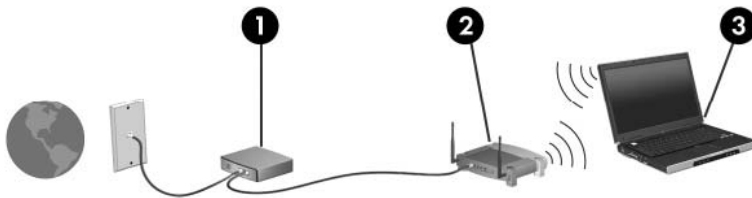

As your network grows, additional wireless and wired computers can be connected to the network to access the Internet.

For help in setting up your WLAN, refer to the information provided by your router manufacturer or your ISP.

## Protecting your WLAN

Because the WLAN standard was designed with only limited security capabilities—basically to foil casual eavesdropping rather than more powerful forms of attack—it is essential to understand that WLANs are vulnerable to well-known and well-documented security weaknesses.

WLANs in public areas, or “hotspots,” like coffee shops and airports may not provide any security. New technologies are being developed by wireless manufacturers and hotspot service providers that make the public environment more secure and anonymous. If you are concerned about the security of your computer in a hotspot, limit your network activities to noncritical e-mail and basic Internet surfing.

When you set up a WLAN or access an existing WLAN, always enable security features to protect your network from unauthorized access. The common security levels are Wi-Fi Protected Access (WPA)-Personal and Wired Equivalent Privacy (WEP). Because wireless radio signals travel outside the network, other WLAN devices can pick up unprotected signals and either connect to your network (uninvited) or capture information being sent across it. However, you can take precautions to protect your WLAN:

- **Use a wireless transmitter with built-in security**

Many wireless base stations, gateways, or routers provide built-in security features such as wireless security protocols and firewalls. With the correct wireless transmitter, you can protect your network from the most common wireless security risks.

- **Work behind a firewall**

A firewall is a barrier that checks both data and requests for data that are sent to your network, and discards any suspicious items. Firewalls are available in many varieties, both software and hardware. Some networks use a combination of both types.

- **Use wireless encryption**

A variety of sophisticated encryption protocols are available for your WLAN:

- **Wired Equivalent Privacy (WEP)** is a wireless security protocol that encodes or encrypts all network data before it is transmitted using a WEP key. Usually, you can allow the network to assign the WEP key. Alternatively, you can set up your own key, generate a different key, or choose other advanced options. Without the correct key, others will not be able to use the WLAN.
- **WPA (Wi-Fi Protected Access)**, like WEP, uses security settings to encrypt and decrypt data that is transmitted over the network. However, instead of using one static security key for encryptions as WEP does, WPA uses “temporal key integrity protocol” (TKIP) to dynamically generate a new key for every packet. It also generates different sets of keys for each computer on the network.

## Connecting to a WLAN

To connect to the WLAN, follow these steps:

1. Be sure that the WLAN device is on. If it is on, the wireless light is white. If the wireless light is amber, press the wireless action key (f12).
2. Click the network icon in the notification area, at the far right of the taskbar.
3. Select your WLAN from the list.
4. Click **Connect**.

If the network is a security-enabled WLAN, you are prompted to enter a network security key, which is a security code. Enter the code, and then click **OK** to complete the connection.

---

 **NOTE:** If no WLANs are listed, you are out of range of a wireless router or access point.

**NOTE:** If you do not see the network you want to connect to, click **Open Network and Sharing Center**, and then click **Set up a new connection or network**. A list of options is displayed. You can choose to manually search for and connect to a network or to create a new network connection.

After the connection is made, place the mouse pointer over the network icon in the notification area, at the far right of the taskbar, to verify the name and status of the connection.

---

 **NOTE:** The functional range (how far your wireless signals travel) depends on WLAN implementation, router manufacturer, and interference from other electronic devices or structural barriers such as walls and floors.

More information about using a WLAN is available through the following resources:

- Information from your ISP and the user guides included with your wireless router and other WLAN equipment
- Information and Web site links provided in Help and Support

For a list of public WLANs near you, contact your ISP or search the web. Web sites that list public WLANs include Cisco Internet Mobile Office Wireless Locations, Hotspotlist, and Geektools. Check with each public WLAN location for cost and connection requirements.

## Roaming to another network

When you move your computer within range of another WLAN, Windows attempts to connect to that network. If the attempt is successful, your computer is automatically connected to the new network. If Windows does not recognize the new network, follow the same procedure you used initially to connect to your WLAN.

## Using Bluetooth wireless devices (select models only)

A Bluetooth device provides short-range wireless communications that replace the physical cable connections that traditionally link electronic devices such as the following:

- Computers (desktop, notebook, PDA)
- Phones (cellular, cordless, smart phone)
- Imaging devices (printer, camera)
- Audio devices (headset, speakers)

Bluetooth devices provide peer-to-peer capability that allows you to set up a personal area network (PAN) of Bluetooth devices. For information on configuring and using Bluetooth devices, refer to the Bluetooth software Help.

## Bluetooth and Internet Connection Sharing (ICS)

HP does **not** recommend setting up one computer with Bluetooth as a host and using it as a gateway through which other computers may connect to the Internet. When two or more computers are connected using Bluetooth, and Internet Connection Sharing (ICS) is enabled on one of the computers, the other computers may not be able to connect to the Internet using the Bluetooth network.

The strength of Bluetooth is in synchronizing information transfers between your computer and wireless devices including cellular phones, printers, cameras, and PDAs. The inability to consistently connect two or more computers to share the Internet through Bluetooth is a limitation of Bluetooth and the Windows operating system.

# Troubleshooting wireless connection problems

Some possible causes for wireless connection problems include the following:

- The network configuration (SSID or security) has been changed.
- The wireless device is not installed correctly or has been disabled.
- The wireless device or router hardware has failed.
- The wireless device encountered interference from other devices.

---

 **NOTE:** Wireless networking devices are included with select computer models only. If wireless networking is not listed in the feature list on the side of the original computer package, you may add wireless networking capability to the computer by purchasing a wireless networking device.

---

Before working your way through the sequence of possible solutions to your network connection problem, be sure that device drivers are installed for all wireless devices.

Use the procedures in this chapter to diagnose and repair a computer that does not connect to the network you want to use.

## Cannot connect to a WLAN

If you have a problem connecting to a WLAN, confirm that the integrated WLAN device is properly installed on your computer:

---

 **NOTE:** Windows includes the User Account Control feature to improve the security of your computer. You may be prompted for your permission or password for tasks such as installing software, running utilities, or changing Windows settings. Refer to Help and Support for more information.

---

1. Select **Start > Control Panel > System and Security**.
2. In the **System** area, click **Device Manager**.
3. Click the arrow next to **Network adapters** to expand the list and show all adapters.
4. Identify the WLAN device from the Network adapters list. The listing for a WLAN device may include the term *wireless*, *wireless LAN*, *WLAN*, *Wi-Fi*, or *802.11*.

If no WLAN device is listed, either your computer does not have an integrated WLAN device, or the driver for the WLAN device is not properly installed.

For more information on troubleshooting WLANs, refer to the Web site links provided in Help and Support.

## Cannot connect to a preferred network

Windows can automatically repair a corrupted WLAN connection:

- If there is a network icon in the notification area, at the far right of the taskbar, right-click the icon, and then click **Troubleshoot problems**.

Windows resets your network device and attempts to reconnect to one of the preferred networks.

- If there is no network icon in the notification area, follow these steps:
  1. Select **Start > Control Panel > Network and Internet > Network and Sharing Center**.
  2. Click **Troubleshoot problems**, and then select the network you wish to repair.

## Network icon is not displayed

If the network icon is not displayed in the notification area after you configure the WLAN, the software driver is either missing or corrupted. A Windows “Device not Found” error message may also be displayed. The driver must be reinstalled.

If the WLAN device you are using was purchased separately, consult the manufacturer's Web site for the latest software.

To get the latest version of the WLAN device software for your computer, follow these steps:

1. Open your web browser, and then go to <http://www.hp.com/support>.
2. Select your country or region.
3. Click the option for software and driver downloads, and then enter your computer model number in the search box.
4. Press **enter**, and then follow the on-screen instructions.

---

 **NOTE:** If the WLAN device you are using was purchased separately, consult the manufacturer's Web site for the latest software.

---

## Current network security codes are unavailable

If you are prompted for a network key or a name (SSID) when connecting to a WLAN, the network is protected by security. You must have the current codes to make a connection on a secure network. The SSID and network key are alphanumeric codes that you enter into your computer to identify your computer to the network.

- For a network connected to your personal wireless router, review the router user guide for instructions on setting up the same codes on both the router and the WLAN device.
- For a private network, such as a network in an office or at a public Internet chat room, contact the network administrator to obtain the codes, and then enter the codes when prompted to do so.

Some networks change the SSID or network keys used in their routers or access points on a regular basis to improve security. You must change the corresponding code in your computer accordingly.

If you are provided with new wireless network keys and SSID for a network, and if you have previously connected to that network, follow the steps below to connect to the network:

1. Select **Start > Control Panel > Network and Internet > Network and Sharing Center**.

2. In the left panel, click **Manage wireless networks**.

A list showing the available WLANs is displayed. If you are in a hotspot where several WLANs are active, several will be displayed.

3. Select the network in the list, right-click the network, and then click **Properties**.

---

 **NOTE:** If the network you want is not listed, check with the network administrator to be sure that the router or access point is operating.

---

4. Click the **Security** tab and enter the correct wireless encryption data into the **Network security key** box.

5. Click **OK** to save these settings.

## WLAN connection is very weak

If the connection is very weak, or if your computer cannot make a connection to a WLAN, minimize interference from other devices, as follows:

- Move your computer closer to the wireless router or access point.
- Temporarily disconnect devices such as a microwave, cordless phone, or cellular phone to be sure that other wireless devices are not interfering.

If the connection does not improve, try forcing the device to reestablish all connection values:

1. Select **Start > Control Panel > Network and Sharing Center**.

2. In the left panel, click **Manage wireless networks**.

A list showing the available WLANs is displayed. If you are in a hotspot where several WLANs are active, several will be displayed.

3. Click a network, and then click **Remove**.

## Cannot connect to the wireless router

If you are trying to connect to the wireless router and are unsuccessful, reset the wireless router by removing power from the router for 10 to 15 seconds.

If the computer still cannot make a connection to a WLAN, restart the wireless router. For details, refer to the router manufacturer's instructions.



## Using the modem (select models only)

The modem must be connected to an analog telephone line using a 6-pin, RJ-11 modem cable (purchased separately). In some countries, a country-specific modem cable adapter (purchased separately) is also required. Jacks for digital PBX systems may resemble analog telephone jacks, but they are not compatible with the modem.

⚠ **WARNING!** Connecting the internal analog modem to a digital line can permanently damage the modem. Immediately disconnect the modem cable if you accidentally connect it to a digital line.

If the modem cable contains noise suppression circuitry **(1)**, which prevents interference from TV and radio reception, orient the circuitry end **(2)** of the cable toward the computer.



## Connecting a modem cable

⚠ **WARNING!** To reduce the risk of electric shock, fire, or damage to the equipment, do not plug a modem cable (included with select models only) or telephone cable into the RJ-45 (network) jack.

To connect a modem cable:

1. Plug the modem cable into the modem jack **(1)** on the computer.
2. Plug the modem cable into the RJ-11 telephone wall jack **(2)**.

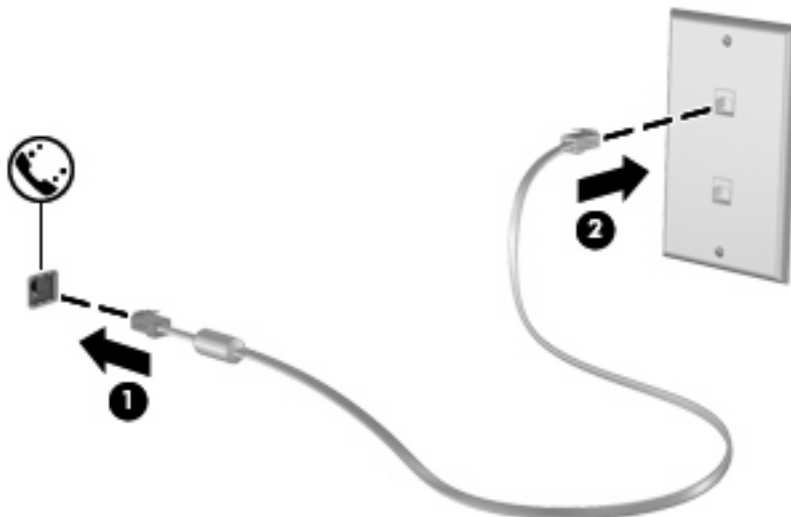

## Connecting a country-specific modem cable adapter

Telephone jacks vary by country. To use the modem and the modem cable (included with select models only) outside the country in which you purchased the computer, you must obtain a country-specific modem cable adapter (included with select models only).

To connect the modem to an analog telephone line that does not have an RJ-11 telephone jack, follow these steps:

1. Plug the modem cable into the modem jack **(1)** on the computer.
2. Plug the modem cable into the country-specific modem cable adapter **(2)**.
3. Plug the country-specific modem cable adapter **(3)** into the telephone wall jack.

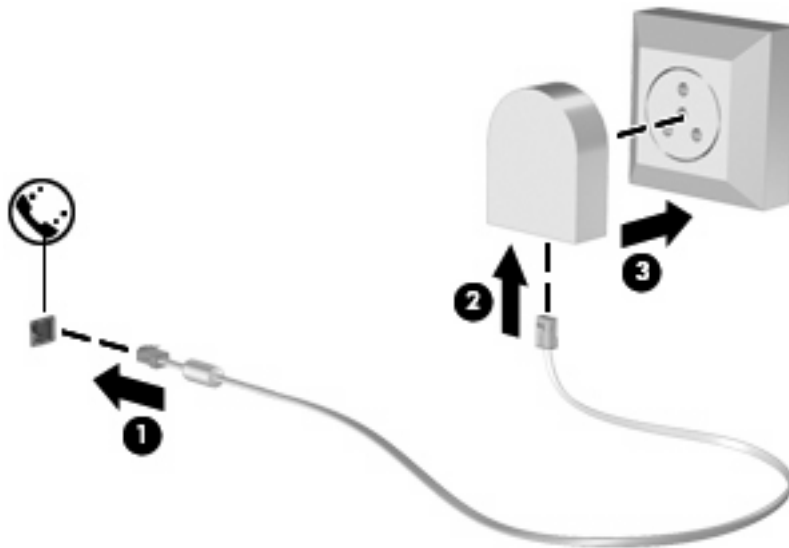

## Selecting a location setting

### Viewing the current location selection

To view the current location setting for the modem, follow these steps:

1. Select **Start > Control Panel**.
2. Click **Clock, Language, and Region**.
3. Click **Region and Language**.
4. Click the **Location** tab to display your location.

## Adding new locations when traveling

By default, the only location setting available to the modem is a location setting for the country in which you purchased the computer. As you travel to different countries, set the internal modem to a location setting that meets the operating standards of the country in which you are using the modem.

As you add new location settings, they are saved by the computer so that you can switch among settings at any time. You can add multiple location settings for any country.

△ **CAUTION:** To prevent losing your home country settings, do not delete your current modem country settings. To enable modem use in other countries while preserving your home country configuration, add a new configuration for each location in which you will use the modem.

**CAUTION:** To prevent configuring the modem in a way that violates the telecommunications regulations and laws of the country you are visiting, select the country in which the computer is located. The modem may not function properly if the correct country selection is not made.

To add a location setting for the modem, follow these steps:

1. Select **Start > Devices and Printers**.
2. Right-click the device that represents your computer, and then click **Modem settings**.

 **NOTE:** You must set up an initial (current) location area code before you can view the Dialing Rules tab. If you do not have a location set up, you will be prompted to enter the location when you click Modem settings.

3. Click the **Dialing Rules** tab.
4. Click **New**. The New Location window is displayed.
5. In the **Location name** box, enter a name such as “home” or “work” for the new location setting.
6. Select a country or region from the **Country/region** drop-down list. (If you select a country or region that is not supported by the modem, the Country/region selection for USA or UK is displayed by default.)
7. Enter the area code, a carrier code (if necessary), and the number to access an outside line (if necessary).
8. Next to **Dial using**, click **Tone** or **Pulse**.
9. Click **OK** to save your new location setting. The Phone and Modem window is displayed.
10. Do one of the following:
  - To set your new location setting as the current location, click **OK**.
  - To select another location setting as the current location setting, select your preference from the settings in the Location list, and then click **OK**.

 **NOTE:** You can use the preceding procedure to add location settings for places within your own country as well as in other countries. For example, you could add a setting named “Work” that includes dialing rules for accessing an outside line.

## Solving travel connection problems

If you experience modem connection problems when using the computer outside of the country in which you purchased it, try the following suggestions.

- **Check the telephone line type.**

The modem requires an analog, not a digital, telephone line. A line described as a PBX line is usually a digital line. A telephone line described as a data line, fax machine line, modem line, or standard telephone line is usually an analog line.

- **Check for pulse or tone dialing.**

An analog telephone line supports one of two dialing modes: pulse dialing or tone dialing. These dialing mode options are selected in the Phone and Modem settings. The dialing mode option selected must match the dialing mode supported by the telephone line in your location.

To determine the dialing mode supported by a telephone line, dial a few digits on the telephone, and then listen for clicks (pulses) or tones. Clicks indicate that the telephone line supports pulse dialing. Tones indicate that the telephone line supports tone dialing.

To change the dialing mode in your current modem location setting, follow these steps:

1. Select **Start > Devices and Printers**.
2. Right-click the device that represents your computer, and then click **Modem settings**.
3. Click the **Dialing Rules** tab.
4. Select your modem location setting.
5. Click **Edit**.
6. Click either **Tone** or **Pulse**.
7. Click **OK** twice.

- **Check the telephone number you are dialing and the response of the remote modem.**

Dial a telephone number, make sure there is a response from the remote modem, and then hang up.

- **Set the modem to ignore dial tones.**

If the modem receives a dial tone it does not recognize, it does not dial and displays a “No Dial Tone” error message.

To set the modem to ignore all dial tones before dialing, follow these steps:

1. Select **Start > Devices and Printers**.
2. Right-click the device that represents your computer, and then click **Modem settings**.
3. Click the **Modems** tab.
4. Click the listing for the modem.
5. Click **Properties**.
6. Click **Modem**.

7. Clear the check box for **Wait for dial tone before dialing**.
8. Click **OK** twice.

## Connecting to a local area network

Connecting to a local area network (LAN) requires an 8-pin, RJ-45 network cable (purchased separately). If the network cable contains noise suppression circuitry **(1)**, which prevents interference from TV and radio reception, orient the circuitry end of the cable **(2)** toward the computer.



To connect the network cable:

1. Plug the network cable into the network jack **(1)** on the computer.
2. Plug the other end of the cable into a network wall jack **(2)**.

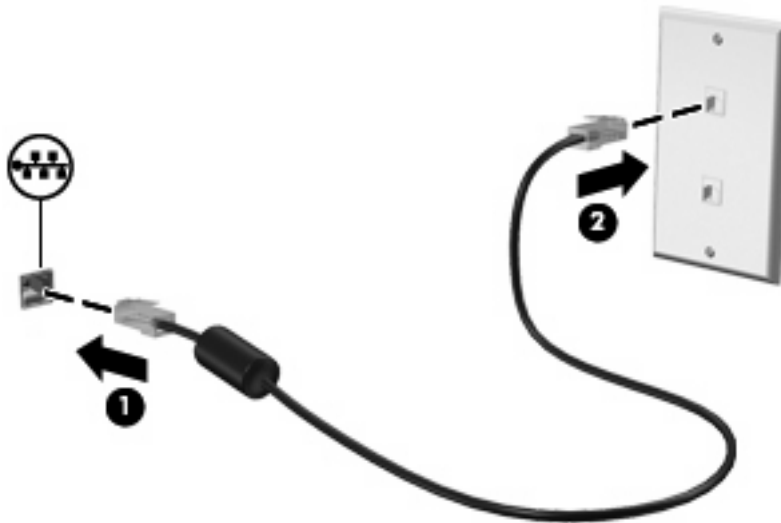

**⚠ WARNING!** To reduce the risk of electric shock, fire, or damage to the equipment, do not plug a modem or telephone cable into the RJ-45 (network) jack.

## 3 Pointing devices and keyboard

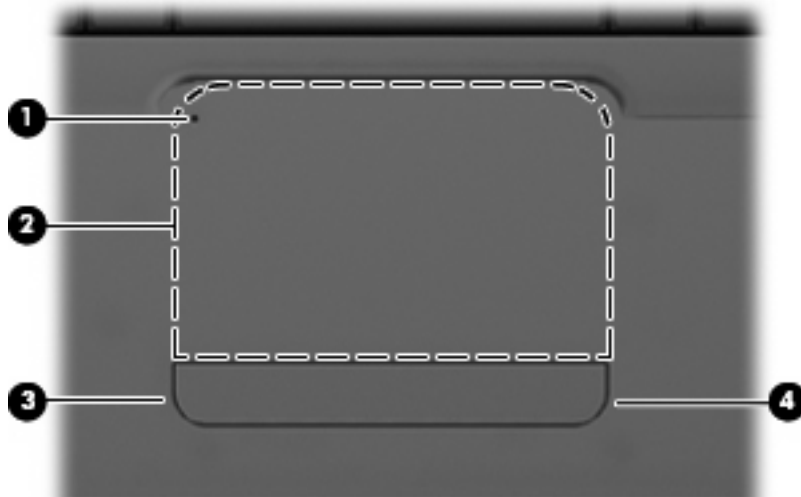

Component	Description
(1) TouchPad off indicator	<ul style="list-style-type: none"><li>• When the TouchPad zone is active, the light is off.</li><li>• When the TouchPad zone is inactive, the light is amber.</li></ul>
(2) TouchPad zone	Moves the pointer and selects or activates items on the screen.
(3) Left TouchPad control	Use the left side of the TouchPad control button like the left button on an external mouse.
(4) Right TouchPad control	Use the right side of the TouchPad control button like the right button on an external mouse.

## Turning the TouchPad on and off

When the TouchPad zone is active, the light is off. To turn the TouchPad on and off, quickly double-tap the TouchPad off indicator.

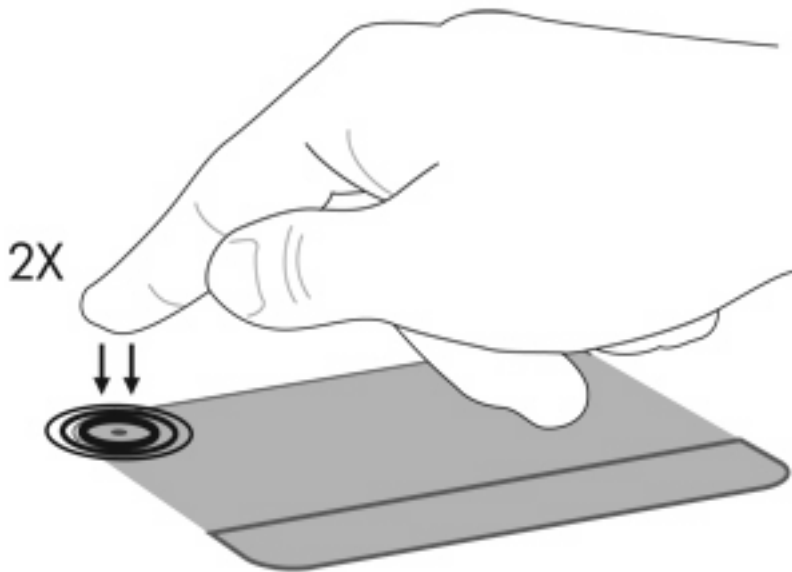

## Using the TouchPad

To move the pointer, slide your finger across the TouchPad surface in the direction you want the pointer to go. Use the left and right TouchPad controls like the left and right buttons on an external mouse. To scroll up and down using the TouchPad scroll zone, slide your finger up or down along the right edge of the TouchPad.

 **NOTE:** If you are using the TouchPad to move the pointer, you must lift your finger off the TouchPad before moving it to the scroll zone. Simply sliding your finger from the TouchPad to the scroll zone will not activate the scrolling function.

## Using TouchPad gestures

The TouchPad supports a variety of TouchPad gestures. To activate the TouchPad gestures, place two fingers on the TouchPad as described in the following sections.

To enable or disable gestures, click the **Synaptics** icon in the notification area, at the far right of the taskbar, then check or uncheck **Disable Gestures**. To enable or disable a specific gesture, select **Control Panel > Hardware and Sound > Mouse > Device settings > Settings**, and then select or clear the check box next to the gesture you want to enable or disable.

## Scrolling

Scrolling is useful for moving up or down on a page or image. It can also be used to scroll from side to side when a scroll bar is displayed at the bottom of the screen. To scroll, place two fingers on the TouchPad, and then drag them across the TouchPad in an up, down, left, or right motion.

 **NOTE:** Scrolling speed is controlled by finger speed.

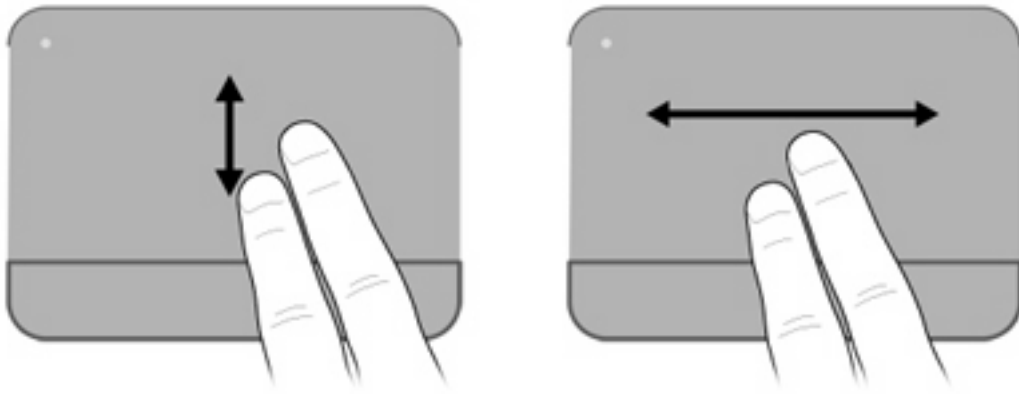

## Pinching

Pinching allows you to zoom in or out on items such as PDFs, images, and photos.

To pinch:

1. Zoom in by holding two fingers together on the TouchPad, and then pull the fingers apart to increase an object's size.
2. Zoom out by holding two fingers apart on the TouchPad, and then pull the fingers together to decrease an object's size.

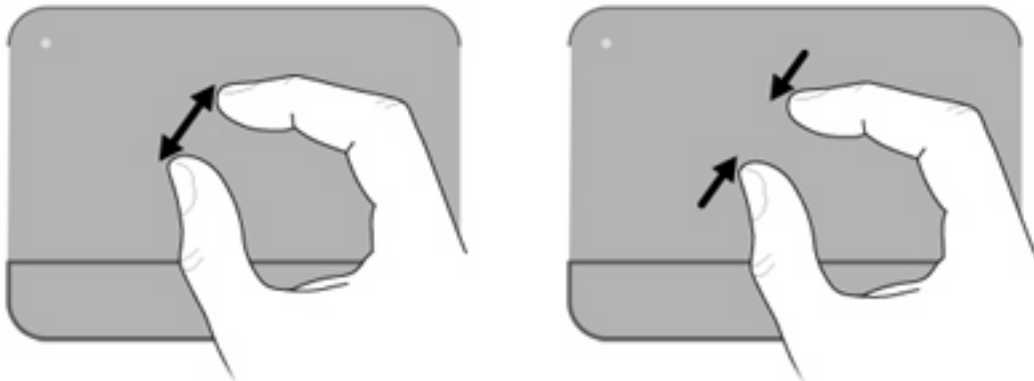

## Rotating

Rotating allows you to rotate items such as photos and pages. To rotate, anchor your thumb on the TouchPad, and then move your forefinger in a semicircular motion around your thumb.



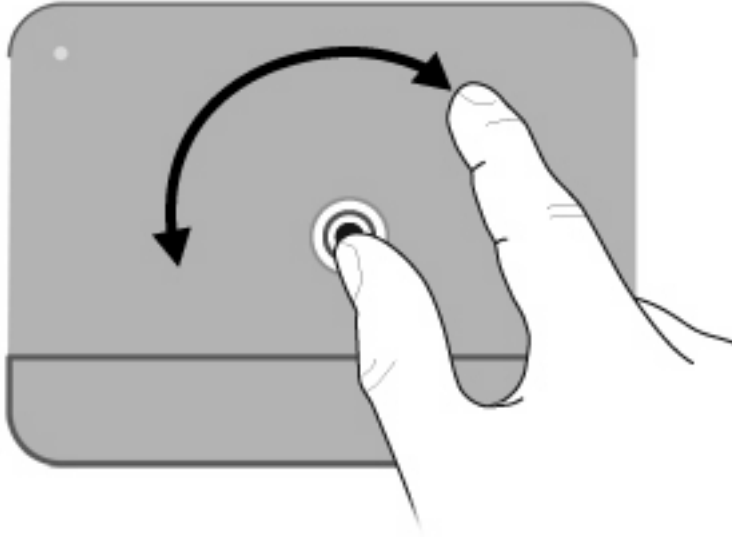

## Setting pointing device preferences

Use Mouse Properties in Windows to customize settings for pointing devices, such as button configuration, click speed, and pointer options.

To access Mouse Properties, select **Start > Control Panel > Printers and Other Hardware > Mouse**.

## Using the keyboard



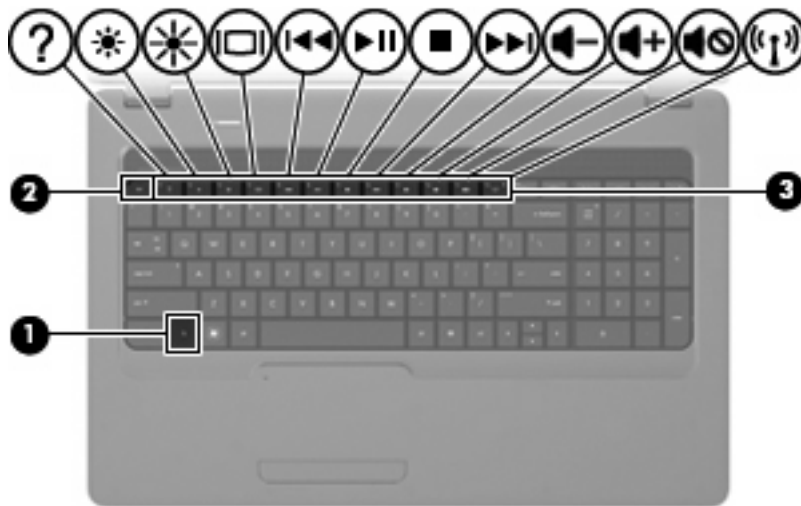

The icons on the **f1** through **f12** keys, at the top of the keyboard, represent the action key functions.

**NOTE:** Depending on the program you are using, pressing **fn (1)** and one of the action keys opens a specific shortcut menu within that program.

The action key feature is enabled at the factory. You can disable this feature in the Setup Utility to require pressing the **fn** key and one of the action keys to activate the assigned function (refer to [Setup Utility \(BIOS\) on page 98](#)).



Function	Action key or hotkey
<b>fn+esc</b>	Press <b>fn+esc</b> (callouts 1 and 2) to display information about system hardware components and the system BIOS (basic input-output system) version number.
<b>?</b>	Press <b>f1</b> to open Help and Support, which provides answers to questions, information about your Windows operating system and computer, tutorials, and updates to your computer. Help and Support also provides checkups for computer functionality, automated and interactive troubleshooting, repair solutions, system recovery procedures, and links to technical support.
	Press and hold <b>f2</b> to decrease the screen brightness level incrementally.
	Press and hold <b>f3</b> to increase the screen brightness level incrementally.
	Press <b>f4</b> to switch the screen image among display devices connected to the computer. For example, if a monitor is connected to the computer, pressing this key alternates the screen image from the computer display to the monitor display to simultaneous display on both the computer and the monitor.  Most external monitors receive video information from the computer using the external VGA video standard. The <b>f4</b> key can also alternate images among other devices that are receiving video information from the computer.
	Press <b>f5</b> to play the previous track of a CD or the previous section of a DVD or a Blu-ray Disc (BD).
	Press <b>f6</b> to play, pause, or resume a track of an audio CD or a section of a DVD or a BD.
	Press <b>f7</b> to stop the playback of an audio CD, a DVD, or a BD.

Function	Action key or hotkey
	Press <b>f8</b> to play the next track of an audio CD or the next section of a DVD or BD.
	Press and hold <b>f9</b> to decrease speaker volume incrementally.
	Press and hold <b>f10</b> to increase speaker volume incrementally.
	Press <b>f11</b> to mute or restore speaker sound.
	Press <b>f12</b> to turn the wireless feature on or off. <b>NOTE:</b> This key does not establish a wireless connection. To establish a wireless connection, a wireless network must also be set up.

## Using keypads

The computer has an integrated numeric keypad and also supports an optional external numeric keypad or an optional external keyboard that includes a numeric keypad.

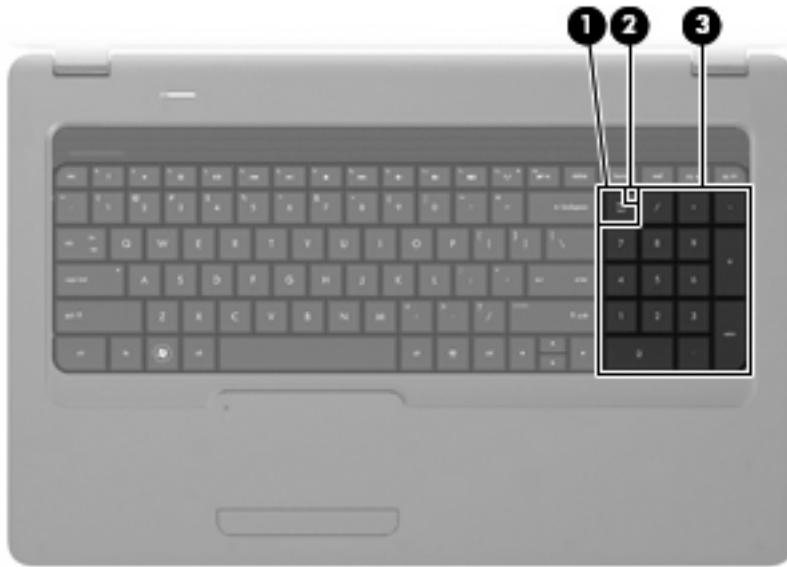

Component	Description
(1) num lk key	Alternates between the navigation and numeric functions on the integrated numeric keypad.  <b>NOTE:</b> The keypad function that is active when the computer is turned off will be reinstated when the computer is turned back on.  On: The numeric function of the keypad is enabled.  Off: The navigation function of the keypad is enabled.
(2) Num lock light	On: Num lock is on.
(3) Integrated numeric keypad	Can be used like the keys on an external numeric keypad.

## Using an optional external numeric keypad

Keys on most external numeric keypads function differently according to whether num lock is on or off. (Num lock is turned off at the factory.) For example:

- When num lock is on, most keypad keys type numbers.
- When num lock is off, most keypad keys function like the arrow, page up, or page down keys.

When num lock on an external keypad is turned on, the num lock light on the computer is turned on. When num lock on an external keypad is turned off, the num lock light on the computer is turned off.

To turn num lock on or off on an external keypad as you work:

- ▲ Press the num lk key on the external keypad, not on the computer.

## Cleaning the TouchPad and keyboard

Dirt and grease on the TouchPad can cause the pointer to jump around on the screen. To avoid this, clean the TouchPad with a damp cloth, and wash your hands frequently when using the computer.

⚠ **WARNING!** To reduce the risk of electric shock or damage to internal components, do not use a vacuum cleaner attachment to clean the keyboard. A vacuum cleaner can deposit household debris on the keyboard surface.

Clean the keyboard regularly to prevent keys from sticking and to remove dust, lint, and particles that can become trapped beneath the keys. A can of compressed air with a straw extension can be used to blow air around and under the keys to loosen and remove debris.



---

# 4 Multimedia

## Multimedia features

Your computer includes multimedia features that allow you to listen to music, watch movies, and view pictures. Your computer may include the following multimedia components:

- Optical drive for playing audio and video discs
- Integrated speakers for listening to music
- Integrated microphone for recording your own audio
- Integrated webcam that allows you to record audio and video
- Preinstalled multimedia software that allows you to play and manage your music, movies, and pictures
- Multimedia action keys which provide fast access to multimedia tasks

---

 **NOTE:** Your computer may not include all of the components listed.

## Identifying your multimedia components

 **NOTE:** Your computer may look slightly different from the illustration in this section.

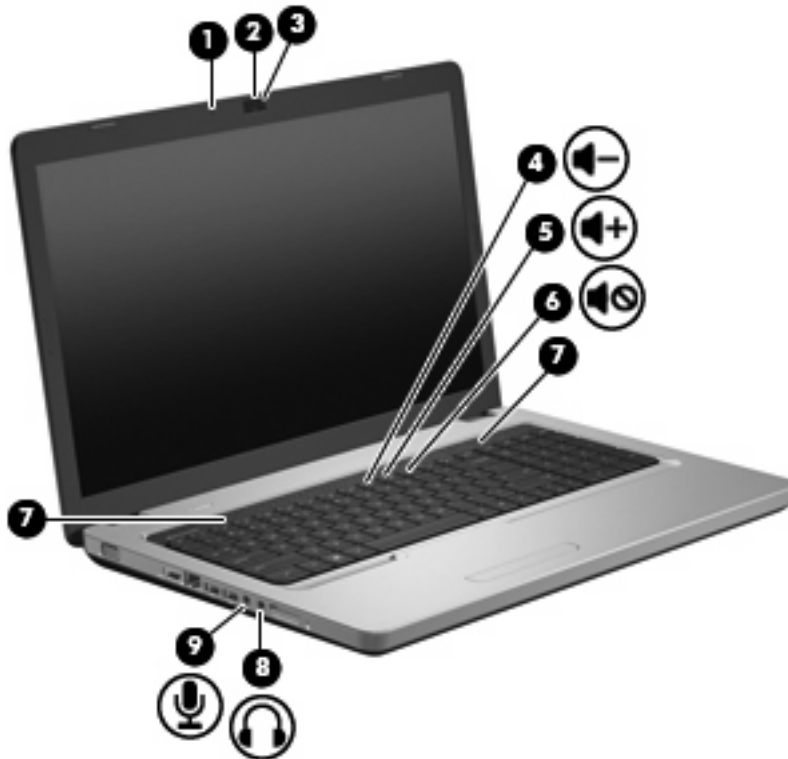

Component	Description
(1) Internal microphone	Records sound.
(2) Webcam (select models only)	Records video and captures still photographs.
(3) Webcam light (select models only)	White: The webcam is in use.
(4) Volume down action key (f9)	Decreases speaker sound.
(5) Volume up action key (f10)	Increases speaker sound.
(6) Volume mute action key (f11)	Mutes and restores speaker sound.
(7) Speakers (2)	Produce sound.
(8) Audio-out (headphone) jack	Produces sound when connected to optional powered stereo speakers, headphones, earbuds, a headset, or television audio.  <b>WARNING!</b> To reduce the risk of personal injury, adjust the volume before putting on headphones, earbuds, or a headset. For additional safety information, refer to the <i>Regulatory, Safety and Environmental Notices</i> .  <b>NOTE:</b> When a device is connected to the headphone jack, the computer speakers are disabled.
(9) Audio-in (microphone) jack	Connects an optional computer headset microphone, stereo array microphone, or monaural microphone.

## Adjusting the volume

You can adjust the volume using the following controls:

- Action keys:
  - Press **f11** to mute or restore speaker sound.
  - Press and hold **f9** to decrease speaker sound incrementally.
  - Press and hold **f10** to increase speaker sound incrementally.
- Windows volume control:
  - a. Click the **Speakers** icon in the notification area, at the far right of the taskbar.
  - b. Increase or decrease the volume by moving the slider up or down. Click the **Mute Speakers** icon to mute the volume.

– or –

  - a. Right-click the **Speakers** icon in the notification area, and then click **Open Volume Mixer**.
  - b. In the **Speakers** column, you can increase or decrease the volume by moving the slider up or down. You can also mute the volume by clicking the **Mute Speakers** icon.

If the **Speakers** icon is not displayed in the notification area, follow these steps to add it:

  - a. Right-click the **Show hidden icons** icon (the arrow at the left side of the notification area).
  - b. Click **Customize notification icons**.
  - c. Under **Behaviors**, select **Show icon and notifications** for the Volume icon.
  - d. Click **OK**.
- Program volume control:

Volume can also be adjusted within some programs.



## Using the media activity functions

The media activity action keys control the play of an audio CD, DVD, or BD (Blu-ray Disc) in the optical drive.

### Using the media activity action keys

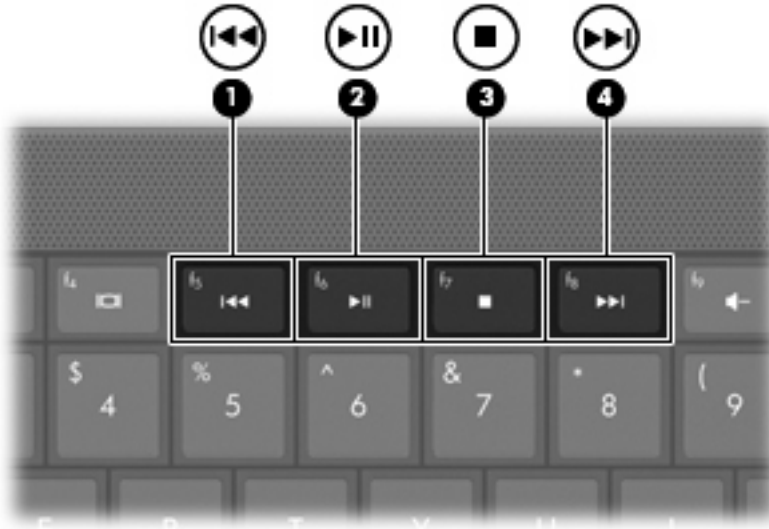

When an audio CD, DVD, or BD is not playing, press **f6** (2) to play the disc.

When an audio CD, DVD, or BD is playing, use the following action keys:

- To play the previous track of an audio CD or the previous section of a DVD or BD, press **f5** (1).
- To pause or resume playing the disc, press **f6** (2).
- To stop the disc, press **f7** (3).
- To play the next track of an audio CD or the next section of a DVD or BD, press **f8** (4).

## Multimedia software

Your computer includes preinstalled multimedia software that allows you to play music, watch movies, and view pictures. The following sections provide details about CyberLink PowerDVD and other preinstalled multimedia software.

### Using CyberLink PowerDVD software

CyberLink PowerDVD turns your computer into a mobile entertainment center. With CyberLink PowerDVD, you can enjoy music and DVD movies.

To start CyberLink PowerDVD, select **Start > All Programs > CyberLink PowerDVD 8**.

For information on using CyberLink PowerDVD, refer to the software Help.

### Using other preinstalled multimedia software

To locate other preinstalled multimedia software:

- ▲ Select **Start > All Programs**, and then open the multimedia program you want to use. For example, if you want to use Windows Media Player to play an audio CD, click **Windows Media Player**.

---

 **NOTE:** Some programs may be located in subfolders.

---

### Installing multimedia software from a disc

To install any multimedia software from a CD or DVD, follow these steps:

1. Insert the disc into the optical drive.
2. When the installation wizard opens, follow the on-screen instructions.
3. Restart the computer if you are prompted to do so.

---

 **NOTE:** For details about using software included with the computer, refer to the software manufacturer's instructions, which may be provided on disc, in the software Help, or on the manufacturer's Web site.

---

# Audio

Your computer enables you to use a variety of audio features:

- Play music using your computer speakers and/or connected external speakers.
- Record sound by using the internal microphone or by connecting an external microphone.
- Download music from the Internet.
- Create multimedia presentations using audio and images.
- Transmit sound and images with instant messaging programs.
- Stream radio programs (select models only) or receive FM radio signals.
- Create (burn) audio CDs.

## Connecting external audio devices

---

 **WARNING!** To reduce the risk of personal injury, adjust the volume before putting on headphones, earbuds, or a headset. For additional safety information, refer to the *Regulatory, Safety and Environmental Notices*.

---

To connect external devices such as external speakers, headphones, or a microphone, refer to the information provided with the device. For best results, remember the following tips:

- Be sure that the device cable is securely connected to the correct jack on your computer. Cable connectors are normally color-coded to match the corresponding jacks on the computer.
- Be sure that you install any drivers required by the external device.

 **NOTE:** A driver is a required program that acts like a translator between the device and the programs that use the device.

---

## Checking your audio functions

To check the system sound on your computer, follow these steps:

1. Select **Start > Control Panel**.
2. Click **Hardware and Sound**.
3. Click **Sound**.
4. When the Sound window opens, click the **Sounds** tab. Under **Program Events**, select any sound event, such as a beep or alarm, and then click the **Test** button.

You should hear sound through the speakers or through connected headphones.

To check the record functions of the computer, follow these steps:

1. Select **Start > All Programs > Accessories > Sound Recorder**.
2. Click **Start Recording** and speak into the microphone. Save the file to your desktop.
3. Open Windows Media Player or CyberLink PowerDVD, and then play back the sound.

 **NOTE:** For best results when recording, speak directly into the microphone and record sound in a setting free of background noise.

---

To confirm or change the audio settings on your computer, select **Start > Control Panel > Hardware and Sound > Sound**.

## Video

Your computer enables you to use a variety of video features:

- Watch movies.
- Play games over the Internet.
- Edit pictures and video to create presentations.
- Connect external video devices.

## Connecting an HDMI device (select models only)

Select computer models include an HDMI (High Definition Multimedia Interface) port. The HDMI port connects the computer to an optional video or audio device, such as a high-definition television, or any compatible digital or audio component.

The computer can support one HDMI device connected to the HDMI port, while simultaneously supporting an image on the computer display or any other supported external display.

 **NOTE:** To transmit video signals through the HDMI port, you need an HDMI cable (purchased separately), available from most electronics retailers.

To connect a video or audio device to the HDMI port:

1. Connect one end of the HDMI cable to the HDMI port on the computer.

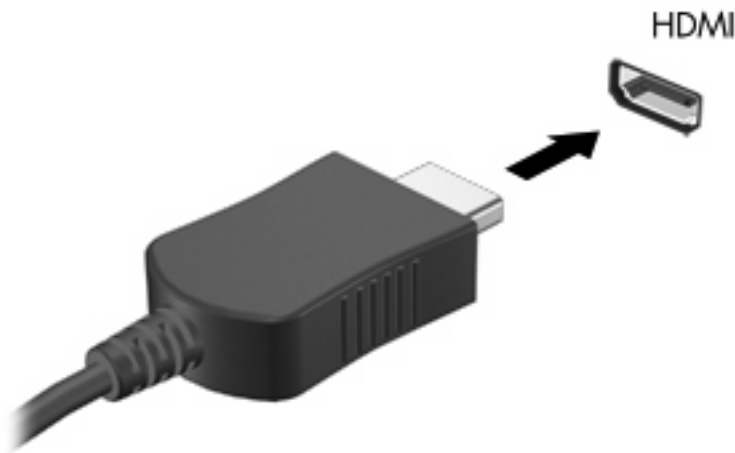

2. Connect the other end of the cable to the video device, according to the device manufacturer's instructions.
3. Press **f4** on the computer to switch the image between the display devices connected to the computer.

## Configuring audio for HDMI (select models only)

To configure HDMI audio, first connect an audio or video device, such as a high-definition TV, to the HDMI port on your computer. Then configure the default audio playback device as follows:

1. Right-click the **Speakers** icon in the notification area, at the far right of the taskbar, and then click **Playback devices**.
2. On the **Playback** tab, click either **Digital Output** or **Digital Output Device (HDMI)**.
3. Click **Set Default**, and then click **OK**.

To return audio to the computer speakers, follow these steps:

1. Right-click the **Speakers** icon in the notification area, at the far right of the taskbar, and then click **Playback devices**.
2. On the **Playback** tab, click **Speakers**.
3. Click **Set Default**, and then click **OK**.

## Optical drive

An optical drive, such as a DVD-ROM drive, plays optical discs (CDs and DVDs). These discs store information, such as music, photos, and movies. DVDs have a higher storage capacity than CDs.

Your optical drive can read standard CD and DVD discs. If your optical drive is a Blu-ray Disc ROM Drive, it can also read Blu-ray Discs.

For information about using the optical drive, refer to [Optical drive on page 70](#).

## Webcam (select models only)

Your computer may include an integrated webcam, located at the top of the display. The webcam is an input device that allows you to capture and share video. Preinstalled CyberLink YouCam software provides new features that expand the webcam experience.

To use the webcam and CyberLink YouCam software, select **Start > All Programs > CyberLink YouCam > CyberLink YouCam**.

---

 **NOTE:** The first time you access the YouCam software, you may experience a brief delay as the software loads.

---

Using YouCam as your webcam software enables you to experiment with the following features:

- **Video**—Record and play back webcam video. You can also e-mail or upload video to YouTube, using the icon on the software interface.
- **Streaming video**—When you open your instant message program, YouCam displays a floating toolbar that lets you add graphic effects.
- **Special effects**—Add frames, filters, and emoticons to your snapshots and video.
- **Snapshots**—Take single frame or “burst” webcam shots in rapid succession.
- **Connect**—E-mail photos and video using the icon on the software interface.

---

 **NOTE:** For details about using webcam software, refer to the software manufacturer's instructions, which may be provided with the software, on disc, or on the manufacturer's Web site.

---

## Webcam tips

For optimum performance, observe the following guidelines while using the webcam:

- Be sure that you have the latest version of an instant message program before starting a video conversation.
- The webcam may not work properly across some network firewalls.

---

 **NOTE:** If you are having trouble viewing or sending multimedia files to someone on another LAN or outside your network firewall, temporarily disable the firewall, perform the task you want to perform, and then reenable the firewall. To permanently resolve the problem, reconfigure the firewall as necessary, and adjust the policies and settings of other intrusion detection systems.

---

 **WARNING!** Security is temporarily compromised while the firewall is disabled.

---

## Adjusting webcam properties

You can adjust webcam properties using the Properties dialog box, which is accessible from various programs that use the integrated camera, usually from a configuration, settings, or properties menu:

- **Brightness**—Controls the amount of light that is incorporated into the image. A higher brightness setting creates a brighter image; a lower brightness setting creates a darker image.
- **Contrast**—Controls the difference between lighter and darker areas on the image. A higher contrast setting intensifies the image; a lower contrast setting maintains more of the original information's dynamic range but leads to a flatter image.



- **Hue**—Controls the aspect of color that distinguishes it from another color (what makes a color red, green, or blue). Hue is distinct from saturation, which measures the intensity of the hue.
- **Saturation**—Controls the strength of color in the final image. A higher saturation setting creates a bolder image; a lower saturation setting creates a more subtle image.
- **Sharpness**—Controls the definition of edges in an image. A higher sharpness setting creates a more defined image; a lower sharpness setting creates a softer image.
- **Gamma**—Controls the contrast affecting the mid-level grays or midtones of an image. Adjusting the gamma of an image allows you to change the brightness values of the middle range of gray tones without dramatically altering the shadows and highlights. A lower gamma setting makes grays look black, and makes dark colors even darker.
- **Backlight Comp**—Compensates in cases where a subject with a large amount of background light would otherwise be obscured by streaking or silhouetting.

For information about using the webcam, select **Start > Help and Support**.

# Troubleshooting

The following sections describe several common issues and their solutions.

## The optical disc tray does not open for removal of a CD, DVD, or BD

1. Insert the end of a paper clip (1) into the release access in the front bezel of the drive.
2. Press in gently on the paper clip until the disc tray is released, and then pull out the tray (2) until it stops.
3. Remove the disc (3) from the tray by gently pressing down on the spindle while lifting the outer edges of the disc. Hold the disc by the edges and avoid touching the flat surfaces.

---

 **NOTE:** If the tray is not fully accessible, tilt the disc carefully as you remove it.

---

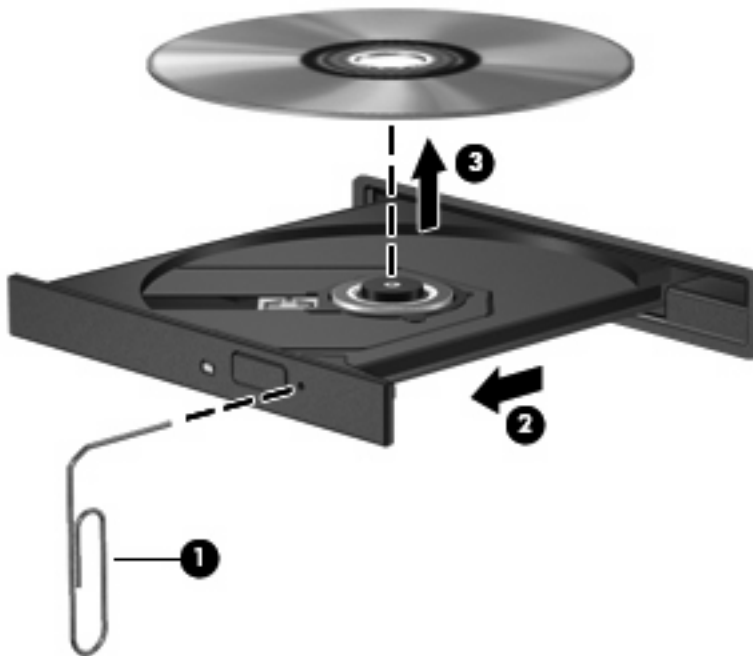

4. Close the disc tray, and then place the disc in a protective case.

## A disc does not play automatically

1. Click **Start > Default Programs > Change AutoPlay Settings**.
2. Confirm that the **Use AutoPlay for all media and devices** check box is selected.
3. Click **Save**.

A CD, DVD, or BD should now start automatically when it is inserted into the optical drive.

## A DVD movie stops, skips, or plays erratically

- Clean the disc.
- Conserve system resources by trying the following suggestions:
  - Log off the Internet.
  - Change the color properties of the desktop:
    1. Right-click on a blank area of the computer desktop, and then select **Screen resolution**.
    2. Select **Advanced Settings > Monitor** tab.
    3. Select **High Color (16 bit)**, if this setting is not already selected.
    4. Click **OK**.
  - Disconnect external devices, such as a printer, scanner, camera, or handheld device.

## A DVD movie is not visible on an external display

1. If both the computer display and an external display are turned on, press **f4** one or more times to switch between the two displays.
2. Configure the monitor settings to make the external display primary:
  - a. Right-click on a blank area of the computer desktop, and then select **Screen resolution**.
  - b. Specify a primary display and a secondary display.

---

 **NOTE:** When using both displays, the DVD image will not appear on any display designated as the secondary display.

---

To get information about a multimedia question not covered in this guide, go to **Start > Help and Support**.

## The process of burning a disc does not begin, or it stops before completion

- Be sure that all other programs are closed.
- Turn off Sleep and Hibernation.
- Be sure that you are using the right kind of disc for your drive (see [Selecting the right disc \(CDs, DVDs, and BDs\) on page 72](#)).
- Be sure that the disc is inserted properly.
- Select a slower write speed and try again.
- If you are copying a disc, save the information on the source disc to your hard drive before trying to burn the contents to a new disc, and then burn from your hard drive.
- Reinstall the disc-burning device driver located in the DVD/CD-ROM drives category in Device Manager.

## A DVD playing in Windows Media Player produces no sound or display

Use CyberLink PowerDVD to play a DVD. CyberLink PowerDVD is installed on the computer and is also available from the HP Web site at <http://www.hp.com>.

## A device driver must be reinstalled

1. Remove any discs from the optical drive.
2. Select **Start > Control Panel > System and Security**. Then in the System area, click **Device Manager**.
3. In the Device Manager window, click the arrow next to the type of driver you want to uninstall, and then reinstall (for example, DVD/CD-ROMs, Modems, and so on).
4. Right-click the device listing, and then click **Uninstall**. When prompted, confirm that you want to delete the device, but do not restart the computer. Repeat for any other drivers you want to delete.
5. In the Device Manager window, click **Action**, and then click **Scan for hardware changes**. Windows scans your system for installed hardware and installs default drivers for any devices requiring drivers.

---

 **NOTE:** If you are prompted to restart the computer, save all open files, and then continue with the restart.

---

6. Reopen Device Manager, if necessary, and then verify that the drivers are once again listed.
7. Try to use your device.

If uninstalling and reinstalling the device drivers does not correct the problem, you may need to update your drivers using the procedures in the following sections.

## Obtaining the latest HP device drivers

1. Open your Internet browser, go to <http://www.hp.com/support>, and then select your country or region.
2. Click the option for software and driver downloads, enter your computer model number in the search box, and then press **enter**.
3. Click your specific product from the models listed.
4. Click the Windows 7 operating system.
5. When the list of drivers is displayed, click an updated driver to open a window containing additional information.
6. Click **Install now** to install the updated driver.

---

 **NOTE:** In some locations you may be able to download the driver and install it later. To do this, click **Download only** to save the file to your computer. When prompted, click **Save**, and then select a storage location on your hard drive. After the file is downloaded, navigate to the folder where the file was stored, and then double-click the file to install.

---

7. If prompted to do so, restart your computer after the installation is complete, and then verify the operation of the device.

## Obtaining the latest Windows device drivers

You can obtain the latest Windows device drivers by using Windows Update. This feature can be set to automatically check for and install updates for the Windows operating system and other Microsoft products.

To use Windows Update:

1. Click **Start > All Programs > Windows Update**.

 **NOTE:** If you have not previously set up Windows Update, you will be prompted to enter settings before you can check for updates.

---

2. Click **Check for updates**.
3. Follow the on-screen instructions.

---

# 5 Power management

## Setting power options

### Using power-saving states

The computer has two power-saving states enabled at the factory: Sleep and Hibernation.

When Sleep is initiated, the power lights blink and the screen clears. Your work is saved to memory, letting you exit Sleep faster than exiting Hibernation. If the computer is in the Sleep state for an extended period or if the battery reaches a critical battery level while in the Sleep state, the computer initiates Hibernation.

When Hibernation is initiated, your work is saved to a hibernation file on the hard drive and the computer turns off.

- 
- △ **CAUTION:** To prevent possible audio and video degradation, loss of audio or video playback functionality, or loss of information, do not initiate Sleep or Hibernation while reading from or writing to a disc or an external media card.
  - 📄 **NOTE:** You cannot initiate any type of networking connection or perform any computer functions while the computer is in the Sleep state or in Hibernation.
-

## Initiating and exiting Sleep

The system is set at the factory to initiate Sleep after 15 minutes of inactivity when running on battery power and 30 minutes of inactivity when running on external power.

Power settings and timeouts can be changed using Power Options in Windows® Control Panel.

With the computer on, you can initiate Sleep in any of the following ways:

- Briefly press the power button.
- Close the display.
- Click **Start**, click the arrow next to the Shut down button, and then click **Sleep**.

You can exit Sleep in any of the following ways:

- Briefly press the power button.
- If the display is closed, open the display.
- Press a key on the keyboard or a button on the remote control.
- Activate the TouchPad.

When the computer exits Sleep, the power light turns on and your work returns to the screen where you stopped working.

---

 **NOTE:** If you have set a password to be required on wakeup, you must enter your Windows password before your work will return to the screen.

---

## Initiating and exiting Hibernation

The system is set at the factory to initiate Hibernation after 1,080 minutes (18 hours) of inactivity when running on both battery power and external power, or when the battery reaches a critical battery level.

Power settings and timeouts can be changed using Power Options in Windows Control Panel.

To initiate Hibernation:

- ▲ Click **Start**, click the arrow next to the Shut down button, and then click **Hibernate**.

To exit Hibernation:

- ▲ Briefly press the power button.

The power light turns on and your work returns to the screen where you stopped working.

---

 **NOTE:** If you have set a password to be required on wakeup, you must enter your Windows password before your work will return to the screen.

---

## Using the battery meter

The battery meter is located in the notification area, at the far right of the taskbar. The battery meter allows you to quickly access power settings, view remaining battery charge, and select a different power plan.

- To display the percentage of remaining battery charge and the current power plan, move the pointer over the battery meter icon.
- To access Power Options or to change the power plan, click the battery meter icon and select an item from the list.

Different battery meter icons indicate whether the computer is running on battery or external power. The icon also displays a message if the battery has reached a low battery level, critical battery level, or reserve battery level.

To hide or display the battery meter icon:

1. Right-click the **Show hidden icons** icon (the arrow at the left side of the notification area).
2. Click **Customize notification icons**.
3. Under Behaviors, select **Show icons and notifications** for the Power icon.
4. Click **OK**.

## Using power plans

A power plan is a collection of system settings that manages how the computer uses power. Power plans can help you conserve power or maximize performance.

You can change power plan settings or create your own power plan.

### Viewing the current power plan

- ▲ Click the battery meter icon in the notification area, at the far right of the taskbar.

– or –

Select **Start > Control Panel > System and Security > Power Options**.

### Selecting a different power plan

- ▲ Click the battery meter icon in the notification area, and then select a power plan from the list.

– or –

Select **Start > Control Panel > System and Security > Power Options**, and then select a power plan from the list.

### Customizing power plans

1. Click the battery meter icon in the notification area, and then click **More power options**.

– or –

Select **Start > Control Panel > System and Security > Power Options**.

2. Select a power plan, and then click **Change plan settings**.



3. Change the settings as needed.
4. To change additional settings, click **Change advanced power settings**, and then make your changes.

## Setting password protection on wakeup

To set the computer to prompt for a password when the computer exits Sleep or Hibernation, follow these steps:

1. Select **Start > Control Panel > System and Security > Power Options**.
2. In the left pane, click **Require a password on wakeup**.
3. Click **Change Settings that are currently unavailable**.
4. Click **Require a password (recommended)**.
5. Click **Save changes**.

## Using external AC power

External AC power is supplied through one of the following devices:

---

⚠ **WARNING!** To reduce potential safety issues, use only the AC adapter provided with the computer, a replacement AC adapter provided by HP, or a compatible AC adapter purchased from HP.

---

- Approved AC adapter
- Optional expansion product

Connect the computer to external AC power under any of the following conditions:

---

⚠ **WARNING!** Do not charge the computer battery while you are onboard aircraft.

---

- When you are charging or calibrating a battery
- When you are installing or modifying system software
- When you are writing information to a CD or DVD

When you connect the computer to external AC power, the following events occur:

- The battery begins to charge.
- If the computer is turned on, the battery meter icon in the notification area changes appearance.

When you disconnect external AC power, the following events occur:

- The computer switches to battery power.
- The display brightness is automatically decreased to save battery life. To increase display brightness, press **f3** or reconnect the AC adapter.

## Connecting the AC adapter

⚠ **WARNING!** To reduce the risk of electric shock or damage to the equipment:

Plug the power cord into an AC outlet that is easily accessible at all times.

Disconnect power from the computer by unplugging the power cord from the AC outlet (not by unplugging the power cord from the computer).

If provided with a 3-pin attachment plug on the power cord, plug the cord into a grounded (earthed) 3-pin outlet. Do not disable the power cord grounding pin, for example, by attaching a 2-pin adapter. The grounding pin is an important safety feature.

To connect the computer to external AC power:

1. Plug the AC adapter into the power connector **(1)** on the computer.
2. Plug the power cord into the AC adapter **(2)**.
3. Plug the other end of the power cord into an AC outlet **(3)**.

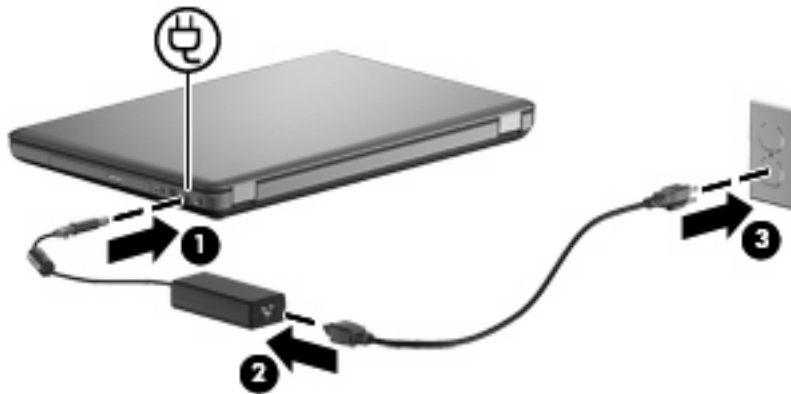

## Testing an AC adapter

Test the AC adapter if the computer exhibits any of the following symptoms when it is connected to AC power:

- The computer does not turn on.
- The display does not turn on.
- The power light is off.

To test the AC adapter:

1. Remove the battery from the computer.
  - a. Shut down the computer and close the display.
  - b. Turn the computer upside down on a flat surface.
  - c. Slide the battery release latch **(1)** to release the battery.
  - d. Pivot the battery **(2)** upward and remove the battery from the computer **(3)**.

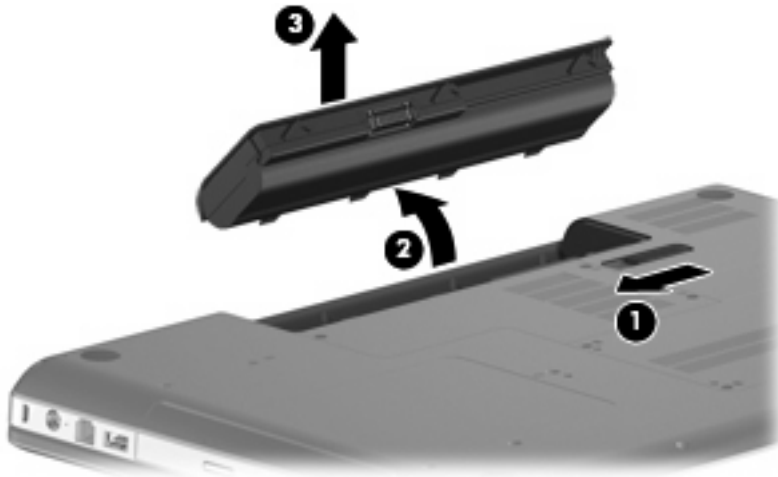

2. Connect the AC adapter to the computer, and then plug it into an AC outlet.
3. Turn on the computer.
  - If the power light turns on, the AC adapter is functioning properly.
  - If the power light remains off, the AC adapter is not functioning and should be replaced.  
Contact technical support for information on obtaining a replacement AC power adapter.

# Using battery power

When a charged battery is in the computer and the computer is not plugged into external power, the computer runs on battery power. When the computer is plugged into external AC power, the computer runs on AC power.

If the computer contains a charged battery and is running on external AC power supplied through the AC adapter, the computer switches to battery power if the AC adapter is disconnected from the computer.

 **NOTE:** The display brightness is decreased to save battery life when you disconnect AC power. To increase display brightness, press **F3** or reconnect the AC adapter.

You can keep a battery in the computer or in storage, depending on how you work. Keeping the battery in the computer whenever the computer is plugged into AC power charges the battery and also protects your work in case of a power outage. However, a battery in the computer slowly discharges when the computer is off and unplugged from external power.

 **WARNING!** To reduce potential safety issues, use only the battery provided with the computer, a replacement battery provided by HP, or a compatible battery purchased from HP.

Computer battery life varies, depending on power management settings, programs running on the computer, display brightness, external devices connected to the computer, and other factors.

## Finding battery information in Help and Support

The battery information section of the Help and Support Learning Center provides the following tools and information:

- Battery Check tool to test battery performance
- Information on calibration, power management, and proper care and storage to maximize battery life
- Information on battery types, specifications, life cycles, and capacity

To access battery information:

- ▲ Select **Start > Help and Support > Learning Center > HP Power and Battery Learning Center**.

## Using Battery Check

Battery Check, a part of Total Care Advisor, provides information on the status of the battery installed in the computer.

To run Battery Check:

1. Connect the AC adapter to the computer.

 **NOTE:** The computer must be connected to external power for Battery Check to function properly.

2. Select **Start > Help and Support > Troubleshooting tools > Battery Check**.

Battery Check examines the battery and its cells to see if they are functioning properly, and then reports the results of the examination.

## Displaying the remaining battery charge

- ▲ Move the pointer over the battery meter icon in the notification area, at the far right of the taskbar.

## Inserting or removing the battery

- △ **CAUTION:** Removing a battery that is the sole power source can cause loss of information. To prevent loss of information, initiate Hibernation or shut down the computer through Windows before removing the battery.
- 

To insert the battery:

1. Close the display.
2. Turn the computer upside down on a flat surface.
3. Insert the battery into the battery bay (1), and then rotate it downward until it is seated (2).



To remove the battery:

1. Turn off the computer and close the display.
2. Turn the computer upside down on a flat surface.
3. Slide the battery release latch (1) to release the battery.

4. Pivot the battery (2) upward, and then remove the battery from the computer (3).

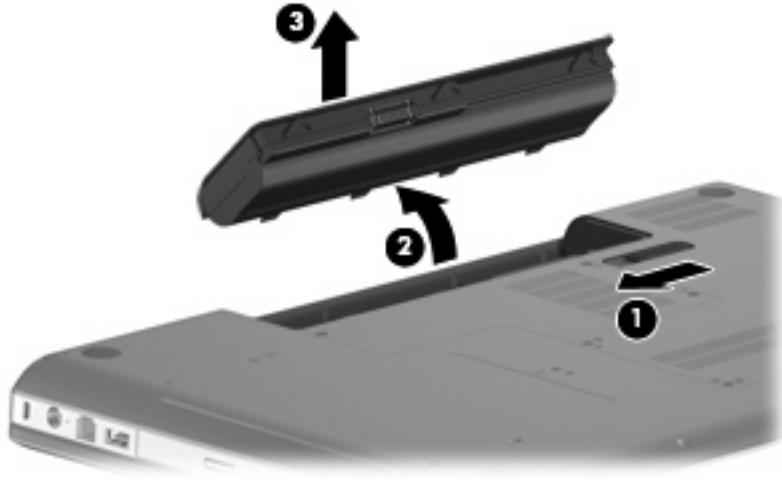

## Charging a battery

**⚠ WARNING!** Do not charge the computer battery while you are onboard aircraft.

The battery charges whenever the computer is plugged into external power through an AC adapter, an optional power adapter, or an optional expansion product.

The battery charges whether the computer is off or in use, but it charges faster when the computer is off.

Charging may take longer if a battery is new, has been unused for two weeks or more, or is much warmer or cooler than room temperature.

To prolong battery life and optimize the accuracy of battery charge displays, follow these recommendations:

- If you are charging a new battery, charge it fully before turning on the computer.
- Charge the battery until the battery light turns off.

**📝 NOTE:** If the computer is on while the battery is charging, the battery meter in the notification area may show 100 percent charge before the battery is fully charged.

- Allow the battery to discharge below 5 percent of a full charge through normal use before charging it.
- If the battery has been unused for one month or more, calibrate the battery instead of simply charging it.

The battery light displays charge status:

- On: The battery is charging.
- Blinking: The battery has reached a low battery level or critical battery level and is not charging.
- Off: The battery is fully charged, in use, or not installed.

## Maximizing battery discharge time

Battery discharge time varies depending on the features you use while on battery power. Maximum discharge time gradually shortens, as the battery storage capacity naturally degrades.

Tips for maximizing battery discharge time:

- Lower the brightness on the display.
- Check the Power saver setting in Power Options.
- Remove the battery from the computer when it is not being used or charged.
- Store the battery in a cool, dry location.

## Managing low battery levels

The information in this section describes the alerts and system responses set at the factory. Some low-battery alerts and system responses can be changed using Power Options in Windows Control Panel. Preferences set using Power Options do not affect lights.

### Identifying low battery levels

When a battery that is the sole power source for the computer reaches a low battery level, the battery light blinks.

If a low battery level is not resolved, the computer enters a critical battery level, and the battery light continues to blink.

The computer takes the following actions for a critical battery level:

- If Hibernation is enabled and the computer is on or in the Sleep state, the computer initiates Hibernation.
- If Hibernation is disabled and the computer is on or in the Sleep state, the computer remains briefly in the Sleep state, and then shuts down and loses any unsaved information.



## Resolving a low battery level

---

△ **CAUTION:** To reduce the risk of losing information when the computer reaches a critical battery level and has initiated Hibernation, do not restore power until the power light turns off.

---

### Resolving a low battery level when external power is available

- ▲ Connect one of the following devices:
  - AC adapter
  - Optional expansion product or docking device
  - Optional power adapter

### Resolving a low battery level when a charged battery is available

1. Turn off the computer or initiate Hibernation.
2. Remove the discharged battery, and then insert a charged battery.
3. Turn on the computer.

### Resolving a low battery level when no power source is available

- ▲ Initiate Hibernation.  
– or –  
Save your work and shut down the computer.

### Resolving a low battery level when the computer cannot exit Hibernation

When the computer lacks sufficient power to exit Hibernation, follow these steps:

1. Insert a charged battery or plug the computer into external power.
2. Exit Hibernation by pressing the power button.

## Calibrating a battery

Calibrate a battery under the following conditions:

- When battery charge displays seem inaccurate
- When you observe a significant change in battery run time

Even if a battery is heavily used, it should not need to be calibrated more than once a month. It is also not necessary to calibrate a new battery.

### Step 1: Fully charge the battery

---

△ **WARNING!** Do not charge the computer battery while you are onboard aircraft.

📝 **NOTE:** The battery charges whether the computer is off or in use, but it charges faster when the computer is off.

---

To fully charge the battery:

1. Insert the battery into the computer.
2. Connect the computer to an AC adapter, optional power adapter, or optional expansion product, and then plug the adapter or device into external power.

The AC adapter light on the computer turns on.

3. Leave the computer plugged into external power until the battery is fully charged.

The AC adapter light on the computer turns white when the battery is fully charged.

## Step 2: Disable Hibernation and Sleep

1. Click the battery meter icon in the notification area, and then click **More power options**.

– or –

Select **Start > Control Panel > System and Security > Power Options**.

2. Under the current power plan, click **Change plan settings**.
3. Record the **Turn off the display** settings listed in the **On battery** column so that you can reset them after the calibration.
4. Change the **Turn off the display** settings to **Never**.
5. Click **Change advanced power settings**.
6. Click the plus sign next to **Sleep**, and then click the plus sign next to **Hibernate after**.
7. Record the **On battery** setting under **Hibernate after** so that you can reset it after the calibration.
8. Change the **On battery** setting to **Never**.
9. Click **OK**.
10. Click **Save changes**.

### Step 3: Discharge the battery

The computer must remain on while the battery is being discharged. The battery can discharge whether or not you are using the computer, but the battery will discharge faster while you are using it.

- If you plan to leave the computer unattended during the discharge, save your information before beginning the discharge procedure.
- If you use the computer occasionally during the discharge procedure and have set energy-saving timeouts, expect the following performance from the system during the discharge process:
  - The monitor will not turn off automatically.
  - Hard drive speed will not decrease automatically when the computer is idle.
  - System-initiated Hibernation will not occur.

To discharge a battery:

1. Unplug the computer from its external power source, but do *not* turn off the computer.
2. Run the computer on battery power until the battery is discharged. The battery light begins to blink when the battery has discharged to a low battery level. When the battery is discharged, the battery light turns off and the computer shuts down.

### Step 4: Fully recharge the battery

To recharge the battery:

1. Plug the computer into external power and maintain external power until the battery is fully recharged. When the battery is recharged, the battery light on the computer turns off.

You can use the computer while the battery is recharging, but the battery will charge faster if the computer is off.

2. If the computer is off, turn it on when the battery is fully charged and the battery light has turned off.

## Step 5: Reenable Hibernation and Sleep

 **CAUTION:** Failure to reenable Hibernation after calibration may result in a full battery discharge and information loss if the computer reaches a critical battery level.

---

1. Click the battery meter icon in the notification area, and then click **More power options**.  
– or –  
Select **Start > Control Panel > System and Security > Power Options**.
2. Under the current power plan, click **Change plan settings**.
3. Re-enter the settings that you recorded for the items in the **On battery** column.
4. Click **Change advanced power settings**.
5. Click the plus sign next to **Sleep**, and then click the plus sign next to **Hibernate after**.
6. Re-enter the setting that you recorded for **On battery**.
7. Click **OK**.
8. Click **Save changes**.

## Conserving battery power

- Select the power saver power plan through Power Options under **System and Security** in Windows Control Panel.
- Turn off wireless and local area network (LAN) connections and exit modem applications when you are not using them.
- Disconnect external devices that are not plugged into an external power source when you are not using them.
- Stop, disable, or remove any external media cards that you are not using.
- Use the **f2** and **f3** action keys to adjust screen brightness as needed.
- If you leave your work, initiate Sleep or Hibernation, or shut down the computer.

## Storing a battery

 **CAUTION:** To prevent damage to a battery, do not expose it to high temperatures for extended periods of time.

---

If a computer will be unused and unplugged from external power for more than two weeks, remove the battery and store it separately.

To prolong the charge of a stored battery, place it in a cool, dry place.

 **NOTE:** A stored battery should be checked every six months. If the capacity is less than 50 percent, recharge the battery before returning it to storage.

---

Calibrate a battery before using it if it has been stored for one month or more.

## Disposing of a used battery

 **WARNING!** To reduce the risk of fire or burns, do not disassemble, crush, or puncture; do not short external contacts; do not dispose of in fire or water.

---

For additional information, refer to the *Regulatory, Safety and Environmental Notices* included with this computer.

## Replacing the battery

Computer battery life varies, depending on power management settings, programs running on the computer, display brightness, external devices connected to the computer, and other factors.

Battery Check notifies you to replace the battery when an internal cell is not charging properly, or when the battery storage capacity has reached a weak condition. A message refers you to the HP Web site for more information about ordering a replacement battery. If the battery is possibly covered by an HP warranty, instructions include a warranty ID.

 **NOTE:** To ensure that you always have battery power when you need it, HP recommends purchasing a new battery when the storage capacity indicator turns green-yellow.

---

# Shutting down the computer

△ **CAUTION:** Unsaved information will be lost when the computer is shut down.

---

The Shut down command closes all open programs, including the operating system, and then turns off the display and computer.

Shut down the computer under any of the following conditions:

- When you need to replace the battery or access components inside the computer
- When you are connecting an external hardware device that does not connect to a USB port
- When the computer will be unused and disconnected from external power for an extended period

Although you can shut down the computer with the power button, the recommended procedure is to use the Windows Shut down command.

To shut down the computer:

📝 **NOTE:** If the computer is in the Sleep state or in Hibernation, you must first exit Sleep or Hibernation before shutdown is possible.

---

1. Save your work and close all open programs.
2. Click **Start**.
3. Click **Shut down**.

If the computer is unresponsive and you are unable to use the preceding shutdown procedures, try the following emergency procedures in the sequence provided:

- Press **ctrl+alt+delete**, and then click the **Power** button.
- Press and hold the power button for at least 5 seconds.
- Disconnect the computer from external power, and then remove the battery.

---

# 6 Drives

## Handling drives

Drives are fragile computer components that must be handled with care. Refer to the following cautions before handling drives. Additional cautions are included with the procedures to which they apply.

- △ **CAUTION:** To reduce the risk of damage to the computer, damage to a drive, or loss of information, observe these precautions:

Before you move a computer that is connected to an external hard drive, initiate Sleep and allow the screen to clear, or properly disconnect the external hard drive.

Before handling a drive, discharge static electricity by touching the unpainted metal surface of the drive.

Do not touch the connector pins on a removable drive or on the computer.

Handle a drive carefully; do not drop a drive or place items on it.

Before removing or inserting a drive, shut down the computer. If you are unsure whether the computer is off, in the Sleep state, or in Hibernation, turn the computer on, and then shut it down through the operating system.

Do not use excessive force when inserting a drive into a drive bay.

An external hard drive must be connected to a USB port on the computer, not to a USB port on an external device such as a hub.

Do not enter information using the keyboard or move the computer while the optical drive is writing to a disc. The write process is sensitive to vibration.

When the battery is the only source of power, be sure that the battery is sufficiently charged before writing to media.

Avoid exposing a drive to temperature or humidity extremes.

Avoid exposing a drive to liquids. Do not spray the drive with cleaning products.

Remove media from a drive before removing the drive from the drive bay, or traveling with, shipping, or storing a drive.

If a drive must be mailed, place the drive in a bubble-pack mailer or other suitable protective packaging and label the package "FRAGILE."

Avoid exposing a drive to magnetic fields. Security devices with magnetic fields include airport walk-through devices and security wands. The airport security devices that check carry-on luggage, such as conveyor belts, use X-rays instead of magnetism and will not damage a drive.

---

# Optical drive

Your computer includes an optical drive that expands the functionality of the computer. Identify what kind of device is installed in your computer to see its capabilities. The optical drive allows you to read data discs, play music, and watch movies. If your computer includes a Blu-ray Disc ROM Drive, you can also watch high-definition video from disc.

## Identifying the installed optical drive

▲ Select **Start > Computer**.

You will see a list of all the devices installed in your computer, including your optical drive. You may have one of the following types of drives:

- DVD±RW/R and CD-RW Combo Drive with Double-Layer (DL) support
- LightScribe DVD±RW/R and CD-RW Combo Drive with Double-Layer (DL) support
- Blu-ray Disc ROM Drive with SuperMulti DVD±R/RW Double-Layer (DL) support
- LightScribe Blu-ray Disc ROM Drive with SuperMulti DVD±R/RW Double-Layer (DL) support

---

 **NOTE:** Some of the drives listed above may not be supported by your computer.

---



## Using optical discs

An optical drive, such as a DVD-ROM drive, supports optical discs (CDs and DVDs). These discs store information, such as music, photos, and movies. DVDs have a higher storage capacity than CDs.

Your optical drive can read standard CD and DVD discs. If your optical drive is a Blu-ray Disc ROM Drive, it can also read Blu-ray Discs.

 **NOTE:** Some of the optical drives listed may not be supported by your computer. The listed drives are not necessarily all of the supported optical drives.

Some optical drives can also write to optical discs as described in the following table.

Optical drive type	Write to CD-RW	Write to DVD±RW/R	Write to DVD+RW DL	Write label to LightScribe CD or DVD±RW/R
DVD±RW and CD-RW SuperMulti DL Combo Drive	Yes	Yes	Yes	No
DVD±RW and CD-RW SuperMulti DL Combo Drive with LightScribe	Yes	Yes	Yes	Yes
Blu-ray ROM DVD±R/RW SuperMulti DL Drive	Yes	Yes	Yes	No
Blu-ray ROM with LightScribe DVD±R/RW SuperMulti DL Drive	Yes	Yes	Yes	Yes

 **CAUTION:** To prevent possible audio and video degradation, loss of information, or loss of audio or video playback functionality, do not initiate Sleep or Hibernation while reading or writing to a CD or DVD.

## Selecting the right disc (CDs, DVDs, and BDs)

An optical drive supports optical discs (CDs, DVDs, and BDs). CDs, used to store digital data, are also used for commercial audio recordings and are convenient for your personal storage needs. DVDs and BDs are used primarily for movies, software, and data backup purposes. DVDs and BDs are the same form factor as CDs but have a much higher storage capacity.

 **NOTE:** The optical drive on your computer may not support all the types of optical discs discussed in this section.

---

### CD-R discs

Use CD-R (write-once) discs to create a permanent copy of data that can be shared as needed. Typical uses include the following:

- Distributing large presentations
- Sharing scanned and digital photos, video clips, and written data
- Making your own music CDs
- Keeping permanent archives of computer files and scanned home records
- Offloading files from your hard drive to free up disc space

After data is recorded, it cannot be erased or written over.

### CD-RW discs

Use CD-RW discs (a rewritable version of a CD) to store large projects that are updated frequently. Typical uses include the following:

- Developing and maintaining large documents and project files
- Transporting work files
- Making weekly backups of hard drive files
- Updating photos, video, audio, and data continuously

### DVD±R discs

Use blank DVD±R discs to permanently store large amounts of information. After data is recorded, it cannot be erased or written over.

### DVD±RW discs

Use DVD±RW discs if you want to be able to erase or write over data that you saved earlier. This type of disc is ideal for testing audio or video recordings before you burn them to a CD or DVD that cannot be changed.

## LightScribe DVD+R discs

Use LightScribe DVD+R discs for sharing and storing data, home videos, and photos. These discs are read-compatible with most DVD-ROM drives and DVD video players. With a LightScribe-enabled drive and LightScribe software, you can write data to the disc and add a designer label to the outside of the disc.

## Blu-ray Disc (BD)

BD is a high-density optical disc format for the storage of digital information, including high-definition video. A single-layer BD can store 25 GB, over five times the size of the 4.7-GB single-layer DVD. A dual-layer BD can store 50 GB, almost 6 times the size of the 8.5-GB dual-layer DVD.

Typical uses include the following:

- Storage of large amounts of data
- High-definition video playback and storage
- Video games

---

 **NOTE:** Because Blu-ray is a new format containing new technologies, certain disc, digital connection, compatibility, and/or performance issues may arise, and do not constitute defects in the product. Flawless playback on all systems is not guaranteed.

---

## Playing a CD, DVD, or BD

1. Turn on the computer.
2. Press the release button **(1)** on the drive bezel to release the disc tray.
3. Pull out the tray **(2)**.
4. Hold the disc by the edges to avoid touching the flat surfaces and position the disc label side up over the tray spindle.

---

 **NOTE:** If the tray is not fully accessible, tilt the disc carefully to position it over the spindle.

---

5. Gently press the disc (3) down onto the tray spindle until the disc snaps into place.

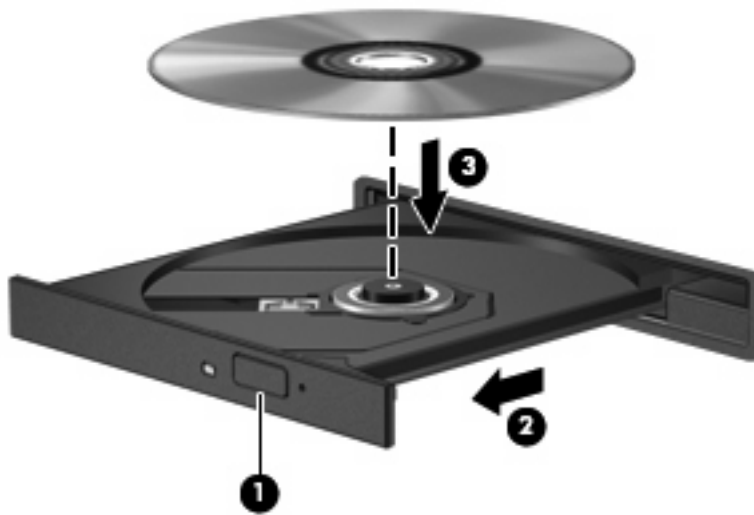

6. Close the disc tray.

If you have not yet configured AutoPlay, as described in the following section, an AutoPlay dialog box opens. It prompts you to select how you want to use the media content.

 **NOTE:** For best results, be sure that your AC adapter is plugged into an external power source while playing a BD.

## Configuring AutoPlay

1. Select **Start > Default Programs > Change AutoPlay settings**.
2. Confirm that the **Use AutoPlay for all media and devices** check box is selected.
3. Click **Choose a default**, and then select one of the available options for each media type listed.

---

 **NOTE:** Choose CyberLink PowerDVD to play DVDs.

---

4. Click **Save**.

---

 **NOTE:** For more information about AutoPlay, refer to Help and Support.

---

## Changing DVD region settings

Most DVDs that contain copyrighted files also contain region codes. The region codes help protect copyrights internationally.

You can play a DVD containing a region code only if the region code on the DVD matches the region setting on your DVD drive.

---

 **CAUTION:** The region settings on your DVD drive can be changed only 5 times.

The region setting you select the fifth time becomes the permanent region setting on the DVD drive.

The number of region changes remaining is displayed on the DVD Region tab.

---

To change settings through the operating system:

1. Select **Start > Control Panel > System and Security**. Then in the System area, click **Device Manager**.

---

 **NOTE:** Windows includes the User Account Control feature to improve the security of your computer. You may be prompted for your permission or password for tasks such as installing software, running utilities, or changing Windows settings. Refer to Help and Support for more information.

---

2. Click the arrow next to **DVD/CD-ROM drives** to expand the list to show all of the installed drives.
3. Right-click the DVD drive for which you want to change region settings, and then click **Properties**.
4. Click the **DVD Region** tab, and change settings.
5. Click **OK**.

## Observing the copyright warning

It is a criminal offense, under applicable copyright laws, to make unauthorized copies of copyright-protected material, including computer programs, films, broadcasts, and sound recordings. Do not use this computer for such purposes.

---

△ **CAUTION:** To prevent loss of information or damage to a disc, observe the following guidelines:

Before writing to a disc, connect the computer to a reliable external power source. Do not write to a disc while the computer is running on battery power.

Before writing to a disc, close all open programs except the disc software you are using.

Do not copy directly from a source disc to a destination disc or from a network drive to a destination disc. Save the information to your hard drive, and then burn from your hard drive to the destination disc.

Do not use the computer keyboard or move the computer while the computer is writing to a disc. The write process is sensitive to vibration.

 **NOTE:** For details about using software included with the computer, refer to the software manufacturer's instructions, which may be provided on disc, in the software Help, or on the manufacturer's Web site.

---

## Copying a CD, DVD, or BD

1. Select **Start > All Programs > CyberLink DVD Suites > Power2Go**.
2. Insert the disc you want to copy into the optical drive.
3. Click **Copy** at the bottom right of the screen.

Power2Go reads the source disc and copies the data to a temporary folder on your hard drive.

4. When prompted, remove the source disc from the optical drive and insert a blank disc into the drive.  
After the information is copied, the disc you created ejects automatically.

## Creating (burning) a CD or DVD

 **NOTE:** Observe the copyright warning. It is a criminal offense, under applicable copyright laws, to make unauthorized copies of copyright-protected material, including computer programs, films, broadcasts, and sound recordings. Do not use this computer for such purposes.

---

If your computer includes a CD-RW, DVD-RW, or DVD±RW optical drive, you can use software such as Windows Media Player or CyberLink Power2Go to burn data, video, and audio files, including MP3 and WAV music files.

Observe the following guidelines when burning a CD or DVD:

- Before burning a disc, save and close any open files and close all programs.
- A CD-R or DVD-R is usually best for burning audio files because after the information is copied, it cannot be changed.

 **NOTE:** You cannot create an audio DVD with CyberLink Power2Go.

---

- Because some home and car stereos will not play CD-RWs, use CD-Rs to burn music CDs.
- A CD-RW or DVD-RW is generally best for burning data files or for testing audio or video recordings before you burn them to a CD or DVD that cannot be changed.
- DVD players used in home systems usually do not support all DVD formats. Refer to the user guide that came with your DVD player for a list of supported formats.
- An MP3 file uses less space than other music file formats, and the process for creating an MP3 disc is the same as the process for creating a data file. MP3 files can be played only on MP3 players or on computers with MP3 software installed.

To burn a CD or DVD, follow these steps:

1. Download or copy the source files into a folder on your hard drive.
2. Insert a blank CD or DVD into the optical drive.
3. Select **Start > All Programs**, and then select the name of the software you want to use.

 **NOTE:** Some programs may be located in subfolders.

---

4. Select the kind of disc you want to create—data, audio, or video.
5. Right-click **Start**, click **Open Windows Explorer**, and then navigate to the folder where the source files are stored.
6. Open the folder, and then drag the files to the drive that contains the blank disc.
7. Initiate the burning process as directed by the program you have selected.

For specific instructions, refer to the software manufacturer's instructions, which may be provided with the software, on disc, or on the manufacturer's Web site.

## Removing a CD, DVD, or BD

1. Press the release button (1) on the drive bezel to release the disc tray, and then gently pull out the tray (2) until it stops.
2. Remove the disc (3) from the tray by gently pressing down on the spindle while lifting the outer edges of the disc. Hold the disc by the edges and avoid touching the flat surfaces.

 **NOTE:** If the tray is not fully accessible, tilt the disc carefully as you remove it.

---

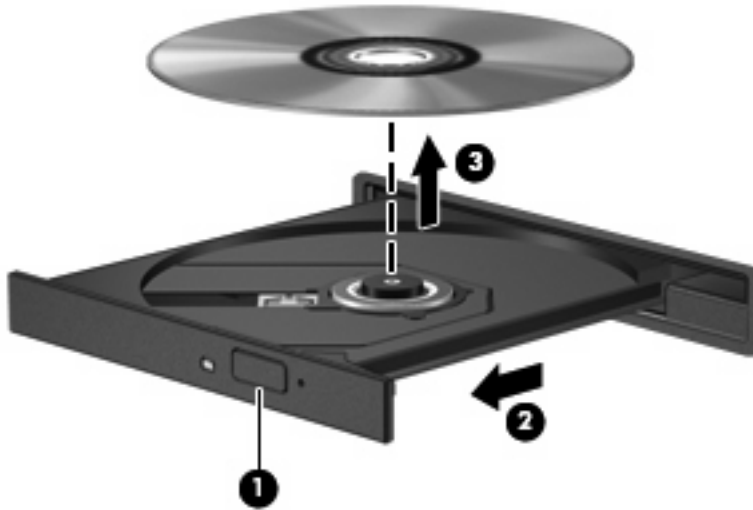

3. Close the disc tray, and then place the disc in a protective case.

## Using external drives

Removable external drives expand your options for storing and accessing information. A USB drive can be added by connecting the drive to a USB port on the computer or on an optional expansion product.

USB drives include the following types:

- 1.44-MB diskette drive
- Hard drive module (a hard drive with an adapter attached)
- DVD-ROM Drive
- DVD/CD-RW Combo Drive
- DVD±RW and CD-RW Combo Drive

 **NOTE:** For more information about required software and drivers, or to learn which computer port to use, refer to the manufacturer's instructions.

---

To connect an external drive to the computer:



△ **CAUTION:** To reduce the risk of damage to the equipment when connecting a powered drive, be sure that the AC power cord is unplugged.

---

1. Connect the drive to the computer.
2. If you are connecting a powered drive, plug the drive power cord into a grounded AC outlet.

To disconnect a powered drive, disconnect it from the computer, and then unplug the AC power cord.

# Improving hard drive performance

## Using Disk Defragmenter

As you use the computer, files on the hard drive become fragmented. Disk Defragmenter consolidates the fragmented files and folders on the hard drive so that the system can run more efficiently.

After you start Disk Defragmenter, it works without supervision. Depending on the size of your hard drive and the number of fragmented files, Disk Defragmenter may take more than an hour to complete. You may want to set it to run during the night or another time when you do not need access to your computer.

HP recommends defragmenting your hard drive at least once a month. You may set Disk Defragmenter to run on a monthly schedule, but you can defragment your computer manually at any time.

To run Disk Defragmenter:

1. Select **Start > All Programs > Accessories > System Tools > Disk Defragmenter**.
2. Click **Defragment disk**.

---

 **NOTE:** Windows® includes the User Account Control feature to improve the security of your computer. You may be prompted for your permission or password for tasks such as installing software, running utilities, or changing Windows settings. Refer to Help and Support for more information.

---

For additional information, refer to the Disk Defragmenter software Help.

## Using Disk Cleanup

Disk Cleanup searches the hard drive for unnecessary files that you can safely delete to free up disk space and help the computer to run more efficiently.

To run Disk Cleanup:

1. Select **Start > All Programs > Accessories > System Tools > Disk Cleanup**.
2. Follow the on-screen instructions.

# Replacing the hard drive

△ **CAUTION:** To prevent information loss or an unresponsive system:

Shut down the computer before removing the hard drive from the hard drive bay. Do not remove the hard drive while the computer is on, in the Sleep state, or in Hibernation.

If you are not sure whether the computer is off or in Hibernation, turn the computer on by pressing the power button. Then shut down the computer through the operating system.

To remove the hard drive:

1. Save your work.
2. Shut down the computer and close the display.
3. Disconnect all external devices connected to the computer.
4. Unplug the power cord from the AC outlet.
5. Turn the computer upside down on a flat surface.
6. Remove the battery from the computer.
7. With the hard drive bay toward you, loosen the hard drive cover screws (1).
8. Lift the hard drive cover away from the computer (2).

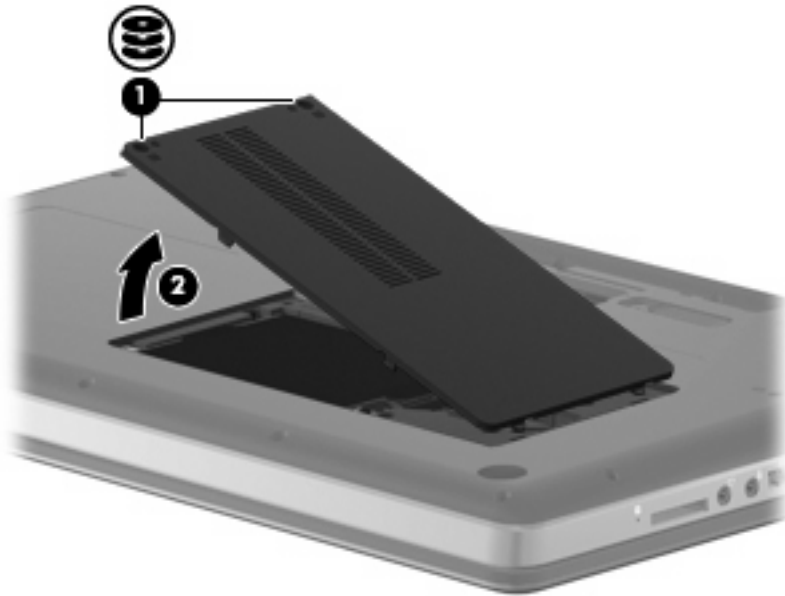

9. Remove the hard drive screws.

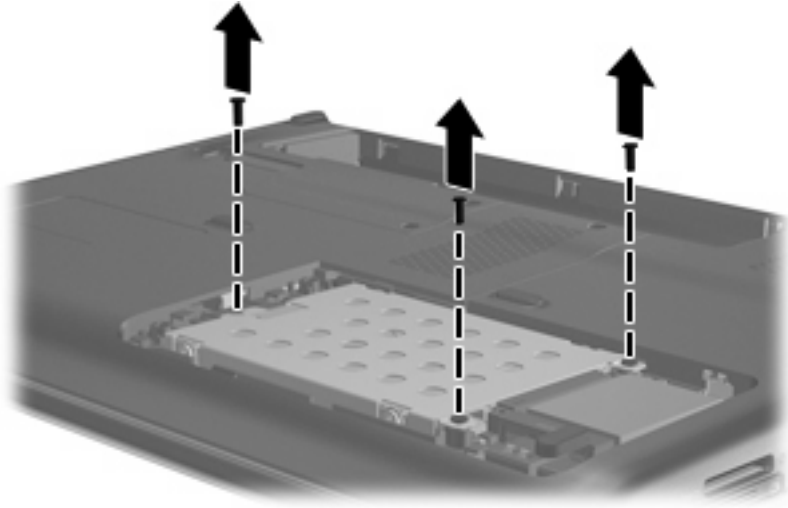

10. Disconnect the hard drive cable from the system board (1) and the cable clip (2).
11. Pull the hard drive tab (3) up, and remove the hard drive from the computer.

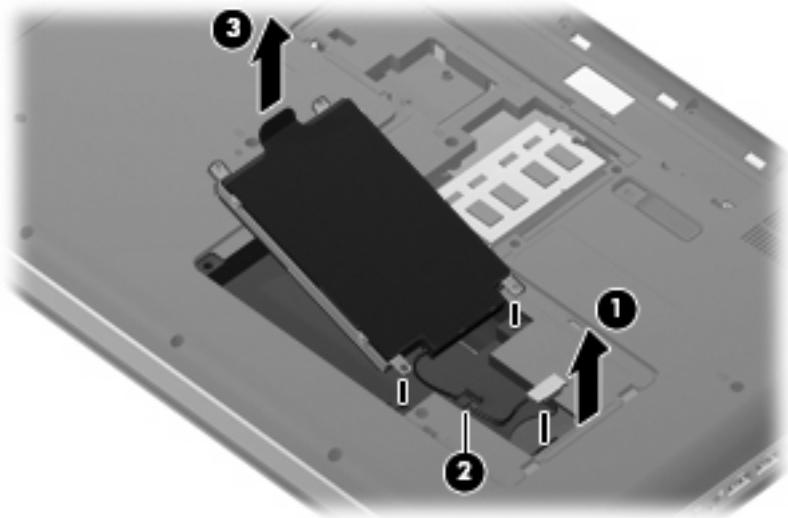

To install the hard drive:

1. Insert the hard drive into the hard drive bay (1), and then press down on the hard drive (2) until it is seated.

2. Secure the hard drive cable beneath the cable clip (3), and then reconnect the hard drive cable to the system board (4).

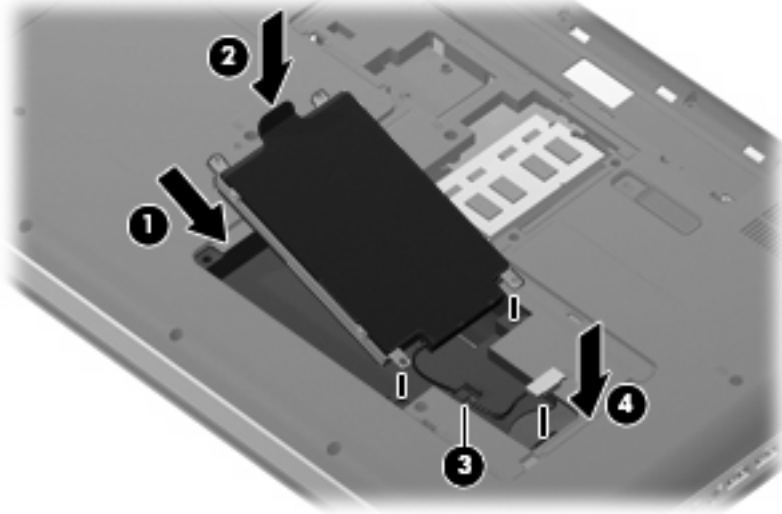

3. Replace the hard drive screws.

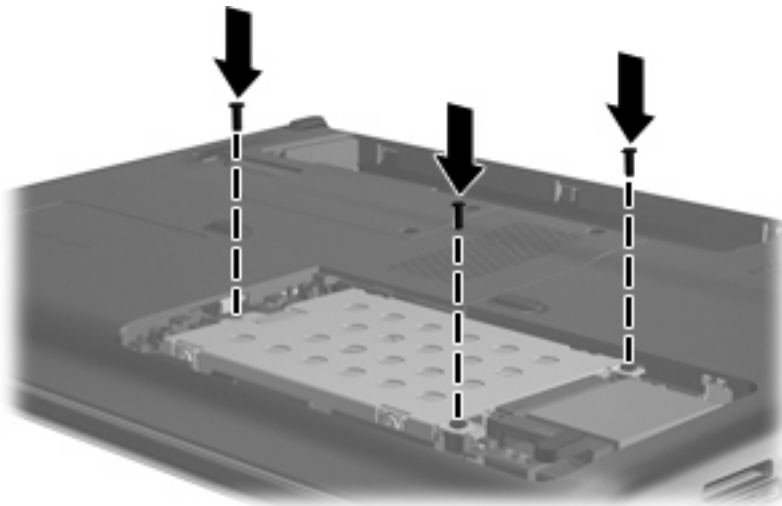

4. Align the tabs (1) on the hard drive cover with the notches on the computer.
5. Close the cover (2).

6. Tighten the hard drive cover screws (3).

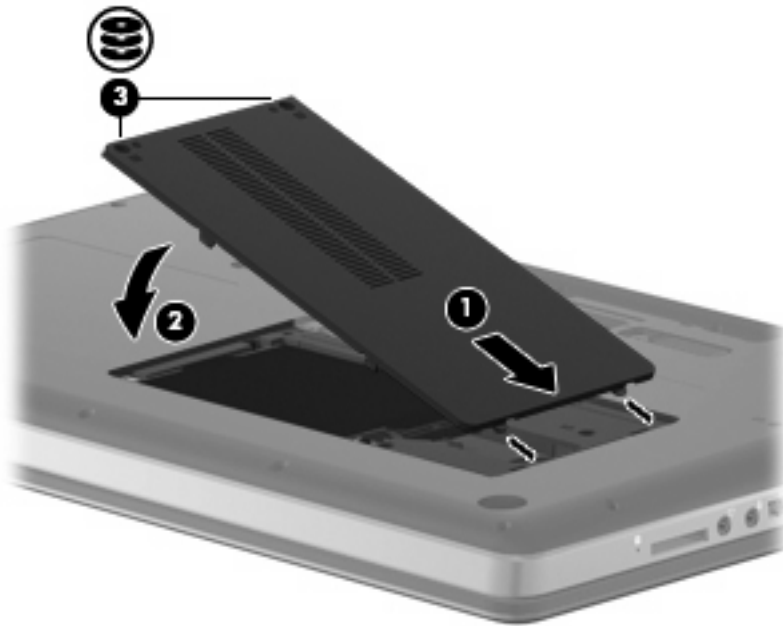

7. Replace the battery.
8. Turn the computer over so the top is facing up.
9. Reconnect power to the computer.
10. Reconnect any external devices.

---

# 7 External devices and external media cards

## Using a USB device

A USB port connects an optional external device, such as a USB keyboard, mouse, drive, printer, scanner, or hub, to the computer.

Some USB devices may require additional support software, which is usually included with the device. For more information about device-specific software, refer to the manufacturer's instructions.

The computer has 3 USB ports, which support USB 1.0, USB 1.1, and USB 2.0 devices. To add more USB ports, connect an optional hub.

## Connecting a USB device

---

△ **CAUTION:** To prevent damage to a USB connector, use minimal force to connect a USB device.

▲ To connect a USB device to the computer, connect the USB cable for the device to the USB port.



You will hear a sound when the device has been detected.

---

📄 **NOTE:** The first time you connect a USB device, the "Installing device driver software" message is displayed in the notification area, at the far right of the taskbar.

---

## Removing a USB device

△ **CAUTION:** To prevent loss of information or an unresponsive system, use the following procedure to safely remove a USB device.

**CAUTION:** To prevent damage to a USB connector, do not pull on the cable to remove the USB device.

To remove a USB device:

1. Click the **Safely Remove Hardware and Eject Media** icon in the notification area, at the far right of the taskbar.

 **NOTE:** To display the Safely Remove Hardware and Eject Media icon, click the **Show hidden icons** icon (the arrow at the left of the notification area).

2. Click the name of the device in the list.

 **NOTE:** You are prompted that it is safe to remove the device.

△ **CAUTION:** To prevent damage to a USB connector, do not pull on the cable to remove the USB device.

3. Remove the device.



## Using Digital Media Slot cards

Optional digital cards provide secure data storage and convenient data sharing. These cards are often used with digital media-equipped cameras and PDAs as well as with other computers.

The Digital Media Slot supports the following digital card formats:

- Memory Stick (MS)
- Memory Stick Pro (MSP)
- MultiMediaCard (MMC)
- Secure Digital (SD) Memory Card
- xD-Picture Card (XD)

### Inserting a digital card

△ **CAUTION:** To avoid damaging the digital card or the computer, do not insert any type of adapter into the Digital Media Slot.

**CAUTION:** To prevent damage to the digital card connectors, use minimal force to insert a digital card.

1. Hold the digital card label side up, with the connectors facing the computer.
2. Insert the card into the Digital Media Slot, and then push in on the card until it is firmly seated.

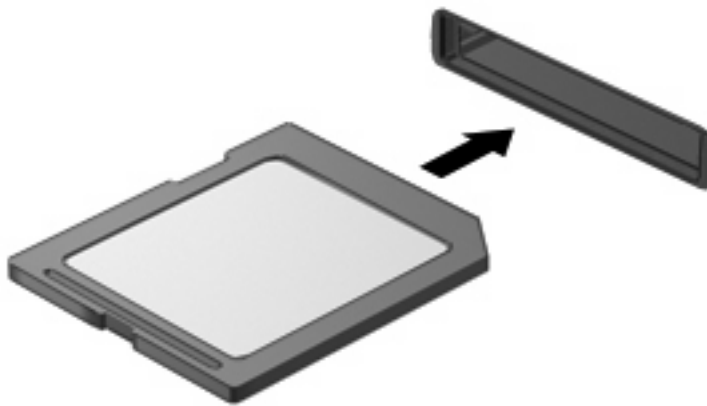

You will hear a sound when the device has been detected, and a menu of options may be displayed.

## Removing a digital card

△ **CAUTION:** To prevent loss of data or an unresponsive system, use the following procedure to safely remove the digital card.

Save your information and close all programs associated with the digital card.

📝 **NOTE:** To stop a data transfer, click **Cancel** in the operating system Copying window.

To remove a digital card:

1. Click the **Safely Remove Hardware and Eject Media** icon in the notification area, at the far right of the taskbar.

📝 **NOTE:** To display the Safely Remove Hardware and Eject Media icon, click the **Show hidden icons** icon (the arrow at the left side of the notification area).

2. Click the name of the digital card in the list.

📝 **NOTE:** You are notified that it is safe to remove the hardware device.

3. Press in on the digital card (1), and then remove the card from the slot (2).

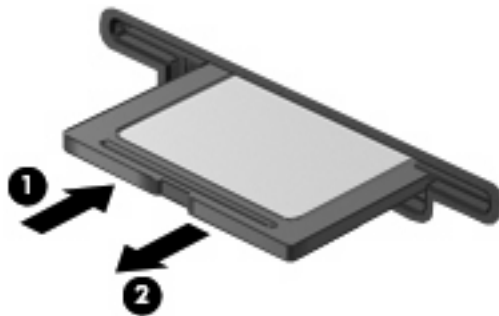

---

## 8 Adding or replacing a memory module

The computer has one memory module compartment, which is located on the bottom of the computer. The memory capacity of the computer can be upgraded by adding a memory module to the vacant expansion memory module slot or by upgrading the existing memory module in the primary memory module slot.

- 
- ⚠ **WARNING!** To reduce the risk of electric shock and damage to the equipment, unplug the power cord and remove all batteries before installing a memory module.
  - ⚠ **CAUTION:** Electrostatic discharge (ESD) can damage electronic components. Before beginning any procedure, ensure that you are discharged of static electricity by touching a grounded metal object.
  - 📝 **NOTE:** To use a dual-channel configuration when adding a second memory module, be sure that both memory modules are the same capacity.
- 

To add or replace a memory module:

1. Save your work.
2. Shut down the computer and close the display.

If you are not sure whether the computer is off or in Hibernation, turn the computer on by pressing the power button. Then shut down the computer through the operating system.

3. Disconnect all external devices connected to the computer.
4. Unplug the power cord from the AC outlet.
5. Turn the computer upside down on a flat surface.
6. Remove the battery from the computer.
7. Loosen the 3 memory module compartment screws **(1)**.

8. Lift the memory module compartment cover (2) away from the computer.

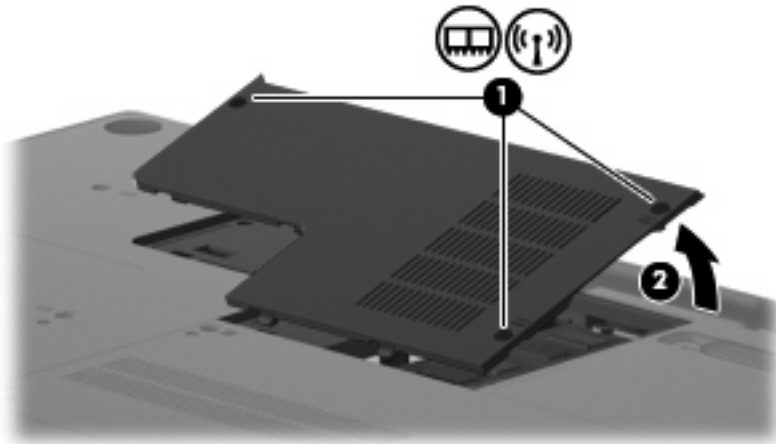

9. If you are replacing a memory module, remove the existing memory module:

- a. Pull the retention clips (1) away from the sides of the memory module.

The memory module tilts up.

△ **CAUTION:** To prevent damage to the memory module, hold the memory module by the edges only. Do not touch the components on the memory module.

- b. Grasp the edge of the memory module (2), and gently pull the module out of the memory module slot.

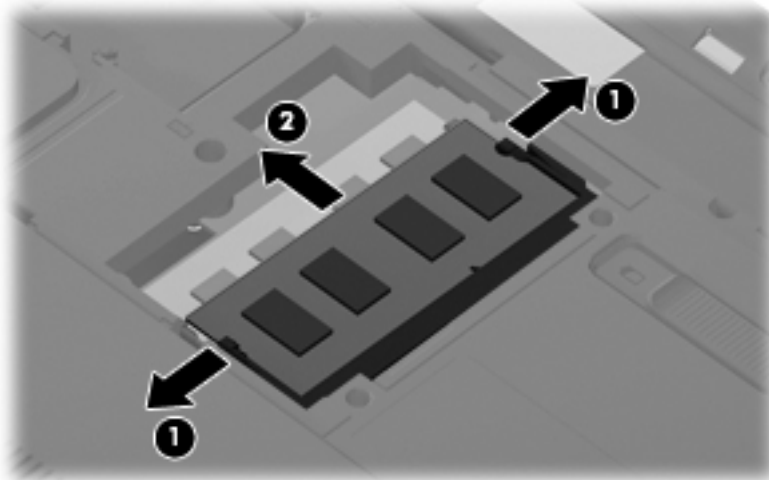

- c. To protect a memory module after removal, place it in an electrostatic-safe container.

10. Insert a new memory module:

△ **CAUTION:** To prevent damage to the memory module, hold the memory module by the edges only. Do not touch the components on the memory module, and do not bend the memory module.

- a. Align the notched edge (1) of the memory module with the tab in the memory module slot.
- b. With the memory module at a 45-degree angle from the surface of the memory module compartment, press the module (2) into the memory module slot until it is seated.
- c. Gently press the memory module (3) down, applying pressure to both the left and right edges of the memory module, until the retention clips snap into place.

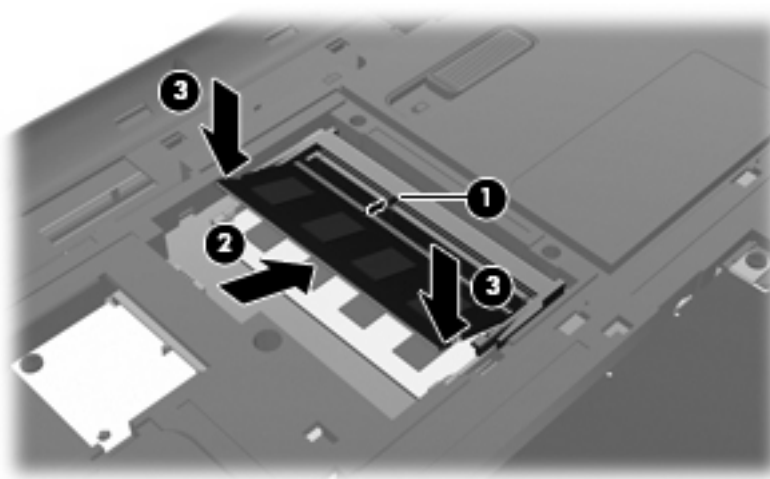

11. Align the tabs (1) on the memory module compartment cover with the notches on the computer.
12. Close the cover (2).
13. Tighten the 3 memory module compartment screws (3).

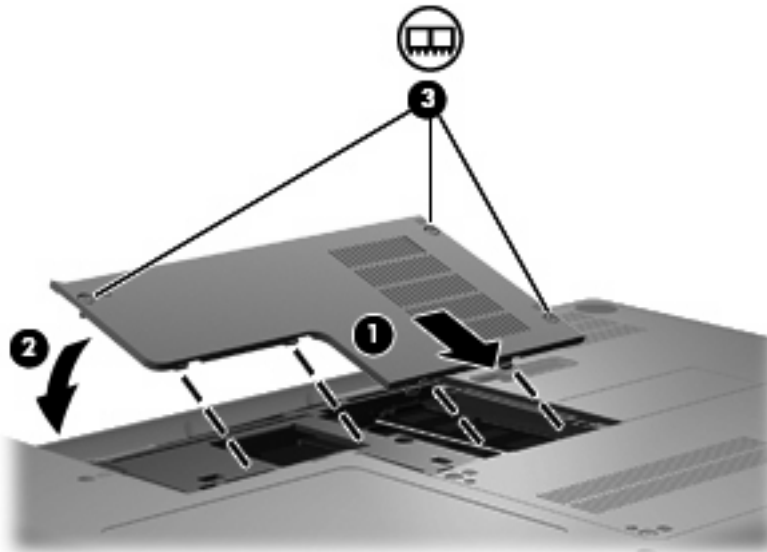

14. Replace the battery.
15. Turn the computer right-side up, and then reconnect external power and external devices.
16. Turn on the computer.

# 9 Security

## Protecting the computer

Standard security features provided by the Windows operating system and the non-Windows Setup Utility can protect your personal settings and data from a variety of risks.

Follow the procedures in this guide to use the following features:

- Passwords
- Antivirus software
- Firewall software
- Critical security updates
- Optional security cable

 **NOTE:** Security solutions are designed to act as deterrents, but they may not deter software attacks or prevent the computer from being mishandled or stolen.

**NOTE:** Before you send your computer for service, remove all password settings.

Computer risk	Security feature
Unauthorized use of the computer	<ul style="list-style-type: none"><li>• QuickLock</li><li>• Power-on password</li></ul>
Computer viruses	Norton Internet Security software
Unauthorized access to data	<ul style="list-style-type: none"><li>• Firewall software</li><li>• Windows updates</li></ul>
Unauthorized access to Setup Utility, BIOS settings, and other system identification information	Administrator password
Ongoing or future threats to the computer	Critical security updates from Microsoft
Unauthorized access to a Windows user account	User password
Unauthorized removal of the computer	Security cable slot (used with an optional security cable)

# Using passwords

A password is a group of characters that you choose to secure your computer information. Several types of passwords can be set, depending on how you want to control access to your information. Passwords can be set in Windows or in the non-Windows Setup Utility preinstalled on the computer.

△ **CAUTION:** To prevent being locked out of the computer, record each password you set. Because most passwords are not displayed as they are set, changed, or deleted, it is essential to record each password immediately and store it in a secure place.

You can use the same password for a Setup Utility feature and for a Windows security feature. You can also use the same password for more than one Setup Utility feature.

Use the following guidelines when setting a password in Setup Utility:

- A password can be any combination of up to eight letters and numbers and is case sensitive.
- If the password was set in Setup Utility, you must enter the password at a Setup Utility prompt. If the password was set in Windows, you must enter the password at a Windows prompt.

Use the following tips for creating and saving passwords:

- When creating passwords, follow requirements set by the program.
- Write down your passwords and store them in a secure place away from the computer.
- Do not store passwords in a file on the computer.
- Do not use your name or other personal information that could be easily discovered by an outsider.

The following sections list Windows and Setup Utility passwords and describe their functions. For additional information about Windows passwords, such as screen-saver passwords, select **Start > Help and Support**.

## Setting passwords in Windows

Password	Function
Administrator password	Protects administrator-level access to computer contents. <b>NOTE:</b> This password cannot be used to access Setup Utility contents.
User password	Protects access to a Windows user account. It also protects access to the computer contents and must be entered when you exit Sleep or Hibernation.

## Setting passwords in Setup Utility

Password	Function
Administrator password*	<ul style="list-style-type: none"><li>• Protects access to Setup Utility.</li><li>• After the password is set, you must enter the password each time you access Setup Utility.</li></ul> <b>CAUTION:</b> If you forget your administrator password, you cannot access Setup Utility.

Password	Function
Power-on password*	<ul style="list-style-type: none"> <li>Protects access to the computer contents.</li> <li>After the password is set, you must enter the password each time you turn on the computer, restart the computer, or exit Hibernation.</li> </ul> <p><b>CAUTION:</b> If you forget your power-on password, you cannot turn on or restart the computer, or exit Hibernation.</p>

\*For details about each of these passwords, refer to the following topics.

## Administrator password

Your administrator password protects the configuration settings and system identification information in Setup Utility. After this password is set, you must enter it each time you access Setup Utility.

Your administrator password is not interchangeable with an administrator password set in Windows, nor is it displayed as it is set, entered, changed, or deleted. Be sure that you record your password and store it in a safe place.

### Managing an administrator password

To set, change, or delete this password, follow these steps:

1. Open Setup Utility by turning on or restarting the computer. While the “Press the ESC key for Startup Menu” message is displayed in the lower-left corner of the screen, press **f10**.

– or –

Open Setup Utility by turning on or restarting the computer. While the “Press the ESC key for Startup Menu” message is displayed in the lower-left corner of the screen, press **esc**. When the Startup Menu is displayed, press **f10**.

2. Use the arrow keys to select **Security > Set Administrator Password**, and then press **enter**.
  - To set an administrator password, enter your password in the **Enter New Password** and **Confirm New Password** fields, and then press **enter**.
  - To change an administrator password, enter your current password in the **Enter Current Password** field, enter a new password in the **Enter New Password** and **Confirm New Password** fields, and then press **enter**.
  - To delete an administrator password, enter your current password in the **Enter Password** field, and then press **enter** four times.
3. To save your changes and exit Setup Utility, use the arrow keys to select **Exit > Exit Saving Changes**.

Your changes go into effect when the computer restarts.

### Entering an administrator password

At the **Enter Password** prompt, enter your administrator password, and then press **enter**. After three unsuccessful attempts to enter the administrator password, you must restart the computer and try again.



## Power-on password

Your power-on password prevents unauthorized use of the computer. Once set, you must enter the password each time you turn on the computer, restart the computer, or exit Hibernation. A power-on password is not displayed as it is set, entered, changed, or deleted.

### Managing a power-on password

To set, change, or delete this password, follow these steps:

1. Open Setup Utility by turning on or restarting the computer. While the “Press the ESC key for Startup Menu” message is displayed in the lower-left corner of the screen, press **f10**.  
  
– or –  
  
Open Setup Utility by turning on or restarting the computer. While the “Press the ESC key for Startup Menu” message is displayed in the lower-left corner of the screen, press **esc**. When the Startup Menu is displayed, press **f10**.
2. Use the arrow keys to select **Security > Set Power-On Password**, and then press **enter**.
  - To set a power-on password, enter your password in the **Enter New Password** and **Confirm New Password** fields, and then press **enter**.
  - To change a power-on password, enter your current password in the **Enter Current Password** field, enter a new password in the **Enter New Password** and **Confirm New Password** fields, and then press **enter**.
  - To delete a power-on password, enter your current password in the **Enter Current Password** field, and then press **enter** four times.
3. To save your changes and exit Setup Utility, use the arrow keys to select **Exit > Exit Saving Changes**.

Your changes go into effect when the computer restarts.

### Entering a power-on password

At the **Enter Password** prompt, enter your password, and then press **enter**. After three unsuccessful attempts to enter the password, you must restart the computer and try again.

## Using antivirus software

When you use the computer to access e-mail, a network, or the Internet, you expose it to computer viruses. Computer viruses can disable the operating system, programs, or utilities, or cause them to function abnormally.

Antivirus software can detect most viruses, destroy them, and in most cases, repair any damage they have caused. To provide ongoing protection against newly discovered viruses, antivirus software must be kept up to date.

Norton Internet Security, an antivirus program, is preinstalled on the computer. The software includes 60 days of free updates. It is strongly recommended that you protect the computer against new viruses beyond 60 days by purchasing extended update service. Instructions for using and updating Norton Internet Security software and for purchasing extended update service are provided within the program. To view and access Norton Internet Security, select **Start > All Programs > Norton Internet Security**.

For more information about computer viruses, enter `viruses` in the Search box in Help and Support.

## Using firewall software

When you use the computer for e-mail, network, or Internet access, unauthorized persons may be able to gain access to the computer, your personal files, and information about you. Use the firewall software preinstalled on the computer to protect your privacy.

Firewall features include logging and reporting of network activity, and automatic monitoring of all incoming and outgoing traffic. Refer to the firewall user guide or contact your firewall manufacturer for more information.

---

 **NOTE:** Under some circumstances a firewall can block access to Internet games, interfere with printer or file sharing on a network, or block authorized e-mail attachments. To temporarily resolve the problem, disable the firewall, perform the task that you want to perform, and then reenable the firewall. To permanently resolve the problem, reconfigure the firewall.

---

## Installing critical security updates

△ **CAUTION:** Microsoft sends alerts regarding critical updates. To protect the computer from security breaches and computer viruses, install all critical updates from Microsoft as soon as you receive an alert.

Updates to the operating system and other software may have become available after the computer was shipped. To be sure that all available updates are installed on the computer, observe these guidelines:

- Run Windows Update as soon as possible after you set up your computer. Use the update link at **Start > All Programs > Windows Update**.
- Run Windows Update monthly thereafter.
- Obtain updates to Windows and other Microsoft® programs, as they are released, from the Microsoft Web site and through the updates link in Help and Support.

## Installing an optional security cable

📄 **NOTE:** A security cable is designed to act as a deterrent, but it may not prevent the computer from being mishandled or stolen.

1. Loop the security cable around a secured object.
2. Insert the key (1) into the cable lock (2).
3. Insert the cable lock into the security cable slot on the computer (3), and then lock the cable lock with the key.

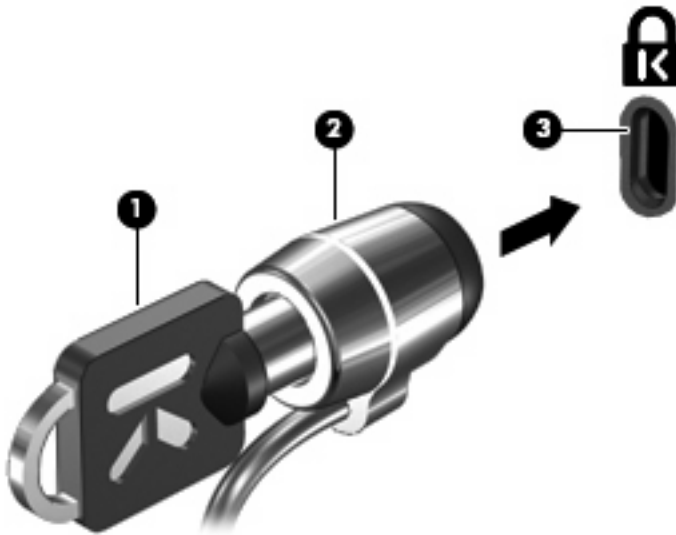

📄 **NOTE:** The location of the security cable slot varies by computer model.

---

# A Setup Utility (BIOS)

## Starting Setup Utility

Setup Utility is a ROM-based information and customization utility that can be used even when your Windows operating system is not working.

The utility reports information about the computer and provides settings for startup, security, and other preferences.

To start Setup Utility:

- ▲ Open Setup Utility by turning on or restarting the computer. While the “Press the ESC key for Startup Menu” message is displayed in the lower-left corner of the screen, press **f10**.

– or –

1. Open Setup Utility by turning on or restarting the computer. While the “Press the ESC key for Startup Menu” message is displayed in the lower-left corner of the screen, press **esc**.
2. When the Startup Menu is displayed, press **f10**.

# Using Setup Utility

## Changing the language of Setup Utility

The following procedure explains how to change the language of Setup Utility. If Setup Utility is not already running, begin at step 1. If Setup Utility is already running, begin at step 2.

1. Open Setup Utility by turning on or restarting the computer. While the “Press the ESC key for Startup Menu” message is displayed in the lower-left corner of the screen, press **f10**.  
– or –  
Open Setup Utility by turning on or restarting the computer. While the “Press the ESC key for Startup Menu” message is displayed in the lower-left corner of the screen, press **esc**. When the Startup Menu is displayed, press **f10**.
2. Use the arrow keys to select **System Configuration > Language**, and then press **enter**.
3. Use the arrow keys to select a language, and then press **enter**.
4. When a confirmation prompt with your language selected is displayed, press **enter**.
5. To save your change and exit Setup Utility, use the arrow keys to select **Exit > Exit Saving Changes**, and then press **enter**.

Your change goes into effect immediately.

## Navigating and selecting in Setup Utility

Because Setup Utility is not Windows based, it does not support the TouchPad. Navigation and selection are by keystroke.

- To choose a menu or a menu item, use the arrow keys.
- To choose an item in a list or to toggle a field, for example an Enable/Disable field, use the arrow keys or **f5** and **f6**.
- To select an item, press **enter**.
- To close a text box or return to the menu display, press **esc**.
- To display additional navigation and selection information while Setup Utility is open, press **f1**.

## Displaying system information

The following procedure explains how to display system information in Setup Utility. If Setup Utility is not open, begin at step 1. If Setup Utility is open, begin at step 2.

1. Open Setup Utility by turning on or restarting the computer. While the “Press the ESC key for Startup Menu” message is displayed in the lower-left corner of the screen, press **f10**.

– or –

Open Setup Utility by turning on or restarting the computer. While the “Press the ESC key for Startup Menu” message is displayed in the lower-left corner of the screen, press **esc**. When the Startup Menu is displayed, press **f10**.

2. Select the **Main** menu. System information such as the system time and date, and identification information about the computer is displayed.
3. To exit Setup Utility without changing any settings, use the arrow keys to select **Exit > Exit Discarding Changes**, and then press **enter**.

## Restoring default settings in Setup Utility

The following procedure explains how to restore Setup Utility default settings. If Setup Utility is not already running, begin at step 1. If Setup Utility is already running, begin at step 2.

1. Open Setup Utility by turning on or restarting the computer. While the “Press the ESC key for Startup Menu” message is displayed in the lower-left corner of the screen, press **f10**.

– or –

Open Setup Utility by turning on or restarting the computer. While the “Press the ESC key for Startup Menu” message is displayed in the lower-left corner of the screen, press **esc**. When the Startup Menu is displayed, press **f10**.

2. Use the arrow keys to select **Exit > Load Setup Defaults**, and then press **enter**.
3. When the Setup Confirmation is displayed, press **enter**.
4. To save your change and exit Setup Utility, use the arrow keys to select **Exit > Exit Saving Changes**, and then press **enter**.

Setup Utility default settings go into effect when the computer restarts.

---

 **NOTE:** Your password, security, and language settings are not changed when you restore the factory default settings.

---

## Exiting Setup Utility

You can exit Setup Utility with or without saving changes.

- To exit Setup Utility and save your changes from the current session:

If the Setup Utility menus are not visible, press **esc** to return to the menu display. Then use the arrow keys to select **Exit > Exit Saving Changes**, and then press **enter**.

- To exit Setup Utility without saving your changes from the current session:

If the Setup Utility menus are not visible, press **esc** to return to the menu display. Then use the arrow keys to select **Exit > Exit Discarding Changes**, and then press **enter**.

After either choice, the computer restarts in Windows.

## Setup Utility menus

The menu tables in this section provide an overview of Setup Utility options.

 **NOTE:** Some of the Setup Utility menu items listed in this chapter may not be supported by your computer.

### Main menu

Select	To do this
System information	<ul style="list-style-type: none"><li>• View and change the system time and date.</li><li>• View identification information about the computer.</li><li>• View specification information about the processor, memory size, system BIOS, and keyboard controller version (select models only).</li></ul>

### Security menu

Select	To do this
Administrator password	Enter, change, or delete an administrator password.
Power-On Password	Enter, change, or delete a power-on password.

## System Configuration menu

Select	To do this
Language Support	Change the language of Setup Utility.
Button Sound (select models only)	Enable/disable the capacitive button tapping sound.
Virtualization Technology (select models only)	Enable/disable the processor Virtualization Technology.
Processor C6 State (select models only)	Enable/disable the processor state.
LAN Power Saving (select models only)	Enable/disable LAN Power Saving. When enabled, saves power when the computer is in DC mode.
Card Reader/1394 Power Saving (select models only)	Enable/disable Card Reader/1394 Power Saving.
Fan Always On	Enable/disable Fan Always On. When enabled, the computer fan will always be on.
Action Keys Mode	Enable/disable Action Keys Mode.
Boot Options	Set the following boot options: <ul style="list-style-type: none"><li>• <b>f10</b> and <b>f12</b> Delay (sec.)—Set the delay for the <b>f10</b> and <b>f12</b> functions of Setup Utility in intervals of 5 seconds each (0, 5, 10, 15, 20).</li><li>• CD-ROM Boot—Enable/disable boot from CD-ROM.</li><li>• Floppy Boot—Enable/disable boot from diskette.</li><li>• Internal Network Adapter Boot—Enable/disable boot from the internal network adapter.</li><li>• Boot Order—Set the boot order for:<ul style="list-style-type: none"><li>◦ Notebook Hard Drive</li><li>◦ Internal CD/DVD ROM Drive</li><li>◦ USB disk on Key/USB Hard disk</li><li>◦ USB CD/DVD ROM Drive</li><li>◦ USB Floppy</li><li>◦ Network Adapter</li></ul></li></ul>

## Diagnostics menu

Select	To do this
Hard Disk Self Test	Run a comprehensive self-test on the hard drive.  <b>NOTE:</b> On models with two hard drives, this menu option is called the <b>Primary Hard Disk Self Test</b> .
Secondary Hard Disk Self Test (select models only)	Run a comprehensive self-test on a secondary hard drive.
Memory Test	Run a diagnostic test on the system memory.



---

## B Software updates

Updated versions of the software provided with your computer may be available on the HP Web site.

Most software and BIOS updates on the HP Web site are packaged in compressed files called *SoftPaqs*.

Some download packages contain a file named Readme.txt, which contains information regarding installing and troubleshooting the file.

To update the software, follow these steps:

1. Identify your computer model, product category, and series or family. Prepare for a system BIOS update by identifying the BIOS version currently installed on the computer.

If your computer is connected to a network, consult the network administrator before installing any software updates, especially system BIOS updates.

---

 **NOTE:** The computer system BIOS is stored on the system ROM. The BIOS initializes the operating system, determines how the computer will interact with the hardware devices, and provides for data transfer among hardware devices, including the time and date.

**NOTE:** Windows includes the User Account Control feature to improve the security of your computer. You may be prompted for your permission or password for tasks such as installing software, running utilities, or changing Windows settings. Refer to Help and Support for more information.

---

2. Access the updates on the HP Web site at <http://www.hp.com>.
3. Install the updates.

# Updating the BIOS

To update the BIOS, first determine what BIOS version you currently have, and then download and install the new BIOS.

## Determining the BIOS version

To determine whether available BIOS updates contain later BIOS versions than those currently installed on the computer, you need to know the version of the system BIOS currently installed.

BIOS version information (also known as *ROM date* and *System BIOS*) can be displayed by pressing **fn+esc** (if you are already in Windows) or by opening Setup Utility.

To use Setup Utility for displaying BIOS information:

1. Open Setup Utility by turning on or restarting the computer. While the “Press the ESC key for Startup Menu” message is displayed in the lower-left corner of the screen, press **f10**.
2. If Setup Utility does not open with the system information displayed, use the arrow keys to select the **Main** menu.

When the Main menu is selected, BIOS and other system information is displayed.

3. To exit Setup Utility, use the arrow keys to select **Exit > Exit Discarding Changes**, and then press **enter**.

## Downloading a BIOS update

- △ **CAUTION:** To prevent damage to the computer or an unsuccessful installation, download and install a BIOS update only when the computer is connected to reliable external power using the AC adapter. Do not download or install a BIOS update while the computer is running on battery power or connected to an optional power source. During the download and installation, follow these instructions:

Do not disconnect power from the computer by unplugging the power cord from the AC outlet.

Do not shut down the computer or initiate Sleep or Hibernation.

Do not insert, remove, connect, or disconnect any device, cable, or cord.

---

To download a BIOS update:

1. Access the page on the HP Web site that provides software for your computer:  
Select **Start > Help and Support > Maintain > Software Updates**.
2. Follow the instructions on the screen to identify your computer and access the BIOS update you want to download.
3. At the download area, follow these steps:
  - a. Identify the BIOS update that is later than the BIOS version currently installed on your computer. Make a note of the date, name, or other identifier. You may need this information to locate the update later, after it has been downloaded to your hard drive.
  - b. Follow the instructions on the screen to download your selection to the hard drive.

Make a note of the path to the location on your hard drive where the BIOS update will be downloaded. You will need to access this path when you are ready to install the update.

-  **NOTE:** If you connect your computer to a network, consult the network administrator before installing any software updates, especially system BIOS updates.
- 

BIOS installation procedures vary. Follow any instructions that are displayed on the screen after the download is complete. If no instructions are displayed, follow these steps:

1. Open Windows Explorer by selecting **Start > Computer**.
2. Double-click your hard drive designation. The hard drive designation is typically Local Disk (C:).
3. Using the hard drive path you recorded earlier, open the folder on your hard drive that contains the update.
4. Double-click the file that has an .exe extension (for example, *filename.exe*).
5. Complete the installation by following the instructions on the screen.

The BIOS installation begins.

The system automatically shuts down after the BIOS has successfully updated.

-  **NOTE:** After a message on the screen reports a successful installation, you can delete the downloaded file from your hard drive.
-

# Updating programs and drivers

To download and install software other than a BIOS update, follow these steps:

To use the HP Web site:

1. Open your web browser, go to <http://www.hp.com/support>, and then select your country or region.
2. Click the option for software and driver downloads, enter your computer model number in the Search box, and then press [enter](#).
3. Click your specific product from the models listed.
4. Select your operating system.
5. When the list of drivers is displayed, click an updated driver to open a window containing additional information.
6. Click **Install now** to install the updated driver.

---

 **NOTE:** In some locations you may be able to download the driver and install it later. To do this, click **Download only** to save the file to your computer. When prompted, click **Save**, and then select a storage location on your hard drive. After the file is downloaded, navigate to the folder where the file was stored, and double-click the file to install.

---

7. If prompted to do so, restart your computer after the installation is complete, and then verify the operation of the device.

---

## C Backup and recovery

Recovery after a system failure is as complete as your most current backup. HP recommends that you create recovery discs immediately after software setup. As you add new software and data files, you should continue to back up your system on a regular basis to maintain a reasonably current backup.

Tools provided by the operating system and HP Recovery Manager software are designed to help you with the following tasks for safeguarding your information and restoring it in case of a system failure:

- Creating a set of recovery discs (Recovery Manager software feature). Recovery discs are used to start up (boot) your computer and restore the operating system and software programs to factory settings in case of system failure or instability.
- Backing up your information regularly to protect your important system files.
- Creating system restore points (operating system feature). System restore points allow you to reverse undesirable changes to your computer by restoring the computer to an earlier state.
- Recovering a program or driver (Recovery Manager software feature). This feature helps you reinstall a program or driver without performing a full system recovery.
- Performing a full system recovery (Recovery Manager software feature). With Recovery Manager, you can recover your full factory image if you experience system failure or instability. Recovery Manager works from a dedicated recovery partition (select models only) on the hard drive or from recovery discs you create.

---

 **NOTE:** If your computer includes a solid-state drive (SSD), you may not have a recovery partition. Recovery discs have been included for computers that do not have a partition. Use these discs to recover your operating system and software. To check for the presence of a recovery partition, select **Start > Computer**. If the partition is present, an HP Recovery drive is listed in the Hard Disk Drives section of the window.

---

## Creating recovery disc

HP recommends that you create recovery discs to be sure that you can restore your system to its original factory state if you experience serious system failure or instability. Create these discs after setting up the computer for the first time.

Handle these discs carefully and keep them in a safe place. The software allows the creation of only one set of recovery discs.

---

 **NOTE:** If your computer does not include an internal optical drive, you can use an optional external optical drive (purchased separately) to create recovery discs, or you can purchase recovery discs for your computer from the HP Web site.

**NOTE:** The external hard drive must be connected to a USB port on the computer, not to a USB port on an external device such as a hub.

---

Note the following guidelines before creating recovery discs:

- You will need high-quality DVD-R, DVD+R, BD-R (writable Blu-ray), or CD-R discs. All these discs are purchased separately. DVDs and BDs have a much higher capacity than CDs. If you use CDs, up to 20 discs may be required, whereas only a few DVDs or BDs are required.

---

 **NOTE:** Read-write discs, such as CD-RW, DVD±RW, double-layer DVD±RW, and BD-RE (rewritable Blu-ray) discs, are not compatible with the Recovery Manager software.

---

- The computer must be connected to AC power during this process.
- Only one set of recovery discs can be created per computer.
- Number each disc before inserting it into the optical drive.
- If necessary, you can exit the program before you have finished creating the recovery discs. The next time you open Recovery Manager, you will be prompted to continue the disc creation process.

To create a set of recovery discs:

1. Select **Start > All Programs > Recovery Manager > Recovery Disk Creation**.
2. Follow the on-screen instructions.

# Backing up your information

As you add new software and data files, you should back up your system on a regular basis to maintain a reasonably current backup. Back up your system at the following times:

- At regularly scheduled times

---

 **NOTE:** Set reminders to back up your information periodically.

---

- Before the computer is repaired or restored
- Before you add or modify hardware or software

Note the following when backing up:

- Create system restore points using the Windows System Restore feature, and periodically copy them to disc.
- Store personal files in the Documents library and back up this folder periodically.
- Back up templates stored in their associated programs.
- Save customized settings in a window, toolbar, or menu bar by taking a screen shot of your settings. The screen shot can be a time-saver if you have to reset your preferences.

To copy the screen and paste it into a word processing document, follow these steps:

1. Display the screen.
  2. Copy the screen:  
To copy only the active window, press **alt+prt sc**.  
To copy the entire screen, press **prt sc**.
  3. Open a word processing document, and then select **Edit > Paste**.
  4. Save the document.
- You can back up your information to an optional external hard drive, a network drive, or discs.
  - When backing up to discs, use any of the following types of discs (purchased separately): CD-R, CD-RW, DVD+R, DVD-R, or DVD±RW. The discs you use will depend on the type of optical drive installed in your computer.

---

 **NOTE:** DVDs store more information than CDs, so using them for backup reduces the number of recovery discs required.

---

- When backing up to discs, number each disc before inserting it into the optical drive of the computer.

## Using Windows Backup and Restore

To create a backup using Windows Backup and Restore, follow these steps:

---

 **NOTE:** Be sure that the computer is connected to AC power before you start the backup process.

**NOTE:** The backup process may take over an hour, depending on file size and the speed of the computer.

---

1. Select **Start > All Programs > Maintenance > Backup and Restore**.
2. Follow the on-screen instructions to set up and create a backup.

---

 **NOTE:** Windows includes the User Account Control feature to improve the security of your computer. You may be prompted for your permission or password for tasks such as installing software, running utilities, or changing Windows settings. Refer to Help and Support for more information.

---



## Using system restore points

When you back up your system, you are creating a system restore point. A system restore point allows you to save and name a snapshot of your hard drive at a specific point in time. You can then recover back to that point if you want to reverse subsequent changes made to your system.

 **NOTE:** Recovering to an earlier restore point does not affect data files that were saved or e-mails that were created since the last restore point.

---

You also can create additional restore points to provide increased protection for your system files and settings.

## When to create restore points

- Before you add or extensively modify software or hardware
- Periodically, whenever the system is performing optimally

 **NOTE:** If you revert to a restore point and then change your mind, you can reverse the restoration.

---

## Create a system restore point

1. Select **Start > Control Panel > System and Security > System**.
2. In the left pane, click **System Protection**.
3. Click the **System Protection** tab.
4. Under **Protection Settings**, select the disk for which you want to create a restore point.
5. Click **Create**.
6. Follow the on-screen instructions.

## Restore to a previous date and time

To revert to a restore point (created at a previous date and time), when the computer was functioning optimally, follow these steps:

1. Select **Start > Control Panel > System and Security > System**.
2. In the left pane, click **System protection**.
3. Click the **System Protection** tab.
4. Click **System Restore**.
5. Follow the on-screen instructions.

## Performing a recovery

 **NOTE:** You can recover only files that you have previously backed up. HP recommends that you use HP Recovery Manager to create a set of recovery discs (entire drive backup) as soon as you set up your computer.

---

Recovery Manager software allows you to repair or restore the system if you experience system failure or instability. Recovery Manager works from recovery discs or from a dedicated recovery partition (select models only) on the hard drive. However, if your computer includes a solid-state drive (SSD), you may not have a recovery partition. If that is the case, recovery discs have been included with your computer. Use these discs to recover your operating system and software.

 **NOTE:** Windows has its own built-in repair features, such as System Restore. If you have not already tried these features, try them before using Recovery Manager.

**NOTE:** Recovery Manager recovers only software that was preinstalled at the factory. Software not provided with this computer must be downloaded from the manufacturer's Web site or reinstalled from the disc provided by the manufacturer.

---

## Recovering using the recovery discs

To restore the system from the recovery discs:

1. Back up all personal files.
2. Insert the first recovery disc into the optical drive and restart the computer.
3. Follow the on-screen instructions.

## Recovering using the dedicated recovery partition (select models only)

 **NOTE:** Computers with an SSD may not have a recovery partition. If the computer does not have a recovery partition, you will not be able to recover using this procedure. Recovery discs have been included for computers that do not have a partition. Use these discs to recover your operating system and software.

---

On some models, you can perform a recovery from the partition on the hard drive, accessed by pressing either the Start button or **f11**. This restores the computer to its factory condition.

To restore the system from the partition, follow these steps:

1. Access Recovery Manager in either of the following ways:
  - Select **Start > All Programs > Recovery Manager > Recovery Manager**.
  - or –
  - Turn on or restart the computer, and then press **esc** while the “Press the ESC key for Startup Menu” message is displayed at the bottom of the screen. Then press **f11** while the “Press <F11> for recovery” message is displayed on the screen.
2. Click **System Recovery** in the **Recovery Manager** window.
3. Follow the on-screen instructions.

# Index

## Symbols/Numerics

1394 Power Saving 102

## A

AC adapter

- connecting 57
- identifying 11
- testing 58

AC adapter light, identifying 6

action keys

- identifying 5
- media control 39
- muting/restoring speaker volume 38
- volume down 37
- volume mute 37
- volume up 37

adjusting webcam properties 46

administrator password

- creating 94
- entering 94
- managing 94

airport security devices 69

antennas 9

antivirus software 96

applications key, Windows 5

audio devices, connecting

- external 42

audio features 41

audio functions, checking 42

audio-in (microphone) jack 37

audio-out (headphone) jack 37

AutoPlay 75

## B

backing up

- customized window, toolbar, and menu bar settings 109
- personal files 109
- templates 109

battery

- calibrating 63
- charging 61, 63
- conserving power 66
- discharging 62
- disposing 67
- identifying 11
- inserting 60
- low battery levels 62
- recharging 65
- removing 60
- replacing 67
- storing 66

battery bay, identifying 8

Battery Check 59

battery light 61, 62

battery power 59

battery release latch,

- identifying 8, 60

battery temperature 66

bays

- battery 8
- hard drive 8

BIOS, updating 104

Blu-ray Disc (BD)

- copying 76
- playing 73
- removing 48, 78

Blu-ray ROM DVD±R/RW

- SuperMulti DL Drive 71

Blu-ray ROM with LightScribe

- DVD±R/RW SuperMulti DL Drive 71

Bluetooth device 13, 19

Bluetooth label 12

boot options 102

boot order 102

button sound 102

buttons

- power 4
- TouchPad right/left 28

## C

cables

- HDMI 43
- LAN 27
- modem 23
- security 97
- USB 85

calibrating battery 63

caps lock light, identifying 3

Card Reader Power Saving 102

CD

- burning 77
- copying 76
- playing 73
- removing 48, 78

CD drive 78

Certificate of Authenticity label 12

changing the language of Setup

- Utility 99

charging batteries 61, 63

checking audio functions 42

compartments

- memory module 8

components

- additional hardware 11
- bottom 8
- display 9
- left-side 7
- right-side 6
- top 2

connecting to a WLAN 18

connection, external power 57

connector, power 6

conservation, power 66

controls

- TouchPad 2

copyright warning 76  
cord, power 11  
corporate WLAN connection 18  
country-specific modem cable  
  adapter 24  
critical battery level 62  
critical updates, software 97  
CyberLink PowerDVD 40

## D

device drivers  
  HP drivers 50  
  Windows drivers 51  
Diagnostics menu 102  
digital card  
  defined 87  
  inserting 87  
  removing 88  
  stopping 88  
digital dual array microphone,  
  identifying 37  
Digital Media Slot, identifying 7  
disc drive 78  
disc performance 80  
Disk Cleanup software 80  
Disk Defragmenter software 80  
displaying system  
  information 100  
drive media 52  
drives  
  boot order 102  
  caring for 69  
DVD  
  burning 77  
  changing region setting 75  
  copying 76  
  playing 73  
  removing 48, 78  
DVD drive 78  
DVD region settings 75  
DVD±RW and CD-RW SuperMulti  
  DL Combo Drive 71  
DVD±RW and CD-RW SuperMulti  
  DL Combo Drive with  
  LightScribe 71

## E

earbuds 37  
encryption 17

entering a power-on  
  password 95  
entering an administrator  
  password 94  
esc key, identifying 5  
exiting Setup Utility 101  
external audio devices,  
  connecting 42  
external drive 78  
external monitor port,  
  identifying 7

## F

f11 112  
fan always on 102  
firewall 17  
firewall software 96  
fn key, identifying 5  
full system recovery 107

## H

hard drive  
  installing 82  
  removing 81  
  replacing 81  
hard drive bay, identifying 8  
hard drive self test 102  
HDMI port, identifying 7, 43  
HDMI, connecting 43  
headphone (audio-out) jack 37  
headphones 37  
Hibernation  
  exiting 53  
  initiated during critical battery  
  level 62  
  initiating 53  
high-definition devices,  
  connecting 43  
hubs 85

## I

icons  
  network 14, 21  
  wired network 14  
  wireless 14  
integrated numeric keypad keys,  
  identifying 5  
integrated webcam light,  
  identifying 9  
integrated webcam, identifying 9  
interference, minimizing 22

internal digital dual array  
  microphone, identifying 37  
internal microphones,  
  identifying 9  
Internet connection setup 16  
issues, resolving 48

## J

jacks  
  audio-in (microphone) 37  
  audio-out (headphone) 37  
  RJ-11 (modem) 6  
  RJ-45 (network) 7

## K

keypad, external  
  num lock 34  
  using 34  
keypad, integrated  
  identifying 34  
keys  
  action 5  
  esc 5  
  fn 5  
  Windows applications 5  
  Windows logo 5  
keys, integrated numeric  
  keypad 5

## L

labels  
  Bluetooth 12  
  Microsoft Certificate of  
  Authenticity 12  
  modem approval 12  
  service tag 12  
  wireless certification 12  
  WLAN 12  
LAN Power Saving 102  
language support 102  
latch, battery release 8  
lights  
  caps lock 3  
  num lk 3  
  num lock 34  
  optical drive 6  
  power 3, 6  
  TouchPad 2, 28  
  webcam 9  
  webcam light 9  
  wireless 3

- local area network (LAN)
  - cable required 27
  - connecting cable 27
- low battery level 62
- M**
- Main menu 101
- maintenance
  - Disk Cleanup 80
  - Disk Defragmenter 80
- managing a power-on password 95
- managing an administrator password 94
- media activity action keys 39
- memory module
  - adding 89
  - inserting 90
  - removing 90
  - replacing 89
  - upgrading 89
- memory module compartment
  - cover
    - removing 90
    - replacing 91
- memory module compartment, identifying 8
- memory test 102
- microphone, internal 9, 37
- Microsoft Certificate of Authenticity label 12
- minimizing interference 22
- modem approval label 12
- modem cable
  - connecting 23
  - country-specific cable adapter 24
  - noise suppression circuitry 23
- modem software
  - setting/adding location 24
  - travel connection problems 26
- monitor port, external 7
- mouse properties, setting pointing device preferences 31
- multimedia components, identifying 37
- multimedia software, installing 40
- N**
- navigating in Setup Utility 99
- network cable
  - connecting 27
  - noise suppression circuitry 27
- network icons 14, 21
- network key 21
- network security codes
  - network key 21
  - SSID 21
- noise suppression circuitry
  - modem cable 23
  - network cable 27
- num lk light, identifying 3
- num lock light, identifying 34
- num lock, external keypad 34
- O**
- operating system
  - Microsoft Certificate of Authenticity label 12
  - Product Key 12
- optical disc
  - playing 73
  - removing 78
- optical drive light, identifying 6
- optical drive, using 45, 70
- P**
- passwords
  - administrator 94
  - power-on 95
  - set in Setup Utility 93
  - set in Windows 93
- performing a recovery 112
- pointing devices, setting preferences 31
- ports
  - external monitor 7
  - HDMI 7, 43
  - USB 6, 7, 85
- power
  - connecting 57
  - conserving 66
- power button, identifying 4
- power connector, identifying 6
- power cord, identifying 11
- power light, identifying 3
- power-on password
  - creating 95
  - entering 95
  - managing 95
- Processor C6 State 102
- Product Key 12
- product name and number, computer 12
- programs, updating 106
- public WLAN connection 18
- R**
- readable media 52
- recovering a program or driver 107
- recovering using the dedicated recovery partition 112
- recovering using the recovery discs 112
- recovery disc 107, 108
- Recovery Manager 107, 112
- recovery partition 107
- recovery, system 112
- region codes, DVD 75
- regulatory information
  - modem approval label 12
  - wireless certification labels 12
- restore points 111
- restoring default settings 100
- RJ-11 (modem) jack, identifying 6
- RJ-45 (network) jack, identifying 7
- S**
- scrolling 29
- secondary hard drive self test 102
- security
  - features 92
  - passwords 93
- security cable 97
- security cable slot, identifying 6
- Security menu 101
- security, wireless 17
- selecting in Setup Utility 99
- serial number, computer 12
- service tag 12
- setup of WLAN 16
- Setup Utility, passwords set in 93
- shutdown 68
- shutting down 68

- Sleep
    - exiting 53
    - initiating 53
  - slots
    - Digital Media 7
    - security cable 6
  - software
    - antivirus 96
    - critical updates 97
    - Disk Cleanup 80
    - Disk Defragmenter 80
    - firewall 96
    - installing 40
    - multimedia 40
    - Windows Media Player 40
    - Wireless Assistant 15
  - solid-state drive (SSD) 107, 112
  - speakers, identifying 4, 37
  - starting Setup Utility 98
  - storing battery 66
  - supported discs 108
  - System Configuration menu 102
  - system failure or instability 107
  - system information 101
  - system recovery 112
  - system restore points 107, 111
- T**
- temperature 66
  - TouchPad controls 2, 28
  - Touchpad gestures, using 29
  - TouchPad off indicator, identifying 2, 3, 28
  - TouchPad zone
    - identifying 2, 28
  - TouchPad, turning on and off 29
  - TouchPad, using 29
  - traveling with the computer
    - modem approval label 12
    - wireless certification labels 12
  - troubleshooting
    - disc burning 49
    - disc play 48
    - DVD movie play 49
    - external display 49
    - HP device drivers 50
    - modem 26
    - optical disc tray 48
    - Windows device drivers 51
  - turning off the computer 68
  - two-finger scrolling 29
- U**
- unresponsive system 68
  - USB cable, connecting 85
  - USB devices
    - connecting 85
    - description 85
    - removing 86
  - USB hubs 85
  - USB ports, identifying 6, 7, 85
  - using Setup Utility 99
  - using system restore 111
- V**
- vents, identifying 7, 8
  - video, using 42
  - Virtualization Technology 102
  - volume down action key 37
  - volume mute action key 37
  - volume up action key 37
  - volume, adjusting 38
- W**
- webcam
    - adjusting properties 46
    - tips 46
    - using 46
  - webcam light 37
  - Windows applications key, identifying 5
  - Windows logo key, identifying 5
  - Windows, passwords set in 93
  - wireless action key
    - locating 14
    - using 14
  - wireless antennas 9
  - Wireless Assistant software 14, 15
  - wireless certification label 12
  - wireless controls
    - button 14
    - operating system 14
    - Wireless Assistant software 14
  - wireless devices, types 13
  - wireless icon 14
  - wireless light, identifying 3, 14
  - wireless local area network (WLAN), identifying 8
  - wireless network (WLAN)
    - connecting 18
    - corporate WLAN
      - connection 18
    - described 13
    - equipment needed 16
    - functional range 18
    - public WLAN connection 18
    - security 17
  - WLAN device 12
  - WLAN label 12
  - writable media 52

