



Notebook PC User Guide

© Copyright 2010 Hewlett-Packard
Development Company, L.P.

Bluetooth is a trademark owned by its proprietor and used by Hewlett-Packard Company under license. SD Logo is a trademark of its proprietor. Microsoft and Windows are U.S. registered trademarks of Microsoft Corporation.

The information contained herein is subject to change without notice. The only warranties for HP products and services are set forth in the express warranty statements accompanying such products and services. Nothing herein should be construed as constituting an additional warranty. HP shall not be liable for technical or editorial errors or omissions contained herein.

First Edition: March 2010

Document Part Number: 595485-002

Product notice

This user guide describes features that are common to most models. Some features may not be available on your computer.

To obtain the latest information in the *Notebook PC User Guide*, go to the HP Web site at <http://www.hp.com/support>.

Safety warning notice

-
- ⚠ **WARNING!** To reduce the possibility of heat-related injuries or of overheating the computer, do not place the computer directly on your lap or obstruct the computer air vents. Use the computer only on a hard, flat surface. Do not allow another hard surface, such as an adjoining optional printer, or a soft surface, such as pillows or rugs or clothing, to block airflow. Also, do not allow the AC adapter to contact the skin or a soft surface, such as pillows or rugs or clothing, during operation. The computer and the AC adapter comply with the user-accessible surface temperature limits defined by the International Standard for Safety of Information Technology Equipment (IEC 60950).
-

Table of contents

1 Features	1
Identifying hardware	1
Components	2
Top components	2
TouchPad	2
Lights	3
Button and speakers	4
Keys	5
Display	6
Right-side components	7
Left-side components	8
Bottom components	9
Wireless antennas	10
Additional hardware components	11
Labels	12
2 Wireless, local area network, and modem	13
Using wireless devices	13
Identifying wireless and network status icons	14
Using the wireless controls	14
Using the wireless action key	14
Using HP Wireless Assistant	15
Using operating system controls	15
Using a WLAN	16
Setting up a WLAN	16
Protecting your WLAN	17
Connecting to a WLAN	18
Roaming to another network	18
Using Bluetooth wireless devices (select models only)	19
Bluetooth and Internet Connection Sharing (ICS)	19
Troubleshooting wireless connection problems	20
Cannot connect to a WLAN	20
Cannot connect to a preferred wireless network	21
Network icon is not displayed	21

Current network security codes are unavailable	21
WLAN connection is very weak	22
Cannot connect to the wireless router	22
Connecting to a local area network	22

3 Pointing devices and keyboard 24

Using the TouchPad	24
Turning the TouchPad on and off	24
Using TouchPad gestures	25
Scrolling	25
Pinching	25
Rotating	26
Setting pointing device preferences	26
Connecting an external mouse	27
Using the keyboard	27
Using the action keys	27
Using the hotkey	28
Cleaning the TouchPad and keyboard	29

4 Multimedia 30

Multimedia features	30
Identifying your multimedia components	30
Adjusting the volume	32
Using the media activity action keys	33
Multimedia software	34
Using CyberLink PowerDVD 8 software	34
Using other preinstalled multimedia software	34
Installing multimedia software from a disc	34
Audio	35
Connecting external audio devices	35
Checking your audio functions	35
Video	36
Connecting an external monitor or projector	36
Connecting an HDMI device (select models only)	37
Configuring audio for HDMI (select models only)	38
Optical drive	39
Identifying the installed optical drive	39
Using optical discs	40
Selecting the right disc	41
CD-R discs	41
CD-RW discs	41
DVD±R discs	41
DVD±RW discs	41

LightScribe DVD+R discs	42
Blu-ray Disc	42
Playing a CD, DVD, or BD	42
Configuring AutoPlay	44
Changing DVD region settings	44
Observing the copyright warning	45
Copying a CD or DVD	45
Creating (burning) a CD or DVD	46
Removing an optical disc (CD, DVD, or BD)	47
Removing the optical drive	48
Webcam (select models only)	51
Webcam tips	51
Adjusting webcam properties	52
Troubleshooting	53
The optical disc tray does not open for removal of a CD, DVD, or BD	53
The computer does not detect the optical drive	54
A disc does not play	55
A disc does not play automatically	55
A movie stops, skips, or plays erratically	56
A movie is not visible on an external display	56
The process of burning a disc does not begin, or it stops before completion	56
A DVD playing in Windows Media Player produces no sound or display	57
A device driver must be reinstalled	57
Obtaining the latest HP device drivers	58
Obtaining the latest Windows device drivers	58
5 Power management	59
Setting power options	59
Using power-saving states	59
Initiating and exiting Sleep	59
Initiating and exiting Hibernation	60
Using the battery meter	60
Using power plans	60
Viewing the current power plan	61
Selecting a different power plan	61
Customizing power plans	61
Setting password protection upon exiting Sleep or Hibernation	61
Using external AC power	62
Connecting the AC adapter	62
Testing an AC adapter	63
Using battery power	63
Displaying the remaining battery charge	64
Finding battery information in Help and Support	64

Using Battery Check	64
Inserting or removing the battery	64
Charging a battery	65
Maximizing battery discharge time	66
Managing low battery levels	66
Identifying low battery levels	66
Resolving a low battery level	67
Resolving a low battery level when external power is available	67
Resolving a low battery level when a charged battery is available	67
Resolving a low battery level when no power source is available	67
Resolving a low battery level when the computer cannot exit Hibernation	67
Calibrating a battery	67
Step 1: Fully charge the battery	67
Step 2: Disable Hibernation and Sleep	68
Step 3: Discharge the battery	68
Step 4: Fully recharge the battery	69
Step 5: Reenable Hibernation and Sleep	69
Conserving battery power	69
Storing a battery	69
Disposing of a used battery	70
Replacing the battery	70
Shutting down the computer	70
6 Drives	72
Handling drives	72
Using external drives	73
Improving hard drive performance	74
Using Disk Defragmenter	74
Using Disk Cleanup	74
Replacing the hard drive	75
7 External devices and external media cards	79
Using a USB device	79
Connecting a USB device	79
Removing a USB device	80
Using Digital Media Slot cards	81
Inserting a digital card	81
Removing a digital card	82
8 Memory modules	83

9 Security	87
Protecting the computer	87
Using passwords	87
Setting passwords in Windows	88
Setting passwords in Setup Utility	88
Administrator password	89
Managing an administrator password	89
Entering an administrator password	89
Power-on password	89
Managing a power-on password	90
Entering a power-on password	90
Using antivirus software	91
Using firewall software	92
Installing critical updates	93
10 Setup Utility (BIOS)	94
Starting Setup Utility	94
Using Setup Utility	95
Changing the language of Setup Utility	95
Navigating and selecting in Setup Utility	95
Displaying system information	96
Restoring default settings in Setup Utility	96
Exiting Setup Utility	97
Setup Utility menus	97
Main menu	97
Security menu	97
System Configuration menu	98
Diagnostics menu	98
11 Software updates	99
Updating the BIOS	100
Determining the BIOS version	100
Downloading a BIOS update	101
Updating programs and drivers	102
12 Backup and recovery	103
Creating recovery discs	104
Backing up your information	105
Using Windows Backup and Restore	106
Using system restore points	107
When to create restore points	107
Create a system restore point	107
Restore to a previous date and time	107

Performing a recovery	108
Recovering from the recovery discs	108
Recovering from the dedicated recovery partition (select models only)	108

Index	109
--------------------	------------

1 Features

Identifying hardware

To see a list of hardware installed in the computer, follow these steps:

- ▲ Select **Start > Control Panel > System and Security**. Then, in the **System** area, check **Device Manager**.

You can also add hardware or modify device configurations using Device Manager.

 **NOTE:** Windows® includes the User Account Control feature to improve the security of your computer. You may be prompted for your permission or password for tasks such as installing software, running utilities, or changing Windows settings. Refer to Help and Support for more information.

Components

Top components

TouchPad

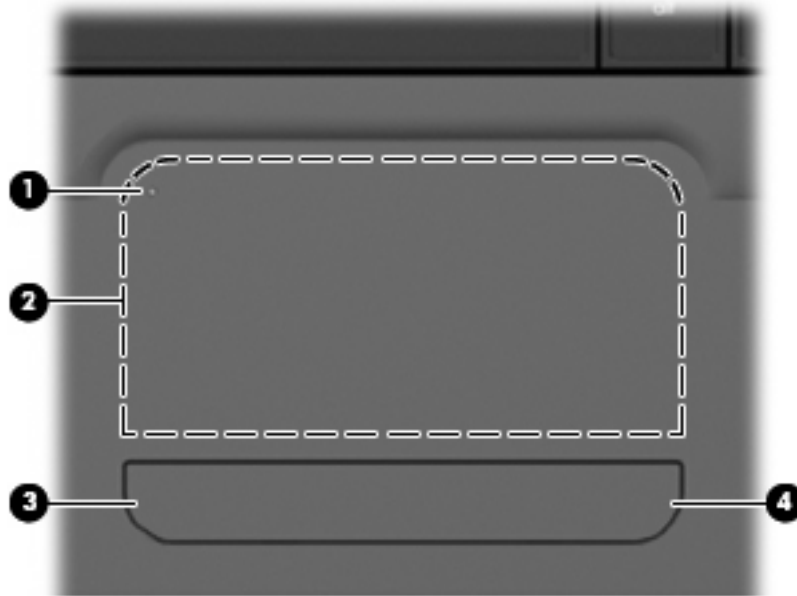



Component	Description
(1)  TouchPad off indicator	To switch the TouchPad zone on and off, quickly double-tap the TouchPad off indicator. NOTE: When the TouchPad zone is active, the light is off.
(2) TouchPad zone	Moves the pointer and selects or activates items on the screen.
(3) Left TouchPad button	Functions like the left button on an external mouse.
(4) Right TouchPad button	Functions like the right button on an external mouse.

There is an unmarked scroll zone inside the right edge of the TouchPad. To scroll up and down using the TouchPad vertical scroll zone, slide your finger up or down inside the right edge of the TouchPad. For more information about TouchPad features, refer to "Using the TouchPad" section later in this guide.

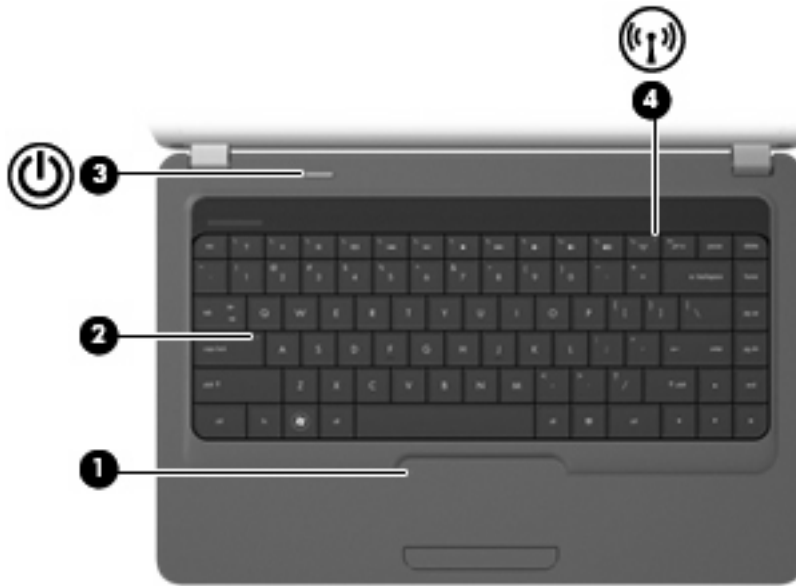
Lights



Component	Description
(1) TouchPad light	<ul style="list-style-type: none"> On: The TouchPad is disabled. Off: The TouchPad is enabled.
(2) Caps lock light	On: Caps lock is on.
(3)  Power light	<ul style="list-style-type: none"> On: The computer is on. Blinking: The computer is in the Sleep state. Off: The computer is off or in Hibernation.
(4)  Wireless light	<ul style="list-style-type: none"> White: An integrated wireless device, such as a wireless local area network (WLAN) device and/or a Bluetooth® device, is on. Amber: All wireless devices are off.



Button and speakers

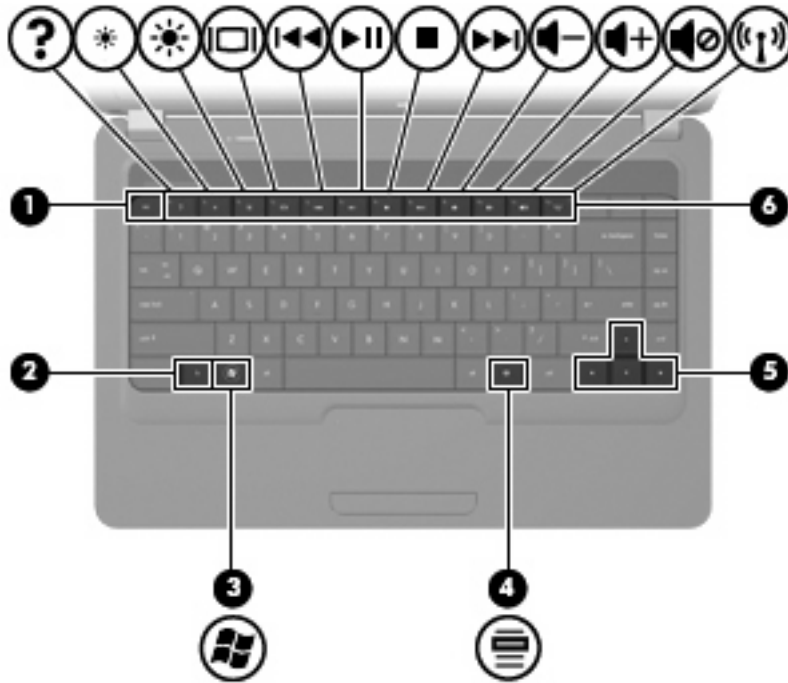

Component	Description
(1) Speakers (2)	Produce sound.
(2) Power button	<ul style="list-style-type: none">• When the computer is off, press the button to turn on the computer.• When the computer is on, press the button briefly to initiate Sleep.• When the computer is in the Sleep state, briefly press the button to exit Sleep.• When the computer is in Hibernation, briefly press the button to exit Hibernation. <p>If the computer has stopped responding and Windows® shutdown procedures are ineffective, press and hold the power button for at least 5 seconds to turn off the computer.</p> <p>To learn more about your power settings, select Start > Control Panel > System and Security > Power Options.</p>

Keys



Component	Description
(1) <code>esc</code> key	Displays system information when pressed in combination with the <code>fn</code> key.
(2) <code>fn</code> key	Displays system information when pressed in combination with the <code>esc</code> key.
(3)  Windows logo key	Displays the Windows Start menu.
(4)  Windows applications key	Displays a shortcut menu for items beneath the pointer.
(5) Navigation keys	Navigate using the Up, Down, Left and Right arrow keys.
(6) Action keys	Execute frequently used system actions.



Display



Component	Description
(1) Internal microphone	Records sound.
(2) Integrated webcam (select models only)	Records audio and video and captures still photographs.
(3) Integrated webcam light (select models only)	On: The integrated webcam is in use.

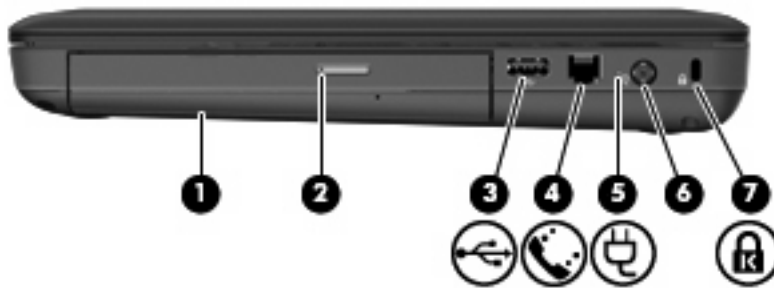





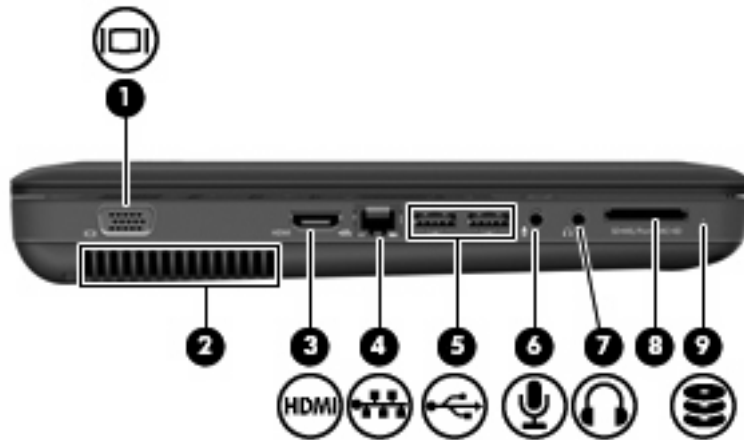

Right-side components



Component	Description
(1) Optical drive	Reads and writes to optical discs.
(2) Optical drive light	Blinking: The optical drive is being accessed.
(3)  USB port	Connects an optional USB device.
(4) RJ-11 (modem) jack (select models only)	Connects a modem cable.
(5) AC adapter/power/battery light	<ul style="list-style-type: none">• White: The computer is connected to external power and the battery is fully charged.• Blinking white: The computer is in the Sleep state.• Amber: A battery is charging.
(6)  Power connector	Connects an AC adapter.
(7)  Security cable slot	Attaches an optional security cable to the computer. NOTE: The security cable is designed to act as a deterrent, but it may not prevent the computer from being mishandled or stolen.





Left-side components

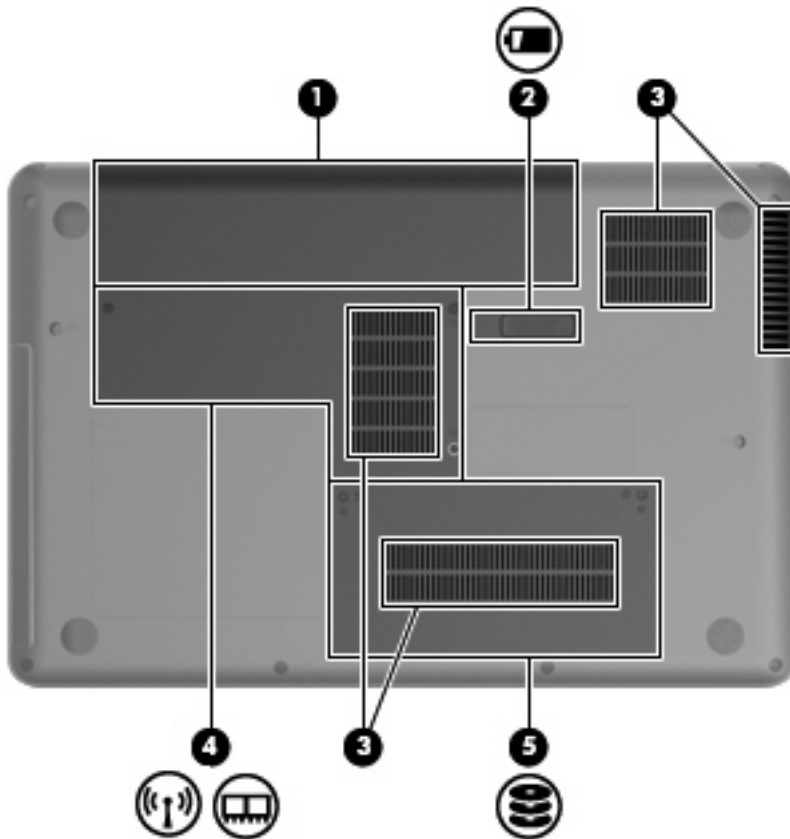

Component	Description
(1) 	External monitor port Connects an external VGA monitor or projector.
(2) 	Vent Enables airflow to cool internal components. NOTE: The computer fan starts up automatically to cool internal components and prevent overheating. It is normal for the internal fan to cycle on and off during routine operation.
(3) 	HDMI port (select models only) Connects an optional video or audio device, such as a high-definition television, or any compatible digital or audio component.
(4) 	RJ-45 (network) jack Connects a network cable.
(5) 	USB ports (2) Connects optional USB devices.
(6) 	Audio-in (microphone) jack Connects an optional computer headset microphone, stereo array microphone, or monaural microphone.
(7) 	Audio-out (headphone) jack Produces sound when connected to optional powered stereo speakers, headphones, earbuds, a headset, or television audio.
(8) 	Digital Media Slot (select models only) Supports the following optional digital card formats: <ul style="list-style-type: none"> • Memory Stick (MS) • Memory Stick Pro (MSP) • MultiMediaCard (MMC) • Secure Digital (SD) Memory Card • xD-Picture Card (XD)
(9) 	Drive light On: The hard drive is in use.

Bottom components



Component	Description
(1)	Battery bay Holds the battery.
(2) 	Battery release latch Releases the battery from the battery bay.
(3)	Vents (4) Enable airflow to cool internal components. NOTE: The computer fan starts up automatically to cool internal components and prevent overheating. It is normal for the internal fan to cycle on and off during routine operation.
(4)  	Memory module compartment Contains 2 memory module slots and, on select models, the wireless LAN (WLAN) device. CAUTION: To prevent an unresponsive system, replace the wireless module only with a wireless module authorized for use in the computer by the governmental agency that regulates wireless devices in your country or region. If you replace the module and then receive a warning message, remove the module to restore computer functionality, and then contact technical support through Help and Support.
(5) 	Hard drive bay Holds the hard drive.

Wireless antennas

At least 2 antennas send and receive signals from one or more wireless devices. These antennas are not visible from the outside of the computer.



 **NOTE:** For optimal transmission, keep the areas immediately around the antennas free from obstructions.

To see wireless regulatory notices, refer to the section of the *Regulatory, Safety and Environmental Notices* that applies to your country or region. These notices are located in Help and Support.

Additional hardware components



Component	Description
(1) Power cord*	Connects an AC adapter to an AC outlet.
(2) AC adapter	Converts AC power to DC power.
(3) Battery*	Powers the computer when the computer is not plugged into external power.

*Power cords vary in appearance by country or region.

⚠ WARNING! Connecting the internal analog modem to a digital line can permanently damage the modem. Immediately disconnect the modem cable if you accidentally connect it to a digital line.

📄 NOTE: Telephone jacks vary by country or region. To use the modem and the modem cable (included with select models only) outside the country or region in which you purchased the computer, you must obtain a country- or region-specific modem cable adapter (included with select models or purchased separately). The modem must be connected to an analog telephone line using a 6-pin, RJ-11 modem cable (included with select models only). Jacks for digital PBX systems may resemble analog telephone jacks, but they are not compatible with the modem.

If the modem cable contains noise suppression circuitry, which prevents interference from TV and radio reception, orient the circuitry end of the cable toward the computer.

Labels

The labels affixed to the computer provide information you may need when you troubleshoot system problems or travel internationally with the computer.

- Service tag—Provides important information, including the following:



Component	
(1)	Product name
(2)	Serial number (s/n)
(3)	Part number/Product number (p/n)
(4)	Warranty period
(5)	Model description

Have this information available when you contact technical support. The service tag label is affixed inside the battery bay.

- Regulatory label—Provides regulatory information about the computer. The regulatory label is affixed inside the battery bay.
- Microsoft® Certificate of Authenticity—Contains the Windows® Product Key. You may need the Product Key to update or troubleshoot the operating system. This certificate is affixed to the bottom of the computer.
- Modem approval label (select models only)—Provides regulatory information about the modem and lists the agency approval markings required by some of the countries or regions in which the modem has been approved for use. You may need this information when traveling internationally. The modem approval label is affixed inside the battery bay.
- Wireless certification label or labels—Provide information about optional wireless devices and the approval markings of some of the countries or regions in which the devices have been approved for use. An optional device may be a wireless local area network (WLAN) device or an optional Bluetooth® device. If your computer model includes one or more wireless devices, one or more certification labels are included with your computer. You may need this information when traveling internationally. Wireless certification labels are affixed inside the memory module compartment. This label is affixed inside the battery bay.

2 Wireless, local area network, and modem

Using wireless devices

Wireless technology transfers data across radio waves instead of wires. Your computer may be equipped with one or more of the following wireless devices:

- Wireless local area network (WLAN) device—Connects the computer to wireless local area networks (commonly referred to as Wi-Fi networks, wireless LANs, or WLANs) in corporate offices, your home, and public places such as airports, restaurants, coffee shops, hotels, and universities. In a WLAN, each mobile wireless device communicates with a wireless router or a wireless access point.
- Bluetooth® device (select models only)—Creates a personal area network (PAN) to connect to other Bluetooth-enabled devices such as computers, phones, printers, headsets, speakers, and cameras. In a PAN, each device communicates directly with other devices, and devices must be relatively close together—typically within 10 meters (approximately 33 feet) of each other.

Computers with WLAN devices support one or more of the following IEEE industry standards:







- 802.11b, the first popular standard, supports data rates of up to 11 Mbps and operates at a frequency of 2.4 GHz.
- 802.11g supports data rates of up to 54 Mbps and operates at a frequency of 2.4 GHz. An 802.11g WLAN device is backward compatible with 802.11b devices, so they can operate on the same network.
- 802.11a supports data rates of up to 54 Mbps and operates at a frequency of 5 GHz.

 **NOTE:** 802.11a is not compatible with 802.11b and 802.11g.

- 802.11n supports data rates of up to 450 Mbps and may operate at 2.4 GHz or 5 GHz, making it backward compatible with 802.11a, b, and g.

For more information on wireless technology, refer to the information and Web site links provided in Help and Support.

Identifying wireless and network status icons

Icon	Name	Description
	Wireless (connected)	Identifies the location of the wireless light and the wireless action key (f12) on the computer. Also identifies the HP Wireless Assistant software on the computer and indicates that one or more of the wireless devices are on.
	Wireless (disconnected)	Identifies the HP Wireless Assistant software on the computer and indicates that all of the wireless devices are off.
	Wired network (connected)	Indicates that one or more network drivers are installed, and one or more network devices are connected to a wired network.
	Wired network (disabled/disconnected)	Indicates that one or more network drivers are installed, but no network devices are connected (or all network devices are disabled in Windows® Control Panel).
	Network (connected)	Indicates that one or more network drivers are installed, and one or more network devices are connected to a wireless network.
	Network (disconnected)	Indicates that one or more network drivers are installed and wireless connections are available, but no network devices are connected to a wireless network.
	Network (disabled/disconnected)	Indicates that one or more network drivers are installed, but no wireless connections are available (or all wireless network devices are disabled by the wireless action key (f12) or HP Wireless Assistant).

Using the wireless controls

You can control the wireless devices in your computer using these features:

- The wireless action key (f12)
- HP Wireless Assistant software
- Operating system controls

Using the wireless action key

The computer has a wireless action key (f12), one or more wireless devices, and a wireless light. All of the wireless devices on your computer are enabled at the factory, so the wireless light is on (white) when you turn on the computer.

The wireless light indicates the overall power state of your wireless devices, not the status of individual devices. If the wireless light is on (white), at least one wireless device is on. If the wireless light is amber, all wireless devices are off.

Because the wireless devices are enabled at the factory, you can use the wireless action key (f12) to turn on or turn off the wireless devices simultaneously. Individual wireless devices can be controlled through HP Wireless Assistant.

Using HP Wireless Assistant

A wireless device can be turned on or off using HP Wireless Assistant. If a wireless device is disabled in Setup Utility, it must be reenabled in Setup Utility before it can be turned on or off using Wireless Assistant.

 **NOTE:** Enabling or turning on a wireless device does not automatically connect the computer to a network or a Bluetooth-enabled device.

To view the state of the wireless devices, click the **Show hidden icons** icon, the arrow at the left of the notification area, and then position the mouse pointer over the wireless icon.

If the wireless icon is not displayed in the notification area, complete the following steps to change Wireless Assistant properties:

1. Select **Start > Control Panel > Hardware and Sound > Windows Mobility Center**.
2. Click the wireless icon in the Wireless Assistant tile, which is located in the bottom row of Windows® Mobility Center. Wireless Assistant opens.
3. Click **Properties**.
4. Select the check box next to **HP Wireless Assistant icon in notification area**.
5. Click **Apply**.
6. Click **Close**.

For more information, refer to the Wireless Assistant software Help:

1. Open Wireless Assistant by clicking the wireless icon in Windows Mobility Center.
2. Click the **Help** button.

Using operating system controls

Some operating systems also offer a way to manage integrated wireless devices and the wireless connection. For example, Windows provides the Network and Sharing Center that allows you to set up a connection or network, connect to a network, manage wireless networks, and diagnose and repair network problems.

To access the Network and Sharing Center, select **Start > Control Panel > Network and Internet > Network and Sharing Center**.

For more information, select **Start > Help and Support**.

Using a WLAN

With a WLAN device, you can access a wireless local area network (WLAN), which is composed of other computers and accessories that are linked by a wireless router or a wireless access point.

 **NOTE:** The terms *wireless router* and *wireless access point* are often used interchangeably.

- A large-scale WLAN, such as a corporate or public WLAN, typically uses wireless access points that can accommodate a large number of computers and accessories and can separate critical network functions.
- A home or small office WLAN typically uses a wireless router, which allows several wireless and wired computers to share an Internet connection, a printer, and files without requiring additional pieces of hardware or software.

To use the WLAN device in your computer, you must connect to a WLAN infrastructure (provided through a service provider or a public or corporate network).

Setting up a WLAN

To set up a WLAN and connect to the Internet, you need the following equipment:

- A broadband modem (either DSL or cable) **(1)** and high-speed Internet service purchased from an Internet service provider (ISP)
- A wireless router (purchased separately) **(2)**
- The wireless computer **(3)**

The illustration below shows an example of a wireless network installation that is connected to the Internet.

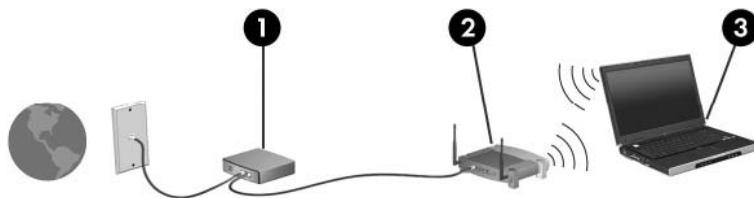

As your network grows, additional wireless and wired computers can be connected to the network to access the Internet.

For help in setting up your WLAN, refer to the information provided by your router manufacturer or your ISP.

Protecting your WLAN

Because the WLAN standard was designed with only limited security capabilities—basically to foil casual eavesdropping rather than more powerful forms of attack—it is essential to understand that WLANs are vulnerable to well-known and well-documented security weaknesses.

WLANs in public areas, or “hotspots,” like coffee shops and airports may not provide any security. New technologies are being developed by wireless manufacturers and hotspot service providers that make the public environment more secure and anonymous. If you are concerned about the security of your computer in a hotspot, limit your network activities to noncritical e-mail and basic Internet surfing.

When you set up a WLAN or access an existing WLAN, always enable security features to protect your network from unauthorized access. The common security levels are Wi-Fi Protected Access (WPA)-Personal and Wired Equivalent Privacy (WEP). Because wireless radio signals travel outside the network, other WLAN devices can pick up unprotected signals and either connect to your network (uninvited) or capture information being sent across it. However, you can take precautions to protect your WLAN:

- **Use a wireless transmitter with built-in security**

Many wireless base stations, gateways, or routers provide built-in security features such as wireless security protocols and firewalls. With the correct wireless transmitter, you can protect your network from the most common wireless security risks.

- **Work behind a firewall**

A firewall is a barrier that checks both data and requests for data that are sent to your network, and discards any suspicious items. Firewalls are available in many varieties, both software and hardware. Some networks use a combination of both types.

- **Use wireless encryption**

A variety of sophisticated encryption protocols is available for your WLAN. Find the solution that works best for your network security:

- **Wired Equivalent Privacy (WEP)** is a wireless security protocol that encodes or encrypts all network data before it is transmitted using a WEP key. Usually, you can allow the network to assign the WEP key. Alternatively, you can set up your own key, generate a different key, or choose other advanced options. Without the correct key, others will not be able to use the WLAN.
- **WPA (Wi-Fi Protected Access)**, like WEP, uses security settings to encrypt and decrypt data that is transmitted over the network. However, instead of using one static security key for encryptions as WEP does, WPA uses “temporal key integrity protocol” (TKIP) to dynamically generate a new key for every packet. It also generates different sets of keys for each computer on the network.

Connecting to a WLAN

To connect to the WLAN, follow these steps:

1. Be sure that the WLAN device is on. If it is on, the wireless light is white. If the wireless light is amber, press the wireless action key (f12).
2. Click the network icon in the notification area, at the far right of the taskbar.
3. Select your WLAN from the list.
4. Click **Connect**.

If the network is a security-enabled WLAN, you are prompted to enter a network security key, which is a security code. Type the code, and then click **OK** to complete the connection.

 **NOTE:** If no WLANs are listed, you are out of range of a wireless router or access point.

NOTE: If you do not see the network you want to connect to, click **Open Network and Sharing Center**, and then click **Set up a new connection or network**. A list of options is displayed. You can choose to manually search for and connect to a network or to create a new network connection.

After the connection is made, place the mouse pointer over the network icon in the notification area, at the far right of the taskbar, to verify the name and status of the connection.

 **NOTE:** The functional range (how far your wireless signals travel) depends on WLAN implementation, router manufacturer, and interference from other electronic devices or structural barriers such as walls and floors.

More information about using a WLAN is available through the following resources:

- Information from your ISP and the user guides included with your wireless router and other WLAN equipment
- Information and Web site links provided in Help and Support

For a list of public WLANs near you, contact your ISP or search the Web. Web sites that list public WLANs include Cisco Internet Mobile Office Wireless Locations, Hotspotlist, and Geektools. Check with each public WLAN location for cost and connection requirements.

Roaming to another network

When you move your computer within range of another WLAN, Windows attempts to connect to that network. If the attempt is successful, your computer is automatically connected to the new network. If Windows does not recognize the new network, follow the same procedure you used initially to connect to your WLAN.

Using Bluetooth wireless devices (select models only)

A Bluetooth device provides short-range wireless communications that replace the physical cable connections that traditionally link electronic devices such as the following:

- Computers (desktop, notebook, PDA)
- Phones (cellular, cordless, smart phone)
- Imaging devices (printer, camera)
- Audio devices (headset, speakers)

Bluetooth devices provide peer-to-peer capability that allows you to set up a personal area network (PAN) of Bluetooth devices. For information on configuring and using Bluetooth devices, refer to the Bluetooth software Help.

Bluetooth and Internet Connection Sharing (ICS)

HP does **not** recommend setting up one computer with Bluetooth as a host and using it as a gateway through which other computers may connect to the Internet. When two or more computers are connected using Bluetooth, and Internet Connection Sharing (ICS) is enabled on one of the computers, the other computers may not be able to connect to the Internet using the Bluetooth network.

The strength of Bluetooth is in synchronizing information transfers between your computer and wireless devices including cellular phones, printers, cameras, and PDAs. The inability to consistently connect two or more computers to share the Internet through Bluetooth is a limitation of Bluetooth and the Windows operating system.

Troubleshooting wireless connection problems

Some possible causes for wireless connection problems include the following:

- Network configuration (SSID or security) has been changed.
- Wireless device is not installed correctly or has been disabled.
- Wireless device or router hardware has failed.
- Wireless device encountered interference from other devices.

 **NOTE:** Wireless networking devices are included with select computer models only. If wireless networking is not listed in the feature list on the side of the original computer package, you may add wireless networking capability to the computer by purchasing a wireless networking device.

Before working your way through the sequence of possible solutions to your network connection problem, be sure that device drivers are installed for all wireless devices.

Use the procedures in this chapter to diagnose and repair a computer that does not connect to the network you want to use.

Cannot connect to a WLAN

If you have a problem connecting to a WLAN, confirm that the integrated WLAN device is properly installed on your computer:

 **NOTE:** Windows includes the User Account Control feature to improve the security of your computer. You may be prompted for your permission or password for tasks such as installing software, running utilities, or changing Windows settings. Refer to Help and Support for more information.

1. Select **Start > Control Panel > System and Security**.
2. In the **System** area, click **Device Manager**.
3. Click the arrow next to **Network adapters** to expand the list and show all adapters.
4. Identify the WLAN device from the Network adapters list. The listing for a WLAN device may include the term *wireless*, *wireless LAN*, *WLAN*, *Wi-Fi*, or *802.11*.

If no WLAN device is listed, either your computer does not have an integrated WLAN device, or the driver for the WLAN device is not properly installed.

For more information on troubleshooting WLANs, refer to the Web site links provided in Help and Support.

Cannot connect to a preferred wireless network

Windows can automatically repair a corrupted WLAN connection:

- If there is a network icon in the notification area, at the far right of the taskbar, right-click the icon, and then click **Troubleshoot problems**.

Windows resets your network device and attempts to reconnect to one of the preferred networks.

- If there is no network icon in the notification area, follow these steps:
 1. Select **Start > Control Panel > Network and Internet > Network and Sharing Center**.
 2. Click **Troubleshoot problems** and select the network you wish to repair.

Network icon is not displayed

If the network icon is not displayed in the notification area after you configure the WLAN, the software driver is either missing or corrupted. A Windows “Device not Found” error message may also be displayed. The driver must be reinstalled.

Get the latest version of the WLAN device software and drivers for your computer from the HP Web site at <http://www.hp.com>. If the WLAN device you are using was purchased separately, consult the manufacturer's Web site for the latest software.

To get the latest version of the WLAN device software for your computer, follow these steps:

1. Open your Web browser and go to <http://www.hp.com/support>.
2. Select your country or region.
3. Click the option for software and driver downloads, and then type your computer model number in the search box.
4. Press **enter**, and then follow the on-screen instructions.

 **NOTE:** If the WLAN device you are using was purchased separately, consult the manufacturer's Web site for the latest software.

Current network security codes are unavailable

If you are prompted for a network key or a name (SSID) when connecting to a WLAN, the network is protected by security. You must have the current codes to make a connection on a secure network. The SSID and network key are alphanumeric codes that you enter into your computer to identify your computer to the network.

- For a network connected to your personal wireless router, review the router user guide for instructions on setting up the same codes on both the router and the WLAN device.
- For a private network, such as a network in an office or at a public Internet chat room, contact the network administrator to obtain the codes, and then enter the codes when prompted to do so.

Some networks change the SSID or network keys used in their routers or access points on a regular basis to improve security. You must change the corresponding code in your computer accordingly.

If you are provided with new wireless network keys and SSID for a network, and if you have previously connected to that network, follow the steps below to connect to the network:

1. Select **Start > Control Panel > Network and Internet > Network and Sharing Center**.

2. In the left panel, click **Manage wireless networks**.

A list showing the available WLANs is displayed. If you are in a hotspot where several WLANs are active, several will be displayed.

3. Select the network in the list, right-click the network, and then click **Properties**.

 **NOTE:** If the network you want is not listed, check with the network administrator to be sure that the router or access point is operating.

4. Click the **Security** tab and enter the correct wireless encryption data into the **Network security key** box.

5. Click **OK** to save these settings.

WLAN connection is very weak

If the connection is very weak, or if your computer cannot make a connection to a WLAN, minimize interference from other devices, as follows:

- Move your computer closer to the wireless router or access point.
- Temporarily disconnect devices such as a microwave, cordless phone, or cellular phone to be sure that other wireless devices are not interfering.

If the connection does not improve, try forcing the device to reestablish all connection values:

1. Select **Start > Control Panel > Network and Internet > Network and Sharing Center**.

2. In the left panel, click **Manage wireless networks**.

A list showing the available WLANs is displayed. If you are in a hotspot where several WLANs are active, several will be displayed.

3. Click a network, and then click **Remove**.

Cannot connect to the wireless router

If you are trying to connect to the wireless router and are unsuccessful, reset the wireless router by removing power from the router for 10 to 15 seconds.

If the computer still cannot make a connection to a WLAN, restart the wireless router. For details, refer to the router manufacturer's instructions.

Connecting to a local area network

Connecting to a local area network (LAN) requires an 8-pin, RJ-45 network cable (purchased separately). If the network cable contains noise suppression circuitry **(1)**, which prevents interference from TV and radio reception, orient the circuitry end of the cable **(2)** toward the computer.



To connect the network cable:

1. Plug the network cable into the network jack (1) on the computer.
2. Plug the other end of the cable into a network wall jack (2).

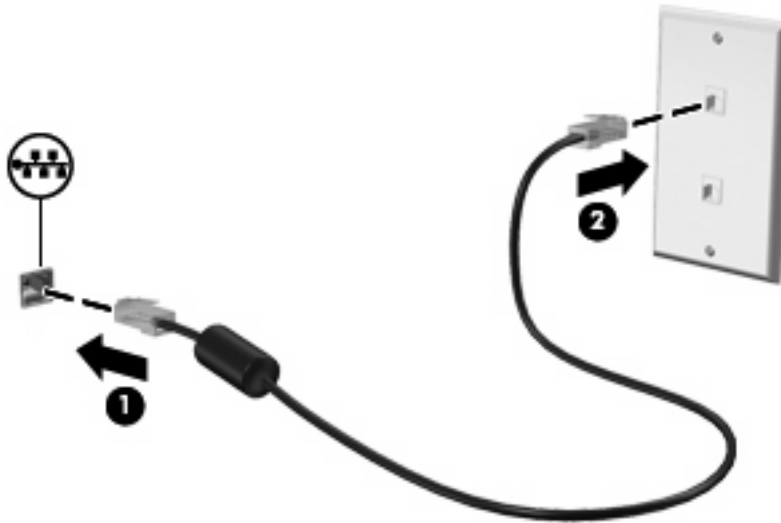

⚠ WARNING! To reduce the risk of electric shock, fire, or damage to the equipment, do not plug a modem or telephone cable into the RJ-45 (network) jack.

3 Pointing devices and keyboard

Using the TouchPad

The following illustration and table describe the computer TouchPad.

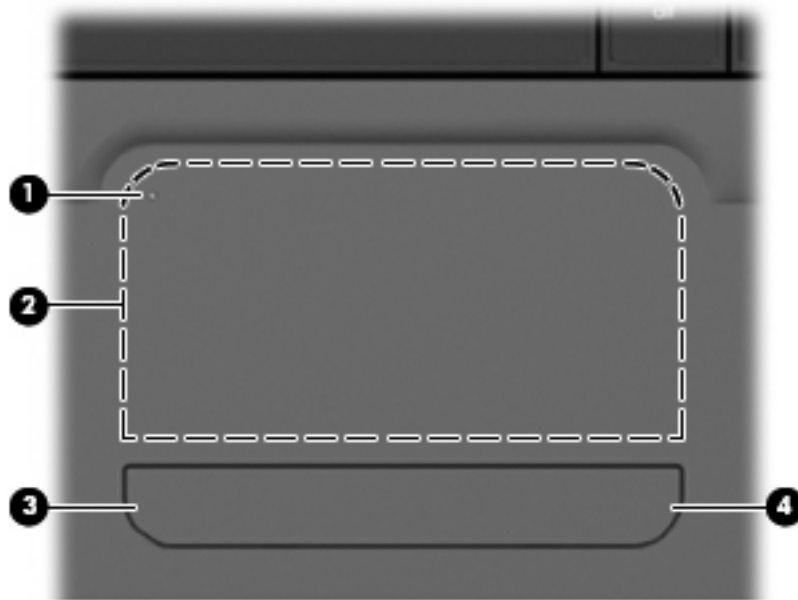

Component	Description
(1) TouchPad off indicator	To switch the TouchPad zone on and off, quickly double-tap the TouchPad off indicator. NOTE: When the TouchPad zone is active, the light is off.
(2) TouchPad zone	Moves the pointer and selects or activates items on the screen.
(3) Left TouchPad button	Functions like the left button on an external mouse.
(4) Right TouchPad button	Functions like the right button on an external mouse.

Turning the TouchPad on and off

The TouchPad is turned on at the factory. When the TouchPad zone is active, the light is off. To turn the TouchPad on and off, quickly double-tap the TouchPad off indicator.

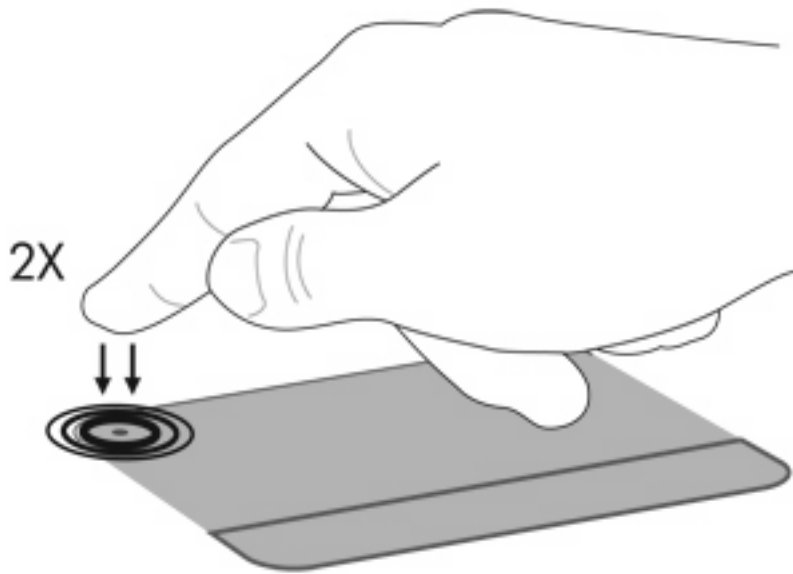

Using TouchPad gestures

To enable or disable gestures, click the **Synaptics** icon in the notification area, at the far right of the taskbar, and then check or uncheck **Disable gestures**. To enable or disable a specific gesture, select **Control Panel > Hardware and Sound > Mouse > Device settings > Settings**, and then check or clear the check box next to the gesture you want to enable or disable.

Scrolling

Scrolling is useful for moving up or down on a page or image. To scroll, place two fingers on the TouchPad and drag them across the TouchPad in an up, down, left, or right motion.

 **NOTE:** Scrolling speed is controlled by finger speed.

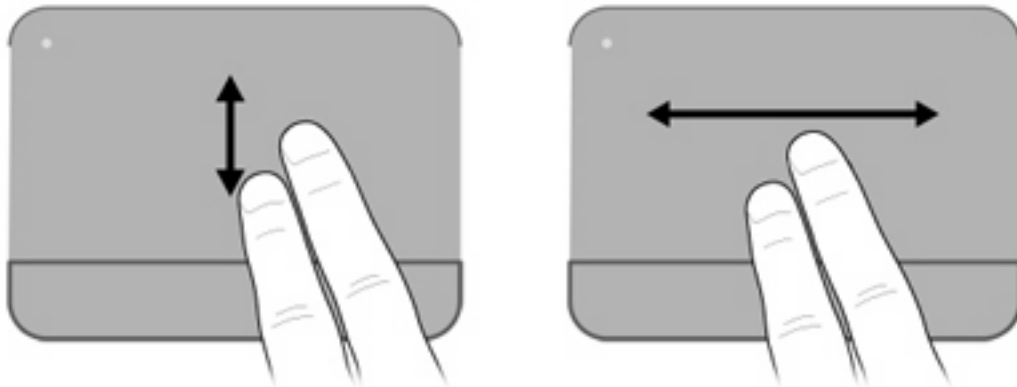

Pinching

Pinching allows you to zoom in or out on items such as PDFs, images, and photos.

To pinch:

- Zoom in by holding two fingers together on the TouchPad, and then pull the fingers apart to increase an object's size.
- Zoom out by holding two fingers apart on the TouchPad, and then pull the fingers together to decrease an object's size.

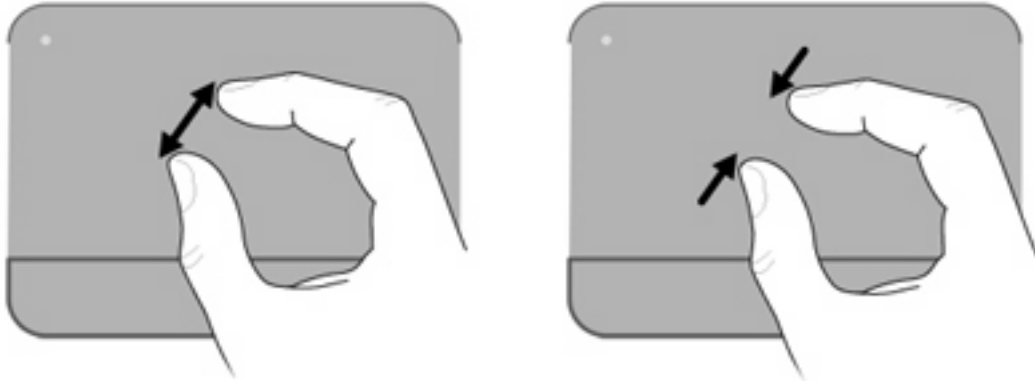

Rotating

Rotating allows you rotate items such as photos and pages. To rotate, anchor your thumb on the TouchPad, and then move your forefinger in a semicircular motion around your thumb.

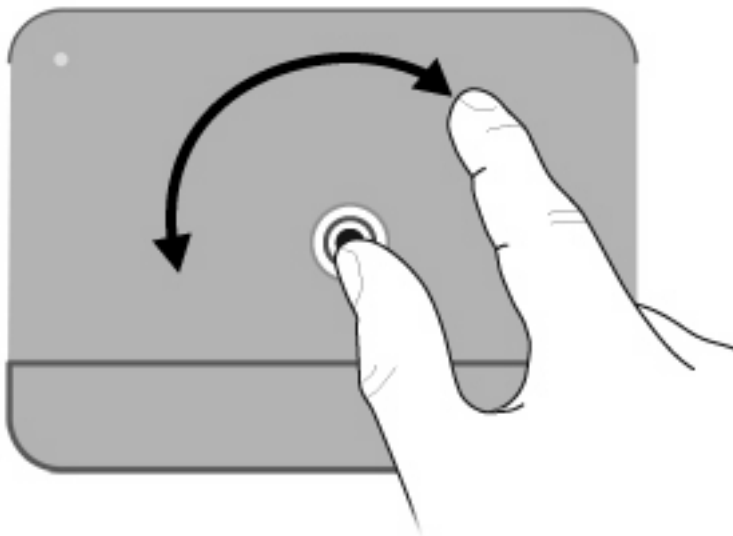

Setting pointing device preferences

Use Mouse Properties in Windows® to customize settings for pointing devices, such as button configuration, click speed, and pointer options.

To access Mouse Properties, select **Start > Control Panel > Printers and Other Hardware > Mouse**.

Connecting an external mouse

You can connect an external USB mouse to the computer using one of the USB ports on the computer.

Using the keyboard









Using the action keys



Action keys are customized actions that are assigned to specific keys at the top of the keyboard. The icons on the **f1** through **f12** keys represent the action key functions.

To use an action key, press and hold this key to activate the assigned function.

 **NOTE:** The action key feature is enabled at the factory. You can disable this feature in Setup Utility. If this feature is disabled in Setup Utility, you will need to press **fn** and an action key to activate the assigned function. Refer to the “Setup Utility (BIOS)” chapter for additional information.



Icon	Key	Description
	f1	Opens Help and Support, which provides information about your Windows operating system and computer, answers to questions and tutorials, and updates to your computer. Help and Support also provides automated troubleshooting and links to support specialists.
	f2	Decreases the screen brightness level incrementally when you hold down this key.
	f3	Increases the screen brightness level incrementally when you hold down this key.
	f4	Switches the screen image among display devices connected to the system. For example, if a monitor is connected to the computer, pressing this key alternates the screen image from computer display to monitor display to simultaneous display on both the computer and the monitor. Most external monitors receive video information from the computer using the external VGA video standard. The switch screen image key can also alternate images among other devices that are receiving video information from the computer.
	f5	Plays the previous track of a CD or the previous section of a DVD or a BD.
	f6	Plays, pauses, or resumes a track of an audio CD or a section of a DVD or a BD.
	f7	Stops playback.
	f8	Plays the next track of an audio CD or the next section of a DVD or a BD.
	f9	Decreases speaker volume incrementally when you hold down this key.

	f10	Increases speaker volume incrementally when you hold down this key.
	f11	Mutes or restores speaker sound.
	f12	Turns the wireless feature on or off. NOTE: This key does not establish a wireless connection. To establish a wireless connection, a wireless network must also be set up.
	prt sc	Takes a snapshot or picture of your computer screen and copies it to the clipboard.

Using the hotkey

A hotkey is a combination of the **fn** key (1) and the **esc** key (2).

Pressing **fn+esc** displays information about system hardware components and the system BIOS version number.



To use a hotkey command on the computer keyboard, follow either of these steps:

- Briefly press the **fn** key, and then briefly press **esc**.
– or –
- Press and hold down the **fn** key, briefly press **esc**, and then release both keys at the same time.

Cleaning the TouchPad and keyboard

Dirt and grease on the TouchPad can cause the pointer to jump around on the screen. To avoid this, clean the TouchPad with a damp cloth, and wash your hands frequently when using the computer.

⚠ **WARNING!** To reduce the risk of electric shock or damage to internal components, do not use a vacuum cleaner attachment to clean the keyboard. A vacuum cleaner can deposit household debris on the keyboard surface.

Clean the keyboard regularly to prevent keys from sticking and to remove dust, lint, and particles that can become trapped beneath the keys. A can of compressed air with a straw extension can be used to blow air around and under the keys to loosen and remove debris.



4 Multimedia

Multimedia features

Your computer includes multimedia features that allow you to listen to music, watch movies, and view pictures. Your computer may include the following multimedia components:

- Optical drive for playing audio and video discs
- Integrated speakers for listening to music
- Integrated microphone for recording your own audio
- Integrated webcam that allows you to capture and share video
- Preinstalled multimedia software that allows you to play and manage your music, movies, and pictures
- Multimedia action keys that provide fast access to multimedia tasks







 **NOTE:** Your computer may not include all of the components listed.

The following sections explain how to identify and use the multimedia components included with your computer.

Identifying your multimedia components

 **NOTE:** Your computer may look slightly different from the illustration in this section.



Component	Description
(1) 	Internal microphone Records sound.
(2)	Webcam (select models only) Records audio and video and captures still photographs.
(3)	Webcam light (select models only) Turns on when video software accesses the webcam.
(4) 	Volume down action key (f9) Decreases speaker sound.
(5) 	Volume up action key (f10) Increases speaker sound.
(6) 	Volume mute action key (f11) Mutes and restores speaker sound.
(7)	Speakers (2) Produce sound.
(8) 	Audio-out (headphone) jack Produces sound when connected to optional powered stereo speakers, headphones, earbuds, a headset, or television audio. WARNING! To reduce the risk of personal injury, adjust the volume before putting on headphones, earbuds, or a headset. For additional safety information, refer to the <i>Regulatory, Safety and Environmental Notices</i> . NOTE: When a device is connected to the headphone jack, the computer speakers are disabled.
(9) 	Audio-in (microphone) jack Connects an optional computer headset microphone, stereo array microphone, or monaural microphone.

Adjusting the volume

You can adjust the volume using the following controls:

- Computer volume action keys:
 - To decrease volume incrementally, press the volume down action key (f9) (1).
 - To increase volume incrementally, press the volume up action key (f10) (2).
 - To mute or restore volume, press the volume mute action key (f11) (3).



- Windows® volume control:
 - a. Click the **Speakers** icon in the notification area, at the far right of the taskbar.
 - b. Increase or decrease the volume by moving the slider up or down. Click the **Mute Speakers** icon to mute the volume.

– or –

 - a. Right-click the **Speakers** icon in the notification area, and then click **Open Volume Mixer**.
 - b. In the Speakers column, increase or decrease the volume by moving the slider up or down. You can also mute the volume by clicking the **Mute Speakers** icon.

If the **Speakers** icon is not displayed in the notification area, follow these steps to add it:

 - a. Right-click the **Show hidden icons** icon (the arrow at the left side of the notification area).
 - b. Click **Customize notification icons**.

- c. Under **Behaviors**, select **Show icon and notifications** for the Volume icon.
- d. Click **OK**.
- Program volume control:
Volume can also be adjusted within some programs.

Using the media activity action keys

The media activity action keys control the play of an audio CD or a DVD or BD (Blu-ray Disc) that is inserted into an optical drive.

- When an audio CD or a DVD or BD is not playing, press the **play/pause** action key (f6) (2) to play the disc.
- When an audio CD or a DVD or BD is playing, use the following action keys:
 - To play the previous track of an audio CD or the previous section of a DVD or BD, press the **previous track** action key (f5) (1).
 - To pause or resume playing the disc, press the **play/pause** action key (f6) (2).
 - To stop the disc, press the **stop** action key (f7) (3).
 - To play the next track of an audio CD or the next section of a DVD, press the **next track** action key (f8) (4).

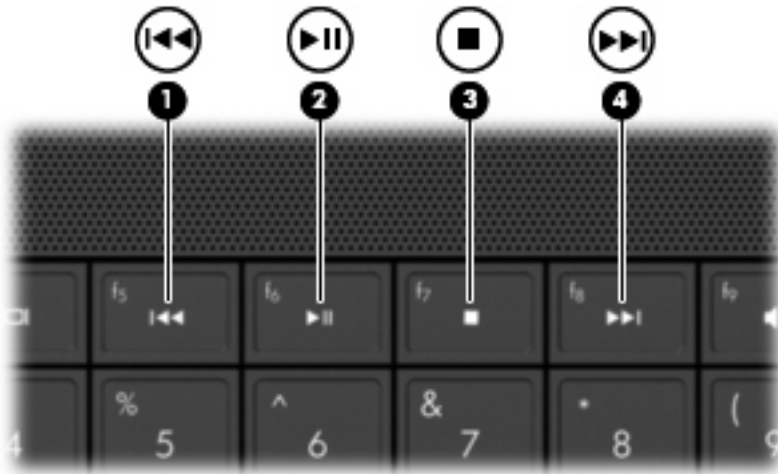

Multimedia software

Your computer includes preinstalled multimedia software that allows you to play music, watch movies, and view pictures. The following sections provide details about CyberLink PowerDVD 8 and other preinstalled multimedia software.

Using CyberLink PowerDVD 8 software

CyberLink PowerDVD 8 turns your computer into a mobile entertainment center. With CyberLink PowerDVD 8, you can enjoy music and DVD movies.

To start CyberLink PowerDVD 8, select **Start > All Programs > CyberLink PowerDVD 8**.

For information on using CyberLink PowerDVD 8, refer to the software Help.

Using other preinstalled multimedia software

To locate other preinstalled multimedia software:

- ▲ Select **Start > All Programs**, and then open the multimedia program you want to use. For example, if you want to use Windows Media Player to play an audio CD, click **Windows Media Player**.



NOTE: Some programs may be located in subfolders.

Installing multimedia software from a disc

To install any multimedia software from a CD or DVD, follow these steps:

1. Insert the disc into the optical drive.
2. When the installation wizard opens, follow the on-screen instructions.
3. Restart the computer if you are prompted to do so.



NOTE: For details about using software included with the computer, refer to the software manufacturer's instructions, which may be provided on disc, in the software Help, or on the manufacturer's Web site.

Audio

Your computer enables you to use a variety of audio features:

- Play music using your computer speakers and/or connected external speakers
- Record sound using the internal microphone or connect an external microphone
- Download music from the Internet
- Create multimedia presentations using audio and images
- Transmit sound and images with instant messaging programs
- Stream radio programs (select models only) or receive FM radio signals
- Create or “burn” audio CDs

Connecting external audio devices

⚠ WARNING! To reduce the risk of personal injury, adjust the volume before putting on headphones, earbuds, or a headset. For additional safety information, refer to the *Regulatory, Safety and Environmental Notices*.

To connect external devices such as external speakers, headphone, or a microphone, refer to the information provided with the device. For best results, remember the following tips:

- Be sure that the device cable is securely connected to the correct jack on your computer. (Cable connectors are normally color-coded to match the corresponding jacks on the computer.)
- Be sure to install any drivers required by the external device.

📖 NOTE: A driver is a required program that acts like a translator between the device and the programs that use the device.

Checking your audio functions

To check the system sound on your computer, follow these steps:

1. Select **Start > Control Panel**.
2. Click **Hardware and Sound**.
3. Click **Sound**.
4. When the Sound window opens, click the **Sounds** tab. Under **Program Events**, select any sound event, such as a beep or alarm, and click the **Test** button.

You should hear sound through the speakers or through connected headphones.

To check the record functions of the computer, follow these steps:

1. Select **Start > All Programs > Accessories > Sound Recorder**.
2. Click **Start Recording** and speak into the microphone. Save the file to your desktop.
3. Open Windows Media Player or CyberLink PowerDVD 8, and play back the sound.

 **NOTE:** For best results when recording, speak directly into the microphone and record sound in a setting free of background noise.

To confirm or change the audio settings on your computer, select **Start > Control Panel > Hardware and Sound > Sound**.

Video

Your computer enables you to use a variety of video features:

- Watch movies
- Play games over the Internet
- Edit pictures and video to create presentations
- Connect external video devices

Connecting an external monitor or projector

The external monitor port connects an external display device such as an external monitor or a projector to the computer.

▲ To connect a display device, connect the device cable to the external monitor port.

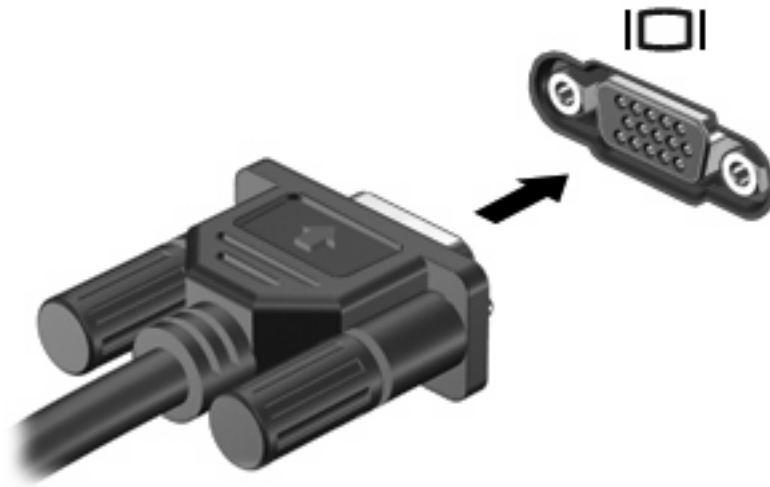

 **NOTE:** If a properly connected external display device does not display an image, press **f4** to transfer the image to the device. Repeatedly pressing **f4** alternates the screen image between the computer display and the device.

Connecting an HDMI device (select models only)

Select models include an HDMI (High Definition Multimedia Interface) port. The HDMI port connects the computer to an optional video or audio device, such as a high-definition television, or any compatible digital or audio component.

The computer can support one HDMI device connected to the HDMI port, while simultaneously supporting an image on the computer display or any other supported external display.

 **NOTE:** To transmit video signals through the HDMI port, you need an HDMI cable (purchased separately), available from most electronic retailers.

To connect a video or audio device to the HDMI port:

1. Connect one end of the HDMI cable to the HDMI port on the computer.

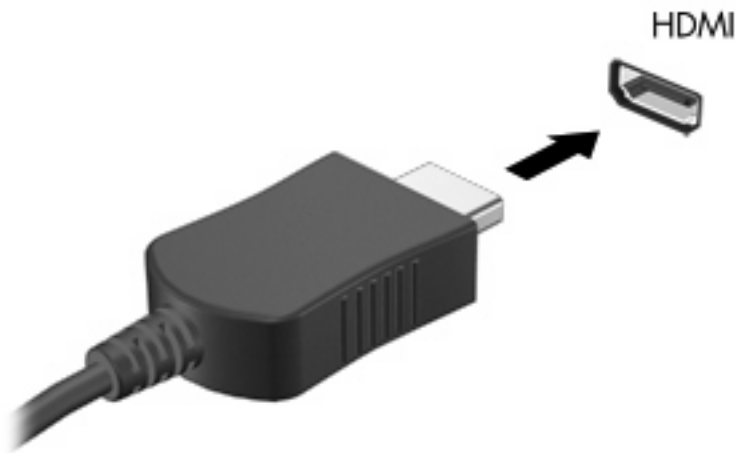

2. Connect the other end of the cable to the video device, according to the device manufacturer's instructions.
3. Press the **f4** action key on the computer to switch the image between the display devices connected to the computer.

Configuring audio for HDMI (select models only)

To configure HDMI audio, first connect an audio or video device, such as a high-definition TV, to the HDMI port on your computer. Then configure the default audio playback device as follows:

1. Right-click the **Speakers** icon in the notification area, at the far right of the taskbar, and then click **Playback devices**.
2. On the **Playback** tab, click either **Digital Output** or **Digital Output Device (HDMI)**.
3. Click **Set Default**, and then click **OK**.

To return audio to the computer speakers, follow these steps:

1. Right-click the **Speakers** icon in the notification area, at the far right of the taskbar, and then click **Playback devices**.
2. On the **Playback** tab, click **Speakers**.
3. Click **Set Default**, and then click **OK**.

Optical drive

Your computer includes an optical drive that expands the functionality of the computer. Identify what kind of device is installed in your computer to see its capabilities. The optical drive allows you to read data discs, play music, and watch movies. If your computer includes a Blu-ray Disc ROM Drive, then you can also watch high-definition video from disc.

Identifying the installed optical drive

▲ Select **Start > Computer**.

You will see a list of all the devices installed in your computer, including your optical drive. You may have one of the following types of drives:

- DVD±RW and CD-RW SuperMulti Double-Layer Combo Drive
- DVD±RW and CD-RW SuperMulti Double-Layer Combo Drive with LightScribe
- Blu-ray ROM DVD±R/RW SuperMulti Double-Layer Drive
- Blu-ray ROM with LightScribe DVD±R/RW SuperMulti Double-Layer Drive

 **NOTE:** Some of the drives listed above may not be supported by your computer.

Using optical discs

An optical drive plays optical discs. Your optical drive can read standard CD and DVD discs, and if it is a Blu-ray Disc ROM Drive, it can also read Blu-ray Discs (BDs).

These discs store information, such as music, photos, and movies. DVDs have a larger storage capacity than CDs, and BDs have the largest capacity of all.

 **NOTE:** Some of the optical drives listed may not be supported by your computer. The listed drives are not necessarily all of the supported optical drives.

Some optical drives can also write to optical discs as described in the following table.

Optical drive type	Write to CD-RW	Write to DVD±RW/R	Write to DVD±R DL	Write label to LightScribe CD or DVD±RW/R
DVD±RW and CD-RW SuperMulti DL Combo Drive	Yes	Yes	Yes	No
DVD±RW and CD-RW SuperMulti DL Combo Drive with LightScribe	Yes	Yes	Yes	Yes
Blu-ray ROM DVD±R/RW SuperMulti DL Drive	Yes	Yes	Yes	No
Blu-ray ROM with LightScribe DVD±R/RW SuperMulti DL Drive	Yes	Yes	Yes	Yes

 **CAUTION:** To prevent possible audio and video degradation, loss of information, or loss of audio or video playback functionality, do not initiate Sleep or Hibernation while reading or writing to a disc.

Selecting the right disc

An optical drive supports optical discs (CDs, DVDs, and BDs). CDs, used to store digital data, are also used for commercial audio recordings and are convenient for your personal storage needs. DVDs and BDs are used primarily for movies, software, and data backup purposes. DVDs and BDs are the same form factor as CDs, but DVDs have 6 to 7 times the storage capacity of CDs, and BDs have 5 to 6 times the storage capacity of DVDs.

 **NOTE:** The optical drive on your computer may not support all the types of optical discs discussed in this section.

CD-R discs

CD-R (write-once) discs are widely used for creating a permanent copy of data that can be shared as needed. Typical uses include the following:

- Distributing large presentations
- Sharing scanned and digital photos, video clips, and written data
- Making your own music CDs
- Keeping permanent archives of computer files and scanned home records
- Offloading files from your hard drive to free up disk space

After data is recorded, it cannot be erased or written over.

CD-RW discs

Use a CD-RW disc (a rewritable version of a CD) to store large projects that must be updated frequently. Typical uses include the following:

- Developing and maintaining large documents and project files
- Transporting work files
- Making weekly backups of hard drive files
- Updating photos, video, audio, and data continuously

DVD±R discs

Use blank DVD±R discs to permanently store large amounts of information. After data is recorded, it cannot be erased or written over.

DVD±RW discs

Use DVD±RW discs if you want to be able to erase or write over data that you saved earlier. This type of disc is ideal for testing audio or video recordings before you burn them to a CD or DVD that cannot be changed.

LightScribe DVD+R discs

Use LightScribe DVD+R discs for sharing and storing data, home videos, and photos. These discs are read-compatible with most DVD-ROM drives and DVD video players. With a LightScribe-enabled drive and LightScribe software, you can write data to the disc and then add a designer label to the outside of the disc.

Blu-ray Disc

Also called BD, Blu-ray Disc is a high-density optical disc format for the storage of digital information, including high-definition video. A single-layer Blu-ray Disc can store 25 GB, over 5 times the capacity of a single-layer DVD at 4.7 GB. A dual-layer Blu-ray Disc can store 50 GB, almost 6 times the capacity of a dual-layer DVD at 8.5 GB.

Typical uses include the following:

- Storage of large amounts of data
- High-definition video playback and storage
- Video games

 **NOTE:** Because Blu-ray is a new format containing new technologies, certain disc, digital connection, compatibility, and/or performance issues may arise. These do not constitute defects in the product. Flawless playback on all systems is not guaranteed.

Playing a CD, DVD, or BD

1. Turn on the computer.
2. Press the release button **(1)** on the drive bezel to release the disc tray.
3. Pull out the tray **(2)**.
4. Hold the disc by the edges to avoid touching the flat surfaces and position the disc label-side up over the tray spindle.

 **NOTE:** If the tray is not fully accessible, tilt the disc carefully to position it over the spindle.

5. Gently press the disc (3) down onto the tray spindle until the disc snaps into place.

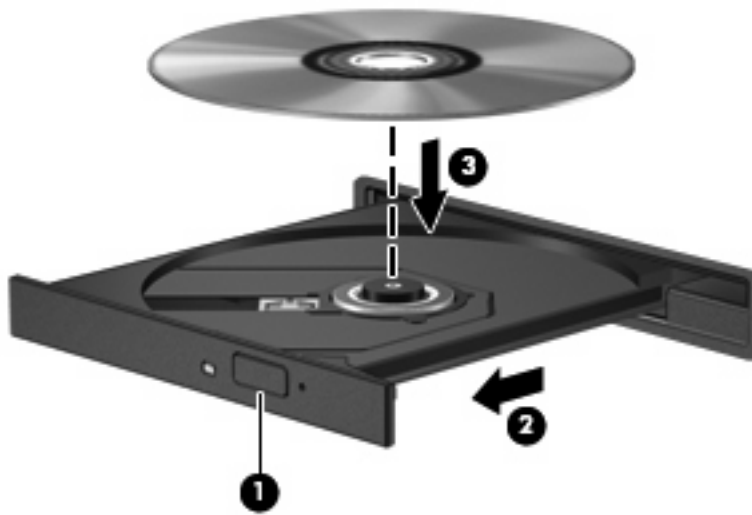

6. Close the disc tray.

If you have not yet configured AutoPlay, as described in the following section, an AutoPlay dialog box opens. It prompts you to select how you want to use the media content.

 **NOTE:** For best results, be sure that your AC adapter is plugged into an external power source while playing a BD.

Configuring AutoPlay

1. Select **Start > Default Programs > Change AutoPlay settings**.
2. Confirm that the **Use AutoPlay for all media and devices** check box at the upper left of the computer screen is selected.
3. Click **Choose a default**, and then select one of the available options for each media type listed.
4. Click **Save**.

 **NOTE:** Choose CyberLink PowerDVD 8 to play DVDs.

NOTE: For more information about AutoPlay, refer to Help and Support.

Changing DVD region settings

Most DVDs that contain copyrighted files also contain region codes. The region codes help protect copyrights internationally.

You can play a DVD containing a region code only if the region code on the DVD matches the region setting on your DVD drive.

△ **CAUTION:** The region settings on your DVD drive can be changed only 5 times.

The region setting you select the fifth time becomes the permanent region setting on the DVD drive.

The number of region changes remaining is displayed on the DVD Region tab.

To change settings through the operating system:

1. Select **Start > Control Panel > System and Security**. Then in the **System** area, click **Device Manager**.

 **NOTE:** Windows includes the User Account Control feature to improve the security of your computer. You may be prompted for your permission or password for tasks such as installing software, running utilities, or changing Windows settings. Refer to Help and Support for more information.

2. Click the arrow next to **DVD/CD-ROM drives** to expand the list to show all of the installed drives.
3. Right-click the DVD drive for which you want to change region settings, and then click **Properties**.
4. Make the desired changes on the **DVD Region** tab.
5. Click **OK**.

Observing the copyright warning

It is a criminal offense, under applicable copyright laws, to make unauthorized copies of copyright-protected material, including computer programs, films, broadcasts, and sound recordings. Do not use this computer for such purposes.

△ **CAUTION:** To prevent loss of information or damage to a disc, observe the following guidelines:

Before writing to a disc, connect the computer to a reliable external power source. Do not write to a disc while the computer is running on battery power.

Before writing to a disc, close all open programs except the disc software you are using.

Do not copy directly from a source disc to a destination disc or from a network drive to a destination disc. Save the information to your hard drive, and then burn from your hard drive to the destination disc.

Do not use the computer keyboard or move the computer while the computer is writing to a disc. The write process is sensitive to vibration.

 **NOTE:** For details about using software included with the computer, refer to the software manufacturer's instructions, which may be provided on disc, in the software Help, or on the manufacturer's Web site.

Copying a CD or DVD

1. Select **Start > All Programs > CyberLink DVD Suite > Power2Go**.

2. Insert the disc you want to copy into the optical drive.

3. Click **Copy** at the bottom right of the screen.

Power2Go reads the source disc and copies the data to a temporary folder on your hard drive.

4. When prompted, remove the source disc from the optical drive and insert a blank disc into the drive.

After the information is copied, the disc you created ejects automatically.

Creating (burning) a CD or DVD

If your computer includes a CD-RW, DVD-RW, or DVD±RW optical drive, you can use software such as Windows Media Player or CyberLink Power2Go to burn data and audio files, including MP3 and WAV music files. To burn video files to a CD or DVD, use MyDVD.

Observe the following guidelines when burning a CD or DVD:

- Before burning a disc, save and close any open files and close all programs.
- A CD-R or DVD-R is usually best for burning audio files because after the information is copied, it cannot be changed.



NOTE: You cannot create an audio DVD with CyberLink Power2Go.

- Because some home and car stereos will not play CD-RWs, use CD-Rs to burn music CDs.
- A CD-RW or DVD-RW is generally best for burning data files or for testing audio or video recordings before you burn them to a CD or DVD that cannot be changed.
- DVD players used in home systems usually do not support all DVD formats. Refer to the user guide that came with your DVD player for a list of supported formats.
- An MP3 file uses less space than other music file formats, and the process for creating an MP3 disc is the same as the process for creating a data file. MP3 files can be played only on MP3 players or on computers with MP3 software installed.

To burn a CD or DVD, follow these steps:

1. Download or copy the source files into a folder on your hard drive.
2. Insert a blank CD or DVD into the optical drive.
3. Select **Start > All Programs**, and then select the name of the program you want to use.



NOTE: Some programs may be located in subfolders.

4. Select the kind of CD or DVD you want to create—data, audio, or video.
5. Right-click **Start**, click **Open Windows Explorer**, and navigate to the folder where the source files are stored.
6. Open the folder, and then drag the files to the drive that contains the blank optical disc.
7. Initiate the burning process as directed by the program you have selected.

For specific instructions, refer to the software manufacturer's instructions, which may be provided with the software, on disc, or on the manufacturer's Web site.

Observe the copyright warning. It is a criminal offense, under applicable copyright laws, to make unauthorized copies of copyright-protected material, including computer programs, films, broadcasts, and sound recordings. Do not use this computer for such purposes.

Removing an optical disc (CD, DVD, or BD)

1. Press the release button (1) on the drive bezel to release the disc tray, and then gently pull out the tray (2) until it stops.
2. Remove the disc (3) from the tray by gently pressing down on the spindle while lifting the outer edges of the disc. Hold the disc by the edges and avoid touching the flat surfaces.

 **NOTE:** If the tray is not fully accessible, tilt the disc carefully as you remove it.

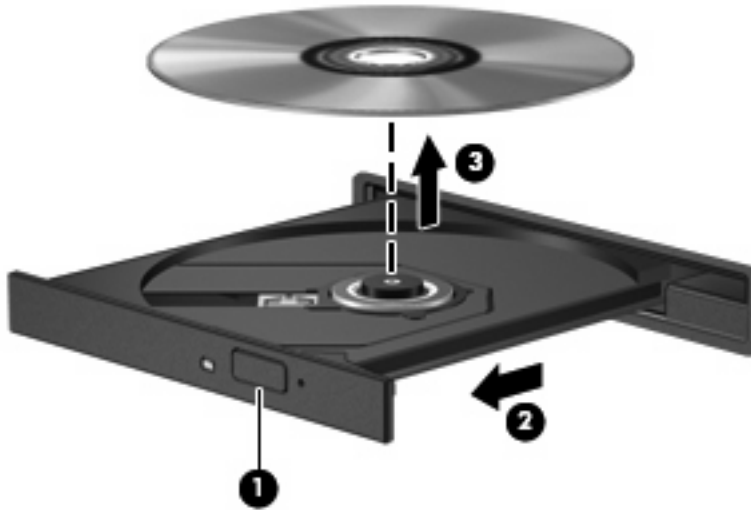

3. Close the disc tray and place the disc in a protective case.

Removing the optical drive

The optical drive can be removed to reduce the weight of the computer:

1. Save your work.
2. Shut down the computer and close the display.

If you are not sure whether the computer is off or in Hibernation, turn the computer on by pressing the power button. Then shut down the computer through the operating system.

3. Disconnect all external devices connected to the computer.
4. Unplug the power cord from the AC outlet.
5. Turn the computer upside down on a flat surface.
6. Remove the battery from the computer.
7. With the hard drive bay toward you, loosen the 2 hard drive cover screws (1) and lift the hard drive cover away from the computer (2).

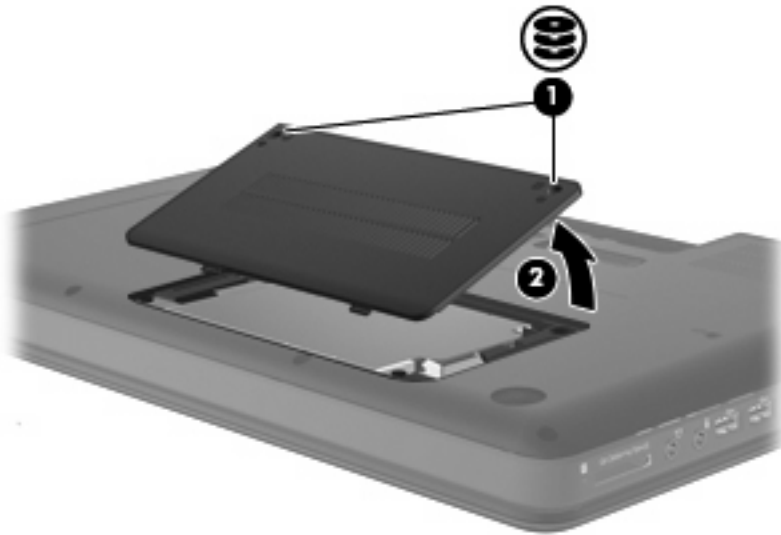

8. Remove the security screw from the optical drive.

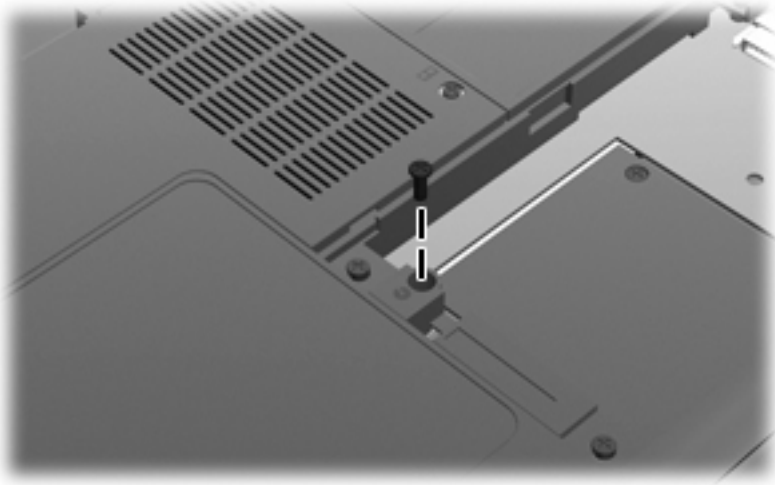

 **NOTE:** A screw driver may be necessary to loosen the bracket holding the optical drive after the security screw is removed.

9. Remove the optical drive from the optical drive bay.

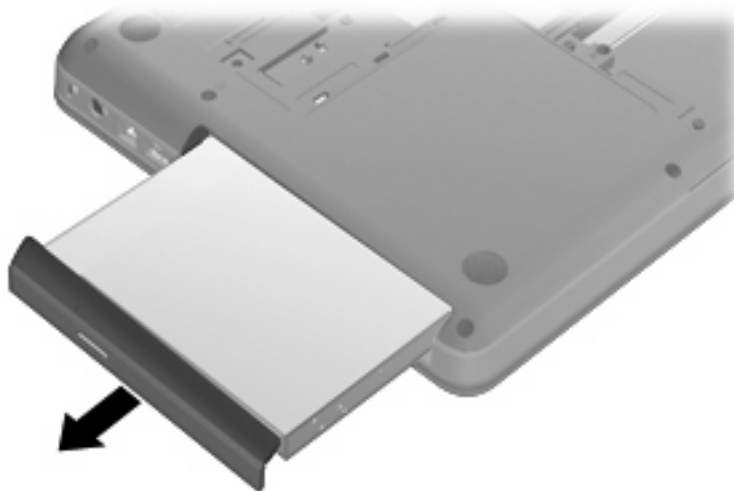

10. Replace the security screw.

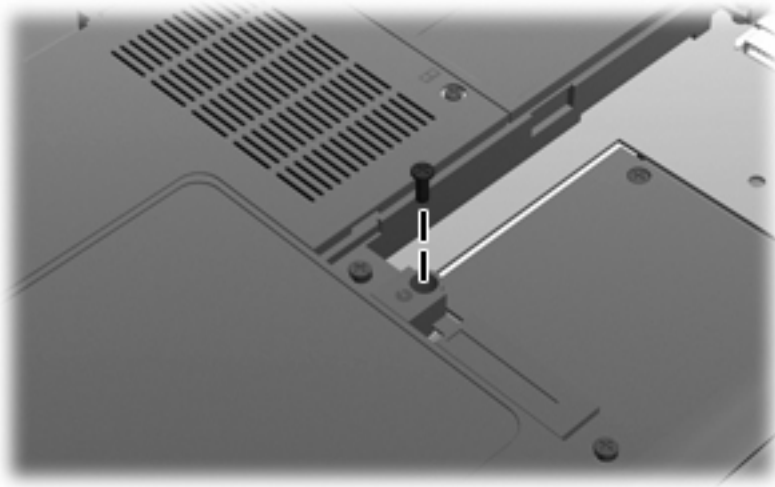

11. Align the tabs (1) on the hard drive cover with the notches on the computer, close the hard drive cover (2), and tighten the hard drive screws (3).

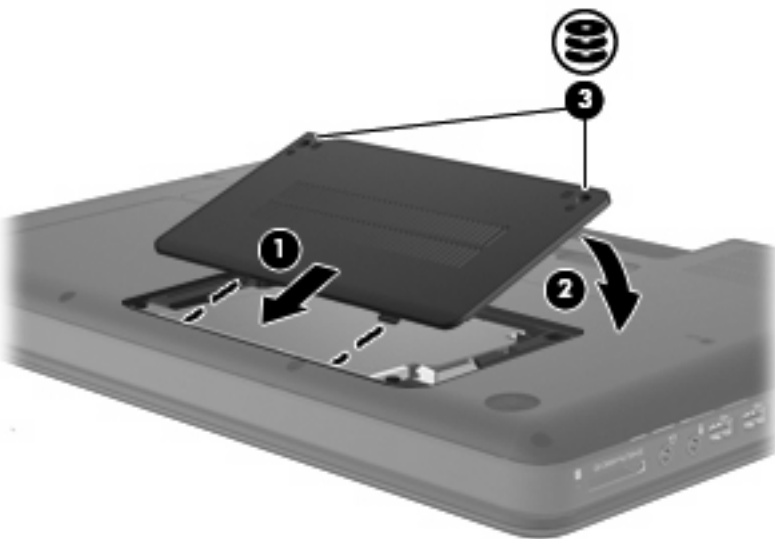

12. Reconnect external power and external devices.
13. Replace the battery, turn the computer over, and turn on the computer.

Webcam (select models only)

Your computer may include an integrated webcam, located at the top of the display. The webcam is an input device that allows you to capture and share video. Preinstalled CyberLink YouCam software provides new features that expand the webcam experience.

To access the webcam and CyberLink YouCam software, select **Start > All Programs > CyberLink YouCam > CyberLink YouCam**.

 **NOTE:** The first time you access the YouCam software, you may experience a brief delay as the software loads.

Using YouCam as your webcam software enables you to experiment with the following features:

- Video—Record and play back webcam video. You can also e-mail or upload video to YouTube, using the icon on the software interface.
- Streaming video—When you open your instant message program, YouCam displays a floating toolbar that lets you add graphic effects.
- Special effects—Add frames, filters, and emoticons to your snapshots and video.
- Snapshots—Take single frame or “burst” webcam shots in rapid succession.
- Connect—E-mail photos and video using the icon on the software interface.

 **NOTE:** For details about using webcam software, refer to the software manufacturer's instructions, which may be provided with the software, on disc, or on the manufacturer's Web site.

Webcam tips

For optimum performance, observe the following guidelines while using the webcam:

- Be sure that you have the latest version of an instant message program before starting a video conversation.
- The webcam may not work properly across some network firewalls.

 **NOTE:** If you are having trouble viewing or sending multimedia files to someone on another LAN or outside your network firewall, temporarily disable the firewall, perform the task you want to perform, and then reenable the firewall. Security may be compromised during the period that the firewall is disabled. To permanently resolve the problem, reconfigure the firewall as necessary, and adjust the policies and settings of other intrusion detection systems.

- Whenever possible, place bright light sources behind the camera and out of the picture area.

 **NOTE:** For details about using your webcam, click the Help menu in the webcam software.

Adjusting webcam properties

You can adjust webcam properties using the Properties dialog box, which is accessible from various programs that use the webcam, usually from a configuration, settings, or properties menu:

- **Brightness**—Controls the amount of light that is incorporated into the image. A higher brightness setting creates a brighter image; a lower brightness setting creates a darker image.
- **Contrast**—Controls the difference between lighter and darker areas on the image. A higher contrast setting intensifies the image; a lower contrast setting maintains more of the original information's dynamic range but leads to a flatter image.
- **Hue**—Controls the aspect of color that distinguishes it from another color (what makes a color red, green, or blue). Hue is distinct from saturation, which measures the intensity of the hue.
- **Saturation**—Controls the strength of color in the final image. A higher saturation setting creates a bolder image; a lower saturation setting creates a more subtle image.
- **Sharpness**—Controls the definition of edges in an image. A higher sharpness setting creates a more defined image; a lower sharpness setting creates a softer image.
- **Gamma**—Controls the contrast affecting the mid-level grays or midtones of an image. Adjusting the gamma of an image allows you to change the brightness values of the middle range of gray tones without dramatically altering the shadows and highlights. A lower gamma setting makes grays look black, and makes dark colors even darker.
- **Backlight Comp**—Compensates in cases where a subject with a large amount of background light would otherwise be obscured by streaking or silhouetting.

For information about using the webcam, select **Start > Help and Support**.

Troubleshooting

The following sections describe several common issues and solutions.

The optical disc tray does not open for removal of a CD, DVD, or BD

1. Insert the end of a paper clip (1) into the release access in the front bezel of the drive.
2. Press in gently on the paper clip until the disc tray is released, and then pull out the tray (2) until it stops.
3. Remove the disc (3) from the tray by gently pressing down on the spindle while lifting the outer edges of the disc. Hold the disc by the edges and avoid touching the flat surfaces.

 **NOTE:** If the tray is not fully accessible, tilt the disc carefully as you remove it.



4. Close the disc tray and place the disc in a protective case.

The computer does not detect the optical drive

If Windows does not detect an installed device, the device driver software may be missing or corrupted. If you suspect that the optical drive is not being detected, verify that the optical drive is listed in the Device Manager utility.

1. Remove any discs from the optical drive.
2. Click **Start > Control Panel > System and Security**. Then in the **System** area, click **Device Manager**.
3. In the Device Manager window, click the arrow next to DVD/CD-ROM drives to expand the list to show all of the installed drives.
4. Right-click the optical device listing to perform the following tasks:
 - Update driver software
 - Disable
 - Uninstall
 - Scan for hardware changes. Windows scans your system for installed hardware and installs any required drivers.
 - Click **Properties** to see if the device is working properly:
 - The Properties window provides details about the device to help you troubleshoot issues.
 - Click the **Driver** tab to update, disable, or uninstall drivers for this device.

A disc does not play

- Save your work and close all open programs before playing a CD or a DVD.
- Log off the Internet before playing a CD or a DVD.
- Be sure that you insert the disc properly.
- Be sure that the disc is clean. If necessary, clean the disc with filtered water and a lint-free cloth. Wipe from the center of the disc to the outer edge.
- Check the disc for scratches. If you find scratches, treat the disc with an optical disc repair kit available at many electronics stores.
- Disable Sleep mode before playing the disc.

Do not initiate Hibernation or Sleep while playing a disc. Otherwise, you may see a warning message asking if you want to continue. If this message is displayed, click **No**. After you click No, the computer may behave in either of the following ways:

- Playback may resume.
- or –
- The playback window in the multimedia program may close. To return to playing the disc, click the **Play** button in your multimedia program to restart the disc. In rare cases, you may need to exit the program and then restart it.
- Increase system resources:
 - Turn off external devices such as printers and scanners. Disconnecting these devices frees up valuable system resources and results in better playback performance.
 - Change desktop color properties. Because the human eye cannot easily tell the difference between colors beyond 16 bits, you should not notice any loss of color while watching a movie if you lower system color properties to 16-bit color, as follows:
 1. Right-click on a blank area of the computer desktop, and select **Screen resolution**.
 2. Select **Advanced Settings > Monitor** tab.
 3. Select **High Color (16 bit)**, if this setting is not already selected.
 4. Click **OK**.

A disc does not play automatically

1. Click **Start > Default Programs > Change AutoPlay Settings**.
2. Select the check box for **Use AutoPlay for all media and devices**.
3. Click **Save**.

A CD, DVD, or BD should now start automatically when it is inserted into the optical drive.

A movie stops, skips, or plays erratically

- Clean the disc.
- Conserve system resources by trying the following suggestions:
 - Log off the Internet.
 - Change the color properties of the desktop:
 1. Right-click on a blank area of the computer desktop, and select **Screen resolution**.
 2. Select **Advanced Settings > Monitor** tab.
 3. Select **High Color (16 bit)**, if this setting is not already selected.
 4. Click **OK**.
 - Disconnect external devices, such as a printer, scanner, camera, or handheld device.

A movie is not visible on an external display

1. If both the computer display and an external display are turned on, press **f4** one or more times to switch between the 2 displays.
2. Configure the monitor settings to make the external display primary:
 - a. Right-click on a blank area of the computer desktop, and select **Screen resolution**.
 - b. Specify a primary display and a secondary display.



NOTE: When using both displays, the DVD image will not appear on any display designated as the secondary display.

To get information about a multimedia question not covered in this guide, go to **Start > Help and Support**.

The process of burning a disc does not begin, or it stops before completion

- Be sure that all other programs are closed.
- Turn off Sleep mode and Hibernation.
- Be sure that you are using the right kind of disc for your drive. See the section “Selecting the right disc”, for more information about disc types.
- Be sure that the disc is inserted properly.
- Select a slower write speed and try again.
- If you are copying a disc, save the information on the source disc to your hard drive before trying to burn the contents to a new disc, and then burn from your hard drive.
- Reinstall the disc-burning device driver located in the DVD/CD-ROM drives category in Device Manager.

A DVD playing in Windows Media Player produces no sound or display

Use CyberLink PowerDVD 8 to play a DVD. CyberLink PowerDVD 8 is installed on the computer, and is also available from the HP Web site at <http://www.hp.com>.

A device driver must be reinstalled

1. Remove any discs from the optical drive.
2. Select **Start > Control Panel > System and Security**. Then in the **System** area, click **Device Manager**.
3. In the Device Manager window, click the arrow next to the type of driver you want to uninstall and then reinstall (for example, DVD/CD-ROMs, Modems, and so on).
4. Right-click the device listing and click **Uninstall**. When prompted, confirm that you want to delete the device, but do not restart the computer. Repeat for any other drivers you want to delete.
5. In the Device Manager window, click **Action**, and then click **Scan for hardware changes**. Windows scans your system for installed hardware and installs default drivers for any devices requiring drivers.

 **NOTE:** If you are prompted to restart the computer, save all open files, and then continue with the restart.

6. Reopen Device Manager, if necessary, and then verify that the drivers are once again listed.
7. Try running your program again.

If uninstalling and reinstalling the device drivers does not correct the problem, you may need to update your drivers using the procedures in the following sections.

Obtaining the latest HP device drivers

1. Open your Web browser, go to <http://www.hp.com/support>, and select your country or region.
2. Click the option for software and driver downloads, type your computer model number in the search box, and then press **enter**.
3. Click your specific product from the models listed.
4. Click the Windows 7 operating system.
5. When the list of drivers is displayed, click an updated driver to open a window containing additional information.
6. Click **Install now** to install the updated driver without downloading the file.

– or –

Click **Download only** to save the file to your computer. When prompted, click **Save** and then select a storage location on your hard drive.

After the file is downloaded, navigate to the folder where the file was stored, and double-click the file to install.

7. If prompted to do so, restart your computer after the installation is complete, and then verify the operation of the device.

Obtaining the latest Windows device drivers

You can obtain the latest Windows device drivers by using Windows Update. This feature can be set to automatically check for and install updates for the Windows operating system and other Microsoft products.

To use Windows Update:

1. Click **Start > All Programs > Windows Update**.

 **NOTE:** If you have not previously set up Windows Update, you will be prompted to enter settings before you can check for updates.

2. Click **Check for updates**.
3. Follow the on-screen instructions.

5 Power management

Setting power options

Using power-saving states

The computer has two power-saving states enabled at the factory: Sleep and Hibernation.

When Sleep is initiated, the power lights blink and the screen clears. Your work is saved to memory, letting you exit the Sleep state faster than exiting Hibernation. If the computer is in the Sleep state for an extended period or if the battery reaches a critical battery level while in the Sleep state, the computer initiates Hibernation.

When Hibernation is initiated, your work is saved to a hibernation file on the hard drive and the computer turns off.

△ **CAUTION:** To prevent possible audio and video degradation, loss of audio or video playback functionality, or loss of information, do not initiate Sleep or Hibernation while reading from or writing to a disc or an external media card.

📝 **NOTE:** You cannot initiate any type of networking connection or perform any computer functions while the computer is in the Sleep state or in Hibernation.

Initiating and exiting Sleep

The system is set at the factory to initiate Sleep after 15 minutes of inactivity when running on battery power and 30 minutes of inactivity when running on external power.

Power settings and timeouts can be changed using Power Options in Windows® Control Panel.

With the computer on, you can initiate Sleep in any of the following ways:

- Briefly press the power button.
- Close the display.
- Click **Start**, click the arrow next to the Shut down button, and then click **Sleep**.

You can exit Sleep in any of the following ways:

- Briefly press the power button.
- If the display is closed, open the display.
- Press a key on the keyboard or a button on the remote control.
- Activate the TouchPad.

When the computer exits Sleep, the power lights turn on and your work returns to the screen where you stopped working.

 **NOTE:** If you have set a password to be required when the computer exits Sleep, you must enter your Windows password before your work will return to the screen.

Initiating and exiting Hibernation

The system is set at the factory to initiate Hibernation after 1,080 minutes (18 hours) of inactivity when running on battery power, 1,080 minutes (18 hours) of inactivity when running on external power, or when the battery reaches a critical battery level.

Power settings and timeouts can be changed using Power Options in Windows Control Panel.

To initiate Hibernation:

▲ Click **Start**, click the arrow next to the Shut down button, and then click **Hibernate**.

To exit Hibernation:

▲ Briefly press the power button.

When the computer exits Hibernation, the power light turns on and your work returns to the screen where you stopped working.

 **NOTE:** If you have set a password to be required when the computer exits Hibernation, you must enter your Windows password before your work will return to the screen.

Using the battery meter

The battery meter is located in the notification area, at the far right of the taskbar. The battery meter allows you to quickly access power settings, view remaining battery charge, and select a different power plan.

- To display the percentage of remaining battery charge and the current power plan, move the pointer over the battery meter icon.
- To access Power Options or to change the power plan, click the battery meter icon and select an item from the list.

Different battery meter icons indicate whether the computer is running on battery or external power. The icon also displays a message if the battery has reached a low battery level, critical battery level, or reserve battery level.

To hide or display the battery meter icon:

1. Right-click the **Show hidden icons** icon (the arrow at the left side of the notification area).
2. Click **Customize notification icons**.
3. Under **Behaviors**, select **Show icons and notifications** for the Power icon.
4. Click **OK**.

Using power plans

A power plan is a collection of system settings that manages how the computer uses power. Power plans can help you conserve power and maximize computer performance.

The following power plans are available:

- HP recommended
- High performance
- Power saver

You can change the settings of these power plans through Power Options.

Viewing the current power plan

▲ Click the battery meter icon in the notification area, at the far right of the taskbar.

– or –

Select **Start > Control Panel > System and Security > Power Options**.

Selecting a different power plan

▲ Click the battery meter icon in the notification area, and then select a power plan from the list.

– or –

Select **Start > Control Panel > System and Security > Power Options**, and then select a power plan from the list.

Customizing power plans

1. Click the battery meter icon in the notification area and then click **Power options**.

– or –

Select **Start > Control Panel > System and Security > Power Options**.

2. Select a power plan, and then click **Change plan settings**.

3. Change the settings as needed.

4. To change additional settings, click **Change advanced power settings** and make your changes.

Setting password protection upon exiting Sleep or Hibernation

To set the computer to prompt for a password when the computer exits Sleep or Hibernation, follow these steps:

1. Select **Start > Control Panel > System and Security > Power Options**.

2. In the left pane, click **Require a password on wakeup**.

3. Click **Change Settings that are currently unavailable**.

4. Click **Require a password (recommended)**.

5. Click **Save changes**.

Using external AC power

External AC power is supplied through an approved AC adapter.

-
- ⚠ **WARNING!** To reduce potential safety issues, use only the AC adapter provided with the computer, a replacement AC adapter provided by HP, or a compatible AC adapter purchased from HP.
-

Connect the computer to external AC power under any of the following conditions:

-
- ⚠ **WARNING!** Do not charge the battery while you are onboard aircraft.
-

- When you are charging or calibrating a battery
- When you are installing or modifying system software
- When you are writing information to a CD or DVD

When you connect the computer to external AC power, the following events occur:

- The battery begins to charge.
- If the computer is turned on, the battery meter icon in the notification area changes appearance.

When you disconnect external AC power, the following events occur:

- The computer switches to battery power.
- The display brightness is automatically decreased to save battery life. To increase display brightness, press the **f3** action key or reconnect the AC adapter.

Connecting the AC adapter

-
- ⚠ **WARNING!** To reduce the risk of electric shock or damage to the equipment:
-

Plug the power cord into an AC outlet that is easily accessible at all times.

Disconnect power from the computer by unplugging the power cord from the AC outlet (not by unplugging the power cord from the computer).

If provided with a 3-pin attachment plug on the power cord, plug the cord into a grounded (earthed) 3-pin outlet. Do not disable the power cord grounding pin, for example, by attaching a 2-pin adapter. The grounding pin is an important safety feature.

To connect the computer to external AC power, follow these steps:

1. Plug the AC adapter into the power connector **(1)** on the computer.
2. Plug the power cord into the AC adapter **(2)**.

3. Plug the other end of the power cord into an AC outlet (3).

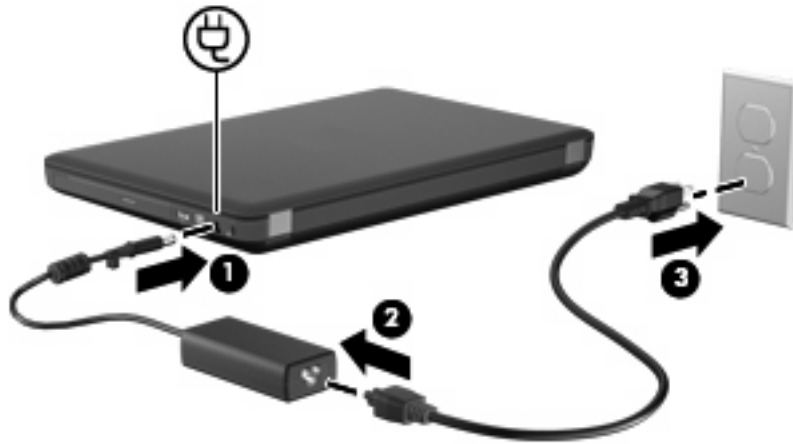

Testing an AC adapter

Test the AC adapter if the computer exhibits any of the following symptoms when it is connected to AC power:

- The computer does not turn on.
- The display does not turn on.
- The power light is off.

To test the AC adapter:

1. Remove the battery from the computer.
2. Connect the AC adapter to the computer, and then plug it into an AC outlet.
3. Turn on the computer.
 - If the power light turns **on**, the AC adapter is functioning properly.
 - If the power light remains **off**, the AC adapter is not functioning and should be replaced. Contact technical support for information on obtaining a replacement AC power adapter. Select **Start > Help and Support > Get assistance**.

Using battery power

When a charged battery is in the computer and the computer is not plugged into external power, the computer runs on battery power. When a charged battery is in the computer and the computer is plugged into external AC power, the computer runs on AC power.

If the computer contains a charged battery and is running on external AC power supplied through the AC adapter, the computer switches to battery power if the AC adapter is disconnected from the computer.

 **NOTE:** The display brightness is decreased to save battery life when you disconnect AC power. To increase display brightness, press the **f3** action key or reconnect the AC adapter.

You can keep a battery in the computer or in storage, depending on how you work. Keeping the battery in the computer whenever the computer is plugged into AC power charges the battery and also protects your work in case of a power outage. However, a battery in the computer slowly discharges when the computer is off and unplugged from external power.

⚠ **WARNING!** To reduce potential safety issues, use only the battery provided with the computer, a replacement battery provided by HP, or a compatible battery purchased from HP.

Battery life varies, depending on power management settings, programs running on the computer, display brightness, external devices connected to the computer, and other factors.

Displaying the remaining battery charge

- ▲ Move the pointer over the battery meter icon in the notification area, at the far right of the taskbar.

Finding battery information in Help and Support

Help and Support provides the following tools and information:

- Battery Check tool to test battery performance
- Information on calibration, power management, and proper care and storage to maximize battery life
- Information on battery types, specifications, life cycles, and capacity

To access battery information:

- ▲ Select **Start > Help and Support > Learn > Power Plans: Frequently Asked Questions**.

Using Battery Check

Help and Support provides information on the status of the battery installed in the computer.

To run Battery Check:

1. Connect the AC adapter to the computer.

📄 **NOTE:** The computer must be connected to external power for Battery Check to function properly.

2. Select **Start > Help and Support > Troubleshoot > Power, Thermal and Mechanical**.
3. Click the **Power** tab, and then click **Battery Check**.

Battery Check examines the battery and its cells to see if they are functioning properly, and then reports the results of the examination.

Inserting or removing the battery

⚠ **CAUTION:** Removing a battery that is the sole power source may cause loss of information. To prevent loss of information, save your work and initiate Hibernation or shut down the computer through Windows before removing the battery.

To insert the battery:

1. Turn the computer upside down on a flat surface.

2. Align the tabs on the battery with the notches on the computer, insert the battery (1), and then pivot the battery downward (2) into the battery bay. The battery release latch (3) automatically locks the battery into place.

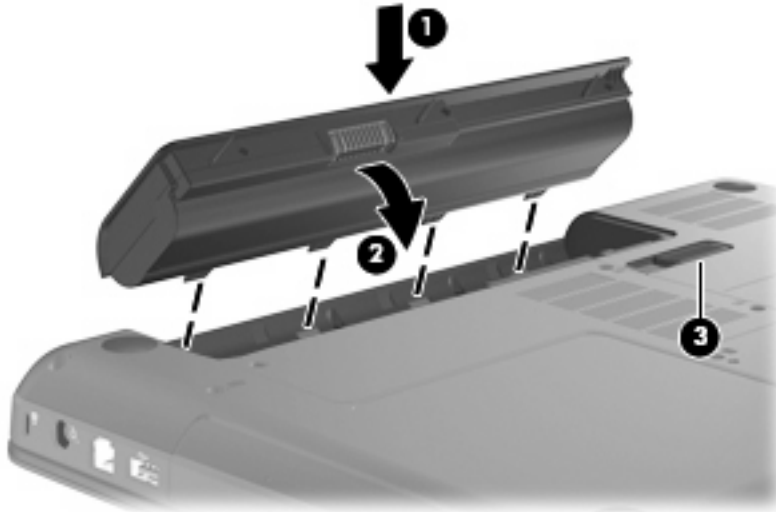

To remove the battery:

1. Turn the computer upside down on a flat surface.
2. Slide the battery release latch (1) to release the battery.
3. Pivot the battery (2) upward and remove it from the computer (3).

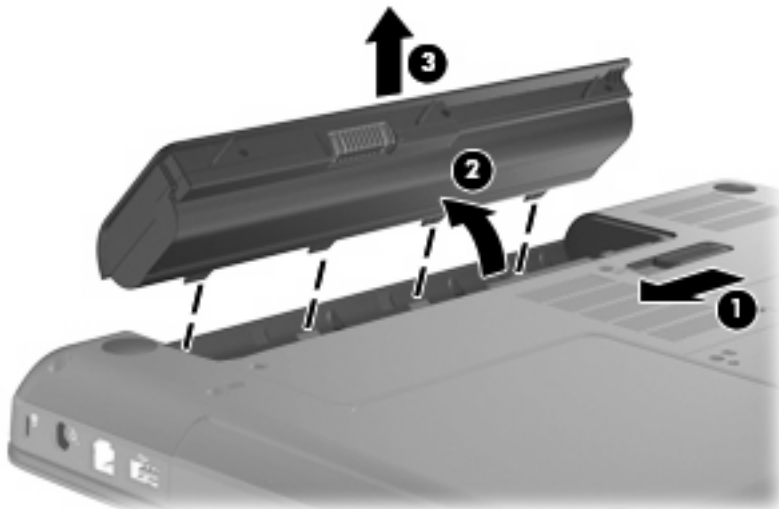

Charging a battery

⚠ **WARNING!** Do not charge the computer battery while you are onboard aircraft.

The battery charges whenever the computer is plugged into external power through an AC adapter or an optional power adapter.

The battery charges whether the computer is off or in use, but it charges faster when the computer is off.

Charging may take longer if a battery is new, has been unused for 2 weeks or more, or is much warmer or cooler than room temperature.

To prolong battery life and optimize the accuracy of battery charge displays, follow these recommendations:

- If you are charging a new battery, charge it fully before turning on the computer.

 **NOTE:** If the computer is on while the battery is charging, the battery meter in the notification area may show 100 percent charge before the battery is fully charged.

- Allow the battery to discharge below 5 percent of a full charge through normal use before charging it.
- If the battery has been unused for one month or more, calibrate the battery instead of simply charging it.

Maximizing battery discharge time

Battery discharge time varies depending on the features you use while on battery power. Maximum discharge time gradually shortens, as the battery storage capacity naturally degrades.

Tips for maximizing battery discharge time:

- Decrease the brightness on the display.
- Check the Power saver setting in Power Options.
- Remove the battery from the computer when it is not being used or charged.
- Store the battery in a cool, dry location.

Managing low battery levels

The information in this section describes the alerts and system responses set at the factory. Some low-battery alerts and system responses can be changed using Power Options in Windows Control Panel. Preferences set using Power Options do not affect lights.

Identifying low battery levels

The computer takes the following actions for a critical battery level:

- If Hibernation is enabled and the computer is on or in Sleep, the computer initiates Hibernation.
- If Hibernation is disabled and the computer is on or in Sleep, the computer remains briefly in Sleep, and then shuts down and loses any unsaved information.

Resolving a low battery level

△ **CAUTION:** To reduce the risk of losing information when the computer reaches a critical battery level and has initiated Hibernation, do not restore power until the power light turns off.

Resolving a low battery level when external power is available

- ▲ Connect one of the following devices:
 - AC adapter
 - Optional power adapter

Resolving a low battery level when a charged battery is available

1. Turn off the computer or initiate Hibernation.
2. Remove the discharged battery, and then insert a charged battery.
3. Turn on the computer.

Resolving a low battery level when no power source is available

- ▲ Initiate Hibernation.
– or –
Save your work and shut down the computer.

Resolving a low battery level when the computer cannot exit Hibernation

When the computer lacks sufficient power to exit Hibernation, follow these steps:

1. Insert a charged battery or plug the computer into external power.
2. Exit Hibernation by briefly pressing the power button.

Calibrating a battery

Calibrate a battery under the following conditions:

- When battery charge displays seem inaccurate
- When you observe a significant change in battery run time

Even if a battery is heavily used, it should not need to be calibrated more than once a month. It is also not necessary to calibrate a new battery.

Step 1: Fully charge the battery

△ **WARNING!** Do not charge the computer battery while you are onboard aircraft.

📝 **NOTE:** The battery charges whether the computer is off or in use, but it charges faster when the computer is off.

To fully charge the battery:

1. Insert the battery into the computer.
2. Connect the computer to an AC adapter or an optional power adapter, and then plug the adapter into external power.
3. Leave the computer plugged into external power until the battery is fully charged.

Step 2: Disable Hibernation and Sleep

1. Click the battery meter icon in the notification area, and then click **Power options**.
– or –
Select **Start > Control Panel > System and Security > Power Options**.
2. Under the current power plan, click **Change plan settings**.
3. Record the **Turn off the display** settings listed in the **On battery** column so that you can reset them after the calibration.
4. Change the **Turn off the display** settings to **Never**.
5. Click **Change advanced power settings**.
6. Click the plus sign next to **Sleep**, and then click the plus sign next to **Hibernate after**.
7. Record the **On battery** setting under **Hibernate after** so that you can reset it after the calibration.
8. Change the **On battery** setting to **Never**.
9. Click **OK**.
10. Click **Save changes**.

Step 3: Discharge the battery

The computer must remain on while the battery is being discharged. The battery can discharge whether or not you are using the computer, but the battery will discharge faster while you are using it.

- If you plan to leave the computer unattended during the discharge, save your information before beginning the discharge procedure.
- If you use the computer occasionally during the discharge procedure and have set energy-saving timeouts, expect the following performance from the system during the discharge process:
 - The monitor will not turn off automatically.
 - Hard drive speed will not decrease automatically when the computer is idle.
 - System-initiated Hibernation will not occur.

To discharge a battery:

1. Unplug the computer from its external power source, but do *not* turn off the computer.
2. Run the computer on battery power until the battery is discharged.

Step 4: Fully recharge the battery

To recharge the battery:

1. Plug the computer into external power and maintain external power until the battery is fully recharged.

You can use the computer while the battery is recharging, but the battery will charge faster if the computer is off.

2. If the computer is off, turn it on when the battery is fully charged.

Step 5: Reenable Hibernation and Sleep

△ **CAUTION:** Failure to reenable Hibernation after calibration may result in a full battery discharge and information loss if the computer reaches a critical battery level.

1. Click the battery meter icon in the notification area, and then click **Power options**.
– or –
Select **Start > Control Panel > System and Security > Power Options**.
2. Under the current power plan, click **Change plan settings**.
3. Reenter the settings that you recorded for the items in the **On battery** column.
4. Click **Change advanced power settings**.
5. Click the plus sign next to **Sleep**, and then click the plus sign next to **Hibernate after**.
6. Reenter the setting that you recorded for **On battery**.
7. Click **OK**.
8. Click **Save changes**.

Conserving battery power

- Select the Power saver power plan through Power Options under System and Security in Windows Control Panel.
- Turn off wireless and local area network (LAN) connections and exit modem applications when you are not using them.
- Disconnect external devices that are not plugged into an external power source, when you are not using them.
- Stop, disable, or remove any external media cards that you are not using.
- Use the **f2** action key to decrease brightness and the **f3** action key to increase brightness as needed.
- If you leave your work, initiate Sleep or Hibernation, or shut down the computer.

Storing a battery

△ **CAUTION:** To prevent damage to a battery, do not expose it to high temperatures for extended periods of time.

If a computer will be unused and unplugged from external power for more than 2 weeks, remove the battery and store it separately.

To prolong the charge of a stored battery, place it in a cool, dry place.

 **NOTE:** A stored battery should be checked every 6 months. If the capacity is less than 50 percent, recharge the battery before returning it to storage.

Calibrate a battery before using it if it has been stored for one month or more.

Disposing of a used battery

 **WARNING!** To reduce the risk of fire or burns, do not disassemble, crush, or puncture; do not short external contacts; do not dispose of in fire or water.

Refer to the *Regulatory, Safety and Environmental Notices* for battery disposal information.

Replacing the battery

Computer battery life varies, depending on power management settings, programs running on the computer, display brightness, external devices connected to the computer, and other factors.

Battery Check notifies you to replace the battery when an internal cell is not charging properly, or when the battery storage capacity has reached a weak condition. A message refers you to the HP Web site for more information about ordering a replacement battery. If the battery is possibly covered by an HP warranty, instructions include a warranty ID.

 **NOTE:** To ensure that you always have battery power when you need it, HP recommends purchasing a new battery when the storage capacity indicator turns green-yellow.

Shutting down the computer

 **CAUTION:** Unsaved information will be lost when the computer is shut down.

The Shut down command closes all open programs, including the operating system, and then turns off the display and computer.

Shut down the computer under any of the following conditions:

- When you need to replace the battery or access components inside the computer
- When you are connecting an external hardware device that does not connect to a USB port
- When the computer will be unused and disconnected from external power for an extended period

Although you can shut down the computer with the power button, the recommended procedure is to use the Windows Shut down command.

To shut down the computer, follow these steps:

 **NOTE:** If the computer is in the Sleep state or in Hibernation, you must first exit Sleep or Hibernation before shut down is possible.

1. Save your work and close all open programs.
2. Click **Start**.
3. Click **Shut down**.

If the computer is unresponsive and you are unable to use the preceding shut down procedures, try the following emergency procedures in the sequence provided:

- Press `ctrl+alt+delete`, and then click the **Power** button.
- Press and hold the power button for at least 5 seconds.
- Disconnect the computer from external power, and then remove the battery.

6 Drives

Handling drives

Drives are fragile computer components that must be handled with care. Refer to the following cautions before handling drives. Additional cautions are included with the procedures to which they apply.

△ **CAUTION:** To reduce the risk of damage to the computer, damage to a drive, or loss of information, observe these precautions:

Before you move a computer that is connected to an external hard drive, initiate Sleep and allow the screen to clear, or properly disconnect the external hard drive.

Before handling a drive, discharge static electricity by touching the unpainted metal surface of the drive.

Do not touch the connector pins on a removable drive or on the computer.

Handle a drive carefully; do not drop a drive or place items on it.

Before removing or inserting a drive, shut down the computer. If you are unsure whether the computer is off, in the Sleep state, or in Hibernation, turn the computer on and then shut it down through the operating system.

Do not use excessive force when inserting a drive into a drive bay.

An external hard drive must be connected to a USB port on the computer, not to a USB port on an external device such as a hub.

Do not type on the keyboard or move the computer while the optical drive is writing to a disc. The write process is sensitive to vibration.

When the battery is the only source of power, be sure that the battery is sufficiently charged before writing to media.

Avoid exposing a drive to temperature or humidity extremes.

Avoid exposing a drive to liquids. Do not spray the drive with cleaning products.

Remove media from a drive before removing the drive from the drive bay, or traveling with, shipping, or storing a drive.

If a drive must be mailed, place the drive in a bubble-pack mailer or other suitable protective packaging and label the package "FRAGILE."

Avoid exposing a drive to magnetic fields. Security devices with magnetic fields include airport walk-through devices and security wands. The airport security devices that check carry-on luggage, such as conveyor belts, use X-rays instead of magnetism and will not damage a drive.

Using external drives

Removable external drives expand your options for storing and accessing information. A USB drive can be added by connecting the drive to a USB port on the computer.

USB drives include the following types:

- 1.44-megabyte diskette drive
- Hard drive module (a hard drive with an adapter attached)
- DVD-ROM Drive
- DVD/CD-RW Combo Drive
- DVD±RW and CD-RW Combo Drive

 **NOTE:** For more information about required software and drivers, or to learn which computer port to use, refer to the manufacturer's instructions.

To connect an external drive to the computer:

△ **CAUTION:** To reduce the risk of damage to the equipment when connecting a powered drive, be sure that the AC power cord is unplugged.

1. Connect the drive to the computer.
2. If you are connecting a powered drive, plug the drive power cord into a grounded AC outlet.

To disconnect a powered drive, disconnect it from the computer, and then unplug the AC power cord.

Improving hard drive performance

Using Disk Defragmenter

As you use the computer, files on the hard drive become fragmented. Disk Defragmenter consolidates the fragmented files and folders on the hard drive so that the system can run more efficiently.

After you start Disk Defragmenter, it works without supervision. Depending on the size of your hard drive and the number of fragmented files, Disk Defragmenter may take more than an hour to complete. You may want to set it to run during the night or another time when you do not need access to your computer.

HP recommends defragmenting your hard drive at least once a month. You may set Disk Defragmenter to run on a monthly schedule, but you can defragment your computer manually at any time.

To run Disk Defragmenter:

1. Select **Start > All Programs > Accessories > System Tools > Disk Defragmenter**.
2. Click **Defragment disk**.

 **NOTE:** Windows® includes the User Account Control feature to improve the security of your computer. You may be prompted for your permission or password for tasks such as installing software, running utilities, or changing Windows settings. Refer to Help and Support for more information.

For additional information, refer to the Disk Defragmenter software Help.

Using Disk Cleanup

Disk Cleanup searches the hard drive for unnecessary files that you can safely delete to free up disk space and help the computer to run more efficiently.

To run Disk Cleanup:

1. Select **Start > All Programs > Accessories > System Tools > Disk Cleanup**.
2. Follow the on-screen instructions.

Replacing the hard drive

△ **CAUTION:** To prevent information loss or an unresponsive system:

Shut down the computer before removing the hard drive from the hard drive bay. Do not remove the hard drive while the computer is on, in the Sleep state, or in Hibernation.

If you are not sure whether the computer is off or in Hibernation, turn the computer on by pressing the power button. Then shut down the computer through the operating system.

To remove the hard drive:

1. Save your work.
2. Shut down the computer and close the display.
3. Disconnect all external devices connected to the computer.
4. Unplug the power cord from the AC outlet.
5. Turn the computer upside down on a flat surface.
6. Remove the battery from the computer.
7. With the hard drive bay toward you, loosen the 2 hard drive cover screws (1).
8. Lift the hard drive cover away from the computer (2).

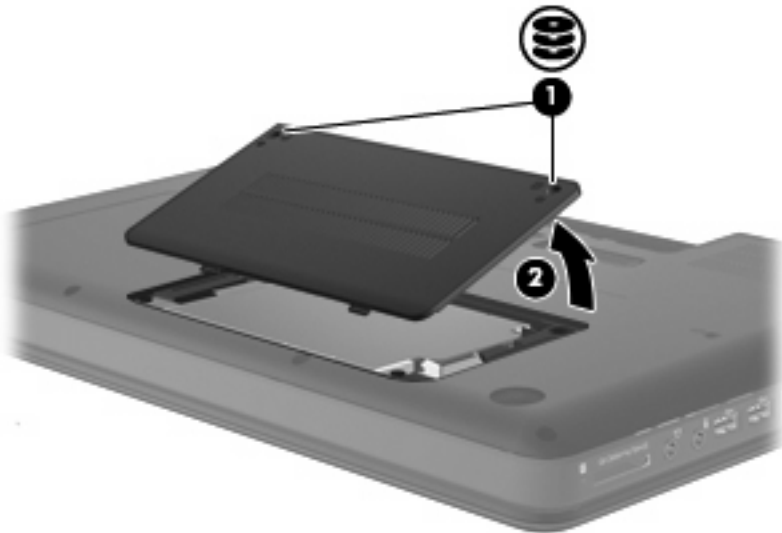

9. Remove the hard drive screws (1) and then drive and then lift the hard drive slightly (2).

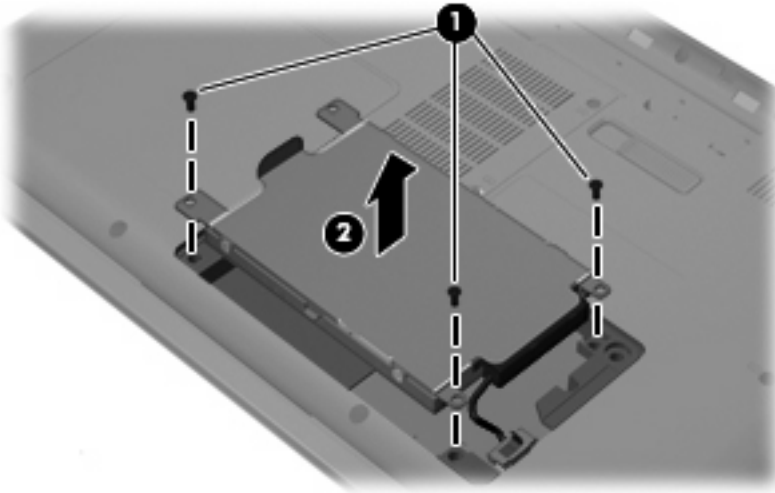

10. Disconnect the hard drive cable and lift the hard drive away from the computer.

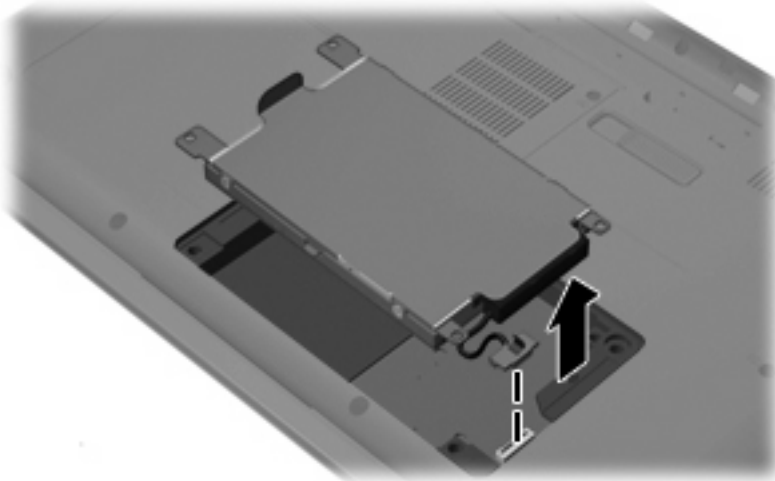

To install a hard drive:

1. Lower the hard drive into the hard drive bay and connect the hard drive cable.

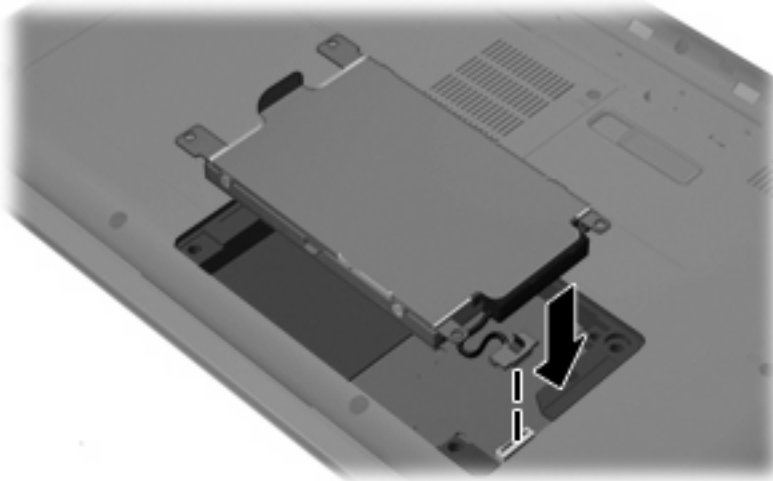

2. Snap the hard drive into place (1) and replace the hard drive screws (2).

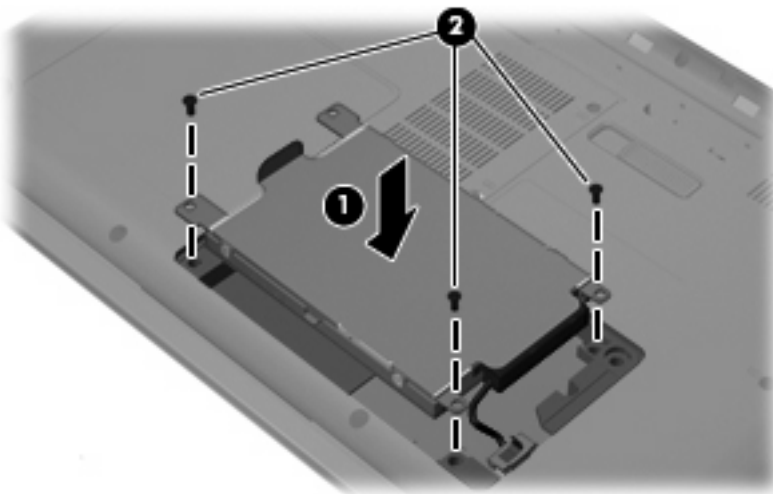

3. Align the tabs (1) on the hard drive cover with the notches on the computer.
4. Close the cover (2).

5. Tighten the hard drive cover screws (3).

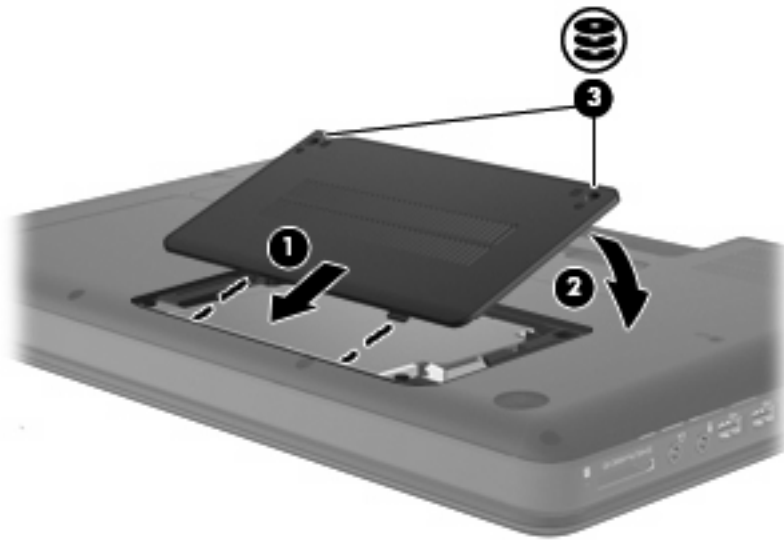

6. Replace the battery.
7. Turn the computer right-side up, and then reconnect external power and external devices.
8. Turn on the computer.

7 External devices and external media cards

Using a USB device

Universal Serial Bus (USB) is a hardware interface that can be used to connect an optional external device, such as a USB keyboard, mouse, drive, printer, scanner, or hub. Devices can be connected to the system.

Some USB devices may require additional support software, which is usually included with the device. For more information about device-specific software, refer to the manufacturer's instructions.

The computer has 3 USB ports, which support USB 1.0, USB 1.1, and USB 2.0 devices. An optional USB hub provides additional USB ports that can be used with the computer.

Connecting a USB device

△ **CAUTION:** To prevent damage to a USB connector, use minimal force to connect a USB device.

▲ To connect a USB device to the computer, connect the USB cable for the device to the USB port.



You will hear a sound when the device has been detected.

📄 **NOTE:** When you connect a USB device, you may see a message in the notification area to let you know that the device is recognized by the system.

Removing a USB device

△ **CAUTION:** To prevent loss of information or an unresponsive system, use the following procedure to safely remove a USB device.

CAUTION: To prevent damage to a USB connector, do not pull on the cable to remove the USB device.

To remove a USB device:

1. Click the **Safely Remove Hardware and Eject Media** icon in the notification area, at the far right of the taskbar.

 **NOTE:** To display the Safely Remove Hardware and Eject Media icon, click the **Show hidden icons** icon (the arrow at the left of the notification area).

2. Click the name of the device in the list.

 **NOTE:** You are prompted that it is safe to remove the device.

3. Remove the device.

Using Digital Media Slot cards

Optional digital cards provide secure data storage and convenient data sharing. These cards are often used with digital media–equipped cameras and PDAs as well as with other computers.

The Digital Media Slot supports the following digital card formats:

- Memory Stick (MS)
- Memory Stick Pro (MSP)
- MultiMediaCard (MMC)
- Secure Digital (SD) Memory Card
- xD-Picture Card (XD)

Inserting a digital card

△ **CAUTION:** To avoid damaging the digital card or the computer, do not insert any type of adapter into the Digital Media Slot.

CAUTION: To prevent damage to the digital card connectors, use minimal force to insert a digital card.

1. Hold the digital card label-side up, with the connectors facing the computer.
2. Insert the card into the Digital Media Slot, and then push in on the card until it is firmly seated.

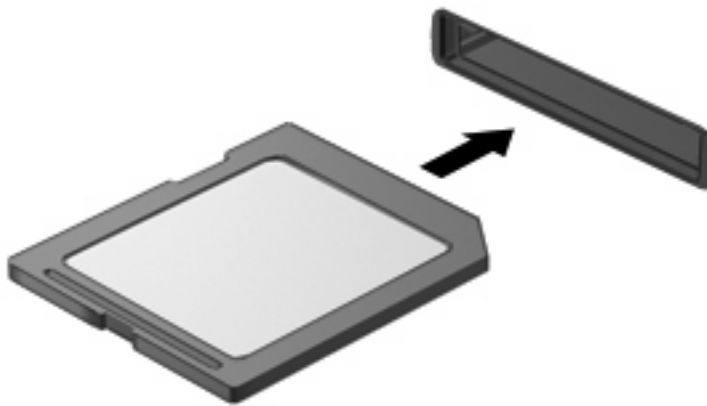

You will hear a sound when the device has been detected, and a menu of options may be displayed.

Removing a digital card

△ **CAUTION:** To prevent loss of data or an unresponsive system, use the following procedure to safely remove the digital card.

Save your information and close all programs associated with the digital card.

📝 **NOTE:** To stop a data transfer, click **Cancel** in the operating system Copying window.

To remove a digital card:

1. Click the **Safely Remove Hardware and Eject Media** icon in the notification area, at the far right of the taskbar.

📝 **NOTE:** To display the Safely Remove Hardware and Eject Media icon, click the **Show hidden icons** icon (the arrow at the left side of the notification area).

2. Click the name of the digital card in the list.

📝 **NOTE:** You are prompted that it is safe to remove the hardware device.

3. Press in on the digital card **(1)**, and then remove the card from the slot **(2)**.

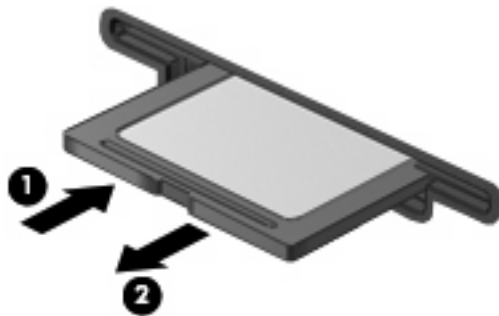

8 Memory modules

The computer has one memory module compartment, which is located on the bottom of the computer.

- △ **WARNING!** To reduce the risk of electric shock and damage to the equipment, unplug the power cord and remove all batteries before installing a memory module.
- △ **CAUTION:** Electrostatic discharge (ESD) can damage electronic components. Before beginning any procedure, ensure that you are discharged of static electricity by touching a grounded metal object.
- 📝 **NOTE:** To use a dual-channel configuration when adding a second memory module, be sure that both memory modules are the same size.

To add or replace a memory module:

1. Save your work.
2. Shut down the computer and close the display.

If you are not sure whether the computer is off or in Hibernation, turn the computer on by pressing the power button. Then shut down the computer through the operating system.

3. Disconnect all external devices connected to the computer.
4. Unplug the power cord from the AC outlet.
5. Turn the computer upside down on a flat surface.
6. Remove the battery from the computer.

7. Loosen the memory module compartment screws (1). Lift the memory module compartment cover (2) away from the computer.

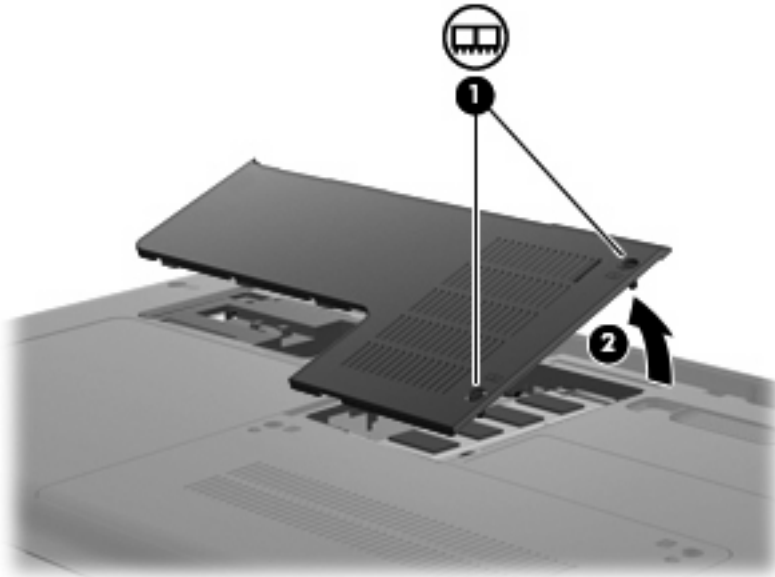

8. If you are replacing a memory module, remove the existing memory module:

- a. Pull away the retention clips (1) on each side of the memory module.
The memory module tilts up.

△ **CAUTION:** To prevent damage to the memory module, hold the memory module by the edges only. Do not touch the components on the memory module, and do not bend the memory module.

- b. Grasp the edge of the memory module (2), and gently pull the module out of the memory module slot.

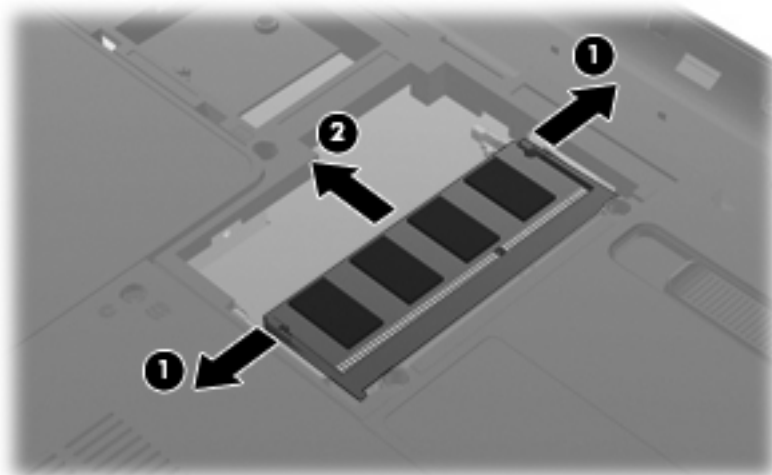

To protect a memory module after removal, place it in an electrostatic-safe container.

9. Insert a new memory module:

△ **CAUTION:** To prevent damage to the memory module, hold the memory module by the edges only. Do not touch the components on the memory module, and do not bend the memory module.

- a. Align the notched edge (1) of the memory module with the tab in the memory module slot.
- b. With the memory module at a 45-degree angle from the surface of the memory module compartment, press the module (2) into the memory module slot until it is seated.
- c. Gently press the memory module (3) down, applying pressure to both the left and right edges of the memory module, until the retention clips snap into place.

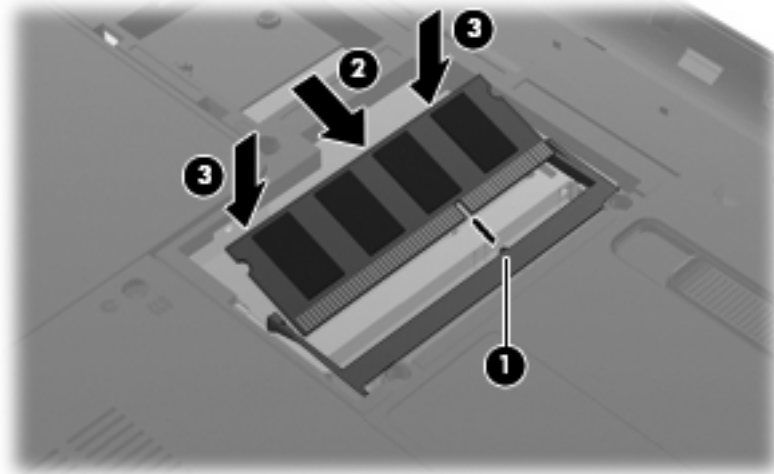

10. Align the tabs (1) on the memory module compartment cover with the notches on the computer.
11. Close the cover (2).
12. Tighten the memory module compartment screws (3).

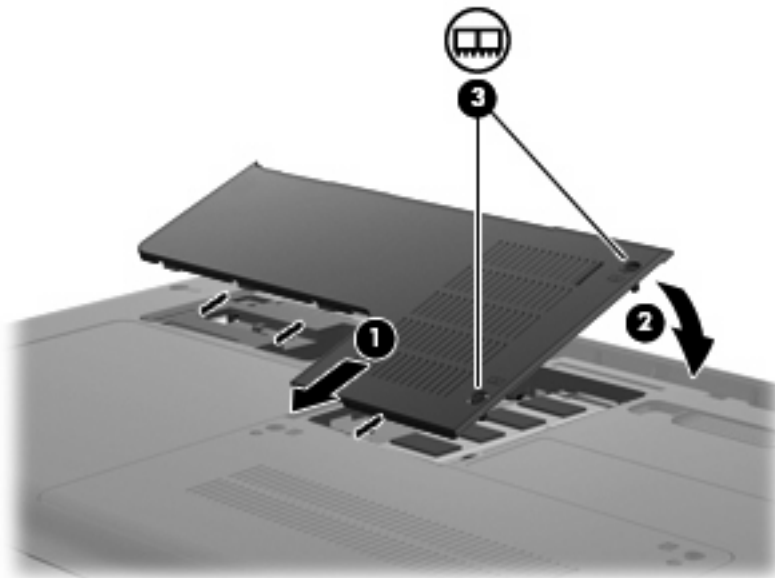

13. Replace the battery.

14. Turn the computer right-side up, and then reconnect external power and external devices.
15. Turn on the computer.

9 Security

Protecting the computer

Standard security features provided by the Windows operating system and the non-Windows Setup Utility can protect your personal settings and data from a variety of risks.

Follow the procedures in this chapter to use the following features:

- Passwords
- Firewall software
- Antivirus support (Norton Internet Security)
- Critical security updates

 **NOTE:** Security solutions are designed to act as deterrents, but they may not deter software attacks or prevent the computer from being mishandled or stolen.

NOTE: Before you send your computer for service, remove all password settings.

Computer risk	Security feature
Unauthorized use of the computer	<ul style="list-style-type: none">• Power-on password
Unauthorized access to data	<ul style="list-style-type: none">• Firewall software• Windows updates
Unauthorized access to Setup Utility, BIOS settings, and other system identification information	Administrator password
Ongoing or future threats to the computer	Critical security updates from Microsoft
Unauthorized access to a Windows user account	User password

Using passwords

A password is a group of characters that you choose to secure your computer information. Several types of passwords can be set, depending on how you want to control access to your information. Passwords can be set in Windows or in the non-Windows Setup Utility preinstalled on the computer.

 **CAUTION:** To prevent being locked out of the computer, record each password you set. Because most passwords are not displayed as they are set, changed, or deleted, it is essential to record each password immediately and store it in a secure place.

You can use the same password for a Setup Utility feature and for a Windows security feature. You can also use the same password for more than one Setup Utility feature.

Use the following guidelines when setting a password in Setup Utility:

- A password can be any combination of up to 8 letters and numbers and is case sensitive.
- A password set in Setup Utility must be entered at a Setup Utility prompt. A password set in Windows must be entered at a Windows prompt.

Use the following tips for creating and saving passwords:

- When creating passwords, follow requirements set by the program.
- Write down your passwords and store them in a secure place away from the computer.
- Do not store passwords in a file on the computer.
- Do not use your name or other personal information that could be easily discovered by an outsider.

The following sections list Windows and Setup Utility passwords and describe their functions. For additional information about Windows passwords, such as screen-saver passwords, select **Start > Help and Support**.

Setting passwords in Windows

Password	Function
Administrator password	Protects administrator-level access to computer contents. NOTE: This password cannot be used to access Setup Utility contents.
User password	Protects access to a Windows user account. It also protects access to the computer contents and must be entered when you exit Sleep or Hibernation.

Setting passwords in Setup Utility

Password	Function
Administrator password*	<ul style="list-style-type: none">• Protects access to Setup Utility.• After this password is set, it must be entered each time you access Setup Utility. CAUTION: If you forget your administrator password, you cannot access Setup Utility.
Power-on password*	<ul style="list-style-type: none">• Protects access to the computer contents.• After this password is set, it must be entered each time you turn on or restart the computer, or exit Hibernation. CAUTION: If you forget your power-on password, you cannot turn on or restart the computer, or exit Hibernation.

*For details about each of these passwords, refer to the following topics.

Administrator password

Your administrator password protects the configuration settings and system identification information in Setup Utility. After this password is set, you must enter it each time you access Setup Utility.

Your administrator password is not interchangeable with an administrator password set in Windows, nor is it displayed as it is set, entered, changed, or deleted. Be sure that you record your password and store it in a safe place.

Managing an administrator password

To set, change, or delete this password, follow these steps:

1. Open Setup Utility by turning on or restarting the computer, and then pressing **f10** while the “F10 = BIOS Setup Options” message is displayed in the lower-left corner of the screen.
2. Use the arrow keys to select **Security > Set Administrator Password**, and then press **enter**.
 - To set an administrator password, type your password in the **Enter New Password** and **Confirm New Password** fields, and then press **enter**.
 - To change an administrator password, type your current password in the **Enter Current Password** field, type a new password in the **Enter New Password** and **Confirm New Password** fields, and then press **enter**.
 - To delete an administrator password, type your current password in the **Enter Password** field, and then press **enter** 4 times.
3. To save your changes and exit Setup Utility, use the arrow keys to select **Exit > Exit Saving Changes**.

Your changes go into effect when the computer restarts.

Entering an administrator password

At the **Enter Password** prompt, type your administrator password, and then press **enter**. After 3 unsuccessful attempts to enter the administrator password, you must restart the computer and try again.

Power-on password

Your power-on password prevents unauthorized use of the computer. After this password is set, it must be entered each time you turn on or restart the computer, or exit Hibernation. A power-on password is not displayed as it is set, entered, changed, or deleted.

Managing a power-on password

To set, change, or delete this password, follow these steps:

1. Open Setup Utility by turning on or restarting the computer, and then pressing **f10** while the “F10 = BIOS Setup Options” message is displayed in the lower-left corner of the screen.
2. Use the arrow keys to select **Security > Set Power-On Password**, and then press **enter**.
 - To set a power-on password, type your password in the **Enter New Password** and **Confirm New Password** fields, and then press **enter**.
 - To change a power-on password, type your current password in the **Enter Current Password** field, type a new password in the **Enter New Password** and **Confirm New Password** fields, and then press **enter**.
 - To delete a power-on password, type your current password in the **Enter Current Password** field, and then press **enter** 4 times.
3. To save your changes and exit Setup Utility, use the arrow keys to select **Exit > Exit Saving Changes**.

Your changes go into effect when the computer restarts.

Entering a power-on password

At the **Enter Password** prompt, type your password, and then press **enter**. After 3 unsuccessful attempts to enter the password, you must restart the computer and try again.

Using antivirus software

When you use the computer for e-mail or Internet access, you expose it to computer viruses that can disable the operating system, programs, or utilities or cause them to function abnormally.

Antivirus software can detect most viruses, destroy them, and in most cases, repair damage they have caused. To provide ongoing protection against newly discovered viruses, antivirus software must be kept up to date.

Norton Internet Security, an antivirus program, is preinstalled on the computer.

- Your version of Norton Internet Security includes 60 days of free updates. It is strongly recommended that you protect the computer against new viruses beyond 60 days by purchasing extended update service. Instructions for using and updating Norton Internet Security software and for purchasing extended update service are provided within the program.
- To access Norton Internet Security, or to get more information about it, click **Start > All Programs > Norton Internet Security**.

 **NOTE:** HP recommends that you always update the antivirus software to help protect your computer.

NOTE: For more information about computer viruses, type `viruses` in the Search box in Help and Support.

Using firewall software

When you use the computer for e-mail, network, or Internet access, unauthorized persons may be able to gain access to the computer, your personal files, and information about you. Use the firewall software preinstalled on the computer to protect your privacy.

Firewall features include logging and reporting of network activity, and automatic monitoring of all incoming and outgoing traffic. Refer to the firewall user guide or contact your firewall manufacturer for more information.

 **NOTE:** Under some circumstances a firewall can block access to Internet games, interfere with printer or file sharing on a network, or block authorized e-mail attachments. To temporarily resolve the problem, disable the firewall, perform the task that you want to perform, and then reenable the firewall. To permanently resolve the problem, reconfigure the firewall.

Installing critical updates

△ **CAUTION:** Microsoft sends alerts regarding critical updates. To protect the computer from security breaches and computer viruses, install all critical updates from Microsoft as soon as you receive an alert.

Updates to the operating system and other software may have become available after the computer was shipped. To be sure that all available updates are installed on the computer, observe these guidelines:

- Run Windows Update as soon as possible after you set up your computer. Use the update link at **Start > All Programs > Windows Update**.
- Run Windows Update at regular intervals, such as once a month.
- Obtain updates to Windows and other Microsoft programs, as they are released, from the Microsoft Web site and through the updates link in Help and Support.

10 Setup Utility (BIOS)

Starting Setup Utility

Setup Utility is a ROM-based information and customization utility that can be used even when your Windows® operating system is not working.

The utility reports information about the computer and provides settings for startup, security, and other preferences.

To start Setup Utility:

- ▲ Open Setup Utility by turning on or restarting the computer. While the “Press the ESC key for Startup Menu” message is displayed in the lower-left corner of the screen, press **f10**.

– or –

1. Open Setup Utility by turning on or restarting the computer. While the “Press the ESC key for Startup Menu” message is displayed in the lower-left corner of the screen, press **esc**.
2. When the Startup Menu is displayed, press **f10**.

Using Setup Utility

Changing the language of Setup Utility

The following procedure explains how to change the language of Setup Utility. If Setup Utility is not already running, begin at step 1. If Setup Utility is already running, begin at step 2.

1. Open Setup Utility by turning on or restarting the computer. While the “Press the ESC key for Startup Menu” message is displayed in the lower-left corner of the screen, press **f10**.
– or –
Open Setup Utility by turning on or restarting the computer. While the “Press the ESC key for Startup Menu” message is displayed in the lower-left corner of the screen, press **esc**. When the Startup Menu is displayed, press **f10**.
2. Use the arrow keys to select **System Configuration > Language**, and then press **enter**.
3. Use the arrow keys to select a language, and then press **enter**.
4. When a confirmation prompt with your language selected is displayed, press **enter**.
5. To save your change and exit Setup Utility, use the arrow keys to select **Exit > Exit Saving Changes**, and then press **enter**.

Your change goes into effect immediately.

Navigating and selecting in Setup Utility

Because Setup Utility is not Windows based, it does not support the TouchPad. Navigation and selection are by keystroke.

- To choose a menu or a menu item, use the arrow keys.
- To choose an item in a list or to toggle a field, for example an Enable/Disable field, use either the arrow keys or **f5** or **f6**.
- To select an item, press **enter**.
- To close a text box or return to the menu display, press **esc**.
- To display additional navigation and selection information while Setup Utility is open, press **f1**.

Displaying system information

The following procedure explains how to display system information in Setup Utility. If Setup Utility is not open, begin at step 1. If Setup Utility is open, begin at step 2.

1. Open Setup Utility by turning on or restarting the computer. While the “Press the ESC key for Startup Menu” message is displayed in the lower-left corner of the screen, press **f10**.

– or –

Open Setup Utility by turning on or restarting the computer. While the “Press the ESC key for Startup Menu” message is displayed in the lower-left corner of the screen, press **esc**. When the Startup Menu is displayed, press **f10**.

2. Select the **Main** menu. System information such as the system time and date, and identification information about the computer is displayed.
3. To exit Setup Utility without changing any settings, use the arrow keys to select **Exit > Exit Discarding Changes**, and then press **enter**.

Restoring default settings in Setup Utility

The following procedure explains how to restore Setup Utility default settings. If Setup Utility is not already running, begin at step 1. If Setup Utility is already running, begin at step 2.

1. Open Setup Utility by turning on or restarting the computer. While the “Press the ESC key for Startup Menu” message is displayed in the lower-left corner of the screen, press **f10**.

– or –

Open Setup Utility by turning on or restarting the computer. While the “Press the ESC key for Startup Menu” message is displayed in the lower-left corner of the screen, press **esc**. When the Startup Menu is displayed, press **f10**.

2. Use the arrow keys to select **Exit > Load Setup Defaults**, and then press **enter**.
3. When the Setup Confirmation is displayed, press **enter**.
4. To save your change and exit Setup Utility, use the arrow keys to select **Exit > Exit Saving Changes**, and then press **enter**.

Setup Utility default settings go into effect when the computer restarts.

 **NOTE:** Your password, security, and language settings are not changed when you restore the factory default settings.

Exiting Setup Utility

You can exit Setup Utility with or without saving changes.

- To exit Setup Utility and save your changes from the current session:

If the Setup Utility menus are not visible, press **esc** to return to the menu display. Then use the arrow keys to select **Exit > Exit Saving Changes**, and then press **enter**.

- To exit Setup Utility without saving your changes from the current session:

If the Setup Utility menus are not visible, press **esc** to return to the menu display. Then use the arrow keys to select **Exit > Exit Discarding Changes**, and then press **enter**.

After either choice, the computer restarts in Windows.

Setup Utility menus

The menu tables in this section provide an overview of Setup Utility options.

 **NOTE:** Some of the Setup Utility menu items listed in this chapter may not be supported by your computer.

Main menu

Select	To do this
System information	<ul style="list-style-type: none">• View and change the system time and date.• View identification information about the computer.• View specification information about the processor, memory size, system BIOS, and keyboard controller version (select models only).

Security menu

Select	To do this
Administrator password	Enter, change, or delete an administrator password.
Power-On Password	Enter, change, or delete a power-on password.

System Configuration menu

Select	To do this
Language Support	Change the language of Setup Utility.
Button Sound (select models only)	Enable/disable the capacitive button tapping sound.
Virtualization Technology (select models only)	Enable/disable the processor Virtualization Technology.
Processor C6 State (select models only)	Enable/disable the processor C6 sleep state.
LAN Power Saving (select models only)	Enable/disable LAN Power Saving. When enabled, saves power when the computer is in DC mode.
Card Reader/1394 Power Saving (select models only)	Enable/disable Card Reader/1394 Power Saving.
Fan Always On	Enabled/disable Fan Always On. When enabled, the computer fan will always be on.
Action Keys Mode	Enable/disable Action Keys Mode
Boot Options	Set the following boot options: <ul style="list-style-type: none">• POST hotkey delay (sec.)—Set the delay for the f1, f2, f9, f10, f11, and f12 functions of Setup Utility in intervals of 5 seconds each (0, 5, 10, 15, 20).• CD-ROM Boot—Enable/disable boot from CD-ROM.• Floppy Boot—Enable/disable boot from diskette.• Internal Network Adapter Boot—Enable/disable boot from the internal network adapter.• Boot Order—Set the boot order for:<ul style="list-style-type: none">◦ Notebook Hard Drive◦ Internal CD/DVD ROM Drive◦ USB Diskette on Key/USB Hard Disk◦ USB CD/DVD ROM Drive◦ USB Floppy◦ Network Adapter

Diagnostics menu

Select	To do this
Hard Disk Self Test	Run a comprehensive self-test on the hard drive. NOTE: On models with two hard drives, this menu option is called the Primary Hard Disk Self Test .
Secondary Hard Disk Self Test (select models only)	Run a comprehensive self-test on a secondary hard drive.
Memory Test	Run a diagnostic test on the system memory.

11 Software updates

Updated versions of the software provided with your computer may be available on the HP Web site.

Most software and BIOS updates on the HP Web site are packaged in compressed files called *SoftPaqs*.

Some download packages contain a file named Readme.txt, which contains information regarding installing and troubleshooting the file.

To update the software, follow these steps, which are explained in the remainder of this guide:

1. Identify your computer model, product category, and series or family. Prepare for a system BIOS update by identifying the BIOS version currently installed on the computer.

If your computer is connected to a network, consult the network administrator before installing any software updates, especially system BIOS updates.

 **NOTE:** The computer system BIOS is stored on the system ROM. The BIOS initializes the operating system, determines how the computer will interact with the hardware devices, and provides for data transfer among hardware devices, including the time and date.

NOTE: Windows® includes the User Account Control feature to improve the security of your computer. You may be prompted for your permission or password for tasks such as installing software, running utilities, or changing Windows settings. Refer to Help and Support for more information.

2. Access the updates on the HP Web site at <http://www.hp.com>.
3. Install the updates.

Updating the BIOS

To update the BIOS, first determine what BIOS version you currently have and then download and install the new BIOS.

Determining the BIOS version

To determine whether available BIOS updates contain later BIOS versions than those currently installed on the computer, you need to know the version of the system BIOS currently installed.

BIOS version information (also known as *ROM date* and *System BIOS*) can be displayed by pressing **fn+esc** (if you are already in Windows) or by opening Setup Utility.

To use Setup Utility for displaying BIOS information:

1. Open Setup Utility by turning on or restarting the computer. While the “Press the ESC key for Startup Menu” message is displayed in the lower-left corner of the screen, press **f10**.
2. If Setup Utility does not open with the system information displayed, use the arrow keys to select the **Main** menu.

When the Main menu is selected, BIOS and other system information is displayed.

3. To exit Setup Utility, use the arrow keys to select **Exit > Exit Discarding Changes**, and then press **enter**.

Downloading a BIOS update

- △ **CAUTION:** To prevent damage to the computer or an unsuccessful installation, download and install a BIOS update only when the computer is connected to reliable external power using the AC adapter. Do not download or install a BIOS update while the computer is running on battery power or connected to an optional power source. During the download and installation, follow these instructions:

Do not disconnect power from the computer by unplugging the power cord from the AC outlet.

Do not shut down the computer or initiate Sleep or Hibernation.

Do not insert, remove, connect, or disconnect any device, cable, or cord.

To download a BIOS update:

1. Access the page on the HP Web site that provides software for your computer:
Select **Start > Help and Support > Maintain > Software Updates**.
2. Follow the instructions on the screen to identify your computer and access the BIOS update you want to download.
3. At the download area, follow these steps:
 - a. Identify the BIOS update that is later than the BIOS version currently installed on your computer. Make a note of the date, name, or other identifier. You may need this information to locate the update later, after it has been downloaded to your hard drive.
 - b. Follow the instructions on the screen to download your selection to the hard drive.

Make a note of the path to the location on your hard drive where the BIOS update will be downloaded. You will need to access this path when you are ready to install the update.

-  **NOTE:** If you connect your computer to a network, consult the network administrator before installing any software updates, especially system BIOS updates.

BIOS installation procedures vary. Follow any instructions that are displayed on the screen after the download is complete. If no instructions are displayed, follow these steps:

1. Open Windows Explorer by selecting **Start > Computer**.
2. Double-click your hard drive designation. The hard drive designation is typically Local Disk (C:).
3. Using the hard drive path you recorded earlier, open the folder on your hard drive that contains the update.
4. Double-click the file that has an .exe extension (for example, *filename.exe*).
5. Complete the installation by following the instructions on the screen.

The BIOS installation begins.

The system automatically shuts down after the BIOS has successfully updated.

-  **NOTE:** After a message on the screen reports a successful installation, you can delete the downloaded file from your hard drive.

Updating programs and drivers

To download and install software other than a BIOS update, follow these steps:

To use the HP Web site:

1. Open your Web browser, go to <http://www.hp.com/support>, and select your country or region.
2. Click the option for software and driver downloads, type your computer model number in the Search box, and then press **enter**.
3. Click your specific product from the models listed.
4. Select your operating system.
5. When the list of drivers is displayed, click an updated driver to open a window containing additional information.
6. Click **Install now** to install the updated driver.

 **NOTE:** In some cases, you may be able to download the driver and install it later. To do this, click **Download only** to save the file to your computer. When prompted, click **Save** and then select a storage location on your hard drive. After the file is downloaded, navigate to the folder where the file was stored, and double-click the file to install.

7. If prompted to do so, restart your computer after the installation is complete, and then verify the operation of the device.

12 Backup and recovery

Recovery after a system failure is as complete as your most current backup. HP recommends that you create recovery discs immediately after software setup. As you add new software and data files, you should continue to back up your system on a regular basis to maintain a reasonably current backup.

Tools provided by the operating system and HP Recovery Manager software are designed to help you with the following tasks for safeguarding your information and restoring it in case of a system failure:

- Creating a set of recovery discs (Recovery Manager software feature). Recovery discs are used to start up (boot) your computer and restore the operating system and software programs to factory settings in case of system failure or instability.
- Backing up your information regularly to protect your important system files.
- Creating system restore points (operating system feature). System restore points allow you to reverse undesirable changes to your computer by restoring the computer to an earlier state.
- Recovering a program or driver (Recovery Manager software feature). This feature helps you reinstall a program or driver without performing a full system recovery.
- Performing a full system recovery (Recovery Manager software feature). With Recovery Manager, you can recover your full factory image if you experience system failure or instability. Recovery Manager works from a dedicated recovery partition (select models only) on the hard drive or from recovery discs you create.

 **NOTE:** Computers with a solid-state drive (SSD) may not have a recovery partition. Recovery discs have been included for computers that do not have a partition. Use these discs to recover your operating system and software. To check for the presence of a recovery partition, select **Start**, right-click **Computer**, click **Manage**, and then click **Disk Management**. If the partition is present, an HP Recovery drive is listed in the window.

Creating recovery discs

HP recommends that you create recovery discs to be sure that you can restore your system to its original factory state if you experience serious system failure or instability. Create these discs after setting up the computer for the first time.

Handle these discs carefully and keep them in a safe place. The software allows the creation of only one set of recovery discs.

 **NOTE:** You can use an optional external optical drive (purchased separately) to create recovery discs, or you can purchase recovery discs for your computer from the HP Web site.

Note the following guidelines before creating recovery discs:

 **NOTE:** The external hard drive must be connected to a USB port on the computer, not to a USB port on an external device such as a hub.

- You will need high-quality DVD-R, DVD+R, BD-R (writable Blu-ray), or CD-R discs. All these discs are purchased separately. DVDs and BDs have a much higher capacity than CDs. If you use CDs, up to 20 discs may be required, whereas only a few DVDs or BDs are required.

 **NOTE:** Read-write discs, such as CD-RW, DVD±RW, double-layer DVD±RW, and BD-RE (rewritable Blu-ray) discs, are not compatible with the Recovery Manager software.

- The computer must be connected to AC power during this process.
- Only one set of recovery discs can be created per computer.
- Number each disc before inserting it into the optical drive.
- If necessary, you can exit the program before you have finished creating the recovery discs. The next time you open Recovery Manager, you will be prompted to continue the disc creation process.

To create a set of recovery discs:

1. Select **Start > All Programs > Recovery Manager > Recovery Disk Creation**.
2. Follow the on-screen instructions.

Backing up your information

As you add new software and data files, you should back up your system on a regular basis to maintain a reasonably current backup. Back up your system at the following times:

- At regularly scheduled times

 **NOTE:** Set reminders to back up your information periodically.

- Before the computer is repaired or restored
- Before you add or modify hardware or software

Note the following when backing up:

- Create system restore points using the Windows® System Restore feature, and periodically copy them to disc.
- Store personal files in the Documents library and back up this folder periodically.
- Back up templates stored in their associated programs.
- Save customized settings in a window, toolbar, or menu bar by taking a screen shot of your settings. The screen shot can be a time-saver if you have to reset your preferences.

To copy the screen and paste it into a word-processing document, follow these steps:

1. Display the screen.
 2. Copy the screen:
To copy only the active window, press **alt+prt sc**.
To copy the entire screen, press **prt sc**.
 3. Open a word-processing document, and then select **Edit > Paste**.
 4. Save the document.
- You can back up your information to an optional external hard drive, a network drive, or discs.
 - When backing up to discs, use any of the following types of discs (purchased separately): CD-R, CD-RW, DVD+R, DVD-R, or DVD±RW. The discs you use will depend on the type of optical drive installed in your computer.

 **NOTE:** DVDs store more information than CDs, so using them for backup reduces the number of recovery discs required.

- When backing up to discs, number each disc before inserting it into the optical drive of the computer.

Using Windows Backup and Restore

To create a backup using Windows Backup and Restore, follow these steps:

 **NOTE:** Be sure that the computer is connected to AC power before you start the backup process.

NOTE: The backup process may take over an hour, depending on file size and the speed of the computer.

1. Select **Start > All Programs > Maintenance > Backup and Restore**.
2. Follow the on-screen instructions to set up and create a backup.

 **NOTE:** Windows® includes the User Account Control feature to improve the security of your computer. You may be prompted for your permission or password for tasks such as installing software, running utilities, or changing Windows settings. Refer to Help and Support for more information.

Using system restore points

When you back up your system, you are creating a system restore point. A system restore point allows you to save and name a snapshot of your hard drive at a specific point in time. You can then recover back to that point if you want to reverse subsequent changes made to your system.

 **NOTE:** Recovering to an earlier restore point does not affect data files saved or e-mails created since the last restore point.

You also can create additional restore points to provide increased protection for your system files and settings.

When to create restore points

- Before you add or extensively modify software or hardware
- Periodically, whenever the system is performing optimally

 **NOTE:** If you revert to a restore point and then change your mind, you can reverse the restoration.

Create a system restore point

1. Select **Start > Control Panel > System and Security > System**.
2. In the left pane, click **System Protection**.
3. Click the **System Protection** tab.
4. Under **Protection Settings**, select the disk for which you want to create a restore point.
5. Click **Create**.
6. Follow the on-screen instructions.

Restore to a previous date and time

To revert to a restore point (created at a previous date and time), when the computer was functioning optimally, follow these steps:

1. Select **Start > Control Panel > System and Security > System**.
2. In the left pane, click **System protection**.
3. Click the **System Protection** tab.
4. Click **System Restore**.
5. Follow the on-screen instructions.

Performing a recovery

 **NOTE:** You can recover only files that you have previously backed up. HP recommends that you use HP Recovery Manager to create a set of recovery discs (entire drive backup) as soon as you set up your computer.

Recovery Manager software allows you to repair or restore the system if you experience system failure or instability. Recovery Manager works from recovery discs or from a dedicated recovery partition (select models only) on the hard drive. However, if your computer includes a solid-state drive (SSD), you may not have a recovery partition. If that is the case, recovery discs have been included with your computer. Use these discs to recover your operating system and software.

 **NOTE:** Windows has its own built-in repair features, such as System Restore. If you have not already tried these features, try them before using Recovery Manager.

NOTE: Recovery Manager recovers only software that was preinstalled at the factory. Software not provided with this computer must be downloaded from the manufacturer's Web site or reinstalled from the disc provided by the manufacturer.

Recovering from the recovery discs

To restore the system from the recovery discs:

1. Back up all personal files.
2. Insert the first recovery disc into the optical drive and restart the computer.
3. Follow the on-screen instructions.

Recovering from the dedicated recovery partition (select models only)

 **NOTE:** Computers with an SSD may not have a recovery partition. If the computer does not have a recovery partition, you will not be able to recover using this procedure. Recovery discs have been included for computers that do not have a partition. Use these discs to recover your operating system and software.

On some models, you can perform a recovery from the partition on the hard drive, accessed by pressing either the Start button or **f11**. This restores the computer to its factory condition.

To restore the system from the partition, follow these steps:

1. Access Recovery Manager in either of the following ways:
 - Select **Start > All Programs > Recovery Manager > Recovery Manager**.
 - or –
 - Turn on or restart the computer, and then press **esc** while the “Press the ESC key for Startup Menu” message is displayed at the bottom of the screen. Then, press **f11** while the “Press <F11> for recovery” message is displayed on the screen.
2. Click **System Recovery** in the **Recovery Manager** window.
3. Follow the on-screen instructions.

Index

Symbols/Numerics

1394 Power Saving 98

A

AC adapter

connecting 62

identifying 11

action keys

volume down 31, 32

volume mute 31, 32

volume up 31, 32

administrator password

creating 89

entering 89

managing 89

airport security devices 72

antennas 10

applications key, Windows 5

audio devices, connecting

external 35

audio features 35

audio functions, checking 35

audio-in (microphone) jack,

identifying 31

audio-out (headphone) jack,

identifying 31

AutoPlay 44

B

backing up

customized window, toolbar,
and menu bar settings 105

personal files 105

templates 105

battery

calibrating 67

charging 65, 67

conserving power 69

discharging 66

disposing 70

inserting 64

low battery levels 66

recharging 69

removing 64

storing 69

battery bay, identifying 9

battery power 63

battery release latch 64

battery release latch,

identifying 9

battery temperature 69

battery, identifying 11

bays

battery 9

hard drive 9

BIOS, updating 100

Blu-ray Disc

playing 42

removing 47

Bluetooth device 13, 19

Bluetooth label 12

boot options 98

boot order 98

button sound 98

buttons

power 4

TouchPad right/left 2, 24

C

cables

LAN 22

USB 79

calibrating battery 67

caps lock light, identifying 3

Card Reader Power Saving 98

CD

copying 45

playing 42

removing 47

CD drive 40, 73

changing the language of Setup
Utility 95

charging batteries 65, 67

checking audio functions 35

compartments

memory module 9

components

additional hardware 11

bottom 9

left-side 8

right-side 7

top 2

connecting to a WLAN 18

connection, external power 62

connector, power 7

conservation, power 69

copyright warning 45

cord, power 11

corporate WLAN connection 18

critical battery level 66

CyberLink PowerDVD 8

software 34

D

device drivers

HP drivers 58

Windows drivers 58

Diagnostics menu 98

digital card

defined 81

inserting 81

removing 82

stopping 82

Digital Media Slot light,

identifying 8

Digital Media Slot, identifying 8

Disk Cleanup software 74

Disk Defragmenter software 74

disk performance 74

diskette drive 73

- displaying system information 96
- drive media 59
- drives
 - boot order 98
 - caring for 72
- DVD
 - changing region setting 44
 - copying 45
 - playing 42
 - removing 47
- DVD drive 40, 73
- DVD region settings 44

- E**
- earbuds 31
- encryption 17
- entering a power-on password 90
- entering an administrator password 89
- esc key, identifying 5
- exiting Setup Utility 97
- external audio devices, connecting 35
- external drive 73
- external monitor port, identifying 8, 36

- F**
- f11 108
- fan always on 98
- firewall 17
- fn key, identifying 5, 28
- full system recovery 103
- function keys, identifying 5, 28

- H**
- hard drive
 - installing 77
 - removing 75
 - replacing 75
- hard drive bay, identifying 9
- hard drive self test 98
- HDMI 8, 37
- headphone (audio-out) jack 31
- Hibernation
 - exiting 60
 - initiated during critical battery level 66
 - initiating 60
- high-definition devices, connecting 37
- hotkey
 - description 28
- hotkeys
 - using 28
- hubs 79

- I**
- icons
 - network 14, 21
 - wired network 14
 - wireless 14
- interference, minimizing 22
- Internet connection setup 16
- issues, resolving 53

- J**
- jacks
 - audio-in (microphone) 31
 - audio-out (headphone) 31
 - RJ-11 (modem) 7
 - RJ-45 (network) 8

- K**
- keyboard hotkey, identifying 28
- keys
 - esc 5
 - fn 5
 - function 5
 - navigation 5
 - Windows applications 5
 - Windows logo 5

- L**
- labels
 - Bluetooth 12
 - modem approval 12
 - service tag 12
 - wireless certification 12
 - WLAN 12
- LAN Power Saving 98
- language support 98
- latch, battery release 9
- light
 - power 3
- lights
 - caps lock 3
 - Digital Media Slot 8
 - optical drive 7
- webcam 6
- wireless 3
- local area network (LAN)
 - cable required 22
 - connecting cable 22
- low battery level 66

- M**
- Main menu 97
- maintenance
 - Disk Cleanup 74
 - Disk Defragmenter 74
- managing a power-on password 90
- managing an administrator password 89
- media controls, hotkeys 33
- memory module
 - inserting 84
 - removing 84
- memory module compartment
 - cover
 - removing 84
 - replacing 85
- memory module compartment, identifying 9
- memory test 98
- microphone (internal), identifying 6, 31
- minimizing interference 22
- modem approval label 12
- modem cable
 - noise suppression circuitry 11
- monitor port, external 8
- monitor, connecting 36
- mouse, external
 - connecting 27
 - setting preferences 26
- multimedia components, identifying 30
- multimedia software 34

- N**
- navigating in Setup Utility 95
- navigation keys, identifying 5
- network cable
 - connecting 22
 - noise suppression circuitry 22
- network icons 14, 21
- network key 21

- network security codes
 - network key 21
 - SSID 21
- noise suppression circuitry
 - modem cable 11
 - network cable 22
- O**
- operating system 70
- optical disc
 - Blu-ray Disc 42
 - CD-R 41
 - CD-RW 41
 - DVD±R 41
 - DVD±RW 41
 - LightScribe DVD+R 42
 - removing 47
 - using 40
- optical drive
 - identifying 7
 - removing 48
 - using 39
- optical drive light, identifying 7
- P**
- passwords
 - administrator 89
 - power-on 89
 - set in Setup Utility 88
 - set in Windows 88
- performing a recovery 108
- ports
 - external monitor 8, 36
 - HDMI 8, 37
 - USB 7, 8, 79
- power
 - connecting 62
 - conserving 69
- power button, identifying 4
- power connector, identifying 7
- power cord, identifying 11
- power light, identifying 3
- power-on password
 - creating 90
 - entering 90
 - managing 90
- Processor C6 State 98
- product name and number, computer 12
- programs, updating 102
- projector, connecting 36
- public WLAN connection 18
- R**
- readable media 59
- recovering a program or driver 103
- recovering from the dedicated recovery partition 108
- recovering from the recovery discs 108
- recovery discs 103, 104
- Recovery Manager 103, 108
- recovery partition 103
- recovery, system 108
- region codes, DVD 44
- regulatory information
 - modem approval label 12
 - wireless certification labels 12
- release latch
 - battery 65
- restore points 107
- restoring default settings 96
- RJ-11 (modem) jack, identifying 7
- RJ-45 (network) jack, identifying 8
- S**
- secondary hard drive self test 98
- security cable slot, identifying 7
- Security menu 97
- security, wireless 17
- selecting in Setup Utility 95
- serial number, computer 12
- service tag 12
- setup of WLAN 16
- Setup Utility, passwords set in 88
- shut down 70
- Sleep
 - exiting 59
 - initiating 59
- slots
 - Digital Media 8
 - memory module 9
 - security cable 7
- software
 - Disk Cleanup 74
 - Disk Defragmenter 74
 - multimedia 34
 - Windows Media Player 34
 - Wireless Assistant 15
- solid-state drive (SSD) 103, 108
- speakers, identifying 4, 31
- starting Setup Utility 94
- storing battery 69
- supported discs 104
- System Configuration menu 98
- system failure or instability 103
- system information 97
- system recovery 108
- system restore points 103, 107
- T**
- temperature 69
- tips, webcam 51
- TouchPad
 - buttons 2
 - identifying 2, 24
 - setting preferences 26
- TouchPad light, identifying 24
- TouchPad right/left buttons, identifying 24
- TouchPad zone
 - identifying 2
- traveling with the computer
 - modem approval label 12
 - wireless certification labels 12
- troubleshooting
 - disc burning 56
 - disc play 55
 - DVD movie play 56
 - external display 56
 - HP device drivers 58
 - optical disc tray 53
 - optical drive detection 54
 - Windows device drivers 58
- turning off the computer 70
- U**
- unresponsive system 70
- USB cable, connecting 79
- USB devices
 - connecting 79
 - description 79
 - removing 80
- USB hubs 79
- USB ports, identifying 7, 8, 79
- using Setup Utility 95

using system restore 107

V

vents, identifying 8, 9

video, using 36

Virtualization Technology 98

volume down action key 31, 32

volume mute action key 31, 32

volume up action key 31, 32

volume, adjusting 32

W

webcam

 identifying 6, 31

 using 51

webcam light, identifying 6, 31

webcam properties, adjusting 52

webcam tips 51

Windows applications key,

 identifying 5

Windows logo key, identifying 5

Windows, passwords set in 88

wireless antennas 10

Wireless Assistant software 14,
15

wireless button

 using 14

wireless certification label 12

wireless controls

 button 14

 operating system 14

 Wireless Assistant

 software 14

wireless devices, types 13

wireless icon 14

wireless light 3, 14

wireless network (WLAN)

 connecting 18

 corporate WLAN

 connection 18

 described 13

 equipment needed 16

 functional range 18

 public WLAN connection 18

 security 17

WLAN label 12

WLAN module 9

writable media 59

