



COLOR LASERJET ENTERPRISE CM4540

MFP SERIES

User Guide





HP Color LaserJet Enterprise CM4540 MFP Series

User Guide

Copyright and License

© 2010 Copyright Hewlett-Packard Development Company, L.P.

Reproduction, adaptation, or translation without prior written permission is prohibited, except as allowed under the copyright laws.

The information contained herein is subject to change without notice.

The only warranties for HP products and services are set forth in the express warranty statements accompanying such products and services. Nothing herein should be construed as constituting an additional warranty. HP shall not be liable for technical or editorial errors or omissions contained herein.

Part number: CC419-90901

Edition 2, 10/2010

Trademark Credits

Adobe®, Acrobat®, and PostScript® are trademarks of Adobe Systems Incorporated.

Corel® is a trademark or registered trademark of Corel Corporation or Corel Corporation Limited.

Intel® Core™ is a trademark of Intel Corporation in the U.S. and other countries.

Microsoft®, Windows®, Windows® XP, and Windows Vista® are U.S. registered trademarks of Microsoft Corporation.

PANTONE® is Pantone, Inc's check-standard trademark for color.

UNIX® is a registered trademark of The Open Group.

ENERGY STAR and the ENERGY STAR mark are registered U.S. marks.

Conventions used in this guide

 **TIP:** Tips provide helpful hints or shortcuts.

 **NOTE:** Notes provide important information to explain a concept or to complete a task.

 **CAUTION:** Cautions indicate procedures that you should follow to avoid losing data or damaging the product.

 **WARNING!** Warnings alert you to specific procedures that you should follow to avoid personal injury, catastrophic loss of data, or extensive damage to the product.

Table of contents

1 Product basics	1
Product comparison	2
Environmental features	3
Accessibility features	4
Product views	5
Front view	5
CM4540 MFP	5
CM4540f MFP	6
CM4540fskm MFP	7
Back view	8
Interface ports	9
Serial number and model number location	9
Control-panel layout	10
Control-panel help	11
Touchscreen navigation	12
Buttons on the touchscreen	14
2 Control panel menus	15
Control panel menus	16
Administration menu	18
Reports menu	18
General Settings menu	19
Copy Settings menu	23
Scan/Digital Send Settings menu	27
Fax Settings menu	29
Print Settings menu	33
Print Options menu	34
Display Settings menu	35
Manage Supplies menu	37
Manage Trays menu	38
Stapler/Stacker Settings menu	39

Network Settings menu	39
Troubleshooting menu	42
Device Maintenance menu	45
Backup/Restore menu	45
Calibration/Cleaning menu	45
USB Firmware Upgrade menu	46
Service menu	46

3 Software for Windows 47

Supported operating systems for Windows	48
Supported printer drivers for Windows	49
Select the correct printer driver for Windows	50
HP Universal Print Driver (UPD)	51
UPD installation modes	51
Priority for print settings	52
Change printer-driver settings for Windows	53
Change the settings for all print jobs until the software program is closed	53
Change the default settings for all print jobs	53
Change the product configuration settings	53
Remove software for Windows	54
Supported utilities for Windows	55
HP Web Jetadmin	55
HP Embedded Web Server	55
Software for other operating systems	56

4 Use the product with Mac 57

Software for Mac	58
Supported operating systems for Mac	58
Supported printer drivers for Mac	58
Install software for Mac operating systems	58
Install software for Mac computers connected directly to the product	58
Install software for Mac computers on a wired network	59
Configure the IP address	59
Install the software	60
Remove software from Mac operating systems	61
Priority for print settings for Mac	63
Change printer-driver settings for Mac	63
Software for Mac computers	64
HP Utility for Mac	64
Open the HP Printer Utility	64
HP Utility features	64

Supported utilities for Mac	65
HP Embedded Web Server	65
Print with Mac	66
Cancel a print job with Mac	66
Change the paper size and type with Mac	66
Create and use printing presets with Mac	66
Resize documents or print on a custom paper size with Mac	67
Print a cover page with Mac	67
Use watermarks with Mac	67
Print multiple pages on one sheet of paper with Mac	68
Print on both sides (duplex) with Mac	68
Store jobs with Mac	69
Set the color options with Mac	69
Solve problems with a Mac	70
5 Connect the product	71
Printer sharing disclaimer	72
Connect with USB	73
CD installation	73
Connect to a network	73
Supported network protocols	74
Install the product on a wired network	75
Configure the IP address	75
Install the software	77
Configure network settings	78
View or change network settings	78
Set or change the network password	78
Manually configure IPv4 TCP/IP parameters from the control panel	79
Manually configure IPv6 TCP/IP parameters from the control panel	80
6 Paper and print media	81
Understand paper use	82
Special paper guidelines	82
Change the printer driver to match the paper type and size in Windows	84
Supported paper sizes	85
Supported paper types	88
Load paper trays	90
Load Tray 1	90
Load Tray 2 and optional Trays 3, 4, and 5 with standard-size paper	92
Load Tray 2 and optional Trays 3, 4, and 5 with custom-size paper	93
Tray and bin capacity	96

Paper orientation for loading trays	98
Paper orientation for loading Tray 1	98
Paper orientation for loading Tray 2 or Trays 3, 4, and 5	100
Configure trays	101
Configure a tray when loading paper	101
Configure a tray to match print job settings	101
Configure a tray by using the control panel	101
Automatic paper sensing (auto-sense mode)	102
Auto-sense settings	102
Select an output bin (fskm models only)	103

7 Manage supplies 105

Print cartridge information	106
Supplies views	107
Print cartridge views	107
Manage print cartridges	108
Settings for print cartridges	108
Print when a print cartridge is at estimated end of life	108
Enable or disable the Very Low Settings options from the control panel	108
Recycle supplies	109
Print-cartridge storage	109
HP policy on non-HP print cartridges	109
HP fraud hotline and Web site	109
Replacement instructions	110
Replace print cartridges	110
Replace the toner collection unit	112
Replace the staple cartridge	115
Solve problems with supplies	116
Check the print cartridges	116
Inspect the print cartridge for damage	117
Repeating defects	118
Print the Supplies Status page	119
Interpret control panel messages for supplies	120

8 Print tasks 127

Cancel a print job with Windows	128
Basic print tasks with Windows	129
Open the printer driver with Windows	129
Get help for any printing option with Windows	130
Change the number of print copies with Windows	130
Save custom print settings for reuse with Windows	131

Use a printing shortcut with Windows	131
Create printing shortcuts	132
Improve print quality with Windows	135
Select the page size with Windows	135
Select a custom page size with Windows	135
Select the paper type with Windows	135
Select the paper tray with Windows	135
Select the gloss level with Windows	135
Print on both sides (duplex) with Windows	136
Print multiple pages per sheet with Windows	137
Select page orientation with Windows	139
Set color options with Windows	141
Additional print tasks with Windows	143
Print colored text as black (grayscale) with Windows	143
Print on preprinted letterhead or forms with Windows	143
Print on special paper, labels, or transparencies	145
Print the first or last page on different paper with Windows	148
Scale a document to fit page size with Windows	150
Add a watermark to a document with Windows	152
Create a booklet with Windows	152
Select output options with Windows (fskm models only)	154
Select an output bin with Windows	154
Select staple options with Windows	155
Use job storage features with Windows	157
Create a stored job with Windows	157
Print a stored job	158
Delete a stored job	159
Set job storage options with Windows	159
Print one copy for proof before printing all the copies	159
Temporarily store a personal job on the product and print it later ..	160
Temporarily store a job on the product	160
Permanently store a job on the product	160
Make a permanently stored job private so that anyone who tries to print it must provide a PIN	161
Receive notification when someone prints a stored job	161
Set the user name for a stored job	161
Specify a name for the stored job	161
Print special jobs with Windows	162
Print business graphics or marketing material	162
Supported glossy paper	162
Print weatherproof maps and outdoor signs	163

Supported tough paper	163
Set the duplex alignment	163
Walk-up USB printing	164

9 Color 167

Adjust color	168
Change the color theme for a print job	168
Change the color options	169
Manual color options	170
Use the HP EasyColor option	171
Match colors	172
Sample book color matching	172
Print color samples	173
PANTONE® color matching	173

10 Copy 175

Use copy functions	176
Copy	176
Cancel a copy job	176
Reduce or enlarge a copy image	177
Collate a copy job	178
Make color copies or black and white copies	178
Copy settings	179
Change copy quality	179
Optimize the copy image for text or pictures	179
Check the scanner glass for dirt or smudges	179
Adjust the copy lightness/darkness	181
Define custom copy settings	183
Set the paper size and type for copying on special paper	183
Restore copy default settings	184
Copy a book	185
Copy a photo	186
Create a stored copy job	187
Copy mixed-size originals	188
Copy on both sides (duplex)	189
Use Job Build mode	190

11 Scan and send documents 191

Set up scan/send features	192
Use scan/send functions	194

Sign in	194
Change default scan/send settings from the product control panel	194
Send a scanned document	195
Send a scanned document to a network folder	195
Send a scanned document to a folder in the product memory	196
Send a scanned document to a USB flash drive	197
Send to e-mail	198
Supported protocols	199
Configure e-mail server settings	199
Send a scanned document to one or more e-mail addresses	200
Use the address book	202
Add contacts to the address book from the product control panel ..	202
Send a document to e-mail by using the address book	203

12 Fax 205

Setup	206
Introduction	206
HP LaserJet Analog Fax Accessory 500 features	206
Verify fax operation	207
Required fax settings	207
Fax Setup Wizard	208
Set or verify the date and time	209
Set or verify the date/time format	209
Set fax settings	210
Remote fax configuration	210
Web browser	210
HP Web Jetadmin	210
HP MFP Digital Sending Software Configuration Utility	211
Send fax settings	211
Fax send setup	211
Fax Setup Wizard	211
Fax dialing settings	213
General fax send settings	217
Set billing codes	219
Default job options	220
Image preview	221
Set the outgoing fax resolution	221
Original sides	222
Notification	222
Content orientation	223
Original size	223

Image adjustment	224
Optimize text/picture	224
Job build	225
Blank page suppression	225
Receive fax settings	226
Fax receive setup	226
Set the ringer volume	226
Set rings-to-answer	226
Set fax receive speed	227
Set ring interval	227
Set ring frequency	227
Enable or disable the fax printing schedule	228
Block incoming faxes	228
Create a blocked-fax list	229
Delete numbers from the blocked-fax list	229
Initiate polling receive	229
Default job options	230
Notification	230
Stamp received faxes (incoming faxes)	231
Set fit-to-page	231
Set the paper selection	232
Set the output bin	232
Set the sides	233
Set the paper tray	233
Fax archive and forwarding	233
Enable fax archiving	234
Enable fax forwarding	234
Use Fax	235
Fax feature screen	235
Status message bar	236
Send a fax	236
Send a fax by entering numbers manually	237
Send a fax using speed dial	238
Search a speed-dial list by name	238
Send a fax by using fax address book numbers	239
Fax address book search	240
Cancel a fax	240
Cancel the current fax transmission	240
Cancel pending faxes	240
Receive faxes	241
Create or delete speed dial lists	241

Create a speed dial list	241
Delete a speed dial list	243
Delete a single number from the speed dial list	244
Add a number to an existing speed dial list	245
Voice Calls and Retries	246
Fax Call Report	246
Fax Activity Log	247
T.30 Report	247
Scheduling fax printing (memory lock)	247
Use Fax over VoIP networks	248
Solve fax problems	249
Is your fax set up correctly?	249
What type of phone line are you using?	249
Are you using a surge-protection device?	249
Are you using a phone company voice-messaging service or an answering machine?	250
Does your phone line have a call-waiting feature?	250
Check fax accessory status	250
Fax feature is not operating	251
General fax problems	251
Problems with receiving faxes	252
Problems with sending faxes	253
Error codes	254
Fax error messages	254
Send-fax messages	256
Receive-fax messages	258
Fax reports	259
Fax activity log	259
Billing code report	260
Blocked fax list report	260
Speed dial list report	260
Fax call report	260
Clear the fax activity log	260
Service settings	261
Settings in the Troubleshooting menu	261
Settings in the Resets menu	261
Firmware upgrades	262

13 Manage and maintain 263

Print information pages	264
Use the HP Embedded Web Server	266

Open the HP Embedded Web Server by using a network connection	266
HP Embedded Web Server features	267
Information tab	267
General tab	267
Copy/Print tab	268
Scan/Digital Send tab	268
Fax tab	269
Troubleshooting tab	270
Security tab	270
Networking tab	271
Other Links list	271
Use HP Web Jetadmin software	272
Product security features	273
Security statements	273
IP Security	273
Secure the HP Embedded Web Server	273
Encryption support: HP Encrypted High Performance Hard Disks	273
Secure stored jobs	274
Lock the control panel menus	274
Lock the formatter	274
Economy settings	275
Optimize speed or energy use	275
Powersave modes	275
Set sleep mode	275
Set sleep delay	276
Set the sleep schedule	276
Install external I/O cards	277
Clean the product	279
Clean the paper path	279
Clean the scanner glass	279
Product updates	282
14 Solve problems	283
Self help	284
Solve problems checklist	285
Factors that affect product performance	286
Restore factory settings	287
Interpret control-panel messages	288
Control-panel message types	288
Control-panel messages	288
Paper feeds incorrectly or becomes jammed	289

The product does not pick up paper	289
The product picks up multiple sheets of paper	289
Prevent paper jams	289
Clear jams	290
Jam locations	290
Clear jams in the document feeder	292
Clear paper jams in the stapler	293
Clear staple jams	294
Clear jams in the output bin area	297
Clear jams from under the top cover	297
Clear jams in the right door	299
Clear jams in Tray 1	302
Clear jams in Trays 2, 3, 4, or 5	304
Clear jams in the lower-right door (Trays 3, 4, or 5)	305
Change jam recovery	306
Improve print quality	307
Select a paper type	307
Use paper that meets HP specifications	307
Print a cleaning page	308
Calibrate the product	308
Set the image registration	308
Internal print-quality-test pages	309
Check the print cartridge	309
Use the printer driver that best meets your printing needs	310
Improve print quality for copies	311
The product does not print or it prints slowly	312
The product does not print	312
The product prints slowly	313
Solve walk-up USB printing problems	314
The Open from USB menu does not open when you insert the USB accessory	314
The file does not print from the USB storage accessory	314
The file that you want to print is not listed in the Open from USB menu	315
Solve connectivity problems	316
Solve direct-connect problems	316
Solve network problems	316
Poor physical connection	316
The computer is using the incorrect IP address for the product	316
The computer is unable to communicate with the product	317
The product is using incorrect link and duplex settings for the network	317
New software programs might be causing compatibility problems	317
The computer or workstation might be set up incorrectly	317

The product is disabled, or other network settings are incorrect	317
Solve product software problems with Windows	318
Solve product software problems with Mac	319
The printer driver is not listed in the Print & Fax list	319
The product name does not appear in the product list in the Print & Fax list	319
The printer driver does not automatically set up the selected product in the Print & Fax list	319
A print job was not sent to the product that you wanted	320
When connected with a USB cable, the product does not appear in the Print & Fax list after the driver is selected.	320
You are using a generic printer driver when using a USB connection	320

Appendix A Product supplies and accessories 321

Order parts, accessories, and supplies	322
Part numbers	323
Accessories	323
Cables and interfaces	323
Customer self-repair parts	323

Appendix B Service and support 327

Hewlett-Packard limited warranty statement	328
HP's Premium Protection Warranty: LaserJet print cartridge limited warranty statement	329
Color LaserJet Fuser Kit, Transfer Kit, and Roller Kit Limited Warranty Statement	330
Data stored on the print cartridge	331
End User License Agreement	332
OpenSSL	334
Customer self-repair warranty service	335
Customer support	336

Appendix C Product specifications 337

Physical specifications	338
Power consumption, electrical specifications, and acoustic emissions	338
Environmental specifications	338

Appendix D Regulatory information 339

FCC regulations	340
Environmental product stewardship program	341
Protecting the environment	341
Ozone production	341
Power consumption	341

Paper use	341
Plastics	341
HP LaserJet print supplies	341
Return and recycling instructions	342
United States and Puerto Rico	342
Multiple returns (more than one cartridge)	342
Single returns	342
Shipping	342
Non-U.S. returns	343
Paper	343
Material restrictions	343
Disposal of waste equipment by users in private households in the European Union	344
Chemical substances	344
Material Safety Data Sheet (MSDS)	344
For more information	344
Declaration of Conformity	345
Declaration of Conformity (fax models)	347
Safety statements	349
Laser safety	349
Canadian DOC regulations	349
VCCI statement (Japan)	349
Power cord instructions	349
Power cord statement (Japan)	349
EMC statement (China)	350
EMC statement (Korea)	350
EMI statement (Taiwan)	350
Laser statement for Finland	350
Substances Table (China)	351
Restriction on Hazardous Substances statement (Turkey)	351
Additional statements for telecom (fax) products	352
EU Statement for Telecom Operation	352
New Zealand Telecom Statements	352
Additional FCC statement for telecom products (US)	352
Telephone Consumer Protection Act (US)	353
Industry Canada CS-03 requirements	353
Japan Telecom Mark	354
Index	355

1 Product basics

- [Product comparison](#)
- [Environmental features](#)
- [Accessibility features](#)
- [Product views](#)

Product comparison



CM4540 MFP

CC419A

- Prints up to 42 pages per minute (ppm) on Letter-size paper and up to 40 ppm on A4-size paper
- Scans in grayscale up to 36.5 images per minute (ipm) for Letter-size pages and up to 35 ipm for A4-size pages
- Scans in color up to 21 images per minute (ipm) for Letter-size pages and up to 20 ipm for A4-size pages
- Digital sending features, including sending to e-mail, network folders, and a USB flash drive.
- 100-sheet multipurpose input tray (Tray 1)
- 500-sheet input tray (Tray 2)
- 50-sheet document feeder for copying and scanning
- Flatbed scanner that holds pages up to Legal size
- Automatic two-sided printing
- 500-sheet, face-down output bin
- Hi-speed USB 2.0 port
- HP Jetdirect embedded print server for connecting to a 10/100/1000Base-TX network
- USB port on the control panel for walk-up printing and scanning
- Color touchscreen display
- Hinged control panel to adjust the viewing angle
- 1280 megabytes (MB) of random access memory (RAM)
- HP Encrypted High Performance Hard Disk
- Hardware integration pocket on the control panel for adding solutions
- Color access control



CM4540f MFP

CC420A

This model has the same features as the CM4540 MFP model, with the following differences:

- HP 500-sheet Paper Feeder (Tray 3) and cabinet (increases the total input capacity to 1100 pages)
- Analog faxing with the built-in HP Analog Fax Accessory 500

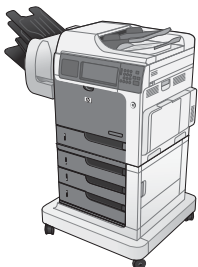

CM4540fsm MFP

CC421A

This model has the same features as the CM4540 MFP model, with the following differences:

- HP 3 x 500-sheet Paper Feeder (Trays 3, 4, and 5) and stand (increases the total input capacity to 2100 pages)
- HP 900-sheet 3-bin Stapling Mailbox (replaces the 500-sheet output bin)
- Analog faxing with the built-in HP Analog Fax Accessory 500

Environmental features

Duplex	Save paper by using duplex printing as your default print setting.
Print multiple pages per sheet	Save paper by printing two or more pages of a document side-by-side on one sheet of paper. Access this feature through the printer driver.
Recycling	Reduce waste by using recycled paper. Recycle print cartridges by using the HP return process.
Energy savings	Save energy by initiating sleep mode for the product.
HP Smart Web printing	Use HP Smart Web printing to select, store, and organize text and graphics from multiple Web pages and then edit and print exactly what you see onscreen. It gives you the control you need for printing meaningful information while minimizing waste. Download HP Smart Web printing from this Web site: www.hp.com/go/smartweb .
Job storage	Use the job storage features to manage print jobs. By using job storage, you activate printing while you are at the shared product, eliminating lost print jobs that are then reprinted.

Accessibility features

The product includes several features that aid you with accessibility issues.

- Online user guide that is compatible with text screen-readers.
- Print cartridges can be installed and removed by using one hand.
- All doors and covers can be opened by using one hand.
- Paper can be loaded in Tray 1 by using one hand.
- The control-panel display rotates up to adjust the viewing angle.

Product views

Front view

CM4540 MFP

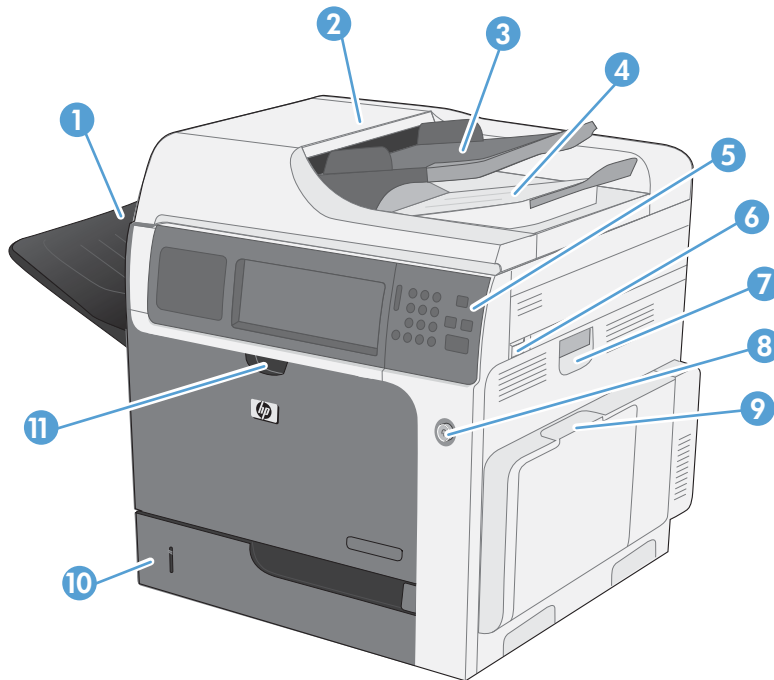

1	Standard output bin
2	Document feeder cover (access for clearing jams)
3	Document feeder input tray
4	Document feeder output bin
5	Control panel with color touchscreen display
6	Top-cover-release lever (access for clearing jams)
7	Handle for the right door (access for clearing jams)
8	On-off button
9	Handle for Tray 1
10	Tray 2
11	Handle for the front cover (access to the print cartridges and the toner collection unit)

CM4540f MFP

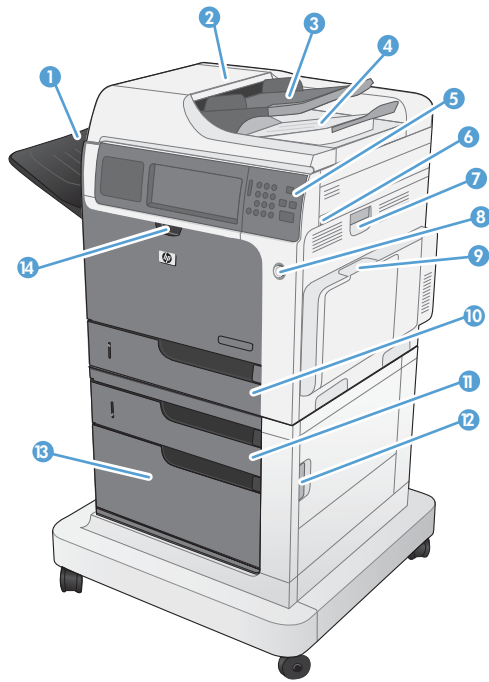

1	Standard output bin
2	Document feeder cover (access for clearing jams)
3	Document feeder input tray
4	Document feeder output bin
5	Control panel with color touchscreen display
6	Top-cover-release lever (access for clearing jams)
7	Handle for the right door (access for clearing jams)
8	On-off button
9	Handle for Tray 1
10	Tray 2
11	Tray 3
12	Handle for lower-right door (access for clearing jams)
13	Storage cabinet
14	Handle for the front cover (access to the print cartridges and the toner collection unit)

CM4540fskm MFP

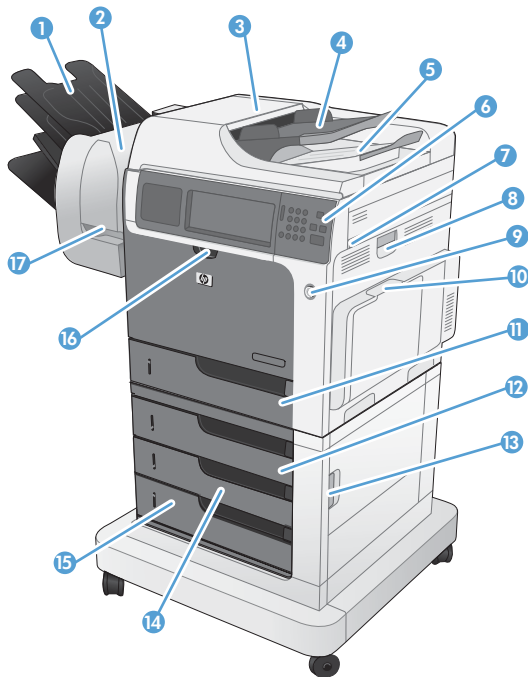

1	Mailbox output bins
2	HP Stapling Mailbox accessory
3	Document feeder cover (access for clearing jams)
4	Document feeder input tray
5	Document feeder output bin
6	Control panel with color touchscreen display
7	Top-cover-release lever (access for clearing jams)
8	Handle for the right door (access for clearing jams)
9	On-off button
10	Handle for Tray 1
11	Tray 2
12	Tray 3
13	Handle for lower-right door (access for clearing jams)
14	Tray 4
15	Tray 5
16	Handle for the front cover (access to the print cartridges and the toner collection unit)
17	Stapler release lever (access to the staple cartridge)

Back view

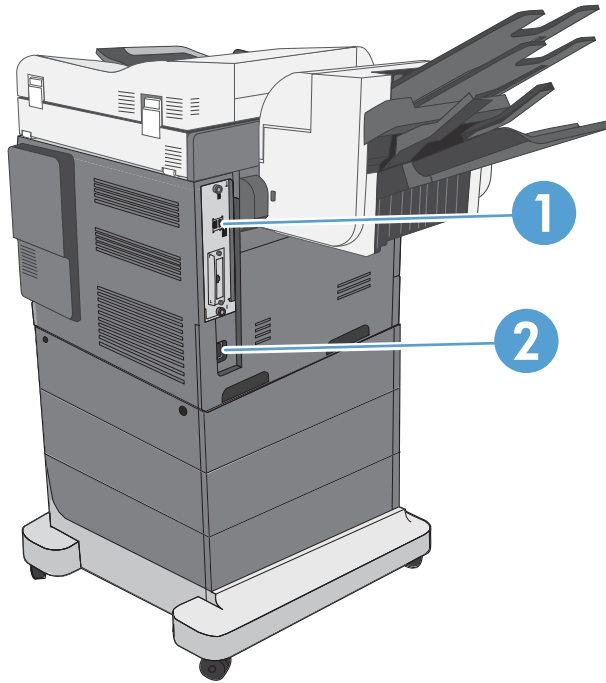

1	Interface ports
2	Power connection

Interface ports

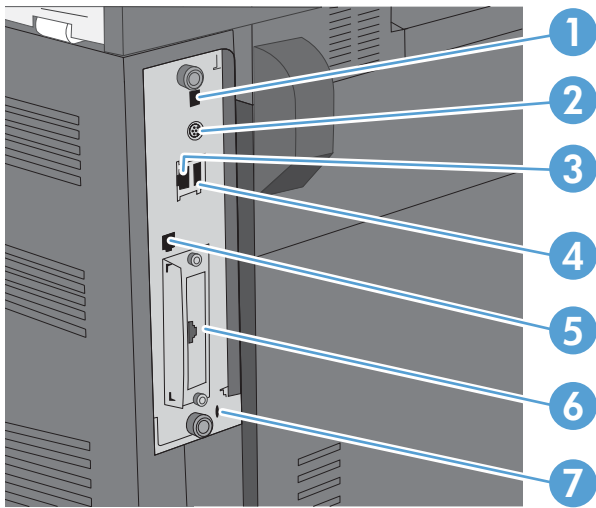

1	Hi-speed USB 2.0 printing port
2	Foreign interface harness for connecting third-party devices
3	Local area network (LAN) Ethernet (RJ-45) network port
4	USB port for connecting external USB devices
5	Fax port (RJ-11)
6	EIO interface expansion slot
7	Slot for a cable-type security lock

Serial number and model number location

The model number and serial number are listed on an identification label located on the back of the product. The serial number contains information about the country/region of origin, the product version, production code, and the production number of the product.

Model name	Model number
CM4540 MFP	CC419A
CM4540f MFP	CC420A
CM4540fskm MFP	CC421A

Control-panel layout

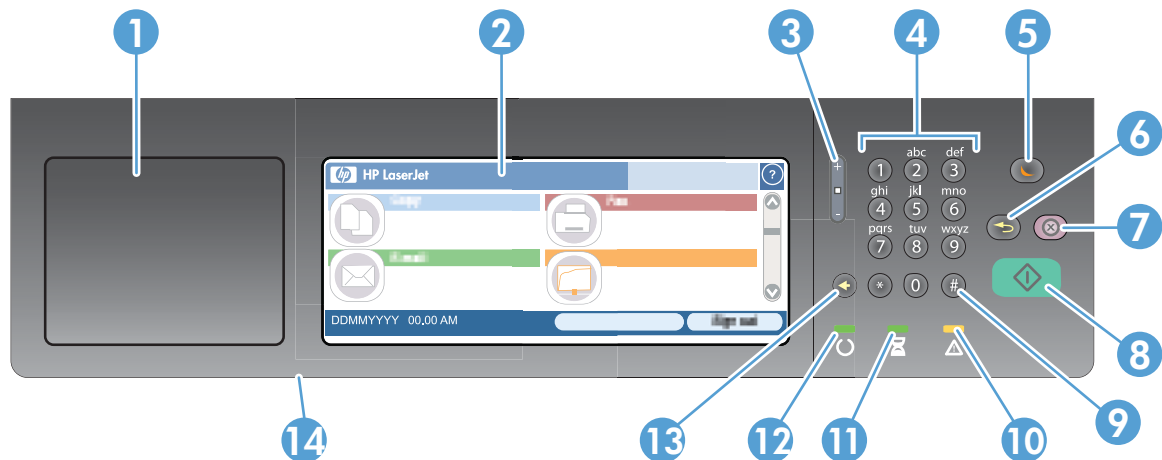



1	Hardware integration pocket	Area for adding third-party security devices
2	Touchscreen graphical display	Use the touchscreen to open and set up all product functions.
3	Brightness-adjustment button	Use this button to increase or decrease the brightness of the touchscreen display.
4	Numeric keypad	Use this area to specify the number of copies and other numeric values.
5	Sleep button	If the product is inactive for a long period of time, it automatically enters a sleep mode. To place the product into sleep mode or to reactivate the product, press the Sleep button.
6	Reset button	Resets the job settings to factory or user-defined default values.
7	Stop button	Stops the active job and opens the Job Status screen.
8	Start button	Begins a copy job, starts digital sending, starts a fax job, or continues a job that has been interrupted.
9	Pause button	Use this button to indicate a required pause for a fax number.
10	Attention light	Indicates that the product has a condition that requires intervention. Examples include an empty paper tray or an error message.
11	Data light	Indicates that the product is receiving data.
12	Ready light	Indicates that the product is ready to begin processing any job.
13	Backspace button	Clears the active text or number field, and returns values to the default settings.
14	USB port (on the bottom edge of the hinged control panel)	Connect a USB flash drive for walk-up printing and scanning.

Control-panel help

The product has a built-in Help system that explains how to use each screen. To open the Help system, touch the Help button  in the upper-right corner of the screen.

For some screens, the Help opens to a global menu where you can search for specific topics. You can browse through the menu structure by touching the buttons in the menu.

For screens that contain settings for individual jobs, the Help opens to a topic that explains the options for that screen.

If the product alerts you of an error or warning, touch the error  or warning  button to open a message that describes the problem. The message also contains instructions to help solve the problem.

Touchscreen navigation

The home screen provides access to the product features, and it indicates the current status of the product.

NOTE: HP regularly updates features that are available in the product firmware. To take advantage of the most current features, update the product firmware. To download the most recent firmware upgrade, go to www.hp.com/go/cljcm4540mfp_firmware.

NOTE: Depending on how the product has been configured, the features that appear on the home screen can vary.

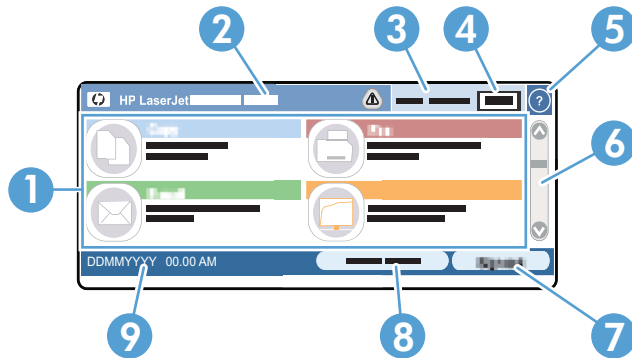

1	Features	Depending on how the product is configured, the features that appear in this area can include any of the following items: <ul style="list-style-type: none">• Copy• Fax• E-mail• Save to Network Folder• Save to USB• Save to Device Memory• Open from USB• Open from Device Memory• Quick Sets• Job Status• Supplies• Trays• Administration• Device Maintenance
2	Product status	The status line provides information about the overall product status.
3	Copy type	Shows whether copies are color.

4	Copy count	The copy count box indicates the number of copies that the product is set to make.
5	Help button	Touch the Help button to open the embedded help system.
6	Scroll bar	Touch the up or down arrows on the scroll bar to see the complete list of available features.
7	Sign In or Sign Out	Touch the Sign In button to access secured features. Touch the Sign Out button to sign out of the product if you have signed in for access to secured features. After you sign out, the product restores all options to the default settings.
8	Network Address	Touch the Network Address button to find information about the network connection. NOTE: Depending on the product configuration, this button might not appear.
9	Date and time	The current date and time appear here. You can select the format that the product uses to show the date and time, for example 12-hour format or 24-hour format.

Buttons on the touchscreen

The status line on the touchscreen provides information about the product status. Various buttons can appear in this area. The following table describes each button.



Home button. Touch the home button to go to the Home screen from any other screen.



Start button. Touch the **Start** button to begin the action for the feature that you are using.

NOTE: The name of this button changes for each feature. For example, in the **Copy** feature, the button is named **Start Copy**.



Stop button. If the product is processing a print or fax job, the **Stop** button appears instead of the **Start** button. Touch the **Stop** button to halt the current job. The product prompts you to cancel the job or to resume it.



Warning button. The warning button appears when the product has a problem but can continue functioning. Touch the warning button to see a message that describes the problem. The message also has instructions for solving the problem.





Help button. Touch the help button to open the built-in online Help system.

2 Control panel menus

- [Control panel menus](#)
- [Administration menu](#)
- [Device Maintenance menu](#)

Control panel menus

The product has many menus on the control panel Home screen to help you perform tasks and configure settings.

 **NOTE:** To learn about each menu option, touch the Help button  in the upper-right corner of the screen for that option.

NOTE: HP regularly updates features that are available in the product firmware. To take advantage of the most current features, update the product firmware. To download the most recent firmware upgrade, go to www.hp.com/go/cljcm4540mfp_firmware.

Table 2-1 Menus on the Home screen

Menu	Description
Initial Setup	<p>This menu appears when you first turn the product on. Use it to set the language, to set the date and time, to configure essential fax and e-mail settings, and to enable the Open from USB feature.</p> <p>After you have completed the initial setup, you have the option to hide this menu.</p>
Copy	<p>Use this menu to make copies of documents.</p> <p>Several options are available for customizing jobs. These settings are temporary. After you have finished the job, the product returns to the default settings.</p>
Fax	<p>Use this menu to send a fax from the product. This menu is available only for products that have a fax accessory. For this menu to appear on the control panel, this feature must be set up by using the Initial Setup menu or by using the HP Embedded Web Server.</p> <p>Several options are available for customizing jobs. These settings are temporary. After you have finished the job, the product returns to the default settings.</p>
E-mail	<p>Use this menu to scan documents and send them as an e-mail attachment. For this menu to appear on the control panel, this feature must be set up by using the Initial Setup menu, by using the HP Scan to Email Setup Wizard during software installation, or by using the HP Embedded Web Server.</p> <p>Several options are available for customizing jobs. These settings are temporary. After you have finished the job, the product returns to the default settings.</p>
Save to USB	<p>Use this menu to scan documents and save them on a USB flash drive. For this menu to appear on the control panel, this feature must be set up by using the HP Embedded Web Server.</p> <p>Several options are available for customizing jobs. These settings are temporary. After you have finished the job, the product returns to the default settings.</p>
Save to Network Folder	<p>Use this menu to scan documents and save them to a shared folder on the network. For this menu to appear on the control panel, this feature must be set up by using the HP Embedded Web Server or by using the HP Save to Folder Setup Wizard during software installation.</p> <p>Several options are available for customizing jobs. These settings are temporary. After you have finished the job, the product returns to the default settings.</p>
Open from USB	<p>Use this menu to open and print a document stored on a USB flash drive. For this menu to appear on the control panel, this feature must be set up by using the Initial Setup menu.</p>

Table 2-1 Menus on the Home screen (continued)

Menu	Description
Save to Device Memory	<p>Use this menu to scan documents and save them to the hard disk in the product.</p> <p>Several options are available for customizing jobs. These settings are temporary. After you have finished the job, the product returns to the default settings.</p>
Open from Device Memory	<p>Use this menu to open and print a document stored on the product hard drive.</p>
Quick Sets	<p>Use this menu to access preset job options for jobs that you scan and send by fax or e-mail, or jobs that you scan and save to a USB flash drive, the product hard disk, or to a folder on the network.</p> <p>Set up Quick Sets by using the HP Embedded Web Server or HP Web Jetadmin.</p>
Job Status	<p>Use this menu to see the status of all active jobs.</p>
Trays	<p>Use this menu to see the current status of each tray. You can also use this menu to configure the paper size and type settings for each tray.</p>
Supplies	<p>Use this menu to see the current status of product supplies, such as print cartridges. Information about ordering new supplies is also available.</p>
Administration	<p>Use this menu to print reports and configure default settings for the product. The Administration menu has several sub-menus. See the sections that follow for details about these menus.</p>
Device Maintenance	<p>Use this menu to calibrate and clean the product and to backup and restore data. See the sections that follow for details about these menus.</p>

Administration menu

You can perform basic product setup by using the [Administration](#) menu. Use the HP Embedded Web Server for more advanced product setup. To open the HP Embedded Web Server, enter the product IP address or host name in the address bar of a Web browser.

Reports menu

To display: At the product control panel, select the [Administration](#) menu, and then select the [Reports](#) menu.

Table 2-2 Reports menu

First level	Second level	Values
Configuration/Status Pages	Administration Menu Map	Print
		View
	Current Settings Page	Print
		View
	Configuration Page	Print
		View
	Supplies Status Page	Print
		View
	Usage Page	Print
		View
File Directory Page	Print	
	View	
Color Usage Job Log	Print	
	View	
Fax Reports	Fax Activity Log	Print
		View
	Billing Codes Report	Print
		View
	Blocked Fax List	Print
		View
Speed Dial List	Print	
	View	
Fax Call Report	Print	
	View	

Table 2-2 Reports menu (continued)

First level	Second level	Values
Other Pages	Demonstration Page	Print
	Color Samples for RGB	Print
	CMYK Values	Print
	PCL Font List	Print
	PS Font List	Print

General Settings menu

To display: At the product control panel, select the [Administration](#) menu, and then select the [General Settings](#) menu.

In the following table, asterisks (*) indicate the factory default setting.

Table 2-3 General Settings menu

First level	Second level	Third level	Fourth level	Values	
Date/Time Settings	Date/Time Format	Date Format		DD/MMM/YYYY	
				MMM/DD/YYYY	
				YYYY/MMM/DD	
		Time Format		12 hour (AM/PM)	
				24 hours	
		Date/Time	Date		Select the date from a pop-up calendar.
			Time		Select the time from a pop-up keypad.
	Time Zone			Select the time zone from a list.	
		Adjust for Daylight Savings		Checkbox	
Energy Settings	Sleep Schedule	A list of scheduled events displays.			
		+ (Add)	Edit		
		Edit	Delete		
			Event Type	Wake Up	
				Sleep	
		Event Time			

Table 2-3 General Settings menu (continued)

First level	Second level	Third level	Fourth level	Values
			Event Days	Select days of the week from a list.
	Sleep Delay			Enter a value between 1 and 120 minutes. The default value is 45 minutes.
	Optimum Speed/Energy Usage			Faster First Page* Save Energy Save More Energy Save Most Energy
Print Quality	Adjust Color	Highlights	Cyan Density Magenta Density Yellow Density Black Density	-5 to 5
		Midtones	Cyan Density Magenta Density Yellow Density Black Density	-5 to 5
		Shadows	Cyan Density Magenta Density Yellow Density Black Density	-5 to 5
	Image Registration	Adjust Tray <X>	Print Test Page	
			X1 Shift Y1 Shift X2 Shift Y2 Shift	-5.00 mm to 5.00 mm
	Auto Sense Behavior	Tray 1 Sensing		Full sensing Expanded sensing* Transparency Only
		Tray X Sensing		Expanded sensing Transparency Only

Table 2-3 General Settings menu (continued)

First level	Second level	Third level	Fourth level	Values
	Adjust Paper Types	Select from a list of paper types that the product supports. The available options are the same for each paper type.	Print Mode	Select from a list of print modes.
			Resistance Mode	Normal mode Up Down
			Humidity Mode	Normal High
			Pre-Rotation Mode	Off On
			Fuser Temp Mode	Normal Up Down
			Paper Curl Mode	Normal Reduced
	Optimize	Normal Paper		Standard* Smooth
		Heavy Paper		Standard* Smooth
		Envelope Control		Normal* Reduced Temperature multipurpose mode
		Environment		Normal* Low Temp
		Line Voltage		Normal* Low Voltage
		Tray 1		Normal* Alternate

Table 2-3 General Settings menu (continued)

First level	Second level	Third level	Fourth level	Values
		Background		Normal* Alternate 1 Alternate 2 Alternate 3
		Uniformity Control		Normal* Alternate 1 Alternate 2 Alternate 3
		Tracking Control		On* Off
		Registration		Normal* Alternate
		Transfer Control		Normal* Alternate 1 Alternate 2 Alternate 3
		Fuser Temp		Normal* Alternate
	Edge Control			Off Light Normal* Maximum
Jam Recovery				Auto* Off On
Manage Stored Jobs	Quick Copy Job Storage Limit			1-300 Default = 32

Table 2-3 General Settings menu (continued)

First level	Second level	Third level	Fourth level	Values
	Quick Copy Job Held Timeout			Off* 1 Hour 4 Hours 1 Day 1 Week
	Default Folder Name for Stored Jobs			
	Sort Stored Jobs By			Job Name* Date
Hold Off Print Job				Enabled* Disabled
Restore Factory Settings				Address Book Calibration Copy Digital Send E-mail Fax General Print Security
Restrict Color				Enable color Disable color Color if allowed

Copy Settings menu

To display: At the product control panel, select the [Administration](#) menu, and then select the [Copy Settings](#) menu.

In the following table, asterisks (*) indicate the factory default setting.

Table 2-4 Copy Settings menu

First level	Second level	Values
Image Preview		Make optional*
		Require preview
		Disable preview
Sides		1-sided original, 1-sided output*
		1-sided original, 2-sided output
		2-sided original, 1-sided output
		2-sided original, 2-sided output
	Orientation	Portrait*
		Landscape
Color/Black	Color Mode	Auto detect*
		Color
		Black
Staple/Collate	Staple	None
		Top left
		Top right
	Collate	Off
		On*
Collate		Collate on (Sets in page order)*
		Collate off (Pages grouped)
Reduce/Enlarge	Scaling	Automatic
		Range X-Y (25-400%)
		100%
		75%
		50%
		125%
		150%
200%		
	Auto Include Margins	

Table 2-4 Copy Settings menu (continued)

First level	Second level	Values
Paper Selection		Automatic Tray 1: [Size], [Type] Tray <X>: [Size], [Type]
Image Adjustment	Darkness	
	Contrast	
	Background Cleanup	
	Sharpness	
Content Orientation	Orientation	Portrait* Landscape
	2-Sided Format	Book-style Flip-style Book-style original; Flip-style copy Flip-style original; Book-style copy
Output Bin		Select from a list of output bins.
Optimize Text/Picture	Optimize For*	Manually adjust* Text Printed picture Photograph
Pages per Sheet		One (1) Two (2) Four (4)
	Page Order	Right, then down Down, then right
	Add Page Borders	
Original Size		Auto detect* Select from a list of sizes that the product supports.
	Borders on Each Page	
	Original Sides	1-sided* 2-sided

Table 2-4 Copy Settings menu (continued)

First level	Second level	Values
Edge-To-Edge		Normal (recommended)*
		Edge-To-Edge output
Job Build		Job Build off*
		Job Build on

Scan/Digital Send Settings menu

To display: At the product control panel, select the [Administration](#) menu, and then select the [Scan/Digital Send Settings](#) menu.

In the following table, asterisks (*) indicate the factory default setting.

Table 2-5 Scan/Digital Send Settings menu

First level	Second level	Third level	Fourth level	Values
E-mail Settings	E-mail Setup	E-mail Setup Wizard		
Default Save to Network Folder Options	NOTE: E-mail Settings only			
Default Save to USB Options				
NOTE: The same options are available for each of these features, except where noted.				
	Default Job Options	Image Preview		Make optional* Require preview Disable preview
		NOTE: You might need to upgrade the firmware to view this menu.		
		Default File Name		
		Document File Type		Select from a list of file types.
		Optimize Text/Picture	Optimize For:	Manually adjust* Text Printed picture Photograph
		Output Quality		High (large file) Medium* Low (small file)
		Original Sides		1-sided 2-sided
			Orientation	Portrait* Landscape Book-style Flip-style

Table 2-5 Scan/Digital Send Settings menu (continued)

First level	Second level	Third level	Fourth level	Values
		Resolution		600 dpi 400 dpi 300 dpi 200 dpi 150 dpi* 75 dpi
		Content Orientation	Orientation	Portrait* Landscape
			2-Sided Format	Book-style* Flip-style
		Color/Black		Auto detect Color Black/Gray Black
		Original Size		
		Notification		Do not notify* Notify when job completes Notify only if job fails Print E-mail*
		Image Adjustment	Darkness	
			Contrast	
			Background Cleanup	
			Sharpness	
		Job Build		Job Build off* Job Build on*
		Blank Page Suppression		Enabled Disabled*

Table 2-5 Scan/Digital Send Settings menu (continued)

First level	Second level	Third level	Fourth level	Values
Digital Send Service Setup	Allow Usage of Digital Sending Software (DSS) Server			
	Allow Transfer to New Digital Sending Software (DSS) Server			

Fax Settings menu

To display: At the product control panel, select the [Administration](#) menu, and then select the [Fax Settings](#) menu.

In the following table, asterisks (*) indicate the factory default setting.

Table 2-6 Fax Settings menu

First level	Second level	Third level	Fourth level	Values
Fax Send Settings	Fax Send Setup	Fax Setup Wizard		
		Fax Dialing Settings	Fax Dial Volume	Off Low* High
			Dialing Mode	Tone* Pulse
			Redial On Busy	Range: 0 – 9 Default = 3
			Redial On No Answer	Range: 0 - 2 Default = 0
			Redial Interval	1-5 Minutes Default = 5 minutes
			Detect Dial Tone	
			Fax Send Speed	Fast Medium Slow
			Dialing Prefix	
		General Fax Send Settings	PC Fax Send	Enabled* Disabled

Table 2-6 Fax Settings menu (continued)

First level	Second level	Third level	Fourth level	Values
			Fax Header	Prepend* Overlay
			Error Correction Mode	Enabled* Disabled
			Fax Number Confirmation	Enabled Disabled*
			JBIG Compression	Enabled* Disabled
		Billing Codes	Enable Billing Codes	Off* On
			Minimum Length	Range: 1 – 16 Default = 1
			Default Billing Code	
			Allow users to edit billing codes	
	Default Job Options	Image Preview		Make optional* Require preview Disable preview
		Resolution		Standard (100 x 200dpi)* Fine (200 x 200dpi) Superfine (300 x 300dpi)
		Original Sides		1-sided* 2-sided
			Orientation	Portrait* Landscape Book-style* Flipstyle

Table 2-6 Fax Settings menu (continued)

First level	Second level	Third level	Fourth level	Values
		Notification		Do not notify*
				Notify when job completes
				Notify only if job fails
				Print
				E-mail
			Notification E-mail address	
			Include Thumbnail	
		Content Orientation	Orientation	Portrait*
				Landscape
			2-Sided Format	Book-style*
				Flip-style
		Original Size		Select from a list of sizes that the product supports.
		Image Adjustment	Darkness	
			Contrast	
			Background Cleanup	
			Sharpness	
		Optimize Text/Picture	Optimize For:	Manually adjust*
				Text
				Printed picture
				Photograph
		Job Build		Job Build off*
				Job Build on
		Blank Page Suppression		Disabled*
				Enabled
Fax Receive Settings	Fax Receive Setup	Rings To Answer		
		Ring Frequency		
		Ring Interval		
		Ringer Volume		Off
				Low*
				High

Table 2-6 Fax Settings menu (continued)

First level	Second level	Third level	Fourth level	Values
		Fax Receive Speed		Fast Medium Slow
	Fax Printing Schedule	Incoming Fax Options		Always store faxes Always print faxes* Use Fax Printing Schedule
		Schedule Touch this to set up a fax printing schedule if you selected the Use Fax Printing Schedule option.	Add (plus sign) Edit	Print incoming faxes Store incoming faxes Event Time Event Days
	Blocked Fax Numbers	Fax Number to Block		
	Default Job Options	Notification		Do not notify Notify when job completes Notify only if job fails Include Thumbnail
		Stamp Received Faxes		Enabled Disabled*
		Fit to Page		Enabled* Disabled
		Paper Selection		Automatic Select from a list of the trays.
		Output Bin		Select from a list of the bins.
		Sides		1-sided 2-sided
Fax Archive and Forwarding	Enable Fax Archiving			
		Type of Fax Job to Archive		Send and receive* Send only Receive only

Table 2-6 Fax Settings menu (continued)

First level	Second level	Third level	Fourth level	Values
		Fax Archiving E-mail Address		
	Enable Fax Forwarding			
		Type of Fax Job to Forward		Send and receive Send only Receive only
		Fax Forwarding Number		

Print Settings menu

To display: At the product control panel, select the [Administration](#) menu, and then select the [Print Settings](#) menu.

In the following table, asterisks (*) indicate the factory default setting.

Table 2-7 Print Settings menu

First level	Second level	Values
Manual Feed		Enabled Disabled*
Courier Font		Regular* Dark
Wide A4		Enabled Disabled*
Print PS Errors		Enabled Disabled*
Print PDF Errors		Enabled Disabled*
Personality		Auto* PCL POSTSCRIPT PDF
PCL	Form Length	Range: 5 – 128 Default = 60

Table 2-7 Print Settings menu (continued)

First level	Second level	Values
	Orientation	Portrait* Landscape
	Font Source	Internal* Card slot 1 Card slot <X> EIO <X> disk USB
	Font Number	Range: 0 – 999 Default = 0
	Font Pitch	Range: 0.44 – 99.99 Default = 10
	Font Point Size	Range: 4.00 – 999.75 Default = 12.00
	Symbol Set	Select from a list of symbol sets.
	Append CR to LF	No* Yes
	Suppress Blank Pages	No* Yes
	Media Source Mapping	Standard* Classic

Print Options menu

To display: At the product control panel, select the [Administration](#) menu, and then select the [Print Options](#) menu.

In the following table, asterisks (*) indicate the factory default setting.

Table 2-8 Print Options menu

First level	Second level	Values
Number of Copies		
Default Paper Size		Select from a list of sizes that the product supports.
Default Custom Paper Size	X Dimension	

Table 2-8 Print Options menu (continued)

First level	Second level	Values
	Y Dimension	
	Use Inches	
	Use Millimeters	
Output Bin		
Sides		1-sided*
		2-sided
2-Sided Format		Book-style*
		Flip-style
Enable Edge-To-Edge Override		Enabled
		Disabled*

Display Settings menu

To display: At the product control panel, select the [Administration](#) menu, and then select the [Display Settings](#) menu.

In the following table, asterisks (*) indicate the factory default setting.

Table 2-9 Display Settings menu

First level	Second level	Values
Key Press Sound		On*
		Off
Language Settings	Language	Select from a list of languages that the product supports.
	Keyboard Layout	Each language has a default keyboard layout. To change it, select from a list of layouts.
Network Address Button		Display
		Hide
Sleep Mode		Disabled
		Use sleep delay*
		Use sleep schedule
		Balance power savings/Wait time
Inactivity Timeout		Range: 10 – 300 seconds
		Default = 60 seconds

Table 2-9 Display Settings menu (continued)

First level	Second level	Values
Clearable Warnings		On
		Job*
Continuable Events		Auto continue (10 seconds)*
		Press OK to continue

Manage Supplies menu

To display: At the product control panel, select the [Administration](#) menu, and then select the [Manage Supplies](#) menu.

In the following table, asterisks (*) indicate the factory default setting.

Table 2-10 Manage Supplies menu

First level	Second level	Third level	Fourth level	Values
Supplies Status				Print View
Supply Settings	Black Cartridge	Very Low Settings		Stop Prompt to continue* Continue
		Low Threshold Settings		1-100% Default = 10%
	Color Cartridges	Very Low Settings		Stop Prompt to continue* Continue
		Low Threshold Settings	Cyan Cartridge Magenta Cartridge Yellow Cartridge	1-100% Default = 10%
	Fuser Kit	Very Low Settings		Stop Prompt to continue* Continue
		Low Threshold Settings		1-100% Default = 10%
	Transfer Kit	Very Low Settings		Stop Prompt to continue* Continue
		Low Threshold Settings		1-100% Default = 10%
	Document Feeder Kit	Very Low Settings		Stop Prompt to continue* Continue

Table 2-10 Manage Supplies menu (continued)

First level	Second level	Third level	Fourth level	Values
		Low Threshold Settings		1-100% Default = 10%
	Toner Collection Unit	Very Low Settings		Stop* Prompt to continue Continue
	Color/Black Mix			Auto* Mostly Color Pages Mostly Black Pages
Supply Messages	Low Message			On* Off
Reset Supplies	New Document Feeder Kit			No Yes

Manage Trays menu

To display: At the product control panel, select the [Administration](#) menu, and then select the [Manage Trays](#) menu.

In the following table, asterisks (*) indicate the factory default setting.

Table 2-11 Manage Trays menu

First level	Values
Use Requested Tray	Exclusively* First
Manually Feed Prompt	Always* Unless loaded
Size/Type Prompt	Display* Do not display
Use Another Tray	Enabled* Disabled
Alternative Letterhead Mode	Disabled* Enabled
Blank Pages	Auto* Yes

Table 2-11 Manage Trays menu (continued)

First level	Values
Image Rotation	Standard
	Alternate
Override A4/Letter	Yes*
	No

Stapler/Stacker Settings menu

To display: At the product control panel, select the [Administration](#) menu, and then select the [Stapler/Stacker Settings](#) menu.

In the following table, asterisks (*) indicate the factory default setting.

Table 2-12 Stapler/Stacker Settings menu

First level	Values
Operation Mode	Mailbox
	Stacker
	Function Separator
Stapling	None
	Top left or right
	Top left
	Top right
Staples Very Low	Continue
	Stop

Network Settings menu

To display: At the product control panel, select the [Administration](#) menu, and then select the [Network Settings](#) menu.

In the following table, asterisks (*) indicate the factory default setting.

Table 2-13 Network Settings menu

First level	Values
I/O Timeout	Range: 5 – 300 sec Default = 15
Embedded Jetdirect Menu EIO <X> Jetdirect Menu	See the table that follows for details. These menus have the same structure. If an additional HP Jetdirect network card is installed in the EIO slot, then both menus are available.

Table 2-14 Embedded Jetdirect Menu/EIO <X> Jetdirect Menu

First level	Second level	Third level	Fourth level	Values
Information	Print Sec Page			Yes
				No*
TCP/IP	Enable			On*
				Off
	Host Name			
	IPV4 Settings	Config Method		Bootp
			DHCP*	
				Auto IP
				Manual
		Manual Settings	IP Address	Enter the address.
		<p>NOTE: This menu is available only if you select the Manual option under the Config Method menu.</p>		
			Subnet Mask	Enter the address.
			Default Gateway	Enter the address.
		Default IP		Auto IP*
				Legacy
		DHCP Release		No*
				Yes
		DHCP Renew		No*
				Yes
		Primary DNS		
		Secondary DNS		

Table 2-14 Embedded Jetdirect Menu/EIO <X> Jetdirect Menu (continued)

First level	Second level	Third level	Fourth level	Values
	IPv6 Settings	Enable		Off On*
		Address	Manual Settings	Enable Address
		DHCPV6 Policy		Router Specified Router Unavailable* Always
		Primary DNS		
		Secondary DNS		
Security	Secure Web			HTTPS Required* HTTPS Optional
	IPSEC			Keep Disable*
	802.1X			Reset Keep*
	Reset Security			Yes No*
Diagnostics	Embedded Tests	LAN HW Test		Yes No*
		HTTP Test		Yes No*
		SNMP Test		Yes No*
		Data Path Test		Yes No*
		Select All Tests		Yes No*
		Execution Time [M]		Range: 1 – 60 hours Default = 1 hour

Table 2-14 Embedded Jetdirect Menu/EIO <X> Jetdirect Menu (continued)

First level	Second level	Third level	Fourth level	Values
		Execute		No*
				Yes
Link Speed				Auto*
				10T Half
				10T Full
				100TX Half
				100TX Full

Troubleshooting menu

To display: At the product control panel, select the [Administration](#) menu, and then select the [Troubleshooting](#) menu.

In the following table, asterisks (*) indicate the factory default setting.

Table 2-15 Troubleshooting menu

First level	Second level	Third level	Fourth level	Values
Event Log				View*
				Print
Paper Path Page				View*
				Print
Fax	Fax T.30 Trace	Print T.30 Report	When to Print Report	Print
				Never automatically print*
				Print after every fax
				Print only after fax send jobs
				Print after any fax error
				Print only after fax send errors
				Print only after fax receive errors
				Save
	Fax V.34			Normal*
				Off

Table 2-15 Troubleshooting menu (continued)

First level	Second level	Third level	Fourth level	Values
	Fax Speaker Mode			Normal*
				Diagnostic
Print Quality Pages	PQ Troubleshooting Pages			Print
	Diagnostic Page			Print
	Color Band Test	Print Test Page		Print
		Copies		Range: 1 – 30
Diagnostic Tests	Disable Cartridge Check			
	Paper Path Sensors	Select from a list of the product sensors.		
	Paper Path Test	Test Page		Print
		Source		Select from a list of the available trays.
		Destination		Select from a list of the available bins.
		Duplex		Off*
				On
		Copies		1*
				10
				50
				100
				500
		Stacking		Off
				On
	Manual Sensor Test			Select from a list of available components.
	Tray/Bin Manual Sensor Test			Select from a list of available components.
	Component Test			Select from a list of available components.
	Print/Stop Test			Range: 0 – 60,000
	Scanner Tests			Select from a list of available components.

Table 2-15 Troubleshooting menu (continued)

First level	Second level	Third level	Fourth level	Values
	Control Panel			LEDs Display Buttons Touchscreen
Retrieve Diagnostic Data				Create device data file Create zipped debug information file Include crash dump files Clean up debug information Send to E-mail Export to USB

Device Maintenance menu

Backup/Restore menu

To display: At the product control panel, select the [Device Maintenance](#) menu, and then select the [Backup/Restore](#) menu.

In the following table, asterisks (*) indicate the factory default setting.

Table 2-16 Backup/Restore menu

First level	Second level	Third level	Values
Backup Data	Enable Scheduled Backups	Backup Time	Enter a time
		Days Between Backups	Enter the number of days
	Backup Now		
	Export Last Backup		
Restore Data			Insert a USB drive that contains the backup file.

Calibration/Cleaning menu

To display: At the product control panel, select the [Device Maintenance](#) menu, and then select the [Calibration/Cleaning](#) menu.

In the following table, asterisks (*) indicate the factory default setting.

Table 2-17 Calibration/Cleaning menu

First level	Second level	Values
Cleaning Settings	Auto Cleaning	Off*
		On
	Cleaning Interval	
	Cleaning Size	
Cleaning Page		Print
Quick Calibration		
Full Calibration		
Delay Calibration at Wake/Power On		Yes*
		No
Calibrate Scanner		

USB Firmware Upgrade menu

To display: At the product control panel, select the [Device Maintenance](#) menu, and then select the [USB Firmware Upgrade](#) menu.

Insert a USB storage device with a firmware upgrade bundle into the USB port, and follow the on-screen instructions.

Service menu

To display: At the product control panel, select the [Device Maintenance](#) menu, and then select the [Service](#) menu.

The [Service](#) menu is locked and requires a PIN for access. This menu is intended for use by authorized service personnel.

3 Software for Windows

- [Supported operating systems for Windows](#)
- [Supported printer drivers for Windows](#)
- [Select the correct printer driver for Windows](#)
- [Priority for print settings](#)
- [Change printer-driver settings for Windows](#)
- [Remove software for Windows](#)
- [Supported utilities for Windows](#)
- [Software for other operating systems](#)

Supported operating systems for Windows

The product supports the following Windows operating systems:

- Windows XP (32-bit and 64-bit)
- Windows Server 2003 (32-bit and 64-bit)
- Windows Server 2008 (32-bit and 64-bit)
- Windows Vista (32-bit and 64-bit)
- Windows 7 (32-bit and 64-bit)

Supported printer drivers for Windows

- HP PCL 6 (this is the default printer driver)
- HP postscript emulation Universal Print Driver (HP UPD PS)
- HP PCL 5 Universal Print Driver (HP UPD PCL 5)
- HP PCL 6 Universal Print Driver (HP UPD PCL 6)

The printer drivers include online Help that has instructions for common printing tasks and also describes the buttons, checkboxes, and drop-down lists that are in the printer driver.

 **NOTE:** For more information about the UPD, see www.hp.com/go/upd.

Select the correct printer driver for Windows

Printer drivers provide access to the product features and allow the computer to communicate with the product (using a printer language). The following printer drivers are available at www.hp.com/go/cljcm4540mfp_software.

HP PCL 6 driver

- Provided as the default driver. This driver is automatically installed unless you select a different one.
- Recommended for all Windows environments
- Provides the overall best speed, print quality, and product-feature support for most users
- Developed to align with the Windows Graphic Device Interface (GDI) for the best speed in Windows environments
- Might not be fully compatible with third-party and custom software programs that are based on PCL 5

HP UPD PS driver

- Recommended for printing with Adobe® software programs or with other highly graphics-intensive software programs
- Provides support for printing from postscript emulation needs, or for postscript flash font support

HP UPD PCL 5

- Recommended for general office printing in Windows environments
- Compatible with previous PCL versions and older HP LaserJet products
- The best choice for printing from third-party or custom software programs
- The best choice when operating with mixed environments, which require the product to be set to PCL 5 (UNIX, Linux, mainframe)
- Designed for use in corporate Windows environments to provide a single driver for use with multiple printer models
- Preferred when printing to multiple printer models from a mobile Windows computer

HP UPD PCL 6

- Recommended for printing in all Windows environments
 - Provides the overall best speed, print quality, and printer feature support for most users
 - Developed to align with Windows Graphic Device Interface (GDI) for best speed in Windows environments
 - May not be fully compatible with third-party and custom solutions based on PCL5
-

HP Universal Print Driver (UPD)

The HP Universal Print Driver (UPD) for Windows is a single driver that gives you instant access to virtually any HP LaserJet product, from any location, without downloading separate drivers. It is built on proven HP print driver technology and has been tested thoroughly and used with many software programs. It is a powerful solution that performs consistently over time.

The HP UPD communicates directly with each HP product, gathers configuration information, and then customizes the user interface to show the product's unique, available features. It automatically enables features that are available for the product, such as two-sided printing and stapling, so you do not need to enable them manually.

For more information, go to www.hp.com/go/upd.

UPD installation modes

Traditional mode	<ul style="list-style-type: none">• Use this mode if you are installing the driver from a CD for a single computer.• When installed from the CD that comes with the product, UPD operates like traditional printer drivers. It operates with a specific product.• If you use this mode, you must install UPD separately for each computer and for each product.
Dynamic mode	<ul style="list-style-type: none">• To use this mode, download UPD from the Internet. See www.hp.com/go/upd.• Dynamic mode allows you to use a single driver installation, so you can discover and print to HP products in any location.• Use this mode if you are installing UPD for a workgroup.

Priority for print settings

Changes to print settings are prioritized depending on where the changes are made:

 **NOTE:** The names of commands and dialog boxes might vary depending on your software program.

- **Page Setup dialog box:** Click **Page Setup** or a similar command on the **File** menu of the program you are working in to open this dialog box. Settings changed here override settings changed anywhere else.
- **Print dialog box:** Click **Print**, **Print Setup**, or a similar command on the **File** menu of the program you are working in to open this dialog box. Settings changed in the **Print** dialog box have a lower priority and usually do not override changes made in the **Page Setup** dialog box.
- **Printer Properties dialog box (printer driver):** Click **Properties** in the **Print** dialog box to open the printer driver. Settings changed in the **Printer Properties** dialog box usually do not override settings anywhere else in the printing software. You can change most of the print settings here.
- **Default printer driver settings:** The default printer driver settings determine the settings used in all print jobs, *unless* settings are changed in the **Page Setup**, **Print**, or **Printer Properties** dialog boxes.
- **Printer control panel settings:** Settings changed at the printer control panel have a lower priority than changes made anywhere else.

Change printer-driver settings for Windows

Change the settings for all print jobs until the software program is closed

1. On the **File** menu in the software program, click **Print**.
2. Select the driver, and then click **Properties** or **Preferences**.

The steps can vary; this procedure is most common.

Change the default settings for all print jobs

1. **Windows XP, Windows Server 2003, and Windows Server 2008 (using the default Start menu view):** Click **Start**, and then click **Printers and Faxes**.

Windows XP, Windows Server 2003, and Windows Server 2008 (using the Classic Start menu view): Click **Start**, click **Settings**, and then click **Printers**.

Windows Vista: Click **Start**, click **Control Panel**, and then in the category for **Hardware and Sound** click **Printer**.

Windows 7: Click **Start**, and then click **Devices and Printers**.

2. Right-click the driver icon, and then select **Printing Preferences**.

Change the product configuration settings

1. **Windows XP, Windows Server 2003, and Windows Server 2008 (using the default Start menu view):** Click **Start**, and then click **Printers and Faxes**.

Windows XP, Windows Server 2003, and Windows Server 2008 (using the Classic Start menu view): Click **Start**, click **Settings**, and then click **Printers**.

Windows Vista: Click **Start**, click **Control Panel**, and then in the category for **Hardware and Sound** click **Printer**.

Windows 7: Click **Start**, and then click **Devices and Printers**.

2. Right-click the driver icon, and then select **Properties** or **Printer properties**.
3. Click the **Device Settings** tab.

Remove software for Windows

Windows XP

1. Click **Start, Control Panel**, and then **Add or Remove Programs**.
2. Find and select the product from the list.
3. Click the **Change/Remove** button to remove the software.

Windows Vista

1. Click **Start, Control Panel**, and then **Programs and Features**.
2. Find and select the product from the list.
3. Select the **Uninstall/Change** option.

Windows 7

1. Click **Start, Control Panel**, and then under the **Programs** heading, click **Uninstall a program**.
2. Find and select the product from the list.
3. Select the **Uninstall** option.

Supported utilities for Windows

HP Web Jetadmin

HP Web Jetadmin is a simple print and imaging peripheral management software tool that helps optimize product use, control color costs, secure products, and streamline supplies management by enabling remote configuration, proactive monitoring, security troubleshooting, and reporting of printing and imaging products.

To download a current version of HP Web Jetadmin and for the latest list of supported host systems, visit www.hp.com/go/webjetadmin.

When installed on a host server, a Windows client can gain access to HP Web Jetadmin by using a supported Web browser (such as Microsoft® Internet Explorer) by navigating to the HP Web Jetadmin host.

HP Embedded Web Server

The product is equipped with the HP Embedded Web Server, which provides access to information about product and network activities. This information appears in a Web browser, such as Microsoft Internet Explorer, Netscape Navigator, Apple Safari, or Mozilla Firefox.

The HP Embedded Web Server resides on the product. It is not loaded on a network server.

The HP Embedded Web Server provides an interface to the product that anyone who has a network-connected computer and a standard Web browser can use. No special software is installed or configured, but you must have a supported Web browser on your computer. To gain access to the HP Embedded Web Server, type the IP address for the product in the address line of the browser. (To find the IP address, print a configuration page. For more information about printing a configuration page, see [Print information pages on page 264](#)).

For a complete explanation of the features and functionality of the HP Embedded Web Server, see [Use the HP Embedded Web Server on page 266](#).

Software for other operating systems

OS	Software
UNIX	<p>For HP-UX and Solaris networks, go to www.hp.com/go/jetdirectunix_software to install model scripts using the HP Jetdirect printer installer (HPPI) for UNIX.</p> <p>For the latest model scripts, go to www.hp.com/go/unixmodelscripts.</p>
Linux	<p>For information, go to www.hplip.net.</p>
SAP devices	<p>For drivers, go to www.hp.com/go/sap/drivers</p> <p>For information, go to www.hp.com/go/sap/print</p>

4 Use the product with Mac

- [Software for Mac](#)
- [Print with Mac](#)
- [Solve problems with a Mac](#)

Software for Mac

Supported operating systems for Mac

The product supports the following Mac operating systems:

- Mac OS X 10.4, 10.5, 10.6, and later

 **NOTE:** For Mac OS X 10.4 and later, PPC and Intel® Core™ Processor Macs are supported.

Supported printer drivers for Mac

The HP LaserJet software installer provides PostScript® Printer Description (PPD) files, Printer Dialog Extensions (PDEs), and the HP Utility for use with Mac OS X computers. The HP printer PPD and PDE files, in combination with the built-in Apple PostScript printer drivers, provide full printing functionality and access to specific HP printer features.

Install software for Mac operating systems

Install software for Mac computers connected directly to the product

This product supports a USB 2.0 connection. Use an A-to-B type USB cable. HP recommends using a cable that is no longer than 2 m (6.5 ft).

1. Install the software from the CD.
2. Click the product icon, and follow the onscreen instructions.
3. Click the **Close** button.
4. When the software prompts you, connect the USB cable to the product and the computer.

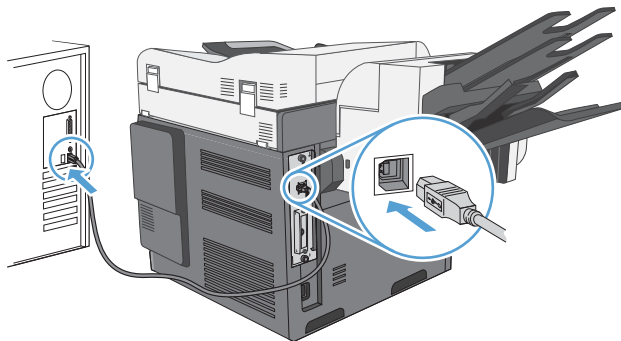

5. To configure the product software to recognize the installed accessories, complete these steps:

Mac OS X 10.4

1. From the Apple menu , click the **System Preferences** menu and then click the **Print & Fax** icon.
2. Click the **Printer Setup** button.
3. Click the **Installable Options** menu.
4. Configure the installed options.

Mac OS X 10.5 and 10.6

1. From the Apple menu , click the **System Preferences** menu and then click the **Print & Fax** icon.
2. Select the product in the left side of the window.
3. Click the **Options & Supplies** button.
4. Click the **Driver** tab.
5. Configure the installed options.

NOTE: For Mac OS X 10.5 and 10.6, the installation procedure should automatically configure the installed options.

-
6. Print a page from any program to make sure that the software is correctly installed.

 **NOTE:** If the installation failed, reinstall the software.

Install software for Mac computers on a wired network

Configure the IP address

1. Make sure the product is turned on and that the **Ready** message appears on the control-panel display.
2. Connect the network cable to the product and to the network.

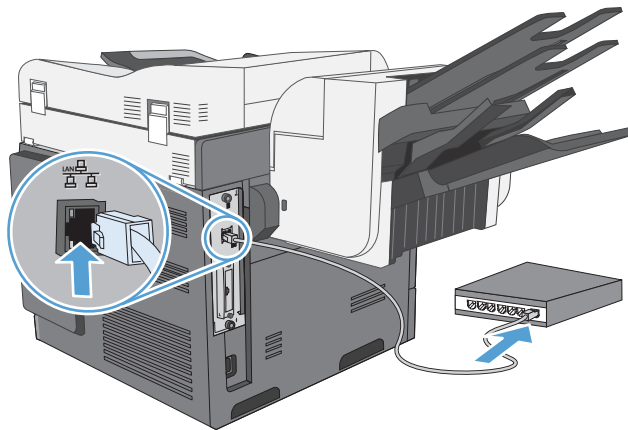

3. Wait for 60 seconds before continuing. During this time, the network recognizes the product and assigns an IP address or host name for the product.
4. At the product control panel, touch the **Network Address** button to identify the product IP address or host name.

If the [Network Address](#) button is not visible, you can find the IP address or host name by printing a configuration page.

- a. At the product control panel, scroll to and touch the [Administration](#) button.
- b. Open the following menus:
 - [Reports](#)
 - [Configuration/Status Pages](#)
 - [Configuration Page](#)
- c. Touch the [View](#) button to view the information on the control panel, or touch the [Print](#) button to print the pages.
- d. Find the IP address on the Jetdirect page.

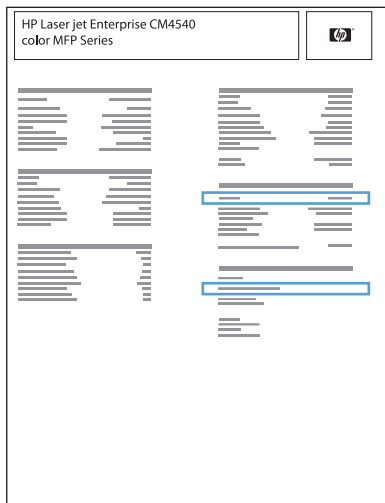

5. **IPv4:** If the IP address is 0.0.0.0, or 192.0.0.192, or 169.254.x.x, you must manually configure the IP address. Otherwise, the network configuration was successful.

IPv6: If the IP address begins with "fe80:", the product should be able to print. If not, you must manually configure the IP address.

Install the software

1. Quit all programs on the computer.
2. Install the software from the CD.
3. Click the product icon, and follow the onscreen instructions.
4. Click the **Close** button when the installation is complete.
5. At the computer, open the Apple menu , click the **System Preferences** menu, and then click the **Print & Fax** icon.
6. Click the plus symbol (+).

By default, Mac OS X uses the Bonjour method to find the driver and add the product to the printer pop-up menu. This method is best in most situations. If Mac OS X cannot find the HP printer driver, an error message displays. Reinstall the software.

If you are connecting the product to a large network, you might need to use IP printing to connect rather than Bonjour. Follow these steps:

- a. Click the **IP Printer** button.
 - b. From the **Protocol** drop-down list, select the **HP Jetdirect-Socket** option. Enter the IP address or host name for the product. From the **Print Using** drop-down list, select the product model if one is not already selected.
7. To configure the product to recognize the installed accessories, complete these steps:

Mac OS X 10.4

1. From the Apple menu , click the **System Preferences** menu and then click the **Print & Fax** icon.
2. Click the **Printer Setup** button.
3. Click the **Installable Options** menu.
4. Configure the installed options.

Mac OS X 10.5 and 10.6

1. From the Apple menu , click the **System Preferences** menu and then click the **Print & Fax** icon.
2. Select the product in the left side of the window.
3. Click the **Options & Supplies** button.
4. Click the **Driver** tab.
5. Configure the installed options.

NOTE: For Mac OS X 10.5 and 10.6, the installation procedure should automatically configure the installed options.

8. Print a page from any program to make sure that the software is correctly installed.

Remove software from Mac operating systems

You must have administrator rights to remove the software.

1. Open **System Preferences**.
2. Select **Print & Fax**.
3. Highlight the product.
4. Click the minus (-) symbol.

5. Delete the print queue, if necessary.
6. Delete the .GZ file from the following hard-drive folder:
 - **Mac OS X 10.4:** Library/Printers/PPDs/Contents/Resources/<lang>.lproj, where <lang> is the two-letter language code for the language that you are using.
 - **Mac OS X 10.5 and 10.6:** Library/Printers/PPDs/Contents/Resources



Priority for print settings for Mac

Changes to print settings are prioritized depending on where the changes are made:

 **NOTE:** The names of commands and dialog boxes might vary depending on your software program.

- **Page Setup dialog box:** Click **Page Setup** or a similar command on the **File** menu of the program you are working in to open this dialog box. Settings changed here might override settings changed anywhere else.
- **Print dialog box:** Click **Print**, **Print Setup**, or a similar command on the **File** menu of the program you are working in to open this dialog box. Settings changed in the **Print** dialog box have a lower priority and do *not* override changes made in the **Page Setup** dialog box.
- **Default printer driver settings:** The default printer driver settings determine the settings used in all print jobs, *unless* settings are changed in the **Page Setup**, **Print**, or **Printer Properties** dialog boxes.
- **Printer control panel settings:** Settings changed at the printer control panel have a lower priority than changes made anywhere else.

Change printer-driver settings for Mac

Change the settings for all print jobs until the software program is closed	Change the default settings for all print jobs	Change the product configuration settings
<ol style="list-style-type: none">1. On the File menu, click the Print button.2. Change the settings that you want on the various menus.	<ol style="list-style-type: none">1. On the File menu, click the Print button.2. Change the settings that you want on the various menus.3. On the Presets menu, click the Save As... option and type a name for the preset. <p>These settings are saved in the Presets menu. To use the new settings, you must select the saved preset option every time you open a program and print.</p>	<p>Mac OS X 10.4</p> <ol style="list-style-type: none">1. From the Apple menu , click the System Preferences menu and then click the Print & Fax icon.2. Click the Printer Setup button.3. Click the Installable Options menu.4. Configure the installed options. <p>Mac OS X 10.5 and 10.6</p> <ol style="list-style-type: none">1. From the Apple menu , click the System Preferences menu and then click the Print & Fax icon.2. Select the product in the left side of the window.3. Click the Options & Supplies button.4. Click the Driver tab.5. Configure the installed options.

Software for Mac computers

HP Utility for Mac

Use the HP Utility to set up product features that are not available in the printer driver.

You can use the HP Utility when the product uses a universal serial bus (USB) cable or is connected to a TCP/IP-based network.

Open the HP Printer Utility

Mac OS X 10.4	<ol style="list-style-type: none">1. Open the Finder, click Applications, click Utilities, and then double-click Printer Setup Utility.2. Select the product that you want to configure, and then click Utility.
Mac OS X 10.5 and 10.6	<ol style="list-style-type: none">1. From the Printer Browser menu, click Printer Utility. <p style="text-align: center;">-or-</p> <p>From the Print Queue, click the Utility icon.</p>

HP Utility features

The HP Utility consists of pages that you open by clicking in the **Configuration Settings** list. The following table describes the tasks that you can perform from these pages. At the top of any page, click the **HP Support** link to access technical assistance, online supplies ordering, online registration, and recycling and return information.

Menu	Item	Description
Information And Support	Supplies Status	Shows the product supplies status and provides links for online supplies-ordering.
	Device Information	Shows information about the currently selected product.
	Color Usage	Shows the total pages printed, the number of pages printed in color, and the number of pages printed in black only.
	File Upload	Transfers files from the computer to the product.
	Upload Fonts	Transfers font files from the computer to the product.
	Update Firmware	Transfers a firmware update file to the product.
	Commands	Sends special characters or print commands to the product after the print job.
Printer Settings	Trays Configuration	Changes the default tray settings.
	Duplex Mode	Turns on the automatic two-sided printing mode.
	Stored Jobs	Manages print jobs that are stored on the product hard disk.
	E-mail Alerts	Configures the product to send e-mail notices for certain events.
	Network Settings	Configures the network settings, such as the IPv4 and IPv6 settings.

Menu	Item	Description
	Supplies Management	Configures how the product should behave when supplies are nearing the end of their estimated life.
	Restrict Color	Configures color-printing restrictions for specific users and software programs. NOTE: This option is available only after you open the View menu and select the Show Advanced option.
	Protect Direct Ports	Disables printing over USB or parallel ports.
	Additional Settings	Provides access to the HP Embedded Web Server.

Supported utilities for Mac

HP Embedded Web Server

The product is equipped with the HP Embedded Web server, which provides access to information about product and network activities. Access the HP Embedded Web Server from the HP Utility. Open the **Printer Settings** menu, and then select the **Additional Settings** option.

Print with Mac

Cancel a print job with Mac

1. If the print job is currently printing, cancel it by following this procedure:
 - a. Press the Stop  button on the product control panel.
 - b. From the list on the touchscreen, touch the print job you want to delete, and touch the **Cancel Job** button.
 - c. The product prompts you to confirm the deletion. Touch the **Yes** button.
2. You can also cancel a print job from a software program or a print queue.
 - **Software program:** Typically, a dialog box appears briefly on the computer screen, allowing you to cancel the print job.
 - **Mac print queue:** Open the print queue by double-clicking the product icon in the Dock. Highlight the print job, and then click **Delete**.

Change the paper size and type with Mac

1. On the **File** menu in the software program, click the **Print** option.
2. In the **Copies & Pages** menu, click the **Page Setup** button.
3. Select a size from the **Paper Size** drop-down list, and then click the **OK** button.
4. Open the **Finishing** menu. (Mac OS X 10.5 and 10.6)
5. Select a type from the **Media-type** drop-down list.
6. Click the **Print** button.

Create and use printing presets with Mac

Use printing presets to save the current printer driver settings for reuse.

Create a printing preset

1. On the **File** menu, click the **Print** option.
2. Select the driver.
3. Select the print settings that you want to save for reuse.
4. In the **Presets** menu, click the **Save As...** option, and type a name for the preset.
5. Click the **OK** button.

Use printing presets

1. On the **File** menu, click the **Print** option.
2. Select the driver.
3. In the **Presets** menu, select the printing preset.

 **NOTE:** To use printer-driver default settings, select the **standard** option.

Resize documents or print on a custom paper size with Mac

- | | |
|--------------------------------------|---|
| Mac OS X 10.4, 10.5, and 10.6 | <ol style="list-style-type: none">1. On the File menu, click the Page Setup option.2. Select the product, and then select the correct settings for the Paper Size and Orientation options. |
| Mac OS X 10.5 and 10.6 | <ol style="list-style-type: none">1. On the File menu, click the Print option.2. Click the Page Setup button.3. Select the product, and then select the correct settings for the Paper Size and Orientation options. |
- Use one of these methods.
1. On the **File** menu, click the **Print** option.
 2. Open the **Paper Handling** menu.
 3. In the **Destination Paper Size** area, click the **Scale to fit paper size** box, and then select the size from the drop-down list.

Print a cover page with Mac

1. On the **File** menu, click the **Print** option.
2. Select the driver.
3. Open the **Cover Page** menu, and then select where to print the cover page. Click either the **Before Document** button or the **After Document** button.
4. In the **Cover Page Type** menu, select the message that you want to print on the cover page.

 **NOTE:** To print a blank cover page, select the **standard** option from the **Cover Page Type** menu.

Use watermarks with Mac

1. On the **File** menu, click the **Print** option.
2. Open the **Watermarks** menu.
3. From the **Mode** menu, select the type of watermark to use. Select the **Watermark** option to print a semi-transparent message. Select the **Overlay** option to print a message that is not transparent.

4. From the **Pages** menu, select whether to print the watermark on all pages or on the first page only.
5. From the **Text** menu, select one of the standard messages, or select the **Custom** option and type a new message in the box.
6. Select options for the remaining settings.

Print multiple pages on one sheet of paper with Mac

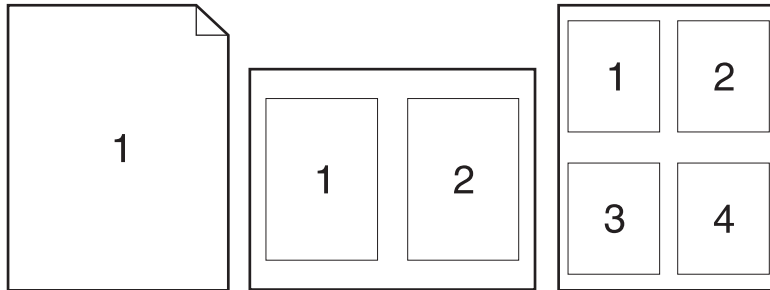

1. On the **File** menu, click the **Print** option.
2. Select the driver.
3. Open the **Layout** menu.
4. From the **Pages per Sheet** menu, select the number of pages that you want to print on each sheet (1, 2, 4, 6, 9, or 16).
5. In the **Layout Direction** area, select the order and placement of the pages on the sheet.
6. From the **Borders** menu, select the type of border to print around each page on the sheet.

Print on both sides (duplex) with Mac

1. Insert enough paper into one of the trays to accommodate the print job.
2. On the **File** menu, click the **Print** option.
3. Open the **Layout** menu.
4. From the **Two-Sided** menu, select a binding option.

Store jobs with Mac

You can store jobs on the product so you can print them at any time. You can share stored jobs with other users, or you can make them private.

1. On the **File** menu, click the **Print** option.
2. Open the **Job Storage** menu.
3. In the **Job Storage Mode** drop-down list, select the type of stored job.
 - **Proof and Hold:** This feature provides a quick way to print and proof one copy of a job and then print more copies.
 - **Personal Job:** When you send a job to the product, the job does not print until you request it at the product control panel. If you assign a personal identification number (PIN) to the job, you must provide the required PIN at the control panel.
 - **Quick Copy:** If the optional hard disk is installed on the product, you can print the requested number of copies of a job and then store a copy of the job on the optional hard disk. Storing the job allows you to print additional copies of the job later.
 - **Stored Job:** If the optional hard disk is installed on the product, you can store a job such as a personnel form, time sheet, or calendar on the product and allow other users to print the job at any time. Stored jobs also can be protected by a PIN.
4. To use a custom user name or job name, click the **Custom** button, and then enter the user name or the job name.

Select which option to use if another stored job already has that name.

Use Job Name + (1 - 99)	Append a unique number to the end of the job name.
Replace Existing File	Overwrite the existing stored job with the new one.

5. If you selected the **Stored Job** or **Personal Job** option in step 3, you can protect the job with a PIN. Type a 4-digit number in the **Use PIN to Print** field. When other people attempt to print this job, the product prompts them to enter this PIN number.

Set the color options with Mac

Use the **Color Options** menu or the **Color/Quality Options** menu to control how colors are interpreted and printed from software programs.

1. On the **File** menu, click the **Print** option.
2. Select the driver.
3. Open the **Color Options** menu or the **Color/Quality Options** menu.
4. Select the appropriate tab and adjust the settings.

Solve problems with a Mac

See [Solve product software problems with Mac on page 319](#).

5 Connect the product

- [Printer sharing disclaimer](#)
- [Connect with USB](#)
- [Connect to a network](#)

Printer sharing disclaimer

HP does not support peer-to-peer networking, as the feature is a function of Microsoft operating systems and not of the HP printer drivers. Go to Microsoft at www.microsoft.com.

Connect with USB

This product supports a USB 2.0 connection. Use an A-to-B type USB cable. HP recommends using a cable that is no longer than 2 m (6.5 ft).

△ **CAUTION:** Do not connect the USB cable until the installation software prompts you to connect it.

CD installation

1. Quit all open programs on the computer.
2. Install the software from the CD, and follow the onscreen instructions.
3. When prompted, select the **Directly connect to this computer using USB cable** option, and then click the **Next** button.
4. When the software prompts you, connect the USB cable to the product and the computer.

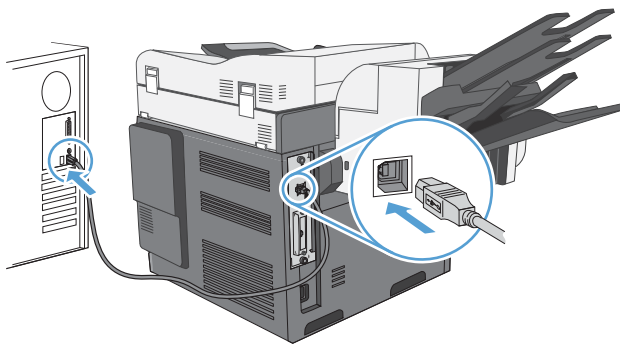

5. At the end of the installation, click the **Finish** button, or click the **More Options** button to install more software.
6. On the **More Options** screen, you can install more software, or click the **Exit** button.
7. Print a page from any program to make sure that the software is correctly installed.

📄 **NOTE:** If the installation failed, reinstall the software.

Connect to a network

You can configure network parameters from the control panel, the HP Embedded Web Server, or for most networks, from the HP Web Jetadmin software.

📄 **NOTE:** HP Web Jetadmin software is not supported on Mac OS X operating systems.

For a complete list of supported networks and for instructions on configuring network parameters from software, see the *HP Jetdirect Embedded Print Server Administrator's Guide*. The guide comes with products in which an HP Jetdirect embedded print server is installed.

Supported network protocols

Table 5-1 Supported network protocols

Network type	Supported protocols
TCP/IP IPv4 and IPv6 networks	<ul style="list-style-type: none"> • Apple Bonjour • Simple Network Management Protocol (SNMP) v1, v2, and v3 • Hyper Text Transfer Protocol (HTTP) • Secure HTTP (HTTPS) • File Transfer Protocol (FTP) • Port 9100 • Line printer daemon (LPD) • Internet Printing Protocol (IPP) • Secure IPP • Web Services Dynamic Discovery (WS Discovery) • IPsec/Firewall
TCP/IP IPv4 networks only	<ul style="list-style-type: none"> • Auto IP • Service Location Protocol (SLP) • Trivial File Transfer Protocol (TFTP) • Telnet • Internet Group Management Protocol (IGMP) v2 • Bootstrap Protocol (BOOTP)/DHCP • Windows Internet Name Service (WINS) • IP Direct Mode • WS Print

Table 5-1 Supported network protocols (continued)

Network type	Supported protocols
TCP/IP IPv6 networks only	<ul style="list-style-type: none">• Dynamic Host Configuration Protocol (DHCP) v6• Multicast Listener Discovery Protocol (MLD) v1• Internet Control Message Protocol (ICMP) v6
Other supported network protocols	<ul style="list-style-type: none">• AppleTalk• iPrint

Table 5-2 Advanced Security features for network management

Service name	Description
IPsec/Firewall	Provides network-layer security on IPv4 and IPv6 networks. A firewall provides simple control of IP traffic. IPsec provides additional protection through authentication and encryption protocols.
Kerberos	Allows you to exchange private information across an open network by assigning a unique key, called a ticket, to each user who logs on to the network. The ticket is then embedded in messages to identify the sender.
SNMP v3	Employs a user-based security model for SNMP v3, which provides user authentication and data privacy through encryption.
SSL/TLS	Allows you to transmit private documents via the Internet and guarantee privacy and data integrity between the client and server applications.
IPsec batch configuration	Provides network-layer security through the simple control of IP traffic to and from the product. This protocol provides the benefits of encryption and authentication and allows for multiple configurations.

Install the product on a wired network

Configure the IP address

1. Make sure the product is turned on and that the **Ready** message appears on the control-panel display.

2. Connect the network cable to the product and to the network.

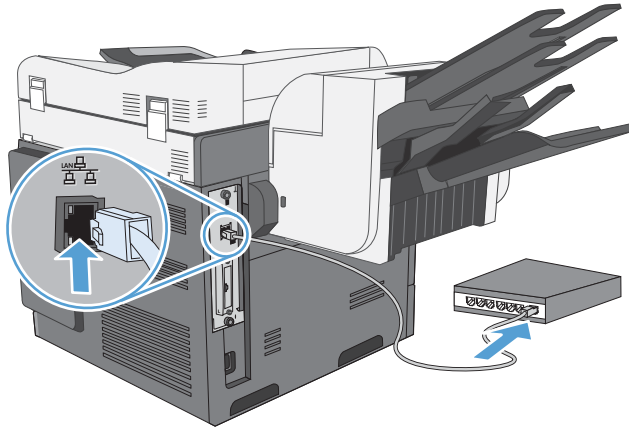

3. Wait for 60 seconds before continuing. During this time, the network recognizes the product and assigns an IP address or host name for the product.
4. At the product control panel, touch the [Network Address](#) button to identify the product IP address or host name.

If the [Network Address](#) button is not visible, you can find the IP address or host name by printing a configuration page.

- a. At the product control panel, scroll to and touch the [Administration](#) button.
- b. Open the following menus:
 - [Reports](#)
 - [Configuration/Status Pages](#)
 - [Configuration Page](#)
- c. Touch the [View](#) button to view the information on the control panel, or touch the [Print](#) button to print the pages.

- d. Find the IP address on the Jetdirect page.

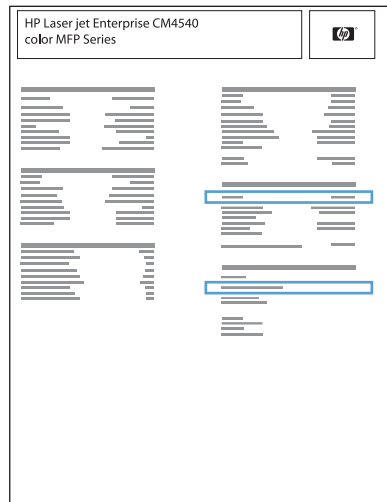

5. **IPv4:** If the IP address is 0.0.0.0, or 192.0.0.192, or 169.254.x.x, you must manually configure the IP address. Otherwise, the network configuration was successful.
IPv6: If the IP address begins with "fe80:", the product should be able to print. If not, you must manually configure the IP address.

Install the software

1. Quit all programs on the computer.
2. Install the software from the CD.
3. Follow the onscreen instructions.
4. When prompted, select the **Connect through a wired network** option.
5. From the list of available printers, select the printer that has the correct IP address.
6. At the end of the installation, click the **Finish** button, or click the **More Options** button to install more software or configure basic digital sending features for the product.
 - Install the HP PC Send Fax driver to enable sending faxes from your computer. (Fax models only)
 - Use the HP Scan to Email Setup Wizard to configure basic E-mail settings.
 - Use the HP Save to Folder Setup Wizard to set up a shared folder on the network where you can store scanned documents.
7. Print a page from any program to make sure that the software is correctly installed.

Configure network settings

View or change network settings

Use the embedded Web server to view or change IP configuration settings.

1. Print a configuration page, and locate the IP address.
 - If you are using IPv4, the IP address contains only digits. It has this format:
`xxx . xxx . xxx . xxx`
 - If you are using IPv6, the IP address is a hexadecimal combination of characters and digits. It has a format similar to this:
`xxxx : : xxxx : xxxx : xxxx : xxxx`
2. To open the embedded Web server, type the IP address into the address line of a Web browser.
3. Click the **Networking** tab to obtain network information. You can change settings as needed.

Set or change the network password

Use the embedded Web server to set a network password or change an existing password.

1. Open the embedded Web server, click the **Networking** tab, and click the **Security** link.

 **NOTE:** If a password has previously been set, you are prompted to type the password. Type the password, and then click the **Apply** button.

2. Type the new password in the **New Password** box and in the **Verify password** box.
3. At the bottom of the window, click the **Apply** button to save the password.

Manually configure IPv4 TCP/IP parameters from the control panel

Use the control-panel [Administration](#) menus to manually set an IPv4 address, subnet mask, and default gateway.

1. From the Home screen, scroll to and touch the [Administration](#) button.
2. Open each of the following menus:
 - a. [Network Settings](#)
 - b. [Embedded Jetdirect Menu](#)
 - c. [TCP/IP](#)
 - d. [IPV4 Settings](#)
 - e. [Config Method](#)
 - f. [Manual](#)
 - g. [Manual Settings](#)
 - h. [IP Address, Subnet Mask, or Default Gateway](#)
3. Use the keypad to specify the IP address, subnet mask, or default gateway.

Manually configure IPv6 TCP/IP parameters from the control panel

Use the control-panel [Administration](#) menus to manually set an IPv6 address.

1. From the Home screen, scroll to and touch the [Administration](#) button.
2. To enable manual configuration, open each of the following menus:
 - a. [Network Settings](#)
 - b. [Embedded Jetdirect Menu](#)
 - c. [TCP/IP](#)
 - d. [IPV6 Settings](#)
 - e. [Address](#)
 - f. [Manual Settings](#)
 - g. [Enable](#)

Select the [On](#) option, and then touch the [Save](#) button.

3. To configure the address, open each of the following menus:
 - [Network Settings](#)
 - [Embedded Jetdirect Menu](#)
 - [TCP/IP](#)
 - [IPV6 Settings](#)
 - [Address](#)

Use the keypad to enter the address.

 **NOTE:** If you are using the arrow buttons, you must press the [OK](#) button after entering each digit.

6 Paper and print media

- [Understand paper use](#)
- [Change the printer driver to match the paper type and size in Windows](#)
- [Supported paper sizes](#)
- [Supported paper types](#)
- [Load paper trays](#)
- [Configure trays](#)
- [Select an output bin \(fskm models only\)](#)

Understand paper use

This product supports a variety of paper and other print media in accordance with the guidelines in this user guide. Paper or print media that does not meet these guidelines might cause poor print quality, increased jams, and premature wear on the product.

For best results, use only HP-brand paper and print media designed for laser printers or multiuse. Do not use paper or print media made for inkjet printers. Hewlett-Packard Company cannot recommend the use of other brands of media because HP cannot control their quality.

It is possible for paper to meet all of the guidelines in this user guide and still not produce satisfactory results. This might be the result of improper handling, unacceptable temperature and/or humidity levels, or other variables over which Hewlett-Packard has no control.

- △ **CAUTION:** Using paper or print media that does not meet Hewlett-Packard's specifications might cause problems for the product, requiring repair. This repair is not covered by the Hewlett-Packard warranty or service agreements.

Special paper guidelines

This product supports printing on special media. Use the following guidelines to obtain satisfactory results. When using special paper or print media, be sure to set the type and size in the printer driver to obtain the best results.

- △ **CAUTION:** HP LaserJet products use fusers to bond dry toner particles to the paper in very precise dots. HP laser paper is designed to withstand this extreme heat. Using inkjet paper could damage the product.

Media type	Do	Do not
Envelopes	<ul style="list-style-type: none">• Store envelopes flat.• Use envelopes where the seam extends all the way to the corner of the envelope.• Use peel-off adhesive strips that are approved for use in laser printers.	<ul style="list-style-type: none">• Do not use envelopes that are wrinkled, nicked, stuck together, or otherwise damaged.• Do not use envelopes that have clasps, snaps, windows, or coated linings.• Do not use self-stick adhesives or other synthetic materials.
Labels	<ul style="list-style-type: none">• Use only labels that have no exposed backing between them.• Use labels that lie flat.• Use only full sheets of labels.	<ul style="list-style-type: none">• Do not use labels that have wrinkles or bubbles, or are damaged.• Do not print partial sheets of labels.
Transparencies	<ul style="list-style-type: none">• Use only transparencies that are approved for use in color laser printers.• Place transparencies on a flat surface after removing them from the product.	<ul style="list-style-type: none">• Do not use transparent print media not approved for laser printers.

Media type	Do	Do not
Letterhead or preprinted forms	<ul style="list-style-type: none"> • Use only letterhead or forms approved for use in laser printers. 	<ul style="list-style-type: none"> • Do not use raised or metallic letterhead.
Heavy paper	<ul style="list-style-type: none"> • Use only heavy paper that is approved for use in laser printers and meets the weight specifications for this product. 	<ul style="list-style-type: none"> • Do not use paper that is heavier than the recommended media specification for this product unless it is HP paper that has been approved for use in this product.
Glossy or coated paper	<ul style="list-style-type: none"> • Use only glossy or coated paper that is approved for use in laser printers. 	<ul style="list-style-type: none"> • Do not use glossy or coated paper designed for use in inkjet products.

Change the printer driver to match the paper type and size in Windows

1. On the **File** menu in the software program, click **Print**.
2. Select the product, and then click the **Properties** or **Preferences** button.
3. Click the **Paper/Quality** tab.
4. Select a size from the **Paper size** drop-down list.
5. Select a paper type from the **Paper type** drop-down list.
6. Click the **OK** button.

Supported paper sizes

 **NOTE:** To obtain best results, select the correct paper size and type in the printer driver before printing.

Table 6-1 Supported paper and print media sizes

Size and dimensions	Tray 1	Tray 2	Optional Trays 3, 4, and 5	Automatic duplex printing
Letter 216 x 279 mm (8.5 x 11 in)	✓	✓	✓	✓
Legal 216 x 356 mm (8.5 x 14 in)	✓	✓	✓	✓
Executive 184 x 267 mm (7.24 x 10.51 in)	✓	✓	✓	✓
Statement 140 x 216 mm (5.5 x 8.5 in)	✓			
8.5 x 13 216 x 330 mm (8.5 x 13 in)	✓	✓	✓	✓
4 x 6 101.6 x 152.4 mm (4 x 6 in)	✓			
10 x 15 cm 101.6 x 152.4 mm (4 x 6 in)	✓			
5 x 7 127 x 188 mm (5 x 7 in)	✓			
5 x 8 127 x 203 mm (5 x 8 in)	✓			
A4 210 x 297 mm (8.27 x 11.69 in)	✓	✓	✓	✓
RA4 215 x 305 mm (8.46 x 12.01 in)	✓	✓	✓	✓
A5 148 x 210 mm (5.83 x 8.27 in)	✓	✓	✓	✓
A6 105 x 148 mm (4.13 x 5.82 in)	✓			

Table 6-1 Supported paper and print media sizes (continued)

Size and dimensions	Tray 1	Tray 2	Optional Trays 3, 4, and 5	Automatic duplex printing
B5 (JIS) 182 x 257 mm (7.17 x 10.12 in)	✓	✓	✓	✓
B6 (JIS) 128 x 182 mm (5.03 x 7.16 in)	✓			
16K 195 x 270 mm (7.67 x 10.62 in) 184 x 260 mm (7.24 x 10.23 in) 197 x 273 mm (7.75 x 10.74 in)	✓	✓	✓	✓
Postcard (JIS) 100 x 148 mm (3.93 x 5.82 in)	✓			
DPostcard (JIS) 148 x 200 mm (5.82 x 7.87 in)	✓			
Custom 89 x 127 mm to 216 x 356 mm (3.5 x 5 in to 8.5 x 14 in)	✓ ¹			
Custom 148 x 210 mm to 216 x 356 mm (5.83 x 8.27 in to 8.5 x 14 in)		✓	✓	
Envelope #9 98 x 225 mm (3.85 x 8.85 in)	✓			
Envelope #10 105 x 241 mm (4.13 x 9.48 in)	✓			
Envelope Monarch 98 x 191 mm (3.9 x 7.5 in)	✓			
Envelope B5 176 x 250 mm (6.92 x 9.84 in)	✓			
Envelope C5 162 x 229 mm (6.37 x 9.01 in)	✓			
Envelope C6 162 x 114 mm (6.37 x 4.48 in)	✓			

Table 6-1 Supported paper and print media sizes (continued)

Size and dimensions	Tray 1	Tray 2	Optional Trays 3, 4, and 5	Automatic duplex printing
Envelope DL ISO 110 x 220 mm (4.33 x 8.66 in)	✓			

¹ The product can print on 89 x 127 mm (3.5 x 5 in) size paper from Tray 1 for Extra Heavy (131-175 g/m²) and Cardstock (176-220 g/m²) paper types.

Supported paper types

Paper type	Tray 1	Tray 2	Optional Trays 3, 4, and 5	Automatic duplex printing
Plain Paper	✓	✓	✓	✓
HP Matte (105 g/m ²)	✓	✓	✓	✓
HP Matte (120 g/m ²)	✓	✓	✓	✓
HP Matte (160 g/m ²)	✓	✓ ¹	✓ ¹	✓ ²
HP Matte (200 g/m ²)	✓	✓ ¹	✓ ¹	
HP Soft Gloss (120 g/m ²)	✓	✓	✓	✓
HP Glossy (130 g/m ²)	✓	✓	✓	✓
HP Glossy (160 g/m ²)	✓	✓	✓	✓
HP Glossy (220 g/m ²)	✓	✓	✓	✓
Light (60–74 g/m ²)	✓	✓	✓	✓
Midweight (96–110 g/m ²)	✓	✓	✓	✓
Heavy (111–130 g/m ²)	✓	✓	✓	✓
Extra Heavy (131–175 g/m ²)	✓	✓ ¹	✓ ¹	✓ ²
Cardstock (176–220 gm ²)	✓	✓ ¹	✓ ¹	
Mid-weight glossy (96–110 g/m ²)	✓	✓	✓	✓
Heavy glossy (111–130 g/m ²)	✓	✓	✓	✓
Extra-heavy glossy (131–175 g/m ²)	✓	✓	✓	✓
Card glossy (176–220 g/m ²)	✓	✓	✓	✓
Color Transparency	✓	✓	✓	
Labels	✓	✓ ¹	✓ ¹	
Letterhead	✓	✓	✓	✓
Envelope	✓			
Preprinted	✓	✓	✓	✓
Prepunched	✓	✓	✓	✓
Colored	✓	✓	✓	✓
Bond	✓	✓	✓	✓
Recycled	✓	✓	✓	✓
Rough	✓	✓	✓	✓
HP Tough Paper	✓	✓	✓	✓

Paper type	Tray 1	Tray 2	Optional Trays 3, 4, and 5	Automatic duplex printing
Opaque film	✓	✓	✓	✓

¹ Trays 2, 3, 4, and 5 can print on this paper in some circumstances, but HP does not guarantee results.

² The product can automatically print on both sides for this paper type in some circumstances, but HP does not guarantee results.

Load paper trays

Load Tray 1

△ **CAUTION:** To avoid jams, never add or remove paper from Tray 1 during printing.

1. Open Tray 1.

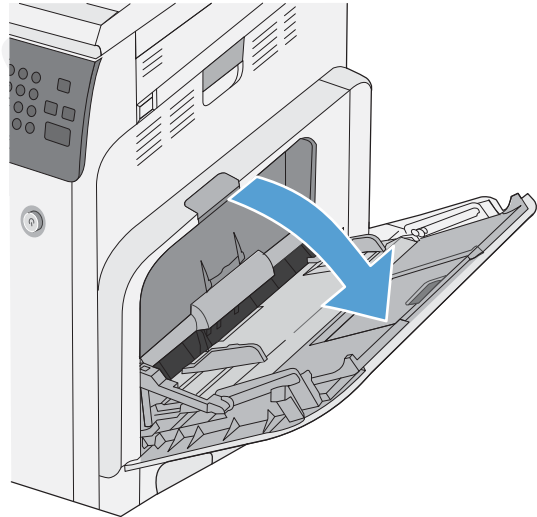

2. Fold out the tray extension to support the paper and set the side guides to the correct width.

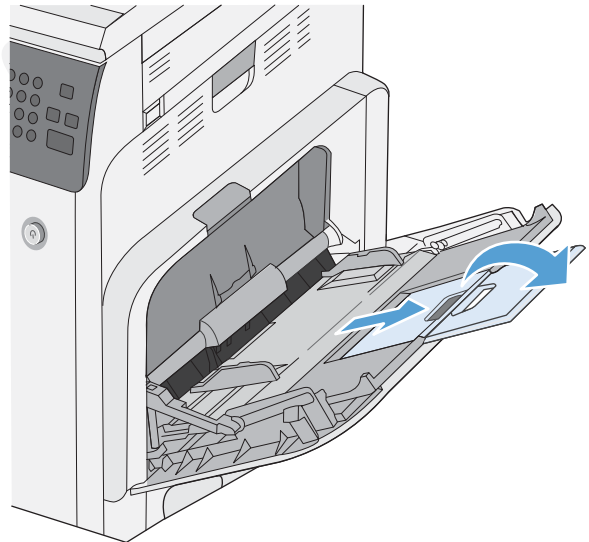

3. Load paper in the tray.

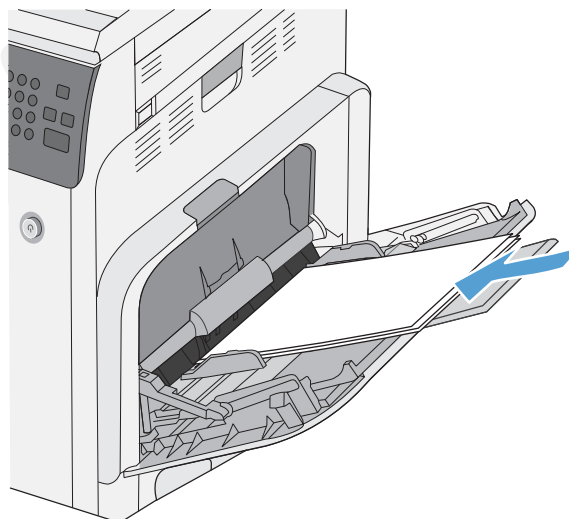

4. Make sure the stack fits under the tabs on the guides and does not exceed the load-level indicators.

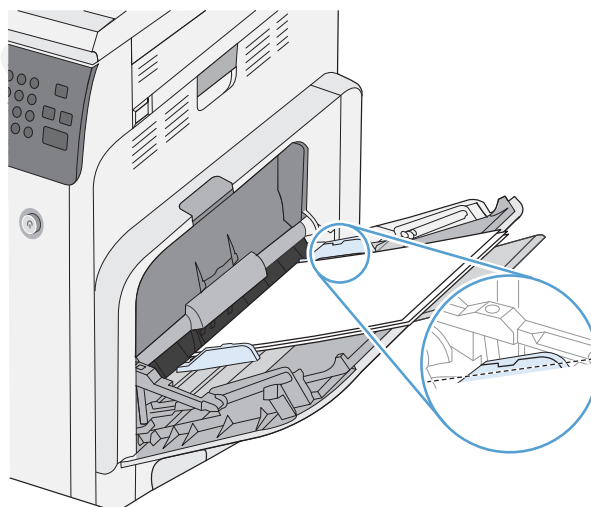

5. Adjust the side guides so that they lightly touch the paper stack but do not bend it.

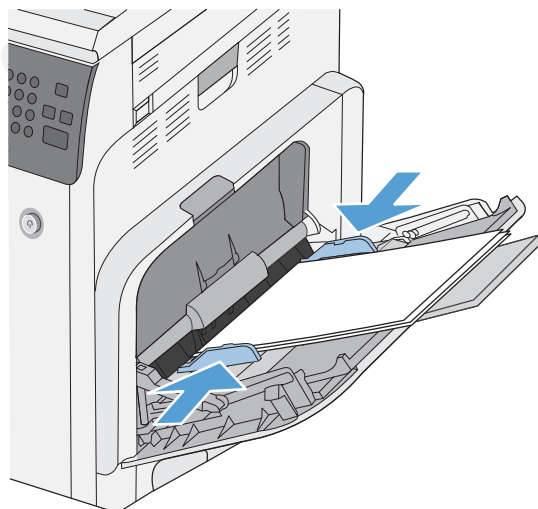

Load Tray 2 and optional Trays 3, 4, and 5 with standard-size paper

1. Open the tray.

NOTE: Do not open the tray while it is in use.

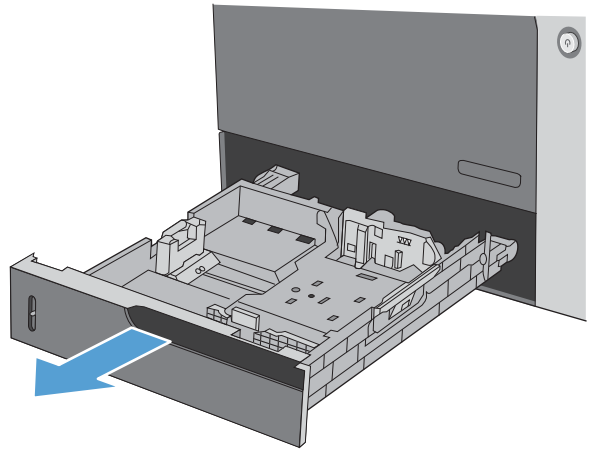

2. Adjust the paper-length and paper-width guides by squeezing the adjustment latches and sliding the guides to the size of the paper being used.

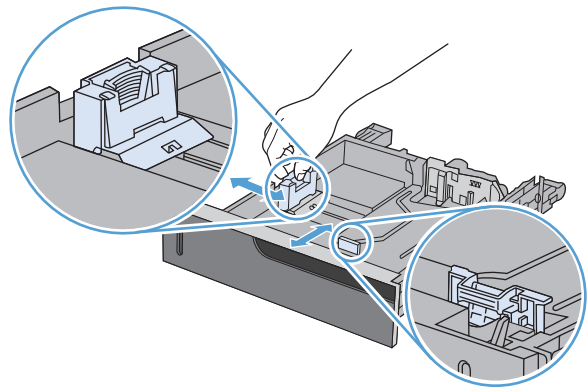

3. Load paper into the tray. Check the paper to verify the guides lightly touch the stack, but do not bend it.

NOTE: To prevent jams, do not overfill the tray. Be sure the top of the stack is below the tray full indicator.

NOTE: If the tray is not adjusted correctly, an error message might appear during printing or the paper might jam.

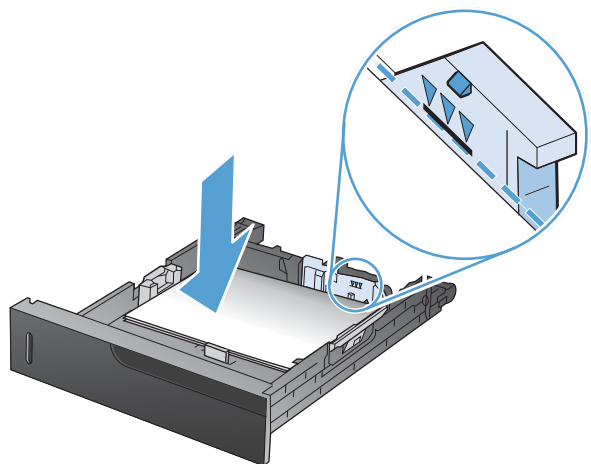

4. Close the tray.

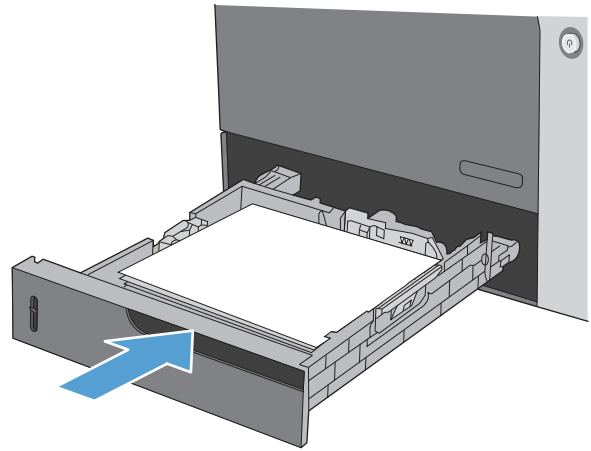

5. The control panel shows the tray's paper type and size. If the configuration is not correct, follow the instructions on the control panel to change the size or type.



Load Tray 2 and optional Trays 3, 4, and 5 with custom-size paper

1. Open the tray.

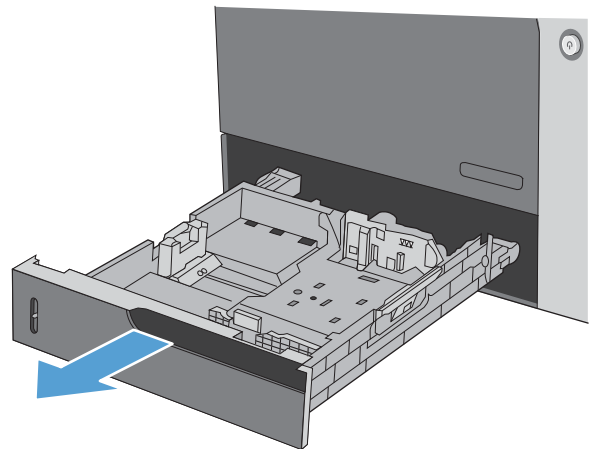

2. Adjust the paper-length and paper-width guides by squeezing the adjustment latches and sliding the guides to the size of the paper being used.

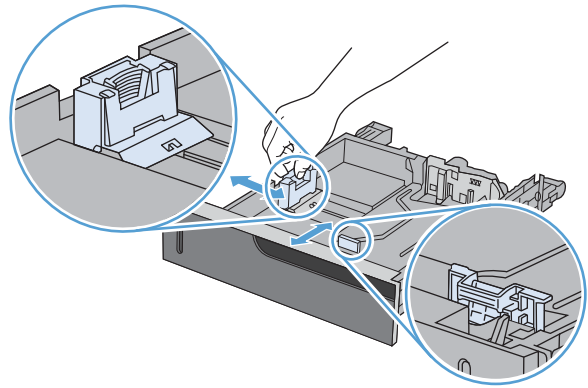

3. Load paper into the tray. Check the paper to verify the guides lightly touch the stack, but do not bend it.

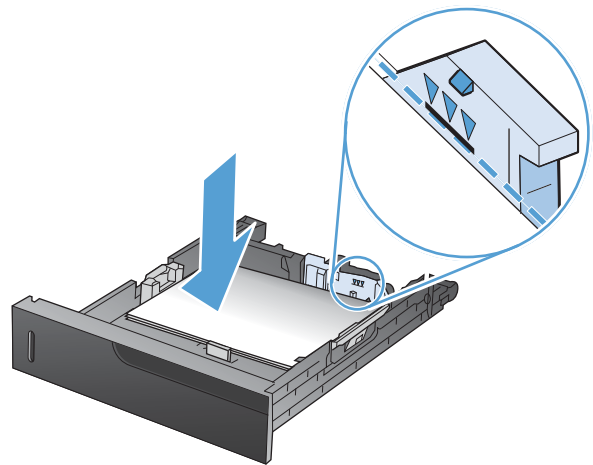

4. Close the tray.

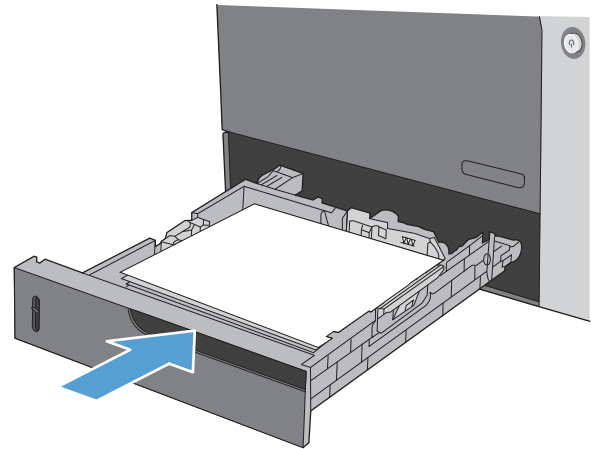

5. The control panel prompts you to set the paper size and type. Select the **Custom** setting, and then configure the X and Y dimensions of the custom paper size.

NOTE: See the label in the paper tray, or the following illustration, to determine the X and Y dimensions.

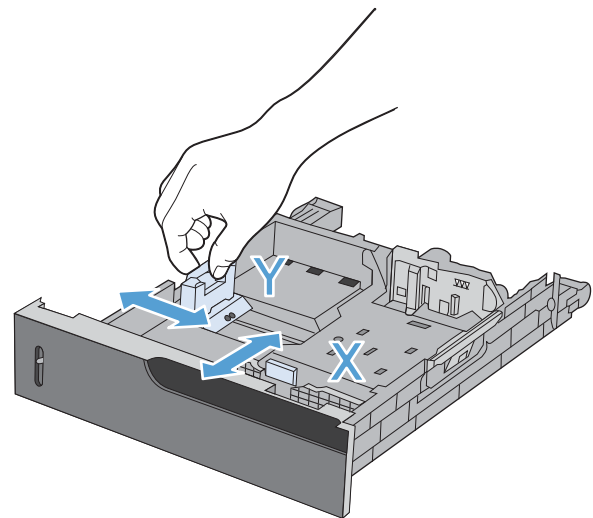

Tray and bin capacity

Tray or bin	Paper type	Specifications	Quantity
Tray 1	Paper	Range: 60 g/m ² (16 lb) bond to 216 g/m ² (58 lb) bond	Maximum stack height: 10 mm (0.39 in) Equivalent to 100 sheets of 75 g/m ² (20 lb) bond
	Envelopes	Less than 60 g/m ² (16 lb) bond to 90 g/m ² (24 lb) bond	Up to 10 envelopes
	Labels	Maximum 0.102 mm (0.004 in) thick	Maximum stack height: 10 mm (0.39 in)
	Transparencies	Minimum 0.102 mm (0.004 in) thick	Maximum stack height: 10 mm (0.39 in) Up to 50 sheets
	Glossy paper	Range: 105 g/m ² (28 lb) bond to 220 g/m ² (58 lb) bond	Maximum stack height: 10 mm (0.39 in) Up to 50 sheets
Tray 2	Paper	Range: 60 g/m ² (16 lb) bond to 220 g/m ² (59 lb) bond	Maximum stack height: 56 mm (2.2 in) Equivalent to 500 sheets of 75 g/m ² (20 lb) bond
	Transparencies	Minimum 0.102 mm (0.004 in) thick	Maximum stack height: 56 mm (2.2 in)
	Glossy paper	Range: 105 g/m ² (28 lb) bond to 220 g/m ² (58 lb) bond	Maximum stack height: 56 mm (2.2 in)
Optional Trays 3, 4, and 5	Paper	Range: 60 g/m ² (16 lb) bond to 220 g/m ² (59 lb) bond	Maximum stack height: 56 mm (2.2 in) Equivalent to 500 sheets of 75 g/m ² (20 lb) bond
	Transparencies	Minimum 0.102 mm (0.004 in) thick	Maximum stack height: 56 mm (2.2 in)
	Glossy paper	Range: 105 g/m ² (28 lb) bond to 220 g/m ² (58 lb) bond	Maximum stack height: 56 mm (2.2 in)
Output bin	Paper		Up to 500 sheets of 75 g/m ² (20 lb) bond
Document feeder	Paper	Range: 60 g/m ² (16 lb) bond to 220 g/m ² (59 lb) bond	Up to 50 sheets of 75 g/m ² (20 lb) bond

 **NOTE:** Trays 2, 3, 4, and 5 can print on bond paper heavier than 220 g/m² (59 lb) in some circumstances, but HP does not guarantee results.

Paper orientation for loading trays

If you are using paper that requires a specific orientation, load it according to the information in the following tables.

NOTE: The [Alternative Letterhead Mode](#) and [Image Rotation](#) settings affect the way you load letterhead or preprinted paper. The following information depicts the default setting.

Paper orientation for loading Tray 1

Paper type	Image orientation	Duplex mode	How to load paper
Preprinted or letterhead	Portrait	1-sided printing	Face down Bottom edge leading into the product
		Automatic 2-sided printing	Face up Bottom edge leading into the product
	Landscape	1-sided printing	Face down Top edge toward the back of the product
		Automatic 2-sided printing	Face up Top edge toward the back of the product

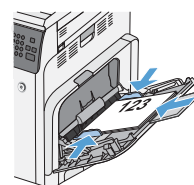
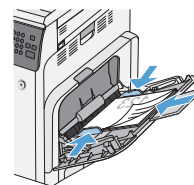
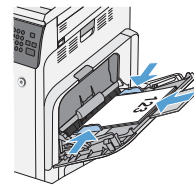
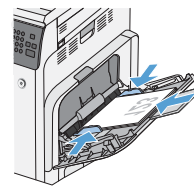

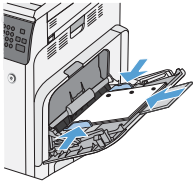
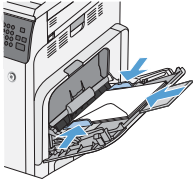
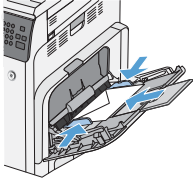
Paper type	Image orientation	Duplex mode	How to load paper
Prepunched	Portrait or landscape	1- or 2-sided printing	Holes toward the back of the product 
Envelopes	Landscape Short edge of the envelope feeding into the product	1-sided printing	Face down Top edge toward the front of the product 
	Portrait Long edge of the envelope feeding into the product	1-sided printing	Face down Top edge leading into the product 

Paper orientation for loading Tray 2 or Trays 3, 4, and 5

Paper type	Image orientation	Duplex mode	How to load paper
Preprinted or letterhead	Portrait	1-sided printing	Face up Top edge at the left side of the tray
		Automatic 2-sided printing	Face down Top edge at the left side of the tray
	Landscape	1-sided printing	Face up Top edge toward the back of the product
		Automatic 2-sided printing	Face down Top edge toward the back of the product
Prepunched	Portrait or landscape	1- or 2-sided printing	Holes toward the back of the product

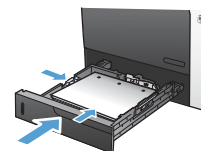
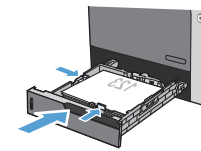
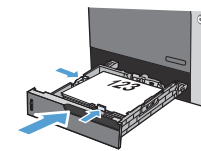
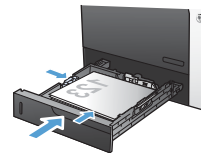
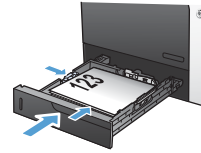

Configure trays

The product automatically prompts you to configure a tray for type and size in the following situations:

- When you load paper into the tray
- When you specify a particular tray or paper type for a print job through the printer driver or a software program and the tray is not configured to match the print-job's settings

 **NOTE:** The prompt does not appear if you are printing from Tray 1, and it is configured for the [Any Size](#) paper size and the [Any Type](#) paper type settings. In this situation, if the print job does not specify a tray, the product prints from Tray 1, even if the paper size and type settings in the print job do not match the paper loaded in Tray 1.

Configure a tray when loading paper

1. Load paper in the tray. Close the tray if you are using Tray 2, 3, 4, or 5.
2. The tray configuration message appears.
3. Touch the **OK** button to accept the detected size and type, or touch the **Modify** button to choose a different paper size or type.
4. Select the correct size and type and then touch the **OK** button.

Configure a tray to match print job settings

1. In the software program, specify the source tray, the paper size, and the paper type.
2. Send the job to the product.
If the tray needs to be configured, the tray configuration message appears.
3. Load the tray with the specified type and size of paper, and then close the tray.
4. Touch the **OK** button to accept the detected size and type, or touch the **Modify** button to choose a different paper size or type.
5. Select the correct size and type and then touch the **OK** button.

Configure a tray by using the control panel

You can also configure the trays for type and size without a prompt from the product.

1. From the Home screen, touch the **Trays** button.
2. Touch the line for the tray that you want to configure, and then touch the **Modify** button.
3. Select the paper size and paper type from the lists of options.
4. Touch the **OK** button to save your selection.

Automatic paper sensing (auto-sense mode)

The automatic paper type sensor functions when a tray is configured to the [Any Type](#) or plain type setting.

After it has picked up paper from the tray, the product can detect overhead transparencies, paper weight, and gloss level.

For more control, select a specific paper type in the job or configure the tray for a specific paper type.

Auto-sense settings

Full sensing (Tray 1 only)	For each sheet of paper that it picks up from the tray, the product detects light paper, plain paper, heavy paper, glossy paper, tough paper, and transparencies.
Expanded sensing NOTE: This is the default setting for all trays.	For the first few sheets of paper that it picks up from the tray, the product detects light paper, plain paper, heavy paper, glossy paper, tough paper, and transparencies. The product assumes the rest of the pages are of the same type.
Transparency only	The product distinguishes between transparencies and non-transparencies. This setting provides the fastest printing, but for some paper types it might reduce print quality.

Select an output bin (fskm models only)

You can configure the product to use different output bins for printing, copying, and faxing. You can also configure the product to sort jobs according to the username associated with each job, or to stack all jobs from the lower bin to the upper bin.

 **NOTE:** You can also select output bins from the printer driver. Selections that you make in the printer driver override control-panel settings.

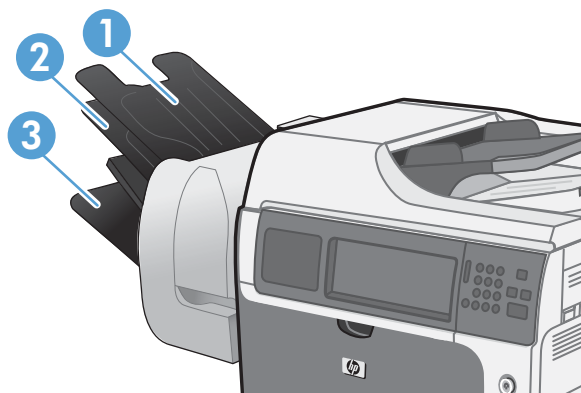

1	Upper-Left Bin
2	Middle-Left Bin
3	Lower-Left Bin

1. From the Home screen, scroll to and touch the [Administration](#) menu.
2. Open each of the following menus:
 - [Stapler/Stacker Settings](#)
 - [Operation Mode](#)
3. To configure the product to sort jobs into different bins according to product function, select the [Function Separator](#) option. Touch the [OK](#) button.

 **NOTE:** You can also select the [Mailbox](#) option to sort jobs according to the username associated with the job.

Select the [Stacker](#) option to stack all jobs into the lower output bin first. When the lower bin is full, jobs stack into the middle bin, and then into the upper bin.

4. To configure the bin for copy jobs, open these menus, and then select a bin from the list of options.

- [Administration](#)
- [Copy Settings](#)
- [Output Bin](#)

5. To configure the bin for printing incoming faxes, open these menus:

- [Administration](#)
- [Fax Settings](#)
- [Fax Receive Settings](#)
- [Default Job Options](#)
- [Output Bin](#)

Select a bin from the list of options.

 **NOTE:** All stapled jobs always go to the lower bin.

NOTE: For print jobs, select the output bin in the printer driver.

7 Manage supplies

- [Print cartridge information](#)
- [Supplies views](#)
- [Manage print cartridges](#)
- [Replacement instructions](#)
- [Solve problems with supplies](#)

Print cartridge information

Feature	Description
Part numbers	<ul style="list-style-type: none">• Standard-capacity black print cartridge: CE260A• High-capacity black print cartridge: CE264X• Cyan print cartridge: CF031A• Yellow print cartridge: CF032A• Magenta print cartridge: CF033A
Accessibility	<ul style="list-style-type: none">• The print cartridges can be installed and removed by using one hand.
Environmental features	<ul style="list-style-type: none">• Recycle print cartridges by using the HP Planet Partners return and recycling program.

For more information about supplies, go to www.hp.com/go/learnaboutsupplies.

Supplies views

Print cartridge views

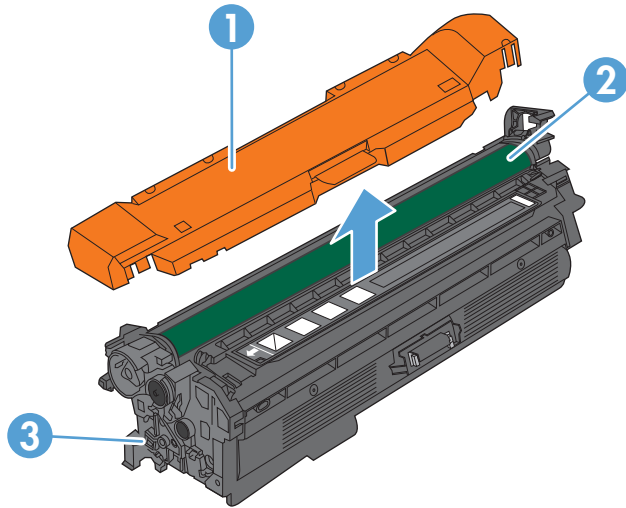

1	Plastic shield
2	Imaging drum
3	Print cartridge memory tag

Manage print cartridges

Correctly using, storing, and monitoring the print cartridge can help ensure high-quality print output.

Settings for print cartridges

Print when a print cartridge is at estimated end of life

- A **<Color> <Supply> Low** message—where **<Color>** is the color of the supply, and **<Supply>** is the type of supply—appears when a supply is nearing the estimated end of its useful life.
- A **<Color> <Supply> Very Low** message appears when a supply is at its estimated end of useful life.

Print-quality problems can occur when using a supply that is at its estimated end of life.

Enable or disable the Very Low Settings options from the control panel

You can enable or disable the default settings at any time, and you do not have to re-enable them when you install a new cartridge.

1. From the Home screen on the control panel, touch the [Administration](#) button.
2. Open the following menus:
 - [Manage Supplies](#)
 - [Supply Settings](#)
 - [Black Cartridge](#) or [Color Cartridges](#)
 - [Very Low Settings](#)
3. Select one of the following options:
 - Select the [Continue](#) option to set the product to alert you that the cartridge is very low, but to continue printing.

 **NOTE:** Using the [Continue](#) setting allows printing beyond Very Low without customer interaction and can result in unsatisfactory print quality.

 - Select the [Stop](#) option to set the product to stop printing (including printing faxes) until you replace the cartridge.
 - Select the [Prompt to continue](#) option to set the product to stop printing (including printing faxes) and prompt you to replace the cartridge. You can acknowledge the prompt and continue printing.

If you select the [Stop](#) or [Prompt to continue](#) option, the product stops printing when it reaches the Very Low threshold. When you replace the cartridge, the product automatically resumes printing.

When the product is set to the [Stop](#) or [Prompt to continue](#) option, there is some risk that faxes will not print when the product resumes printing. This can occur if the product has received more faxes than the memory can hold while the product is waiting.

The product can print faxes without interruption when it passes the Very Low threshold if you select the [Continue](#) option for color and black cartridges, but print quality might degrade.

Once an HP supply has reached Very Low, HP's premium Protection Warranty on that supply has ended.

Recycle supplies

To recycle a genuine HP print cartridge, place the used cartridge in the box in which the new cartridge arrived. Use the enclosed return label to send the used supply to HP for recycling. For complete information, see the recycling guide that is included with each new HP supply item.

Print-cartridge storage

Do not remove the print cartridge from its package until you are ready to use it.

△ **CAUTION:** To prevent damage to the print cartridge, do not expose it to light for more than a few minutes.

HP policy on non-HP print cartridges

Hewlett-Packard Company cannot recommend the use of non-HP print cartridges, either new or remanufactured.

📄 **NOTE:** Any damage caused by a non-HP print cartridge is not covered under the HP warranty and service agreements.

HP fraud hotline and Web site

Call the HP fraud hotline (1-877-219-3183, toll-free in North America) or go to www.hp.com/go/anticounterfeit when you install an HP print cartridge and the control-panel message says the cartridge is non-HP. HP will help determine if the cartridge is genuine and take steps to resolve the problem.

Your print cartridge might not be a genuine HP print cartridge if you notice the following:

- The supplies status page indicates that a non-HP supply is installed.
- You are experiencing a high number of problems with the print cartridge.
- The cartridge does not look like it usually does (for example, the packaging differs from HP packaging).

Replacement instructions

Replace print cartridges

The product uses four colors and has a different print cartridge for each color: black (K), magenta (M), cyan (C), and yellow (Y).

△ **CAUTION:** If toner gets on clothing, wipe it off with a dry cloth and wash the clothes in cold water. Hot water sets toner into fabric.

📄 **NOTE:** Information about recycling used print cartridges is on the print-cartridge box.

1. Open the front door. Make sure that the door is completely open.

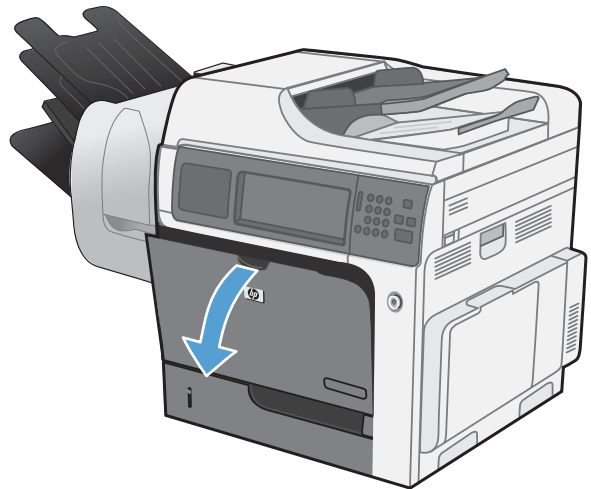

2. Grasp the handle of the used print cartridge and pull out to remove.

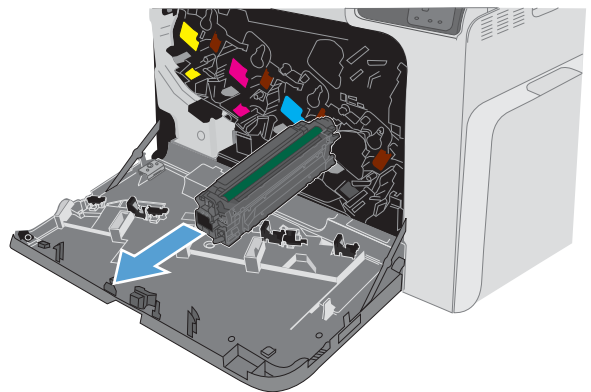

3. Store the used print cartridge in a protective bag. Information about recycling used print cartridges is on the print-cartridge box.

4. Remove the new print cartridge from its protective bag.

NOTE: Be careful not to damage the memory tag on the print cartridge.

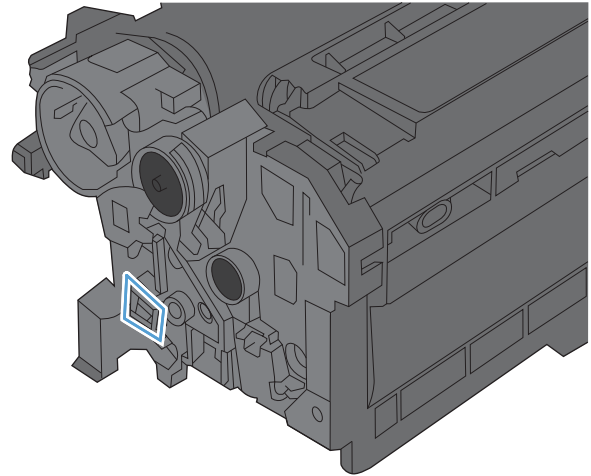

5. Grasp both sides of the print cartridge and distribute the toner by gently rocking the print cartridge.

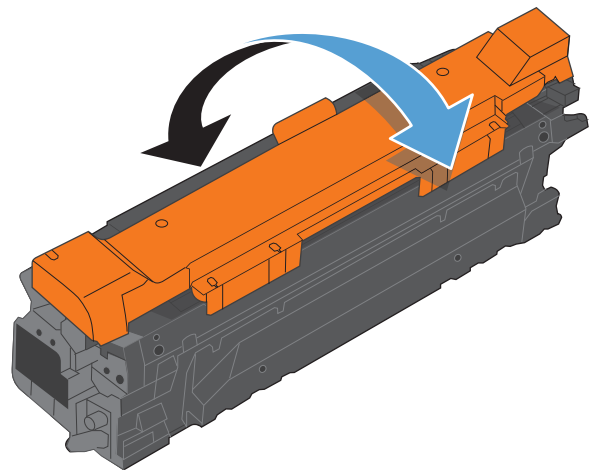

6. Remove the orange protective cover from the print cartridge.

CAUTION: Avoid prolonged exposure to light.

CAUTION: Do not touch the green roller. Doing so can damage the cartridge.

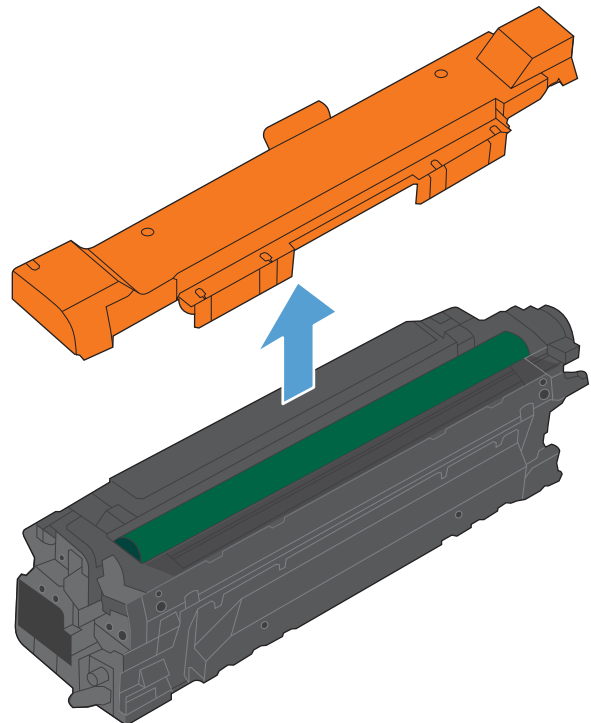

7. Align the print cartridge with its slot and insert the print cartridge until it clicks into place.

NOTE: The print cartridges go in at a slight angle.

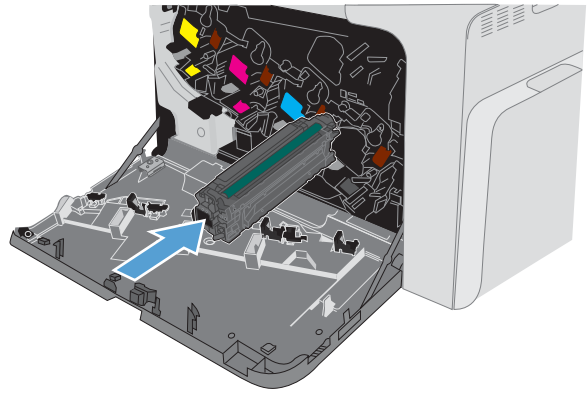

8. Close the front door.

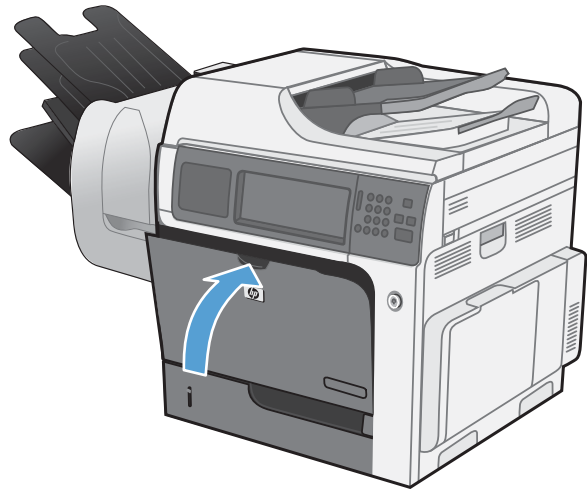

Replace the toner collection unit

Replace the toner collection unit when the control panel prompts you.

 **NOTE:** The toner collection unit is designed for a single use. Do not attempt to empty the toner collection unit and reuse it. Doing so could lead to toner being spilled inside the product, which could result in reduced print quality. After use, return the toner collection unit to HP's Planet Partners program for recycling.

1. Open the front door. Make sure that the door is completely open.

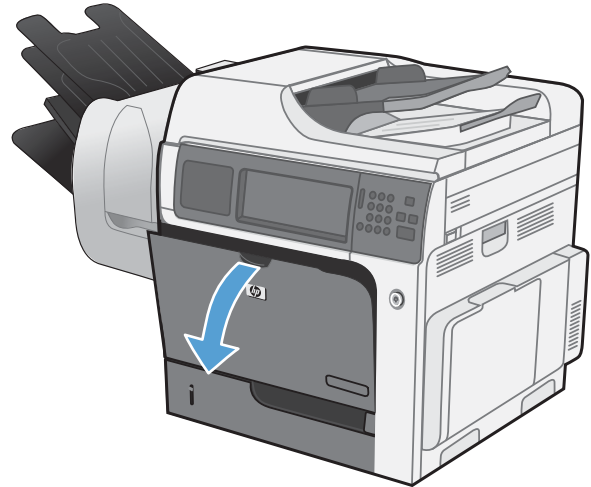

2. Grasp the top of the toner collection unit and remove it from the product.

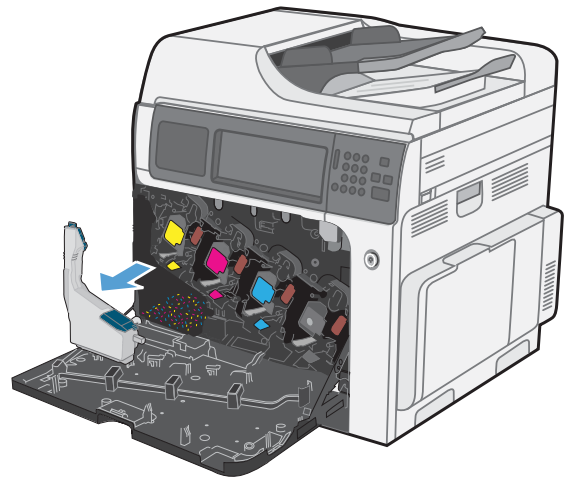

3. Place the attached cap over the opening at the top of the unit.

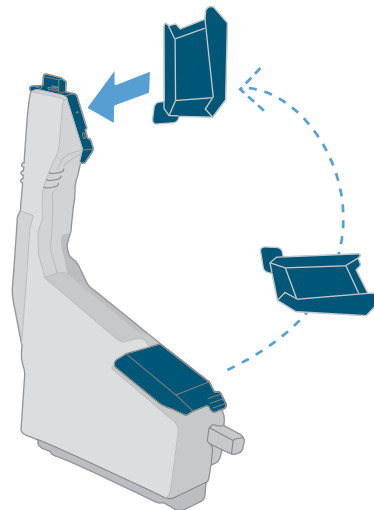

4. Remove the new toner collection unit from its packaging.

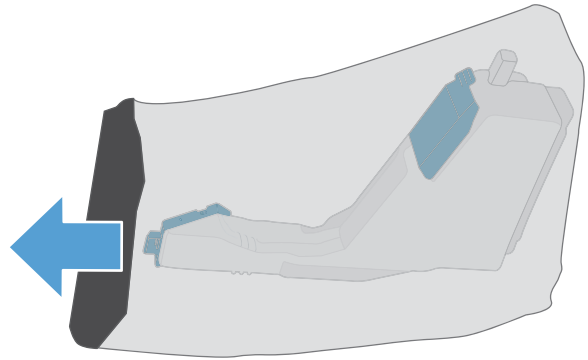

5. Insert the bottom of the new unit into the product first and then push the top of the unit until it clicks into place.

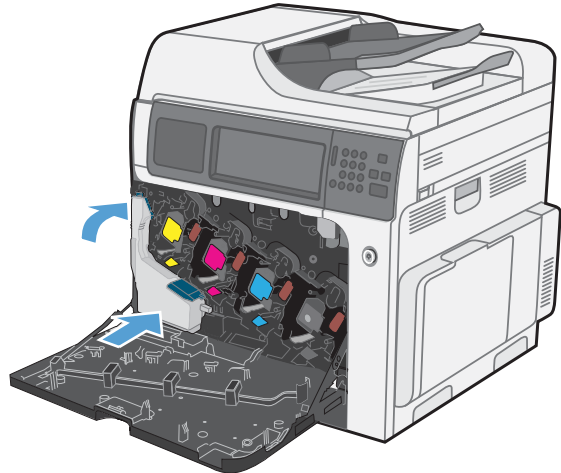

6. Close the front door.

NOTE: If the toner collection unit is not installed correctly, the front door does not close completely.

To recycle the used toner collection unit, follow the instructions included with the new toner collection unit.

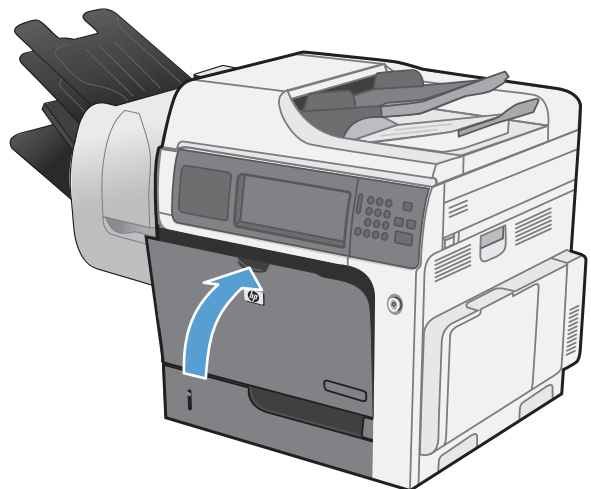

Replace the staple cartridge

1. Lift the gray latch on the front of the stapler, and open the stapler cover.

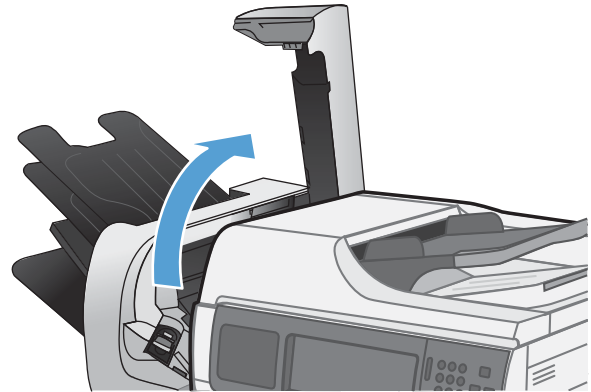

2. Lift the green tab on the staple cartridge up, and then pull the staple cartridge straight out.

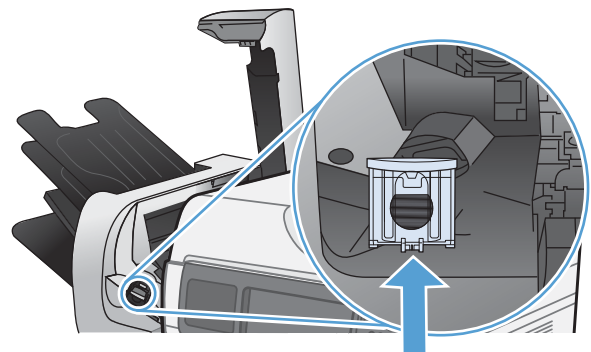

3. Insert the new staple cartridge into the stapler and push down on the green handle until it snaps into place.

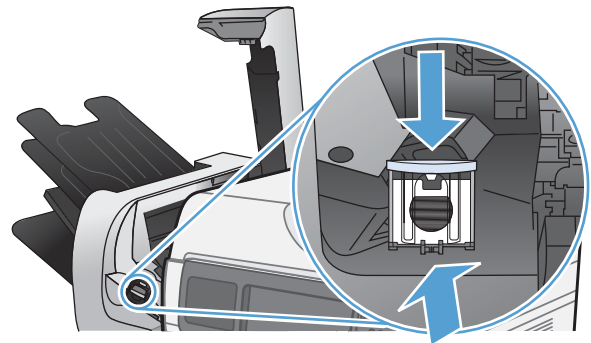

4. Close the stapler cover.

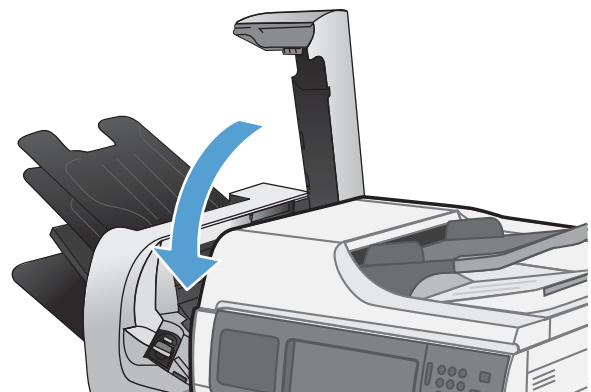

Solve problems with supplies

Check the print cartridges

Check the print cartridge, and replace it if necessary, if you are having any of the following problems:

- The printing is too light or seems faded in areas.
- Printed pages have small unprinted areas.
- Printed pages have streaks or bands.

 **NOTE:** If you are using a draft or EconoMode print setting, the printing might appear light.

If you determine that you need to replace a print cartridge, print the supplies status page to find the part number for the correct genuine HP print cartridge.

Type of print cartridge	Steps to resolve the problem
Refilled or remanufactured print cartridge	Hewlett-Packard Company cannot recommend the use of non-HP supplies, either new or remanufactured. Because they are not HP products, HP cannot influence their design or control their quality. If you are using a refilled or remanufactured print cartridge and are not satisfied with the print quality, replace the cartridge with a genuine HP cartridge that has the words "HP" or "Hewlett-Packard" on it, or has the HP logo on it.
Genuine HP print cartridge	<ol style="list-style-type: none">1. The product control panel or the supplies status page indicates Very Low status when the cartridge has reached the end of its designated life. Replace the print cartridge if print quality is no longer acceptable.2. Visually inspect the print cartridge for damage. See the instructions that follow. Replace the print cartridge if necessary.3. If printed pages have marks that repeat several times at the same distance apart, print a cleaning page. If this does not solve the problem, use the repeating defects information in this document to identify the cause of the problem.

Inspect the print cartridge for damage

1. Remove the print cartridge from the product, and verify that the sealing tape has been removed.
2. Check the memory chip for damage.
3. Examine the surface of the green imaging drum on the bottom of the print cartridge.

△ **CAUTION:** Do not touch the green roller (imaging drum) on the bottom of the cartridge. Fingerprints on the imaging drum can cause print-quality problems.

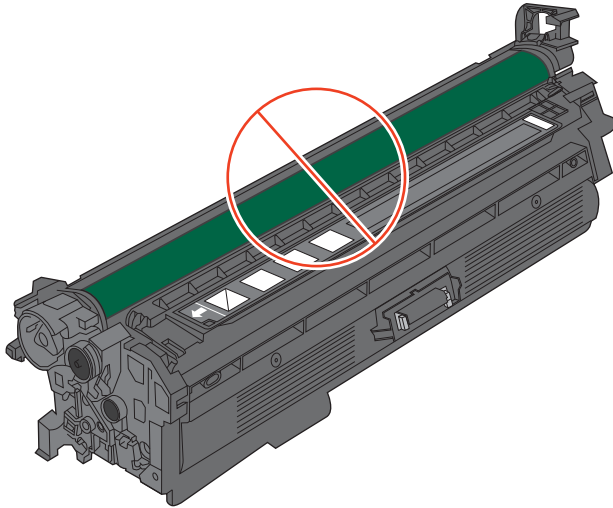

4. If you see any scratches, fingerprints, or other damage on the imaging drum, replace the print cartridge.
5. If the imaging drum does not appear to be damaged, rock the print cartridge gently several times and reinstall it. Print a few pages to see if the problem has resolved.

Repeating defects

If defects repeat at regular intervals on the page, use this ruler to identify the cause of the defect. Place the top of the ruler at the first defect. The marking that is beside the next occurrence of the defect indicates which component needs to be replaced.

Figure 7-1 Repetitive defects ruler

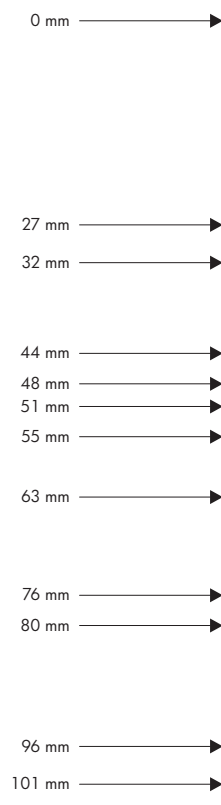

Distance between defects	Product components that cause the defect
27 mm	Print cartridge
32 mm	Print cartridge
44 mm	Transfer unit
48 mm	Print cartridge
51 mm	Transfer roller
55 mm	Print engine
63 mm	Transfer unit
76 mm	Print cartridge
76 mm	Fuser
80 mm	Fuser
96 mm	Print engine
101 mm	Print engine

Print the Supplies Status page

The [Supplies Status](#) page indicates the estimated life remaining in print cartridges. It also lists the part number for the correct genuine HP print cartridge for your product so you can order a replacement print cartridge, as well as other useful information.

1. Open the following menus:
 - [Administration](#)
 - [Reports](#)
 - [Configuration/Status Pages](#)
2. Select the [Supplies Status](#) option, and then touch the [Print](#) button to print the report.

Interpret control panel messages for supplies

The following table contains important information about supplies status messages.

Table 7-1 Supplies status messages

Control panel message	Description	Recommended action
10.XX.YY Supply memory error	<p>The product cannot read or write to at least one print cartridge memory chip or a memory chip is missing from a print cartridge.</p> <p>XX values</p> <ul style="list-style-type: none">• 00 = Memory chip memory error• 10 = Memory chip missing <p>YY values</p> <ul style="list-style-type: none">• 00 = Black• 01 = Cyan• 02 = Magenta• 03 = Yellow	Reinstall the print cartridge, or install a new print cartridge.
Black cartridge low	The product indicates when a supply level is low. Actual print cartridge life might vary. You do not need to replace the print cartridge at this time unless print quality is no longer acceptable.	If print quality is no longer acceptable, replace the print cartridge. Consider purchasing a replacement cartridge so it is available when the installed cartridge has reached the end of its estimated life.
Black cartridge very low	The product indicates when a supply level is very low. Actual print cartridge life might vary. You do not need to replace the print cartridge at this time unless print quality is no longer acceptable. After an HP supply has reached the very low threshold, the HP premium protection warranty for that supply has ended.	If print quality is no longer acceptable, replace the print cartridge. Consider purchasing a replacement cartridge so it is available when the installed cartridge has reached the end of its estimated life.
Cyan cartridge low	The product indicates when a supply level is low. Actual print cartridge life might vary. You do not need to replace the print cartridge at this time unless print quality is no longer acceptable.	If print quality is no longer acceptable, replace the print cartridge. Consider purchasing a replacement cartridge so it is available when the installed cartridge has reached the end of its estimated life.

Table 7-1 Supplies status messages (continued)

Control panel message	Description	Recommended action
Cyan cartridge very low	The product indicates when a supply level is very low. Actual print cartridge life might vary. Consider having a replacement print cartridge available to install when print quality is no longer acceptable. You do not need to replace the print cartridge at this time unless print quality is no longer acceptable. After an HP supply has reached the very low threshold, the HP premium protection warranty for that supply has ended.	If print quality is no longer acceptable, replace the print cartridge.
Fuser kit low	The fuser kit is low. The actual supply life remaining might vary. Consider having a replacement fuser kit available to install when print quality is no longer acceptable. You do not need to replace the fuser kit at this time unless print quality is no longer acceptable.	If print quality is no longer acceptable, replace the fuser kit. Instructions are included with the fuser kit.
Fuser kit very low	The fuser kit is very low. The actual supply life remaining might vary. You do not need to replace the fuser kit at this time unless print quality is no longer acceptable. After an HP supply has reached the very low threshold, the HP premium protection warranty for that supply has ended.	If print quality is no longer acceptable, replace the fuser kit. Instructions are included with the fuser kit.
Incompatible <color> cartridge	The indicated color print cartridge is not compatible with this product.	Replace the print cartridge with one that is designed for this product.
Incompatible fuser	The fuser is not compatible with this product.	CAUTION: The fuser can be hot while the product is in use. Wait for the fuser to cool before handling it. <ol style="list-style-type: none">1. Open the right door.2. Remove the incompatible fuser.3. Install the correct fuser.4. Close the right door.
Incompatible supplies	Print cartridges or other supply items are installed that were not designed for this product. The product cannot print with these supplies installed.	Touch the Supplies button to identify the incompatible supplies. Install supplies that are designed for this product.
Incompatible transfer unit	The transfer unit is incompatible with this product.	<ol style="list-style-type: none">1. Open right door.2. Remove the incompatible transfer unit.3. Install the correct transfer unit.4. Close the right door.

Table 7-1 Supplies status messages (continued)

Control panel message	Description	Recommended action
Magenta cartridge low	The product indicates when a supply level is low. Actual print cartridge life might vary. You do not need to replace the print cartridge at this time unless print quality is no longer acceptable.	If print quality is no longer acceptable, replace the print cartridge. Consider purchasing a replacement cartridge so it is available when the installed cartridge has reached the end of its estimated life.
Magenta cartridge very low	The product indicates when a supply level is very low. Actual print cartridge life might vary. Consider having a replacement print cartridge available to install when print quality is no longer acceptable. You do not need to replace the print cartridge at this time unless print quality is no longer acceptable. After an HP supply has reached the very low threshold, the HP premium protection warranty for that supply has ended.	If print quality is no longer acceptable, replace the print cartridge.
Replace <color> cartridge	The product indicates when a supply level is at its estimated end of life. The actual life remaining might be different than the estimation. Have a replacement supply available to install when print quality is no longer acceptable. The supply does not need to be replaced now unless the print quality is no longer acceptable. After an HP supply has reached its approximated end of life, HP's premium Protection Warranty on that supply ends.	Replace the specified color cartridge. Or, configure the product to continue printing by using the Manage Supplies menu.
Replace fuser kit	The product indicates when the fuser kit is at its estimated end of life. The actual life remaining might be different than the estimation. Have a replacement fuser kit available to install when print quality is no longer acceptable. The fuser kit does not need to be replaced now unless the print quality is no longer acceptable. After the fuser kit reaches its approximated end of life, HP's premium Protection Warranty on that fuser kit ends.	CAUTION: The fuser can be hot while the product is in use. Wait for the fuser to cool before handling it. <ol style="list-style-type: none"> 1. Open the right door. 2. Grasp the blue handles on both sides of the fuser and pull straight out to remove it. 3. Install the new fuser. 4. Close the right door.
Replace supplies	Two or more supplies are at the estimated end of life. The actual life remaining might be different than the estimation. Consider having replacement supplies available to install when print quality is no longer acceptable. The supply does not need to be replaced now unless the print quality is no longer acceptable. After an HP supply has reached its approximated end of life, HP's premium Protection Warranty on that supply ends.	Touch the Supplies button to see which supplies need to be replaced. Or, configure the product to continue printing by using the Manage Supplies menu.

Table 7-1 Supplies status messages (continued)

Control panel message	Description	Recommended action
Replace toner collection unit	The product indicates when a toner collection unit is at its estimated end of life. The actual life remaining might be different than the estimation. Have a replacement toner collection unit available to install when print quality is no longer acceptable. The toner collection unit does not need to be replaced now unless the print quality is no longer acceptable. After a toner collection unit has reached its approximated end of life, HP's premium Protection Warranty on that toner collection unit ends.	Replace the toner collection unit. If you wish to have the toner collection unit operate past its estimated capacity, configure the product to continue printing by using the Manage Supplies menu. This is not a recommended option because of the risk of overfilling the toner collection unit, which could result in the need to service the product.
Replace transfer kit	The product indicates when a transfer kit is at its estimated end of life. The actual life remaining might be different than the estimation. Have a replacement transfer kit available to install when print quality is no longer acceptable. The transfer kit does not need to be replaced now unless the print quality is no longer acceptable. After a transfer kit has reached its approximated end of life, HP's premium Protection Warranty on that transfer kit ends.	Replace the transfer kit. Instructions are included with the transfer kit.
Supplies in wrong position	Two or more print-cartridge slots contain the wrong color print cartridge. From left to right, the print cartridges should be installed in this order: <ul style="list-style-type: none"> • Yellow • Magenta • Cyan • Black 	Install the correct color cartridge in each slot.
Supplies low	This message appears when at least two supplies have reached the low threshold. The actual supply life remaining might vary. Touch the Supplies button to see which supplies are low. You do not need to replace the supplies at this time unless print quality is no longer acceptable. After an HP supply has reached the very low threshold, the HP premium protection warranty for that supply has ended.	To continue printing in color, either replace the supply or reconfigure the product by using the Manage Supplies menu on the control panel.

Table 7-1 Supplies status messages (continued)

Control panel message	Description	Recommended action
Supplies very low	This message appears when at least two supplies have reached the very low threshold. Touch the Supplies button to see which supplies are low. The actual supply life remaining might vary. You do not need to replace the supplies at this time unless print quality is no longer acceptable. After an HP supply has reached the very low threshold, the HP premium protection warranty for that supply has ended.	To continue printing in color, either replace the supply or reconfigure the product by using the Manage Supplies menu on the control panel.
Toner collection unit low	The toner collection unit is almost full. The actual supply life remaining might vary. You do not need to replace the toner collection unit at this time unless print quality is no longer acceptable.	To continue printing, either touch the OK button or replace the toner collection unit.
Toner collection unit very low	The toner collection unit is almost full, and the product is configured to stop at this point. The actual supply life remaining might vary. After an HP supply has reached the very low threshold, the HP premium protection warranty for that supply has ended.	Reconfigure the product to continue printing, or replace the toner collection unit. CAUTION: Continuing to print when the toner collection unit is full could damage the product.
Transfer kit low	This message appears when the transfer kit reaches the low threshold. The actual supply life remaining might vary. You do not need to replace the transfer kit at this time unless print quality is no longer acceptable.	No action is necessary to continue. If the print quality is no longer acceptable, replace the transfer kit. Instructions are included with the new transfer kit.
Transfer kit very low	This message appears when the transfer kit has reached the very low threshold. The actual supply life remaining might vary. You do not need to replace the supplies at this time unless print quality is no longer acceptable. After an HP supply has reached the very low threshold, the HP premium protection warranty for that supply has ended.	To continue printing, either replace the transfer kit or reconfigure the product to continue printing by using the Manage Supplies menu on the control panel.
Unsupported supply installed	One of the print cartridges is for a different HP product.	If print quality is no longer acceptable, replace the print cartridge.
Used supply in use	One of the print cartridges has been previously used.	If you believe you purchased a genuine HP supply, go to www.hp.com/go/anticounterfeit .

Table 7-1 Supplies status messages (continued)

Control panel message	Description	Recommended action
Wrong cartridge in <color> slot	<p>The indicated slot for a print cartridge contains a cartridge that is not the correct color. From left to right, the print cartridges should be installed in this order:</p> <ul style="list-style-type: none">• Yellow• Magenta• Cyan• Black	<p>Remove the print cartridge from that slot, and install a cartridge that is the correct color.</p>
Yellow cartridge low	<p>The product indicates when a supply level is low. Actual print cartridge life might vary. You do not need to replace the print cartridge at this time unless print quality is no longer acceptable.</p>	<p>If print quality is no longer acceptable, replace the print cartridge. Consider purchasing a replacement cartridge so it is available when the installed cartridge has reached the end of its estimated life.</p>
Yellow cartridge very low	<p>The product indicates when a supply level is very low. Actual print cartridge life might vary. Consider having a replacement print cartridge available to install when print quality is no longer acceptable. You do not need to replace the print cartridge at this time unless print quality is no longer acceptable. After an HP supply has reached the very low threshold, the HP premium protection warranty for that supply has ended.</p>	<p>If print quality is no longer acceptable, replace the print cartridge.</p>

8 Print tasks

- [Cancel a print job with Windows](#)
- [Basic print tasks with Windows](#)
- [Additional print tasks with Windows](#)
- [Walk-up USB printing](#)

Cancel a print job with Windows

 **NOTE:** If the print job is too far into the printing process, you might not have the option to cancel it.

1. If the print job is currently printing, cancel it by following this procedure:
 - a. Press the Stop  button on the control panel.
 - b. From the list on the touchscreen, touch the print job you want to delete, and touch the **Cancel Job** button.
 - c. The product prompts you to confirm the deletion. Touch the **Yes** button.
2. You can also cancel a print job from a software program or a print queue.
 - **Software program:** Typically, a dialog box appears briefly on the computer screen, allowing you to cancel the print job.
 - **Windows print queue:** If a print job is waiting in a print queue (computer memory) or print spooler, delete the job there.
 - **Windows XP, Server 2003, or Server 2008:** Click **Start**, click **Settings**, and then click **Printers and Faxes**. Double-click the product icon to open the window, right-click the print job that you want to cancel, and then click **Cancel**.
 - **Windows Vista:** Click **Start**, click **Control Panel**, and then, under **Hardware and Sound**, click **Printer**. Double-click the product icon to open the window, right-click the print job that you want to cancel, and then click **Cancel**.
 - **Windows 7:** Click **Start**, and then click **Devices and Printers**. Double-click the product icon to open the window, right-click the print job that you want to cancel, and then click **Cancel**.

Basic print tasks with Windows

The methods to open the print dialog from software programs can vary. The procedures that follow include a typical method. Some software programs do not have a **File** menu. See the documentation for your software program to learn how to open the print dialog.

Open the printer driver with Windows

1. On the **File** menu in the software program, click **Print**.

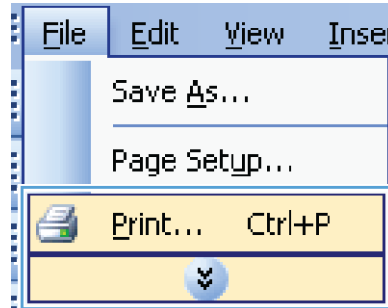

2. Select the product, and then click the **Properties** or **Preferences** button.

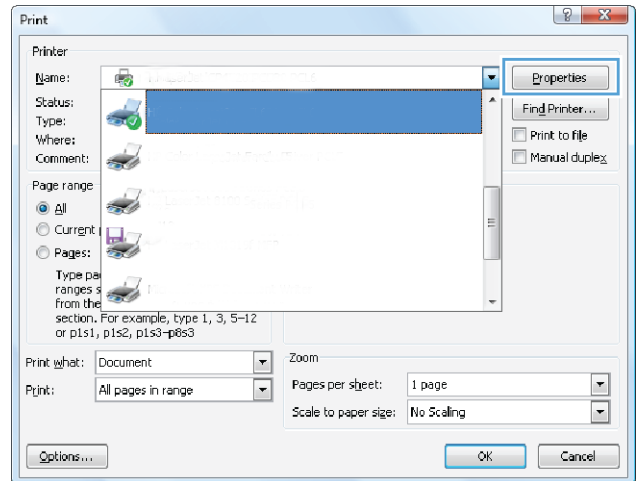

Get help for any printing option with Windows

1. Click the **Help** button to open the online Help.

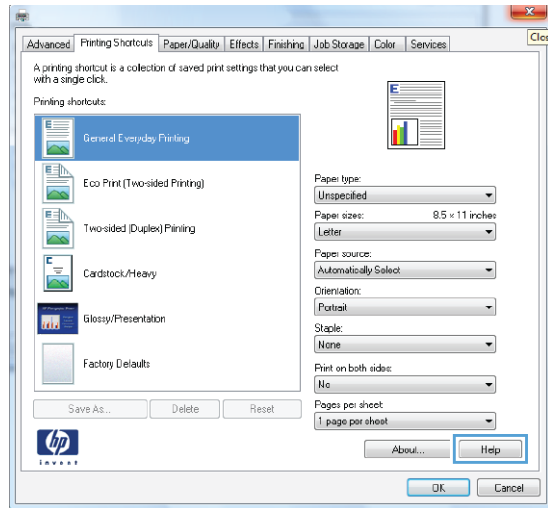

Change the number of print copies with Windows

1. On the **File** menu in the software program, click **Print**.
2. Select the product, and then select the number of copies.

Save custom print settings for reuse with Windows

Use a printing shortcut with Windows

1. On the **File** menu in the software program, click **Print**.

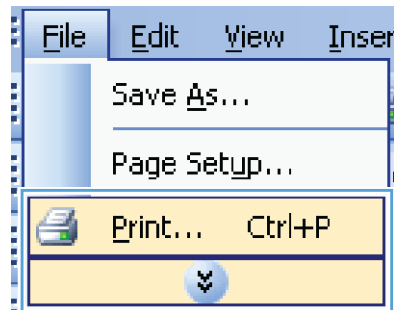

2. Select the product, and then click the **Properties** or **Preferences** button.

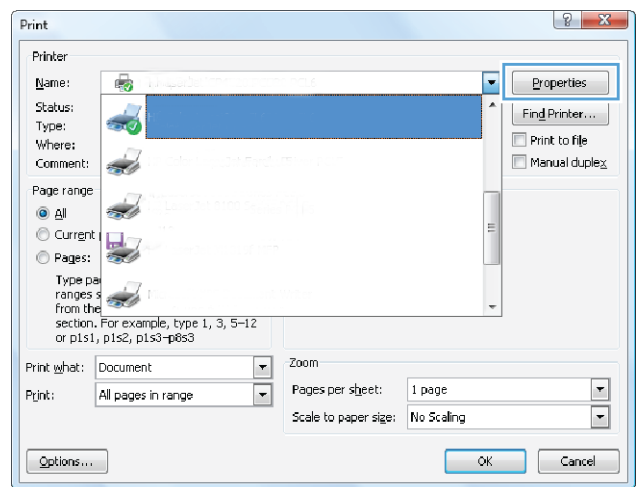

3. Click the **Printing Shortcuts** tab.

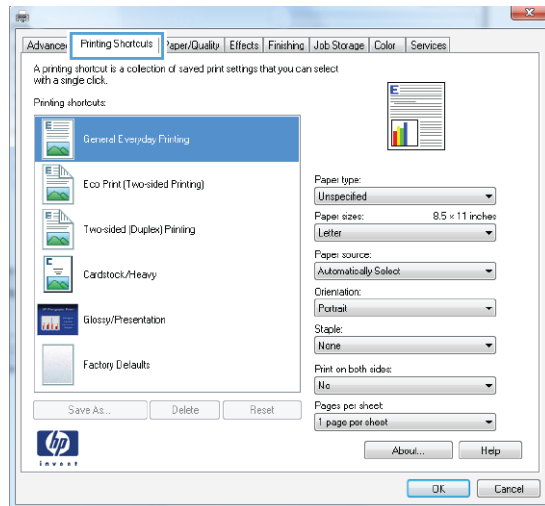

4. Select one of the shortcuts, and then click the **OK** button.

NOTE: When you select a shortcut, the corresponding settings change on the other tabs in the printer driver.

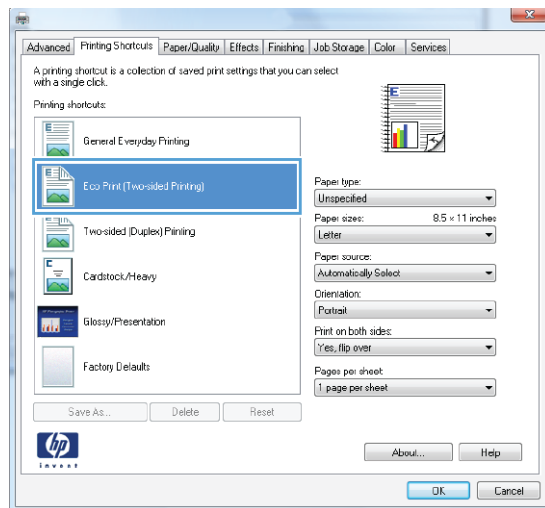

Create printing shortcuts

1. On the **File** menu in the software program, click **Print**.

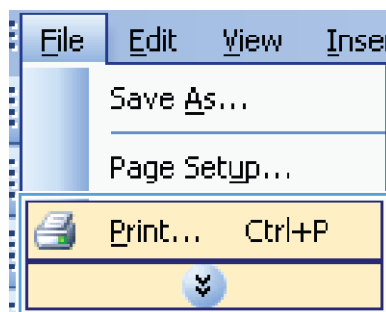

2. Select the product, and then click the **Properties** or **Preferences** button.

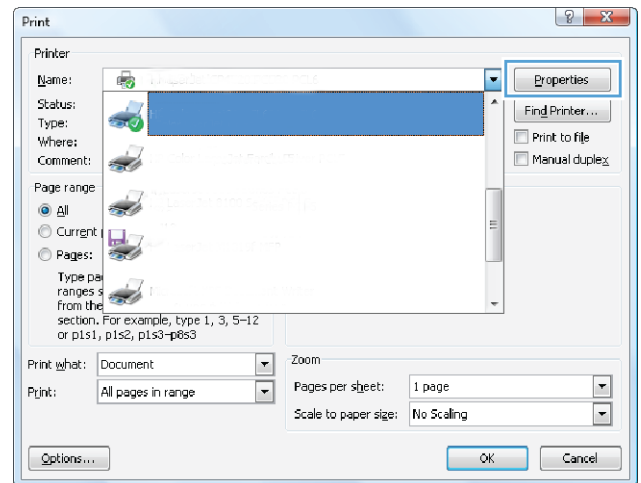

3. Click the **Printing Shortcuts** tab.

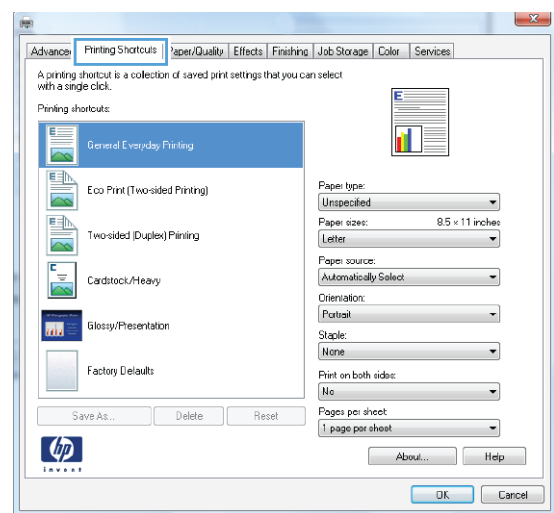

4. Select an existing shortcut as a base.

NOTE: Always select a shortcut before adjusting any of the settings on the right side of the screen. If you adjust the settings and then select a shortcut, all your adjustments are lost.

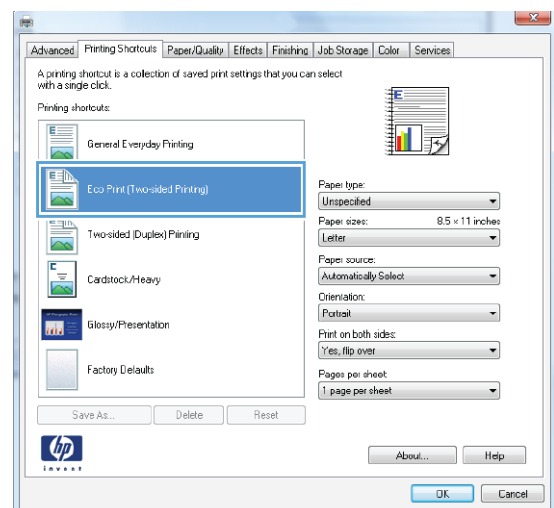

5. Select the print options for the new shortcut.

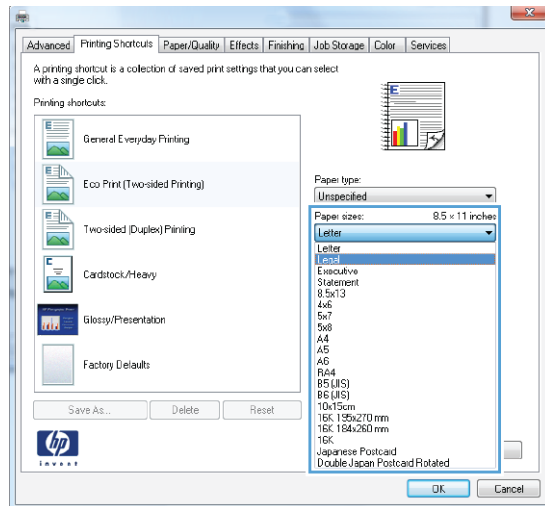

6. Click the **Save As** button.

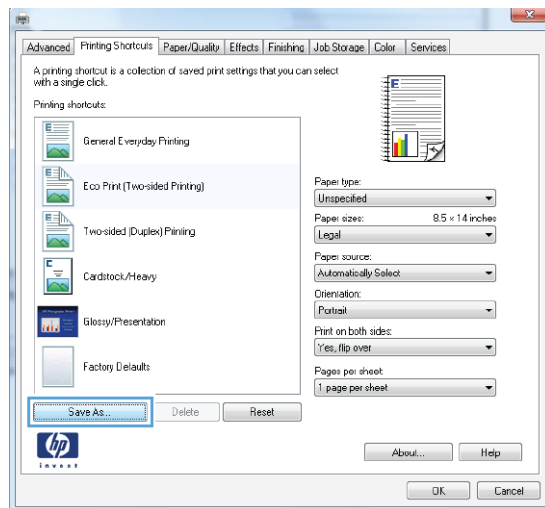

7. Type a name for the shortcut, and click the **OK** button.

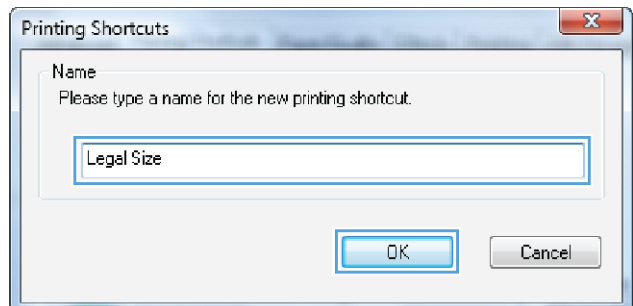

Improve print quality with Windows

Select the page size with Windows

1. On the **File** menu in the software program, click **Print**.
2. Select the product, and then click the **Properties** or **Preferences** button.
3. Click the **Paper/Quality** tab.
4. Select a size from the **Paper size** drop-down list.

Select a custom page size with Windows

1. On the **File** menu in the software program, click **Print**.
2. Select the product, and then click the **Properties** or **Preferences** button.
3. Click the **Paper/Quality** tab.
4. Click the **Custom** button.
5. Type a name for the custom size, specify the dimensions, and click the **OK** button.

Select the paper type with Windows

1. On the **File** menu in the software program, click **Print**.
2. Select the product, and then click the **Properties** or **Preferences** button.
3. Click the **Paper/Quality** tab.
4. From the **Paper type** drop-down list, click the **More...** option.
5. Expand the list of **Type is:** options.
6. Expand the category of paper types that best describes your paper, and then click the paper type that you are using.

Select the paper tray with Windows

1. On the **File** menu in the software program, click **Print**.
2. Select the product, and then click the **Properties** or **Preferences** button.
3. Click the **Paper/Quality** tab.
4. Select a tray from the **Paper source** drop-down list.

Select the gloss level with Windows

1. On the **File** menu in the software program, click **Print**.
2. Select the product, and then click the **Properties** or **Preferences** button.

3. Click the **Paper/Quality** tab.
4. In the **Print Quality** area, select the gloss level from the first drop-down list.

Print on both sides (duplex) with Windows

1. On the **File** menu in the software program, click **Print**.

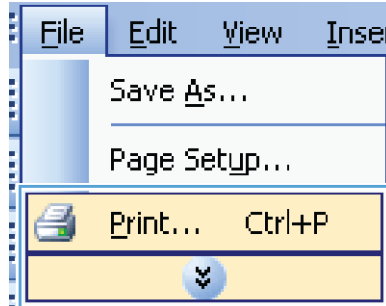

2. Select the product, and then click the **Properties** or **Preferences** button.

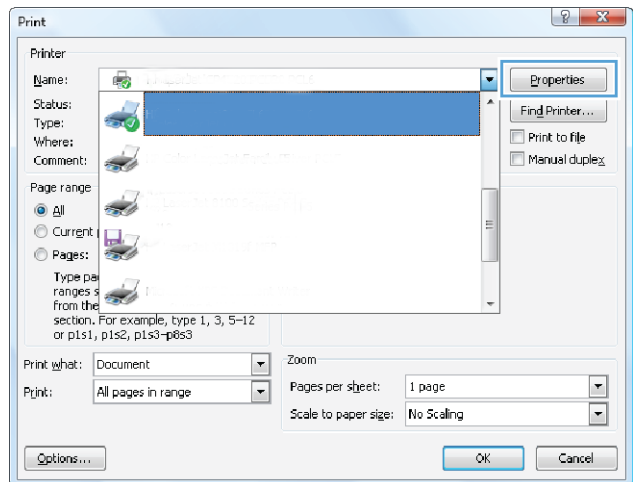

3. Click the **Finishing** tab.

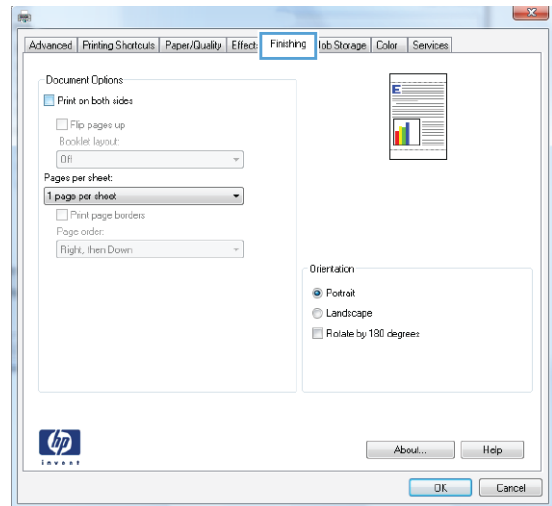

4. Select the **Print on both sides** check box. Click the **OK** button to print the job.

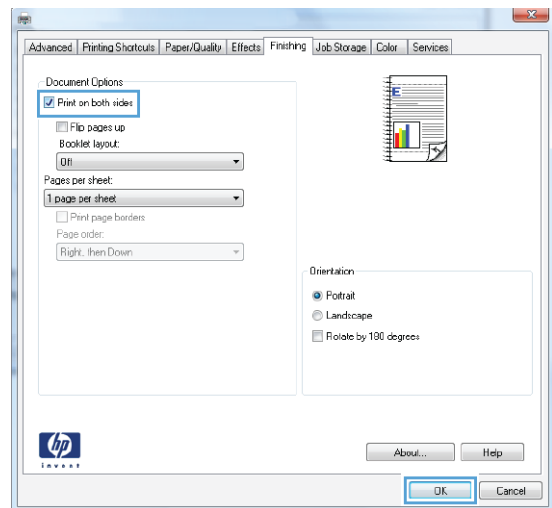

Print multiple pages per sheet with Windows

1. On the **File** menu in the software program, click **Print**.

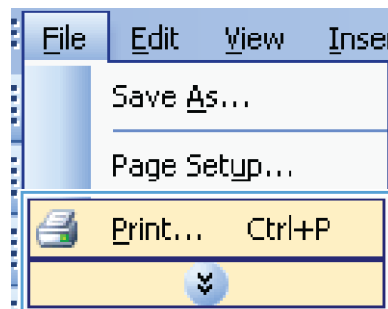

2. Select the product, and then click the **Properties** or **Preferences** button.

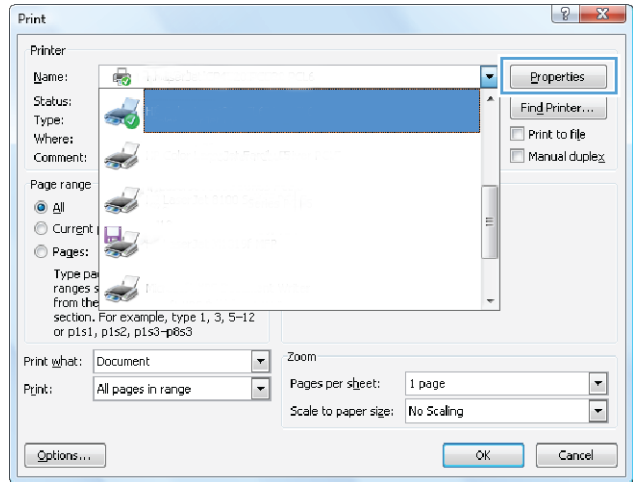

3. Click the **Finishing** tab.

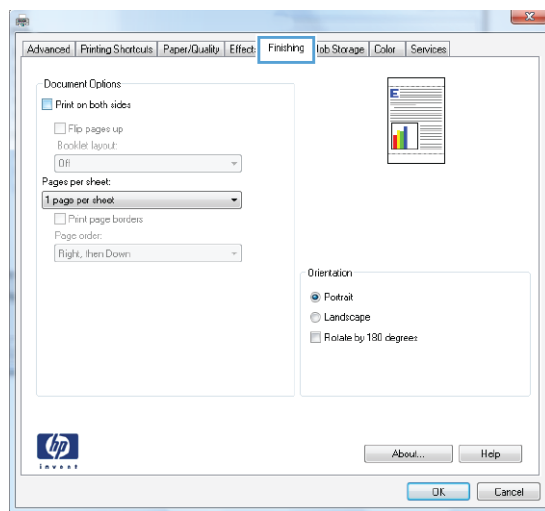

4. Select the number of pages per sheet from the **Pages per sheet** drop-down list.

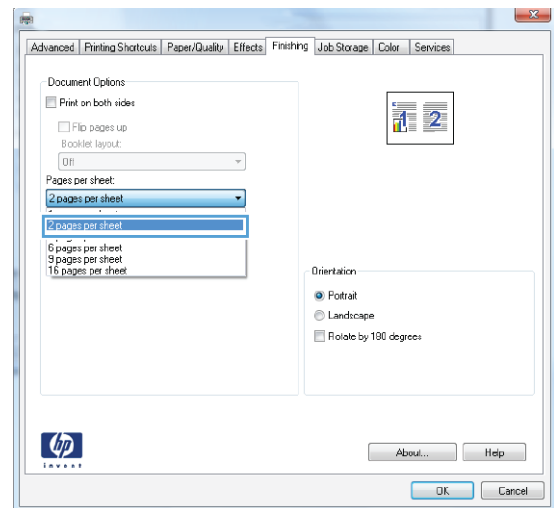

5. Select the correct **Print page borders**, **Page order**, and **Orientation** options.

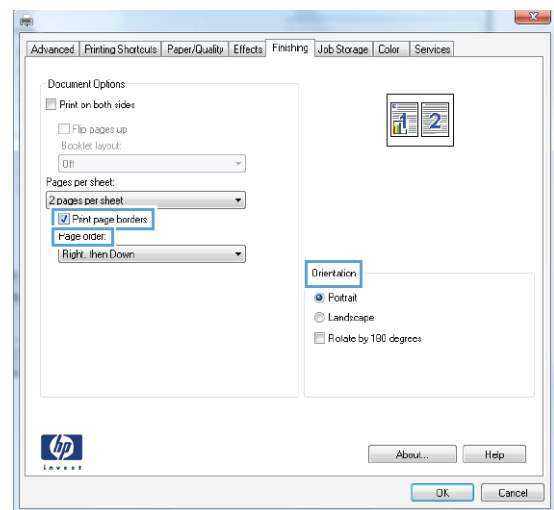

Select page orientation with Windows

1. On the **File** menu in the software program, click **Print**.

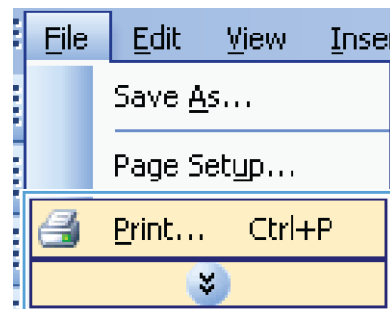

2. Select the product, and then click the **Properties** or **Preferences** button.

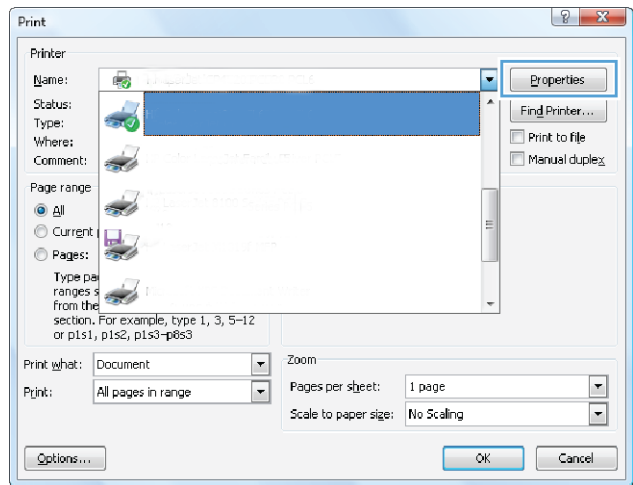

3. Click the **Finishing** tab.

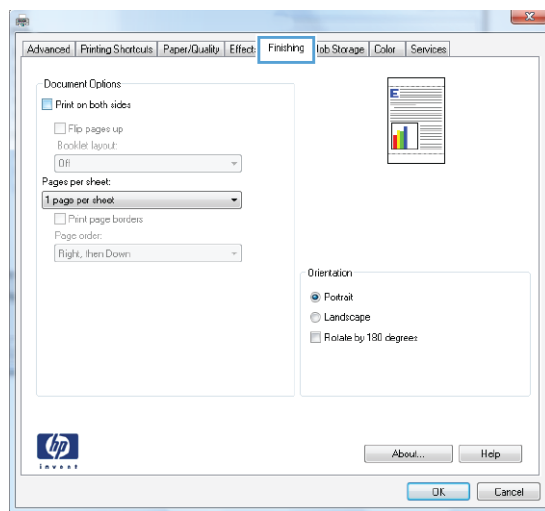

4. In the **Orientation** area, select the **Portrait** or **Landscape** option.

To print the page image upside down, select the **Rotate by 180 degrees** option.

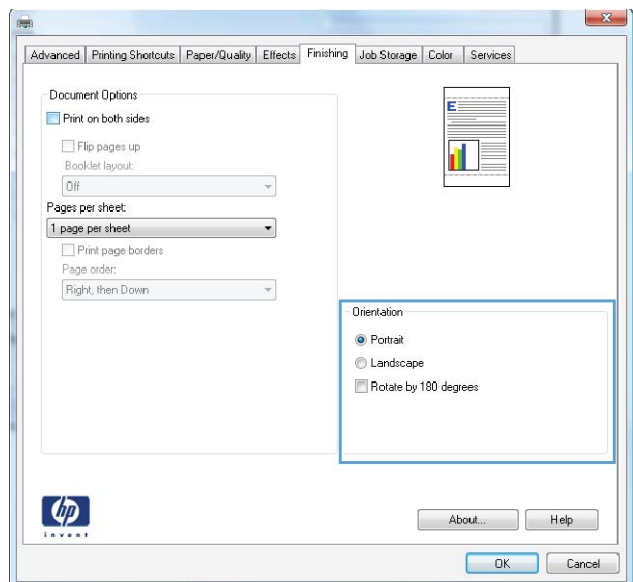

Set color options with Windows

1. On the **File** menu in the software program, click **Print**.

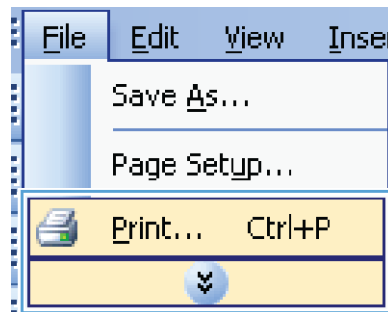

2. Select the product, and then click the **Properties** or **Preferences** button.

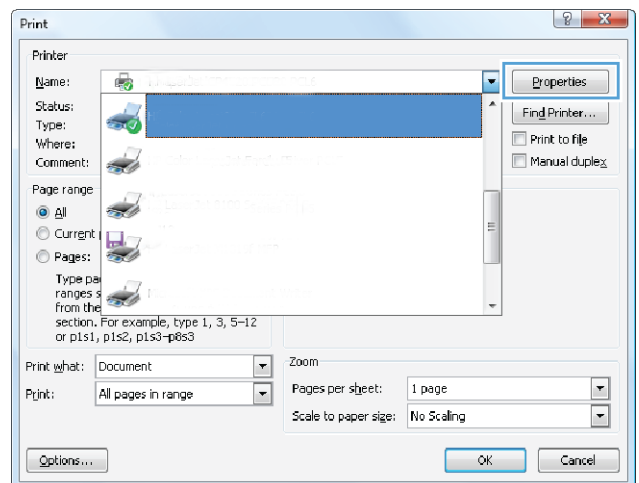

3. Click the **Color** tab.

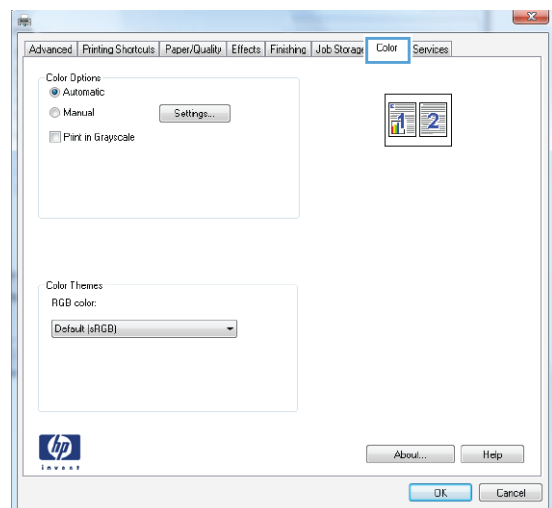

4. Click the **HP EasyColor** check box to clear it.

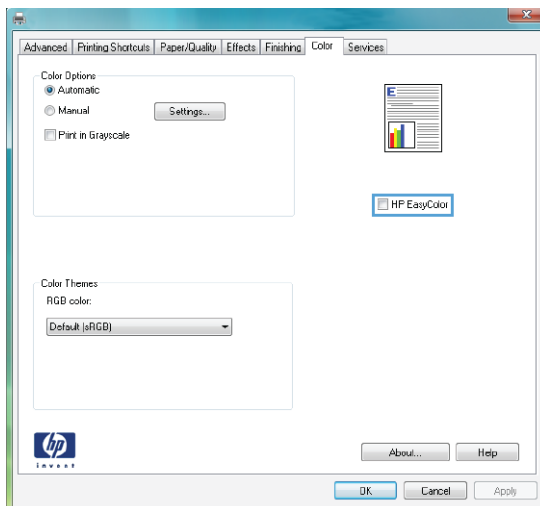

5. In the **Color Options** area, click the **Manual** option, and then click the **Settings** button.

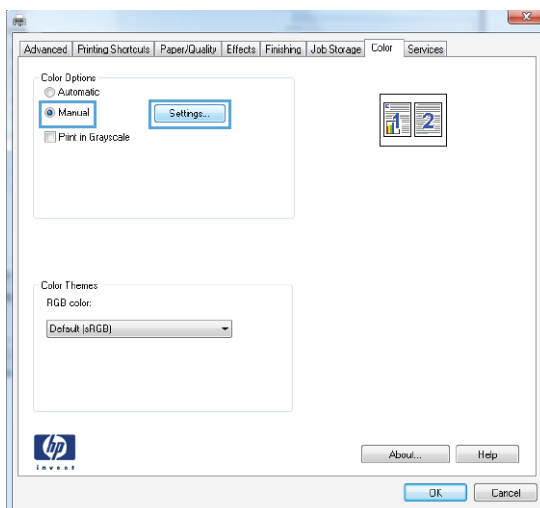

6. Adjust the general settings for Edge Control, and settings for text, graphics, and photographs.

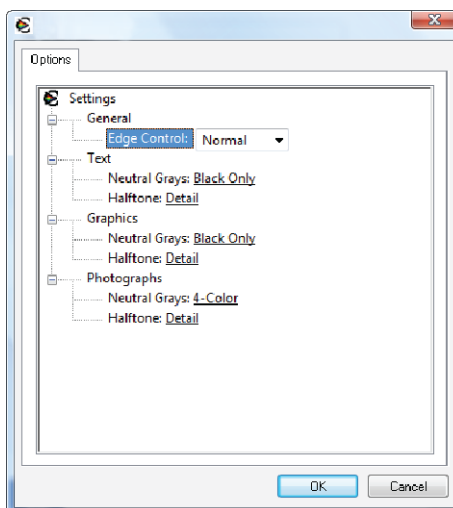

Additional print tasks with Windows

Print colored text as black (grayscale) with Windows

1. On the **File** menu in the software program, click **Print**.
2. Select the product, and then click the **Properties** or **Preferences** button.
3. Click the **Advanced** tab.
4. Expand the **Document Options** section.
5. Expand the **Printer Features** section.
6. In the **Print All Text as Black** drop-down list, select the **Enabled** option.

Print on preprinted letterhead or forms with Windows

1. On the **File** menu in the software program, click **Print**.

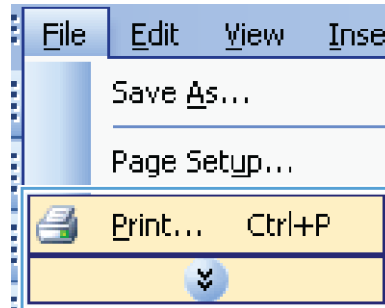

2. Select the product, and then click the **Properties** or **Preferences** button.

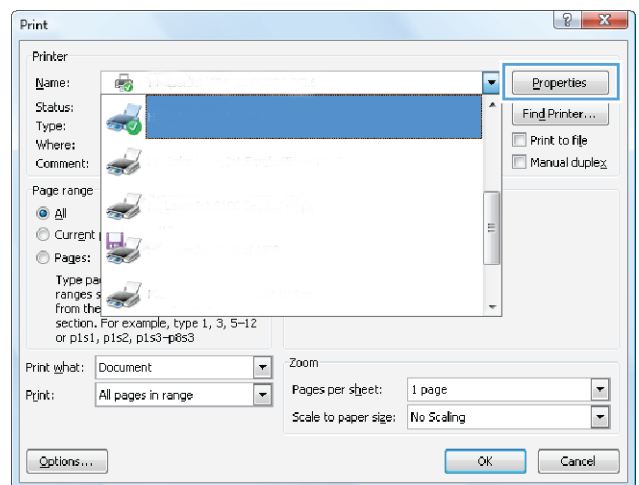

3. Click the **Paper/Quality** tab.

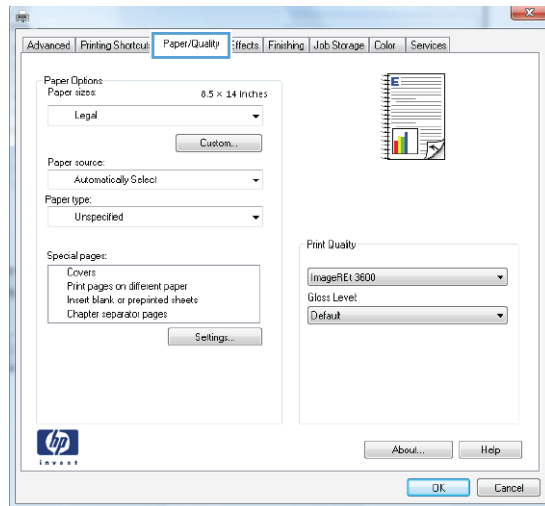

4. From the **Paper type** drop-down list, click the **More...** option.

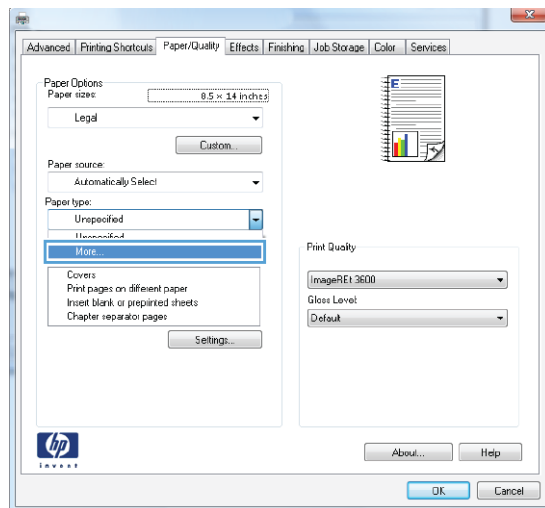

5. Expand the list of **Type is:** options.

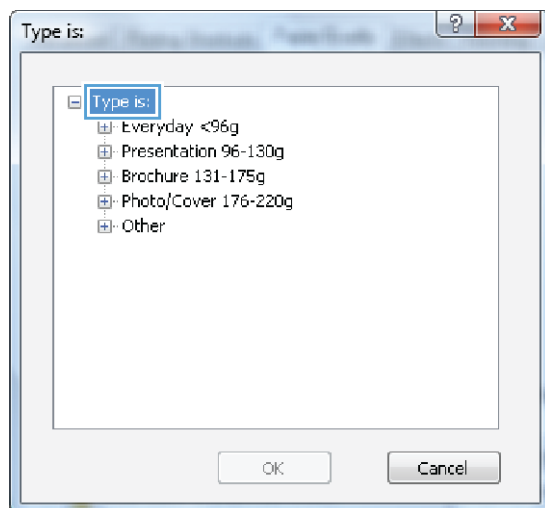

- Expand the list of **Other** options.

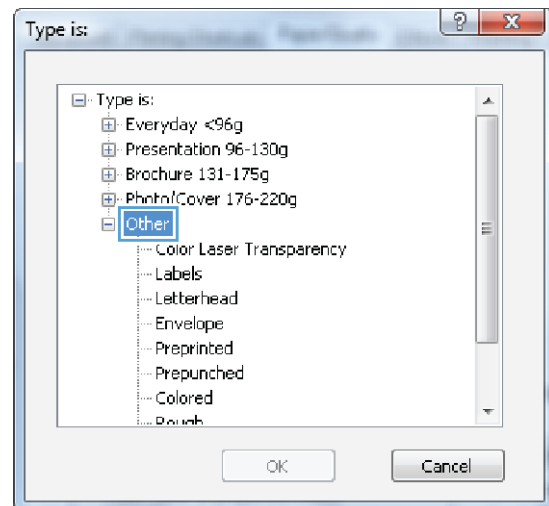

- Select the option for the type of paper you are using, and click the **OK** button.

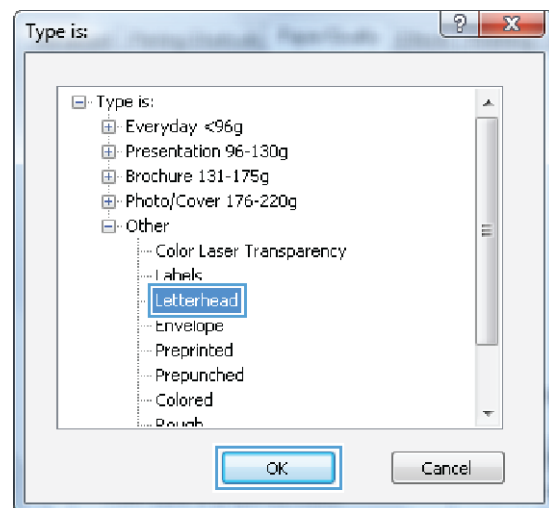

Print on special paper, labels, or transparencies

- On the **File** menu in the software program, click **Print**.

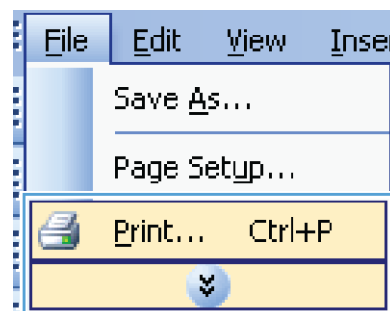

2. Select the product, and then click the **Properties** or **Preferences** button.

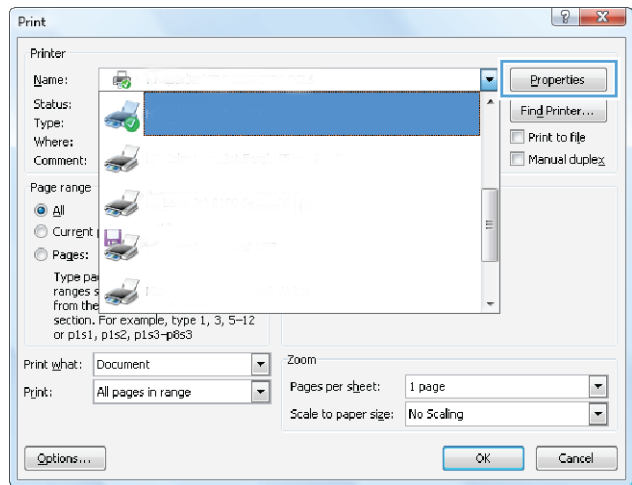

3. Click the **Paper/Quality** tab.

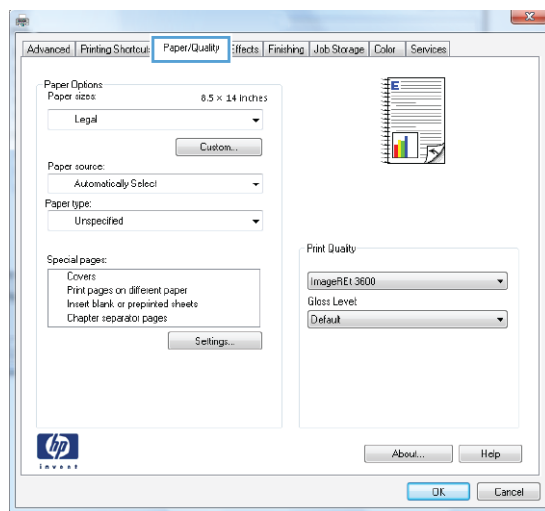

4. From the **Paper type** drop-down list, click the **More...** option.

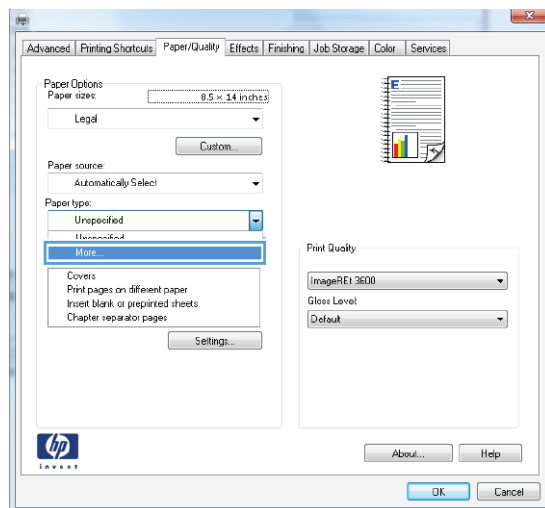

5. Expand the list of **Type is:** options.

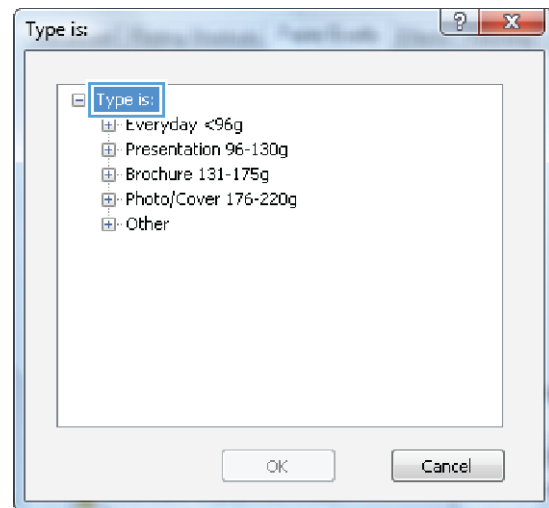

6. Expand the category of paper types that best describes your paper.

NOTE: Labels and transparencies are in the list of **Other** options.

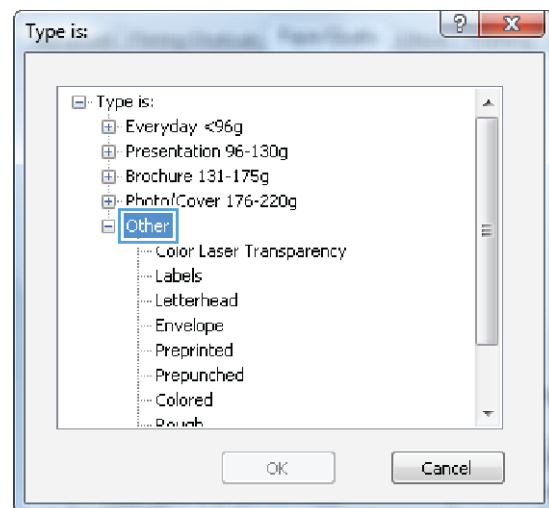

7. Select the option for the type of paper you are using, and click the **OK** button.

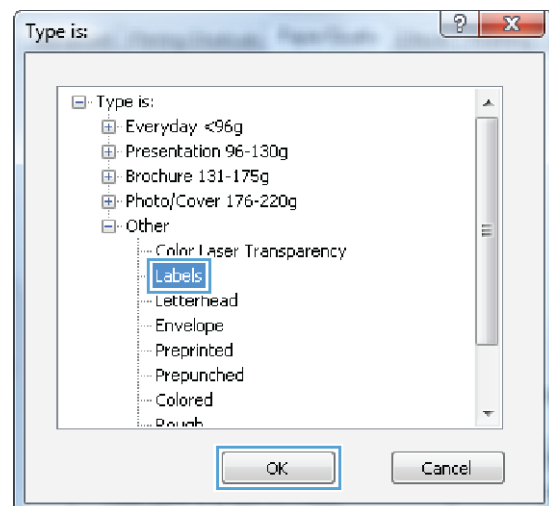

Print the first or last page on different paper with Windows

1. On the **File** menu in the software program, click **Print**.

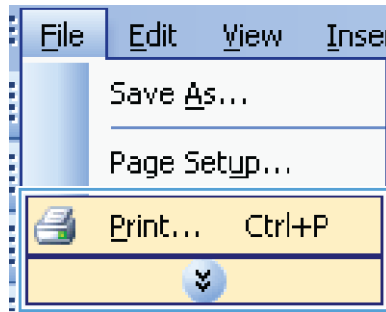

2. Select the product, and then click the **Properties** or **Preferences** button.

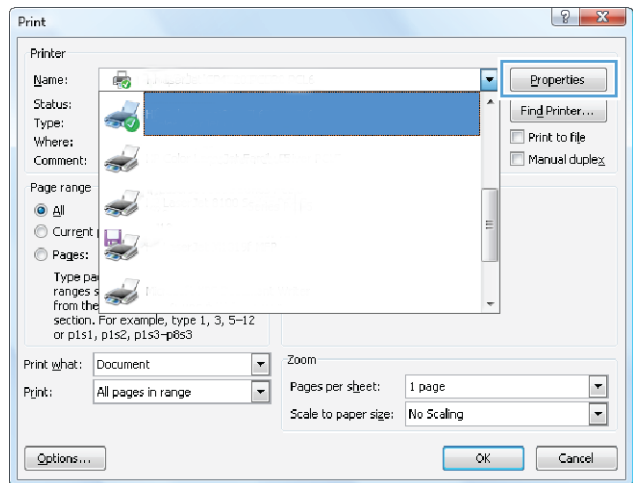

3. Click the **Paper/Quality** tab.

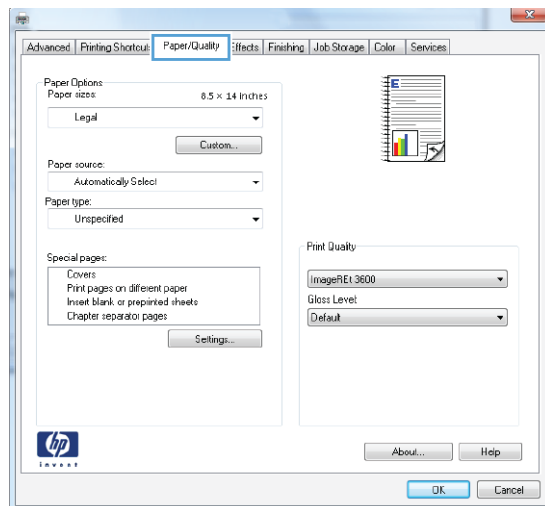

- In the **Special pages** area, click the **Print pages on different paper** option, and then click the **Settings** button.

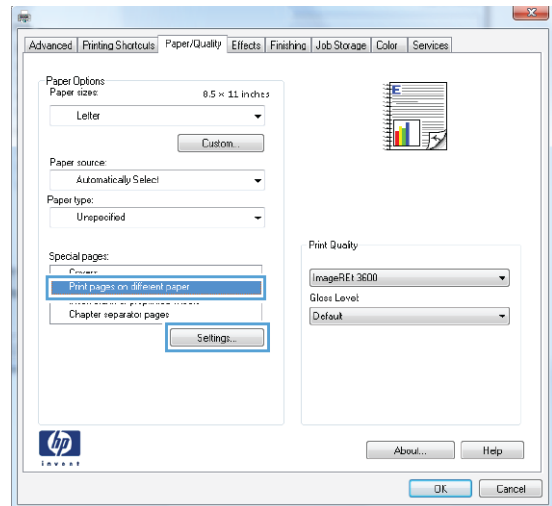

- In the **Pages in document** area, select either the **First** or **Last** option.

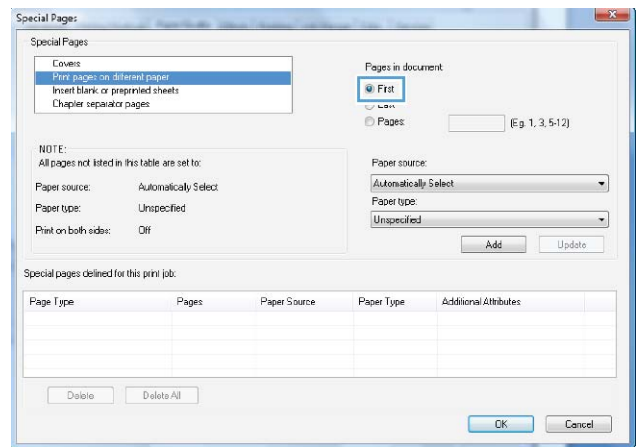

- Select the correct options from the **Paper source** and **Paper type** drop-down lists. Click the **Add** button.

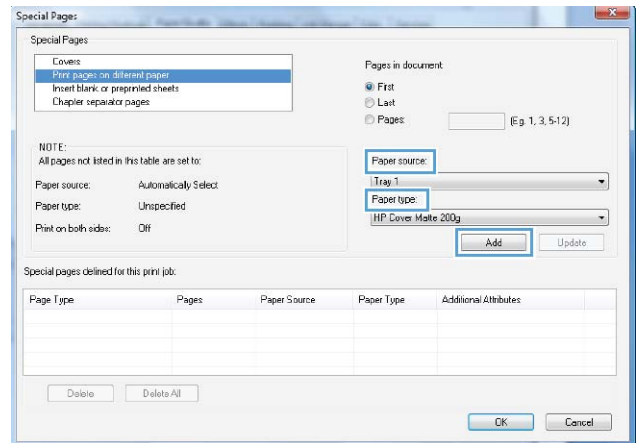

- If you are printing *both* the first and last pages on different paper, repeat steps 5 and 6, selecting the options for the other page.

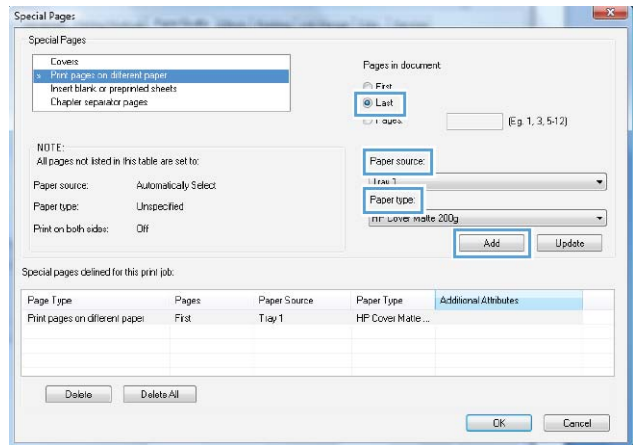

- Click the **OK** button.

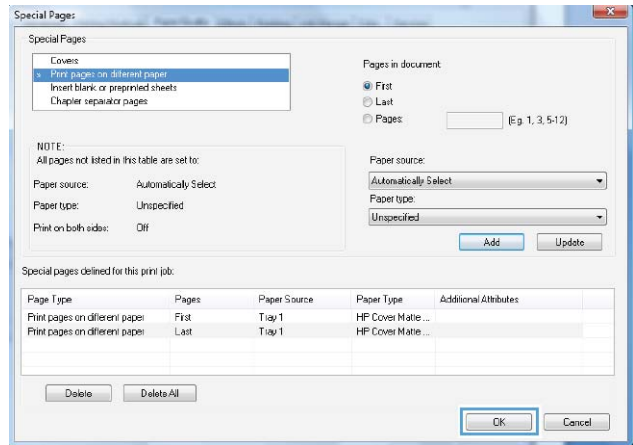

Scale a document to fit page size with Windows

- On the **File** menu in the software program, click **Print**.

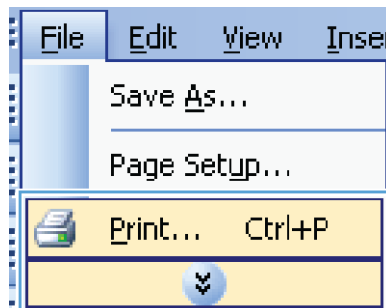

2. Select the product, and then click the **Properties** or **Preferences** button.

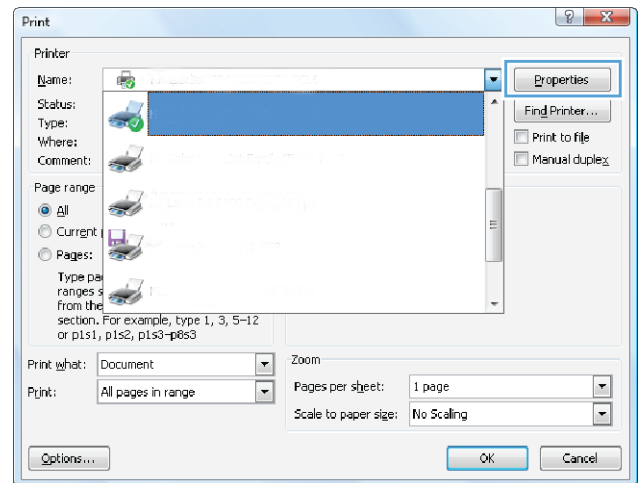

3. Click the **Effects** tab.

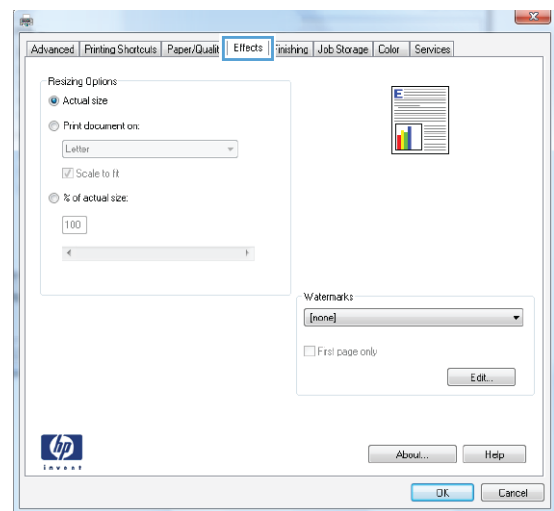

4. Select the **Print document on** option, and then select a size from the drop-down list.

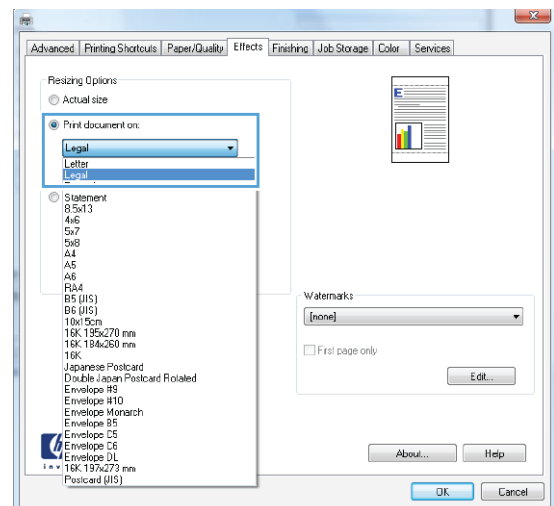

Add a watermark to a document with Windows

1. On the **File** menu in the software program, click **Print**.
2. Select the product, and then click the **Properties** or **Preferences** button.
3. Click the **Effects** tab.
4. Select a watermark from the **Watermarks** drop-down list.

Or, to add a new watermark to the list, click the **Edit** button. Specify the settings for the watermark, and then click the **OK** button.

5. To print the watermark on the first page only, select the **First page only** check box. Otherwise, the watermark is printed on each page.

Create a booklet with Windows

1. On the **File** menu in the software program, click **Print**.

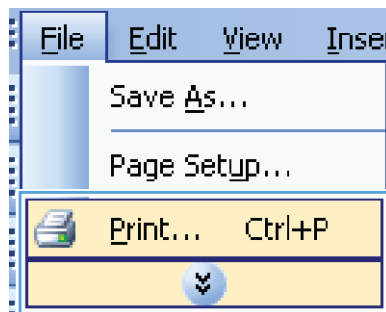

2. Select the product, and then click the **Properties** or **Preferences** button.

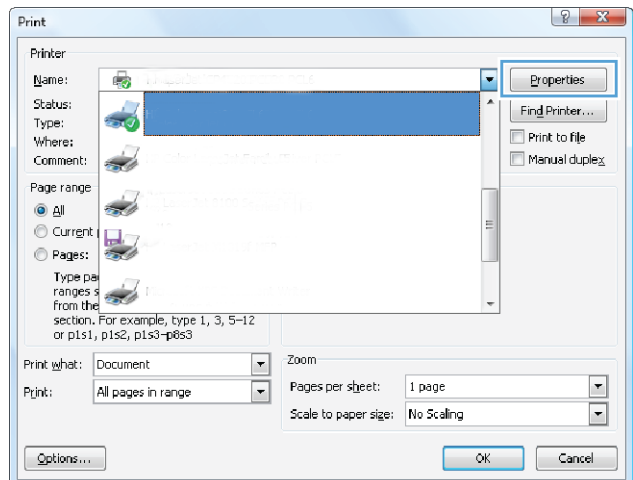

3. Click the **Finishing** tab.

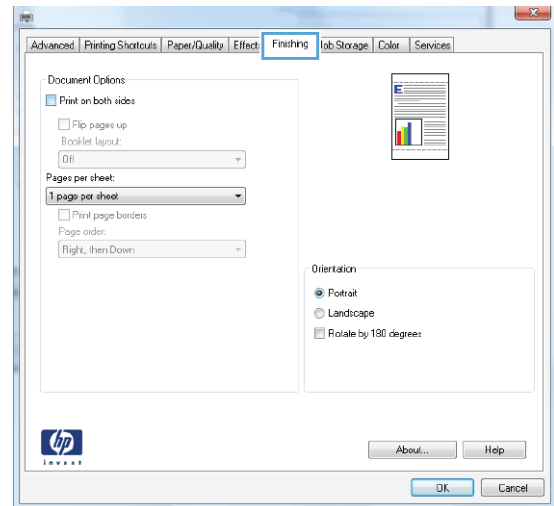

4. Select the **Print on both sides** check box.

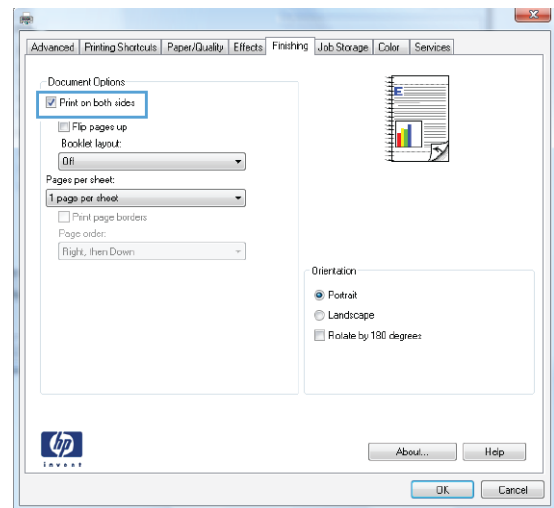

5. In the **Booklet layout** drop-down list, click the **Left binding** or **Right binding** option. The **Pages per sheet** option automatically changes to **2 pages per sheet**.

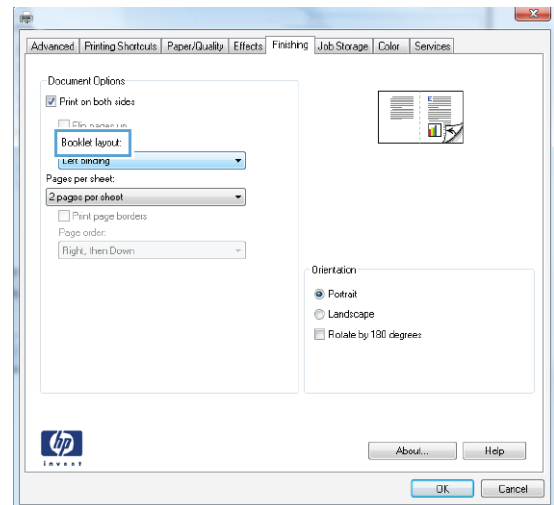

Select output options with Windows (fskm models only)

Select an output bin with Windows

1. On the **File** menu in the software program, click **Print**.

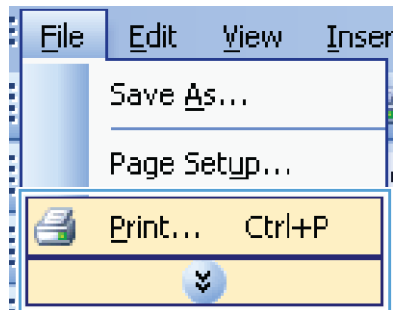

2. Select the product, and then click the **Properties** or **Preferences** button.

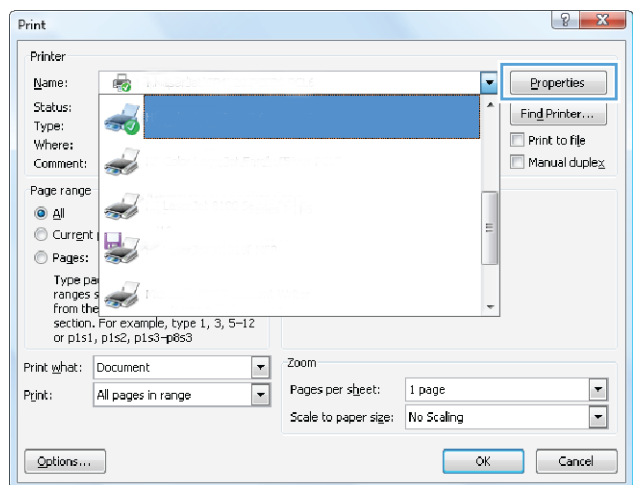

3. Click the **Output** tab.

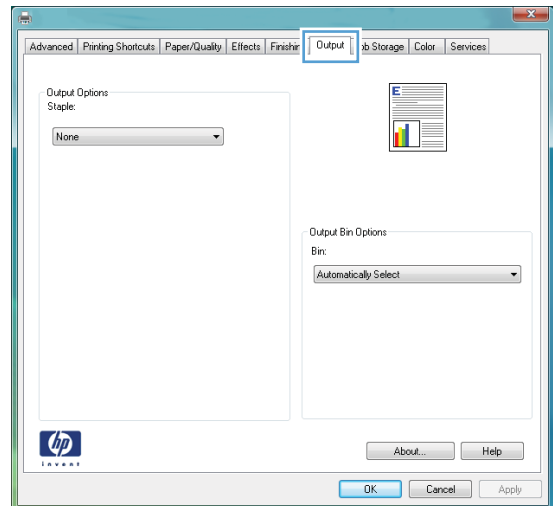

4. In the **Output Bin Options** area, select a bin from the **Bin** drop-down list.

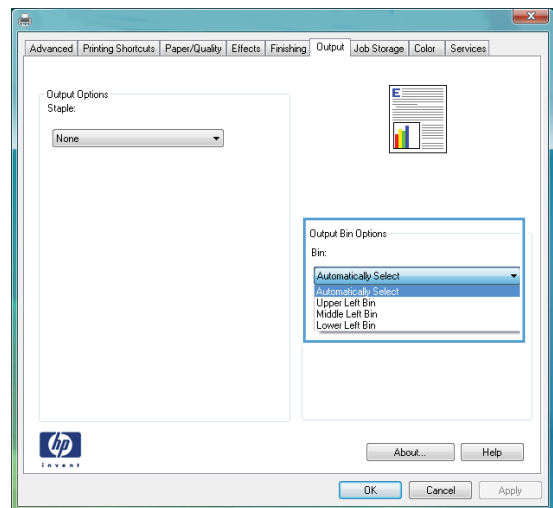

Select staple options with Windows

1. On the **File** menu in the software program, click **Print**.

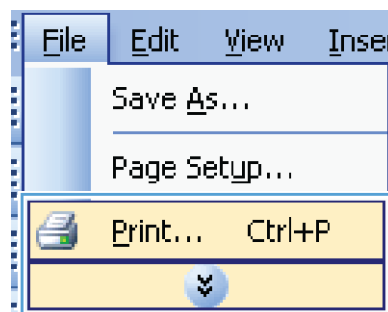

2. Select the product, and then click the **Properties** or **Preferences** button.

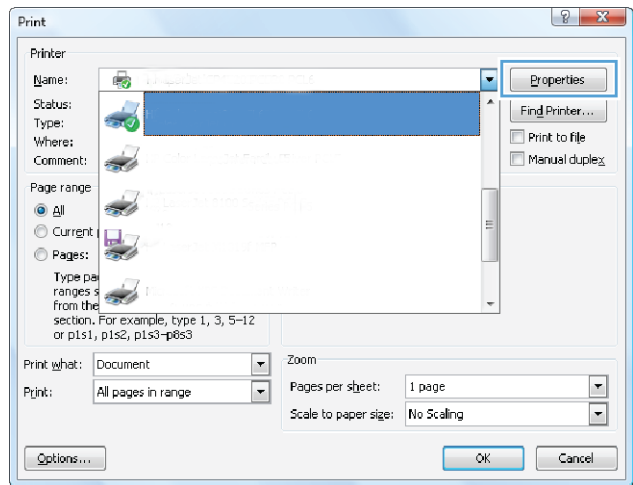

3. Click the **Output** tab.

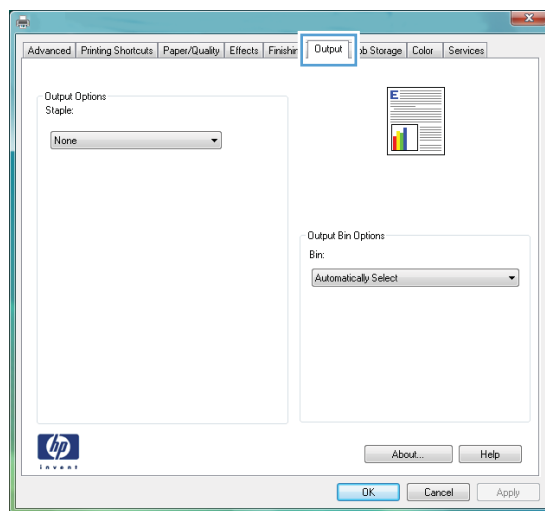

4. In the **Output Options** area, select an option from the **Staple** drop-down list.

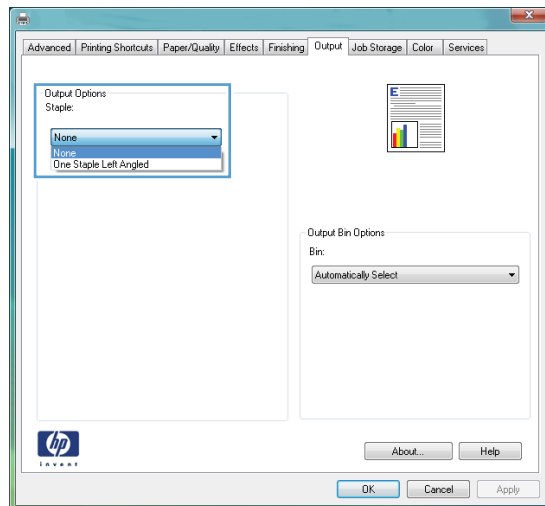

Use job storage features with Windows

The following job-storage modes are available for print jobs:

- **Proof and Hold:** This feature provides a quick way to print and proof one copy of a job and then print more copies.
- **Personal Job:** When you send a job to the product, the job does not print until you request it at the product control panel. If you assign a personal identification number (PIN) to the job, you must provide the required PIN at the control panel.
- **Quick Copy:** If the optional hard disk is installed on the product, you can print the requested number of copies of a job and then store a copy of the job on the optional hard disk. Storing the job allows you to print additional copies of the job later.
- **Stored Job:** If the optional hard disk is installed on the product, you can store a job such as a personnel form, time sheet, or calendar on the product and allow other users to print the job at any time. Stored jobs also can be protected by a PIN.

△ **CAUTION:** If you turn off the product, all **Quick Copy**, **Proof and Hold**, and **Personal Job** types of stored jobs are deleted. To permanently store the job and prevent the product from deleting it when space is needed for something else, select the **Stored Job** option in the driver.

Create a stored job with Windows

1. On the **File** menu in the software program, click **Print**.
2. Select the product, and then click the **Properties** or **Preferences** button.

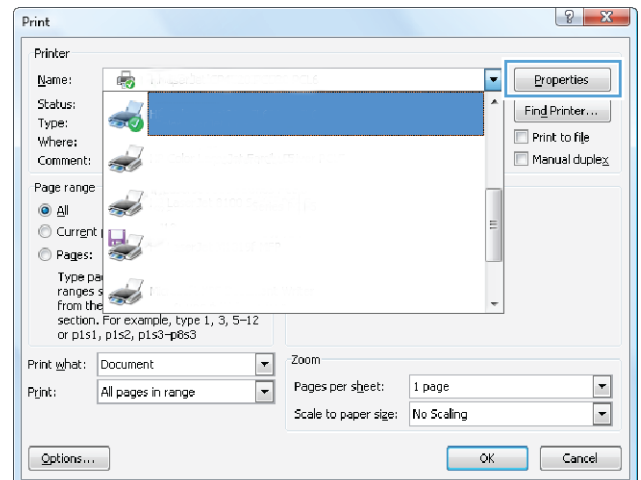
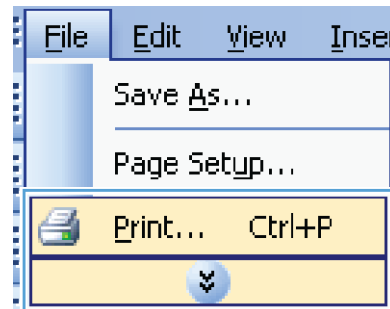

3. Click the **Job Storage** tab.

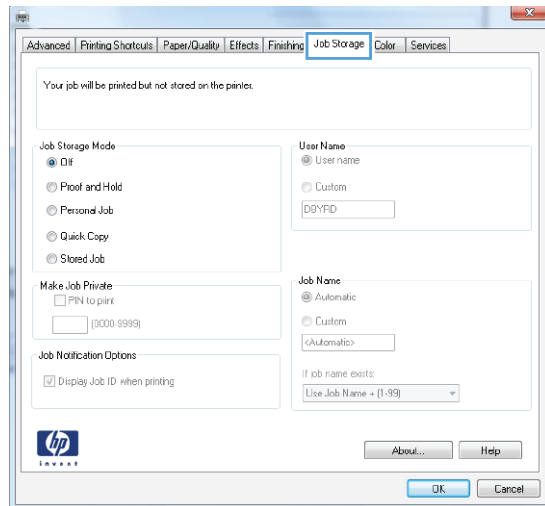

4. Select a **Job Storage Mode** option.

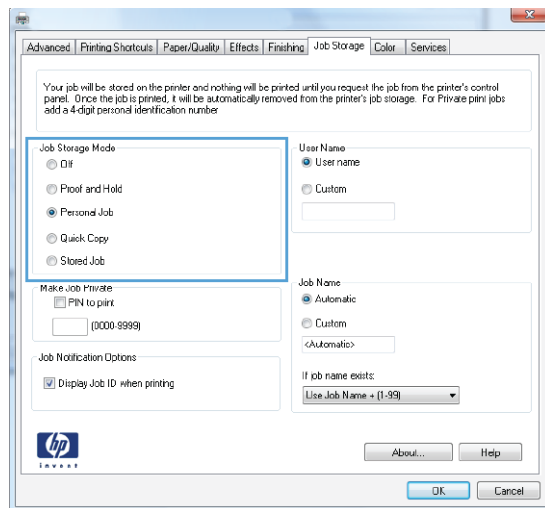

Print a stored job

Use the following procedure to print a job that is stored in the product memory.

1. From the Home screen, touch the **Open from Device Memory** button.



2. Select the name of the folder where the job is stored.



3. Select the name of the job, adjust the number of copies, and then touch the Start button to print the job.

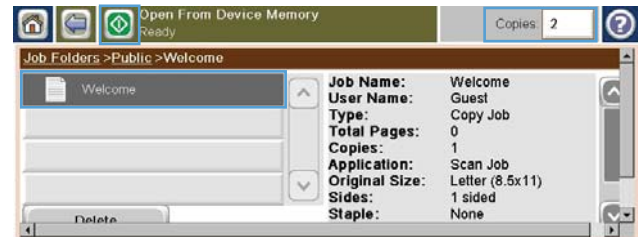

4. If the job is locked, type the PIN in the PIN field, adjust the number of copies, and then touch the Start button to print the job.



Delete a stored job

When you send a stored job to the product memory, the product overwrites any previous jobs with the same user and job name. If a job is not already stored under the same user and job name, and the product needs additional space, the product might delete other stored jobs starting with the oldest. You can change the number of jobs that can be stored from the [General Settings](#) menu on the product control panel.

Use this procedure to delete a job that is stored in the product memory.

1. From the Home screen, touch the [Open from Device Memory](#) button.
2. Select the name of the folder where the job is stored.
3. Select the name of the job, and then touch the [Delete](#) button.
4. If the job is locked, type the PIN in the [PIN](#) field, and then touch the [Delete](#) button.

Set job storage options with Windows

Print one copy for proof before printing all the copies

1. On the **File** menu in the software program, click **Print**.
2. Select the product, and then click the **Properties** or **Preferences** button.

3. Click the **Job Storage** tab.
4. In the **Job Storage Mode** area, click the **Proof and Hold** option.

Temporarily store a personal job on the product and print it later

 **NOTE:** The product deletes the job after you print it.

1. On the **File** menu in the software program, click **Print**.
2. Select the product, and then click the **Properties** or **Preferences** button.
3. Click the **Job Storage** tab.
4. In the **Job Storage Mode** area, click the **Personal Job** option.
5. Optional: In the **Make Job Private** area, click the **PIN to print** option, and enter a 4-digit personal identification number (PIN).
6. Print the job at any time from the product control panel.

Temporarily store a job on the product

 **NOTE:** This option is available if the optional hard disk is installed in the product.

NOTE: The product stores the job until you turn the product off.

1. On the **File** menu in the software program, click **Print**.
2. Select the product, and then click the **Properties** or **Preferences** button.
3. Click the **Job Storage** tab.
4. In the **Job Storage Mode** area, click the **Quick Copy** option.

The requested number of copies are printed immediately, and you can print more copies from the product control panel.

Permanently store a job on the product

 **NOTE:** This option is available if the optional hard disk is installed in the product.

1. On the **File** menu in the software program, click **Print**.
2. Select the product, and then click the **Properties** or **Preferences** button.
3. Click the **Job Storage** tab.
4. In the **Job Storage Mode** area, click the **Stored Job** option.

Make a permanently stored job private so that anyone who tries to print it must provide a PIN

 **NOTE:** This option is available if the optional hard disk is installed in the product.

1. On the **File** menu in the software program, click **Print**.
2. Select the product, and then click the **Properties** or **Preferences** button.
3. Click the **Job Storage** tab.
4. In the **Job Storage Mode** area, click the **Stored Job** option or the **Personal Job** option.
5. In the **Make Job Private** area, click the **PIN to print** option, and enter a 4-digit personal identification number (PIN).

 **NOTE:** To print the job or to delete it, you must provide the PIN at the product control panel.

Receive notification when someone prints a stored job

 **NOTE:** Only the person who created the stored job receives notification. You do not receive notification when someone prints a stored job that another person has created.

1. On the **File** menu in the software program, click **Print**.
2. Select the product, and then click the **Properties** or **Preferences** button.
3. Click the **Job Storage** tab.
4. Select the job storage mode that you want.
5. In the **Job Notifications Options** area, click the **Display Job ID when printing** option.

Set the user name for a stored job

Follow this procedure to change the user name for a stored job.

1. On the **File** menu in the software program, click **Print**.
2. Select the product, and then click the **Properties** or **Preferences** button.
3. Click the **Job Storage** tab.
4. Select the job storage mode that you want.
5. In the **User Name** area, click the **User name** option to use the Windows default user name. To provide a different user name, click the **Custom** option and type the name.

Specify a name for the stored job

Follow this procedure to change the default name for a stored job.

1. On the **File** menu in the software program, click **Print**.
2. Select the product, and then click the **Properties** or **Preferences** button.

3. Click the **Job Storage** tab.
4. Select the job storage mode that you want.
5. To automatically generate the job name associated with the stored document, in the **Job Name** area, click the **Automatic** option. The driver uses the document file name, if it is available. If the document has no file name, the driver uses the software program name or a time stamp for the job name.

To specify a job name, click the **Custom** option and type the name.

6. Select an option from the **If job name exists** drop-down list.
 - Select the **Use Job Name + (1-99)** option to add a number to the end of the existing name.
 - Select the **Replace Existing File** option to overwrite a job that already has that name.

Print special jobs with Windows

Print business graphics or marketing material

You can use this product to print marketing and sales material or other color documents on glossy paper. To maximize the quality of this output you must do the following:

1. Choose the appropriate paper. See the following table.
2. At the product control panel, configure the paper tray for the correct paper type.
3. Select the corresponding settings in the printer driver.

Supported glossy paper

HP glossy paper product	Product code	Product size	Control panel and print driver settings
HP Laser Presentation Paper, Soft Gloss	Q6541A	Letter	HP soft gloss 120g
HP Laser Presentation Paper, Glossy	Q2546A	Letter	HP glossy 130g
HP Laser Presentation Paper, Glossy	Q2552A	A4	HP glossy 130g
HP Laser Professional Paper, Soft Gloss	Q6542A	A4	HP soft gloss 120g
HP Laser Brochure Paper, Glossy	Q6611A, Q6610A	Letter	HP glossy 160g
HP Laser Superior Paper, Glossy	Q6616A	A4	HP glossy 160g
HP Laser Photo Paper, Glossy	Q6607A, Q6608A	Letter	HP glossy 220g
HP Laser Photo Paper, Glossy	Q6614A	A4	HP glossy 220g

HP glossy paper product	Product code	Product size	Control panel and print driver settings
HP Laser Photo Paper, Glossy 4x6	Q8842A	101.6 x 152.4 mm (4 x 6 in)	HP glossy 220g
HP Laser Photo Paper, Glossy 10 cm x 15 cm	Q8843A	101.6 x 152.4 mm (4 x 6 in)	HP glossy 220g

 **NOTE:** In the United States, see www.hp.com/go/paper for a complete list of HP brand paper.

Print weatherproof maps and outdoor signs

The product can print durable, waterproof maps, signs, or menus by using HP Tough Paper. HP Tough Paper is a waterproof, tear-proof, satin finish paper that retains rich, vibrant print color and clarity even when exposed to heavy usage or weather. This avoids expensive and time-consuming lamination. To maximize the quality of this output you must do the following:

- Choose the appropriate paper. See the following table.
- At the product control panel, configure the paper tray for the correct paper type.
- Select the corresponding settings in the printer driver.

Supported tough paper

HP paper name	Product code	Product size	Control panel and print driver settings
HP LaserJet Tough Paper	Q1298A	Letter	HP Tough Paper
HP LaserJet Tough Paper	Q1298B	A4	HP Tough Paper

Set the duplex alignment

For documents that are printed on both sides, such as brochures, set the registration for the tray before printing to ensure that the front and back of the page are aligned.

1. From the Home screen, touch the [Administration](#) button.
2. Open the following menus:
 - a. [General Settings](#)
 - b. [Print Quality](#)
 - c. [Image Registration](#)
 - d. [Adjust Tray <X>](#)
3. Touch the [Print Test Page](#) setting, and then touch the [OK](#) button.
4. Follow the instructions on the test page to complete the adjustment.

Walk-up USB printing

This product features walk-up USB printing, so you can quickly print files without sending them from a computer. The product accepts standard USB storage accessories in the USB port on the front of the product. You can print the following types of files:

- .pdf
- .prn
- .pcl
- .ps
- .cht

1. Insert the USB storage accessory into the USB port on the front of the product.

NOTE: You might need to remove the cover from the USB port

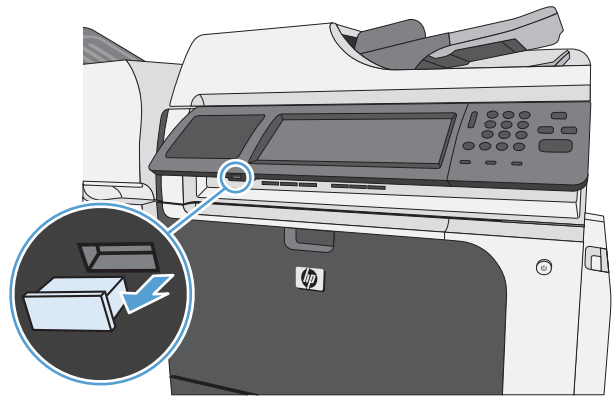

2. The **Open from USB** screen opens. Select a folder from the list on the left side of the screen.

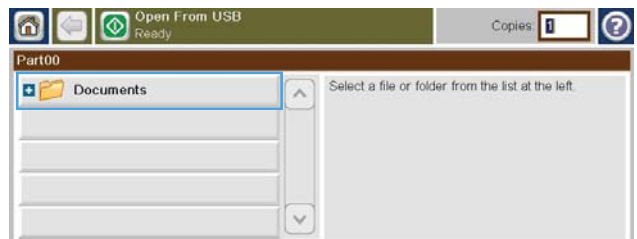

3. Select the name of the document that you want to print.

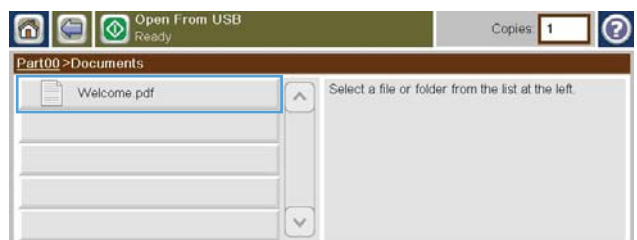

4. If you need to adjust the number of copies, touch the **Copies** field, and then use the keypad to select the number of copies.



5. Touch the Start  button to print the document.



9 Color

- [Adjust color](#)
- [Match colors](#)

Adjust color

Manage color by changing the settings on the **Color** tab in the printer driver.

Change the color theme for a print job

1. On the **File** menu in the software program, click **Print**.
2. Click **Properties** or **Preferences**.
3. Click the **Color** tab.
4. Select a color theme from the **Color Themes** drop-down list.
 - **Default (sRGB)**: This theme sets the product to print RGB data in raw device mode. When using this theme, manage color in the software program or in the operating system for correct rendering.
 - **Vivid**: The product increases the color saturation in the midtones. Use this theme when printing business graphics.
 - **Photo**: The product interprets RGB color as if it were printed as a photograph using a digital mini lab. The product renders deeper, more saturated colors differently than with the Default (sRGB) theme. Use this theme when printing photos.
 - **Photo (Adobe RGB 1998)**: Use this theme with printing digital photos that use the AdobeRGB color space rather than sRGB. Turn off color management in the software program when using this theme.
 - **None**: No color theme is used.

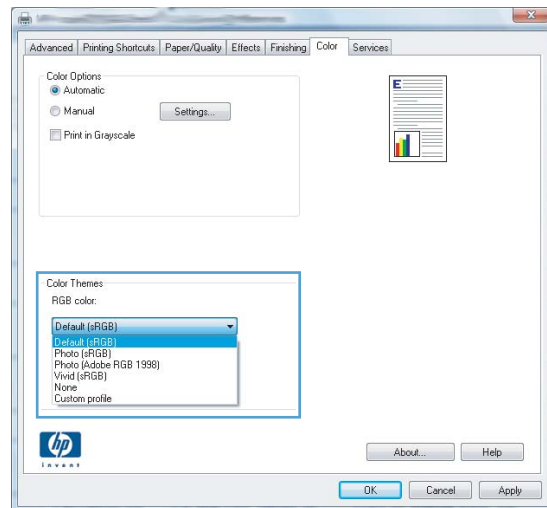

Change the color options

Change the color options settings for the current print job from the color tab of the printer driver.

1. On the **File** menu in the software program, click **Print**.
2. Click **Properties** or **Preferences**.
3. Click the **Color** tab.
4. Click the **Automatic** or **Manual** setting.
 - **Automatic** setting: Select this setting for most color print jobs
 - **Manual** setting: Select this setting to adjust the color settings independent from other settings.

 **NOTE:** Changing color settings manually can impact output. HP recommends that only color graphics experts change these settings.

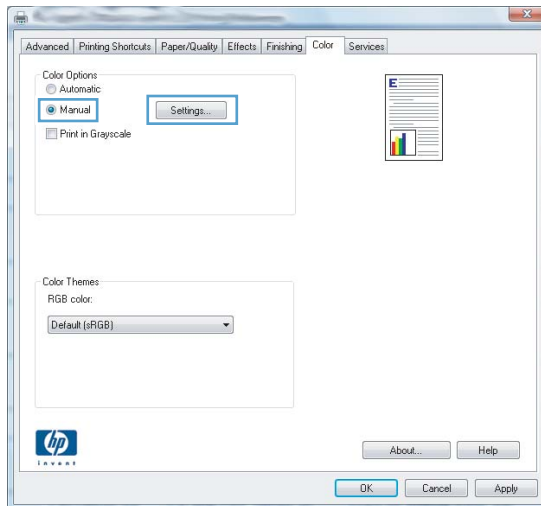

5. Click the **Print in Grayscale** option to print a color document in black and shades of gray. Use this option to print color documents for photocopying or faxing. You can also use this option to print draft copies or to save color toner.
6. Click the **OK** button.

Manual color options

Use manual color options to adjust the **Neutral Grays**, **Halftone**, and **Edge Control** options for text, graphics, and photographs.

Table 9-1 Manual color options

Setting description	Setting options
<p>Edge Control</p> <p>The Edge Control setting determines the rendering of edges. Edge control has two components: adaptive halftoning and trapping. Adaptive halftoning increases edge sharpness. Trapping reduces the effect of color-plane misregistration by overlapping the edges of adjacent objects slightly.</p>	<ul style="list-style-type: none">• Off turns off both trapping and adaptive halftoning.• Light sets trapping at a minimal level. Adaptive halftoning is on.• Normal sets trapping at a medium level. Adaptive halftoning is on.• Maximum is the most aggressive trapping setting. Adaptive halftoning is on.
<p>Halftone</p> <p>Halftone options affect color output clarity and resolution.</p>	<ul style="list-style-type: none">• Smooth provides better results for large, solid-filled print areas and enhances photographs by smoothing color gradations. Select this option when uniform and smooth area fills are important.• Detail is useful for text and graphics that require sharp distinctions among lines or colors, or images that contain a pattern or a high level of detail. Select this option when sharp edges and small details are important.
<p>Neutral Grays</p> <p>The Neutral Grays setting determines the method for creating gray colors used in text, graphics, and photographs.</p>	<ul style="list-style-type: none">• Black Only generates neutral colors (grays and black) by using only black toner. This guarantees neutral colors without a color cast. This setting is best for documents and grayscale viewgraphs.• 4-Color generates neutral colors (grays and black) by combining all four toner colors. This method produces smoother gradients and transitions to other colors, and it produces the darkest black.

Use the HP EasyColor option

If you are using the HP PCL 6 printer driver for Windows, the **HP EasyColor** technology automatically improves mixed-content documents that are printed from Microsoft Office programs. This technology scans documents and automatically adjusts photographic images in .JPEG or .PNG format.

HP EasyColor technology enhances the entire image at one time, rather than dividing it into several pieces, which results in improved color consistency, sharper details, and faster printing.

If you are using the HP Postscript printer driver for Mac, **HP EasyColor** technology scans all documents and automatically adjusts all photographic images with the same improved photographic results.

In the following example, the images on the left were created without using the **HP EasyColor** option. The images on the right show the enhancements that result from using the **HP EasyColor** option.



The **HP EasyColor** option is enabled by default in both the HP PCL 6 printer driver and the HP Mac Postscript printer driver, so you do not need to make manual color adjustments. To disable the option so you can manually adjust the color settings, open the **Color** tab in the Windows driver or the **Color/Quality Options** tab in the Mac driver, and then click the **HP EasyColor** check box to clear it.

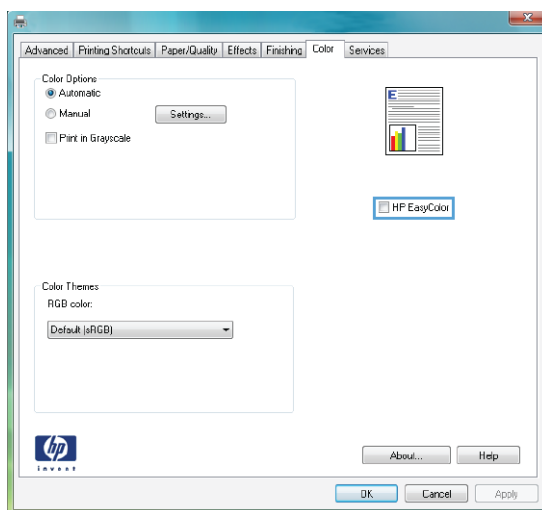

Match colors

The process of matching product output color to your computer screen is quite complex because printers and computer monitors use different methods of producing color. Monitors *display* colors by light pixels using an RGB (red, green, blue) color process, but printers *print* colors using a CMYK (cyan, magenta, yellow, and black) process.

Several factors can influence your ability to match printed colors to those on your monitor. These factors include:

- Paper
- Printer colorants (inks or toners for example)
- Printing process (inkjet, press, or laser technology for example)
- Overhead lighting
- Personal differences in perception of color
- Software programs
- Printer drivers
- Computer operating system
- Monitors and monitor settings
- Video cards and drivers
- Operating environment (humidity for example)

Keep the above factors in mind when colors on your screen do not perfectly match your printed colors.

For most users, the best method for matching colors on your screen to your product is to print sRGB colors.

Sample book color matching

The process for matching product output to preprinted sample books and standard color references is complex. In general, you can obtain a reasonably good match to a sample book if the inks used to create the sample book are cyan, magenta, yellow, and black. These are usually referred to as process color sample books.

Some sample books are created from spot colors. Spot colors are specially created colorants. Many of these spot colors are outside of the range of the product. Most spot color sample books have companion process sample books that provide CMYK approximations to the spot color.

Most process sample books will state which process standards were used to print the sample book. In most cases they will be SWOP, EURO, or DIC. To get optimal color matching to the process sample book, select the corresponding ink emulation from the product menu. If you cannot identify the process standard, use SWOP ink emulation.

Print color samples

To use the color samples, select the color sample that is the closest match to the desired color. Use the sample's color value in your software program to describe the object you wish to match. Colors may vary depending on paper type and the software program used. For more details on how to use the color samples, go to www.hp.com/support/cljcm4540mfp.

Use the following procedure to print color samples at the product using the control panel:

1. From the Home screen, open the following menus:
 - a. Administration
 - b. Reports
 - c. Other Pages
2. Select either the [Color Samples for RGB](#) or the [CMYK Values](#) option, and touch the [OK](#) button.

PANTONE® color matching

PANTONE has multiple color matching systems. PANTONE MATCHING SYSTEM® is very popular and uses solid inks to generate a wide range of color hues and tints. See www.hp.com/go/cljcm4540mfp_software for details on how to use PANTONE Colors with this product.

 **NOTE:** PANTONE Colors generated might not match PANTONE-identified standards. Consult current PANTONE Publications for accurate color.

10 Copy

- [Use copy functions](#)
- [Copy settings](#)
- [Copy a book](#)
- [Copy a photo](#)
- [Create a stored copy job](#)
- [Copy mixed-size originals](#)
- [Copy on both sides \(duplex\)](#)
- [Use Job Build mode](#)

Use copy functions

Copy

Use the scanner glass to make as many as 9999 copies of small, lightweight paper (less than 60 g/m² or 16 lb) or heavy paper (more than 105 g/m² or 28 lb). This includes paper such as receipts, newspaper clippings, photographs, old documents, worn documents, and books.

Use the document feeder to make as many as 9999 copies of a document that has up to 50 pages (depending on the thickness of the pages).

1. To copy from the scanner glass, place the original document face-down on the glass. Align the corner of the original with the upper-left corner of the glass.



2. To copy from the document feeder, place the document into the document feeder with the pages facing up.

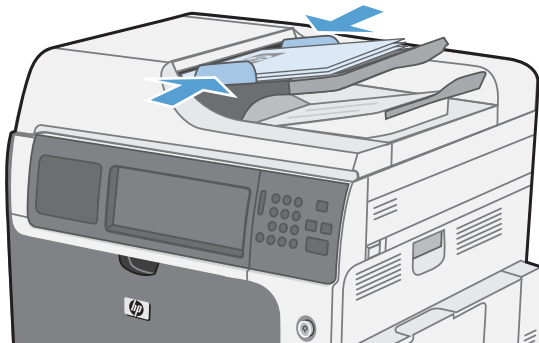

3. To make copies by using the default copy options, use the keypad on the control panel to select the number of copies, and touch the Start  button.

Cancel a copy job

1. Press the Stop  button on the control panel and then touch the name of the job.
2. Touch the **Cancel Job** button, and then touch the **OK** button.

Reduce or enlarge a copy image

1. From the Home screen, touch the **Copy** button.



2. Touch the **Reduce/Enlarge** button.

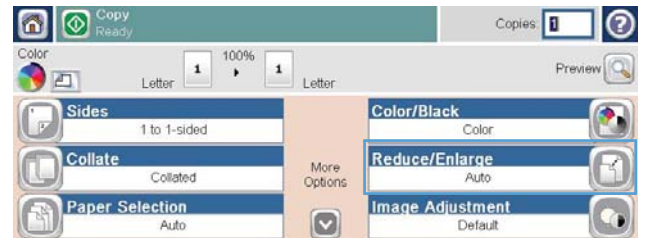

3. Select one of the predefined percentages, or touch the **Scaling** field and type a percentage between 25 and 400. Touch the **OK** button. You can also select these options:

- **Auto**: The product automatically scales the image to fit the paper size in the tray.
- **Auto Include Margins**: The product reduces the image slightly to fit the entire scanned image within the printable area on the page.

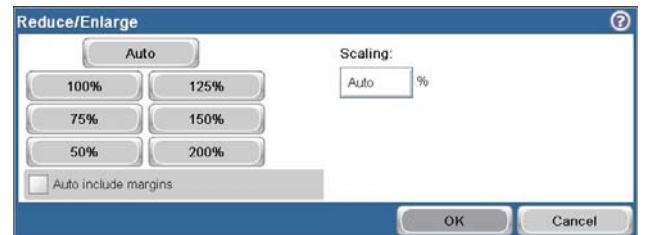

NOTE: To reduce the image, select a scaling percentage that is less than 100. To enlarge the image, select a scaling percentage that is greater than 100.

4. Touch the **Start** button.

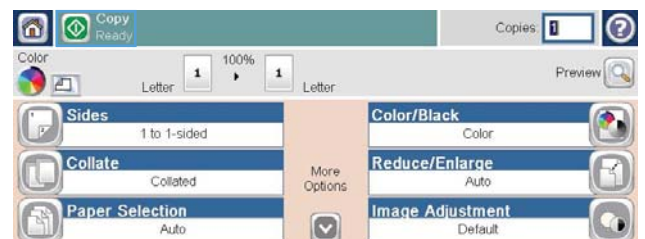

Collate a copy job

1. From the Home screen, touch the **Copy** button.



2. Touch the **Collate** button or the **Staple/Collate** button.

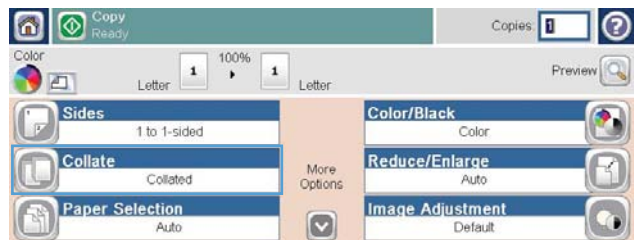

3. Touch the **Collate on (Sets in page order)** option.

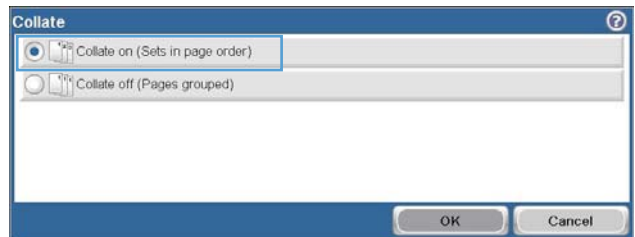

4. Touch the **Start** button.

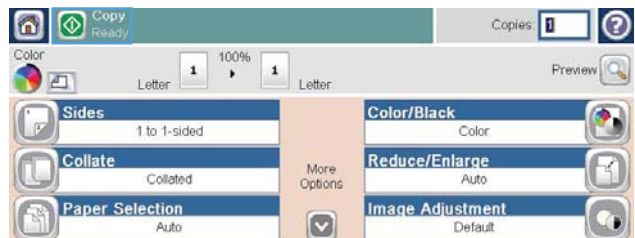

Make color copies or black and white copies

1. From the Home screen, touch the **Copy** button.

2. Touch the **Color/Black** button.

3. Select the color option that you want to use, and then touch the **OK** button.

Copy settings

Change copy quality

Optimize the copy image for text or pictures

1. From the Home screen, touch the **Copy** button.



2. Touch the **More Options** button, and then touch the **Optimize Text/Picture** button.

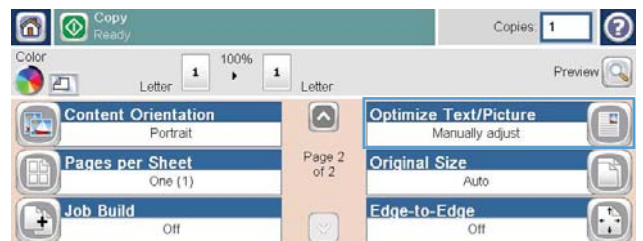

3. Select one of the predefined options, or touch the **Manually adjust** button and then adjust the slider in the **Optimize For** area. Touch the **OK** button.

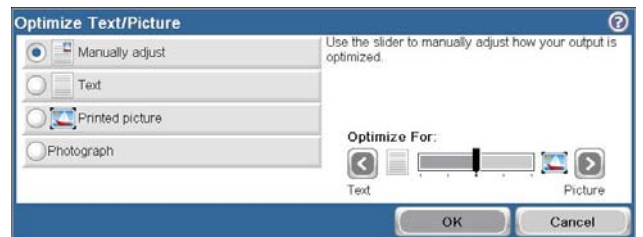

4. Touch the **Start** button.

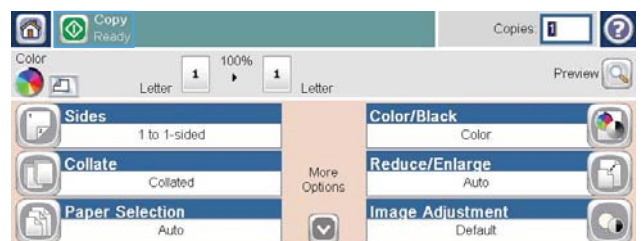

Check the scanner glass for dirt or smudges

Over time, specks of debris might collect on the scanner glass and white plastic backing, which can affect performance. Use the following procedure to clean the scanner glass and white plastic backing.

1. Use the power switch to turn off the product, and then unplug the power cord from the electrical socket.

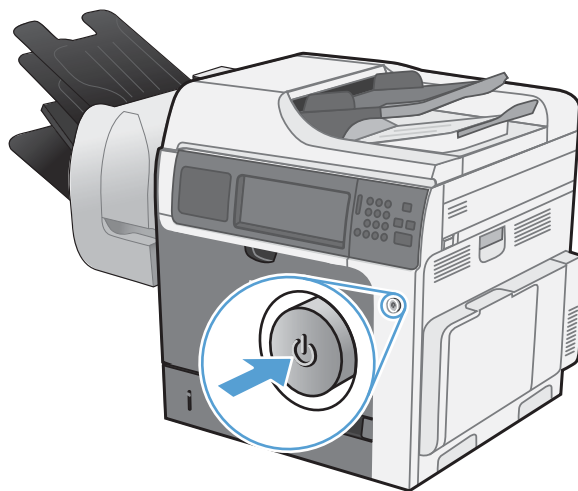

2. Open the scanner lid.

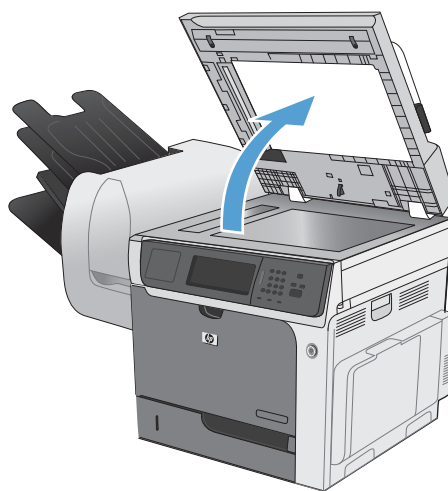

3. Clean the scanner glass and the white plastic backing with a soft cloth or sponge that has been moistened with nonabrasive glass cleaner. Dry the glass and white plastic backing with a chamois or a cellulose sponge to prevent spotting.

CAUTION: Do not use abrasives, acetone, benzene, ammonia, ethyl alcohol, or carbon tetrachloride on any part of the product; these can damage the product. Do not place liquids directly on the glass or platen. They might seep and damage the product.

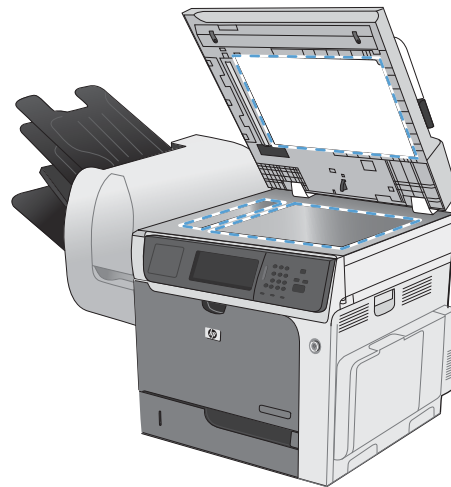

4. Plug in the product, and then use the power switch to turn on the product.

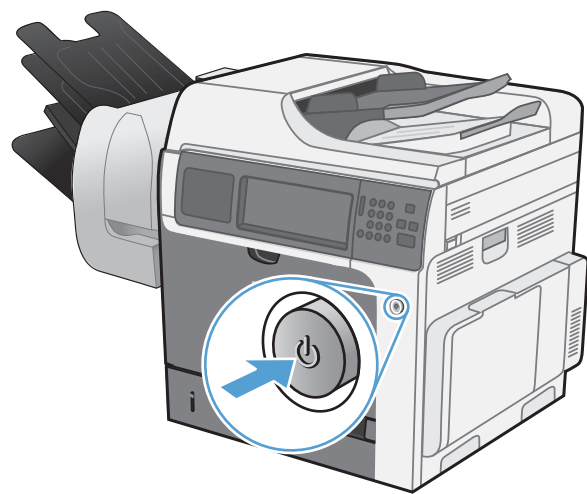

Adjust the copy lightness/darkness

1. From the Home screen, touch the **Copy** button.



2. Touch the **Image Adjustment** button.

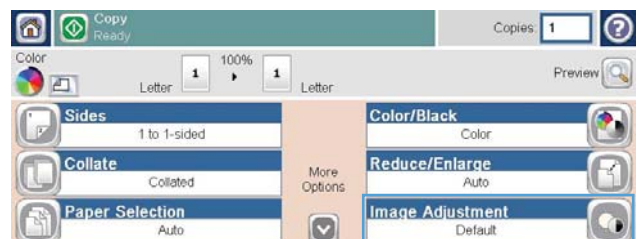

3. Adjust the sliders to set the **Darkness** level, the **Contrast**, the **Sharpness** level, and the **Background Cleanup** level. Touch the **OK** button.

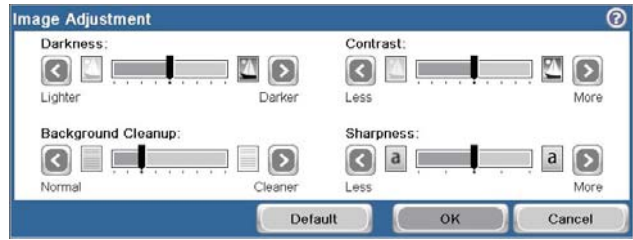

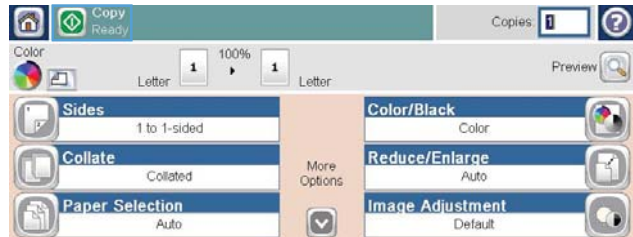

4. Touch the **Start** button.



Define custom copy settings

You can use the [Administration](#) menu to establish default settings that apply to all copy jobs. If necessary, you can override most settings for an individual job. After that job is complete, the product returns to the default settings.

1. From the Home screen, scroll to and touch the [Administration](#) menu.
2. Open the [Copy Settings](#) menu.
3. Several options are available. You can configure defaults for all options, or for only some options.

 **NOTE:** To learn about each menu option, touch the Help button  in the upper-right corner of the screen for that option.

Set the paper size and type for copying on special paper

1. From the Home screen, touch the [Copy](#) button.



2. Touch the [Paper Selection](#) button.

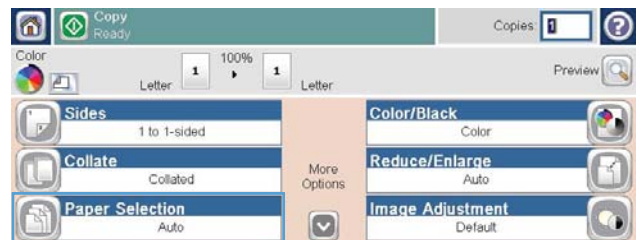

3. Select the tray that holds the paper that you want to use, and then touch the [OK](#) button.





Restore copy default settings

1. From the Home screen, open the following menus:
 - Administration
 - General Settings
 - Restore Factory Settings
2. Select the **Copy** check box, and then touch the **Reset** button.

Copy a book

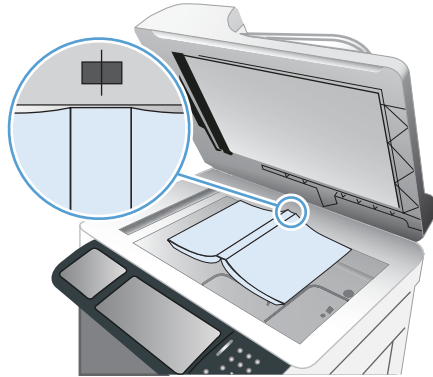
1. Lift the lid and place the book on the scanner glass with the spine aligned with the mark on the rear, center of the scanner glass.



2. Gently close the lid.
3. On the control panel, touch the **Copy** button.
4. Touch the Start  button.
5. Repeat these steps for each page that you want to copy.

 **NOTE:** This product does not have the capability to distinguish left and right pages. Assemble the copied pages carefully.

Copy a photo

 **NOTE:** Copy photos from the scanner glass.

1. Lift the lid and place the photo on the scanner glass with the picture-side down and the upper-left corner of the photo in the upper-left corner of the glass.





2. Gently close the lid.
3. On the control panel, touch the **Copy** button.
4. Touch the **Optimize Text/Picture** button, and select the **Photograph** button.
5. Touch the **Start**  button.

Create a stored copy job

Use this procedure to scan a document and save it on the product so you can print copies at any time.

1. Place the document face-down on the scanner glass or face-up in the document feeder.
2. From the Home screen, touch the [Save to Device Memory](#) button.

 **NOTE:** If prompted, type your user name and password.

3. Select an existing folder, or touch the [New Folder](#) button to create a new folder.
4. Type the name for the file in the [File Name](#) text field, and select the file type from the [File Type](#) drop-down list.
5. To configure settings for the document, touch the [More Options](#) button.
6. Touch the Start  button to save the file.

Copy mixed-size originals

You can copy original documents that are printed on different sizes of paper as long as the sheets of paper have one common dimension. For example, you could combine Letter and Legal sizes.

1. Arrange the sheets in the original document so they all have the same width.
2. Place the sheets face-up into the document feeder, and adjust both paper guides against the document.

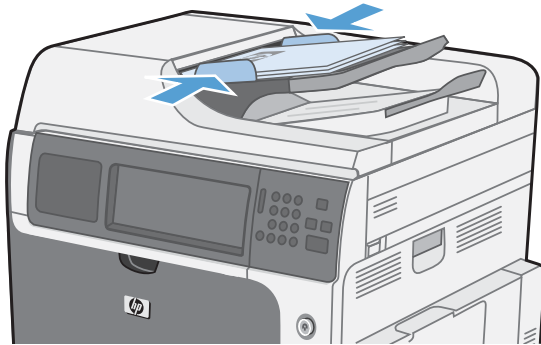

3. On the control panel, touch the **Copy** button.
4. Touch the **Original Size** button.

 **NOTE:** If this option is not on the first screen, touch the **More Options** button until the option displays.

5. Select the **Mixed Letter/Legal** button, and then touch the **OK** button.
6. Touch the Start  button.

Copy on both sides (duplex)

1. Load the original documents into the document feeder with the first page facing up, and with the top of the page leading.

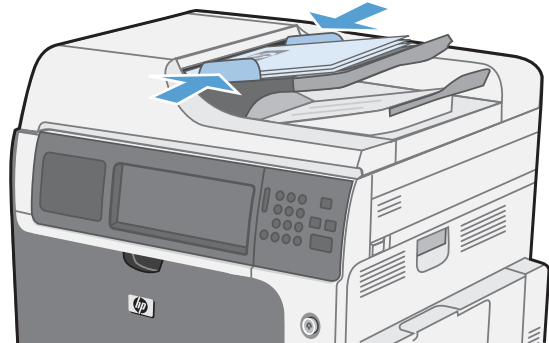

2. On the control panel, touch the **Copy** button.



3. Touch the **Sides** button.

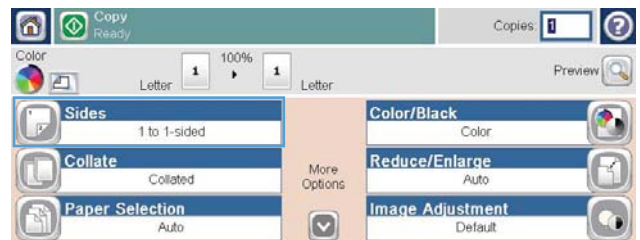

4. To make a two-sided copy from a one-sided original, touch the **1-sided original, 2-sided output** button.

To make a two-sided copy from a two-sided original, touch the **2-sided original, 2-sided output** button.

To make a one-sided copy from a two-sided original, touch the **2-sided original, 1-sided output** button.

Touch the **OK** button.

5. Touch the **Start** button.

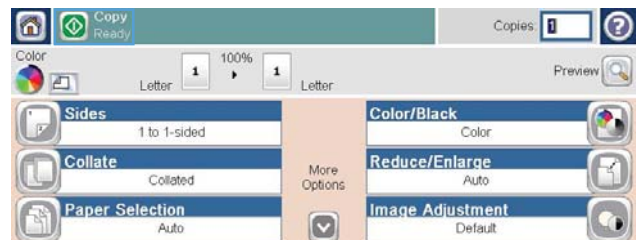
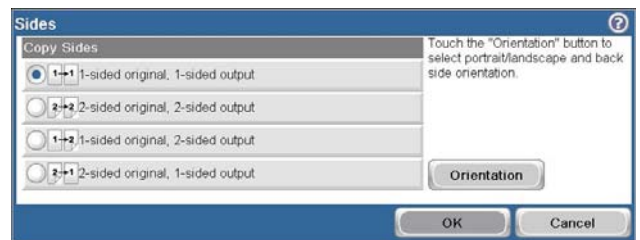

Use Job Build mode

Use the **Job Build** feature to combine several sets of original documents into one copy job. Also use this feature to copy an original document that has more pages than the document feeder can accommodate at one time.

1. Load the original document face-up in the document feeder or face-down on the scanner glass.
2. On the control panel, touch the **Copy** button.
3. Scroll to and touch the **Job Build** button.
4. Touch the **Job Build on** button.
5. Touch the **OK** button.
6. If necessary, select the desired copy options.
7. Touch the **Start**  button. After each page is scanned, the control panel prompts you for more pages.
8. If the job contains more pages, load the next page, and then touch the **Scan** button.

The product temporarily saves all the scanned images. Touch the **Finish** button to finish printing the copies.

11 Scan and send documents

- [Set up scan/send features](#)
- [Use scan/send functions](#)
- [Send a scanned document](#)

Set up scan/send features

The product offers the following scan and send features:

- Scan and save files to a folder on your network.
- Scan and save files to the product hard drive.
- Scan and save files to a USB flash drive.
- Scan and send documents to one or more e-mail addresses.

Some scan and send features are not available on the product control panel until you use the HP Embedded Web Server to enable them.

 **NOTE:** To find detailed information about using the HP Embedded Web Server, click the **Help** link in the upper-right corner of each HP Embedded Web Server page.

1. Open a Web page, and type the product IP address in the address line.
2. When the HP Embedded Web Server opens, click the **Scan/Digital Send** tab.
3. If you did not previously use the HP Scan to Email Setup Wizard to set up the **E-mail** feature, you can enable it by using the HP Embedded Web Server.
 - a. Click the **E-mail Setup** link.
 - b. Select the **E-mail** check box to enable the feature.
 - c. Select the outgoing mail server to use, or click the **Add** button to add a different server to the list.

 **NOTE:** If you don't know the name of the mail server, you can usually find it by opening your e-mail program and looking at the outgoing mail configuration settings.

- d. In the **Address and Message Field Control** area, configure the default setting for the From address.
 - e. Configuring the other settings is optional.
 - f. When you are finished, click the **Save Settings** button.
4. Enable the **Save to Network Folder** feature.
 - a. Click the **Save to Network Folder Setup** link.
 - b. Select the **Save to Network Folder** check box to enable the feature.
 - c. In the **Quick Sets** area, click the **Add** button.
 - d. On the next screen, provide a name and a description for the Quick Set and specify the location where you want the Quick Set to appear on the control panel. Click the **Next** button.
 - e. On the next screen, select the type of Quick Set folder to use, and then click the **Next** button.

Use scan/send functions

Sign in

Some features on the product control panel can be secured so that unauthorized people cannot use them. When a feature is secured, the product prompts you to sign in before you can use it. You can also sign in without waiting for a prompt by touching the **Sign In** button on the Home screen.

Typically, you use the same user name and password that you use to sign in to your computer on the network. Consult the network administrator for this product if you have questions about which credentials to use.

After you have signed in to the product a **Sign Out** button appears on the control panel. To maintain security for the product, touch the **Sign Out** button when you have finished using the product.

Change default scan/send settings from the product control panel

1. From the Home screen, scroll to and touch the **Administration** button.
2. Open the **Scan/Digital Send Settings** menu.
3. Select the category of scan and send settings that you want to configure.
4. Open the **Default Job Options** menu, and configure the options. Touch the **OK** button to save the settings.

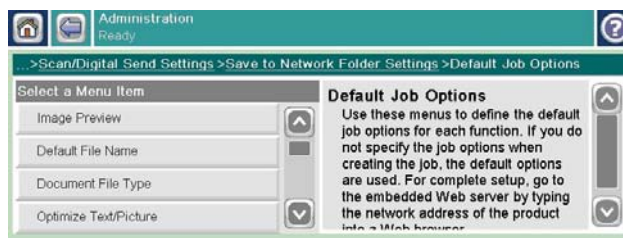
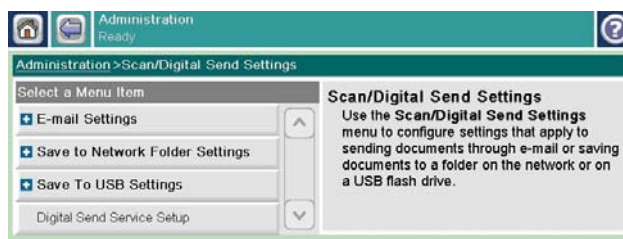
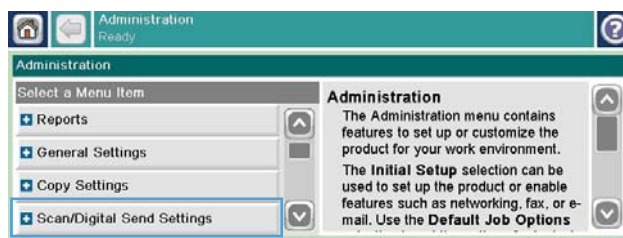

Send a scanned document

Send a scanned document to a network folder

The product can scan a file and save it in a folder on the network. The following operating systems support this feature:

- Windows Server 2003, 64-bit
- Windows Server 2008, 64-bit
- Windows XP, 64-bit
- Windows Vista, 64-bit
- Windows 7, 64-bit
- Novell v5.1 and later (access to the [Quick Sets](#) folders only)

 **NOTE:** You might be required to sign in to the product to use this feature.

The system administrator can use the HP Embedded Web Server to configure pre-defined [Quick Sets](#) folders, or you can provide the path to another network folder.

1. Place the document face-down on the scanner glass or face-up in the document feeder.

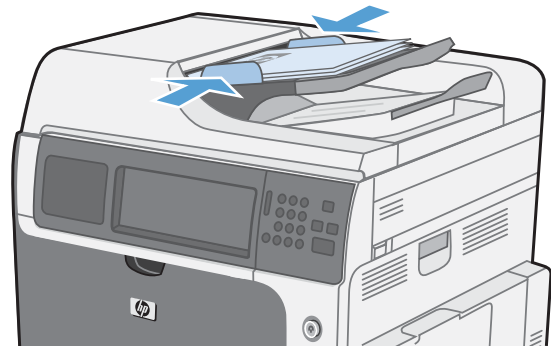

2. From the Home screen, touch the [Save to Network Folder](#) button.

NOTE: If prompted, type your user name and password.

3. To use one of the preset job settings, select one of the items in the [Quick Sets](#) list.

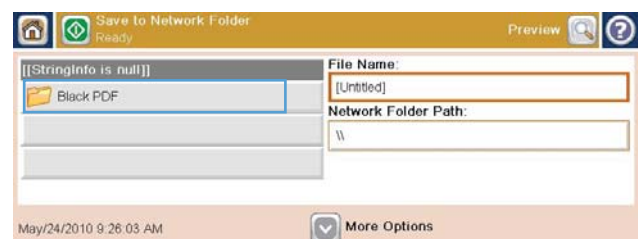

- To set up a new job, type the name for the file in the **File Name** text field, and type the path to the network folder in the **Network Folder Path** field. Use this format for the path:

\\path\path

- To configure settings for the document, touch the **More Options** button.

- Touch the Start  button to save the file.

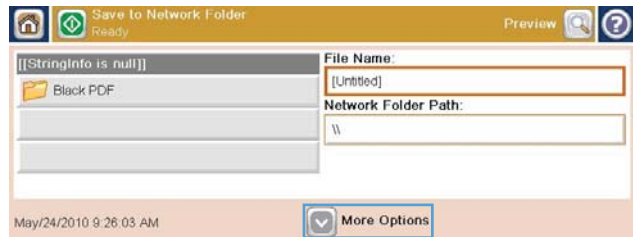
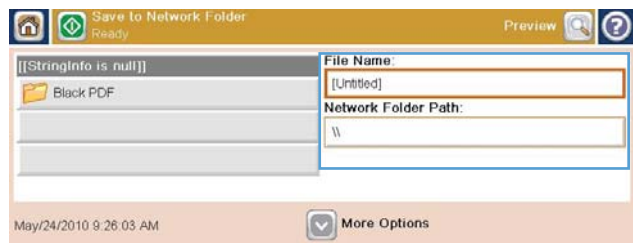

Send a scanned document to a folder in the product memory

Use this procedure to scan a document and save it on the product so you can print copies at any time.

- Place the document face-down on the scanner glass or face-up in the document feeder.

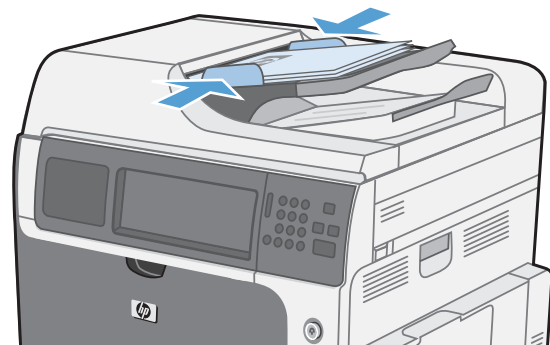

- From the Home screen, touch the **Save to Device Memory** button.

NOTE: If prompted, type your user name and password.



3. Select an existing folder, or touch the **New Folder** button to create a new folder.



4. Type the name for the file in the **File Name** text field.



5. To configure settings for the document, touch the **More Options** button.



6. Touch the **Start** button to save the file.



Send a scanned document to a USB flash drive

The product can scan a file and save it in a folder on a USB flash drive.

 **NOTE:** You might be required to sign in to the product to use this feature.

1. Place the document face-down on the scanner glass or face-up in the document feeder.

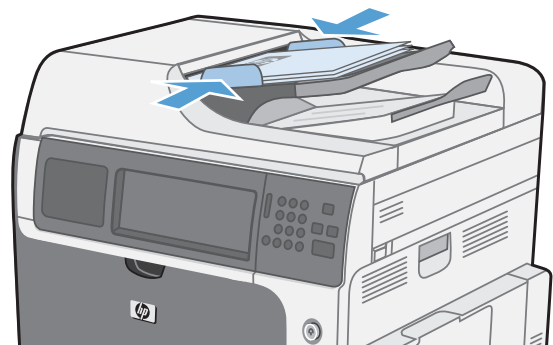

- From the Home screen, touch the **Save to USB** button.

NOTE: If prompted, type your user name and password.

- Select one of the folders in the list, or touch the **New Folder** button to create a new folder on the USB flash drive.

- Type the name for the file in the **File Name** text field, and select the file type from the **File Type** drop-down list.

- To configure settings for the document, touch the **More Options** button.

- Touch the Start button to save the file.

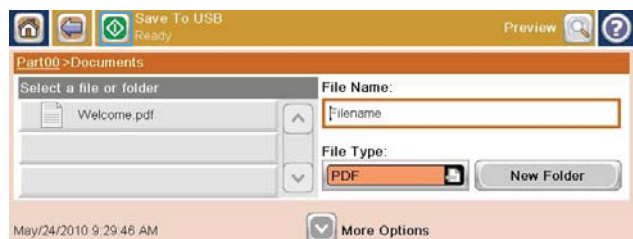
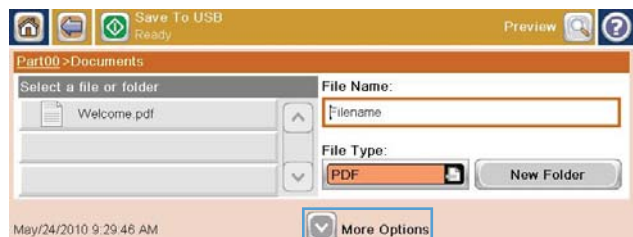
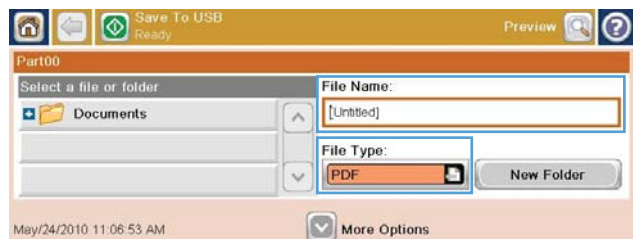
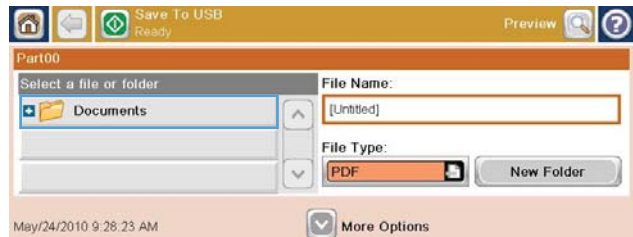

Send to e-mail

The product e-mail feature offers the following benefits:

- Sends documents to one or more e-mail addresses.
- Delivers files in black-and-white or in color.
- You can send files in different file formats that the recipient can manipulate.

In order to use the e-mail feature, the product needs to be connected to a valid SMTP local area network that includes Internet access.

Supported protocols

The product supports Simple Mail Transfer Protocol (SMTP) and Lightweight Directory Access Protocol (LDAP).

SMTP

- SMTP is a set of rules that define the interaction between programs that send and receive e-mail. In order for the product to send documents to e-mail, it must be connected to a LAN that has access to an e-mail server that supports SMTP.
- If you are using a LAN connection, contact your system administrator to obtain the IP address or host name for your SMTP server. If you are connecting through a DSL or cable connection, contact the internet service provider to obtain the SMTP server IP address.

LDAP

- LDAP is used to gain access to a database of information. When the product uses LDAP, it searches a global list of e-mail addresses. As you begin to type the e-mail address, LDAP uses an auto-complete feature that supplies a list of e-mail addresses that match the characters you type. As you type additional characters, the list of matching e-mail addresses becomes smaller.
- The product supports LDAP, but a connection to an LDAP server is not required in order for the product to be able to send to e-mail.

 **NOTE:** If you need to change the LDAP settings, you must change them by using the HP Embedded Web Server.

Configure e-mail server settings

Before you can send a document to e-mail, you must configure the product.

 **NOTE:** The instructions that follow are for configuring the product at the control panel. You can also perform these procedures by using the HP Embedded Web Server. Using the [E-mail Setup Wizard](#) menu is the simplest way to configure the e-mail settings.

NOTE: The e-mail icon is not shown on the control panel if e-mail is not configured.

1. From the Home screen, scroll to and touch the [Administration](#) menu.



- Open the **Scan/Digital Send Settings** menu.

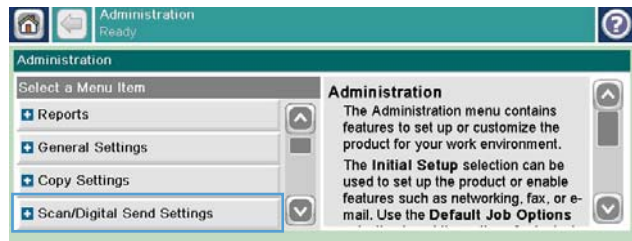

- Open the **E-mail Settings** menu.

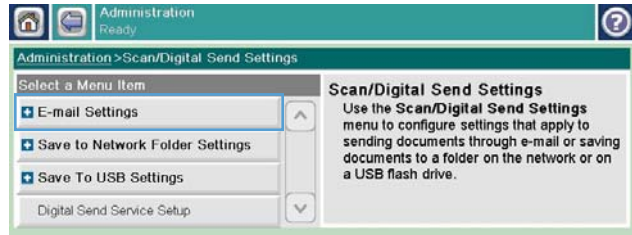

- Open the **E-mail Setup Wizard** menu, and follow the on-screen instructions.

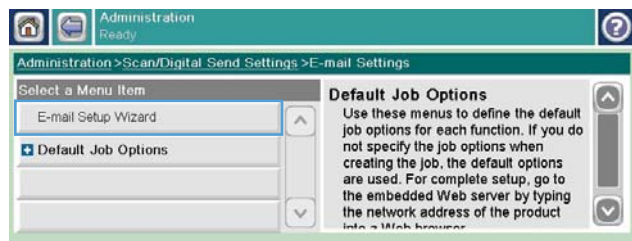

Send a scanned document to one or more e-mail addresses

- Place the document face-down on the scanner glass or face-up in the document feeder.

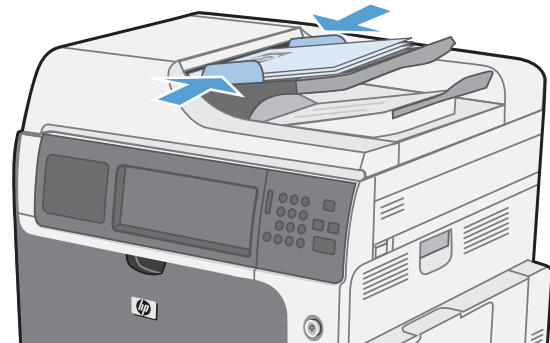

- From the Home screen, touch the **E-mail** button.

NOTE: If prompted, type your user name and password.



3. Touch the text box next a field to open a keypad.

NOTE: If you are signed in to the product, your user name or other default information might appear in the **From** field. If so, you might not be able to change it.



4. Type the appropriate information for the field. To send to multiple addresses, separate the addresses with a semicolon, or touch the Enter button on the touchscreen keypad after you type each address.



5. To change the settings for the document touch the **More Options** button.



6. If you are sending a two-sided document, select the **Original Sides** menu and select the **2-sided** option.

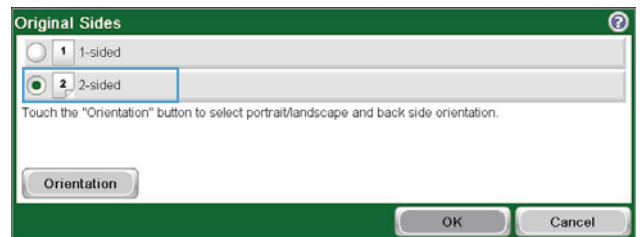

7. Touch the Start button to begin sending.

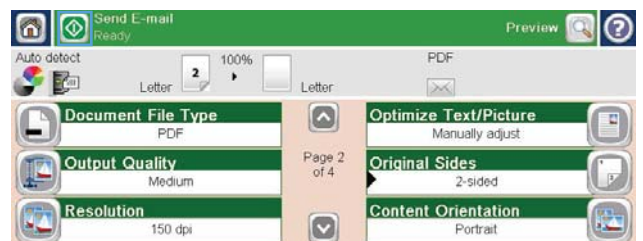

Use the address book

You can send e-mail to a list of recipients by using the address book. Depending on how the product is configured, you might have one or more of the following address book viewing options.

- **All Contacts:** Lists all the contacts that are available to you.
- **Personal Contacts:** Lists all the contacts that are associated with your user name. These contacts are not visible to other people who use the product.

 **NOTE:** You must be signed in to the product to see the **Personal Contacts** list.

- **Local Contacts:** Lists all the contacts that are stored in the product memory. These contacts are visible to all people who use the product.

Add contacts to the address book from the product control panel

If you are signed in to the product, contacts that you add to the address book will not be visible to other people who use the product.

If you are not signed in to the product, contacts that you add to the address book will be visible to all people who use the product.

 **NOTE:** You can also use the HP Embedded Web Server (EWS) to create and manage the address book.

1. From the Home screen, touch the **E-mail** button.

NOTE: If prompted, type your user name and password.

2. Touch the address book  button that is next to the **To** field to open the **Address Book** screen.

3. Touch the Add contact button  that is in the lower left corner of the screen.

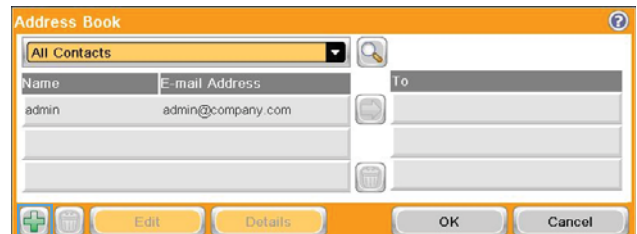

- In the **Name** text field, type the name of the contact.



- From the drop-down list, select the **E-mail Address** option, and then type the contact's e-mail address.

Touch the **OK** button to add the contact to the list.



Send a document to e-mail by using the address book

- Place the document face-down on the scanner glass or face-up in the document feeder.

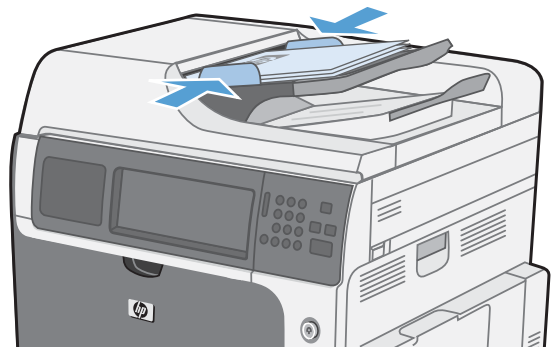

- From the Home screen, touch the **E-mail** button.

NOTE: If prompted, type your user name and password.



- Touch the address book  button that is next to the **To** field to open the **Address Book** screen.



4. From the drop-down list, select the address book view that you want to use.



5. Select a name from the list of contacts, and then touch the right arrow button to add the name to the recipients list.

Repeat this step for each recipient, and then touch the OK button.

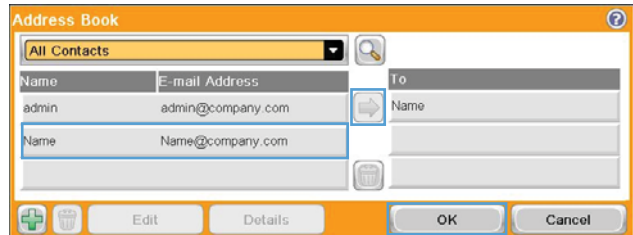

6. Touch the Start button to begin sending.

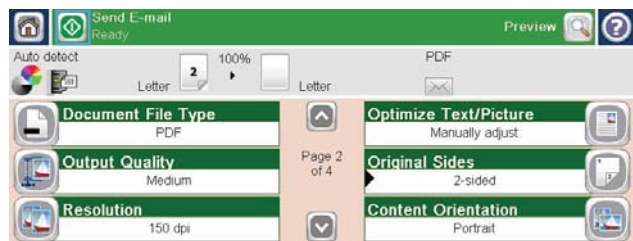

12 Fax

- [Setup](#)
- [Set fax settings](#)
- [Use Fax](#)
- [Solve fax problems](#)

Setup

Introduction

The HP LaserJet Analog Fax Accessory 500 enables the HP multifunction product (MFP) to function as a standalone analog fax machine. For more information, see www.hp.com/go/ljanalogfaxaccessory500_manuals.

NOTE: In addition to the analog fax feature, the product also supports LAN and internet faxing. Only one fax method can be enabled at a time.

NOTE: If the product came with the fax accessory installed, remove the fax connection cover, connect the phone cord, and then perform the initial fax configuration. The fax connection cover is located on the phone connector on the formatter rear panel.

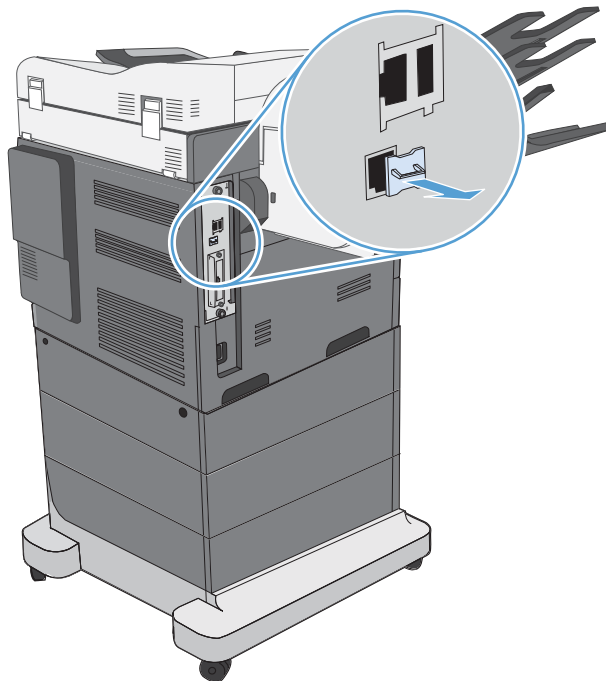

HP LaserJet Analog Fax Accessory 500 features

Send-fax features

- Speed dials
- Fax address book
- Resolution and image-adjustment options
- Billing codes

Receive-fax features	<ul style="list-style-type: none"> • Stamp received faxes • Block incoming faxes • Fax polling • Adjustable rings-to-answer
Advanced fax features	<ul style="list-style-type: none"> • Notification of fax status • JBIG compression • Error correction • Fax archive
Remote fax configuration	<ul style="list-style-type: none"> • Embedded Web server • HP Web Jetadmin • HP MFP Digital Sending Software
Security features	<ul style="list-style-type: none"> • Fax-printing schedule

Verify fax operation

When the fax accessory is installed and operating correctly, the fax icon displays on the product control panel. If the fax accessory has just been installed but has not been configured, the fax icon is grayed-out. If this occurs, use the instructions that follow to configure the fax accessory.

Required fax settings

After the fax accessory is installed, you must configure certain settings before you can use the accessory. If these settings are not configured, the fax icon is grayed-out. These settings include:

- [Country/region](#)
- [Date/Time](#)
- [Company Name](#)
- [Fax Number](#)
- [Dialing Prefix](#) (optional)

This information is used in the fax header, which is printed on all outgoing faxes.

 **NOTE:** When first installed, the fax accessory might read some of these settings from the product; therefore, a value may already be set. You should check the values to verify that they are set and correct.

NOTE: In the U.S. and many other countries/regions, setting the date, time, country/region, phone number, and company name is a legal requirement for fax.

Fax Setup Wizard

The Fax Setup Wizard guides you through a step-by-step procedure to configure fax settings that are required to use the fax feature. If the settings are not configured, the fax feature is disabled.

The first time the product is turned on with a fax accessory installed, access the Fax Setup Wizard by following these steps:

1. From the Home screen, touch the [Initial Setup](#) button.
2. Touch the [Fax Setup Wizard](#) menu.
3. Follow the steps in the Fax Setup Wizard to configure the required settings.
4. When the Fax Setup Wizard finishes, the option to hide the [Initial Setup](#) button appears on the Home screen.

Access the Fax Setup Wizard *after* initial setup through the control panel by following these steps:

1. From the Home screen, scroll to and touch the [Administration](#) button.
2. Open the following menus:
 - [Fax Settings](#)
 - [Fax Send Settings](#)
 - [Fax Send Setup](#)
 - [Fax Setup Wizard](#)

Follow these steps to configure the required fax settings using the Fax Setup Wizard:

1. Touch your country/region on the first screen of the Fax Setup Wizard and then touch the [Next](#) button.
2. Touch the date and time boxes to enter the date/time, and then touch the [Next](#) button.
3. Touch the [Company Name](#) and [Fax Number](#) boxes to enter your company name and fax number, and then touch the [Next](#) button.
4. Touch the [Dialing Prefix](#) box to enter your dialing prefix, if required, and then touch the [Next](#) button.
5. Confirm your fax configuration settings on the final screen of the Fax Setup Wizard. Touch the [Finish](#) button to complete the Fax Setup Wizard.

-or-

Touch the [Back](#) button to move back through the Fax Setup Wizard screens and make changes to your configuration entries.

 **NOTE:** The settings configured using the Fax Setup Wizard on the control panel override any settings made in the embedded Web server.

NOTE: If the [Fax Setup](#) menu settings does not appear in the menu listing, LAN or internet fax might be enabled. When LAN or internet fax is enabled, the analog fax accessory is disabled and the fax menu does not display. Only one fax feature, either LAN fax, analog fax or internet fax, can be enabled at a time. The fax icon displays for either fax feature. If you wish to use analog fax when LAN fax is enabled, use the HP MFP Digital Sending Software Configuration Utility or the product embedded Web server to disable LAN fax.

Set or verify the date and time

The date and time setting for the fax accessory is the same value as the product date and time setting. This information can be entered using the Fax Setup Wizard, or by following these steps:

1. From the Home screen, scroll to and touch the [Administration](#) button.
2. Open the following menus:
 - [General Settings](#)
 - [Date/Time Settings](#)
 - [Date/Time](#)
3. Touch the correct [Time Zone](#) setting for your locale.
4. Touch the [Month](#) drop down menu and select a month.
5. Touch the boxes next to the [Date](#) drop down menu to enter the day and year from the keypad.
6. Touch the boxes below the [Time](#) heading to enter the hour and minutes from the keypad and then touch the [AM](#) or [PM](#) button.
7. Touch the [Adjust for Daylight Savings](#) feature, if necessary.
8. Touch the [Save](#) button to save the settings.

Set or verify the date/time format

The date and time format setting for the fax accessory is in the same format as the product date and time setting. This information can be entered using the Fax Setup Wizard, or by following these steps:

1. From the Home screen, scroll to and touch the [Administration](#) button.
2. Open the following menus:
 - [General Settings](#)
 - [Date/Time Settings](#)
 - [Date/Time Format](#)
3. Touch a [Date Format](#) option.
4. Touch a [Time Format](#) option.
5. Touch the [Save](#) button to save the settings.

Set fax settings

Remote fax configuration

In addition to using the product control panel, you can configure the fax accessory remotely by using various software tools. Because the product contains an embedded Web server (EWS), you can configure the fax accessory across the Web by using either a Web browser or HP Web Jetadmin (WJA). In addition, you can configure the fax accessory across the network with a network-connected computer by using the HP MFP Digital Sending Software Configuration Utility (DSS). These tools provide access to most of the fax accessory configuration settings that available from the product fax menu.

Web browser

The product contains an embedded Web server (EWS). The EWS allows you to use a Web browser to access and set the analog-fax settings.

1. Type the IP address of the product in the browser URL address bar and press **Enter** to open the EWS Configure product screen. To get the IP address of the product, print a product Configuration page.

 **NOTE:** If DSS is being used, a message appears on EWS indicating that DSS is in control. The only way to change settings is through DSS.

2. Click the **Fax** tab. The **Fax Send Setup** screen displays.
3. On the **Fax Send Setup** screen, click Enable Fax Send to enable the fax. Make any changes to the common job settings and to the specific settings for the type of fax being used, and then click the **Apply** button to accept the settings.

HP Web Jetadmin

To access the product analog-fax settings by using HP Web Jetadmin, perform the following steps. For detailed information about HP Web Jetadmin, see the **HP Web Jetadmin Reference Manual**.

1. Start HP Web Jetadmin.
2. In the **At a Glance** text box, type the IP address of the product in the **Quick Device Find** text box, and then click the **Go** button to see the device status in the right pane. Select **Digital Sending and Fax** from the status drop-down menu in that pane.
3. Configure the options in the **Fax Settings** section or the **Advanced Fax Settings** section. For information about a specific setting, select the context help next to the setting.
4. After you have made changes to the settings, click the **Apply** button to accept the settings.

In addition to configuring a single product, you can also perform multiple device configuration. Multiple device mode configures several products at once. For information about this feature, see the **Web Jetadmin User Guide** available under the **Self Help and Documentation** tab at www.hp.com/go/webjetadmin.

HP MFP Digital Sending Software Configuration Utility

To access the analog MFP fax settings by using the DSS configuration utility, perform the following steps.

1. Start the utility (on the computer or server) to open the main screen.
2. Select the product and click the **Configure MFP** button on the main screen, and then click the Send to Fax tab to open the Fax Settings screen.
3. To enable the fax capabilities on the product, select the **Enable Fax Send** option. To access Analog-fax settings, select **Internal Modem** in the **Fax Send Method** drop-down list. On the **Common Job Settings** tab, make any changes to the settings and click the **Apply** button to accept the settings. Select the **Internal Modem** tab to set additional fax settings.

In addition to configuring a single product, you can also configure multiple devices. For more information about the HP MFP Digital Sending Software Configuration Utility, see the **HP MFP Digital Sending Software User Guide** or the **HP MFP Digital Sending Software Support Guide**.

 **NOTE:** Depending on the capabilities and settings of your fax method, some of these options might not be available or configurable.

Send fax settings

Fax send setup

Use the [Fax Send Setup](#) menu to configure the following features:

- Fax Setup Wizard
- Fax Dialing Settings
- General Fax Send Settings
- Billing Codes

Fax Setup Wizard

The Fax Setup Wizard guides you through a step-by-step procedure to configure fax settings that are required to use the fax feature. If the settings are not configured, the fax feature is disabled.

The first time the product is turned on with a fax accessory installed, access the fax setup wizard by following these steps:

1. From the Home screen, touch the [Initial Setup](#) button.
2. Touch the [Fax Setup Wizard](#) menu.
3. Follow the steps in the Fax Setup Wizard to configure the required settings.
4. When the Fax Setup Wizard finishes, the option to hide the [Initial Setup](#) button appears on the Home screen.

Access the Fax Setup Wizard *after* initial setup through the control panel by following these steps:

1. From the Home screen, scroll to and touch the [Administration](#) button.
2. Open the following menus:
 - [Fax Settings](#)
 - [Fax Send Settings](#)
 - [Fax Send Setup](#)
 - [Fax Setup Wizard](#)

Follow these steps to configure the required fax settings using the Fax Setup Wizard:

1. Touch your country/region on the first screen of the Fax Setup Wizard and then touch the [Next](#) button.
2. Touch the date and time boxes to enter the date/time, and then touch the [Next](#) button.
3. Touch the [Company Name](#) and [Fax Number](#) boxes to enter your company name and fax number, and then touch the [Next](#) button.
4. Touch the [Dialing Prefix](#) box to enter your dialing prefix, if required, and then touch the [Next](#) button.
5. Confirm your fax configuration settings on the final screen of the Fax Setup Wizard. Touch the [Finish](#) button to complete the Fax Setup Wizard.

-or-

Touch the [Back](#) button to move back through the Fax Setup Wizard screens and make changes to your configuration entries.

 **NOTE:** The settings configured using the Fax Setup Wizard on the control panel override any settings made in the embedded Web server.

NOTE: If the [Fax Setup](#) menu settings does not appear in the menu listing, LAN fax might be enabled. When LAN fax is enabled, the analog fax accessory is disabled and the fax menu does not display. Only one fax feature, either LAN fax, analog fax or internet fax, can be enabled at a time. The fax icon displays for either fax feature. If you wish to use analog fax when LAN fax is enabled, use the HP MFP Digital Sending Software Configuration Utility to disable LAN fax.

Fax dialing settings

Set the fax dial volume

Use the [Fax Dial Volume](#) setting to control the product's dialing volume level when sending faxes.

1. From the Home screen, scroll to and touch the [Administration](#) button.
2. Open the following menus:
 - [Fax Settings](#)
 - [Fax Send Settings](#)
 - [Fax Send Setup](#)
 - [Fax Dialing Settings](#)
3. Touch the [Fax Dial Volume](#) drop-down menu and select one of the following settings:
 - [Off](#)
 - [Low](#) (default)
 - [High](#)
4. Touch the [Save](#) button to save the fax volume setting.

Set the dialing mode

The dialing mode setting sets the type of dialing that is used: either tone (touch-tone phones) or pulse (rotary-dial phones).

To set the dialing mode, perform the following steps.

1. From the Home screen, scroll to and touch the [Administration](#) button.
2. Open the following menus:
 - [Fax Settings](#)
 - [Fax Send Settings](#)
 - [Fax Send Setup](#)
 - [Fax Dialing Settings](#)
3. Touch the [Dialing Mode](#) drop down menu and select either the [Tone](#) option (default) or [Pulse](#) option to set the fax dialing mode.
4. Touch the [Save](#) button.

Set fax send speed

The Fax send speed setting sets the modem bit rate (measured in bits per second) of the Analog Fax modem while sending a fax.

1. From the Home screen, scroll to and touch the [Administration](#) button.
2. Open the following menus:
 - [Fax Settings](#)
 - [Fax Send Settings](#)
 - [Fax Send Setup](#)
 - [Fax Dialing Settings](#)
3. Touch the drop down menu under the [Fax Send Speed](#) heading and then touch one of the following:
 - [Fast](#) (default) — 33600 bps (bits per second)
 - [Medium](#) — 14400 bps
 - [Slow](#) — 9600 bps
4. Touch the [Save](#) button.

Set the redial interval

The redial interval setting selects the number of minutes between retries if the number dialed is busy or not answering.

 **NOTE:** You might observe a redial message on the control panel when both the **Redial-on-Busy** and **Redial-on-No-Answer** settings are set to off. This occurs when the fax accessory dials a number, establishes a connection, and then loses the connection. As a result of this error condition, the fax accessory performs two automatic redial attempts regardless of the redial settings (the first one at 26,400 bps and, if that fails, a second one at 14,400 bps). During this redial operation, a message appears on the control panel to indicate that a redial is in progress.

1. From the Home screen, scroll to and touch the [Administration](#) button.
2. Open the following menus:
 - [Fax Settings](#)
 - [Fax Send Settings](#)
 - [Fax Send Setup](#)
 - [Fax Dialing Settings](#)
3. Touch the [Redial Interval](#) text box to display the keypad.
4. Enter the value (1–5, default is 5) and touch the [OK](#) button.
5. Touch the [Save](#) button.

Set redial on error

The **Redial on error** feature sets the number of times a fax number will be redialed when an error occurs during a fax transmission.

1. From the Home screen, scroll to and touch the **Administration** button.
2. Open the following menus:
 - **Fax Settings**
 - **Fax Send Settings**
 - **Fax Send Setup**
 - **Fax Dialing Settings**
3. Touch the **Redial on error** box to open the keypad.
4. Enter a value (0–9, default is 2) and then touch the **OK** button.
5. Touch the **Save** button.

Set redial-on-busy

The redial-on-busy setting selects the number of times (0 through 9) the fax accessory redials a number when the number is busy. The interval between retries is set by the Redial Interval setting.

1. From the Home screen, scroll to and touch the **Administration** button.
2. Open the following menus:
 - **Fax Settings**
 - **Fax Send Settings**
 - **Fax Send Setup**
 - **Fax Dialing Settings**
3. Touch the **Redial On Busy** text box to display the keypad.
4. Enter a value (0–9, default is 3) and then touch the **OK** button.
5. Touch the **Save** button.

Set redial-on-no-answer

The redial-on-no-answer setting selects the number of times the fax accessory redials if the number dialed does not answer. The number of retries is either 0 to 1 (used in the U.S.) or 0 to 2, depending on the country/region setting. The interval between retries is set by the redial interval setting.

1. From the Home screen, scroll to and touch the [Administration](#) button.
2. Open the following menus:
 - [Fax Settings](#)
 - [Fax Send Settings](#)
 - [Fax Send Setup](#)
 - [Fax Dialing Settings](#)
3. Touch the [Redial On No Answer](#) text box to display the keypad.
4. Enter a value (0–2, default is 0) and then touch the [OK](#) button.
5. Touch the [Save](#) button.

Set the dial tone detection

The detect dial tone setting determines whether the fax checks for a dial tone before sending a fax.

1. From the Home screen, scroll to and touch the [Administration](#) button.
2. Open the following menus:
 - [Fax Settings](#)
 - [Fax Send Settings](#)
 - [Fax Send Setup](#)
 - [Fax Dialing Settings](#)
3. Touch the [Detect Dial Tone](#) setting; a checkmark appears next to the [Detect Dial Tone](#) setting when selected. The default setting is unchecked (disabled).
4. Touch the [Save](#) button to enable dial tone detection.

Set a dialing prefix (if required)

The dialing prefix setting allows you to enter a prefix number (such as a "9" to access an outside line) when dialing. This prefix number is automatically added to all phone numbers when dialed.

 **NOTE:** You might need a pause between the prefix and the phone number. To insert a 2-second pause, enter a comma (,), pound sign (#), or a "P". To add an extension number, use "X".

1. From the Home screen, scroll to and touch the [Administration](#) button.
2. Open the following menus:
 - [Fax Settings](#)
 - [Fax Send Settings](#)
 - [Fax Send Setup](#)
 - [Fax Dialing Settings](#)
3. Touch the [Dialing Prefix](#) text box to display the keypad.
4. Type your dialing prefix number on the keypad and then touch the [OK](#) button.
5. Touch the [Save](#) button.

General fax send settings

Use the [General Fax Send Settings](#) menu to configure the following features:

- Fax Number Confirmation
- PC Fax Send
- Fax Header
- JBIG Compression
- Error Correction Mode

Activate Fax Number Confirmation

When fax number confirmation is enabled, the fax number must be entered twice to ensure that it was entered correctly. The default setting for this feature is [Disabled](#).

1. From the Home screen, scroll to and touch the [Administration](#) button.
2. Open the following menus:
 - [Fax Settings](#)
 - [Fax Send Settings](#)
 - [Fax Send Setup](#)
 - [General Fax Send Settings](#)
3. Touch the [Fax Number Confirmation](#) box to enable fax number confirmation.
4. Touch the [Save](#) button.

Enable PC fax send

Use the PC fax send feature to send faxes from a PC. This feature is enabled by default. If this feature is disabled, use the following steps to enable:

 **NOTE:** The PC fax send driver must be installed on the computer from where the faxes will be sent.

1. From the Home screen, scroll to and touch the [Administration](#) button.
2. Open the following menus:
 - [Fax Settings](#)
 - [Fax Send Settings](#)
 - [Fax Send Setup](#)
 - [General Fax Send Settings](#)
3. Touch the [PC Fax Send](#) box.
4. Touch the [Save](#) button.

Fax header

Use the fax header feature to control whether the header is appended to the top, and content is shifted down, or if the header is overlaid on top of the fax image.

1. From the Home screen, scroll to and touch the [Administration](#) button.
2. Open the following menus:
 - [Fax Settings](#)
 - [Fax Send Settings](#)
 - [Fax Send Setup](#)
 - [General Fax Send Settings](#)
3. Touch the [Prepend](#) (default) or [Overlay](#) option in the [Fax Header](#) section to orientate the fax header.
4. Touch the [Save](#) button.

Set the JBIG compression mode

Enabling JBIG compression can reduce phone-call charges by reducing fax transmission time and is, therefore, the preferred setting. However, JBIG might cause compatibility problems when communicating with some older fax machines, in which case you might need to disable it.

 **NOTE:** JBIG compression only works when both the sending and receiving machines have JBIG compression.

To enable or disable JBIG compression, perform the following steps.

1. From the Home screen, scroll to and touch the [Administration](#) button.
2. Open the following menus:
 - [Fax Settings](#)
 - [Fax Send Settings](#)
 - [Fax Send Setup](#)
 - [General Fax Send Settings](#)
3. Touch the [JBIG Compression](#) feature (default) to enable JBIG compression.
4. Touch the [Save](#) button.

Set the error correction mode

Normally, the fax accessory monitors the signals on the telephone line while it is sending or receiving a fax. If the fax accessory detects an error during the transmission and the error correction setting is on, the fax accessory can request that the error portion of the fax be sent again.

Error correction mode is enabled by default. You should turn off error correction only if you are having trouble sending or receiving a fax and if you are willing to accept the errors in the transmission and a probable quality reduction in the image. Turning off the setting might be useful when you are trying to send a fax overseas or receive one from overseas, or if you are using a satellite telephone connection.

 **NOTE:** Some VOIP providers may suggest turning error correction mode off. However, this is not usually necessary.

If error correction mode is disabled, follow these steps to enable:

1. From the Home screen, scroll to and touch the [Administration](#) button
2. Open the following menus:
 - [Fax Settings](#)
 - [Fax Send Settings](#)
 - [Fax Send Setup](#)
 - [General Fax Send Settings](#)
3. Touch the [Error Correction Mode](#) check box to enable error correction mode if it is disabled (unchecked).
4. Touch the [Save](#) button.

Set billing codes

The billing-code setting, when enabled, prompts the user to enter a number when sending a fax. This number is placed in the billing-code report. To view the billing-code report, either print the report or query it by using an application.

Billing codes are disabled by default. Follow these steps to enable billing codes:

1. From the Home screen, scroll to and touch the [Administration](#) button.
2. Open the following menus:
 - [Fax Settings](#)
 - [Fax Send Settings](#)
 - [Fax Send Setup](#)
 - [Billing Codes](#)
3. Touch the [Enable Billing Codes](#) feature to enable billing codes.

 **NOTE:** To disable billing codes, deselect the [Enable Billing Codes](#) feature, touch the [Save](#) button, and then skip the remaining steps.

To allow users to edit billing codes, touch the [Allow users to edit billing codes](#) feature.

4. Touch the [Default Billing Code](#) text box to open the keyboard.
5. Enter the billing code and then touch the [OK](#) button.
6. Touch the [Minimum Length](#) text box to open the keypad.
7. Type the minimum number of digits you want in the billing code, and then touch the [OK](#) button.
8. Touch the [Save](#) button.

Default job options

The following default job options are available for configuration:

- Image Preview
- Resolution
- Original Sides
- Notification
- Content Orientation
- Original Size
- Image Adjustment
- Optimize Text/Picture
- Job Build
- Blank Page Suppression

 **NOTE:** Default job option settings are shared across all fax methods; analog, LAN, and internet fax.

Image preview

1. From the Home screen, scroll to and touch the [Administration](#) button.
2. Open the following menus:
 - [Fax Settings](#)
 - [Fax Send Settings](#)
 - [Default Job Options](#)
 - [Image Preview](#)
3. The following option is available:
 - [Disable preview](#)
4. Touch the [Save](#) button.

Set the outgoing fax resolution

The outgoing fax resolution setting determines the maximum resolution supported by the receiving fax. The fax accessory uses the highest possible resolution (as limited by this setting) and the maximum resolution of the receiving fax.

 **NOTE:** Faxes wider than 21.25 cm (8.5 inches) are automatically sent by using standard or fine resolution, to reduce phone time.

NOTE: The default resolution setting is a lower dpi than previous product model default resolution settings. For example, previous product models had a default resolution of FINE (200 x 200 dpi).

NOTE: The higher the resolution, the longer the transmission time required.

NOTE: LAN fax settings resolution settings vary by vendor and may differ from the settings listed below.

1. From the Home screen, scroll to and touch the [Administration](#) button.
2. Open the following menus:
 - [Fax Settings](#)
 - [Fax Send Settings](#)
 - [Default Job Options](#)
 - [Resolution](#)
3. Touch one of the following resolution settings:
 - [Standard \(100 x 200dpi\)](#) (default)
 - [Fine \(200 x 200dpi\)](#)
 - [Superfine \(300 x 300dpi\)](#)
4. Touch the [Save](#) button.

Original sides

1. From the Home screen, scroll to and touch the [Administration](#) button.
2. Open the following menus:
 - [Fax Settings](#)
 - [Fax Send Settings](#)
 - [Default Job Options](#)
 - [Original Sides](#)
3. Touch one of the following options:
 - [1-sided](#) (default)
 - [2-sided](#)
4. Touch the [Orientation](#) button to set the page orientation.
5. Touch the [Save](#) button.

Notification

Notification selects when and how you are notified of the status of an outgoing fax. This setting applies to the current fax only. To change the setting permanently, change the default setting.

1. From the Home screen, touch the [Fax](#) menu.
2. Open the following menus:
 - [Fax Settings](#)
 - [Fax Send Settings](#)
 - [Default Job Options](#)
 - [Notification](#)
3. Touch one of the following notification settings:
 - [Do not notify](#) (default)
 - [Notify when job completes](#)
 - [Notify only if job fails](#)
4. Touch the [Print](#) option to receive a printed notification, or touch the [E-mail](#) option to receive an e-mail notification.
5. If you selected the [Print](#) option, touch the [Save](#) button to complete the notification setup.

-or-

If you selected the [E-mail](#) option, use the keyboard to type an e-mail address. Then touch the [OK](#) button to complete the notification setup.

6. Touch the [Include Thumbnail](#) check box to include a thumbnail image with notifications.

Content orientation

Use the content orientation feature to set how the fax content is oriented on the page. For 1-sided pages, choose Portrait (short-edge on top, default setting) or Landscape (long-edge on top). For 2-sided pages, choose Book-style (short-edge on top) or Flip-style (long-edge on top).

1. From the Home screen, scroll to and touch the [Administration](#) button.
2. Open the following menus:
 - [Fax Settings](#)
 - [Fax Send Settings](#)
 - [Default Job Options](#)
 - [Content Orientation](#)
3. Touch [Portrait](#) (default) or [Landscape](#) for 1-sided pages.
4. Touch [Book-style](#) or [Flip-style](#) for 2-sided pages.
5. Touch the [Save](#) button.

Original size

Use the Original size feature to match your fax content to the size of the original document.

1. From the Home screen, scroll to and touch the [Administration](#) button.
2. Open the following menus:
 - [Fax Settings](#)
 - [Fax Send Settings](#)
 - [Default Job Options](#)
 - [Original Size](#)
3. Touch one of the following options:
 - [Auto detect](#) (default)
 - [Letter](#) (8.5x11)
 - [Mixed Letter/Legal](#)
 - [Legal](#) (8.5 x 14)
 - [Executive](#) (7.25 x 10.5)
 - [Statement](#) (8.5 x 5.5)

- Legal (8.5 x 13)
- A4 (210x297 mm)
- A5 (148x210 mm)
- B5 (257x182 mm)
- 16k (197x273 mm)
- DPostcard JIS (148x200 mm)

4. Touch the [Save](#) button.

Image adjustment

1. From the Home screen, scroll to and touch the [Administration](#) button.
2. Open the following menus:
 - [Fax Settings](#)
 - [Fax Send Settings](#)
 - [Default Job Options](#)
 - [Image Adjustment](#)
3. Touch the [Lighter](#) or [Darker](#) buttons to adjust the [Darkness](#) setting.
4. Touch the [Less](#) or [More](#) buttons to adjust the [Contrast](#), [Background Cleanup](#), or [Sharpness](#) settings.
5. Touch the [Save](#) button.

 **NOTE:** Touch the [Default](#) button to reset the sharpness setting to the factory setting.

Optimize text/picture

Use the Optimize text/picture feature to produce fax output that best matches the original. Sending graphics and photos in text mode results in lower quality images.

1. From the Home screen, scroll to and touch the [Administration](#) button.
2. Open the following menus:
 - [Fax Settings](#)
 - [Fax Send Settings](#)
 - [Default Job Options](#)
 - [Optimize Text/Picture](#)
3. Touch one of the following options:
 - [Manually adjust](#) (default)
 - [Text](#)

- [Printed picture](#)
 - [Photograph](#)
4. Touch the [Save](#) button.

Job build

Use the Job build feature to combine multiple originals into a single fax job.

1. From the Home screen, scroll to and touch the [Administration](#) button.
2. Open the following menus:
 - [Fax Settings](#)
 - [Fax Send Settings](#)
 - [Default Job Options](#)
 - [Job Build](#)
3. Touch one of the following options:
 - [Job Build off](#) (default)
 - [Job Build on](#)
4. Touch the [Save](#) button.

Blank page suppression

Use the Blank page suppression feature to prevent blank pages in a fax from being printed.

1. From the Home screen, scroll to and touch the [Administration](#) button.
2. Open the following menus:
 - [Fax Settings](#)
 - [Fax Send Settings](#)
 - [Default Job Options](#)
 - [Blank Page Suppression](#)
3. Touch one of the following options:
 - [Disabled](#) (default)
 - [Enabled](#)
4. Touch the [Save](#) button.

Receive fax settings

Fax receive setup

Set the ringer volume

1. From the Home screen, scroll to and touch the [Administration](#) button.
2. Open the following menus:
 - [Fax Settings](#)
 - [Fax Receive Settings](#)
 - [Fax Receive Setup](#)
3. Touch the [Ringer Volume](#) drop down menu and then select one of the following ringer volume settings:
 - [Off](#)
 - [Low \(default\)](#)
 - [High](#)
4. Touch the [Save](#) button to save the ringer volume setting.

Set rings-to-answer

The rings-to-answer setting determines the number of times the phone rings before the call is answered by the fax accessory.

 **NOTE:** The default setting range for rings-to-answer is country/region-specific. The range of possible rings-to-answer is limited by country/region.

1. From the Home screen, scroll to and touch the [Administration](#) button.
2. Open the following menus:
 - [Fax Settings](#)
 - [Fax Receive Settings](#)
 - [Fax Receive Setup](#)
3. Touch the [Rings To Answer](#) drop-down menu and then touch the number of rings (1–5, the default is 1).
4. Touch the [Save](#) button.

Set fax receive speed

1. From the Home screen, scroll to and touch the [Administration](#) button.
2. Open the following menus:
 - [Fax Settings](#)
 - [Fax Receive Settings](#)
 - [Fax Receive Setup](#)
3. Touch one of the following options from the [Fax Receive Speed](#) drop down menu:
 - [Fast](#) (default) — v.34/max 33,600 bps
 - [Medium](#) — v.17/max 14,600 bps
 - [Slow](#) — v.29/max 9600 bps
4. Touch the [Save](#) button.

Set ring interval

1. From the Home screen, scroll to and touch the [Administration](#) button.
2. Open the following menus:
 - [Fax Settings](#)
 - [Fax Receive Settings](#)
 - [Fax Receive Setup](#)
3. Touch the box beneath the [Ring Interval](#) heading to open the keypad.
4. Enter a value for the ring interval on the keypad, and then touch the [OK](#) button. The default setting for ring interval is 600.
5. Touch the [Save](#) button.

Set ring frequency

1. From the Home screen, scroll to and touch the [Administration](#) button.
2. Open the following menus:
 - [Fax Settings](#)
 - [Fax Receive Settings](#)
 - [Fax Receive Setup](#)
3. Touch the box beneath the [Ring Frequency](#) heading to open the keypad.

4. Enter a value for the ring frequency on the keypad, and then touch the **OK** button. The default setting for ring frequency is 68 hz.
5. Touch the **Save** button.

Enable or disable the fax printing schedule

 **NOTE:** Before enabling a fax-printing schedule, a schedule must be created.

1. From the Home screen, scroll to and touch the **Administration** button.
2. Open the following menus:
 - **Fax Settings**
 - **Fax Receive Settings**
 - **Fax Printing Schedule**
3. Touch the **Use Fax Printing Schedule** option.
4. Touch the **Schedule** button.
5. Touch **Fax Printing Mode**.
6. Touch the green plus sign to open the **Schedule a Weekly Fax Event** screen.
7. Select an option under the **Event Type** heading:
 - **Print incoming faxes**
 - **Store incoming faxes**
8. Touch the **Time** fields to open the keypad and then enter the hour and minute values when incoming faxes will be printed or stored.
9. Touch the **Event Days** buttons for the days to apply the fax printing schedule.
10. Touch the **OK** button.
11. Touch the **Save** button to save the fax printing schedule.
12. Touch the **Save** button to enable fax printing schedule.

 **NOTE:** Only one fax printing schedule can be applied per day.

Block incoming faxes

Use the fax block list setting to create a list of blocked phone numbers. When a fax is received from a blocked phone number, the fax is not printed and is immediately deleted from memory.

Create a blocked-fax list

1. From the Home screen, scroll to and touch the [Administration](#) button.
 2. Open the following menus:
 - [Fax Settings](#)
 - [Fax Receive Settings](#)
 - [Blocked Fax Numbers](#)
 3. Touch the [Fax Number to Block](#) text box to display the keyboard.
 4. Type a number and then touch the [OK](#) button.
 5. Touch the green arrow to move the number to the [Blocked Fax Numbers](#) list.
-
-  **NOTE:** To add additional blocked fax numbers, repeat steps 3 through 5.
6. Touch the [Save](#) button to save the blocked fax numbers list.

Delete numbers from the blocked-fax list

1. From the Home screen, scroll to and touch the [Administration](#) button.
2. Open the following menus:
 - [Fax Settings](#)
 - [Fax Receive Settings](#)
 - [Blocked Fax Numbers](#)
3. Touch the number to be deleted from the [Blocked Fax Numbers](#) list, touch the [Delete](#) button, and then touch the [Save](#) button.
4. Touch the [OK](#) button to confirm the deletion of the number.
5. Repeat steps 3 and 4 to delete more numbers from the [Blocked Fax Numbers](#) list, or touch the [Delete All](#) button, and then touch the [Save](#) button, to delete all numbers from the [Blocked Fax Numbers](#) list at once.

Initiate polling receive

Some fax machines can hold a fax until another fax machine requests that the fax be sent. When a product polls another fax machine that is holding a fax and requests that the held fax be sent to the product, this is known as polling receive.

1. On the control panel, touch the [Fax](#) icon to display the Fax screen.
2. Touch [More Options](#) to display the options screen.
3. Scroll to page 3.
4. Touch [Fax Polling](#) to display the Fax Polling screen.

5. Touch the text box to display the keyboard.
6. Using the keypad, type a polling receive number, and then touch [Start](#).
7. The number entered is dialed. If a stored fax is being held at the fax machine dialed, that fax is transmitted to the product and printed. If no fax is held, a [No Fax is Available](#) message will be displayed. If the fax machine does not support the polling feature, a [Poll Invalid](#) error message will be shown.

Default job options

The following default job options are available for configuration:

- Notification
- Stamp Received Faxes
- Fit to Page
- Paper Selection
- Output Bin
- Sides

 **NOTE:** Default job option settings are shared across all fax methods; analog, LAN, and internet fax.

Notification

This setting controls when the fax call report is printed for incoming faxes.

1. From the Home screen, scroll to and touch the [Administration](#) button.
2. Open the following menus:
 - [Fax Settings](#)
 - [Fax Receive Settings](#)
 - [Default Job Options](#)
 - [Notification](#)
3. Touch one of the following notification settings:
 - [Do not notify](#) (default)
 - [Notify when job completes](#)
 - [Notify only if job fails](#)
4. Touch the [Print](#) option to receive a printed notification, or touch the [E-mail](#) option to receive an e-mail notification.
5. If you selected the [Print](#) option, touch the [Save](#) button to complete the notification setup.

-or-

If you selected the [E-mail](#) option, use the keyboard to type an e-mail address. Then touch the [Save](#) button to complete the notification setup.

6. Touch the [Include Thumbnail](#) check box to include a thumbnail image with notifications.

Stamp received faxes (incoming faxes)

The stamp received faxes setting enables or disables stamping incoming faxes. The stamp prints the date, time, phone number, and page number on each incoming page.

1. From the Home screen, scroll to and touch the [Administration](#) button.
2. Open the following menus:
 - [Fax Settings](#)
 - [Fax Receive Settings](#)
 - [Default Job Options](#)
 - [Stamp Received Faxes](#)
3. Touch the [Disabled](#) option (default) to disable the stamp, or touch the [Enabled](#) option to enable the stamp.
4. Touch the [Save](#) button.

Set fit-to-page

When selecting a page size to print a fax, the product determines the closest page size that matches the intended size from sizes available in the product. If the fit-to-page setting is enabled and the received image is larger than that page size, the product attempts to scale the image to fit the page. If this setting is disabled, an incoming image larger than the page splits across pages.

1. From the Home screen, scroll to and touch the [Administration](#) button.
2. Open the following menus:
 - [Fax Settings](#)
 - [Fax Receive Settings](#)
 - [Default Job Options](#)
 - [Fit to Page](#)
3. Touch the [Enabled](#) option (default) to enable fit-to-page, or touch the [Disabled](#) option to disable fit-to-page.
4. Touch the [Save](#) button.

Set the paper selection

Use the paper selection feature to specify which tray the paper for the fax is loaded from.

1. From the Home screen, scroll to and touch the [Administration](#) button.
2. Open the following menus:
 - [Fax Settings](#)
 - [Fax Receive Settings](#)
 - [Default Job Options](#)
 - [Paper Selection](#)
3. Touch one of the following options:
 - [Automatic](#) (default)
 - [Tray 1](#)
 - [Tray 2](#)
 - [Tray 3](#)
 - [Tray 4](#)
 - [Tray 5](#)
4. Touch the [Save](#) button.

Set the output bin

Use the Output bin feature to set which output bin to use for outputting the fax.

1. From the Home screen, scroll to and touch the [Administration](#) button.
2. Open the following menus:
 - [Fax Settings](#)
 - [Fax Receive Settings](#)
 - [Default Job Options](#)
 - [Output Bin](#)
3. Touch the bin to use for your received faxes.
4. Touch the [Save](#) button.

Set the sides

Use the Sides feature to specify 1–side or 2–sided output for faxes.

1. From the Home screen, scroll to and touch the [Administration](#) button.
2. Open the following menus:
 - [Fax Settings](#)
 - [Fax Receive Settings](#)
 - [Default Job Options](#)
 - [Sides](#)
3. Touch one of the following options:
 - [1-sided](#) (default)
 - [2-sided](#)
4. Touch the [Save](#) button.

Set the paper tray

The paper tray setting selects the product paper tray to pull paper from for printing faxes.

1. From the Home screen, scroll to and touch the [Administration](#) button.
2. Open the following menus:
 - [Fax Settings](#)
 - [Fax Receive Settings](#)
 - [Default Job Options](#)
 - [Paper Selection](#)
3. Touch the name of the tray to use for received faxes.
4. Touch the [Save](#) button to save the paper tray selection value.

Fax archive and forwarding

Use the fax archive feature to save archival copies of all incoming faxes, all outgoing faxes, or both, to a specified email address.

Use the fax forwarding feature to forward all received faxes, all outgoing faxes, or both, to another fax number. When fax forwarding is enabled, the receiving product prints the fax (if fax printing is disabled, the fax prints when the printing is enabled), and also forwards the fax to the fax forward number.

 **NOTE:** To use the [Archive to Email Address](#) feature, the SMTP server must be configured, and responding, on the product. For information about configuring the SMTP server, see the product user guide.

Enable fax archiving

1. From the Home screen, scroll to and touch the [Administration](#) button.
2. Open the following menus:
 - [Fax Settings](#)
 - [Fax Archive and Forwarding](#)
3. Touch the [Enable Fax Archiving](#) box.
4. Select one of the following choices from the [Type of Fax Job to Archive](#) drop down menu:
 - [Send and receive](#) (default)
 - [Send only](#)
 - [Receive only](#)
5. Touch the [Fax Archiving E-mail Address](#) text box to open the keypad.
6. Type the email address where faxes will be forwarded, and then touch the [OK](#) button.
7. Touch the [Save](#) button.

Enable fax forwarding

1. From the Home screen, scroll to and touch the [Administration](#) button.
2. Open the following menus:
 - [Fax Settings](#)
 - [Fax Archive and Forwarding](#)
3. Touch the [Enable Fax Forwarding](#) box.
4. Select one of the following choices from the [Type of Fax Job to Forward](#) drop down menu:
 - [Send and receive](#)
 - [Send only](#)
 - [Receive only](#) (default)
5. Touch the [Fax Forwarding Number](#) text box to open the keypad.
6. Type the number where faxes will be forwarded, and then touch the [OK](#) button.
7. Touch the [Save](#) button.

Use Fax

Fax feature screen

The Fax feature screen is used to send faxes. To access this screen, press the [Fax](#) icon displayed on the control panel Home screen.

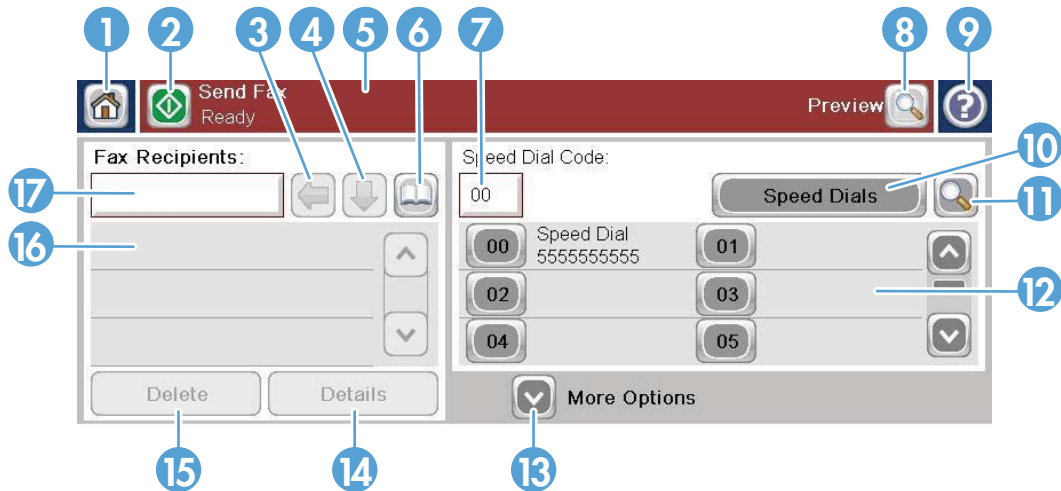

1	Home Key - return to main screen
2	Send Fax - press to send fax to recipients
3	Backspace/Delete Number
4	Enter Number into Recipient List
5	Status Message Bar
6	Access fax address book
7	Speed Dial Search by Number
8	Image Preview
9	Help - touch to display help selections
10	Speed Dial - Edit Key
11	Speed Dial - Search by Name
12	Speed Dial List (scroll to display other entries)
13	More Options – touch to view or set other fax sending options.
14	Press for Details of Selected Recipient
15	Press to Delete Selected Recipient from List
16	Fax Recipients
17	Fax Number - Touch for keyboard or enter from control panel keypad ¹

¹ When the **Fax Number** is touched, a pop up is displayed which includes the **PIN** button for adding special character brackets ([]) to hide a PIN, and a **Pause** button to insert a comma for a two second pause.

 **NOTE:** The PIN is for calling card numbers, not for the security of faxed documents.

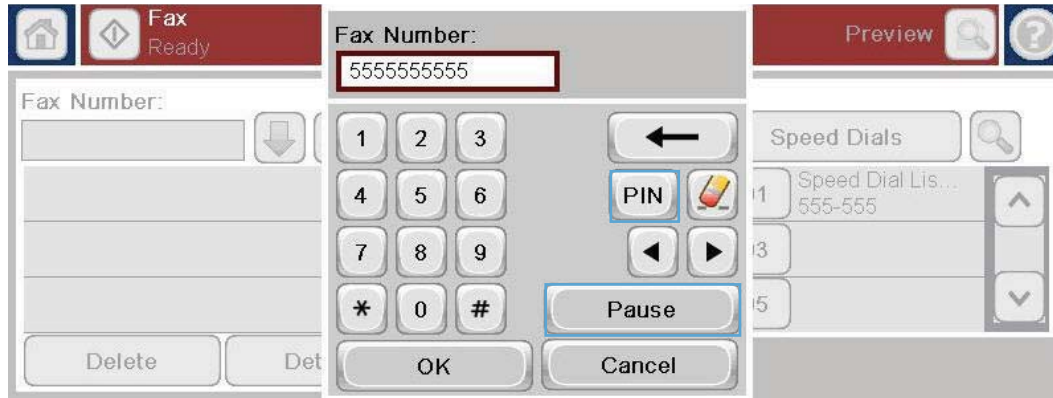

Status message bar

While sending and receiving faxes, status information will display in the status bar located at the top of some touch screens. This status includes such information as: **Ready**, **Receiving call**, **Page sent**, and others.

Send a fax

To send a fax, you can use one of three basic methods to enter numbers:

- Enter numbers manually.
- Enter numbers using speed dial.
- Enter numbers using the fax address book.

 **NOTE:** For online information about sending a fax, touch **?** on the screen to access the help menu, and then touch the **Fax** menu under the list of help topics.

Allowable characters in fax numbers

- Digits (0–9)
- #
- *
- ,
- spaces
- []
- ()

- -
- +
- X
- P

When entering a phone number from the numeric keypad, include any pauses or other numbers, such as area codes, access codes for numbers outside a PBX system (usually a 9 or 0), or a long-distance prefix. A two second pause may be included by typing a comma (,). If the fax prefix setting has been set to automatically include the dialing prefix, you will not need to enter it.

NOTE: When a fax is sent, it is first scanned and stored into memory. After the entire document is stored, it is sent and then deleted from memory. Faxes that fail to send, because the number was busy or did not answer, are deleted from memory. If the [Redial On Busy](#) or [Redial On No Answer](#) features are set, the fax will not be deleted until all retries fail or the fax is sent successfully.

Send a fax by entering numbers manually

1. Place the document in the automatic document feeder (ADF) or on the scanner glass.

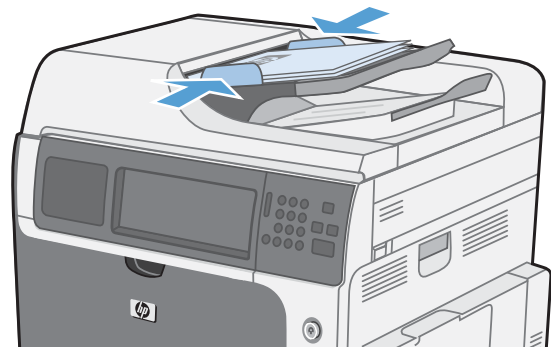

2. From the Home screen, touch the [Fax](#) button. You may be prompted to type a user name and password.

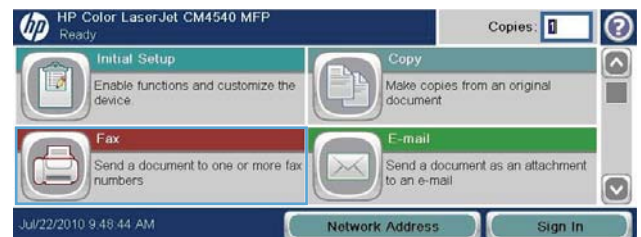

3. Touch the [More Options](#) button. Verify that the settings match those of your original. When all settings are completed, touch the up arrow to scroll to the main [Fax](#) screen.

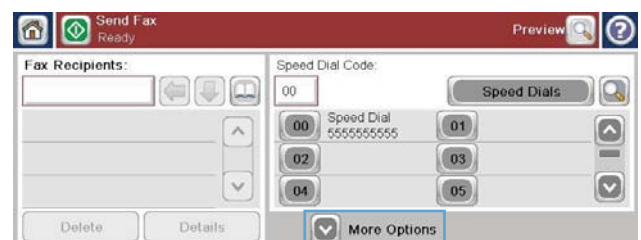

4. Touch the **Fax Number** box to open the keypad.

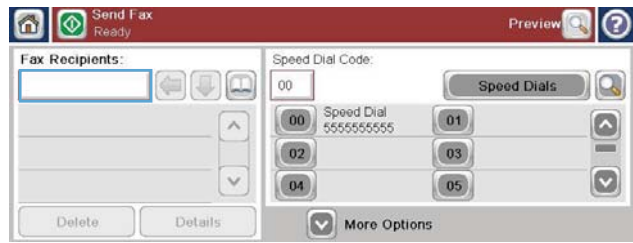

5. Using the keypad, enter a phone number and then touch the **OK** button.



6. Touch the **Start** icon to send the fax. You can either touch the **Start** icon on the touch screen or press the green **Start** button on the control panel.

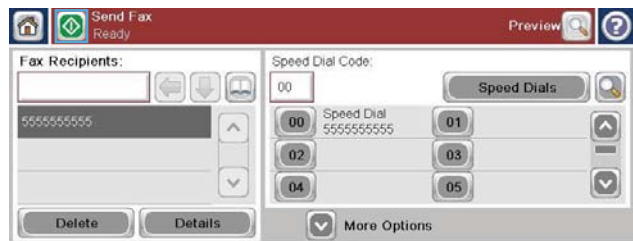

Send a fax using speed dial

 **NOTE:** Prior to sending a fax using speed dial, you must create a speed dial.

1. Place the document in the automatic document feeder (ADF) or on the scanner glass.
2. From the Home screen, touch the **Fax** button.
3. Touch a **Speed Dial** number for the speed dial name you wish to use and then touch the **OK** button. The speed dial name will appear in the **Fax Number** section of the **Fax** screen.
4. Touch the **Start** button to send the fax. You can either touch the **Start** button on the touch screen or press the green **Start** button on the control panel.

Search a speed-dial list by name

Use this feature to search an existing speed dial by name.

 **NOTE:** If you do not know the unique name of the speed dial, type a letter to select any portion of the list. For example, to view speed-dial names that begin with the letter N, type the letter N. If no matching entries exist, a message appears before the search shows the entry that is closest to the letter N.

1. From the Home screen, touch the **Fax** button.

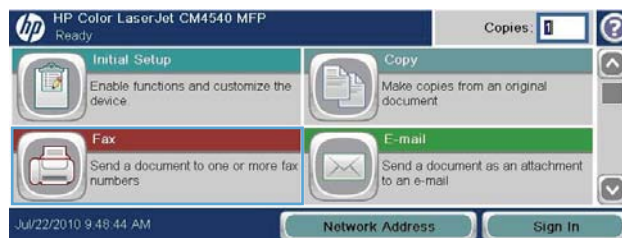

2. Touch the **Speed Dial Search** button. This button looks like a magnifying glass and is located to the right of the **Speed Dial** button.

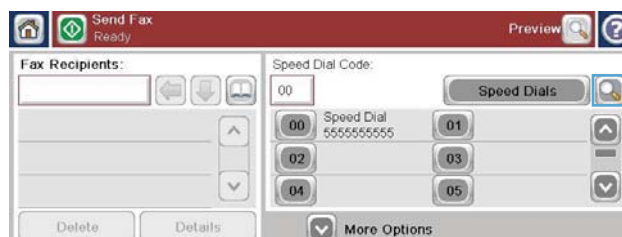

3. Type the first letters of the speed dial name to search for. As matches are found, the list at the top of the search screen is populated. If necessary, scroll to see all the entries, or type more letters to narrow the search.

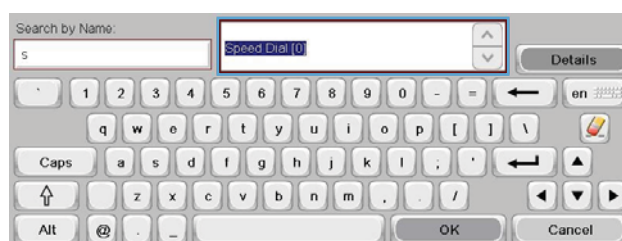

4. Select the appropriate name from the list and touch the **OK** button. The speed-dial list on the main fax screen shows the selected entry within the list of numbers.
5. Touch a speed dial number to add it to the recipients list.
6. Select or search for additional names as needed.

Send a fax by using fax address book numbers

The fax address book feature allows you to store fax numbers on the product.

Your Microsoft® Exchange contact list may also be enabled on the product to appear in the fax address book.

1. On the control panel, touch the **Fax** icon to display the **Fax** screen.
2. Touch the **Address Book** icon to display the **Address Book** screen.
3. Select a fax address book source from the drop down menu.
4. Touch the names to highlight and then touch the right arrow icon to move the highlighted names to the **Fax Recipients** section.

5. Touch the **OK** button to return to the **Fax** screen.
6. Touch the **Start** button to send the fax. You can either touch the **Start** button on the touch screen or press the green **Start** button on the control panel.

Fax address book search

Use the fax address book search feature to complete a name search of the address book.

1. Touch the **Fax** icon on the Home screen.
2. Touch the fax address book icon (located to the right of the fax recipients box).
3. Select the **All Contacts** or **Local Contacts** choice in the drop down menu at the top of the fax address book screen.
4. Touch the **Search** icon (magnifying glass) next to the drop down menu.
5. On the keyboard, type the first letter or letters of the name; matching recipients appear as letters are typed. Type more letters to further refine the search. Select from the name(s) found at the top of the screen, and then touch **OK**. The screen returns to the Fax fax address book.
6. Touch the right arrow to enter the selected name into the Fax Recipients list.
7. Touch the **OK** button to return to the Send Fax job screen.

 **NOTE:** To import/export the local fax address book to the EWS, refer to the EWS documentation.

Cancel a fax

Cancel the current fax transmission

- ▲ Touch the **Cancel Job** button on the fax **Status** screen.

-or-

On the control panel, touch the red **Stop** button.

Touch the **OK** button when the message **Job has been aborted.** displays.

Touch the **OK** button to finish canceling the fax job and return to the fax screen.

Cancel pending faxes

1. From the Home screen, scroll to and touch the **Job Status** button.
2. Touch the fax job to cancel on the **Job Status** screen.
3. Touch the **Cancel Job** button.
4. Touch the **Yes** button on the screen with the message **Are you sure you want to cancel this job?** displays.

 **NOTE:** The cancel operation may require up to 30 seconds to complete.

Receive faxes

When the fax accessory receives incoming faxes, it stores them in memory before printing. After the entire fax is stored, it is printed and then deleted from memory. Faxes print when received unless Schedule Printing of Faxes is enabled. If Schedule Printing of Faxes is enabled, all incoming faxes are stored in memory and not printed. When Schedule Printing of Faxes is disabled, all stored faxes print.

You can change the fax-receive default settings to modify the way a fax is received. These settings include the following options:

- Selecting the number of rings-to-answer
- Printing date, time, and page number on faxes (stamp)
- Selecting input paper tray and destination bin
- Forwarding faxes to another number
- Blocking faxes from certain numbers
- Schedule the printing of faxes (memory lock)
- Notification settings

Create or delete speed dial lists

Speed dial allows you to assign a speed dial name to a single number or a group of numbers and then send a fax to that number or numbers by selecting the speed dial name.

Create a speed dial list

1. From the Home screen, scroll to and touch the **Fax** button.
2. Touch the **Speed Dials** button to display the **Speed Dial** screen.

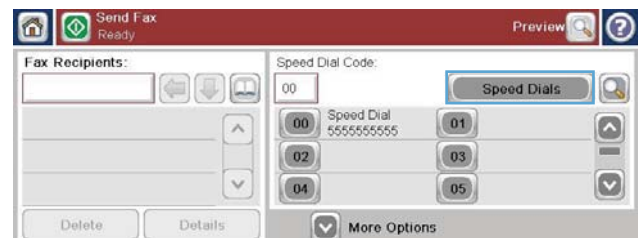
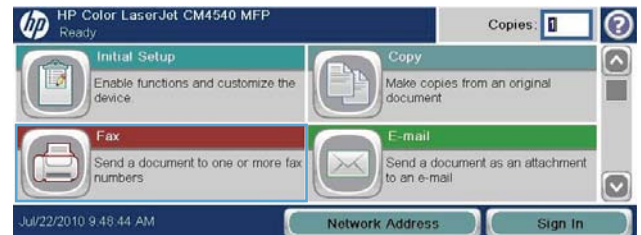

3. Touch a **Speed Dial Number**.

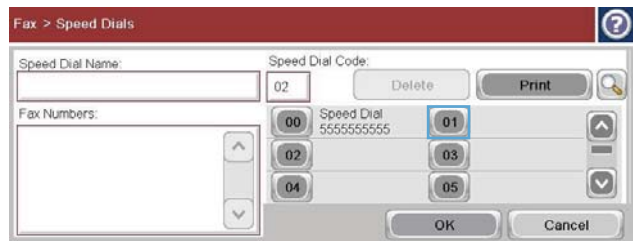

4. Touch the **Speed Dial Name** box to display the keyboard.

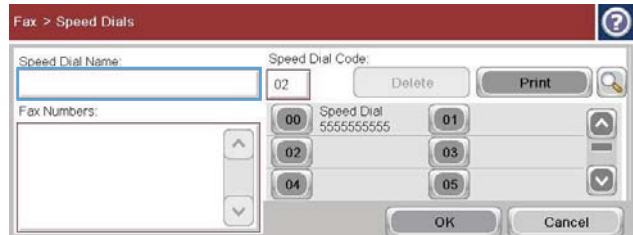

5. Type a name for the speed dial.

6. Touch the down arrow on the **Speed Dial Name** box to open the drop down menu.

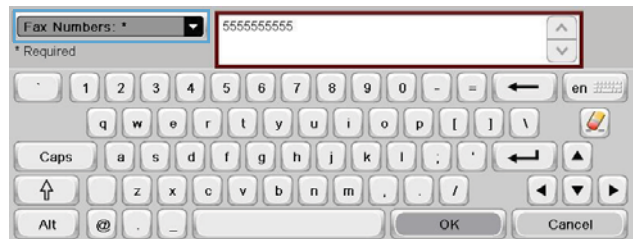

7. Touch the **Fax Number** option.



8. Type a fax number for the **Speed Dial Name**.

NOTE: To enter additional fax numbers for a speed dial name, touch the screen to the right of the last digit of the previously entered fax number. When the cursor appears, touch the enter key to move the cursor to the next line. Repeat this step to enter all the numbers for the speed dial name.

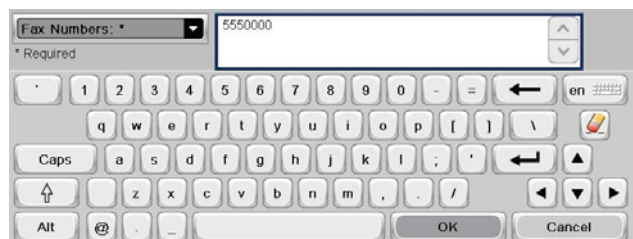

9. Touch the **OK** button. The name and fax number (or numbers) will appear next to the **Speed Dial Number**.



10. When finished, press the **OK** button to return to the **Fax** screen

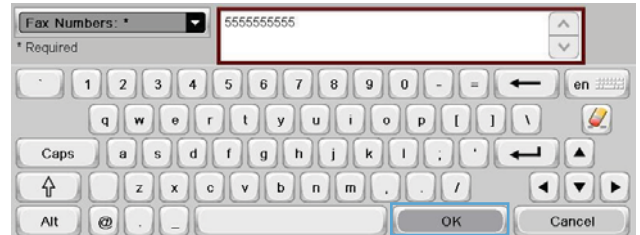

Delete a speed dial list

1. From the Home screen, scroll to and touch the **Fax** button.
2. Touch the **Speed Dials** button to display the **Speed Dial** screen.
3. Touch a **Speed Dials** number of the list to be deleted.

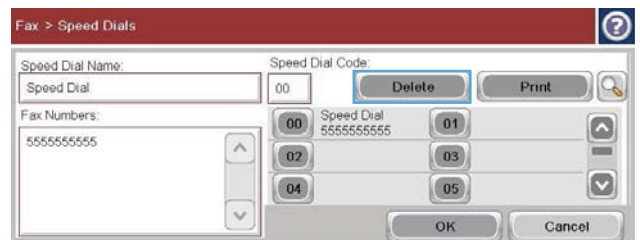
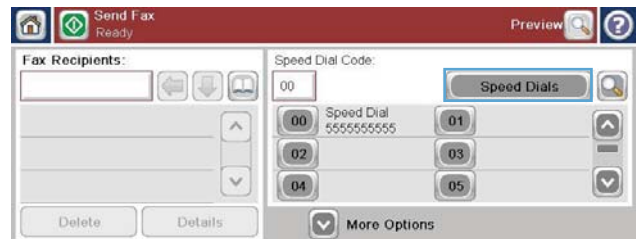
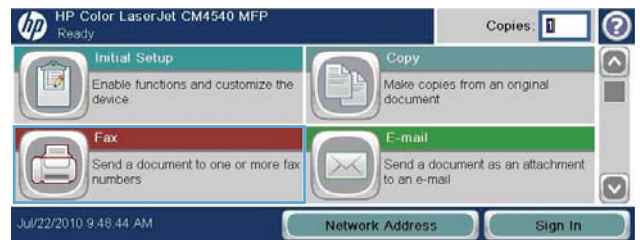

4. Touch the **Delete** button.

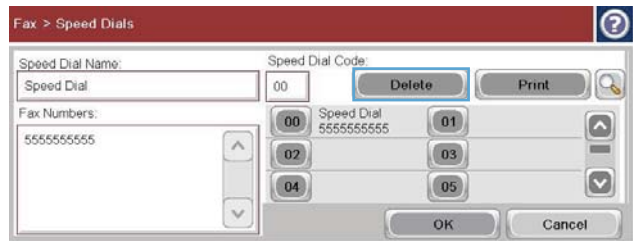

5. Touch the **Yes** button to confirm the deletion of the speed dial list and to return to the **Fax** screen.

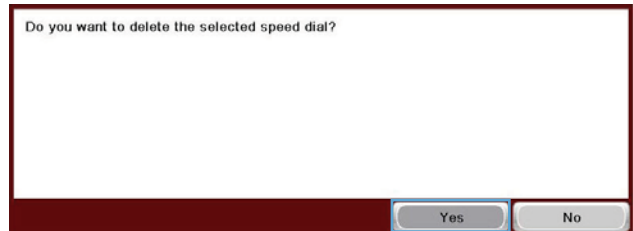

Delete a single number from the speed dial list

1. From the Home screen, scroll to and touch the **Fax** button.

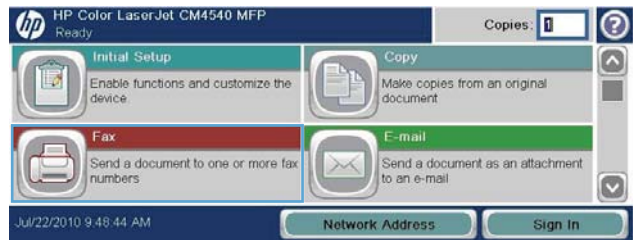

2. Touch the **Speed Dials** button to display the **Speed Dial** screen.

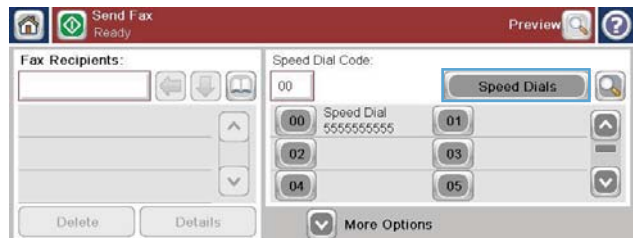

3. Touch the **Speed Dial** number of the list to open the keyboard.

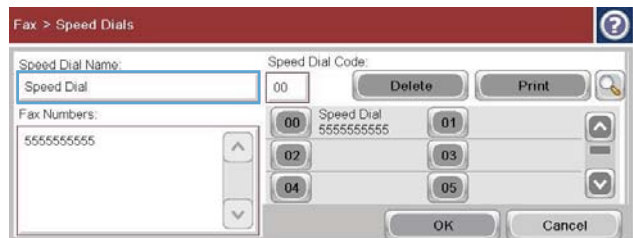

4. Touch the down arrow on the **Speed Dial Name** box to open the drop down menu and then touch the **Fax Numbers** option.



5. Scroll through the list of fax numbers and touch the screen to the right of last digit of the fax number to be deleted. Use the backspace key to delete the fax number.

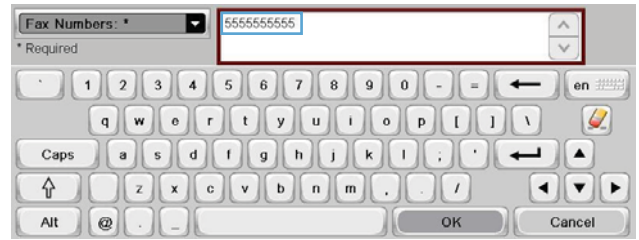

6. Touch the **OK** button to return to the **Speed Dials** screen.

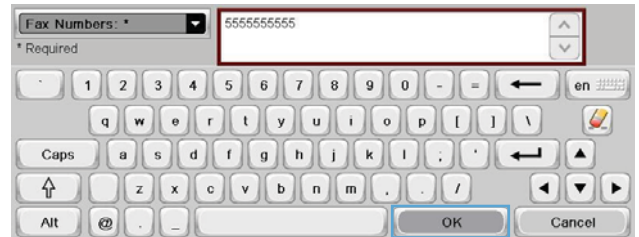

7. Touch the **OK** button to return to the **Fax** screen.

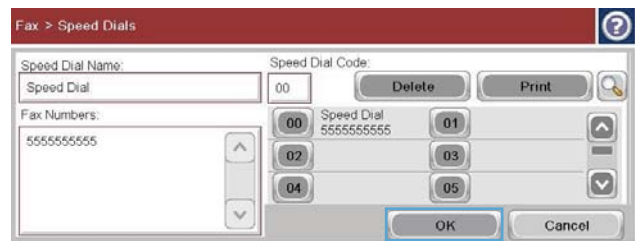

Add a number to an existing speed dial list

1. From the Home screen, scroll to and touch the **Fax** button.

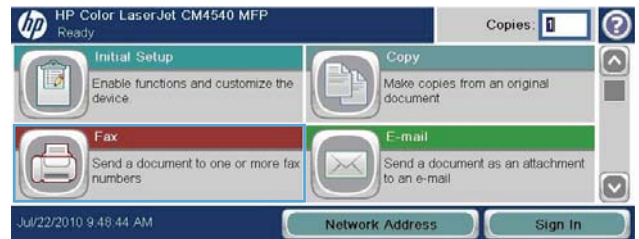

2. Touch the **Speed Dials** button to display the **Speed Dial** screen.

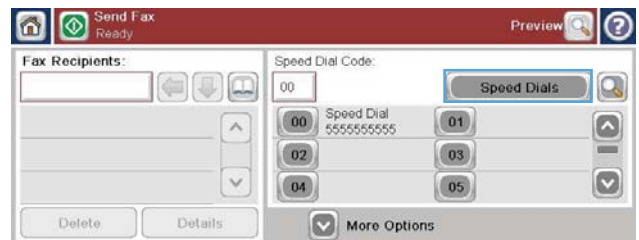

3. Touch the **Speed Dial** number of the list to be edited.

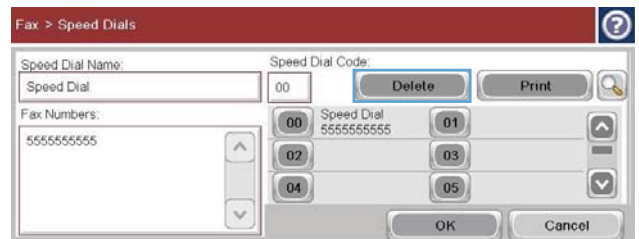

4. Touch the down arrow on the **Speed Dial Name** box to open the drop down menu.



5. Touch the **Fax Numbers** item.



6. To add a fax number for a speed dial name, touch the screen to the right of the last digit of the last fax number in the list. When the cursor appears, touch the enter key  to move the cursor to the next line and then type the fax number.

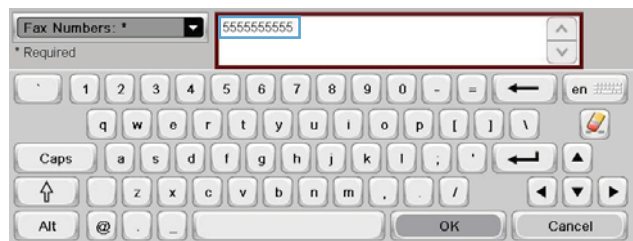

7. Touch the **OK** button to return to the **Speed Dials** screen.

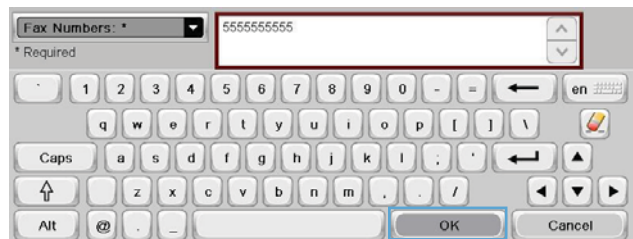

8. Touch the **OK** button to return to the **Fax** screen.

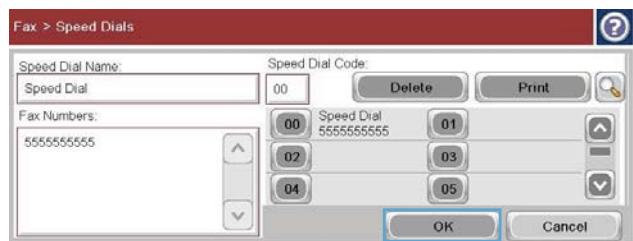

Voice Calls and Retries

Fax Call Report

A Fax Call Report is printed when the Notification feature has been enabled in the Default Job Options or More Options menu.

When all fax attempts have been exhausted, a Fax Call Report will be printed for a fax send. It shows the fax job log ID. The result of the final attempt is printed on the Fax Call Report.

A Fax Call Report does not print for voice calls.

 **NOTE:** A Fax Call Report only generates Job numbers for final attempts. If one of these reports is printed manually from the menu and the last call was neither the final attempt nor a Voice call the Job number will be zero.

Fax Activity Log

Voice Calls are not included in the Fax Activity Log by default. Only the final attempt, after all redials are used or the fax is a success, is listed in the Fax Activity Log.

T.30 Report

Voice Calls do not cause a T.30 report to print. All retry attempts cause a T.30 report to print.

Scheduling fax printing (memory lock)

Use the fax scheduling feature to specify when faxes print. The following fax printing modes can be selected:

- [Store all received faxes](#)
- [Print all received faxes](#)
- [Use Fax Printing Schedule](#)

If the [Store all received faxes](#) feature is selected, then all incoming faxes will be stored in memory and not printed. It is possible to access fax jobs stored in memory through the [Open from Device Memory](#) menu. Using this menu, you can print or delete print jobs while they are stored in memory. For additional information about this feature, see the Retrieve Job menu description in the product user guide.

 **NOTE:** Retrieved stored faxes can be accessed by entering the [Fax Printing](#) menu and changing to the [Print all received faxes](#) mode.

If the [Print all received faxes](#) mode is selected, then all incoming faxes will be printed. Any faxes that are currently stored in memory will also be printed.

If the [Use Fax Printing Schedule](#) mode is selected, then faxes will be only printed per the fax printing schedule. The fax printing schedule can be set to lockout an entire day (24 hours) or lockout a time period during the day. Only one lockout period can be set, but it can be applied to any number of days. The lockout period is setup under the [Fax Printing Schedule](#) menu.

Adding only one type of event into the schedule would make the product behave as **Store All Received Faxes** or **Print All Received Faxes** based on the type of single event added i.e. Single Store Event would cause device to **Store All Received Faxes** and Single Print Event would cause **Print All Received Faxes**.

 **NOTE:** When the lockout time ends, any faxes that were received and stored during the lockout period are printed automatically.

Use Fax over VoIP networks

VoIP technology converts the analog phone signal into digital bits. These are then assembled into packets which travel on the Internet. The packets are converted and transmitted back to analog signals at or near the destination.

The transmission of the information on the Internet is done digitally instead of analog. Therefore, there are different constraints on the fax transmission that may require different fax settings than the analog Public Switched Telephone Network (PSTN). Fax is very dependent upon timing and signal quality, so a fax transmission is more sensitive to a VoIP environment.

The following are suggested changes in settings for the HP LaserJet Analog Fax Accessory 500 when it is connected to a VoIP service:

- Start off with the fax set in V.34 (Fast) mode and with Error Correction Mode (ECM) turned on. The V.34 protocol handles any changes in transmission speed needed to accommodate VoIP networks.
- If numerous errors or retries occur with the unit set to V.34, set V.34 Off and set speed to Medium (14,400 bps).
- If errors and retries persist, set a lower fax speed as some VoIP systems cannot handle the higher signal rates associated with fax. Set the Maximum Baud Rate to 9,600 bps (Slow).
- In rare cases, if errors persist, turn off ECM on the product. The image quality might decrease. Ensure that the image quality is acceptable with ECM off before using this setting.
- If the preceding setting changes have not improved the VoIP fax reliability, contact your VoIP provider for help.

Solve fax problems

Is your fax set up correctly?

Use the following checklist to help identify the cause of any fax related problems you are encountering:

- **Are you using the phone cord supplied with the fax accessory?** This fax accessory has been tested with the supplied phone cord to meet RJ11 and functional specifications. Do not substitute another phone cord; the analog-fax accessory requires an analog phone cord. It also requires an analog phone connection.
- **Is the fax/phone line connector seated in the socket on the fax accessory?** Make sure that the phone jack is well seated in the socket. The connector should be inserted into the socket until it "clicks."
- **Is the phone wall jack working properly?** Verify that a dial tone exists by attaching a phone to the wall jack. Can you hear a dial tone, and can you make a phone call?

What type of phone line are you using?

- **Dedicated line:** A standard fax/phone number assigned to receive or send faxes.
-
-  **NOTE:** The phone line should be for product fax use only and not shared with other types of telephone devices. Examples include alarm systems that use the phone line for notifications to a monitoring companies.
-
- **PBX system:** A business-environment phone system. Standard home phones and the fax accessory use an analog phone signal. Some PBX systems are digital and might not be compatible with the fax accessory. You need to have access to a standard analog phone line to be able to send and receive faxes.
 - **Roll-over lines:** A phone system feature where a new call "rolls over" to the next available line when the first incoming line is busy. Try attaching the fax accessory to the first incoming phone line. The fax accessory will answer the phone after it rings the number of times set in the rings-to-answer setting.

 **NOTE:** Roll-over lines can cause problems with the fax accessory's ability to receive faxes. Using roll-over lines with this product is not recommended.

Are you using a surge-protection device?

A surge-protection device can be used between the wall jack and the fax accessory to protect the fax accessory against electrical power passed through the phone lines. These devices can cause some fax communication problems by degrading the quality of the phone signal. If you are having problems sending or receiving faxes and are using one of these devices, connect the fax accessory directly to the phone jack on the wall to determine whether the problem is with the surge-protection device.

Are you using a phone company voice-messaging service or an answering machine?

If the rings-to-answer setting for the messaging service is lower than the rings-to-answer setting for the fax accessory, the messaging service answers the call, and the fax accessory is not able to receive faxes. If the rings-to-answer setting for the fax accessory is lower than that of the messaging service, the fax accessory answers all calls, and no calls are routed to the messaging service.

Does your phone line have a call-waiting feature?

If the fax telephone line has an activated call-waiting feature, a call-waiting notice can interrupt a fax call in progress, which causes a communication error. Ensure that a call-waiting feature is not active on the fax telephone line.

Check fax accessory status

If the analog-fax accessory does not appear to be functioning, print a [Configuration page](#) report to check the status.

1. From the Home screen, scroll to and touch the [Administration](#) button.
2. Open the following menus:
 - [Reports](#)
 - [Configuration/Status Pages](#)
 - [Configuration page](#)
3. Touch the [Print](#) button to print the report, or touch the [View](#) button to view the report on the screen. The report consists of several pages.

 **NOTE:** The product IP address or host name is listed on the Jetdirect Page.

On the Fax Accessory Page of the Configuration Page, under the Hardware Information heading, check the Modem Status. The following table identifies the status conditions and possible solutions.

Operational / Enabled ¹	The analog-fax accessory is installed and ready.
Operational / Disabled ¹	The fax accessory is installed and operational, however, HP Digital Sending utility has either disabled the product fax feature or has enabled LAN fax. When LAN fax is enabled, the analog-fax feature is disabled. Only one fax feature, either LAN fax or analog fax, can be enabled at a time.
Non-Operational / Enabled/Disabled ¹	A firmware failure has been identified. The firmware should be updated.
Damaged / Enabled/Disabled ¹	Fax accessory has failed; reset the fax accessory card and check for bent pins. If the status is still DAMAGED, replace the analog-fax accessory card.

¹ ENABLED indicates that the analog fax accessory is enabled, turned on; DISABLED indicates that LAN fax is enabled (analog fax is turned off).

Fax feature is not operating

The fax accessory is installed but the icon does not appear on the product main screen.

Cause	Solution
HP MFP Digital Sending Software Configuration utility has disabled the analog-fax feature.	Use the HP MFP Digital Sending Software Configuration utility to enable the analog-fax feature.
The accessory is not operating correctly.	Check the fax accessory status. If the status is NON-OPERATIONAL, new firmware might need to be installed. If the status is DAMAGED and you just installed the card, try reseating the card and check for bent pins. If the status is DAMAGED and the card is installed correctly, the card might need to be replaced.
Faulty formatter board.	Contact your HP service representative for service.

The product is not displaying the fax menus.

Cause	Solution
LAN fax is enabled.	This is normal operation. When the HP Digital Sending Software enables LAN fax, the analog fax is disabled and the fax menu, which is used for the analog fax only, does not open.

General fax problems

Problem	Cause	Solution
Fax failed to send.	JBIG is enabled and receiving fax does not have JBIG capability.	Set JBIG off.
An "Out of Memory" status message appears on the status message bar.	The product storage disk is full.	Delete some files from the disk, see the product user guide for information about managing the disk.
Print quality of a photo is poor or prints as a gray box.	Wrong Page Content mode setting.	Try setting the Optimize Text/Picture option to Photograph .
Pressed the Cancel button on the product keyboard to cancel a fax transmission and the fax was still sent.	Cancellation takes place after making a selection in the cancellation menu (displayed after pressing red Stop button) and acknowledging with OK .	Cancel faxes using the fax menu.
No fax address book button appears.	The fax address book feature has not been enabled.	Use the HP MFP Digital Sending Software Configuration utility to enable the fax address book feature.

Problem	Cause	Solution
Not able to locate the Fax settings in HP Web Jetadmin.	Fax settings in HP Web Jetadmin are located under the device's status page drop-down menu.	Select Digital Sending and Fax from the drop-down menu.
The header is being appended to the top of the page when I have overlay enabled.	The fax will append the overlay header to the top of a page when overlay is set, when the fax has been forwarded.	This is normal operation.
Have a mix of names and numbers in the recipients box.	This is normal for both names and numbers to appear, depending on where they are from, the fax address book lists names, and all other databases list numbers.	Normal, no action required.
My one page fax prints as two pages.	The fax header is being appended to the top of the fax, pushing text to a second page.	If you want your one page fax to print on one page, set the overlay header to overlay mode or adjust the Fit to page setting.
Document stops feeding in the middle of faxing.	There might be a jam in the ADF.	If there is a jam, see the product user guide for instructions on clearing jams.
The volume for sounds coming from the fax accessory is too high or too low.	The volume setting needs to be adjusted.	

Problems with receiving faxes

Incoming fax calls are not being answered by the fax accessory (no fax detected).

Cause	Solution
The rings-to-answer setting might not be set correctly.	Check the rings-to-answer setting.
The phone cord might not be connected properly, or the phone cord is not working.	Check the installation. Make sure you are using the phone cord that came with the fax accessory.
The phone line might not be working.	Disconnect the fax accessory from the phone jack, and connect a phone. Try to make a phone call to ensure the phone line is working.
A voice-messaging service might be interfering with the fax accessory's ability to answer calls.	Do one of the following: <ul style="list-style-type: none"> • Discontinue the messaging service. • Get a phone line dedicated to fax calls. • Decrease the rings-to-answer for the fax accessory to a number less than the rings-to-answer for the voice mail.

Faxes are transmitting or being received very slowly.

Cause	Solution
You might be sending or receiving a very complex fax, such as one with many graphics.	Complex faxes take longer to be sent or received.

Faxes are transmitting or being received very slowly.

Cause	Solution
The receiving fax machine might have a slow modem speed.	The fax accessory only sends the fax at the fastest modem speed the receiving fax machine can use.
The resolution at which the fax was sent or is being received is very high. A higher resolution typically results in better quality, but also requires a longer transmission time.	If you are receiving the fax, call and ask the sender to decrease the resolution and resend the fax. If you are sending, decrease the resolution and change the Optimize Text/Picture option.
If there is a poor phone-line connection, the fax accessory and the receiving fax machine slow down the transmission to adjust for errors.	Cancel and resend the fax. Have the phone company check the phone line.

Faxes are not printing on the product.

Cause	Solution
There is no media in the media input tray.	Load media. Any faxes received while the input tray is empty are stored and will print after the tray has been refilled.
Schedule Printing of Faxes is set.	If Schedule Printing of Faxes is enabled, faxes will not print until it is disabled.
The product is either low on toner or has run out of toner.	The product stops printing as soon as it is low on toner or runs out of toner. Any faxes received are stored in memory and print after the toner has been replaced. For other product printing problems, see the product user guide.
Incoming call may be a voice call.	Incoming voice calls usually show up in the call report as a Communication Error (17) . As these are voice calls and not a fax error, no action is needed to be taken. Ensure that those calling you have a voice number that is different from the fax number.
The incoming fax was interrupted.	Verify that the fax telephone line does not have an activated call-waiting feature. A call-waiting notice can interrupt a fax call in progress, which causes a communication error.
The Fax Printing Schedule feature is set to Always store faxes .	Change the Fax Printing Schedule setting to Always print faxes .

Problems with sending faxes

Problem	Cause	Solution
Faxes quit during sending.	The fax machine to which you are sending might be malfunctioning.	Try sending to another fax machine.
	Your phone line might not be working.	Disconnect the fax accessory from the phone jack, and connect a phone. Try to make a phone call to ensure the phone line is working.

Problem	Cause	Solution
	Your phone line might be noisy or poor quality	Try using a lower baud rate to improve the reliability of transmission. See maximum baud rate setting.
	A call-waiting feature might be active	Verify that the fax telephone line does not have an activated call-waiting feature. A call-waiting notice can interrupt a fax call in progress, which causes a communication error.
The fax accessory is receiving faxes but is not sending them.	If the fax accessory is on a PBX system, the PBX system might be generating a dial tone the fax accessory cannot detect.	Disable the detect dial tone setting.
	There might be a poor phone connection.	Try again later.
	The fax machine to which you are sending might be malfunctioning.	Try sending to another fax machine.
	Your phone line might not be working.	Disconnect the fax accessory from the phone jack, and connect a phone. Try to make a phone call to ensure the phone line is working.
Outgoing fax calls keep dialing.	The fax accessory automatically redials a fax number if the Redial on Busy option is set to on or if the Redial On No Answer is set on.	This is normal operation. If you do not want the fax to retry, set Redial on Busy to 0 and set Redial On No Answer to 0.
Faxes you send are not arriving at the receiving fax machine.	The receiving fax machine might be turned off or might have an error condition, such as being out of paper.	Call the recipient to make sure the fax machine is turned on and ready to receive faxes.
	A fax might be in memory because it is waiting to redial a busy number, or there are other jobs ahead of it waiting to be sent.	If a fax job is in memory for either of these reasons, an entry for the job appears in the fax log. Print the fax activity log, and check the Result column for jobs with a Pending designation.

Error codes

If a fax problem occurs which prevents or interrupts sending or receiving of a fax, an error code is generated that will help in determining the cause of the problem. Error codes show up in the fax activity log, the fax call report, and the T.30 Protocol Trace. Print one of these three reports to obtain the error code. A detailed description of the error codes and the appropriate action can be found at www.hp.com by searching for HP LaserJet Analog Fax Accessory 500.

Fax error messages

When an analog fax is sent or received on an HP LaserJet product, any errors that occur during the fax process will be displayed on the product control panel and entered into the fax reports. Fax errors can occur for many reasons and often they are due to interruptions or noise on the telephone connection.

Any error that takes place during the fax process regardless of where it originates will be displayed by the product.

If the fax process is interrupted or an error occurs during a fax transmission or reception, a two part status/error description is generated by the fax subsystem on the product. Normal or successful faxes also generate messages indicating success. The message information consists of a text description and a numeric code (a few messages don't include numeric codes). Only the text part of the message will be displayed on the product control panel; however, both the text message and numeric code will be listed in the Fax Activity Report, Fax Call Report, and the Fax T.30 Trace (these fax reports can be printed out individually from the product control panel – under the [Administration](#) > [Reports](#) > [Fax Reports](#) and [Administration](#) > [Troubleshooting](#) > [Fax](#) > [Fax T.30 Trace](#) menus). The numeric code is shown in parentheses after the text part of the message in the reports. For example, if a communication error occurred, the control panel display would show [Fax Failed: Communication Error](#). The same error would be shown in the Result field in the Fax Activity Report as **Communication Error (17)**. For this example, the numeric code associated with this communication error is '17'.

The numeric code is generated by the fax modem. Usually a numeric code of (0) indicates a normal modem response. Some messages will always display a numeric code of (0), whereas other messages can have a range of numeric codes depending on the circumstances, and a few messages will have no numeric code. Usually a numeric code of (0) indicates an error was not associated with the fax modem, but occurred in another part of the fax subsystem or other product subsystem such as the printing subsystem. Non-zero error codes give further detail into the particular action or process that the modem is executing, and they don't necessarily indicate that there is a problem with the modem.

In the tables that follow, the fax messages with the most common number codes are given with recommended corrective action. Several messages that are normal or indicate a normal event are also included in tables. For example, if a fax was not able to be sent to a busy number, a [Fail Busy](#) message will be shown. Nothing is wrong with the fax subsystem; the message indicates the fax was not completed due to a busy telephone number at the receiving end.

Persistent error messages with numeric codes different than those listed here require assistance of customer support. A more detailed listing of the last fax call can be printed out before contacting customer support to help identify the problem. The detailed fax listing is called a Fax T.30 Trace and can be printed for the last fax, or it can be set to print whenever a fax error occurs. To print or configure the Fax T.30 Trace, touch [Administration](#), [Troubleshooting](#), and then [Fax T.30 Trace](#). You can then print the report for the last fax or configure when to print the T.30 trace.

Send-fax messages

Table 12-1 Send-fax messages

Message	Error No.	Description	Action(s)
Cancelled	0	Fax was cancelled by user at control panel of product.	None.
Success	n/a	Fax sent successfully.	None.
Fail Busy	0	The receiving fax machine is busy.	The fax will be retired automatically (if configured), otherwise try resending fax later.
No Answer	0	The receiving fax machine is not answering the call.	The receiving fax machine may be disconnected or turned off; contact the receiver to check the machine. Try resending.
Compression Error	Any	Fax may be corrupted or not sent.	Try resending fax.
No Dial	0	No dial tone is detected when sending the fax.	Verify the phone line is active; set the sending fax to "not" to detect a dial tone.
Modem Fail	Any	Unexpected or bad response from the internal fax modem to product.	Try resending fax; if the error persists, contact service. NOTE: This does not necessarily indicate that the modem hardware is bad.
Communication Error	17 or 36	Lost telephone connection between sender and receiver. May be due to voice calls.	Try resending the fax.
Communication Error	Any besides 17 or 36	General communications issue where the fax transmission was interrupted or did not proceed as expected.	Try resending fax; if the error persists, contact service.
Space Fail	0	Unable to read or write the fax image file to disk; could be corrupt product disk or no space available on the product's disk.	Try resending fax; if the error persists, contact service.
Page Fail	0	Incompatible page width, or page had too many bad lines.	Try resending fax; if the error persists, contact service.
Memory Error	0	Out of RAM memory on product.	If error persists, may need to add RAM to product.
Job Fail	Any	Fax failure; the fax job did not complete.	Try resending fax; if the error persists, contact service.

Table 12-1 Send-fax messages (continued)

Message	Error No.	Description	Action(s)
Power Failure	0	A power failure occurred during the fax transmission on the sending fax product.	Try resending the fax.
No Fax Detected	17 or 36	No fax machine was detected at receiving end. May be due to voice calls.	Verify fax number and have receiver verify fax machine is on and connected; then try resending fax.

Receive-fax messages

Table 12-2 Receive-fax messages

Message	Error No.	Description	Action(s)
Success	n/a	Fax received ok.	None.
Blocked	n/a	Fax reception was blocked by receiving fax machine using blocked number feature.	None.
Modem Fail	Any	Unexpected or bad response from the internal modem to the product - example is trying to send a fax just as another fax is arriving.	Have fax resent; if the error persists, contact service.
Communication Error	17, 36	Lost telephone connection or interruption between sender/receiver.	Have the sender resend the fax (if the sending machine does not automatically retry).
Communication Error	Any besides 17 or 36	General communications issue where the fax transmission was interrupted or did not proceed as expected.	Have fax resent; if the error persists, contact service.
Space Fail	0	Unable to read or write image file to disk; could be corrupt product disk or no space on disk.	Have fax resent; if the error persists, contact service.
Page Fail	0	Incompatible page width or page had too many bad lines.	Have fax resent; if the error persists, contact service.
Memory Error	0	Out of RAM memory on product.	If error persists, may need to add additional RAM memory to product.
Compression Error	0	Corrupted fax - the received image file cannot be decoded.	Have fax resent; enable ECM (Error Correction Mode) if not already.
Print Fail	0	Corrupted fax - the received image file cannot be decoded.	Have fax resent; enable ECM (Error Correction Mode) if not already.
Poll Invalid	0	The fax polling feature attempted to retrieve a fax from another machine but no fax was available.	Contact the administrator of the fax machine being polled and verify a fax is available, and then retry.
Job Fail	Any	Fax failure; this includes all non-specific failures.	Have fax resent; if the error persists, contact service.
Power Failure	0	A power failure occurred during the fax reception.	Have the sender resend the fax.
No Fax Detected	17, 36	A voice call was made to the fax.	None

Fax reports

The following sections list the fax reports available on this product. These reports can be printed or viewed on the product control panel.

The following fax reports are available on this product:

- Fax Activity Log
- Billing Codes Report
- Blocked Fax List
- Speed Dial List
- Fax Call Report

Use the following steps to print or view a fax report:

1. From the Home screen, scroll to and touch the [Administration](#) button.
2. Open the following menus:
 - [Reports](#)
 - [Fax Reports](#)
3. Touch the log or report to print or view.
4. Touch the [Print](#) or [View](#) button.

Fax activity log

The fax activity log includes the following information.

- The fax header information configured on the product.
- The job number of each fax job.
- Date and time of all faxes received, sent, or failed to send.
- The type of fax job; send or receive.
- Identification (phone number, if available)
- Duration (off-hook time)
- Number of pages
- Result (successfully sent, pending, or failed to send which includes error type and code)

The database stores the most recent 500 fax entries (older faxes are deleted from the log). The database fax entries include any fax session as an entry. For example, a fax session could be a sent fax, received fax, or firmware upgrades. Depending on the activity, there might be fewer than 500 entries in the report (unless you sent 500 faxes without receiving any faxes or other completing another activity).

If you want to use the log for record keeping purposes, you should print the log periodically (at least every 500 faxes) and then clear it.

Billing code report

The billing code report is a list of the most recent 500 faxes that were successfully sent, listed by billing code. The following information is provided in this report.

- Billing code number
- Date and time of all faxes that were successfully sent
- Identification number
- Duration (off hook time)
- Number of pages sent
- Result (success)

The database stores the most recent 500 faxes (older faxes are deleted from the database). If you want to use the report for record keeping purposes, you should print the report periodically (at least every 500 faxes) and then clear it.

Blocked fax list report

The blocked fax list report contains the list of fax numbers that the product has been configured to not receive faxes from.

Speed dial list report

A speed dial list report lists the fax numbers assigned to speed dial names.

Fax call report

The fax call report is a brief report that indicates the status of the last fax that was sent or received.

Clear the fax activity log

To clear the fax activity log, complete the following steps.

1. On the control panel, touch the [Administration](#) icon.
2. Open the following menus:
 - [Fax Settings](#)
 - [Clear fax activity log](#)
3. Touch the [Clear](#) button to clear the fax activity log.

Service settings

These items in the control-panel menus can help with troubleshooting if the corrective action taken under the Error Codes section is unsuccessful. They are intended to be used when an HP service representative is assisting you.

Settings in the Troubleshooting menu

Open the [Administration](#) menu, and then select the [Troubleshooting](#) menu.

Troubleshooting menu settings

T.30 Trace: The T.30 trace is a printed report which produces a record of all the communications between the sending and receiving fax machines for the last Fax transmission or reception. The report has many technical details which are usually beyond the scope of most users. However the report contains detailed error codes and other information that might be useful in troubleshooting a particular problem related to sending or receiving a FAX. The report contents might be requested by an HP service representative when trying to determine the cause of a problem and will help to determine the appropriate action.

Transmit Signal Loss**Transmit Signal Loss:** This selection compensates for phone line signal loss. It is not recommended to modify this setting unless requested to do so by an HP service representative as it might render the fax inoperable.

V34: This setting has two values (Normal and Off) that control the modem's baud rate. The Normal setting allows the modem to select (negotiate with the other modem) any of the supported baud rates up to 33,600 bps. The Off setting sets the baud rate to 14,400 bps. This setting remains set, until changed.

Speaker Mode: This service setting has two modes, Normal and Diagnostic. In Normal mode, the modem speaker is turned on during dialing through the initial connection and then shuts off. For Diagnostic mode, the speaker is turned on and remains on for all fax communications until the setting is returned to Normal.

Settings in the Resets menu

Open the [Administration](#) menu, and then select the [Resets](#) menu.

Resets menu settings

Restore Factory Telecom Settings or **Restore Default Telecom Settings:** This selection resets several menu changes back to their default settings. This includes the maximum baud rate, ring-burst off time, V.34, speaker mode, and transmit signal loss.

Firmware upgrades

The firmware on the fax accessory can be updated. Fax firmware updates occur as part of an overall product firmware update. See the product user guide for more information.

13 Manage and maintain

- [Print information pages](#)
- [Use the HP Embedded Web Server](#)
- [Use HP Web Jetadmin software](#)
- [Product security features](#)
- [Economy settings](#)
- [Install external I/O cards](#)
- [Clean the product](#)
- [Product updates](#)

Print information pages

Information pages provide details about the product and its current configuration. Use the following procedure to print or view the information pages:

1. From the Home screen, scroll to and touch the [Administration](#) button.
2. Open the [Reports](#) menu.
3. Select the name of the report you want to review, and then touch the [Print](#) button to print it or touch the [View](#) button to review the settings on the control-panel display.

 **NOTE:** Some pages do not have the [View](#) option.

Table 13-1 Reports menu

First level	Second level	Description
Configuration/Status Pages	Administration Menu Map	
	Configuration Page	Shows the product settings and installed accessories.
	Supplies Status	Shows the approximate remaining life for the supplies; reports statistics on total number of pages and jobs processed, serial number, page counts, and maintenance information. HP provides approximations of the remaining life for the supplies as a customer convenience. The actual remaining supply levels might be different than the approximations provided.
	Usage Page	Shows a count of all paper sizes that have passed through the product; lists whether they were simplex, duplex, monochrome, or color; and reports the page count.
Fax Reports	File Directory Page	Shows the file name and folder name for files that are stored in the product memory.
	Color Usage	Prints the color-use statistics for the product.
	Fax Activity Log	Contains a list of the faxes that have been sent from or received by this product.
	Billing Codes Report	A list of billing codes that have been used for outgoing faxes. This report shows how many sent faxes were billed to each code.
	Blocked Fax List	A list of phone numbers that are blocked from sending faxes to this product.
	Speed Dial List	Shows the speed dials that have been set up for this product.
	Last Fax Call Report	A detailed report of the last fax operation, either sent or received.

Table 13-1 Reports menu (continued)

First level	Second level	Description
Other Pages	Demo Page	Prints a demonstration page that highlights the printing capability of the product.
	Color Samples for RGB	Prints color samples for different RGB values. Use the samples as a guide for matching printed colors.
	CMYK Values	Prints color samples for different CMYK values. Use the samples as a guide for matching printed colors.
	PCL Font List	Prints the available PCL fonts.

Use the HP Embedded Web Server

Use the HP Embedded Web Server to view product status, configure product network settings, and to manage printing functions from your computer instead of from the product control panel. The following are examples of what you can do using the HP Embedded Web Server:

- View product status information.
- Determine the remaining life for all supplies and order new ones.
- View and change tray configurations.
- View and change the product control-panel menu configuration.
- View and print internal pages.
- Receive notification of product and supplies events.
- View and change network configuration.

To use the HP Embedded Web Server, you must have Microsoft Internet Explorer 5.01 or later or Netscape 6.2 or later for Windows, Mac OS, and Linux (Netscape only). Netscape Navigator 4.7 is required for HP-UX 10 and HP-UX 11. The HP Embedded Web Server works when the product is connected to an IP-based network. The HP Embedded Web Server does not support IPX-based product connections. You do not have to have Internet access to open and use the HP Embedded Web Server.

When the product is connected to the network, the HP Embedded Web Server is automatically available.

Open the HP Embedded Web Server by using a network connection

1. Identify the product IP address or host name. If the [Network Address](#) button is visible on the Home screen on the product control panel, touch that button to display the address. Otherwise, follow these steps to print or view the product configuration page:
 - a. From the Home screen on the product control panel touch the [Administration](#) button.
 - b. Open the following menus:
 - [Reports](#)
 - [Configuration/Status Pages](#)
 - [Configuration Page](#)
 - c. Touch the [Print](#) or [View](#) button.
 - d. Find the IP address or host name on the Jetdirect page.
2. In a supported Web browser on your computer, type the product IP address or host name in the address/URL field.

HP Embedded Web Server features

Information tab

Table 13-2 HP Embedded Web Server Information tab

Menu	Description
Device Status	Shows the product status and shows the estimated life remaining of HP supplies. The page also shows the type and size of paper set for each tray. To change the default settings, click the Change Settings link.
Configuration Page	Shows the information found on the configuration page.
Event Log Page	Shows a list of all product events and errors. Use the HP Instant Support link (in the Other Links area on all HP Embedded Web Server pages) to connect to a set of dynamic Web pages that help you solve problems. These pages also show additional services available for the product.
Usage Page	Shows a summary of the number of pages the product has printed, grouped by size, type, and paper print path.
Device Information	Shows the product network name, address, and model information. To customize these entries, click the Device Information menu on the General tab.
Print	Browse to a file on your computer or network, and print it.
Printable Reports and Pages	Lists the internal reports and pages for the product. Select one or more items to print or view.

General tab

Table 13-3 HP Embedded Web Server General tab

Menu	Description
Control Panel Administration Menu	Shows the menu structure of the Administration menu on the control panel. NOTE: You can configure settings on this screen, but the HP Embedded Web Server provides more advanced configuration options than are available through the Administration menu.
Alerts	Set up e-mail alerts for various product and supplies events.
AutoSend	Configure the product to send automated e-mails regarding product configuration and supplies to specific e-mail addresses.
Control Panel Snapshot	Shows an image of the current screen on the control-panel display.
Edit Other Links	Add or customize a link to another Web site. This link appears in the Other Links area on all HP Embedded Web Server pages.
Ordering Information	Enter specific supplies ordering information to be displayed on the Supplies Status Page. For example, this information could include the contact information or Web URL for the company from which you purchase supplies.
Device Information	Name the product and assign an asset number to it. Enter the name of the primary contact who will receive information about the product.

Table 13-3 HP Embedded Web Server General tab (continued)

Menu	Description
Language	Set the language in which to display the HP Embedded Web Server information.
Date and Time	Set the date and time or synchronize with a network time server.
Sleep Schedule	Set or edit a wake time, sleep time, and sleep delay for the product. You can set a different schedule for each day of the week and for holidays.
Backup and Restore	Create a backup file that contains product and user data. If necessary, you can use this file to restore data to the product.
Solution Installer	Install third-party software programs that can enhance the product functionality.
Quick Sets Setup	Configure jobs that are available in the Quick Sets area of the Home screen on product control panel.
Quota Server Setup	Connecting to a quota server ensures that each person who uses the product stays within a predetermined range of printed or scanned pages. When connected, the product queries the server at the start of each job to ensure that the person has pages available.

Copy/Print tab

Table 13-4 HP Embedded Web Server Copy/Print tab

Menu	Description
Open from USB Setup	Enable or disable the Open from USB menu on the control panel.
Manage Stored Jobs	Enable or disable the ability to store jobs in the product memory, and configure job-storage options.
Restrict Color	Permit or restrict color printing and copying. You can specify permissions for individual users or for jobs that are sent from specific software programs.

Scan/Digital Send tab

Table 13-5 HP Embedded Web Server Scan/Digital Send tab

Menu	Description
Address Book	Add e-mail addresses into the product one at a time, and edit e-mail addresses that have already been saved in the product. You can also use the Import/Export tab to load a large list of frequently-used e-mail addresses on to the product all at once, rather than adding them one at a time.

Table 13-5 HP Embedded Web Server Scan/Digital Send tab (continued)

Menu	Description
E-mail Setup	Configure the default e-mail settings for digital sending, including the following: <ul style="list-style-type: none">• Settings for the outgoing mail (SMTP) server• Default settings for E-mail Quick Sets jobs• Default message settings, such as the "From" address and the subject line.• Settings for digital signatures and encryption• Settings for e-mail notifications• Settings for individual and group sign-in and permissions• Default scan settings for e-mail jobs• Default file settings for e-mail jobs
Save to Network Folder Setup	Configure the network folder settings for digital sending, including the following: <ul style="list-style-type: none">• Default settings for Quick Sets jobs saved in a network folder• Settings for notifications• Default scan settings for jobs saved in a network folder• Default file settings for for jobs saved in a network folder
Save to USB Setup	Configure the USB settings for digital sending, including the following: <ul style="list-style-type: none">• Default settings for Quick Sets jobs saved on a USB flash drive• Settings for notifications• Default scan settings for jobs saved on a USB flash drive• Default file settings for for jobs saved on a USB flash drive
OXPd: Workflow	Use third-party workflow tools.
Digital Sending Software Setup	Configure settings related to using optional Digital Sending software.

Fax tab

Table 13-6 HP Embedded Web Server Fax tab

Menu	Description
Fax Send Setup	Configure settings for sending faxes, including the following: <ul style="list-style-type: none">• Default settings for outgoing faxes• Default setting for sending faxes with the internal fax modem• Settings for using a LAN fax service• Settings for using an Internet fax service

Table 13-6 HP Embedded Web Server Fax tab (continued)

Menu	Description
Speed Dials	Manage fax speed dial numbers. You can also import .CSV files containing e-mail addresses, fax numbers, or user records, so that they can be accessed on this product. You can also export e-mail, fax, or user records from the product into a file on your computer. You can then use this file as a data backup, or you can use it to import the records onto another HP product.
Fax Receive Setup	Configure default print options for incoming faxes, and set up a fax printing schedule.
Fax Archive and Forwarding	Enable or disable fax archiving and fax forwarding, and configure basic settings for each. <ul style="list-style-type: none"> Fax archiving is a method to send a copy of all incoming and outgoing faxes to an e-mail address. Fax forwarding is a method to forward incoming faxes to a different fax device.
Fax Activity Log	Contains a list of the faxes that have been sent from or received by this product.

Troubleshooting tab

Table 13-7 HP Embedded Web Server Troubleshooting tab

Menu	Description
Reports and Tests	Print a variety of reports to help you solve problems with the product. Change the fax speed and fax speaker mode for diagnostic purposes.
Calibration/Cleaning	Enable the automatic cleaning feature, set the page count at which the product automatically prints the cleaning page, and set the page size to use for the cleaning page.

Security tab

Table 13-8 HP Embedded Web Server Security tab

Menu	Description
General Security	Configure an administrator password so you can restrict access to certain features on the product. Enable or disable the Host USB port on the control panel or the USB connectivity port on the formatter for printing directly from a computer.
Access Control	Configure access to product functions for specific individuals or groups. Also select the method by which individuals sign in to the product.

Table 13-8 HP Embedded Web Server Security tab (continued)

Menu	Description
Protect Stored Data	Configure and manage the internal hard drive for the product. This product includes an encrypted hard drive for maximum security. Configure settings for jobs that are stored on the product hard drive.
Certificate Management	Install and manage security certificates for access to the product and the network.

Networking tab

Use the **Networking** tab to change network settings for the product when it is connected to an IP-based network. This tab does not appear if the product is connected to other types of networks.

Other Links list

 **NOTE:** You can configure which items appear in the **Other Links** list by using the **Edit Other Links** menu on the **General** tab. The following items are the default links.

Table 13-9 HP Embedded Web Server Other Links list

Menu	Description
HP Instant Support	Connects you to the HP Web site to help you find solutions to product problems.
Shop for Supplies	Connects to the HP SureSupply Web site, where you can receive information on options for purchasing original HP supplies, such as print cartridges and paper.
Product Support	Connects to the support site for the product, from which you can search for help regarding various topics.
Show Me How	Connects to information that demonstrates specific tasks for the product, such as clearing jams and printing on various types of paper.

Use HP Web Jetadmin software

HP Web Jetadmin is an award-winning, industry-leading tool for efficiently managing a wide variety of networked HP devices, including printers, multifunction products, and digital senders. This single solution allows you to remotely install, monitor, maintain, troubleshoot, and secure your printing and imaging environment — ultimately increasing business productivity by helping you save time, control costs, and protect your investment.

HP Web Jetadmin updates are periodically made available to provide support for specific product features. Visit www.hp.com/go/webjetadmin and click the **Self Help and Documentation** link to learn more about updates.

Product security features

Security statements

The product supports security standards and recommended protocols that help you keep the product secure, protect critical information on your network, and simplify the way you monitor and maintain the product.

For in-depth information about HP's secure imaging and printing solutions, visit www.hp.com/go/secureprinting. The site provides links to white papers and FAQ documents about security features.

IP Security

IP Security (IPsec) is a set of protocols that control IP-based network traffic to and from the product. IPsec provides host-to-host authentication, data integrity, and encryption of network communications.

For products that are connected to the network and have an HP Jetdirect print server, you can configure IPsec by using the **Networking** tab in the HP Embedded Web Server.

Secure the HP Embedded Web Server

Assign an administrator password for access to the product and the HP Embedded Web Server so that unauthorized users cannot change the product settings.

1. Open the HP Embedded Web Server by entering the product IP address into the address line of a Web browser.
2. Click the **Security** tab.
3. Open the **General Security** menu.
4. In the **Username** field, type the name to associate with the password.
5. Type the password in the **New Password** box, and type it again in the **Verify password** box.

 **NOTE:** If you are changing an existing password, you must first type the existing password in the **Old Password** field.

6. Click the **Apply** button. Make note of the password and store it in a safe place.

Encryption support: HP Encrypted High Performance Hard Disks

This product includes an encrypted hard disk. This hard disk provides hardware-based encryption so you can securely store sensitive print, copy, and scan data without impacting product performance. This hard disk uses the latest Advanced Encryption Standard (AES) and has versatile time-saving features and robust functionality.

Use the **Security** menu in the HP Embedded Web Server to configure the disk.

For more information about the encrypted hard disk, see the *HP High-Performance Secure Hard Disk Setup Guide*.

1. Go to www.hp.com/support.
2. Type **Secure Hard Disk** into the search box and click the >> button.
3. Click the **HP Secure High Performance Hard Disk Drive** link.
4. Click the **Manuals** link.

Secure stored jobs

You can protect jobs that are stored on the product by assigning a PIN to them. Anyone who tries to print these protected jobs must first enter the PIN at the product control panel.

Lock the control panel menus

You can lock various features on the control panel by using the HP Embedded Web Server.

1. Open the HP Embedded Web Server by entering the product IP address into the address line of a Web browser.
2. Click the the **Security** tab.
3. Open the **Access Control** menu.
4. In the **Sign In and Permission Policies** area, select which types of users have permission for each of the features.
5. Click the **Apply** button.

Lock the formatter

The formatter area, on the back of the product, has a slot that you can use to attach a security cable. Locking the formatter prevents someone from removing valuable components from it.

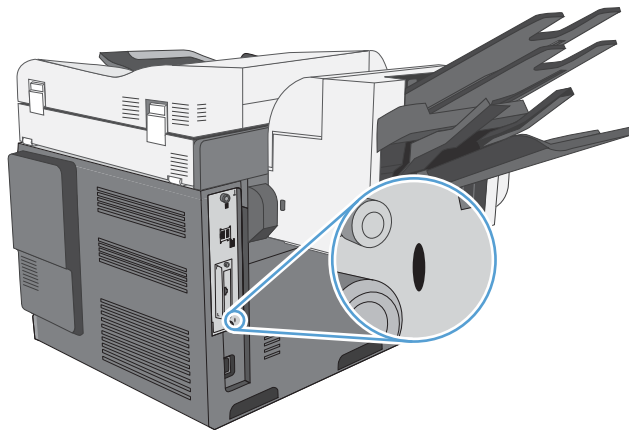

Economy settings

Optimize speed or energy use

By default the product stays warm between jobs to optimize speed. You can set the product to cool between jobs, which conserves energy.

1. From the Home screen, touch the [Administration](#) button.
2. Open each of the following menus:
 - a. [General Settings](#)
 - b. [Energy Settings](#)
 - c. [Optimum Speed/Energy Usage](#)
3. Select the option that you want to use.

Powersave modes

Use the [Sleep Schedule](#) feature to reduce power consumption when the product is inactive. You can schedule specific times of the day at which the product enters sleep mode or wakes from sleep mode. You can customize this schedule for each day of the week or for holidays.

Use the [Sleep Delay](#) feature to cause the product to enter sleep mode automatically after a predefined period of inactivity.

 **NOTE:** These features do not affect product warm-up time.

Set sleep mode

1. From the Home screen, touch the [Administration](#) button.
2. Open each of the following menus:
 - a. [Display Settings](#)
 - b. [Sleep Mode](#)
3. Select one of the following options:
 - [Use sleep delay](#): Activates the [Sleep Delay](#) feature.
 - [Use sleep schedule](#): Activates the [Sleep Schedule](#) feature.
 - [Use both](#): Use the sleep delay and the sleep schedule.

Set sleep delay

1. From the Home screen, touch the [Administration](#) button.
2. Open each of the following menus:
 - a. [General Settings](#)
 - b. [Energy Settings](#)
 - c. [Sleep Delay](#)
3. Select the appropriate time period, and then touch the [OK](#) button.

 **NOTE:** The default value is 45 minutes.

Set the sleep schedule

 **NOTE:** You must configure the date and time settings before you can use the [Sleep Schedule](#) feature. If you have already configured the date and time settings, you can skip steps 2 and 3 in the following procedure.

1. From the Home screen, touch the [Administration](#) button, and then open the [General Settings](#) menu.
2. Open the [Date/Time Format](#) menu. Configure the following settings:
 - [Date Format](#)
 - [Time Format](#)
3. Open the [Date/Time](#) menu and configure the following settings:
 - [Date](#)
 - [Time](#)
 - [Time Zone](#)

If you are in an area that uses daylight savings time, select the [Adjust for Daylight Savings](#) box.

4. Open the [Energy Settings](#) menu, and then open the [Sleep Schedule](#) menu.
5. Touch the Add  button, and then select the type of event to schedule: [Wake Up](#) or [Sleep](#).
6. Configure the following settings:
 - [Event Time](#)
 - [Event Days](#)
 - [Event Description](#)
7. Open the [Holidays](#) menu to configure which days are holidays for your area.

Install external I/O cards

This product is equipped with an external I/O (EIO) slot. You can install an additional HP Jetdirect print server card or external EIO hard drive in the available EIO slot.

 **NOTE:** This example shows installing an HP Jetdirect print server card.

1. Turn the product off.

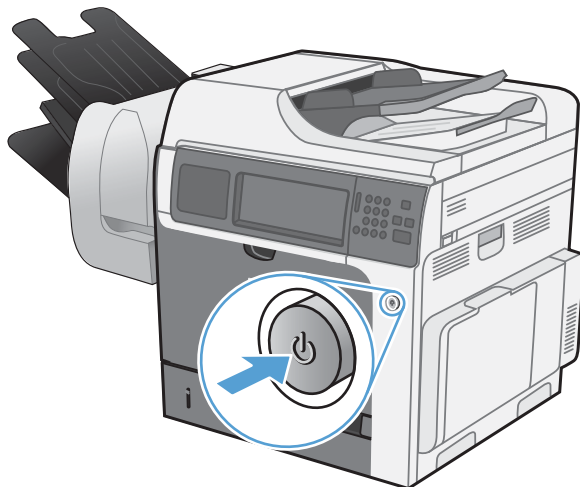

2. Disconnect all power and interface cables.

 **NOTE:** This illustration might not show all the cables.

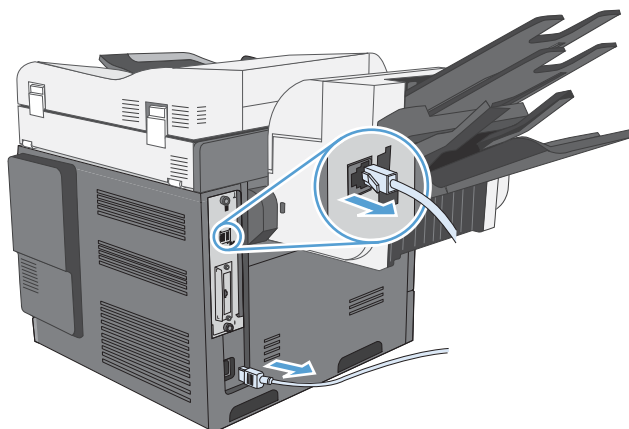

3. Loosen and remove the two retaining screws holding the cover for the EIO slot, and then remove the cover. You will not need these screws and the cover again. They can be discarded.

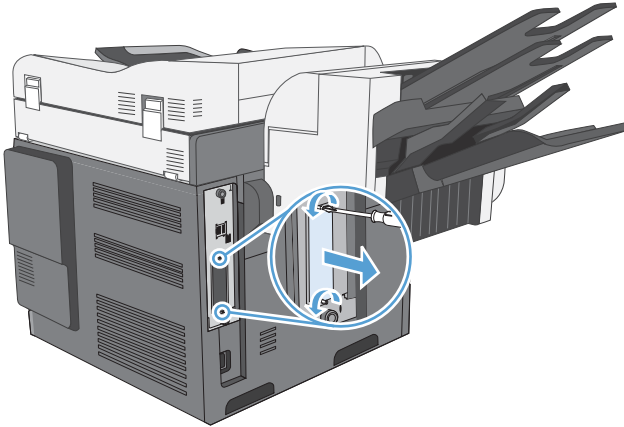

4. Firmly insert the HP Jetdirect print server card into the EIO slot.

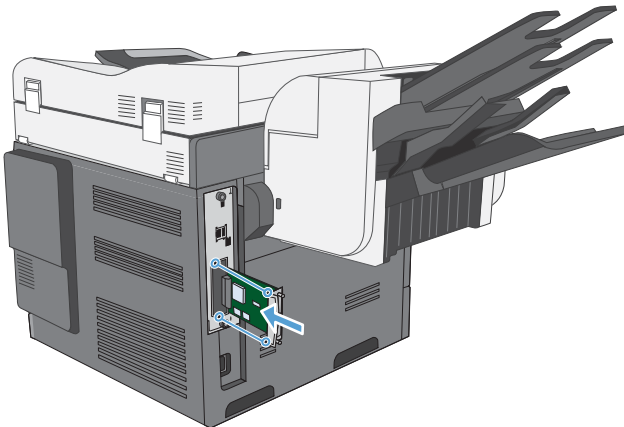

5. Insert and tighten the retaining screws that came with the print server card.

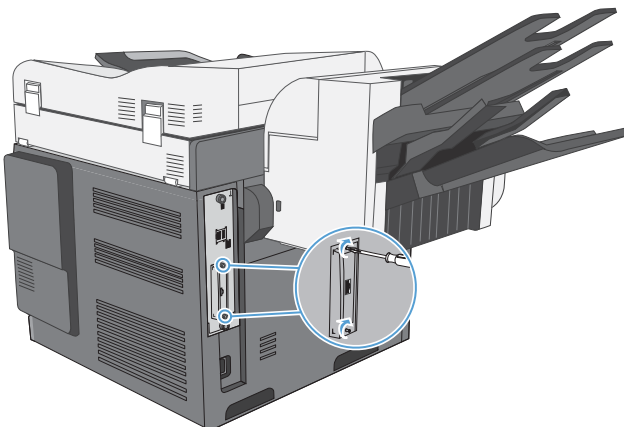

6. Reconnect the power cable and remaining interface cables, and turn the product on.

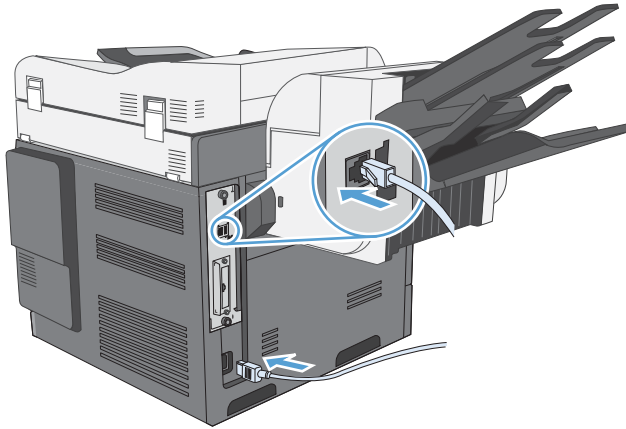

7. Print a configuration page. An HP Jetdirect configuration page that contains network configuration and status information should also print.

If it does not print, turn the product off, and then uninstall and reinstall the print server card to ensure that it is completely seated in the slot.

8. Perform one of these steps:
 - Choose the correct port. See the computer or operating system documentation for instructions.
 - Reinstall the software, choosing the network installation this time.

Clean the product

To clean the product exterior, use a soft, water-moistened cloth.

Clean the paper path

1. From the Home screen, touch the [Device Maintenance](#) button.
2. Open the following menus:
 - [Calibration/Cleaning](#)
 - [Cleaning Page](#)
3. Touch the [Print](#) button to print the page.
4. The cleaning process can take several minutes. When it is finished, discard the printed page.

Clean the scanner glass

Over time, specks of debris might collect on the scanner glass and white plastic backing, which can affect performance. Use the following procedure to clean the scanner glass and white plastic backing.

1. Use the power switch to turn off the product, and then unplug the power cord from the electrical socket.

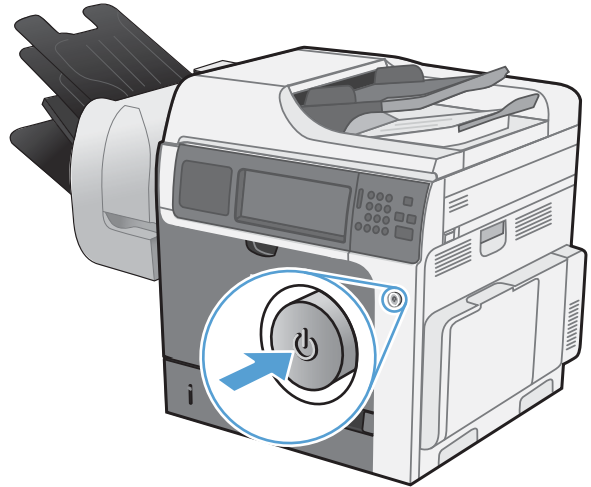

2. Open the scanner lid.

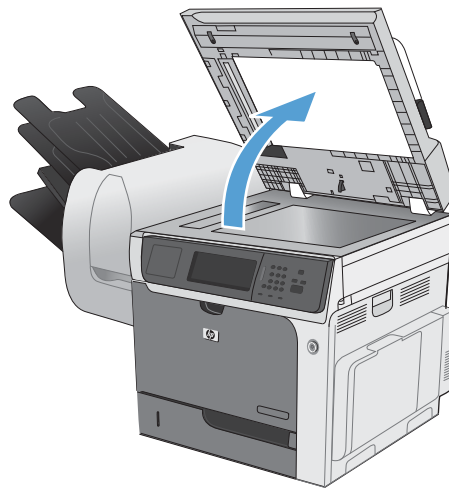

3. Clean the scanner glass and the white plastic backing with a soft cloth or sponge that has been moistened with nonabrasive glass cleaner. Dry the glass and white plastic backing with a chamois or a cellulose sponge to prevent spotting.

CAUTION: Do not use abrasives, acetone, benzene, ammonia, ethyl alcohol, or carbon tetrachloride on any part of the product; these can damage the product. Do not place liquids directly on the glass or platen. They might seep and damage the product.

NOTE: Carefully clean the small glass strip to the left of the scanner glass. Small marks on this glass result in streaks on copies made from the document feeder.

4. Plug in the product, and then use the power switch to turn on the product.

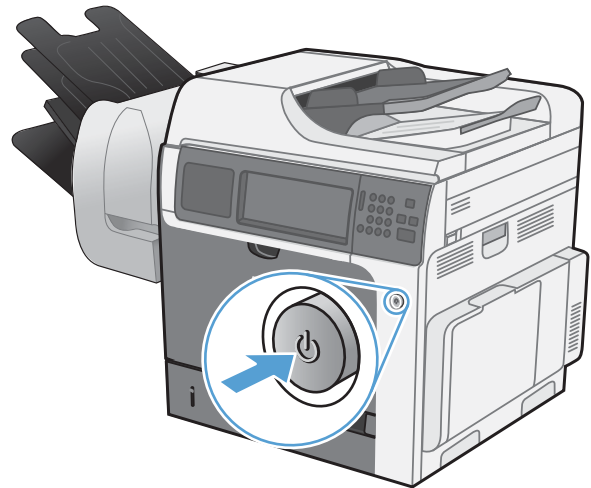
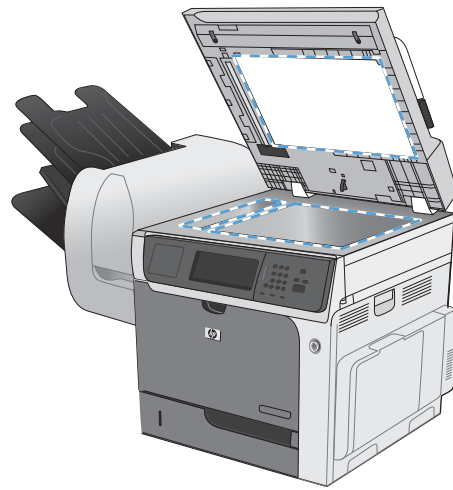

Product updates

HP regularly updates features that are available in the product firmware. To take advantage of the most current features, update the product firmware. To download the most recent firmware upgrade, go to www.hp.com/go/cljcm4540mfp_firmware.

14 Solve problems

- [Self help](#)
- [Solve problems checklist](#)
- [Restore factory settings](#)
- [Interpret control-panel messages](#)
- [Paper feeds incorrectly or becomes jammed](#)
- [Improve print quality](#)
- [The product does not print or it prints slowly](#)
- [Solve walk-up USB printing problems](#)
- [Solve connectivity problems](#)
- [Solve product software problems with Windows](#)
- [Solve product software problems with Mac](#)

Self help

In addition to the information in this guide, other sources are available that provide helpful information.

<i>Use the Control Panel poster</i>	This poster contains information on using the buttons and other features available on the product control panel.
Quick Reference Topics	Several Quick Reference Topics for this product are available at this Web site: www.hp.com/support/cljcm4540mfp You can print these topics and keep them near the product. They are a handy reference for procedures that you perform frequently.
Quick Reference Guide	This guide contains procedures for the most commonly used product functions. The guide is available from this Web site: www.hp.com/support/cljcm4540mfp You can print this guide and keep it near the product.
Control panel help	The control panel has built-in help that guides you through several tasks, such as replacing print cartridges and clearing jams. To open the Help system, touch the Help button  in the upper-right corner of the screen.

Solve problems checklist

Follow these steps when trying to solve a problem with the product.

- 1.** Make sure the product Ready light is on. If no lights are on, complete these steps:
 - a.** Check the power-cable connections.
 - b.** Check that the power is turned on.
 - c.** Make sure that the line voltage is correct for the product power configuration. (See the label that is on the back of the product for voltage requirements.) If you are using a power strip and its voltage is not within specifications, plug the product directly into the wall. If it is already plugged into the wall, try a different outlet.
 - d.** If none of these measures restores power, contact HP Customer Care.
- 2.** Check the cabling.
 - a.** Check the cable connection between the product and the computer or network port. Make sure that the connection is secure.
 - b.** Make sure that the cable itself is not faulty by using a different cable, if possible.
 - c.** Check the network connection.
- 3.** The control panel should indicate ready status. If an error message appears, resolve the error.
- 4.** Ensure that the paper that you are using meets specifications.
- 5.** Print a configuration page.
 - a.** From the Home screen on the product control panel, open the following menus:
 - [Administration](#)
 - [Reports](#)
 - [Configuration/Status Pages](#)
 - [Configuration Page](#)
 - b.** Touch the [Print](#) button.

If the pages do not print, check that at least one tray contains paper.

If the page jams in the product, follow the instructions on the control panel to clear the jam.
- 6.** If the configuration page prints, check the following items:
 - a.** If the page does not print correctly, the problem is with the product hardware. Contact HP Customer Care.
 - b.** If the page prints correctly, then the product hardware is working. The problem is with the computer you are using, with the printer driver, or with the program.
- 7.** Select one of the following options:

Windows: Click **Start**, click **Settings**, and then click **Printers** or **Printers and Faxes**. Double-click the name of the product.

-or-

Mac OS X: Open the **Printer Setup Utility** or the **Print & Fax** list, and double-click the line for the product.

8. Verify that you have installed the printer driver for this product. Check the program to make sure that you are using the printer driver for this product. The printer driver is on the CD that came with the product. You can also download the printer driver from this Web site: www.hp.com/support/cljcm4540mfp.
9. Print a short document from a different program that has worked in the past. If this solution works, then the problem is with the program you are using. If this solution does not work (the document does not print), complete these steps:
 - a. Try printing the job from another computer that has the product software installed.
 - b. If you connected the product to the network, connect the product directly to a computer with a USB cable. Redirect the product to the correct port, or reinstall the software, selecting the new connection type that you are using.

Factors that affect product performance

Several factors affect the time it takes to print a job:

- Maximum product speed, measured in pages per minute (ppm)
- The use of special paper (such as transparencies, heavy paper, and custom-size paper)
- Product processing and download time
- The complexity and size of graphics
- The speed of the computer you are using
- The USB connection
- The product I/O configuration
- The network operating system and configuration (if applicable)
- The printer driver that you are using

Restore factory settings

1. From the Home screen, scroll to and touch the [Administration](#) menu.
2. Open the following menus:
 - [General Settings](#)
 - [Restore Factory Settings](#)
3. Select one or more categories of settings from the list, and then touch the [Reset](#) button.

Interpret control-panel messages

Control-panel message types

Four types of control-panel messages can indicate the status of or problems with the product.

Message type	Description
Status messages	Status messages reflect the current state of the product. They inform you of normal product operation and require no interaction to clear them. They change as the state of the product changes. Whenever the product is ready, not busy, and has no pending warning messages, the Ready status message appears if the product is online.
Warning messages	Warning messages inform you of data and print errors. These messages typically alternate with the Ready or status messages and remain until you touch the OK button. Some warning messages are clearable. If the Clearable Warnings menu in the Display Settings menu is set to the Job option, the next print job clears these messages.
Error messages	<p>Error messages communicate that some action must be performed, such as adding paper or clearing a jam.</p> <p>Some error messages are auto-continuable. If the Continuable Events menu in the Display Settings menu is set to the Auto-Continue option, the product continues normal operation after an auto-continuable error message appears for 10 seconds.</p> <p>NOTE: Pressing any button during the 10-second auto-continuable error message overrides the auto-continue feature, and the button function takes precedence. For example, pressing the Stop  button pauses printing and offers the option to cancel the print job.</p>
Critical-error messages	Critical error messages inform you of a product failure. You can clear some of these messages by turning the product off and then on. These messages are not affected by the Auto-Continue setting. If a critical error persists, service is required.

Control-panel messages

The product provides robust control panel messaging. When a message appears on the control panel, follow the on-screen instructions to resolve the issue. If the product displays an “Error” or “Attention” message, and no steps are shown to resolve the issue, turn the product off then on. Contact HP support if you continue to experience issues with the product.

To get additional information for warnings that appear in the status line, touch the Warning button .

For additional information on a variety of topics, touch the Help button  in the upper-right corner of the home screen.

Paper feeds incorrectly or becomes jammed

- [The product does not pick up paper](#)
- [The product picks up multiple sheets of paper](#)
- [Prevent paper jams](#)
- [Clear jams](#)

The product does not pick up paper

If the product does not pick up paper from the tray, try these solutions.

1. Open the product and remove any jammed sheets of paper.
2. Load the tray with the correct size of paper for your job.
3. Make sure the paper guides in the tray are adjusted correctly for the size of paper. Adjust the guides so they are touching the paper stack without bending it.
4. Check the product control panel to see if the product is waiting for you to acknowledge a prompt to feed the paper manually. Load paper, and continue.

The product picks up multiple sheets of paper

If the product picks up multiple sheets of paper from the tray, try these solutions.

1. Remove the stack of paper from the tray and flex it, rotate it 180 degrees, and flip it over. *Do not fan the paper.* Return the stack of paper to the tray.
2. Use only paper that meets HP specifications for this product.
3. Use paper that is not wrinkled, folded, or damaged. If necessary, use paper from a different package.
4. Make sure the tray is not overfilled. If it is, remove the entire stack of paper from the tray, straighten the stack, and then return some of the paper to the tray.
5. Make sure the paper guides in the tray are adjusted correctly for the size of paper. Adjust the guides so they are touching the paper stack without bending it.

Prevent paper jams

To reduce the number of paper jams, try these solutions.

1. Use only paper that meets HP specifications for this product.
2. Use paper that is not wrinkled, folded, or damaged. If necessary, use paper from a different package.
3. Use paper that has not previously been printed or copied on.

4. Make sure the tray is not overfilled. If it is, remove the entire stack of paper from the tray, straighten the stack, and then return some of the paper to the tray.
5. Make sure the paper guides in the tray are adjusted correctly for the size of paper. Adjust the guides so they are touching the paper stack without bending it.
6. Make sure that the tray is fully inserted in the product.
7. If you are printing on heavy, embossed, or perforated paper, use the manual feed feature and feed sheets one at a time.

Clear jams

Jam locations

Use this illustration to identify locations of jams. In addition, instructions appear on the control panel to direct you to the location of jammed paper and how to clear it.

 **NOTE:** Internal areas of the product that might need to be opened to clear jams have green handles or green labels.

 **WARNING!** To avoid electrical shock, remove any necklaces, bracelets, or other metal items before reaching into the inside of the product.

Figure 14-1 Jam locations



1	Document feeder
2	Top cover
3	Right door
4	Tray 1 area
5	Tray 2, and optional Trays 3, 4, and 5
6	Lower-right door

7	Stapler
8	Output bins

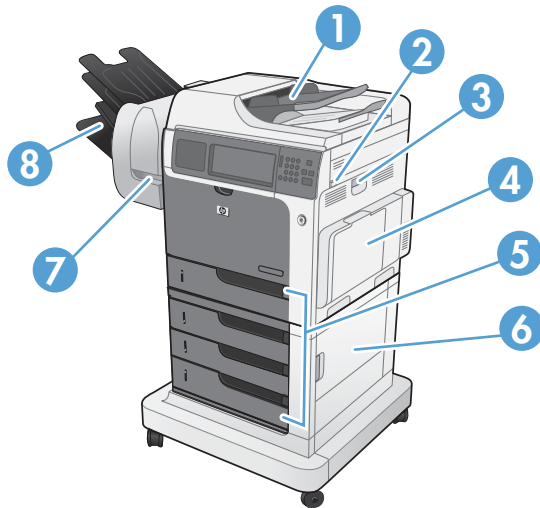
Clear jams in the document feeder

1. Open the document feeder cover.

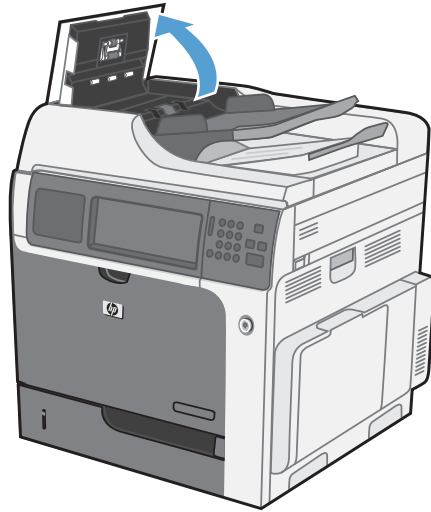

2. Lift the jam-access door, and remove any jammed paper.



3. Close the document feeder cover.

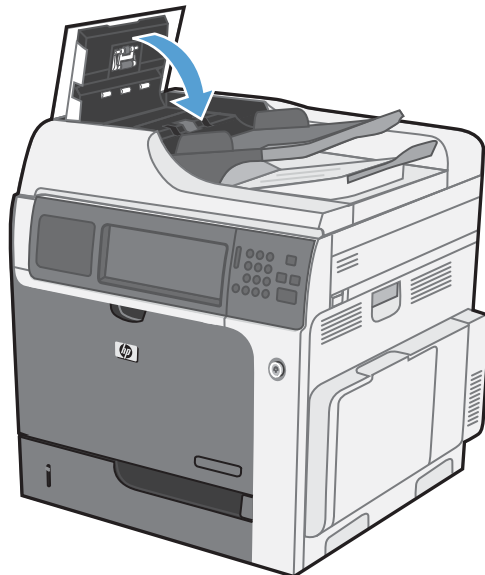

Clear paper jams in the stapler

1. Lift the gray latch on the front of the stapler, and open the stapler cover.

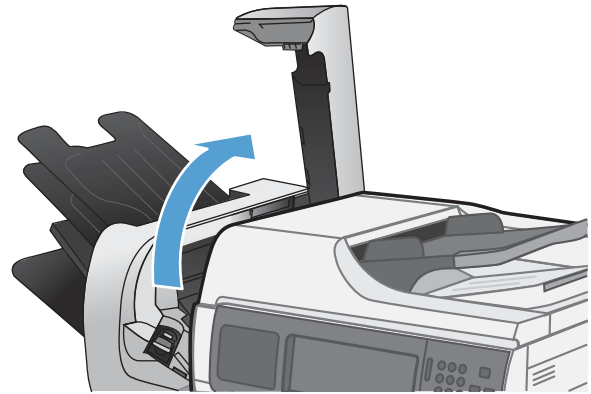

2. If jammed paper is visible underneath the paper guide, pull it straight out.

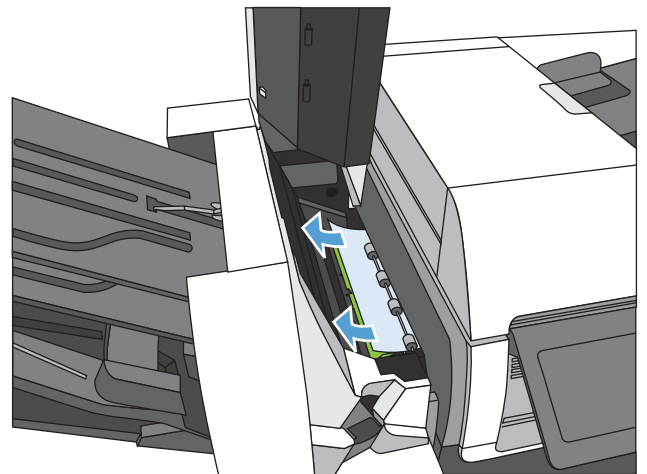

3. Lift the green jam-access door. If jammed paper is visible under the jam-access door, pull it straight out,

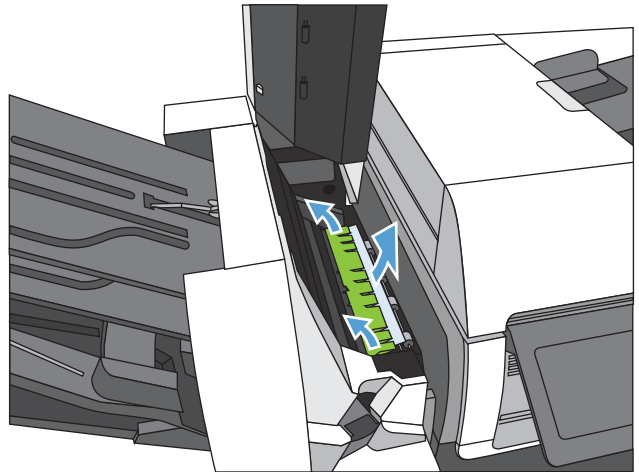

4. Close the stapler cover.

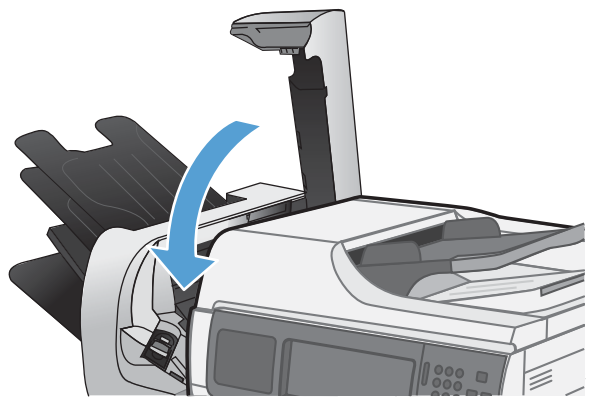

Clear staple jams

1. Lift the gray latch on the front of the stapler, and open the stapler cover.

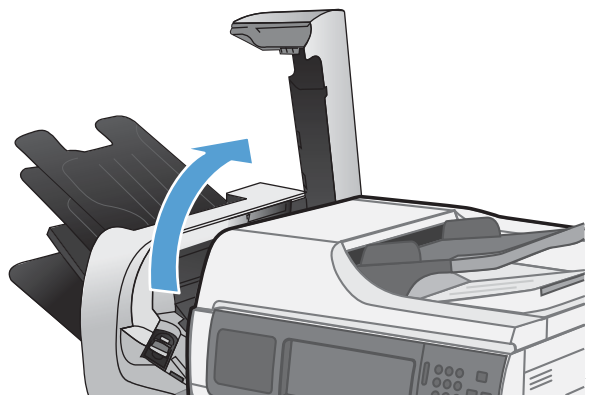

2. Lift the green tab on the staple cartridge up, and then pull the staple cartridge straight out.

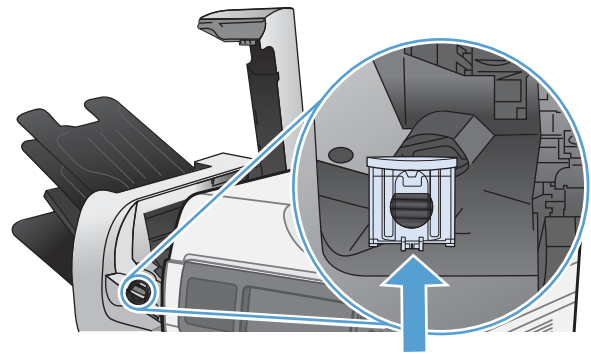

3. Lift up on the small lever at the back of the staple cartridge.

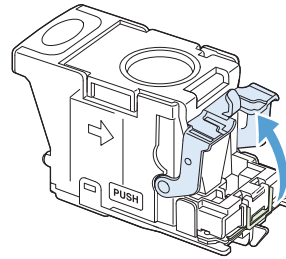

4. Remove the jammed staples.

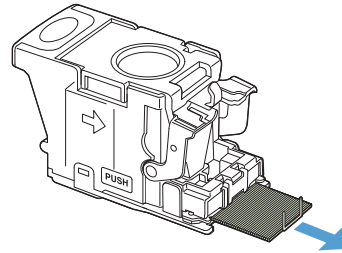

5. Close the lever at the back of the staple cartridge. Be sure that it snaps into place.

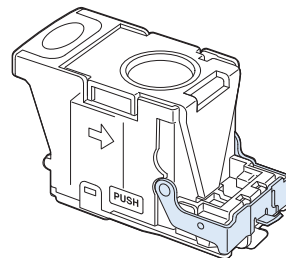

6. Insert the staple cartridge into the stapler and push down on the green handle until it snaps into place.

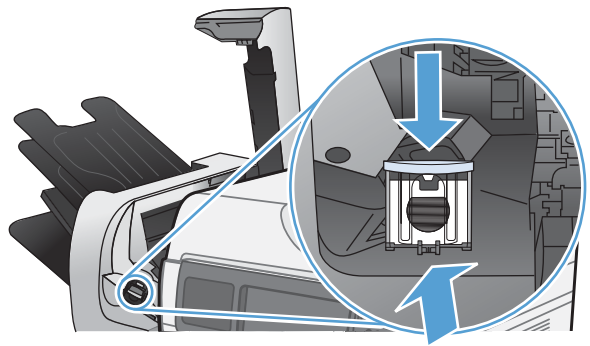

7. Close the stapler cover.

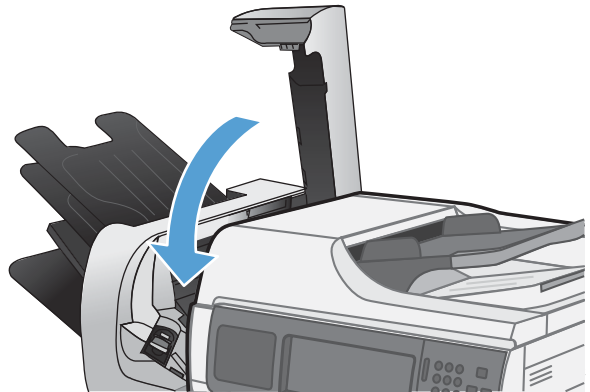

Clear jams in the output bin area

1. If paper is visible from the output bin, grasp the leading edge and remove it.

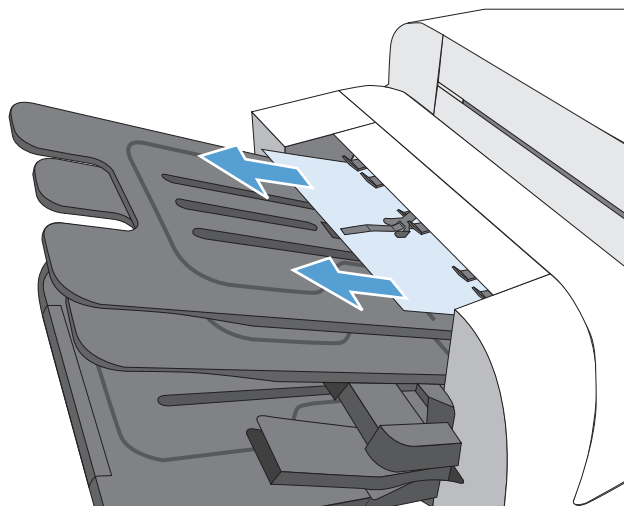

Clear jams from under the top cover

1. Pull the top-cover-release lever forward, and then lift the top cover up.

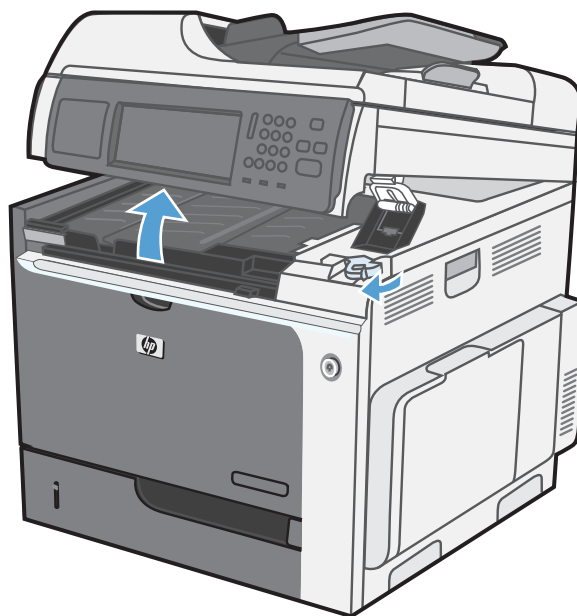

2. Remove any jammed sheets that are under the top cover.

CAUTION: Do not touch the foam rollers that are under the top cover. Contaminants can affect print quality.



3. Close the top cover.

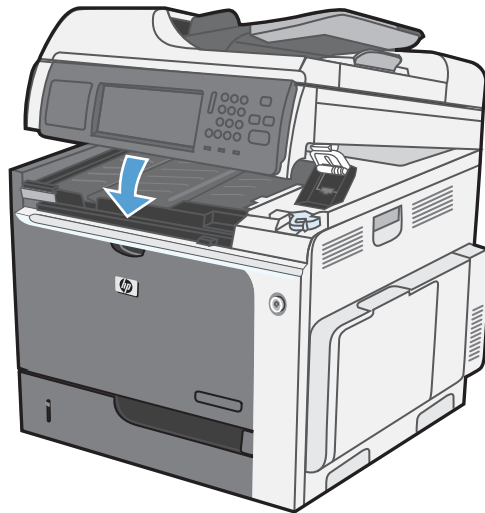

Clear jams in the right door

△ **CAUTION:** The fuser can be hot while the product is in use. Wait for the fuser to cool before handling it.

1. Open the right door.

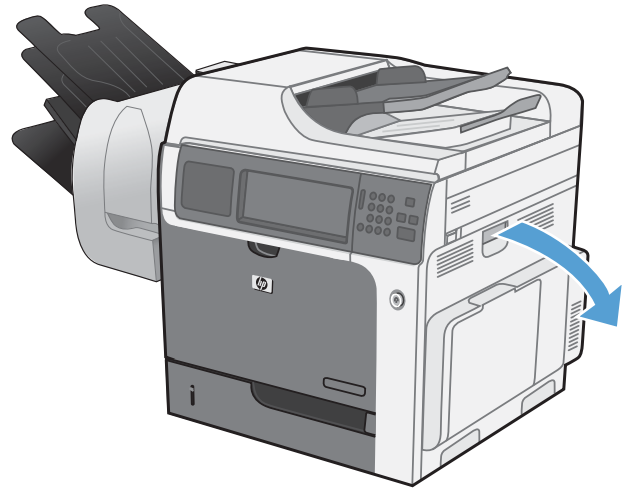

2. Gently pull the paper out of the pickup area.

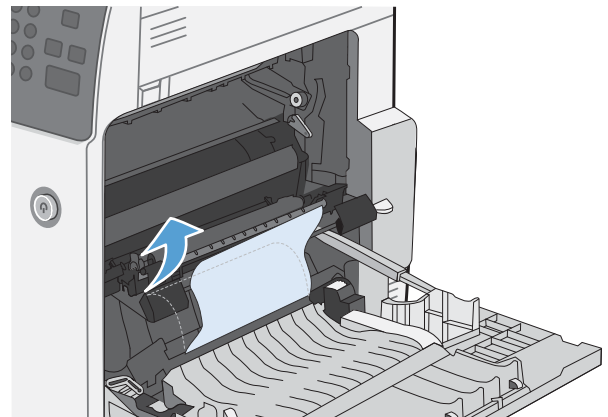

3. If paper is visible entering the bottom of the fuser, gently pull downward to remove it.

CAUTION: Do not touch the rollers on the transfer roller. Contaminants can affect print quality.

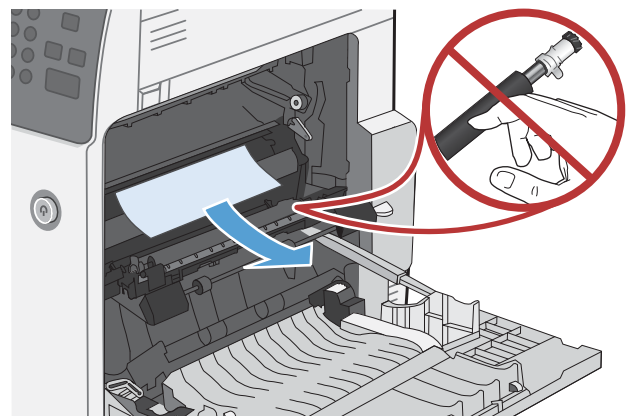

4. If paper is jammed as it enters the output bin, remove the fuser and gently pull the paper downward to remove it.

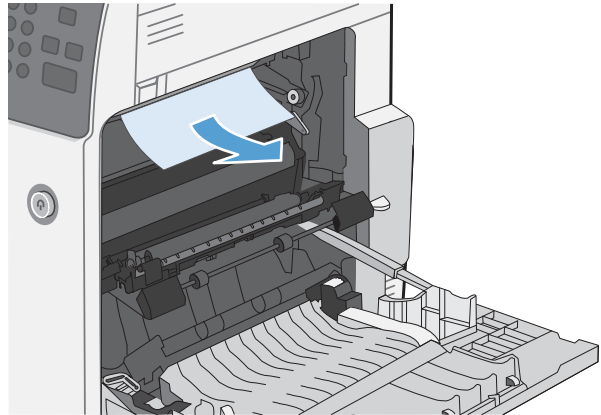

5. Paper could be jammed inside the fuser where it would not be visible. Grasp the fuser handles, lift up slightly, and then pull straight out to remove the fuser.

CAUTION: The fuser can be hot while the product is in use. Wait for the fuser to cool before handling it.

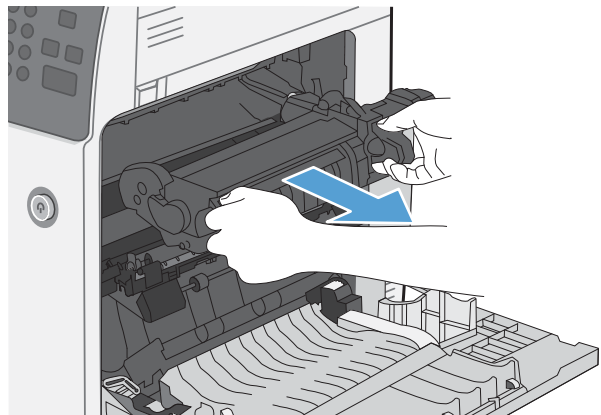

6. Open the jam-access door. If paper is jammed inside the fuser, gently pull it straight up to remove it. If the paper tears, remove all paper fragments.

CAUTION: Even if the body of the fuser has cooled, the rollers that are inside could still be hot. Do not touch the fuser rollers until they have cooled.

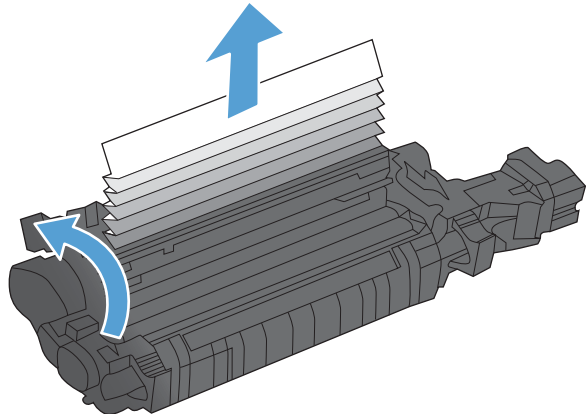

7. Close the jam-access door, and push the fuser completely into the product.

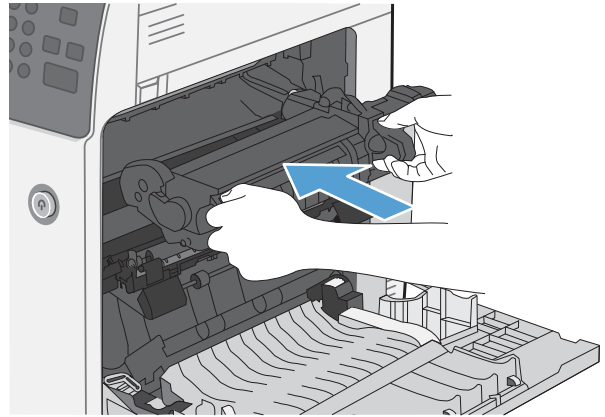

8. Close the right door.

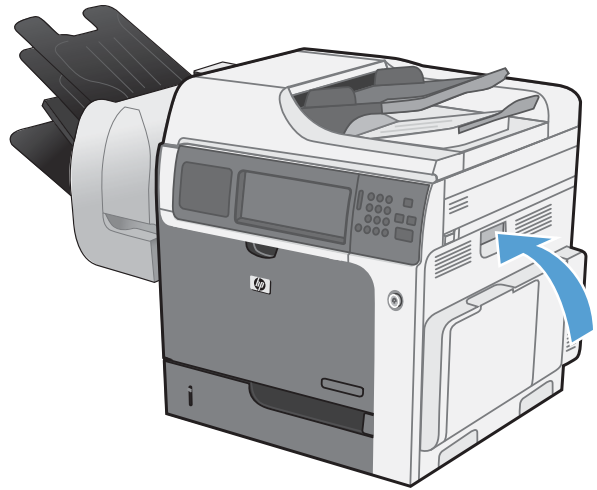

Clear jams in Tray 1

1. If jammed paper is visible in Tray 1, clear the jam by gently pulling the paper straight out. Touch the **OK** button to clear the message.

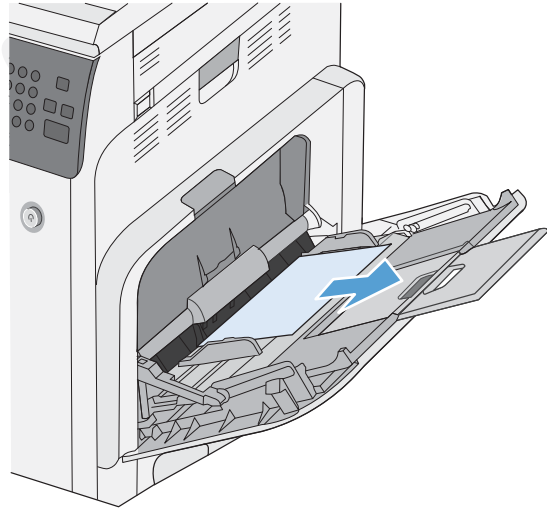

2. If you cannot remove the paper, or if no jammed paper is visible in Tray 1, close Tray 1 and open the right door.

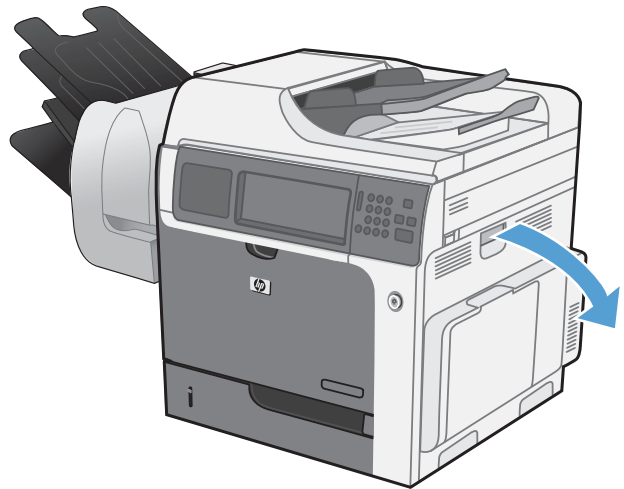

3. Gently pull the paper out of the pick up area.

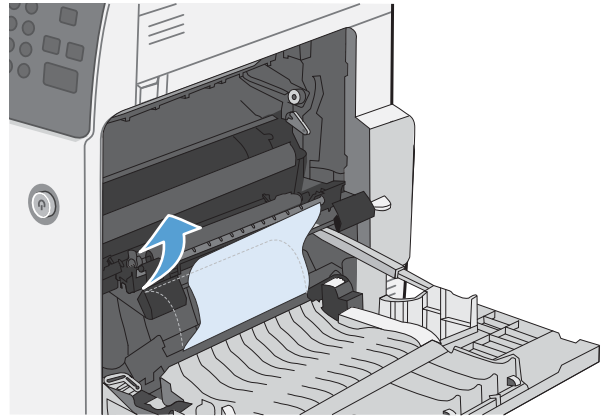

4. Close the right door.

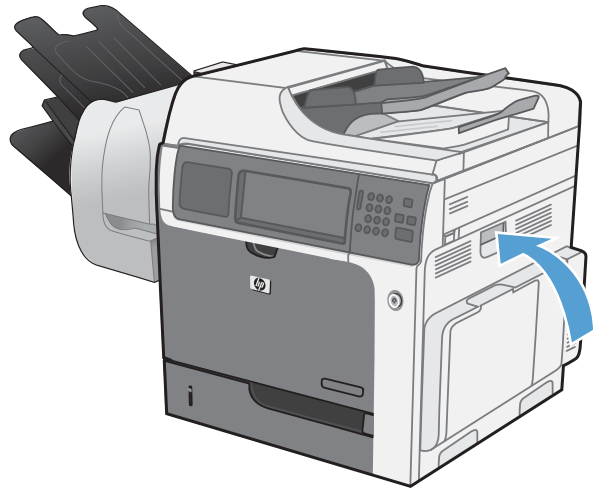

Clear jams in Trays 2, 3, 4, or 5

△ **CAUTION:** Opening a tray when paper is jammed can cause the paper to tear and leave pieces of paper in the tray, which might cause another jam. Be sure to clear jams before opening the tray.

1. Open the tray and make sure that the paper is stacked correctly. Remove any jammed or damaged sheets of paper. To access jammed paper from the tray cavity, remove the tray from the product.

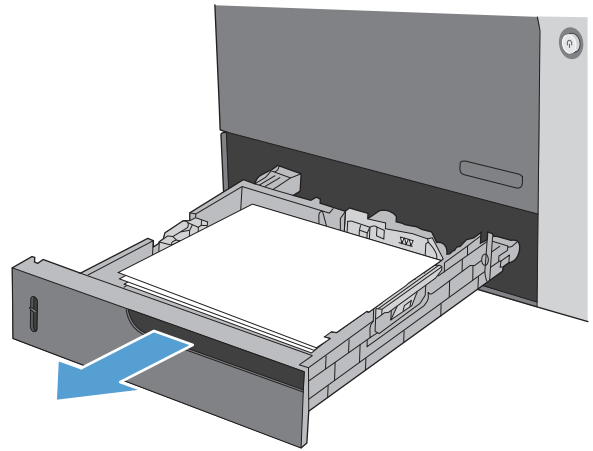

2. Close the tray.

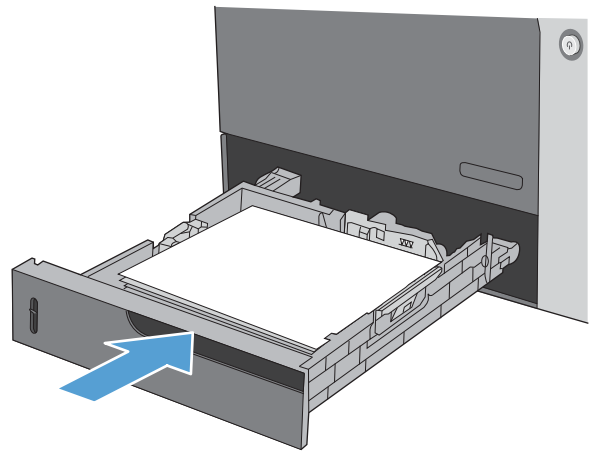

Clear jams in the lower-right door (Trays 3, 4, or 5)

1. Open the lower-right door.

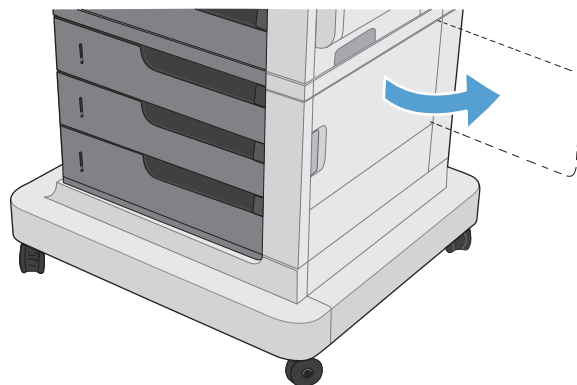

2. If paper is visible, gently pull the jammed paper up or down to remove it.

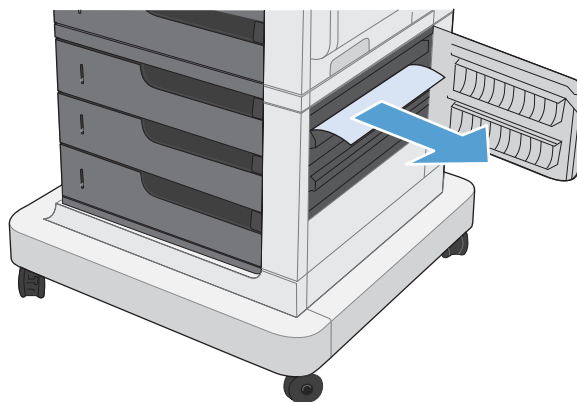

3. Close the lower-right door.

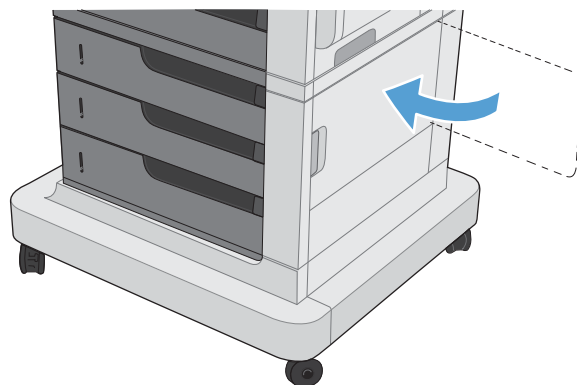

Change jam recovery

This product provides a jam recovery feature that reprints jammed pages.

1. From the Home screen, scroll to and touch the [Administration](#) button.



2. Open the [General Settings](#) menu, and then open the [Jam Recovery](#) menu.
3. Select one of the following options:
 - **Auto** — The product attempts to reprint jammed pages when sufficient memory is available. This is the default setting.
 - **Off** — The product does not attempt to reprint jammed pages. Because no memory is used to store the most recent pages, performance is optimal.

NOTE: When using this option, if the product runs out of paper and the job is being printed on both sides, some pages can be lost.

 - **On** — The product always reprints jammed pages. Additional memory is allocated to store the last few pages printed. This might cause overall performance to suffer.

Improve print quality

You can prevent most print-quality problems by following these guidelines.

- Use the correct paper type setting in the printer driver.
- Use paper that meets HP specifications for this product.
- Clean the product as necessary.
- Replace print cartridges when they are reaching the end of their estimated life and print quality is no longer acceptable.
- Use the printer driver that best meets your printing needs.

Select a paper type

1. Open the printer driver, click the **Properties** or **Preferences** button, and then click the **Paper/Quality** tab.
2. Select a type from the **Type is** drop-down list.
3. Click the **OK** button.

Use paper that meets HP specifications

Use different paper if you are having any of the following problems:

- The printing is too light or seems faded in areas.
- Specks of toner are on the printed pages.
- Toner is smearing on the printed pages.
- Printed characters seem misformed.
- Printed pages are curled.

Always use a paper type and weight that this product supports. In addition, follow these guidelines when selecting paper:

- Use paper that is of good quality and free of cuts, nicks, tears, spots, loose particles, dust, wrinkles, voids, staples, and curled or bent edges.
- Use paper that has not been previously printed on.
- Use paper that is designed for use in laser printers. Do not use paper that is designed only for use in Inkjet printers.
- Use paper that is not too rough. Using smoother paper generally results in better print quality.

Print a cleaning page

Print a cleaning page to remove dust and excess toner from the paper path if you are having any of the following problems:

- Specks of toner are on the printed pages.
- Toner is smearing on the printed pages.
- Repeated marks occur on the printed pages.

Use the following procedure to print a cleaning page.

1. From the Home screen, touch the [Device Maintenance](#) button.
2. Open the following menus:
 - [Calibration/Cleaning](#)
 - [Cleaning Page](#)
3. Touch the [Print](#) button to print the page.
4. The cleaning process can take several minutes. When it is finished, discard the printed page.

Calibrate the product

Calibration is a product function that optimizes print quality. If you experience any image-quality problems, calibrate the product.

1. From the Home screen, touch the [Device Maintenance](#) button.
2. Open the following menus:
 - [Calibration/Cleaning](#)
 - [Full Calibration](#)
3. Wait while the product calibrates, and then try printing again.

Set the image registration

If you are having problems with text aligning on the page, use the [Set Registration](#) menu to set the image registration.

1. From the Home screen, touch the [Administration](#) button.
2. Open the following menus:
 - a. [General Settings](#)
 - b. [Print Quality](#)
 - c. [Image Registration](#)
 - d. [Adjust Tray <X>](#)

3. Touch the [Print Test Page](#) setting, and then touch the [OK](#) button.
4. Follow the instructions on the test page to complete the adjustment.

Internal print-quality-test pages

Use the built-in print-quality-troubleshooting pages to help diagnose and solve print-quality problems.

1. From the Home screen, touch the [Administration](#) button.
2. Open the following menus:
 - [Troubleshooting](#)
 - [Print Quality Pages](#)
 - [PQ Troubleshooting Pages](#)
3. Touch the [Print](#) button. Follow the instructions on the pages that print.

Check the print cartridge

Check each print cartridge, and replace it if necessary, if you are having any of the following problems:

- The printing is too light or seems faded in areas.
- Printed pages have small unprinted areas.
- Printed pages have streaks or bands.

 **NOTE:** If you are using a draft or EconoMode print setting, the printing might appear light.

If you determine that you need to replace a print cartridge, print the supplies status page to find the part number for the correct genuine HP print cartridge.

Type of print cartridge	Steps to resolve the problem
Refilled or remanufactured print cartridge	Hewlett-Packard Company cannot recommend the use of non-HP supplies, either new or remanufactured. Because they are not HP products, HP cannot influence their design or control their quality. If you are using a refilled or remanufactured print cartridge and are not satisfied with the print quality, replace the cartridge with a genuine HP cartridge that has the words "HP" or "Hewlett-Packard" on it, or has the HP logo on it.
Genuine HP print cartridge	<ol style="list-style-type: none"> 1. The product control panel or the supplies status page indicates Very Low status when the cartridge has reached the end of its designated life. Replace the print cartridge if print quality is no longer acceptable. 2. Visually inspect the print cartridge for damage. See the instructions that follow. Replace the print cartridge if necessary. 3. If printed pages have marks that repeat several times at the same distance apart, print a cleaning page. If this does not solve the problem, use the repeating defects information in this document to identify the cause of the problem.

Use the printer driver that best meets your printing needs

You might need to use a different printer driver if the printed page has unexpected lines in graphics, missing text, missing graphics, incorrect formatting, or substituted fonts.

HP PCL 6 driver

- Provided as the default driver. This driver is automatically installed unless you select a different one.
- Recommended for all Windows environments
- Provides the overall best speed, print quality, and product-feature support for most users
- Developed to align with the Windows Graphic Device Interface (GDI) for the best speed in Windows environments
- Might not be fully compatible with third-party and custom software programs that are based on PCL 5

HP UPD PS driver

- Recommended for printing with Adobe® software programs or with other highly graphics-intensive software programs
- Provides support for printing from postscript emulation needs, or for postscript flash font support

HP UPD PCL 5

- Recommended for general office printing in Windows environments
- Compatible with previous PCL versions and older HP LaserJet products
- The best choice for printing from third-party or custom software programs
- The best choice when operating with mixed environments, which require the product to be set to PCL 5 (UNIX, Linux, mainframe)
- Designed for use in corporate Windows environments to provide a single driver for use with multiple printer models
- Preferred when printing to multiple printer models from a mobile Windows computer

HP UPD PCL 6

- Recommended for printing in all Windows environments
 - Provides the overall best speed, print quality, and printer feature support for most users
 - Developed to align with Windows Graphic Device Interface (GDI) for best speed in Windows environments
 - May not be fully compatible with third-party and custom solutions based on PCL5
-

Download additional printer drivers from this Web site: www.hp.com/go/cljcm4540mfp_software.

Improve print quality for copies

If you encounter print quality problems in copied documents, review the solutions for printed documents listed previously in this document. However, some print-quality problems occur only in copied documents.

- If streaks appear on copies made by using the document feeder, clean the small glass strip on the left side of the scanner assembly.
- If dots or other defects appear on copies made by using the scanner glass, clean the scanner glass and the white plastic backing.

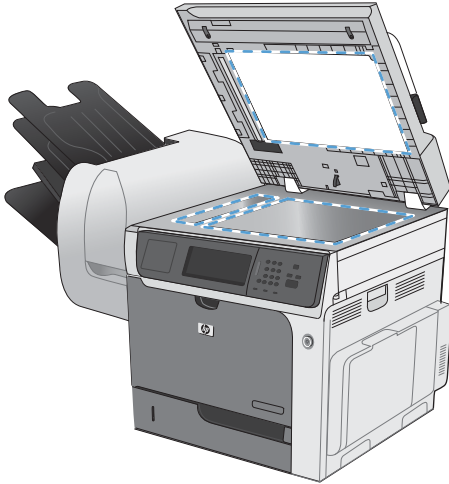

1. Use the power switch to turn off the product, and then unplug the power cord from the electrical socket.
2. Open the scanner lid.
3. Clean the scanner glass and the white plastic backing with a soft cloth or sponge that has been moistened with nonabrasive glass cleaner.

△ **CAUTION:** Do not use abrasives, acetone, benzene, ammonia, ethyl alcohol, or carbon tetrachloride on any part of the product; these can damage the product. Do not place liquids directly on the glass or platen. They might seep and damage the product.

4. Dry the glass and white plastic backing with a chamois or a cellulose sponge to prevent spotting.
5. Plug in the product, and then use the power switch to turn on the product.

The product does not print or it prints slowly

The product does not print

If the product does not print at all, try the following solutions.

1. Make sure the product is turned on and that the control panel indicates it is ready.
 - If the control panel does not indicate the product is ready, turn the product off and then on again.
 - If the control panel indicates the product is ready, try sending the job again.
2. If the control panel indicates the product has an error, resolve the error and then try sending the job again.
3. Make sure the cables are all connected correctly. If the product is connected to a network, check the following items:
 - Check the light next to the network connection on the product. If the network is active, the light is green.
 - Make sure that you are using a network cable and not a phone cord to connect to the network.
 - Make sure the network router, hub, or switch is turned on and that it is working correctly.
4. Install the HP software from the CD that came with the product. Using generic printer drivers can cause delays clearing jobs from the print queue.
5. From the list of printers on your computer, right-click the name of this product, click **Properties**, and open the **Ports** tab.
 - If you are using a network cable to connect to the network, make sure the printer name listed on the **Ports** tab matches the product name on the product configuration page.
 - If you are using a USB cable and are connecting to a wireless network, make sure the box is checked next to **Virtual printer port for USB**.
6. If you are using a personal firewall system on the computer, it might be blocking communication with the product. Try temporarily disabling the firewall to see if it is the source of the problem.
7. If your computer or the product is connected to a wireless network, low signal quality or interference might be delaying print jobs.

The product prints slowly

If the product prints, but it seems slow, try the following solutions.

1. Make sure the computer meets the minimum specifications for this product. For a list of specifications, go to this Web site: www.hp.com/support/cljcm4540mfp.
2. When you configure the product to print on some paper types, such as heavy paper, the product prints more slowly so it can correctly fuse the toner to the paper. If the paper type setting is not correct for the type of paper you are using, change the setting to the correct paper type.
3. If your computer is connected to a wireless network, low signal quality or interference might be delaying print jobs.

Solve walk-up USB printing problems

- [The Open from USB menu does not open when you insert the USB accessory](#)
- [The file does not print from the USB storage accessory](#)
- [The file that you want to print is not listed in the Open from USB menu](#)

The Open from USB menu does not open when you insert the USB accessory

1. You might be using a USB storage accessory or a file system that this product does not support. Save the files on a standard USB storage accessory that uses File Allocation Table (FAT) file systems. The product supports FAT12, FAT16, and FAT32 USB storage accessories.
2. If another menu is already open, close that menu and then reinsert the USB storage accessory.
3. The USB storage accessory might have multiple partitions. (Some USB storage accessory manufacturers install software on the accessory that creates partitions, similar to a CD.) Reformat the USB storage accessory to remove the partitions, or use a different USB storage accessory.
4. The USB storage accessory might require more power than the product can provide.
 - a. Remove the USB storage accessory.
 - b. Turn the product off and then on.
 - c. Use a USB storage accessory that has its own power supply or that requires less power.
5. The USB storage accessory might not be functioning correctly.
 - a. Remove the USB storage accessory.
 - b. Turn the product off and then on.
 - c. Try printing from another USB storage accessory.

The file does not print from the USB storage accessory

1. Make sure paper is in the tray.
2. Check the control panel for messages. If paper is jammed in the product, clear the jam.

The file that you want to print is not listed in the Open from USB menu

1. You might be trying to print a file type that the USB printing feature does not support. The product supports .pdf, .prn, .pcl, .ps, and .cht file types.
2. You might have too many files in a single folder on the USB storage accessory. Reduce the number of files in the folder by moving them to subfolders.
3. You might be using a character set for the file name that the product does not support. In this case, the product replaces the file names with characters from a different character set. Rename the files using ASCII characters.

Solve connectivity problems

Solve direct-connect problems

If you have connected the product directly to a computer, check the cable.

- Verify that the cable is connected to the computer and to the product.
- Verify that the cable is not longer than 5 m (16.4 ft). Try using a shorter cable.
- Verify that the cable is working correctly by connecting it to another product. Replace the cable if necessary.

Solve network problems

Check the following items to verify that the product is communicating with the network. Before beginning, print a configuration page from the product control panel and locate the product IP address that is listed on this page.

- [Poor physical connection](#)
- [The computer is using the incorrect IP address for the product](#)
- [The computer is unable to communicate with the product](#)
- [The product is using incorrect link and duplex settings for the network](#)
- [New software programs might be causing compatibility problems](#)
- [The computer or workstation might be set up incorrectly](#)
- [The product is disabled, or other network settings are incorrect](#)

Poor physical connection

1. Verify that the product is attached to the correct network port using a cable of the correct length.
2. Verify that cable connections are secure.
3. Look at the network port connection on the back of the product, and verify that the amber activity light and the green link-status light are lit.
4. If the problem continues, try a different cable or port on the hub.

The computer is using the incorrect IP address for the product

1. Open the printer properties and click the **Ports** tab. Verify that the current IP address for the product is selected. The product IP address is listed on the product configuration page.
2. If you installed the product using the HP standard TCP/IP port, select the box labeled **Always print to this printer, even if its IP address changes.**

3. If you installed the product using a Microsoft standard TCP/IP port, use the hostname instead of the IP address.
4. If the IP address is correct, delete the product and then add it again.

The computer is unable to communicate with the product

1. Test network communication by pinging the network.
 - a. Open a command-line prompt on your computer. For Windows, click **Start**, click **Run**, and then type `cmd`.
 - b. Type `ping` followed by the IP address for your product.
 - c. If the window displays round-trip times, the network is working.
2. If the ping command failed, verify that the network hubs are on, and then verify that the network settings, the product, and the computer are all configured for the same network.

The product is using incorrect link and duplex settings for the network

Hewlett-Packard recommends leaving this setting in automatic mode (the default setting). If you change these settings, you must also change them for your network.

New software programs might be causing compatibility problems

Verify that any new software programs are correctly installed and that they use the correct printer driver.

The computer or workstation might be set up incorrectly

1. Check the network drivers, printer drivers, and the network redirection.
2. Verify that the operating system is configured correctly.

The product is disabled, or other network settings are incorrect

1. Review the configuration page to check the status of the network protocol. Enable it if necessary.
2. Reconfigure the network settings if necessary.

Solve product software problems with Windows

Problem	Solution
A printer driver for the product is not visible in the Printer folder	<p>Reinstall the product software.</p> <p>NOTE: Close any applications that are running. To close an application that has an icon in the system tray, right-click the icon, and select Close or Disable.</p> <p>Try plugging the USB cable into a different USB port on the computer.</p>
An error message was displayed during the software installation	<p>Reinstall the product software.</p> <p>NOTE: Close any applications that are running. To close an application that has an icon in the task bar, right-click the icon, and select Close or Disable.</p> <p>Check the amount of free space on the drive where you are installing the product software. If necessary, free up as much space as you can, and reinstall the product software.</p> <p>If necessary, run the Disk Defragmenter, and reinstall the product software.</p>
The product is in Ready mode, but nothing prints	<p>Print a Configuration page, and verify the product functionality.</p> <p>Verify that all of the cables are correctly seated and within specifications. This includes the USB and power cables. Try a new cable.</p> <p>Verify the IP Address on the Embedded Jetdirect Page matches the IP address for the software port. Use one of the following procedures:</p>
Windows XP, Windows Server 2003, Windows Server 2008, and Windows Vista	<ol style="list-style-type: none"> 1. Click Start. 2. Click Settings. 3. Click Printers and Faxes (using the default Start menu view) or click Printers (using the Classic Start menu view). 4. Right-click the product driver icon, and then select Properties. 5. Click the Ports tab, and then click Configure Port. 6. Verify the IP address, and then click OK or Cancel. 7. If the IP Addresses are not the same, delete the driver, and reinstall the driver using the correct IP address.
Windows 7	<ol style="list-style-type: none"> 1. Click Start. 2. Click Devices and Printers. 3. Right-click the product driver icon, and then select Printer properties. 4. Click the Ports tab, and then click Configure Port. 5. Verify the IP address, and then click OK or Cancel. 6. If the IP Addresses are not the same, delete the driver, and reinstall the driver using the correct IP address.

Solve product software problems with Mac

- [The printer driver is not listed in the Print & Fax list](#)
- [The product name does not appear in the product list in the Print & Fax list](#)
- [The printer driver does not automatically set up the selected product in the Print & Fax list](#)
- [A print job was not sent to the product that you wanted](#)
- [When connected with a USB cable, the product does not appear in the Print & Fax list after the driver is selected.](#)
- [You are using a generic printer driver when using a USB connection](#)

The printer driver is not listed in the Print & Fax list

1. Make sure that the product .GZ file is in the following hard-drive folder: Library/Printers/PPDs/Contents/Resources. If necessary, reinstall the software.
2. If the GZ file is in the folder, the PPD file might be corrupt. Delete the file and then reinstall the software.

The product name does not appear in the product list in the Print & Fax list

1. Make sure that the cables are connected correctly and the product is on.
2. Print a configuration page to check the product name. Verify that the name on the configuration page matches the product name in the Print & Fax list.
3. Replace the USB or network cable with a high-quality cable.

The printer driver does not automatically set up the selected product in the Print & Fax list

1. Make sure that the cables are connected correctly and the product is on.
2. Make sure that the product .GZ file is in the following hard-drive folder: Library/Printers/PPDs/Contents/Resources. If necessary, reinstall the software.
3. If the GZ file is in the folder, the PPD file might be corrupt. Delete the file and then reinstall the software.
4. Replace the USB or network cable with a high-quality cable.

A print job was not sent to the product that you wanted

1. Open the print queue and restart the print job.
2. Another product with the same or similar name might have received your print job. Print a configuration page to check the product name. Verify that the name on the configuration page matches the product name in the Print & Fax list.

When connected with a USB cable, the product does not appear in the Print & Fax list after the driver is selected.

Software troubleshooting

- ▲ Make sure that your Mac operating system is Mac OS X 10.5 or later.

Hardware troubleshooting

1. Make sure that the product is turned on.
2. Make sure that the USB cable is connected correctly.
3. Make sure that you are using the appropriate high-speed USB cable.
4. Make sure that you do not have too many USB devices drawing power from the chain. Disconnect all of the devices from the chain, and connect the cable directly to the USB port on the computer.
5. Check to see if more than two non-powered USB hubs are connected in a row on the chain. Disconnect all of the devices from the chain, and then connect the cable directly to the USB port on the computer.



NOTE: The iMac keyboard is a non-powered USB hub.

You are using a generic printer driver when using a USB connection

If you connected the USB cable before you installed the software, you might be using a generic printer driver instead of the driver for this product.

1. Delete the generic printer driver.
2. Reinstall the software from the product CD. Do not connect the USB cable until the software installation program prompts you.
3. If multiple printers are installed, make sure that you have selected the correct printer in the **Format For** drop-down menu in the **Print** dialog box.

A Product supplies and accessories

- [Order parts, accessories, and supplies](#)
- [Part numbers](#)

Order parts, accessories, and supplies

Order supplies and paper	www.hp.com/go/suresupply
Order genuine HP parts or accessories	www.hp.com/buy/parts
Order through service or support providers	Contact an HP-authorized service or support provider.
Order using HP software	Use the HP Embedded Web Server on page 266

Part numbers

Accessories

Item	Description	Product number
HP Color LaserJet 500-sheet Paper Feeder and Cabinet	500-sheet paper tray with a storage cabinet.	CC422A
HP Color LaserJet 3 x 500-sheet Paper Feeder and Stand	1500-sheet paper tray. Contains three 500-sheet trays and a stand.	CC423A
HP LaserJet 900-sheet 3-bin Stapling Mailbox	Stapler with a 3-bin output mailbox that holds up to 900 sheets.	CC424A
HP Color LaserJet 500-sheet Paper Feeder	500-sheet input tray (no storage cabinet or stand)	CC425A
HP LaserJet MFP Analog Fax Accessory 500	Provides fax capability for the product. This is included with the CM4540f MFP and CM4540fskm MFP models.	CC487A

Cables and interfaces

Item	Description	Product number
Enhanced I/O (EIO) card	HP Jetdirect 635n IPv6/IPsec Print Server	J7961G
USB cable	2-meter standard USB-compatible device connector	C6518A

Customer self-repair parts

The following Customer Self-Repair parts are available for your product.

- Parts listed as **Mandatory** self-replacement are to be installed by customers, unless you are willing to pay HP service personnel to perform the repair. For these parts, on-site or return-to-depot support is not provided under your HP product warranty.
- Parts listed as **Optional** self-replacement may be installed by HP service personnel at your request for no additional charge during the product warranty period.

 **NOTE:** For more information, go to www.hp.com/go/learnaboutesupplies.

Table A-1 Customer self-repair parts

Item	Description	Self-replacement options	Product number	Part number
HP Color LaserJet black print cartridge	Standard black cartridge	Mandatory	CE260A	CE260-67901

Table A-1 Customer self-repair parts (continued)

Item	Description	Self-replacement options	Product number	Part number
HP Color LaserJet black print cartridge	High-capacity black cartridge	Mandatory	CE264X	CE264-67901
HP Color LaserJet cyan print cartridge	Cyan cartridge	Mandatory	CF031A	CF031-67901
HP Color LaserJet yellow print cartridge	Yellow cartridge	Mandatory	CF032A	CF032-67901
HP Color LaserJet magenta print cartridge	Magenta cartridge	Mandatory	CF033A	CF033-67901
HP Color LaserJet Toner Collection Unit	Receptacle for toner that has not fused to the paper.	Mandatory	CE265A	CC493-67913
HP Staple cartridge	Replacement staple cartridge, which holds 5,000 staples	Mandatory	C8091A	
HP Color LaserJet fuser kit	Replacement fuser	Mandatory	110 Volt fuser: CE246A 200 Volt fuser: CE247A	110 Volt fuser: CC493-67911 200 Volt fuser: CC493-67912
Fuser cleaning kit	Includes 50 sheets of HP LaserJet Tough Paper and instructions to clean the fuser	Mandatory		CC419-67905
Document feeder maintenance kit	Includes a replacement roller assembly and separation pad for the document feeder	Mandatory	CE248A	CE248-67901
HP Color LaserJet image transfer kit	Replacement transfer unit, transfer roller, Tray 1 pickup roller, and eight feed and separation rollers for Trays 2-5.	Mandatory	CE249A	CC493-67910
Repair maintenance kit	Replacement transfer unit and transfer roller	Mandatory		CC493-67909
Control panel kit	Replacement control panel	Optional		CC419-67901
HP LaserJet 900-sheet 3-bin Stapling Mailbox	Replacement stapler/stacker	Mandatory	CC424A	CC424-67901
HP Color LaserJet 500-sheet Paper Feeder	500-sheet input tray (no storage cabinet or stand)	Mandatory	CC425A	CC425-67901
HP Color LaserJet 500-sheet Paper Feeder and Cabinet	500-sheet paper tray with a storage cabinet	Mandatory	CC422A	CC493-67902

Table A-1 Customer self-repair parts (continued)

Item	Description	Self-replacement options	Product number	Part number
HP Color LaserJet 3 x 500-sheet Paper Feeder and Stand	1 500-sheet paper tray. Contains three 500-sheet trays and a stand.	Mandatory	CC423A	CC493-67903
HP LaserJet MFP Analog Fax Accessory 500	Provides fax capability for the product. This is included with the CM4540f MFP and CM4540fskm MFP models.	Mandatory	CC487A	CC456-60002
Feed roller and separation roller kit for Trays 2–5	One feed roller and eight separation rollers	Mandatory		CC493-67907
Tray 1 roller kit	Pickup roller for Tray 1	Mandatory		CC493-67906
Formatter assembly kit	Replacement formatter (requires you to exchange the previous formatter)	Mandatory		CE871-69001
Internal hard disk assembly kit	Replacement HP Encrypted High Performance Hard Disk	Mandatory		CC419-67902
Output bin bezel	Replacement bezel for using the standard output bin	Mandatory		CC419-67904
Document feeder bin extension	Replacement long-paper extension for the document feeder output bin	Mandatory		CC419-67903
Secondary transfer roller kit	Replacement roller	Mandatory		CC493-67908
Document feeder feed roller	Replacement roller	Mandatory		PF2309K131NI
Document feeder pickup roller	Replacement roller	Mandatory		PF2309K132NI
Document feeder separation pad	Replacement separation pad	Mandatory		PF2309K133NI
Document feeder separation pad spring	Replacement spring	Mandatory		PF2309P322NI
Tray 2, 3, 4, or 5	Replacement paper cassette	Mandatory		RM1-5928-000CN
Pickup roller for Trays 2–5	Replacement roller	Mandatory		RL1-2099-000CN

B Service and support

- [Hewlett-Packard limited warranty statement](#)
- [HP's Premium Protection Warranty: LaserJet print cartridge limited warranty statement](#)
- [Color LaserJet Fuser Kit, Transfer Kit, and Roller Kit Limited Warranty Statement](#)
- [Data stored on the print cartridge](#)
- [End User License Agreement](#)
- [OpenSSL](#)
- [Customer self-repair warranty service](#)
- [Customer support](#)

Hewlett-Packard limited warranty statement

HP PRODUCT	DURATION OF LIMITED WARRANTY
HP Color LaserJet CM4540, CM4540f, CM4540fskm	One-year on-site warranty

HP warrants to you, the end-user customer, that HP hardware and accessories will be free from defects in materials and workmanship after the date of purchase, for the period specified above. If HP receives notice of such defects during the warranty period, HP will, at its option, either repair or replace products which prove to be defective. Replacement products may be either new or equivalent in performance to new.

HP warrants to you that HP software will not fail to execute its programming instructions after the date of purchase, for the period specified above, due to defects in material and workmanship when properly installed and used. If HP receives notice of such defects during the warranty period, HP will replace software which does not execute its programming instructions due to such defects.

HP does not warrant that the operation of HP products will be uninterrupted or error free. If HP is unable, within a reasonable time, to repair or replace any product to a condition as warranted, you will be entitled to a refund of the purchase price upon prompt return of the product.

HP products may contain remanufactured parts equivalent to new in performance or may have been subject to incidental use.

Warranty does not apply to defects resulting from (a) improper or inadequate maintenance or calibration, (b) software, interfacing, parts or supplies not supplied by HP, (c) unauthorized modification or misuse, (d) operation outside of the published environmental specifications for the product, or (e) improper site preparation or maintenance.

TO THE EXTENT ALLOWED BY LOCAL LAW, THE ABOVE WARRANTIES ARE EXCLUSIVE AND NO OTHER WARRANTY OR CONDITION, WHETHER WRITTEN OR ORAL, IS EXPRESSED OR IMPLIED AND HP SPECIFICALLY DISCLAIMS ANY IMPLIED WARRANTIES OR CONDITIONS OF MERCHANTABILITY, SATISFACTORY QUALITY, AND FITNESS FOR A PARTICULAR PURPOSE. Some countries/regions, states or provinces do not allow limitations on the duration of an implied warranty, so the above limitation or exclusion might not apply to you. This warranty gives you specific legal rights and you might also have other rights that vary from country/region to country/region, state to state, or province to province.

HP's limited warranty is valid in any country/region or locality where HP has a support presence for this product and where HP has marketed this product. The level of warranty service you receive may vary according to local standards. HP will not alter form, fit or function of the product to make it operate in a country/region for which it was never intended to function for legal or regulatory reasons.

TO THE EXTENT ALLOWED BY LOCAL LAW, THE REMEDIES IN THIS WARRANTY STATEMENT ARE YOUR SOLE AND EXCLUSIVE REMEDIES. EXCEPT AS INDICATED ABOVE, IN NO EVENT WILL HP OR ITS SUPPLIERS BE LIABLE FOR LOSS OF DATA OR FOR DIRECT, SPECIAL, INCIDENTAL, CONSEQUENTIAL (INCLUDING LOST PROFIT OR DATA), OR OTHER DAMAGE, WHETHER BASED IN CONTRACT, TORT, OR OTHERWISE. Some countries/regions, states or provinces do not allow the exclusion or limitation of incidental or consequential damages, so the above limitation or exclusion may not apply to you.

THE WARRANTY TERMS CONTAINED IN THIS STATEMENT, EXCEPT TO THE EXTENT LAWFULLY PERMITTED, DO NOT EXCLUDE, RESTRICT OR MODIFY AND ARE IN ADDITION TO THE MANDATORY STATUTORY RIGHTS APPLICABLE TO THE SALE OF THIS PRODUCT TO YOU.

HP's Premium Protection Warranty: LaserJet print cartridge limited warranty statement

This HP product is warranted to be free from defects in materials and workmanship.

This warranty does not apply to products that (a) have been refilled, refurbished, remanufactured or tampered with in any way, (b) experience problems resulting from misuse, improper storage, or operation outside of the published environmental specifications for the printer product or (c) exhibit wear from ordinary use.

To obtain warranty service, please return the product to place of purchase (with a written description of the problem and print samples) or contact HP customer support. At HP's option, HP will either replace products that prove to be defective or refund your purchase price.

TO THE EXTENT ALLOWED BY LOCAL LAW, THE ABOVE WARRANTY IS EXCLUSIVE AND NO OTHER WARRANTY OR CONDITION, WHETHER WRITTEN OR ORAL, IS EXPRESSED OR IMPLIED AND HP SPECIFICALLY DISCLAIMS ANY IMPLIED WARRANTIES OR CONDITIONS OF MERCHANTABILITY, SATISFACTORY QUALITY, AND FITNESS FOR A PARTICULAR PURPOSE.

TO THE EXTENT ALLOWED BY LOCAL LAW, IN NO EVENT WILL HP OR ITS SUPPLIERS BE LIABLE FOR DIRECT, SPECIAL, INCIDENTAL, CONSEQUENTIAL (INCLUDING LOST PROFIT OR DATA), OR OTHER DAMAGE, WHETHER BASED IN CONTRACT, TORT, OR OTHERWISE.

THE WARRANTY TERMS CONTAINED IN THIS STATEMENT, EXCEPT TO THE EXTENT LAWFULLY PERMITTED, DO NOT EXCLUDE, RESTRICT OR MODIFY AND ARE IN ADDITION TO THE MANDATORY STATUTORY RIGHTS APPLICABLE TO THE SALE OF THIS PRODUCT TO YOU.

Color LaserJet Fuser Kit, Transfer Kit, and Roller Kit Limited Warranty Statement

This HP product is warranted to be free from defects in materials and workmanship until the printer provides a low-life indicator on the control panel.

This warranty does not apply to products that (a) have been refurbished, remanufactured or tampered with in any way, (b) experience problems resulting from misuse, improper storage, or operation outside of the published environmental specifications for the printer product or (c) exhibit wear from ordinary use.

To obtain warranty service, please return the product to place of purchase (with a written description of the problem) or contact HP customer support. At HP's option, HP will either replace products that prove to be defective or refund your purchase price.

TO THE EXTENT ALLOWED BY LOCAL LAW, THE ABOVE WARRANTY IS EXCLUSIVE AND NO OTHER WARRANTY OR CONDITION, WHETHER WRITTEN OR ORAL, IS EXPRESSED OR IMPLIED AND HP SPECIFICALLY DISCLAIMS ANY IMPLIED WARRANTIES OR CONDITIONS OF MERCHANTABILITY, SATISFACTORY QUALITY, AND FITNESS FOR A PARTICULAR PURPOSE.

TO THE EXTENT ALLOWED BY LOCAL LAW, IN NO EVENT WILL HP OR ITS SUPPLIERS BE LIABLE FOR DIRECT, SPECIAL, INCIDENTAL, CONSEQUENTIAL (INCLUDING LOST PROFIT OR DATA), OR OTHER DAMAGE, WHETHER BASED IN CONTRACT, TORT, OR OTHERWISE.

THE WARRANTY TERMS CONTAINED IN THIS STATEMENT, EXCEPT TO THE EXTENT LAWFULLY PERMITTED, DO NOT EXCLUDE, RESTRICT OR MODIFY AND ARE IN ADDITION TO THE MANDATORY STATUTORY RIGHTS APPLICABLE TO THE SALE OF THIS PRODUCT TO YOU.

Data stored on the print cartridge

The HP print cartridges used with this product contain a memory chip that assists in the operation of the product.

In addition, this memory chip collects a limited set of information about the usage of the product, which might include the following: the date when the print cartridge was first installed, the date when the print cartridge was last used, the number of pages printed using the print cartridge, the page coverage, the printing modes used, any printing errors that might have occurred, and the product model. This information helps HP design future products to meet our customers' printing needs.

The data collected from the print cartridge memory chip does not contain information that can be used to identify a customer or user of the print cartridge or their product.

HP collects a sampling of the memory chips from print cartridges returned to HP's free return and recycling program (HP Planet Partners: www.hp.com/recycle). The memory chips from this sampling are read and studied in order to improve future HP products. HP partners who assist in recycling this print cartridge might have access to this data, as well.

Any third party possessing the print cartridge might have access to the anonymous information on the memory chip. If you prefer to not allow access to this information, you can render the chip inoperable. However, after you render the memory chip inoperable, the memory chip cannot be used in an HP product.

End User License Agreement

PLEASE READ CAREFULLY BEFORE USING THIS SOFTWARE PRODUCT: This End-User License Agreement (“EULA”) is a contract between (a) you (either an individual or the entity you represent) and (b) Hewlett-Packard Company (“HP”) that governs your use of the software product (“Software”). This EULA does not apply if there is a separate license agreement between you and HP or its suppliers for the Software, including a license agreement in online documentation. The term “Software” may include (i) associated media, (ii) a user guide and other printed materials, and (iii) “online” or electronic documentation (collectively “User Documentation”).

RIGHTS IN THE SOFTWARE ARE OFFERED ONLY ON THE CONDITION THAT YOU AGREE TO ALL TERMS AND CONDITIONS OF THIS EULA. BY INSTALLING, COPYING, DOWNLOADING, OR OTHERWISE USING THE SOFTWARE, YOU AGREE TO BE BOUND BY THIS EULA. IF YOU DO NOT ACCEPT THIS EULA, DO NOT INSTALL, DOWNLOAD, OR OTHERWISE USE THE SOFTWARE. IF YOU PURCHASED THE SOFTWARE BUT DO NOT AGREE TO THIS EULA, PLEASE RETURN THE SOFTWARE TO YOUR PLACE OF PURCHASE WITHIN FOURTEEN DAYS FOR A REFUND OF THE PURCHASE PRICE; IF THE SOFTWARE IS INSTALLED ON OR MADE AVAILABLE WITH ANOTHER HP PRODUCT, YOU MAY RETURN THE ENTIRE UNUSED PRODUCT.

- 1. THIRD PARTY SOFTWARE.** The Software may include, in addition to HP proprietary software (“HP Software”), software under licenses from third parties (“Third Party Software” and “Third Party License”). Any Third Party Software is licensed to you subject to the terms and conditions of the corresponding Third Party License. Generally, the Third Party License is in a file such as “license.txt” or a “readme” file. You should contact HP support if you cannot find a Third Party License. If the Third Party Licenses include licenses that provide for the availability of source code (such as the GNU General Public License) and the corresponding source code is not included with the Software, then check the product support pages of HP's website (hp.com) to learn how to obtain such source code.
- 2. LICENSE RIGHTS.** You will have the following rights provided you comply with all terms and conditions of this EULA:
 - a. Use.** HP grants you a license to Use one copy of the HP Software. “Use” means installing, copying, storing, loading, executing, displaying, or otherwise using the HP Software. You may not modify the HP Software or disable any licensing or control feature of the HP Software. If this Software is provided by HP for Use with an imaging or printing product (for example, if the Software is a printer driver, firmware, or add-on), the HP Software may only be used with such product (“HP Product”). Additional restrictions on Use may appear in the User Documentation. You may not separate component parts of the HP Software for Use. You do not have the right to distribute the HP Software.
 - b. Copying.** Your right to copy means you may make archival or back-up copies of the HP Software, provided each copy contains all the original HP Software’s proprietary notices and is used only for back-up purposes.
- 3. UPGRADES.** To Use HP Software provided by HP as an upgrade, update, or supplement (collectively “Upgrade”), you must first be licensed for the original HP Software identified by HP as eligible for the Upgrade. To the extent the Upgrade supersedes the original HP Software, you may no longer use such HP Software. This EULA applies to each Upgrade unless HP provides other terms with the Upgrade. In case of a conflict between this EULA and such other terms, the other terms will prevail.

- 4. TRANSFER.**
 - a.** Third Party Transfer. The initial end user of the HP Software may make a one-time transfer of the HP Software to another end user. Any transfer will include all component parts, media, User Documentation, this EULA, and if applicable, the Certificate of Authenticity. The transfer may not be an indirect transfer, such as a consignment. Prior to the transfer, the end user receiving the transferred Software will agree to this EULA. Upon transfer of the HP Software, your license is automatically terminated.
 - b.** Restrictions. You may not rent, lease or lend the HP Software or Use the HP Software for commercial timesharing or bureau use. You may not sublicense, assign or otherwise transfer the HP Software except as expressly provided in this EULA.
- 5. PROPRIETARY RIGHTS.** All intellectual property rights in the Software and User Documentation are owned by HP or its suppliers and are protected by law, including applicable copyright, trade secret, patent, and trademark laws. You will not remove any product identification, copyright notice, or proprietary restriction from the Software.
- 6. LIMITATION ON REVERSE ENGINEERING.** You may not reverse engineer, decompile, or disassemble the HP Software, except and only to the extent that the right to do so is allowed under applicable law.
- 7. CONSENT TO USE OF DATA.** HP and its affiliates may collect and use technical information you provide in relation to (i) your Use of the Software or the HP Product, or (ii) the provision of support services related to the Software or the HP Product. All such information will be subject to HP's privacy policy. HP will not use such information in a form that personally identifies you except to the extent necessary to enhance your Use or provide support services.
- 8. LIMITATION OF LIABILITY.** Notwithstanding any damages that you might incur, the entire liability of HP and its suppliers under this EULA and your exclusive remedy under this EULA will be limited to the greater of the amount actually paid by you for the Product or U.S. \$5.00. TO THE MAXIMUM EXTENT PERMITTED BY APPLICABLE LAW, IN NO EVENT WILL HP OR ITS SUPPLIERS BE LIABLE FOR ANY SPECIAL, INCIDENTAL, INDIRECT, OR CONSEQUENTIAL DAMAGES (INCLUDING DAMAGES FOR LOST PROFITS, LOST DATA, BUSINESS INTERRUPTION, PERSONAL INJURY, OR LOSS OF PRIVACY) RELATED IN ANY WAY TO THE USE OF OR INABILITY TO USE THE SOFTWARE, EVEN IF HP OR ANY SUPPLIER HAS BEEN ADVISED OF THE POSSIBILITY OF SUCH DAMAGES AND EVEN IF THE ABOVE REMEDY FAILS OF ITS ESSENTIAL PURPOSE. Some states or other jurisdictions do not allow the exclusion or limitation of incidental or consequential damages, so the above limitation or exclusion may not apply to you.
- 9. U.S. GOVERNMENT CUSTOMERS.** Software was developed entirely at private expense. All Software is commercial computer software within the meaning of the applicable acquisition regulations. Accordingly, pursuant to US FAR 48 CFR 12.212 and DFAR 48 CFR 227.7202, use, duplication and disclosure of the Software by or for the U.S. Government or a U.S. Government subcontractor is subject solely to the terms and conditions set forth in this End User License Agreement, except for provisions which are contrary to applicable mandatory federal laws.
- 10. COMPLIANCE WITH EXPORT LAWS.** You will comply with all laws, rules, and regulations (i) applicable to the export or import of the Software, or (ii) restricting the Use of the Software, including any restrictions on nuclear, chemical, or biological weapons proliferation.
- 11. RESERVATION OF RIGHTS.** HP and its suppliers reserve all rights not expressly granted to you in this EULA.

© 2009 Hewlett-Packard Development Company, L.P.

Rev. 04/09

OpenSSL

This product includes software developed by the OpenSSL Project for use in the OpenSSL Toolkit (<http://www.openssl.org/>)

THIS SOFTWARE IS PROVIDED BY THE OpenSSL PROJECT "AS IS" AND ANY EXPRESSED OR IMPLIED WARRANTIES, INCLUDING, BUT NOT LIMITED TO, THE IMPLIED WARRANTIES OF MERCHANTABILITY AND FITNESS FOR A PARTICULAR PURPOSE ARE DISCLAIMED. IN NO EVENT SHALL THE OpenSSL PROJECT OR ITS CONTRIBUTORS BE LIABLE FOR ANY DIRECT, INDIRECT, INCIDENTAL, SPECIAL, EXEMPLARY, OR CONSEQUENTIAL DAMAGES (INCLUDING, BUT NOT LIMITED TO, PROCUREMENT OF SUBSTITUTE GOODS OR SERVICES;

LOSS OF USE, DATA, OR PROFITS; OR BUSINESS INTERRUPTION) HOWEVER CAUSED AND ON ANY THEORY OF LIABILITY, WHETHER IN CONTRACT, STRICT LIABILITY, OR TORT (INCLUDING NEGLIGENCE OR OTHERWISE) ARISING IN ANY WAY OUT OF THE USE OF THIS SOFTWARE, EVEN IF ADVISED OF THE POSSIBILITY OF SUCH DAMAGE.

This product includes cryptographic software written by Eric Young (ey@cryptsoft.com). This product includes software written by Tim Hudson (tjh@cryptsoft.com).

Customer self-repair warranty service

HP products are designed with many Customer Self Repair (CSR) parts to minimize repair time and allow for greater flexibility in performing defective parts replacement. If during the diagnosis period, HP identifies that the repair can be accomplished by the use of a CSR part, HP will ship that part directly to you for replacement. There are two categories of CSR parts: 1) Parts for which customer self repair is mandatory. If you request HP to replace these parts, you will be charged for the travel and labor costs of this service. 2) Parts for which customer self repair is optional. These parts are also designed for Customer Self Repair. If, however, you require that HP replace them for you, this may be done at no additional charge under the type of warranty service designated for your product.

Based on availability and where geography permits, CSR parts will be shipped for next business day delivery. Same-day or four-hour delivery may be offered at an additional charge where geography permits. If assistance is required, you can call the HP Technical Support Center and a technician will help you over the phone. HP specifies in the materials shipped with a replacement CSR part whether a defective part must be returned to HP. In cases where it is required to return the defective part to HP, you must ship the defective part back to HP within a defined period of time, normally five (5) business days. The defective part must be returned with the associated documentation in the provided shipping material. Failure to return the defective part may result in HP billing you for the replacement. With a customer self repair, HP will pay all shipping and part return costs and determine the courier/carrier to be used.

Customer support

Get telephone support for your country/region

Country/region phone numbers are on the flyer that was in the box with your product or at www.hp.com/support/.

Have the product name, serial number, date of purchase, and problem description ready.

Get 24-hour Internet support

www.hp.com/support/cljcm4540mfp

Get support for products used with a Macintosh computer

www.hp.com/go/macosex

Download software utilities, drivers, and electronic information

www.hp.com/go/cljcm4540mfp_software

Order additional HP service or maintenance agreements

www.hp.com/go/carepack

Register your product

www.register.hp.com

C Product specifications

- [Physical specifications](#)
- [Power consumption, electrical specifications, and acoustic emissions](#)
- [Environmental specifications](#)

Physical specifications

Table C-1 Product dimensions

Product	Height	Depth	Width	Weight
CM4540 MFP	575 mm (22.6 in)	617 mm (24.3 in)	827 mm (32.5 in)	54.8 kg (120.5 lb)
CM4540f MFP	1119 mm (44.1 in)	668 mm (26.3 in)	849 mm (33.4 in)	75.7 kg (166.5 lb)
CM4540fskm MFP	1119 mm (44.1 in)	668 mm (26.3 in)	1012 mm (39.8 in)	88.6 kg (195.0 lb)

Power consumption, electrical specifications, and acoustic emissions

See www.hp.com/go/cljcm4540mfp_regulatory for current information.

△ **CAUTION:** Power requirements are based on the country/region where the product is sold. Do not convert operating voltages. This will damage the product and void the product warranty.

Environmental specifications

Environmental condition	Recommended	Allowed
Temperature (product and print cartridge)	17° to 27°C (62.6° to 80.6°F)	10° to 30°C (50° to 86°F)
Relative humidity	30% to 70% relative humidity (RH)	10% to 80% RH
Altitude	N/A	0 m (0 ft) to 3000 m (9842 ft)

D Regulatory information

- [FCC regulations](#)
- [Environmental product stewardship program](#)
- [Declaration of Conformity](#)
- [Declaration of Conformity \(fax models\)](#)
- [Safety statements](#)
- [Additional statements for telecom \(fax\) products](#)

FCC regulations

This equipment has been tested and found to comply with the limits for a Class A digital device, pursuant to Part 15 of the FCC rules. These limits are designed to provide reasonable protection against harmful interference in a residential installation. This equipment generates, uses, and can radiate radio frequency energy, and if not installed and used in accordance with the instruction manual, may cause harmful interference to radio communications. Operation of this equipment in a residential area is likely to cause harmful interference in which case the user will be required to correct the interference at his own expense.

 **NOTE:** Any changes or modifications to the printer that are not expressly approved by HP could void the user's authority to operate this equipment.

Use of a shielded interface cable is required to comply with the Class A limits of Part 15 of FCC rules.

Environmental product stewardship program

Protecting the environment

Hewlett-Packard Company is committed to providing quality products in an environmentally sound manner. This product has been designed with several attributes to minimize impacts on our environment.

Ozone production

This product generates no appreciable ozone gas (O₃).

Power consumption

Power usage drops significantly while in Ready and Sleep mode, which saves natural resources and saves money without affecting the high performance of this product. To determine the ENERGY STAR® qualification status for this product, see the Product Data Sheet or Specifications Sheet. Qualified products are also listed at:

www.hp.com/go/energystar

Paper use

This product's optional automatic duplex feature (two-sided printing) and N-up printing (multiple pages printed on one page) capability can reduce paper usage and the resulting demands on natural resources.

Plastics

Plastic parts over 25 grams are marked according to international standards that enhance the ability to identify plastics for recycling purposes at the end of the product's life.

HP LaserJet print supplies

It's easy to return and recycle your HP LaserJet print cartridges after use—free of charge—with HP Planet Partners. Multilingual program information and instructions are included in every new HP LaserJet print cartridge and supplies package. You help reduce the toll on the environment further when you return multiple cartridges together rather than separately.

HP is committed to providing inventive, high-quality products and services that are environmentally sound, from product design and manufacturing to distribution, customer use and recycling. When you participate in the HP Planet Partners program, we ensure your HP LaserJet print cartridges are recycled properly, processing them to recover plastics and metals for new products and diverting millions of tons of waste from landfills. Since this cartridge is being recycled and used in new materials, it will not be returned to you. Thank you for being environmentally responsible!

 **NOTE:** Use the return label to return original HP LaserJet print cartridges only. Please do not use this label for HP inkjet cartridges, non-HP cartridges, refilled or remanufactured cartridges or warranty returns. For information about recycling your HP inkjet cartridges please go to <http://www.hp.com/recycle>.

Return and recycling instructions

United States and Puerto Rico

The enclosed label in the HP LaserJet toner cartridge box is for the return and recycling of one or more HP LaserJet print cartridges after use. Please follow the applicable instructions below.

Multiple returns (more than one cartridge)

1. Package each HP LaserJet print cartridge in its original box and bag.
2. Tape the boxes together using strapping or packaging tape. The package can weigh up to 31 kg (70 lb).
3. Use a single pre-paid shipping label.

OR

1. Use your own suitable box, or request a free bulk collection box from www.hp.com/recycle or 1-800-340-2445 (holds up to 31 kg (70 lb) of HP LaserJet print cartridges).
2. Use a single pre-paid shipping label.

Single returns

1. Package the HP LaserJet print cartridge in its original bag and box.
2. Place the shipping label on the front of the box.

Shipping

For US and Puerto Rico HP LaserJet print cartridge recycling returns, use the pre-paid, pre-addressed shipping label contained in the box. To use the UPS label, give the package to the UPS driver during your next delivery or pick-up, or take it to an authorized UPS drop-off center. (Requested UPS Ground pickup will be charged normal pick-up rates) For the location of your local UPS drop-off center, call 1-800-PICKUPS or visit www.ups.com.

If you are returning the package with the FedEx label, give the package to either the U.S. Postal Service carrier or FedEx driver during your next pick-up or delivery. (Requested FedEx Ground pickup will be charged normal pick-up rates). Or, you can drop off your packaged print cartridge(s) at any U.S. Post Office or any FedEx shipping center or store. For the location of your nearest U.S. Post Office, please call 1-800-ASK-USPS or visit www.usps.com. For the location of your nearest FedEx shipping center/store, please call 1-800-GOFEDEX or visit www.fedex.com.

For more information, or to order additional labels or boxes for bulk returns, visit www.hp.com/recycle or call 1-800-340-2445. Information subject to change without notice.

Residents of Alaska and Hawaii

Do not use the UPS label. Call 1-800-340-2445 for information and instructions. The U.S. Postal Service provides no-cost cartridge return transportation services under an arrangement with HP for Alaska and Hawaii.

Non-U.S. returns

To participate in HP Planet Partners return and recycling program, just follow the simple directions in the recycling guide (found inside the packaging of your new product supply item) or visit www.hp.com/recycle. Select your country/region for information on how to return your HP LaserJet printing supplies.

Paper

This product is capable of using recycled papers when the paper meets the guidelines outlined in the *HP LaserJet Printer Family Print Media Guide*. This product is suitable for the use of recycled paper according to EN12281:2002.

Material restrictions

This HP product does not contain added mercury.

This HP product contains a battery that might require special handling at end-of-life. The batteries contained in or supplied by Hewlett-Packard for this product include the following:

HP Color LaserJet Enterprise CM4540 MFP Series	
Type	Carbon monofluoride lithium
Weight	0.8 g
Location	On formatter board
User-removable	No



廢電池請回收

For recycling information, you can go to www.hp.com/recycle, or contact your local authorities or the Electronics Industries Alliance: www.eiae.org.

Disposal of waste equipment by users in private households in the European Union

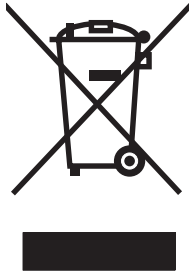

This symbol on the product or on its packaging indicates that this product must not be disposed of with your other household waste. Instead, it is your responsibility to dispose of your waste equipment by handing it over to a designated collection point for the recycling of waste electrical and electronic equipment. The separate collection and recycling of your waste equipment at the time of disposal will help to conserve natural resources and ensure that it is recycled in a manner that protects human health and the environment. For more information about where you can drop off your waste equipment for recycling, please contact your local city office, your household waste disposal service or the shop where you purchased the product.

Chemical substances

HP is committed to providing our customers with information about the chemical substances in our products as needed to comply with legal requirements such as REACH (Regulation EC No 1907/2006 of the European Parliament and the Council). A chemical information report for this product can be found at: www.hp.com/go/reach.

Material Safety Data Sheet (MSDS)

Material Safety Data Sheets (MSDS) for supplies containing chemical substances (for example, toner) can be obtained by accessing the HP Web site at www.hp.com/go/msds or www.hp.com/hpinfo/community/environment/productinfo/safety.

For more information

To obtain information about these environmental topics:

- Product environmental profile sheet for this and many related HP products
- HP's commitment to the environment
- HP's environmental management system
- HP's end-of-life product return and recycling program
- Material Safety Data Sheets

Visit www.hp.com/go/environment or www.hp.com/hpinfo/globalcitizenship/environment.

Declaration of Conformity

Declaration of Conformity

according to ISO/IEC 17050-1 and EN 17050-1

Manufacturer's Name: Hewlett-Packard Company DoC#: BOISB-0806-01-rel.1.0

Manufacturer's Address: 11311 Chinden Boulevard
Boise, Idaho 83714-1021, USA

declares, that the product

Product Name: HP Color LaserJet Enterprise CM4540 MFP

Regulatory Model Number²⁾ BOISB-0806-01

Including:

CC422A – 500-sheet paper feeder and cabinet

CC423A – 3x500-sheet paper feeder and stand

CC424A – 900-sheet 3-bin Stapling Mailbox

CC425A – 1x500-sheet paper feeder

Product Options: ALL

Print Cartridges: CE260A, CE264X, CF031A, CF032A, CF033A

conforms to the following Product Specifications:

SAFETY: IEC 60950-1:2001 / EN60950-1: 2001 +A11
IEC 60825-1:1993 +A1 +A2 / EN 60825-1:1994 +A1 +A2 (Class 1 Laser/LED Product)
GB4943-2001

EMC: CISPR22:2005 +A1/ EN55022:2006 +A1 - Class A^{1),3)}

EN 61000-3-2:2006

EN 61000-3-3:1995 +A1 +A2

EN 55024:1998 +A1 +A2

FCC Title 47 CFR, Part 15 Class A^{1),3)} / ICES-003, Issue 4

GB9254-1998, GB17625.1-2003

Supplementary Information:

The product herewith complies with the requirements of the EMC Directive 2004/108/EC and the Low Voltage Directive 2006/95/EC, and carries the CE-Marking  accordingly.

This Device complies with Part 15 of the FCC Rules. Operation is subject to the following two Conditions: (1) this device may not cause harmful interference, and (2) this device must accept any interference received, including interference that may cause undesired operation.

1. The product was tested in a typical configuration with Hewlett-Packard Personal Computer Systems.
2. For regulatory purposes, this product is assigned a Regulatory model number. This number should not be confused with the product name or the product number(s).
3. The product meets the requirements of EN55022 & CNS13438 Class A in which case the following applies: "Warning – This is a class A product. In a domestic environment this product may cause radio interference in which case the user may be required to take adequate measures."

Boise, Idaho USA

August 17, 2010

For regulatory topics only:

European Contact: Your Local Hewlett-Packard Sales and Service Office or Hewlett-Packard GmbH, Department HQ-TRE / Standards Europe, Herrenberger Strasse 140, D-71034, Böblingen (FAX: +49-7031-14-3143)
www.hp.com/go/certificates

USA Contact: Product Regulations Manager, Hewlett-Packard Company, PO Box 15, Mail Stop 160, Boise, Idaho 83707-0015 (Phone: 208-396-6000)

Declaration of Conformity (fax models)

Declaration of Conformity

according to ISO/IEC 17050-1 and EN 17050-1

Manufacturer's Name: Hewlett-Packard Company DoC#: BOISB-0806-02-rel.1.0

Manufacturer's Address: 11311 Chinden Boulevard
Boise, Idaho 83714-1021, USA

declares, that the product

Product Name: HP Color LaserJet Enterprise CM4540f MFP
HP Color LaserJet Enterprise CM4540fskm MFP

Regulatory Model Number²⁾ BOISB-0806-02

Including:

CC422A – 500-sheet paper feeder and cabinet

CC423A – 3x500-sheet paper feeder and stand

CC424A – 900-sheet 3-bin Stapling Mailbox

CC425A – 1x500-sheet paper feeder

BOISB-0703-00 – Fax Module

Product Options: ALL

Print Cartridges: CE260A, CE264X, CF031A, CF032A, CF033A

conforms to the following Product Specifications:

SAFETY: IEC 60950-1:2001 / EN60950-1: 2001 +A11
IEC 60825-1:1993 +A1 +A2 / EN 60825-1:1994 +A1 +A2 (Class 1 Laser/LED Product)
GB4943-2001

EMC: CISPR22:2005 +A1/ EN55022:2006 +A1 - Class A^{1),3)}
EN 61000-3-2:2006
EN 61000-3-3:1995 +A1 +A2
EN 55024:1998 +A1 +A2
FCC Title 47 CFR, Part 15 Class A^{1),3)} / ICES-003, Issue 4
GB9254-1998, GB17625.1-2003

TELECOM: ES 203 021; FCC Title 47 CFR, Part 68⁴⁾

Supplementary Information:

The product herewith complies with the requirements of the EMC Directive 2004/108/EC and the Low Voltage Directive 2006/95/EC, the R&TTE; Directive 1999/5/EC (Annex II), and carries the CE-Marking  accordingly.

This Device complies with Part 15 of the FCC Rules. Operation is subject to the following two Conditions: (1) this device may not cause harmful interference, and (2) this device must accept any interference received, including interference that may cause undesired operation.

1. The product was tested in a typical configuration with Hewlett-Packard Personal Computer Systems.
2. For regulatory purposes, this product is assigned a Regulatory model number. This number should not be confused with the product name or the product number(s).
3. The product meets the requirements of EN55022 & CNS13438 Class A in which case the following applies: "Warning – This is a class A product. In a domestic environment this product may cause radio interference in which case the user may be required to take adequate measures."
4. Telecom approvals and standards appropriate for the target countries/regions have been applied to this product, in addition to those listed above.
5. This product uses an analog fax accessory module which Regulatory Model numbers are: BOISB-0903-00 (US-LIU) or BOISB-0903-01 (EURO LIU), as needed to meet technical regulatory requirements for the countries/regions this product will be sold.
6. 5. This product uses an analog fax accessory module which Regulatory Model number is: BOISB-0703-00 as needed to meet technical regulatory requirements for the countries/regions this product will be sold.

Boise, Idaho USA

August 17, 2010

For regulatory topics only:

European Contact: Your Local Hewlett-Packard Sales and Service Office or Hewlett-Packard GmbH, Department HQ-TRE / Standards Europe, Herrenberger Strasse 140, D-71034, Böblingen (FAX: +49-7031-14-3143)
www.hp.com/go/certificates

USA Contact: Product Regulations Manager, Hewlett-Packard Company, PO Box 15, Mail Stop 160, Boise, Idaho 83707-0015 (Phone: 208-396-6000)

Safety statements

Laser safety

The Center for Devices and Radiological Health (CDRH) of the U.S. Food and Drug Administration has implemented regulations for laser products manufactured since August 1, 1976. Compliance is mandatory for products marketed in the United States. The device is certified as a "Class 1" laser product under the U.S. Department of Health and Human Services (DHHS) Radiation Performance Standard according to the Radiation Control for Health and Safety Act of 1968. Since radiation emitted inside the device is completely confined within protective housings and external covers, the laser beam cannot escape during any phase of normal user operation.

-
- △ **WARNING!** Using controls, making adjustments, or performing procedures other than those specified in this user guide may result in exposure to hazardous radiation.
-

Canadian DOC regulations

Complies with Canadian EMC Class A requirements.

« Conforme à la classe A des normes canadiennes de compatibilité électromagnétiques. « CEM ». »

VCCI statement (Japan)

この装置は、クラスA情報技術装置です。この装置を家庭環境で使用すると電波妨害を引き起こすことがあります。この場合には使用者は適切な対策を講ずるよう要求されることがあります。

VCCI-A

Power cord instructions

Make sure your power source is adequate for the product voltage rating. The voltage rating is on the product label. The product uses either 100-127 Vac or 220-240 Vac and 50/60 Hz.

Connect the power cord between the product and a grounded AC outlet.

-
- △ **CAUTION:** To prevent damage to the product, use only the power cord that is provided with the product.
-

Power cord statement (Japan)

製品には、同梱された電源コードをお使い下さい。
同梱された電源コードは、他の製品では使用出来ません。

EMC statement (China)

此为 A 级产品，在生活环境中，该产品可能会造成无线电干扰。在这种情况下，可能需要用户对其干扰采取切实可行的措施。

EMC statement (Korea)

A급 기기 (업무용 방송통신기기)	이 기기는 업무용(A급)으로 전자파적합등록을 한 기기이오니 판매자 또는 사용자는 이점을 주의하시기 바라며, 가정 외의 지역에서 사용하는 것을 목적으로 합니다.
-----------------------	--

EMI statement (Taiwan)

警告使用者：

這是甲類的資訊產品，在居住的環境中使用時，可能會造成射頻干擾，在這種情況下，使用者會被要求採取某些適當的對策。

Laser statement for Finland

Luokan 1 laserlaite

Klass 1 Laser Apparar

HP Color LaserJet CM4540, CM4540f, CM4540fskm, laserkirjoitin on käyttäjän kannalta turvallinen luokan 1 laserlaite. Normaalisessa käytössä kirjoittimen suojakoteloimintä estää lasersäteiden pääsyn laitteen ulkopuolelle. Laitteen turvallisuusluokka on määritetty standardin EN 60825-1 (2007) mukaisesti.

VAROITUS !

Laitteen käyttäminen muulla kuin käyttöohjeessa mainitulla tavalla saattaa altistaa käyttäjän turvallisuusluokan 1 ylittävälle näkymättömälle lasersäteilylle.

WARNING !

Om apparaten används på annat sätt än i bruksanvisning specificerats, kan användaren utsättas för osynlig laserstrålning, som överskrider gränsen för laserklass 1.

HUOLTO

HP Color LaserJet CM4540, CM4540f, CM4540fskm - kirjoittimen sisällä ei ole käyttäjän huollettavissa olevia kohteita. Laitteen saa avata ja huoltaa ainoastaan sen huoltamiseen koulutettu henkilö. Tällaiseksi huoltotoimenpiteeksi ei katsota väriainekasetin vaihtamista, paperiradan puhdistusta tai muita käyttäjän käsikirjassa lueteltuja, käyttäjän tehtäväksi tarkoitettuja ylläpitotoimia, jotka voidaan suorittaa ilman erikoistyökaluja.

VARO !

Mikäli kirjoittimen suojakotelo avataan, olet alttiina näkymättömälle lasersäteilylle laitteen ollessa toiminnassa. Älä katso säteeseen.

VARNING !

Om laserprinterns skyddshölje öppnas då apparaten är i funktion, utsätts användaren för osynlig laserstrålning. Betrakta ej strålen.

Tiedot laitteessa käytettävän laserdiodin säteilyominaisuuksista: Aallonpituus 775-795 nm Teho 5 m W Luokan 3B laser.

Substances Table (China)

有毒有害物质表

根据中国电子信息产品污染控制管理办法的要求而出台

部件名称	有毒有害物质和元素					
	铅 (Pb)	汞 (Hg)	镉 (Cd)	六价铬 (Cr(VI))	多溴联苯 (PBB)	多溴二苯醚 (PBDE)
打印引擎	X	0	0	0	0	0
复印机组件	X	0	0	0	0	0
控制面板	0	0	0	0	0	0
塑料外壳	0	0	0	0	0	0
格式化板组件	X	0	0	0	0	0
碳粉盒	X	0	0	0	0	0

0614

0 : 表示在此部件所用的所有同类材料中, 所含的此有毒或有害物质均低于 SJ/T11363-2006 的限制要求。

X : 表示在此部件所用的所有同类材料中, 至少一种所含的此有毒或有害物质高于 SJ/T11363-2006 的限制要求。

注 : 引用的“环保使用期限”是根据在正常温度和湿度条件下操作使用产品而确定的。

Restriction on Hazardous Substances statement (Turkey)

Türkiye Cumhuriyeti: EEE Yönetmeliğine Uygundur

Additional statements for telecom (fax) products

EU Statement for Telecom Operation

This product is intended to be connected to the analog Public Switched Telecommunication Networks (PSTN) of European Economic Area (EEA) countries/regions.

It meets requirements of EU R&TTE Directive 1999/5/EC (Annex II) and carries appropriate CE conformity marking.

For more details see Declaration of Conformity issued by the manufacturer in another section of this manual.

However due to differences between individual national PSTNs the product may not guarantee unconditional assurance of successful operation on every PSTN termination point. Network compatibility depends on the correct setting being selected by the customer in preparation of its connection to the PSTN. Please follow the instructions provided in the user manual.

If you experience network compatibility issues, please contact your equipment supplier or Hewlett-Packard help desk in the country/region of operation.

Connecting to a PSTN termination point may be the subject of additional requirements set out by the local PSTN operator.

New Zealand Telecom Statements

The grant of a Telepermit for any item of terminal equipment indicates only that Telecom has accepted that the item complies with minimum conditions for connection to its network. It indicates no endorsement of the product by Telecom, nor does it provide any sort of warranty. Above all, it provides no assurance that any item will work correctly in all respects with another item of Telepermitted equipment of a different make or model, nor does it imply that any product is compatible with all of Telecom's network services.

This equipment may not provide for the effective hand-over of a call to another device connected to the same line.

This equipment shall not be set up to make automatic calls to the Telecom "111" Emergency Service.

This product has not been tested to ensure compatibility with the FaxAbility distinctive ring service for New Zealand.

Additional FCC statement for telecom products (US)

This equipment complies with Part 68 of the FCC rules and the requirements adopted by the ACTA. On the back of this equipment is a label that contains, among other information, a product identifier in the format US:AAAEQ##TXXXX. If requested, this number must be provided to the telephone company.

The REN is used to determine the quantity of devices, which may be connected to the telephone line. Excessive RENs on the telephone line may result in the devices not ringing in response to an incoming call. In most, but not all, areas, the sum of the RENs should not exceed five (5.0). To be certain of the number of devices that may be connected to the line, as determined by the total RENs, contact the telephone company to determine the maximum REN for the calling area.

This equipment uses the following USOC jacks: RJ11C.

An FCC-compliant telephone cord and modular plug is provided with this equipment. This equipment is designed to be connected to the telephone network or premises wiring using a compatible modular jack, which is Part 68 compliant. This equipment cannot be used on telephone company-provided coin service. Connection to Party Line Service is subject to state tariffs.

If this equipment causes harm to the telephone network, the telephone company will notify you in advance that temporary discontinuance of service may be required. If advance notice is not practical, the telephone company will notify the customer as soon as possible. Also, you will be advised of your right to file a complaint with the FCC if you believe it is necessary.

The telephone company may make changes in its facilities, equipment, operations, or procedures that could affect the operation of the equipment. If this happens, the telephone company will provide advance notice in order for you to make the necessary modifications in order to maintain uninterrupted service.

If trouble is experienced with this equipment, please see the numbers in this manual for repair and (or) warranty information. If the trouble is causing harm to the telephone network, the telephone company may request you remove the equipment from the network until the problem is resolved.

The customer can do the following repairs: Replace any original equipment that came with the device. This includes the print cartridge, the supports for trays and bins, the power cord, and the telephone cord. It is recommended that the customer install an AC surge arrester in the AC outlet to which this device is connected. This is to avoid damage to the equipment caused by local lightning strikes and other electrical surges.

Telephone Consumer Protection Act (US)

The Telephone Consumer Protection Act of 1991 makes it unlawful for any person to use a computer or other electronic device, including fax machines, to send any message unless such message clearly contains, in a margin at the top or bottom of each transmitted page or on the first page of the transmission, the date and time it is sent and an identification of the business, other entity, or individual sending the message and the telephone number of the sending machine or such business, or other entity, or individual. (The telephone number provided cannot be a 900 number or any other number for which charges exceed local or long distance transmission charges).

Industry Canada CS-03 requirements

Notice: The Industry Canada label identifies certified equipment. This certification means the equipment meets certain telecommunications network protective, operational, and safety requirements as prescribed in the appropriate Terminal Equipment Technical Requirement document(s). The Department does not guarantee the equipment will operate to the user's satisfaction. Before installing this equipment, users should ensure that it is permissible for the equipment to be connected to the facilities of the local telecommunications company. The equipment must also be installed using an acceptable method of connection. The customer should be aware that compliance with the above conditions may not prevent degradation of service in some situations. Repairs to certified equipment should be coordinated by a representative designated by the supplier. Any repairs or alterations made by the user to this equipment, or equipment malfunctions, may give the telecommunications company cause to request the user to disconnect the equipment. Users should ensure for their own protection that the electrical ground connections of the power utility, telephone lines, and internal metallic water pipe system, if present, are connected together. This precaution can be particularly important in rural areas.

△ **CAUTION:** Users should not attempt to make such connections themselves, but should contact the appropriate electric inspection authority, or electrician, as appropriate. The Ringer Equivalence Number (REN) of this device is 0.0.

Notice: The Ringer Equivalence Number (REN) assigned to each terminal device provides an indication of the maximum number of terminals allowed to be connected to a telephone interface. The termination on an interface may consist of any combination of devices subject only to the requirement that the sum of the Ringer Equivalence Number of all the devices does not exceed five (5.0). The standard connecting arrangement code (telephone jack type) for equipment with direct connections to the telephone network is CA11A.

Japan Telecom Mark

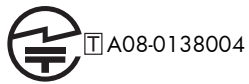

Index

A

- accessories
 - ordering 322
- acoustic specifications 338
- activity log 259
- address books, e-mail
 - LDAP support 199
 - recipient lists 203
 - recipient lists, creating 202
- adjust copy images 181
- Administration menu, control panel 18
- alerts, e-mail 64
- antcounterfeit supplies 109
- automatic paper sensing 102

B

- Backup/Restore menu, control panel 45
- batteries included 343
- billing code report
 - printing 260
- billing codes 219
- Billing Codes Report
 - description 264
- bins, output
 - capacity 96
 - locating 5
- black and white
 - copy jobs 178
- Blocked Fax List
 - description 264
- blocked fax list report
 - printing 260
- booklets
 - creating (Windows) 152
- books
 - copying 185
- both sides, copying 189

- both sides, printing on
 - turning on (Mac) 64
- browser requirements
 - HP embedded Web Server 266
- browser, Web
 - remote configuration 210
- business graphics
 - printing 162
- buttons, control panel
 - touchscreen 14

C

- cable, USB
 - part number 323
- Calibrate/Cleaning menu, control panel 45
- call report 260
- Canadian DOC regulations 349
- cancel
 - copy jobs 176
- canceling
 - print job 66
- canceling a fax 240
- canceling a print request (Windows) 128
- cartridges
 - non-HP 109
 - recycling 109, 341
 - storage 109
 - warranty 329
- cartridges, print
 - replacing 110
- cautions iii
- cleaning
 - paper path 279, 308
 - product 279
 - scanner glass 179, 279
- clearing log/report data 260

- CMYK Values
 - description 265
- collate
 - copy jobs 178
- color
 - adjusting 168
 - copy jobs 178
 - Edge Control 170
 - manage 167
 - match 172
 - Neutral Grays 170
 - Pantone® matching 173
 - print color samples 173
 - printed vs. monitor 172
 - printing in grayscale (Windows) 143
 - sample book matching 172
 - using 167
- color options
 - HP EasyColor (Windows) 171
 - setting (Windows) 141
- Color Samples for RGB
 - description 265
- Color tab settings 69
- Color Usage
 - description 264
- Color usage, Macintosh 64
- configuration
 - remote 210
- Configuration Page
 - description 264
- configurations, models 2
- configuring
 - IP address 59, 75
- connection
 - USB with Mac 58
 - USB with Windows 73
- connectivity
 - solving problems 316

- control panel
 - Administration menu 18
 - Backup/Restore menu 45
 - Calibrate/Cleaning menu 45
 - cleaning page, printing 279
 - Copy Settings menu 23
 - Display Settings menu 35
 - Fax Settings menu 29
 - General Settings menu 19
 - help 11
 - Home screen 12
 - locating 5
 - Manage Supplies menu 37
 - Manage Trays menu 38
 - menus, summary 16
 - messages, numerical list 120
 - messages, types of 288
 - Network Settings menu 39
 - Print Options menu 34
 - Print Settings menu 33
 - Reports menu 18
 - Scan/Digital Send Settings menu 27
 - security 274
 - Service menu 46
 - settings 52, 63
 - Stapler/Stacker Settings menu 39
 - touchscreen buttons 14
 - Troubleshooting menu 42
 - USB Firmware Upgrade menu 46
- conventions, document iii
- copies
 - changing number of (Windows) 130
- copy
 - adjust lightness/darkness 181
 - books 185
 - cancel 176
 - collate 178
 - color 178
 - creating a stored job 187
 - enlarge 177
 - from document feeder 176
 - from glass 176
 - grayscale 178
 - improve quality 179
 - Job Build 190
 - Job Mode 190
 - mixed sizes 188
 - multiple originals 190
 - optimize for text or pictures 179
 - photos 186
 - reduce 177
 - restoring default settings 184
 - set options 183
 - special paper 183
 - two-sided documents 189
- copy settings
 - HP Embedded Web Server 268
- Copy Settings menu, control panel 23
- copying
 - quality, adjusting 311
- counterfeit supplies 109
- cover pages
 - printing (Mac) 67
 - printing on different paper (Windows) 148
- covers, locating 5
- custom print settings (Windows) 131
- custom-size paper settings
 - Macintosh 67
- customer support
 - online 336
- D**
 - date/time setting 209
 - default gateway, setting 79
 - default settings, copy restoring 184
 - defects, repeating 118
 - deleting
 - stored jobs 159
 - Demo Page
 - description 265
 - dial tone detection, setting 216
 - dialing mode
 - setting 213
 - dialing prefix
 - setting 216
 - digital send settings
 - HP Embedded Web Server 268
 - digital sending
 - about 198
 - address books 202, 203
 - configure e-mail 199
 - folders 195
 - job settings 194
 - LDAP support 199
 - product memory 196
 - recipient lists 203
 - sending documents 200
 - SMTP support 199
 - USB flash drive 197
 - digital sending utility, remote configuration 211
 - Display Settings menu, control panel 35
 - disposal, end-of-life 343
 - document conventions iii
 - document feeder
 - copying two-sided documents 189
 - jams 292
 - make copies from 176
 - double-sided copying 189
 - double-sided printing (duplexing)
 - loading paper 98
 - turning on (Mac) 64
 - drivers
 - changing paper types and sizes 84
 - changing settings (Mac) 63
 - changing settings (Windows) 53
 - presets (Mac) 66
 - settings 52
 - settings (Mac) 66
 - settings (Windows) 129
 - supported (Windows) 49
 - universal 51
 - DSS. See digital sending utility
 - duplex alignment
 - setting 163
 - duplex printing (double-sided)
 - loading paper 98
 - settings (Windows) 136
 - turning on (Mac) 64
- E**
 - e-mail alerts 64
 - E-mail feature
 - enabling 192
 - economy settings 275

- Edge Control 170
- electrical specifications 338
- embedded Web server 210
- Embedded Web Server (EWS)
 - assigning passwords 273
 - features 266
- end-of-life disposal 343
- energy use, optimizing 275
- Enhanced I/O (EIO) card
 - installing 277
 - part number 323
 - partnumber 323
- enlarge
 - copy jobs 177
- envelopes
 - loading in Tray 1 90
 - loading orientation 98
- environment, specifications 338
- environmental features 3
- Environmental Product Stewardship Program 341
- error
 - codes 254
- error correction mode
 - settings 219
- error messages
 - control panel 288
 - e-mail alerts 64
 - numerical list 120
 - types of 288
- errors
 - software 318
- European Union, waste disposal 344
- EWS. *See* embedded Web server
- Explorer, versions supported
 - HP Embedded Web Server 266
- e-mail
 - about 198
 - address books 202, 203
 - configure 199
 - LDAP support 199
 - recipient lists 203
 - sending documents 200
 - SMTP support 199

F

- fax
 - canceling 240

- feeding problems 251
 - printing 247
 - receiving 241
 - required settings 207
 - sending 236
 - setup wizard 208, 211
- Fax Activity Log
 - description 264
- fax address book 239
- fax notification 222
- fax number confirmation 217
- fax polling 229
- Fax Reports
 - description 264
- fax settings
 - HP Embedded Web Server 269
- Fax Settings menu, control panel 29
- FCC regulations 340
- features 2
- features, description 206
- feeding problems 251
- File Directory Page
 - description 264
- File Upload, Macintosh 64
- Finnish laser safety statement 350
- firmware
 - Update Mac 64
- firmware upgrades 262
- firmware, downloading new 282
- first page
 - printing on different paper (Windows) 148
 - use different paper 67
- fit-to-page 231
- folders
 - sending to 195
- fonts
 - Upload Macintosh 64
- formatter
 - security 274
- forms
 - printing (Windows) 143
- fraud hotline 109
- fuser
 - jams 299

G

- gateway, setting default 79

- gateways
 - configure 199
- general configuration
 - HP Embedded Web Server 267
- General Settings menu, control panel 19
- gloss level
 - selecting (Windows) 135
- glossy paper, supported 162
- graphics, business
 - printing 162
- graphics, low quality 236
- grayscale
 - copy jobs 178
 - printing (Windows) 143
- group dial. *See* speed dial

H

- hard disks
 - encrypted 273
- help
 - printing options (Windows) 130
- Help button, control panel
 - touchscreen 14
- help, control panel 11
- Home button, control panel
 - touchscreen 14
- Home screen, control panel 12
- HP Customer Care 336
- HP Easy Color
 - disabling 171
 - using 171
- HP Embedded Web Server
 - copy settings 268
 - digital send settings 268
 - fax settings 269
 - general configuration 267
 - information pages 267
 - network settings 271
 - other links list 271
 - print settings 268
 - scan settings 268
 - security settings 270
 - troubleshooting tools 270
- HP Embedded Web Server (EWS)
 - features 266
- HP fraud hotline 109

- HP Jetdirect print server
 - installing 277
 - models including 2
 - HP Printer Utility 64
 - HP tough paper 163
 - HP Universal Print Driver 51
 - HP Utility 64
 - HP Utility, Macintosh 64
 - HP Web Jetadmin 55, 272
 - HP-UX software 56
 - humidity requirements 338
- I**
- information pages
 - HP Embedded Web Server 267
 - printing or viewing 264
 - installing
 - EIO card 277
 - EIO cards 277
 - print cartridges 110
 - product on wired networks, Mac 59
 - product on wired networks, Windows 75
 - software, USB connections 73
 - software, wired networks 77
 - toner collection unit 112
 - interface ports
 - locating 8, 9
 - Internet Explorer, versions supported
 - HP Embedded Web Server 266
 - IP address
 - configuring 59, 75
 - IP Security 273
 - IPsec 273
 - IPv4 address 79
 - IPv6 address 80
- J**
- jams
 - causes of 289
 - document feeder 292
 - fuser 299
 - lower-right door 305
 - output area 293
 - output bin 297
 - recovery 306
 - right door 299
 - stapler 293, 294
 - top cover 297
 - Tray 1 302
 - trays 304
 - Japanese VCCI statement 349
 - JBIG compression
 - setting 218
 - Jetadmin, HP Web 55, 272
 - Jetdirect print server
 - installing 277
 - models including 2
 - Job Build, copying 190
 - Job Mode, copying 190
 - job retention
 - setting options (Windows) 159
 - job storage
 - Macintosh settings 69
 - modes available 157
 - setting options (Windows) 159
 - jobs
 - Macintosh settings 64
 - jobs, print
 - storing permanent copies (Windows) 160
 - storing permanent private copies (Windows) 161
 - storing temporarily (Windows) 160
 - storing temporary copies (Windows) 160
 - jobs, stored
 - creating (Windows) 157
 - deleting 159
 - printing 158
 - receiving notification when printed (Windows) 161
 - setting user names (Windows) 161
 - specifying names (Windows) 161
- K**
- keys, control panel
 - touchscreen 14
 - Korean EMC statement 350
- L**
- labels
 - printing (Windows) 145
 - LAN fax 206
 - landscape orientation
 - selecting, Windows 139
 - laser safety statements 349, 350
 - Last Fax Call Report
 - description 264
 - last page
 - printing on different paper (Windows) 148
 - LDAP servers
 - connect to 199
 - letterhead
 - printing (Windows) 143
 - license, software 332
 - Linux software 56
 - loading
 - Tray 1 90
 - Tray 2 92, 93
 - Tray 3, 4, and 5 92, 93
 - loading paper 90
 - locked fax printing 247
 - log/report
 - activity log 259
 - activity log, clearing 260
 - billing code report 260
 - blocked fax list report 260
 - fax call report 260
 - speed dial list report 260
 - lower-right door
 - jams 305
- M**
- Mac
 - changing paper types and sizes 66
 - driver settings 63, 66
 - problems, troubleshooting 319
 - removing software 61
 - software 64
 - supported operating systems 58
 - Macintosh
 - HP Printer Utility 64
 - resize documents 67
 - support 336
 - Macintosh driver settings
 - custom-size paper 67
 - Job Storage 69
 - watermarks 67

- maintenance kits
 - part numbers 323
- Manage Supplies menu, control panel 37
- Manage Trays menu, control panel 38
- managing network 78
- maps, printing 163
- marketing materials
 - printing 162
- material restrictions 343
- Material Safety Data Sheet (MSDS) 344
- media
 - custom-size, Macintosh settings 67
 - first page 67
 - pages per sheet 68
 - supported sizes 85
- memory
 - included 2, 64
 - supply errors 120
- memory chip, print cartridge
 - description 331
- memory DIMMs
 - security 274
- memory lock
 - disabling 247
 - enabling 247
- memory tag
 - locating 111
- memory, saving and deleting
 - faxes 236
- menus
 - summary 16
- menus, control panel
 - Administration 18
 - Backup/Restore 45
 - Calibrate/Cleaning 45
 - Copy Settings 23
 - Display Settings 35
 - Fax Settings 29
 - General Settings 19
 - Manage Supplies 37
 - Manage Trays 38
 - Network Settings 39
 - Print Options 34
 - Print Settings 33
 - Reports 18
 - Scan/Digital Send Settings 27
 - Service 46
 - Stapler/Stacker Settings 39
 - Troubleshooting 42
 - USB Firmware Upgrade 46
- mercury-free product 343
- messages
 - e-mail alerts 64
 - numerical list 120
 - types of 288
- mixed sizes
 - copying 188
- models, features 2
- modem speed 252
- multifunction product 206
- multiple pages per sheet
 - printing (Windows) 137
- N**
 - n-up printing
 - selecting (Windows) 137
 - names, job
 - specifying (Windows) 161
 - Netscape Navigator, versions supported
 - HP embedded Web Server 266
 - network
 - password, changing 78
 - password, setting 78
 - settings, changing 78
 - settings, viewing 78
 - Network Folder, scan to 195
 - network settings
 - HP Embedded Web Server 271
 - Network Settings menu, control panel 39
 - networks
 - configuring 73
 - default gateway 79
 - HP Web Jetadmin 272
 - installing EIO cards 277
 - IPv4 address 79
 - IPv6 address 80
 - print servers included 2
 - protocols supported 74
 - security 75
 - SMTP servers 199
 - subnet mask 79
- networks, wired
 - installing product, Mac 59
 - installing product, Windows 75
- Neutral Grays 170
- non-HP supplies 109
- not configured 207
- notes iii
- notification settings 222
- O**
 - on/off button, locating 5
 - online help, control panel 11
 - online support 336
 - opening printer drivers
 - (Windows) 129
 - operating environment
 - specifications 338
 - operating systems supported 48, 58
 - optimize copy images 179
 - ordering
 - supplies and accessories 322
 - orientation
 - paper, while loading 98
 - selecting, Windows 139
 - other links list
 - HP Embedded Web Server 271
 - output area
 - jams 293
 - output bin
 - jams 297
 - locating 5
 - output bins
 - configuring 103
 - selecting (Windows) 154
- P**
 - page sizes
 - scaling documents to fit (Windows) 150
 - pages per sheet
 - selecting (Windows) 137
 - paper
 - covers, using different paper 148
 - custom-size, Macintosh settings 67

- first and last pages, using
 - different paper 148
- first page 67
- jams 289
- load 90
- loading orientation 98
- pages per sheet 68
- printing on preprinted letterhead
 - or forms (Windows) 143
- selecting 307
- paper pickup problems
 - solving 289
- paper size
 - changing 84
- paper sizes
 - selecting 135
 - selecting custom 135
 - supported 85
- paper tray selection 233
- paper types
 - changing 84
 - selecting 135
 - supported 88
- paper, ordering 322
- paper, special
 - printing (Windows) 145
- part numbers
 - maintenance kits 323
 - print cartridges 323
 - supplies 323
- pause, when dialing 236
- PBX systems troubleshooting 253
- PCL drivers
 - universal 51
- PCL Font List
 - description 265
- personal jobs
 - storing temporarily
 - (Windows) 160
- phone lines troubleshooting 253
- photos
 - copying 186
- photos, low quality 236
- polling 229
- portrait orientation
 - selecting, Windows 139
- ports
 - locating 9
- PostScript Printer Description (PPD)
 - files
 - included 64
- power
 - consumption 338
- power connection
 - locating 8
- power switch, locating 5
- PPDs
 - included 64
- prefix
 - automatic dialing 216
- preprinted paper
 - printing (Windows) 143
- presets (Mac) 66
- print cartridges
 - checking for damage 117
 - memory chips 331
 - non-HP 109
 - part numbers 323
 - recycling 109, 341
 - replacing 110
 - storage 109
 - warranty 329
- print job
 - canceling 66
- print jobs
 - storing permanent copies
 - (Windows) 160
 - storing permanent private
 - copies (Windows) 161
 - storing temporarily
 - (Windows) 160
 - storing temporary copies
 - (Windows) 160
- print media
 - loading in Tray 1 90
- Print Options menu, control panel
 - 34
- print quality
 - improving 307
 - improving (Windows) 135
- print server card
 - installing 277
- print settings
 - HP Embedded Web Server
 - 268
- Print Settings menu, control panel
 - 33
- print tasks 127
- printer drivers
 - choosing 310
- printer drivers (Mac)
 - changing settings 63
 - settings 66
- printer drivers (Windows)
 - changing settings 53
 - settings 129
 - supported 49
- printing
 - from USB storage accessories
 - 164
 - settings (Mac) 66
 - settings (Windows) 129
 - stored jobs 158
- printing locked faxes 247
- printing on both sides
 - settings (Windows) 136
- priority, settings 52, 63
- private jobs
 - storing permanently
 - (Windows) 161
- problem-solving
 - e-mail alerts 64
 - messages, types of 288
 - no response 312
 - slow response 313
- product. See multifunction product
- product info 1
- product memory
 - sending to 196
- product memory, scan to 196
- proof and hold
 - selecting (Windows) 159
- protocols, network 74
- PS Emulation drivers 49
- pulse dialing
 - setting 213
- Q**
- quick copy jobs
 - storing (Windows) 160
- R**
- receiving faxes 241
- recipient lists 203
- recycling
 - HP printing supplies returns and
 - environmental program 342
 - recycling supplies 109

- redial interval, setting 214
- redial-on-busy
 - setting 215
- redial-on-no-answer
 - setting 216
- reduce
 - copy jobs 177
- regulatory statements
 - environmental product
 - stewardship program 341
- remote configuration
 - digital sending utility 211
 - Web browser 210
 - Web Jetadmin 210
- removing Mac software 61
- repeating defects,
 - troubleshooting 118
- Reports menu, control panel 18
- required settings
 - country/region 207
- resize documents
 - Macintosh 67
 - Windows 150
- resolution
 - setting 221
- restore factory settings 287
- restoring default settings
 - copy 184
- retention, job
 - modes available 157
 - setting options (Windows) 159
- right door
 - jams 299
- rings-to-answer 226
- ruler, repetitive defect 118

S

- safety statements 349, 350
- SAP software 56
- save to device memory
 - enabling 192
- save to network folder
 - enabling 192
- Save to product memory 196
- Save to USB 197
- save to USB
 - enabling 192
- scale documents
 - Macintosh 67
 - Windows 150

- scan
 - job settings 194
- scan settings
 - HP Embedded Web Server 268
- Scan/Digital Send Settings menu,
 - control panel 27
- scanner
 - glass cleaning 311
- scanner glass
 - cleaning 179
- scanning to e-mail
 - about 198
 - address books 202, 203
 - configure 199
 - job settings 194
 - LDAP support 199
 - recipient lists 203
 - sending documents 200
 - SMTP support 199
- scanning to folder 195
- scanning to product memory 196
- scanning to USB 197
- security settings
 - HP Embedded Web Server 270
- security
 - encrypted hard disk 273
- security features 75
- security slot
 - locating 9
- Send to E-mail
 - enabling 192
- Send to Folder 195
- sending a fax
 - delete multiple recipients 243
 - to multiple recipients 241
 - using fax address book
 - numbers 239
- sending to e-mail
 - about 198, 199
 - address books 202, 203
 - job settings 194
 - LDAP support 199
 - recipient lists 203
 - sending documents 200
 - SMTP support 199
- Service menu, control panel 46
- service settings 261

- settings
 - billing codes 219
 - dial tone detection 216
 - dialing mode 213
 - dialing prefix 216
 - driver presets (Mac) 66
 - drivers 53
 - drivers (Mac) 63
 - error correction mode 219
 - fax number confirmation 217
 - fit-to-page 231
 - JBIG compression 218
 - memory lock 247
 - paper tray selection 233
 - priority 52, 63
 - redial interval 214
 - redial-on-busy 215
 - redial-on-no-answer 216
 - required 207
 - resolution 221
 - restore factory 287
 - rings-to-answer 226
 - stamp received faxes 231
- shortcuts (Windows)
 - creating 132
 - using 131
- Sign in
 - control panel 194
- signs, printing 163
- sleep delay
 - disabling 276
 - enabling 276
- sleep mode
 - disabling 275
 - enabling 275
- Sleep Schedule
 - setting 276
- slow fax reception 252
- slow fax transmission 253
- SMTP servers
 - connect to 199
- software
 - embedded Web server 55
 - HP Printer Utility 64
 - HP Web Jetadmin 55
 - installing, USB connections 73
 - installing, wired networks 77
 - Mac 64
 - problems 318
 - settings 52, 63

- software license agreement
 - 332
- supported operating systems
 - 48, 58
- uninstalling for Windows 54
- uninstalling Mac 61
- Solaris software 56
- solving
 - direct-connect problems 316
 - network problems 316
 - walk-up USB printing problems 314
- special media
 - guidelines 82
- special paper
 - copying 183
 - guidelines 82
 - printing (Windows) 145
- specifications
 - electrical and acoustic 338
 - operating environment 338
- speed dial
 - creating 241
 - delete 243
 - list report 260
- Speed Dial List
 - description 264
- speed, optimizing 275
- stamp received faxes 231
- staple options
 - selecting (Windows) 155
- stapler
 - jams 293, 294
- Stapler/Stacker Settings menu, control panel 39
- staples
 - replacing 115
- Start button, control panel touchscreen 14
- status
 - Home screen, control panel 12
 - HP Utility, Macintosh 64
 - messages, types of 288
- status message bar 236
- status, fax accessory page 250
- Stop button, control panel touchscreen 14
- stopping a print request (Windows) 128
- storage, job
 - Macintosh settings 64, 69
 - modes available 157
 - setting options (Windows) 159
- stored jobs
 - creating (Windows) 157
 - creating from a copy 187
 - deleting 159
 - printing 158
 - receiving notification when printed (Windows) 161
 - security 274
 - setting user names (Windows) 161
 - specifying names (Windows) 161
- storing
 - print cartridges 109
- storing jobs
 - permanent copies (Windows) 160
 - permanent private copies (Windows) 161
 - proof and hold (Windows) 159
 - setting options (Windows) 159
 - temporary copies (Windows) 160
 - temporary personal jobs (Windows) 160
 - with Windows 157
- subnet mask 79
- supplies
 - counterfeit 109
 - memory errors 120
 - non-HP 109
 - ordering 322
 - part numbers 323
 - recycling 109, 341
 - status, viewing with HP Utility 64
- supplies status page
 - description 264
 - printing 119
- support
 - online 336
- supported paper 85
- system requirements
 - HP Embedded Web Server 266
- T**
 - T.30 Trace report 261
 - Taiwan EMI statement 350
 - TCP/IP
 - manually configuring IPv4 parameters 79
 - manually configuring IPv6 parameters 80
 - technical support
 - online 336
 - temperature requirements 338
 - tips iii
 - tone dialing
 - setting 213
 - toner cartridges. *See* print cartridges
 - toner collection unit
 - replacing 112
 - top cover
 - jams 297
 - tough paper 163
 - transparencies
 - automatic sensing 102
 - printing (Windows) 145
 - trapping 170
 - Tray 1
 - automatic paper sensing 102
 - capacity 96
 - jams 302
 - Tray 2
 - capacity 96
 - trays
 - capacity 96
 - configure 101
 - included 2
 - jams 304
 - load 90
 - locating 5
 - Macintosh settings 64
 - paper orientation 98
 - selecting (Windows) 135
 - troubleshooting
 - control panel messages 288
 - direct-connect problems 316
 - error messages, numerical list 120
 - jams 289
 - Mac problems 319
 - network problems 316
 - paper feed problems 289

- PBX systems 253
- repeating defects 118
- slow fax reception 252
- slow fax transmission 253
- walk-up USB printing problems 314
- Troubleshooting menu, control panel 42
- troubleshooting tools
 - HP Embedded Web Server 270
- two-sided copying 189
- two-sided printing
 - settings (Windows) 136
 - turning on (Mac) 64

U

- uninstalling Mac software 61
- uninstalling Windows software 54
- universal print driver 51
- UNIX software 56
- updates, downloading product 282
- Usage Page
 - description 264
- USB
 - sending to 197
- USB configuration, Mac 58
- USB configuration, Windows 73
- USB Firmware Upgrade menu, control panel 46
- USB storage accessories
 - printing from 164
- USB, scan to 197
- user names
 - setting for stored jobs (Windows) 161

V

- voice calls and retries 246
- VoIP 248

W

- walk-up USB printing 164
- Warning button, control panel touchscreen 14
- warnings iii
- warranty
 - customer self repair 335
 - license 332

- print cartridges 329
 - product 328
- watermarks
 - adding (Windows) 152
- Web browser requirements
 - HP Embedded Web Server 266
- Web Jetadmin, remote configuration 210
- Web sites
 - customer support 336
 - fraud reports 109
 - HP Web Jetadmin, downloading 272
 - Macintosh customer support 336
 - Material Safety Data Sheet (MSDS) 344
 - universal print driver 51
- Windows
 - driver settings 53
 - drivers supported 49
 - supported operating systems 48
 - universal print driver 51
- wizard, fax setup 208, 211



CC419-90901

