



HP TouchSmart tm2 Notebook PC

Maintenance and Service Guide

© Copyright 2010 Hewlett-Packard
Development Company, L.P.

Bluetooth is a trademark owned by its proprietor and used by Hewlett-Packard Company under license. Intel, Pentium, Celeron, and Core are trademarks or registered trademarks of Intel Corporation or its subsidiaries in the United States and other countries. Microsoft, Windows, and Windows Vista are U.S. registered trademarks of Microsoft Corporation. SD Logo is a trademark of its proprietor.

The information contained herein is subject to change without notice. The only warranties for HP products and services are set forth in the express warranty statements accompanying such products and services. Nothing herein should be construed as constituting an additional warranty. HP shall not be liable for technical or editorial errors or omissions contained herein.

This guide is a troubleshooting reference used for maintaining and servicing the computer. It provides comprehensive information on identifying computer features, components, and spare parts; on troubleshooting computer problems; and on performing computer disassembly procedures.

First Edition: June 2010

Document Part Number: 612233-001

Safety warning notice

- ⚠ **WARNING!** To reduce the possibility of heat-related injuries or of overheating the computer, do not place the computer directly on your lap or obstruct the computer air vents. Use the computer only on a hard, flat surface. Do not allow another hard surface, such as an adjoining optional printer, or a soft surface, such as pillows or rugs or clothing, to block airflow. Also, do not allow the AC adapter to contact the skin or a soft surface, such as pillows or rugs or clothing, during operation. The computer and the AC adapter comply with the user-accessible surface temperature limits defined by the International Standard for Safety of Information Technology Equipment (IEC 60950).
-

Table of contents

1 Product description	1
2 External component identification	4
Top components	4
Display components	4
Keys	5
Lights	6
TouchPad components	7
Front components	8
Rear components	8
Left-side components	9
Right-side components	10
Bottom components	12
3 Illustrated parts catalog	13
Service tag	13
Computer major components	15
Plastics Kit	20
Mass storage devices	21
Miscellaneous parts	22
Sequential part number listing	23
4 Removal and replacement procedures	27
Preliminary replacement requirements	27
Tools required	27
Service considerations	27
Plastic parts	27
Cables and connectors	28
Drive handling	28
Grounding guidelines	29
Electrostatic discharge damage	29
Packaging and transporting guidelines	30
Workstation guidelines	30

Equipment guidelines	31
Component replacement procedures	32
Service tag	32
Computer feet	34
Battery	35
Pen	36
Hard drive	37
Memory module	40
WLAN module	43
RTC battery	47
Top cover	48
Keyboard	50
Pen holder and eject assembly	52
Bluetooth module	53
Power switch board	54
Display assembly	55
System board	59
Power connector and cable	62
Fan	63
Heat sink	64
5 Setup Utility (BIOS)	68
Starting Setup Utility	68
Using Setup Utility	69
Changing the language of Setup Utility	69
Navigating and selecting in Setup Utility	69
Display system information	70
Restoring default settings in Setup Utility	70
Exiting Setup Utility	71
Setup Utility menus	71
Main menu	71
Security menu	71
System Configuration menu	72
Diagnostics menu	72
Updating the BIOS	73
Determining the BIOS	73
Downloading a BIOS update	73
6 Specifications	75
Computer specifications	75
12.1-inch display specifications	76
Hard drive specifications	77
Blu-ray ROM DVD±RW SuperMulti Double-Layer Drive specifications	78

DVD±RW and CD-RW SuperMulti Double-Layer Combo Drive specifications	79
7 Backup and recovery	80
Creating recovery discs	81
Backing up your information	82
Using Windows Backup and Restore	83
Using system restore points	83
When to create restore points	83
Create a system restore point	83
Restore to a previous date and time	84
Performing a recovery	84
Recovering from the recovery discs	84
Recovering from the dedicated recovery partition (select models only)	85
8 Connector pin assignments	86
Audio-in (microphone)	86
Audio-out (headphone)	86
External monitor	87
HDMI	88
RJ-45 (network)	89
Universal Serial Bus	89
9 Power cord set requirements	90
Requirements for all countries	90
Requirements for specific countries and regions	91
10 Recycling	92
Battery	92
Display	92
Index	98

1 Product description

Category	Description
Product Name	HP TouchSmart tm2 Notebook PC
Processors	Intel™ Core™ i5-430UM 1.20-GHz turbo processor (800-MHz FSB, 3-MB L2 cache, 18-W) Intel Core i3-330UM 1.20-GHz processor (800-MHz FSB, 3-MB L2 cache, 18-W) Intel Pentium™ U5400 1.20-GHz processor (800-MHz FSB, 2-MB L2 cache, 18-W)
Chipset	Intel HM55 Express chipset
Graphics	ATi Mobility Radeon HD5450 4550 (ATI Park Pro) graphics subsystem with at least 512-MB of dedicated video memory Support for Blu ray and/or high-definition (HD)-DVD playback with HD decode and DX11 and HDMI support
Panels	12.1-inch, WXGA (1280 × 800, 16:10 wide aspect ratio), LED BrightView with Wacom touch-screen (multitouch enabled) and EMR support Typical brightness: 200 nits
Memory	<ul style="list-style-type: none">• Two SODIMM slots• Customer accessible/upgradable• Dual-channel support <ul style="list-style-type: none">• DDR3, 1333-MHz, can be downgraded to 800-MHz 8192-MB total system memory (4096 MB × 2, dual-channel) 6144-MB total system memory (4096 MB + 2048 MB) 4096-MB total system memory (4096 MB × 1; 2048 MB × 2, dual-channel) 3072-MB total system memory (2048 MB + 1024 MB) 2048-MB total system memory (2048 MB × 1; 1024 MB × 2, dual-channel)
Hard drives	<ul style="list-style-type: none">• Supports all 9.5-mm, 6.35-cm (2.5-inch) hard drives• Serial ATA• Supports Accelerometer hard drive protection 640-GB, 5400-rpm

Category	Description
	500-GB, 7200-rpm
	320-GB, 7200-rpm
	250-GB, 7200-rpm
Optical drives	Supports only external optical drives <ul style="list-style-type: none"> • 12.7-mm tray load • Serial ATA • Blu-ray ROM DVD±RW SuperMulti Double-Layer Drive with LightScribe • DVD±RW and CD-RW SuperMulti Double-Layer Combo Drive with LightScribe
Webcam	HP TrueVision low-light VGA camera, fixed (no tilt), with activity light, 640 × 480 by 24 frames per second
Diskette drive	Supports external USB drive only
Audio	<ul style="list-style-type: none"> • HD audio - Dolby Advanced Audio • Integrated subwoofer • Supports Microsoft® premium requirements • Two omni-directional, digital dual array microphones • Beam-forming, echo-cancellation, noise-suppression software • Pavilion-branded Altec Lansing speakers
Ethernet	Integrated 10/100/1000 (Gigabit Ethernet) network interface card (NIC)
Wireless	<p>Integrated wireless local area network (WLAN) options by way of wireless module (includes two 2.4-GHz antennae in display assembly):</p> <ul style="list-style-type: none"> Atheros 9285G 802.11b/g/n 1x1 WiFi Adapter Broadcom 4313 802.11b/g/n 1x1 WiFi Adapter Intel Centrino Wireless-N 1000 802.11b/g 1x2 WiFi Adapter Ralink RT3090BC4 802.11b/g/n 1x1 WiFi and Bluetooth 2.1+EDR Combo Adapter
External media card	Digital Media Slot, supports Memory Stick, Memory Stick Pro, MultiMediaCard, Secure Digital Memory Card, and xD-Picture Card.
Ports	Audio-in (stereo microphone)
	Audio-out (stereo headphone)
	High-definition multimedia interface (HDMI) v1.3 supporting 1080p with high-bandwidth digital content protection (HDCP) key
	RJ-45 (Ethernet), includes link and activity lights
	USB (3)

Category	Description
	VGA (Dsub 15 pin) supporting 1920 × 1200 external resolution @ 75 Hz. Disabled when connected to devices through the expansion port 3. Hot plug, unplug, and auto detect for correct output to wide-aspect and standard-aspect video.
	2-pin 65-W AC power
Docking	Docking support through the expansion port 3. Supports the HP xb3000 Notebook Expansion Base and the HP Notebook QuickDock.
Keyboard/pointing devices	12.1-inch island-style keyboard with duracoat finish
	Taps enabled as default
	TouchPad with 2 buttons and two-way scroll supports clickpad and HP-defined gestures
	Wacom 9.0-mm touch-screen pen
Power requirements	6-cell, 62-Wh, 2.80-Ah Li-ion battery
	65-W HP Smart AC adapter with localized cable plug support (2-wire plug with ground pin, supports 2-pin DC connector)
Security	Security cable slot
	Fingerprint reader with Digital Persona software support
Operating system	Preinstalled:
	Windows® 7 Home Premium (64-bit)
	Windows 7 Professional (64-bit)
Serviceability	End-user replaceable parts:
	AC adapter
	Battery (system)
	Hard drive
	Memory module
	Optical drive
	RTC battery
	WLAN module
	WWAN module

2 External component identification

Top components

Display components



Item	Component	Function
(1)	WLAN antennas (2)*	Send and receive wireless signals to communicate with wireless local area networks (WLAN).
(2)	Internal microphones (2)	Record sound.
(3)	Webcam light	On: The webcam is in use.
(4)	Webcam	Records video and captures still photographs.
(5)	Speakers (2)	Produce sound.

Item	Component	Function
(6)	Convertible hinge	Swivels the display and converts the computer from traditional notebook mode to slate mode or from slate mode to notebook mode. In slate mode, the display is rotated and folded flat, so that you can view content while carrying the computer.

*The antennas are not visible from the outside of the computer. For optimal transmission, keep the areas immediately around the antennas free from obstructions. To see wireless regulatory notices, refer to the section of the *Regulatory, Safety and Environmental Notices* that applies to your country or region. These notices are located in Help and Support.

Keys

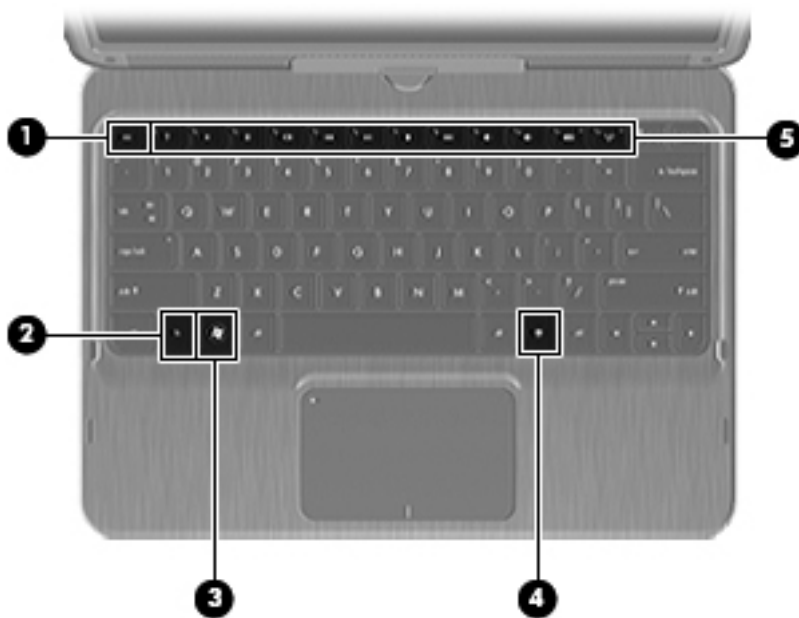

Item	Component	Function
(1)	esc key	Displays system information when pressed in combination with the fn key.
(2)	fn key	Executes frequently used system functions when pressed in combination with an arrow key or the esc key.
(3)	Windows logo key	Displays the Windows Start menu.
(4)	Windows applications key	Displays a shortcut menu for items beneath the cursor.
(5)	Action keys	Execute frequently used system functions.

Lights



Item	Component	Description
(1)	Caps lock light	White: Caps lock is on.
(2)	Mute light	Amber: Computer sound is off.
(3)	Wireless light	<ul style="list-style-type: none">White: An integrated wireless device, such as a wireless local area network (WLAN) device and/or a Bluetooth device, is on. <p>NOTE: Wireless devices are enabled at the factory.</p> <ul style="list-style-type: none">Amber: All wireless devices are off.
(4)	TouchPad off indicator	<ul style="list-style-type: none">Amber: The TouchPad is off.Off: The TouchPad is on.

TouchPad components

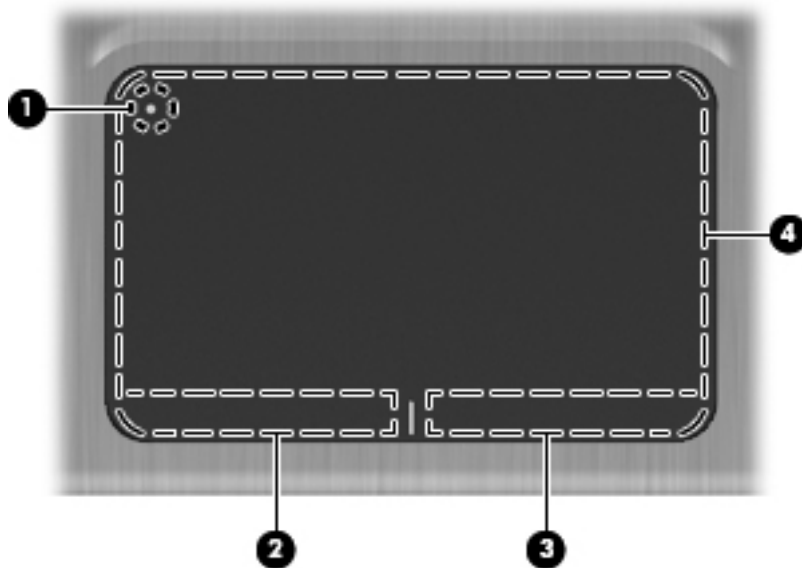

Item	Component	Function
(1)	TouchPad off indicator	To turn the TouchPad zone on and off, quickly double-tap the TouchPad off indicator. NOTE: When the TouchPad zone is active, the light is off.
(2)	Left TouchPad button	Functions like the left button on an external mouse.
(3)	Right TouchPad button	Functions like the right button on an external mouse.
(4)	TouchPad zone	Moves the pointer and selects or activates items on the screen.

Front components



Component	Function
Vent	Enables airflow to cool internal components. NOTE: The computer fan starts up automatically to cool internal components and prevent overheating. It is normal for the internal fan to cycle on and off during routine operation.

Rear components



Item	Component	Function
(1)	Security cable slot	Attaches an optional security cable to the computer. NOTE: The security cable is designed to act as a deterrent, but it may not prevent the computer from being mishandled or stolen.
(2)	External monitor port	Connects an external VGA monitor or projector.
(3)	RJ-45 (network) jack	Connects a network cable.

Left-side components

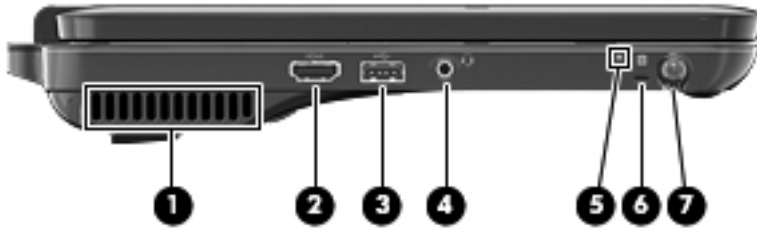

Item	Component	Function
(1)	Vent	Enables airflow to cool internal components. NOTE: The computer fan starts up automatically to cool internal components and prevent overheating. It is normal for the internal fan to cycle on and off during routine operation.
(2)	HDMI port	Connects an optional video or audio device, such as a high-definition television, or any compatible digital or audio component.
(3)	USB port	Connects an optional USB device.
(4)	Audio-out (headphone) jack/Audio-in (microphone) jack	Produces sound when connected to optional powered stereo speakers, headphones, earbuds, a headset, or television audio. Also connects an optional headset microphone. NOTE: When a device is connected to the jack, the device speakers are disabled.
(5)	Drive light	<ul style="list-style-type: none"> Blinking white: The hard drive is being accessed. Amber: HP ProtectSmart Hard Drive Protection has temporarily parked the hard drive.
(6)	Pen tether hole	Connects the pen tether.
(7)	Pen holder	Holds the digitizer pen.

Right-side components

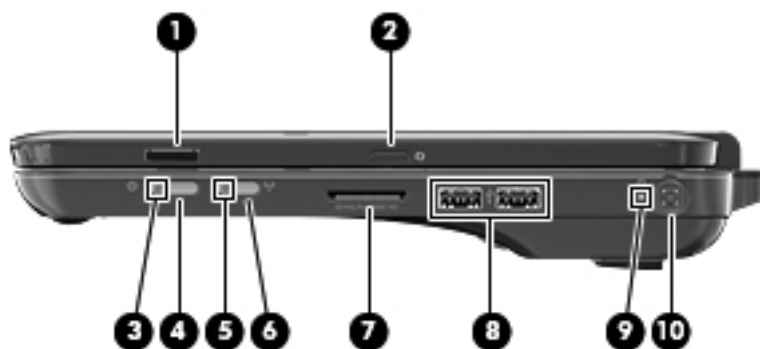

Item	Component	Function
(1)	Fingerprint reader (select models only)	Allows a fingerprint logon to Windows instead of a password logon.
(2)	Rotate button	Rotates the screen image counterclockwise to 4 orientations: landscape primary, portrait primary, landscape secondary, and portrait secondary.
(3)	Power light	<ul style="list-style-type: none"> White: The computer is on. Blinking white: The computer is in the Sleep state. Off: The computer is off or in Hibernation.
(4)	Power switch	<ul style="list-style-type: none"> When the computer is off, slide the power switch to turn on the computer. When the computer is on, briefly slide the power switch to exit Sleep. When the computer is in the Sleep state, briefly slide the power switch to exit Sleep. When the computer is in Hibernation, briefly slide the power switch to exit Hibernation. <p>If the computer has stopped responding and Windows shutdown procedures are ineffective, slide and hold the power switch for at least 5 seconds to turn off the computer.</p> <p>To learn more about your power settings, select Start > Control Panel > System and Security > Power Options.</p>
(5)	Wireless light	<ul style="list-style-type: none"> White: An integrated wireless device, such as a WLAN device and/or a Bluetooth device, is on. <p>NOTE: Wireless devices are enabled at the factory.</p> <ul style="list-style-type: none"> Amber: All wireless devices are off.

Item	Component	Function
(6)	Wireless button	<p>Turns the wireless feature on or off, but does not establish a wireless connection.</p> <p>NOTE: A wireless network must be set up in order to establish a wireless connection.</p>
(7)	Digital Media Slot	<p>Supports the following digital card formats:</p> <ul style="list-style-type: none"> • Memory Stick • Memory Stick Pro • MultiMediaCard • Secure Digital Memory Card • xD-Picture Card
(8)	USB ports (2)	Connect optional USB devices.
(9)	Battery light	<ul style="list-style-type: none"> • Off: The computer is running on battery power. • Blinking amber: The battery has reached a low battery level, a critical battery level, or there is a battery error. • Amber: A battery is charging. • White: The computer is connected to external power and the battery is fully charged.
(10)	Power connector	Connects an AC adapter.

Bottom components

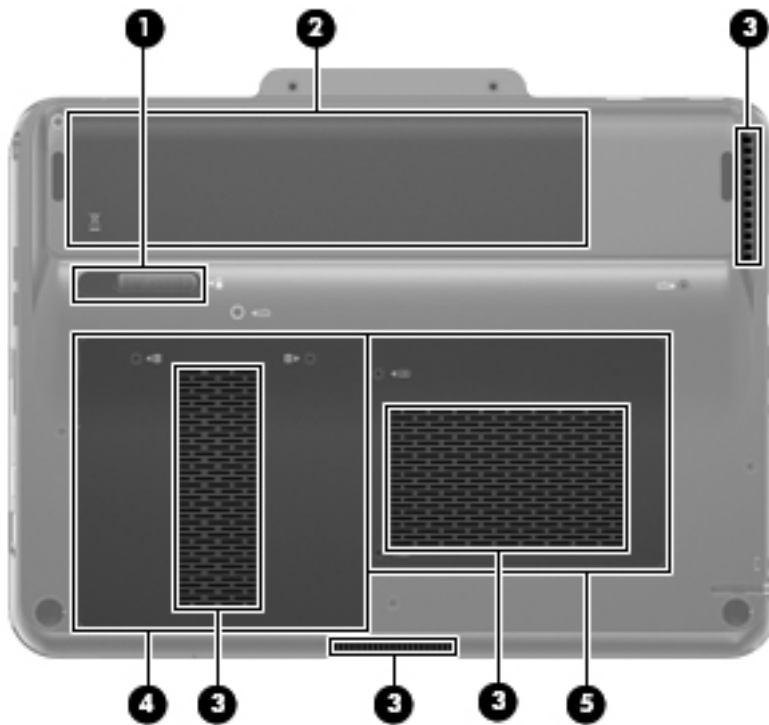

Item	Component	Function
(1)	Battery release latch	Releases the battery from the battery bay.
(2)	Battery bay	Holds the battery and contains the SIM slot. NOTE: The battery is preinstalled in the battery bay at the factory.
(3)	Vents (4)	Enable airflow to cool internal components. NOTE: The computer fan starts up automatically to cool internal components and prevent overheating. It is normal for the internal fan to cycle on and off during routine operation.
(4)	Hard drive bay	Holds the hard drive.
(5)	Memory module compartment	Contains the memory module slots, WLAN module slot, and holds the RTC battery.

3 Illustrated parts catalog

Service tag

When ordering parts or requesting information, provide the computer serial number and model description provided on the service tag.

- (1)** Product name: This is the product name affixed to the front of the computer.
- (2)** Serial number (s/n): This is an alphanumeric identifier that is unique to each product.
- (3)** Part number/Product number (p/n): This number provides specific information about the product's hardware components. The part number helps a service technician to determine what components and parts are needed.
- (4)** Model description: This is the number used to locate documents, drivers, and support for the computer.
- (5)** Warranty period: This number describes the duration of the warranty period for the computer.

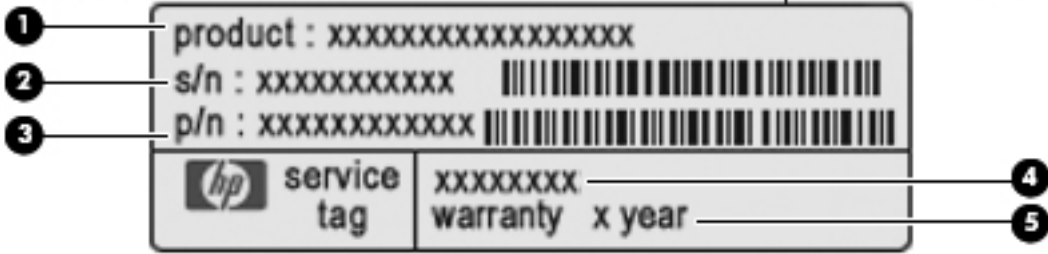

Computer major components

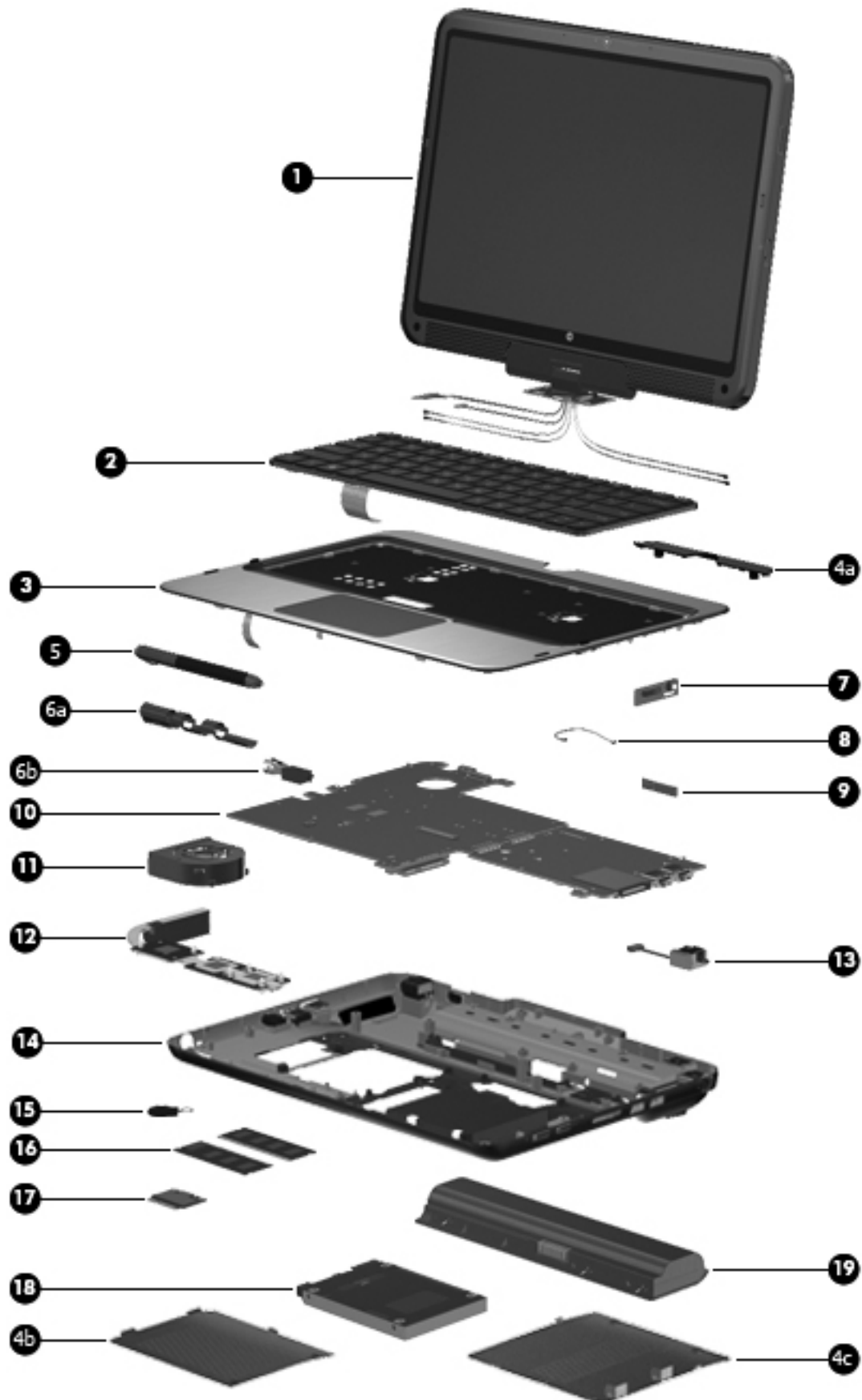

Item	Description	Spare part number
(1)	12.1-inch, WXGA, BrightView, LED touch-screen display assembly (includes Web camera and cable, microphones and cables, fingerprint reader and cable, WLAN antenna cables, and WWAN antenna cables)	611492-001
	Display assembly subcomponents (not illustrated):	
	Display bezel	592956-001
	Web camera/microphone module (includes cable)	592960-001
	Fingerprint reader board (includes cable)	592959-001
	Reset board (includes cable)	611494-001
	Speakers (include cable)	592958-001
	Display enclosure	592955-001
	Display Screw Kit	592962-001
(2)	Keyboard (includes cable and 2 retention clips):	
	For use in Belgium	584161-A41
	For use in Brazil	584161-201
	For use in Canada	584161-121
	For use in Denmark, Finland, and Norway	584161-DH1
	For use in France	584161-051
	For use in Germany	584161-041
	For use in Greece	584161-DJ1
	For use in Israel	584161-BB1
	For use in Italy	584161-061
	For use in Latin America	584161-161
	For use in the Netherlands	584161-B31
	For use in Portugal	584161-131
	For use in Russia	584161-251
	For use in Saudi Arabia	584161-171
	For use in South Korea	584161-AD1
	For use in Spain	584161-071
	For use in Switzerland	584161-BG1
	For use in Taiwan	584161-AB1
	For use in Thailand	584161-281
	For use in Turkey	584161-141
	For use in the United Kingdom	584161-031

Item	Description	Spare part number
	For use in the United States	584161-001
(3)	Top cover (includes TouchPad and TouchPad cable, caps lock light board and cable, and top cover bumper pads)	592964-001
	Plastics Kit , includes:	592971-001
(4a)	Display hinge cover	
(4b)	Memory module compartment cover (includes 2 captive screws, secured with C-clips)	
(4c)	Hard drive cover (includes 2 captive screws, secured with C-clips)	
(5)	Pen	593028-001
(6a)	Pen holder (includes pen eject assembly)	592972-001
(6b)	Pen eject assembly	
(7)	Power switch board (includes cable)	611498-001
	Cable Kit , includes:	613451-001
(8)	Bluetooth module cable	
(9)	Bluetooth module	537921-001
(10)	System board (includes replacement thermal material):	
	Equipped with discrete graphics subsystem and Intel Core i5-430UM 1.20-GHz turbo processor (800-MHz FSB, 3-MB L2 cache, 18-W)	611491-001
	Equipped with discrete graphics subsystem and Intel Core i3-330UM 1.20-GHz processor (800-MHz FSB, 3-MB L2 cache, 18-W)	611489-001
	Equipped with discrete graphics subsystem and Intel Pentium U5400 1.20-GHz processor (800-MHz FSB, 2-MB L2 cache, 18-W)	611487-001
	Equipped with UMA graphics subsystem and Intel Core i5-430UM 1.20-GHz turbo processor (800-MHz FSB, 3-MB L2 cache, 18-W)	611490-001
	Equipped with UMA graphics subsystem and Intel Core i3-330UM 1.20-GHz processor (800-MHz FSB, 3-MB L2 cache, 18-W)	611488-001
	Equipped with UMA graphics subsystem and Intel Pentium U5400 1.20-GHz processor (800-MHz FSB, 2-MB L2 cache, 18-W)	611486-001
(11)	Fan	592970-001
(12)	Heat sink (includes replacement thermal material):	
	For use only on computer models equipped with discrete graphics subsystem	611499-001
	For use only on computer models equipped with UMA graphics subsystem	611500-001
(13)	Power connector and cable	592967-001
(14)	Base enclosure (includes 2 battery release latches, and 4 rubber feet)	611496-001
	Rubber Kit (not illustrated, includes 4 base enclosure rubber feet and pen cover)	592966-001
(15)	RTC battery (includes cable and double-sided tape)	592965-001

Item	Description	Spare part number
(16)	Memory modules (PC3, 1066-MHz):	
	4096-MB	599092-001
	248-MB	598856-001
	1024-MB	598859-001
(17)	WLAN module:	
	Atheros 9285G 802.11b/g/n 1x1 WiFi Adapter for use in Canada, the Cayman Islands, Guam, Puerto Rico, the U.S. Virgin Islands, and the United States	580101-001
	Atheros 9285G 802.11b/g/n 1x1 WiFi Adapter for use in Afghanistan, Albania, Algeria, Andorra, Angola, Antigua and Barbuda, Argentina, Armenia, Aruba, Australia, Austria, Azerbaijan, the Bahamas, Bahrain, Bangladesh, Barbados, Belgium, Belize, Benin, Bermuda, Bolivia, Bosnia and Herzegovina, Botswana, Brazil, the British Virgin Islands, Brunei, Bulgaria, Burkina Faso, Burundi, Cameroon, Cape Verde, the Cayman Islands, the Central African Republic, Chad, Chile, Colombia, Comoros, the Congo, Costa Rica, Croatia, Cyprus, the Czech Republic, Denmark, Djibouti, Dominica, the Dominican Republic, East Timor, Ecuador, Egypt, El Salvador, Equatorial Guinea, Eritrea, Estonia, Ethiopia, Fiji, Finland, France, French Guiana, Gabon, Gambia, Georgia, Germany, Ghana, Gibraltar, Greece, Guadeloupe, Guam, Guatemala, Guinea, Guinea-Bissau, Guyana, Haiti, Honduras, Hong Kong, Hungary, Iceland, India, Ireland, Italy, the Ivory Coast, Jamaica, Jordan, Kenya, Kiribati, Kyrgyzstan, Laos, Latvia, Lesotho, Liberia, Liechtenstein, Lithuania, Luxembourg, Macedonia, Madagascar, Malawi, the Maldives, Mali, Malta, the Marshall Islands, Martinique, Mauritania, Mauritius, Mexico, Micronesia, Monaco, Mongolia, Montenegro, Morocco, Mozambique, Namibia, Nauru, Nepal, the Netherlands, New Zealand, Nicaragua, Niger, Nigeria, Norway, Oman, Pakistan, Palau, Panama, Papua New Guinea, Paraguay, the People's Republic of China, Peru, the Philippines, Poland, Portugal, Puerto Rico, the Republic of Moldova, Romania, Russia, Rwanda, Samoa, San Marino, Sao Tome and Principe, Saudi Arabia, Senegal, Serbia, the Seychelles, Sierra Leone, Singapore, Slovakia, Slovenia, the Solomon Islands, Somalia, South Africa, Spain, Sri Lanka, St. Kitts and Nevis, St. Lucia, St. Vincent and the Grenadines, Suriname, Swaziland, Sweden, Switzerland, Taiwan, Tajikistan, Tanzania, Togo, Tonga, Trinidad and Tobago, Tunisia, Turkey, Turkmenistan, Tuvalu, Uganda, the United Arab Emirates, the United Kingdom, Uruguay, Uzbekistan, Venezuela, Vietnam, Yemen, Zaire, Zambia, and Zimbabwe	580101-002
	Broadcom 4313 802.11b/g/n 1x1 WiFi Adapter	593836-001
	Intel Centrino Wireless-N 1000 802.11b/g 1x2 WiFi Adapter	593530-001
	Ralink RT3090BC4 802.11b/g/n 1x1 WiFi and Bluetooth 2.1+EDR Combo Adapter	602992-001
(18)	Hard drive (includes hard drive bracket, hard drive connector, and Mylar cover):	
	640-GB, 5400-rpm	611495-001
	500-GB, 7200-rpm	584381-001
	320-GB, 7200-rpm	584380-001
	250-GB, 7200-rpm	584379-001

Item	Description	Spare part number
	Hard Drive Hardware Kit (not illustrated; includes hard drive bracket and hard drive screws)	584382-001
(19)	6-cell, 62-Wh, 2.8-Ah, Li-ion battery	586021-001

Plastics Kit

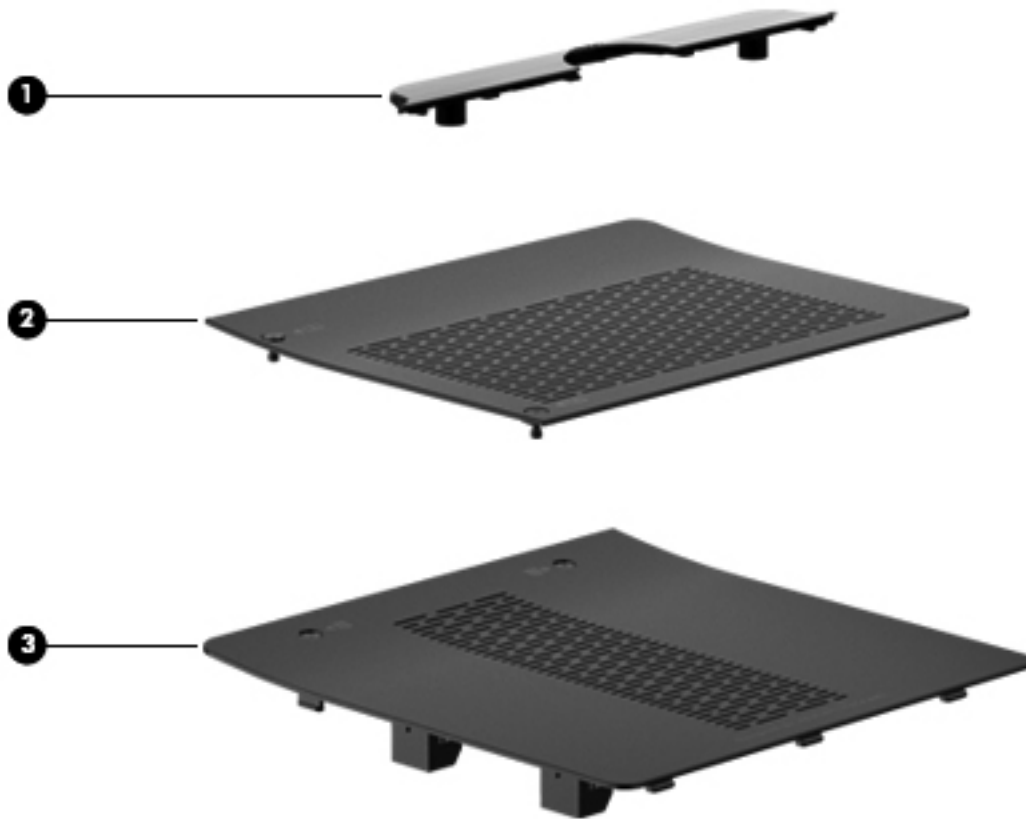

Item	Description	Spare part number
	Plastics Kit , includes:	592971-001
(1)	Display hinge cover	
(2)	Memory module compartment cover (includes 2 captive screws, secured with C-clips)	
(3)	Hard drive cover (includes 1 rubber foot and 2 captive screws, secured with C-clips)	

Mass storage devices



Item	Description	Spare part number
(1)	Hard drive (includes hard drive bracket and Mylar cover):	
	640-GB, 5400-rpm	611495-001
	500-GB, 7200-rpm	584381-001
	320-GB, 7200-rpm	584380-001
	250-GB, 7200-rpm	584379-001
	Hard Drive Hardware Kit (not illustrated, includes hard drive bracket, Mylar cover, and hard drive screws)	584382-001
(2)	External optical drive (includes bezel, bracket, and cable):	
	Blu-ray ROM DVD±RW SuperMulti Double-Layer Drive with LightScribe	584384-001
	DVD±RW and CD-RW SuperMulti Double-Layer Combo Drive with LightScribe	584383-001

Miscellaneous parts

Description	Spare part number
AC adapter:	
65-W RC/V HP Smart AC adapter	609939-001
65-W RC/V EM HP Smart AC adapter	609948-001
HP protective sleeve	598207-001
Power cords:	
For use in Argentina	490371-D01
For use in Australia	490371-011
For use in Brazil	490371-201 and 490371-202
For use in Denmark	490371-081
For use in Europe, the Middle East, and Africa (excluding South Africa)	490371-021
For use in India	490371-D61
For use in Israel	490371-BB1
For use in Italy	490371-061
For use in North America	490371-001
For use in the People's Republic of China	490371-AA1
For use in South Korea	490371-AD1
For use in Switzerland	490371-111
For use in Taiwan	490371-AB1
For use in the United Kingdom and Singapore	490371-031
Screw Kit	592973-001
Wired headset with volume control	371693-001

Sequential part number listing

Spare part number	Description
371693-001	Wired headset with volume control
490371-001	Power cord for use in North America
490371-011	Power cord for use in Australia
490371-021	Power cord for use in Europe, the Middle East, and Africa (excluding South Africa)
490371-031	Power cord for use in the United Kingdom and Singapore
490371-061	Power cord for use in Italy
490371-081	Power cord for use in Denmark
490371-111	Power cord for use in Australia
490371-201	Power cord for use in Brazil
490371-202	Power cord for use in Brazil
490371-AA1	Power cord for use in the People's Republic of China
490371-AB1	Power cord for use in Taiwan
490371-AD1	Power cord for use in South Korea
490371-BB1	Power cord for use in Israel
490371-D01	Power cord for use in Argentina
490371-D61	Power cord for use in India
537921-001	Bluetooth module
	NOTE: The Bluetooth module spare part kit does not include a Bluetooth module cable. The Bluetooth module cable is included in the Cable Kit, spare part number 613451-001.
580101-001	Atheros 9285G 802.11b/g/n 1x1 WiFi Adapter for use in Canada, the Cayman Islands, Guam, Puerto Rico, the U.S. Virgin Islands, and the United States

Spare part number	Description
580101-002	Atheros 9285G 802.11b/g/n 1x1 WiFi Adapter for use in Afghanistan, Albania, Algeria, Andorra, Angola, Antigua and Barbuda, Argentina, Armenia, Aruba, Australia, Austria, Azerbaijan, the Bahamas, Bahrain, Bangladesh, Barbados, Belgium, Belize, Benin, Bermuda, Bolivia, Bosnia and Herzegovina, Botswana, Brazil, the British Virgin Islands, Brunei, Bulgaria, Burkina Faso, Burundi, Cameroon, Cape Verde, the Cayman Islands, the Central African Republic, Chad, Chile, Colombia, Comoros, the Congo, Costa Rica, Croatia, Cyprus, the Czech Republic, Denmark, Djibouti, Dominica, the Dominican Republic, East Timor, Ecuador, Egypt, El Salvador, Equatorial Guinea, Eritrea, Estonia, Ethiopia, Fiji, Finland, France, French Guiana, Gabon, Gambia, Georgia, Germany, Ghana, Gibraltar, Greece, Guadeloupe, Guam, Guatemala, Guinea, Guinea-Bissau, Guyana, Haiti, Honduras, Hong Kong, Hungary, Iceland, India, Ireland, Italy, the Ivory Coast, Jamaica, Jordan, Kenya, Kiribati, Kyrgyzstan, Laos, Latvia, Lesotho, Liberia, Liechtenstein, Lithuania, Luxembourg, Macedonia, Madagascar, Malawi, the Maldives, Mali, Malta, the Marshall Islands, Martinique, Mauritania, Mauritius, Mexico, Micronesia, Monaco, Mongolia, Montenegro, Morocco, Mozambique, Namibia, Nauru, Nepal, the Netherlands, New Zealand, Nicaragua, Niger, Nigeria, Norway, Oman, Pakistan, Palau, Panama, Papua New Guinea, Paraguay, the People's Republic of China, Peru, the Philippines, Poland, Portugal, Puerto Rico, the Republic of Moldova, Romania, Russia, Rwanda, Samoa, San Marino, Sao Tome and Principe, Saudi Arabia, Senegal, Serbia, the Seychelles, Sierra Leone, Singapore, Slovakia, Slovenia, the Solomon Islands, Somalia, South Africa, Spain, Sri Lanka, St. Kitts and Nevis, St. Lucia, St. Vincent and the Grenadines, Suriname, Swaziland, Sweden, Switzerland, Taiwan, Tajikistan, Tanzania, Togo, Tonga, Trinidad and Tobago, Tunisia, Turkey, Turkmenistan, Tuvalu, Uganda, the United Arab Emirates, the United Kingdom, Uruguay, Uzbekistan, Venezuela, Vietnam, Yemen, Zaire, Zambia, and Zimbabwe
584161-001	Keyboard for use in the United States (includes cable and 2 retention clips)
584161-031	Keyboard for use in the United Kingdom (includes cable and 2 retention clips)
584161-041	Keyboard for use in Germany (includes cable and 2 retention clips)
584161-051	Keyboard for use in France (includes cable and 2 retention clips)
584161-061	Keyboard for use in Italy (includes cable and 2 retention clips)
584161-071	Keyboard for use in Spain (includes cable and 2 retention clips)
584161-121	Keyboard for use in French Canada (includes cable and 2 retention clips)
584161-131	Keyboard for use in Portugal (includes cable and 2 retention clips)
584161-141	Keyboard for use in Turkey (includes cable and 2 retention clips)
584161-161	Keyboard for use in Latin America (includes cable and 2 retention clips)
584161-171	Keyboard for use in Saudi Arabia (includes cable and 2 retention clips)
584161-201	Keyboard for use in Brazil (includes cable and 2 retention clips)
584161-251	Keyboard for use in Russia (includes cable and 2 retention clips)
584161-281	Keyboard for use in Thailand (includes cable and 2 retention clips)
584161-A41	Keyboard for use in Belgium (includes cable and 2 retention clips)
584161-AB1	Keyboard for use in Taiwan (includes cable and 2 retention clips)
584161-AD1	Keyboard for use in South Korea (includes cable and 2 retention clips)
584161-B31	Keyboard for use in the Netherlands (includes cable and 2 retention clips)
584161-BB1	Keyboard for use in Israel (includes cable and 2 retention clips)

Spare part number	Description
584161-BG1	Keyboard for use in Switzerland (includes cable and 2 retention clips)
584161-DH1	Keyboard for use in Denmark, Finland, and Norway (includes cable and 2 retention clips)
584161-DJ1	Keyboard for use in Greece (includes cable and 2 retention clips)
584379-001	320-GB, 7200-rpm hard drive (includes hard drive bracket and Mylar cover)
584380-001	250-GB, 7200-rpm hard drive (includes hard drive bracket and Mylar cover)
584381-001	160-GB, 7200-rpm hard drive (includes hard drive bracket and Mylar cover)
584382-001	Hard Drive Hardware Kit (includes hard drive bracket, Mylar cover, and hard drive screws)
584383-001	DVD±RW and CD-RW SuperMulti Double-Layer Combo Drive with LightScribe external drive (includes bezel, bracket, and cable)
584384-001	Blu-ray ROM DVD±RW SuperMulti Double-Layer Drive with LightScribe external drive (includes bezel, bracket, and cable)
586021-001	6-cell, 62-Wh, 2.8-Ah, Li-ion battery
592955-001	Display enclosure
592956-001	Display bezel
592958	Speakers (include cable)
-001	
592959-001	Fingerprint reader board (includes cable)
592960-001	Web camera/microphone module (includes cable)
592962-001	Display Screw Kit
592964-001	Top cover (includes TouchPad and TouchPad cable, caps lock light board and cable, and top cover bumper pads)
592965-001	RTC battery (includes cable and double-sided tape)
592966-001	Rubber Kit (includes 4 base enclosure rubber feet, pen cover, and RJ45 cover)
592967-001	Power connector and cable
592970-001	Fan
592971-001	Plastics Kit
	NOTE: See Plastics Kit on page 20 for more Plastics Kit information.
592972-001	Pen holder and pen eject assembly
592973-001	Screw Kit
593028-001	Pen
593530-001	Intel Centrino Wireless-N 1000 802.11b/g 1x2 WiFi Adapter for use in all countries and regions
593836-001	Broadcom 4313 802.11b/g/n 1x1 WiFi Adapter
598207-001	HP protective sleeve

Spare part number	Description
598856-001	4096-MB memory module (PC3, 1066-MHz)
598859-001	2048-MB memory module (PC3, 1066-MHz)
599092-001	1024-MB memory module (PC3, 1066-MHz)
602992-001	Ralink RT3090BC4 802.11b/g/n 1x1 WiFi and Bluetooth 2.1+EDR Combo Adapter
609939-001	65-W RC/V HP Smart AC adapter
609948-001	65-W RC/V EM HP Smart AC adapter
611486-001	System board equipped with UMA graphics subsystem and Intel Pentium U5400 1.20-GHz processor (800-MHz FSB, 2-MB L2 cache, 18-W; includes replacement thermal material)
611487-001	System board equipped with discrete graphics subsystem and Intel Pentium U5400 1.20-GHz processor (800-MHz FSB, 2-MB L2 cache, 18-W; includes replacement thermal material)
611488-001	System board equipped with UMA graphics subsystem and Intel Core i3-330UM 1.20-GHz processor (800-MHz FSB, 3-MB L2 cache, 18-W; includes replacement thermal material)
611489-001	System board equipped with discrete graphics subsystem and Intel Core i3-330UM 1.20-GHz processor (800-MHz FSB, 3-MB L2 cache, 18-W; includes replacement thermal material)
611490-001	System board equipped with UMA graphics subsystem and Intel Core i5-430UM 1.20-GHz turbo processor (800-MHz FSB, 3-MB L2 cache, 18-W; includes replacement thermal material)
611491-001	System board equipped with discrete graphics subsystem and Intel Core i5-430UM 1.20-GHz turbo processor (800-MHz FSB, 3-MB L2 cache, 18-W; includes replacement thermal material)
611492-001	12.1-inch, WXGA, BrightView, LED touch-screen display assembly (includes Web camera and cable, microphones and cables, fingerprint reader and cable, WLAN antenna cables, and WWAN antenna cables)
611494-001	Reset board (includes cable)
611495-001	160-GB, 7200-rpm hard drive (includes hard drive bracket and Mylar cover)
611496-001	Base enclosure (includes 2 battery release latches, and 4 rubber feet)
611498-001	Power switch board (includes cable)
611499-001	Heat sink for use only with computer models equipped with discrete graphics subsystem (includes replacement thermal material)
611500-001	Heat sink for use only with computer models equipped with UMA graphics subsystem (includes replacement thermal material)
613451-001	Cable Kit (includes the Bluetooth module cable)

4 Removal and replacement procedures

Preliminary replacement requirements

Tools required

You will need the following tools to complete the removal and replacement procedures:

- Magnetic screwdriver
- Phillips P0 and P1 screwdrivers
- Flat-bladed screwdriver

Service considerations

The following sections include some of the considerations that you should keep in mind during disassembly and assembly procedures.

 **NOTE:** As you remove each subassembly from the computer, place the subassembly (and all accompanying screws) away from the work area to prevent damage.

Plastic parts

 **CAUTION:** Using excessive force during disassembly and reassembly can damage plastic parts. Use care when handling the plastic parts. Apply pressure only at the points designated in the maintenance instructions.

Cables and connectors

-
- △ **CAUTION:** When servicing the computer, be sure that cables are placed in their proper locations during the reassembly process. Improper cable placement can damage the computer.
-

Cables must be handled with extreme care to avoid damage. Apply only the tension required to unseat or seat the cables during removal and insertion. Handle cables by the connector whenever possible. In all cases, avoid bending, twisting, or tearing cables. Be sure that cables are routed in such a way that they cannot be caught or snagged by parts being removed or replaced. Handle flex cables with extreme care; these cables tear easily.

Drive handling

-
- △ **CAUTION:** Drives are fragile components that must be handled with care. To prevent damage to the computer, damage to a drive, or loss of information, observe these precautions:

Before removing or inserting a hard drive, shut down the computer. If you are unsure whether the computer is off or in Hibernation, turn the computer on, and then shut it down through the operating system.

Before handling a drive, be sure that you are discharged of static electricity. While handling a drive, avoid touching the connector.

Before removing a diskette drive or optical drive, be sure that a diskette or disc is not in the drive and be sure that the optical drive tray is closed.

Handle drives on surfaces covered with at least one inch of shock-proof foam.

Avoid dropping drives from any height onto any surface.

After removing a hard drive, an optical drive, or a diskette drive, place it in a static-proof bag.

Avoid exposing a hard drive to products that have magnetic fields, such as monitors or speakers.

Avoid exposing a drive to temperature extremes or liquids.

If a drive must be mailed, place the drive in a bubble pack mailer or other suitable form of protective packaging and label the package "FRAGILE."

Grounding guidelines

Electrostatic discharge damage

Electronic components are sensitive to electrostatic discharge (ESD). Circuitry design and structure determine the degree of sensitivity. Networks built into many integrated circuits provide some protection, but in many cases, ESD contains enough power to alter device parameters or melt silicon junctions.

A discharge of static electricity from a finger or other conductor can destroy static-sensitive devices or microcircuitry. Even if the spark is neither felt nor heard, damage may have occurred.

An electronic device exposed to ESD may not be affected at all and can work perfectly throughout a normal cycle. Or the device may function normally for a while, then degrade in the internal layers, reducing its life expectancy.

△ **CAUTION:** To prevent damage to the computer when you are removing or installing internal components, observe these precautions:

Keep components in their electrostatic-safe containers until you are ready to install them.

Use nonmagnetic tools.

Before touching an electronic component, discharge static electricity by using the guidelines described in this section.

Avoid touching pins, leads, and circuitry. Handle electronic components as little as possible.

If you remove a component, place it in an electrostatic-safe container.

The following table shows how humidity affects the electrostatic voltage levels generated by different activities.

△ **CAUTION:** A product can be degraded by as little as 700 V.

Typical electrostatic voltage levels

Event	Relative humidity		
	10%	40%	55%
Walking across carpet	35,000 V	15,000 V	7,500 V
Walking across vinyl floor	12,000 V	5,000 V	3,000 V
Motions of bench worker	6,000 v	800 V	400 V
Removing DIPS from plastic tube	2,000 V	700 V	400 V
Removing DIPS from vinyl tray	11,500 V	4,000 V	2,000 V
Removing DIPS from Styrofoam	14,500 V	5,000 V	3,500 V
Removing bubble pack from PCB	26,500 V	20,000 V	7,000 V
Packing PCBs in foam-lined box	21,000 V	11,000 V	5,000 V

Packaging and transporting guidelines

Follow these grounding guidelines when packaging and transporting equipment:

- To avoid hand contact, transport products in static-safe tubes, bags, or boxes.
- Protect ESD-sensitive parts and assemblies with conductive or approved containers or packaging.
- Keep ESD-sensitive parts in their containers until the parts arrive at static-free workstations.
- Place items on a grounded surface before removing items from their containers.
- Always be properly grounded when touching a component or assembly.
- Store reusable ESD-sensitive parts from assemblies in protective packaging or nonconductive foam.
- Use transporters and conveyors made of antistatic belts and roller bushings. Be sure that mechanized equipment used for moving materials is wired to ground and that proper materials are selected to avoid static charging. When grounding is not possible, use an ionizer to dissipate electric charges.

Workstation guidelines

Follow these grounding workstation guidelines:

- Cover the workstation with approved static-shielding material.
- Use a wrist strap connected to a properly grounded work surface and use properly grounded tools and equipment.
- Use conductive field service tools, such as cutters, screwdrivers, and vacuums.
- When fixtures must directly contact dissipative surfaces, use fixtures made only of static-safe materials.
- Keep the work area free of nonconductive materials, such as ordinary plastic assembly aids and Styrofoam.
- Handle ESD-sensitive components, parts, and assemblies by the case or PCM laminate. Handle these items only at static-free workstations.
- Avoid contact with pins, leads, or circuitry.
- Turn off power and input signals before inserting or removing connectors or test equipment.

Equipment guidelines

Grounding equipment must include either a wrist strap or a foot strap at a grounded workstation.

- When seated, wear a wrist strap connected to a grounded system. Wrist straps are flexible straps with a minimum of one megohm $\pm 10\%$ resistance in the ground cords. To provide proper ground, wear a strap snugly against the skin at all times. On grounded mats with banana-plug connectors, use alligator clips to connect a wrist strap.
- When standing, use foot straps and a grounded floor mat. Foot straps (heel, toe, or boot straps) can be used at standing workstations and are compatible with most types of shoes or boots. On conductive floors or dissipative floor mats, use foot straps on both feet with a minimum of one megohm resistance between the operator and ground. To be effective, the conductive strips must be worn in contact with the skin.

The following grounding equipment is recommended to prevent electrostatic damage:

- Antistatic tape
- Antistatic smocks, aprons, and sleeve protectors
- Conductive bins and other assembly or soldering aids
- Nonconductive foam
- Conductive tabletop workstations with ground cords of one megohm resistance
- Static-dissipative tables or floor mats with hard ties to the ground
- Field service kits
- Static awareness labels
- Material-handling packages
- Nonconductive plastic bags, tubes, or boxes
- Metal tote boxes
- Electrostatic voltage levels and protective materials

The following table lists the shielding protection provided by antistatic bags and floor mats.

Material	Use	Voltage protection level
Antistatic plastic	Bags	1,500 V
Carbon-loaded plastic	Floor mats	7,500 V
Metallized laminate	Floor mats	5,000 V

Component replacement procedures

This chapter provides removal and replacement procedures.

There are as many as 56?? screws that must be removed, replaced, or loosened when servicing the computer. Make special note of each screw size and location during removal and replacement.

Service tag

When ordering parts or requesting information, provide the computer serial number and model description provided on the service tag.

- (1)** Product name: This is the product name affixed to the front of the computer.
- (2)** Serial number (s/n): This is an alphanumeric identifier that is unique to each product.
- (3)** Part number/Product number (p/n): This number provides specific information about the product's hardware components. The part number helps a service technician to determine what components and parts are needed.
- (4)** Model description: This is the number used to locate documents, drivers, and support for the computer.
- (5)** Warranty period: This number describes the duration of the warranty period for the computer.

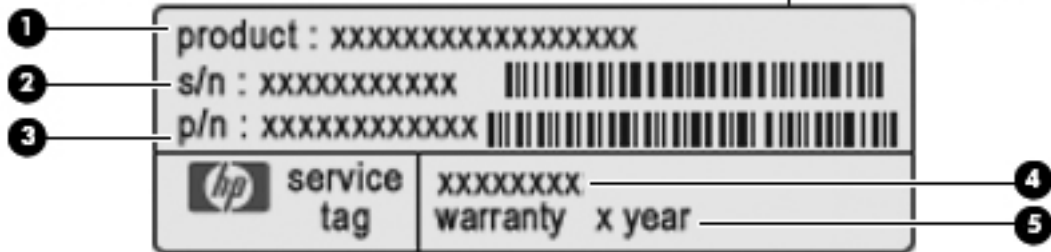

Computer feet

The computer feet are adhesive-backed rubber pads. There are four computer feet that adhere to the computer base enclosure. The feet **(1)** on the front edge of the computer are round. The feet **(2)** on the rear edge of the computer are oblong and wedge-shaped. The computer feet are available in the Rubber Kit, spare part number 592966-001.

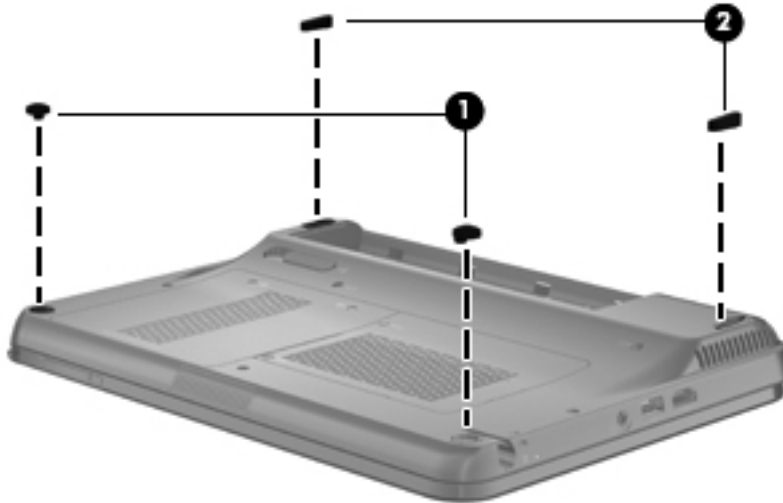

Battery

Description	Spare part number
6-cell, 62-Wh, 2.8-Ah, Li-ion battery	586021-001

Before disassembling the computer, follow these steps:

1. Shut down the computer. If you are unsure whether the computer is off or in Hibernation, turn the computer on, and then shut it down through the operating system.
2. Disconnect all external devices connected to the computer.
3. Disconnect the power cord.

Remove the battery:

1. Turn the computer upside down, with the front toward you.
2. Slide the battery lock latch **(1)**, and then release it. (The battery disengages from the computer.)
3. Remove the battery **(2)** by lifting the front edge, and then swinging it up and back.



To install a battery, slide the battery into the battery bay until you hear a click.

Pen

Description	Spare part number
Pen	593028-001

Before removing the pen, follow these steps:

1. Shut down the computer. If you are unsure whether the computer is off or in Hibernation, turn the computer on, and then shut it down through the operating system.
2. Disconnect all external devices connected to the computer.
3. Disconnect the power cord.
4. Remove the battery (see [Battery on page 35](#)).

Remove the pen:

1. Position the computer with the left side toward you.
2. Press in on the pen **(1)** to release it from the pen holder.
3. Remove the pen **(2)** from the pen holder.



Reverse this procedure to install the pen.

Hard drive

 **NOTE:** The hard drive spare part kit includes a hard drive bracket, hard drive connector, and Mylar cover.

Description	Spare part number
640-GB, 5400-rpm	611495-001
500-GB, 7200-rpm	584381-001
320-GB, 7200-rpm	584380-001
250-GB, 7200-rpm	584379-001
Hard Drive Hardware Kit (includes hard drive bracket and hard drive screws)	584382-001

Before removing the hard drive, follow these steps:

1. Shut down the computer. If you are unsure whether the computer is off or in Hibernation, turn the computer on, and then shut it down through the operating system.
2. Disconnect all external devices connected to the computer.
3. Disconnect the power cord.
4. Remove the battery (see [Battery on page 35](#)).

Remove the hard drive:

1. Position the computer with the front toward you.
2. Loosen the two Phillips PM2.0×5.0 captive screws that secure the hard drive cover to the computer.

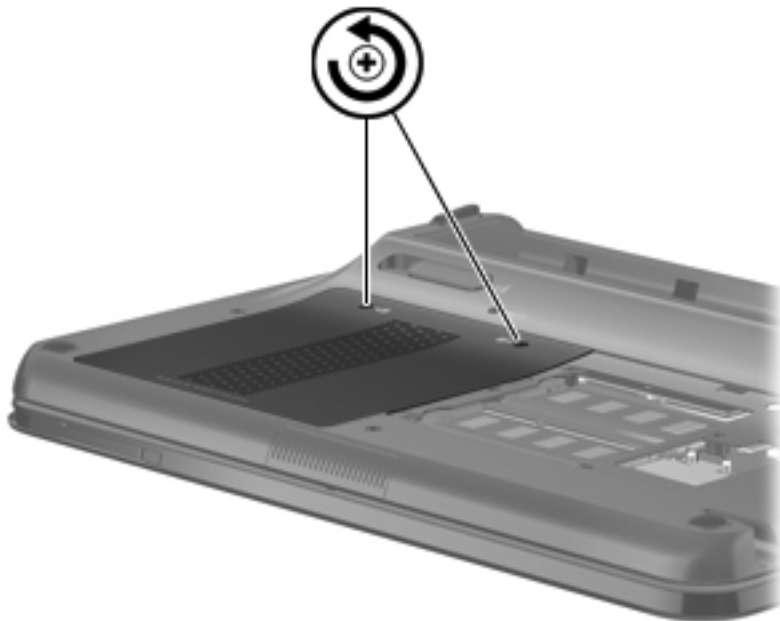

3. Lift the rear edge of the hard drive cover, and then swing it up and forward.



4. Remove the hard drive cover.

 **NOTE:** The hard drive cover is included in the Plastics Kit, spare part number 592971-001.

5. Grasp the Mylar tab on the hard drive and slide the hard drive **(1)** to the left to disconnect it from the system board.
6. Remove the hard drive **(2)** from the hard drive bay.

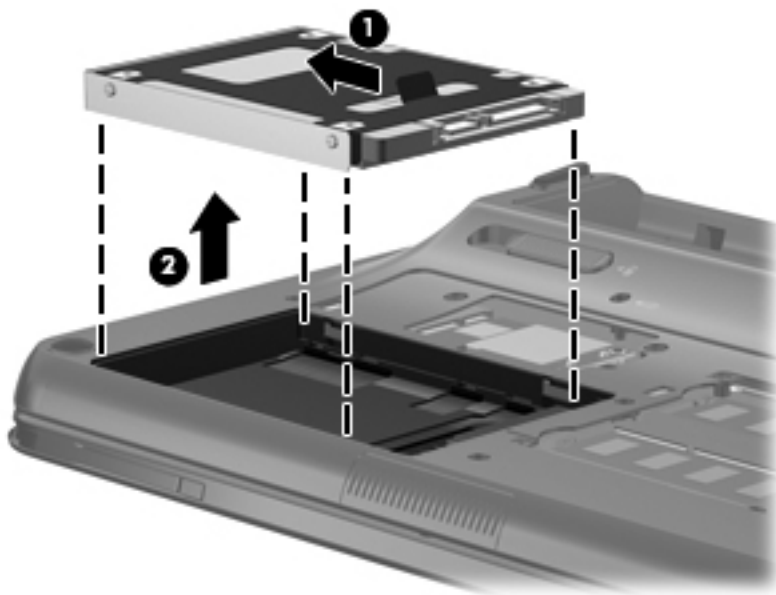

7. If it is necessary to remove the hard drive shield, remove the two Phillips PM3.0×3.0 hard drive shield screws **(1)** from each side of the hard drive.

8. Lift the shield **(2)** straight up to remove it from the hard drive.

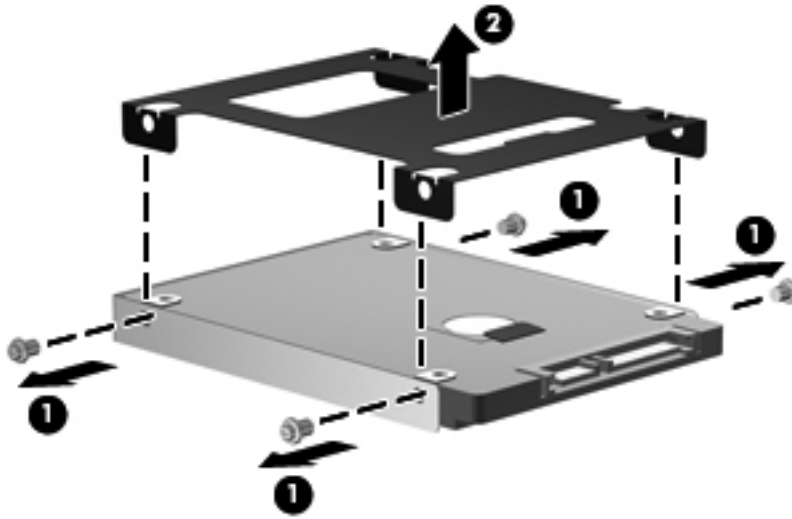

Reverse this procedure to reassemble and install the hard drive.

Memory module

Description	Spare part number
4096-MB (DDR3, PC3, 1066-MHz)	599092-001
2048-MB (DDR3, PC3, 1066-MHz)	598856-001
1024-MB (DDR3, PC3, 1066-MHz)	598859-001

Before removing the memory module, follow these steps:

1. Shut down the computer. If you are unsure whether the computer is off or in Hibernation, turn the computer on, and then shut it down through the operating system.
2. Disconnect all external devices connected to the computer.
3. Disconnect the power cord.
4. Remove the battery (see [Battery on page 35](#)).

Remove the memory module:

1. Position the computer with the front toward you.
2. Loosen the two Phillips PM2.0×5.0 captive screws that secure the memory module compartment cover to the computer.

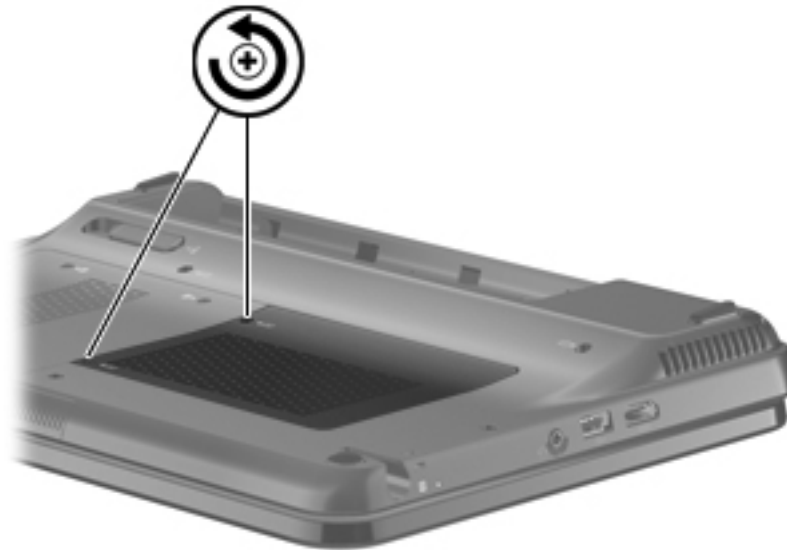

3. Lift the left side of the cover, and then swing it up and to the right.

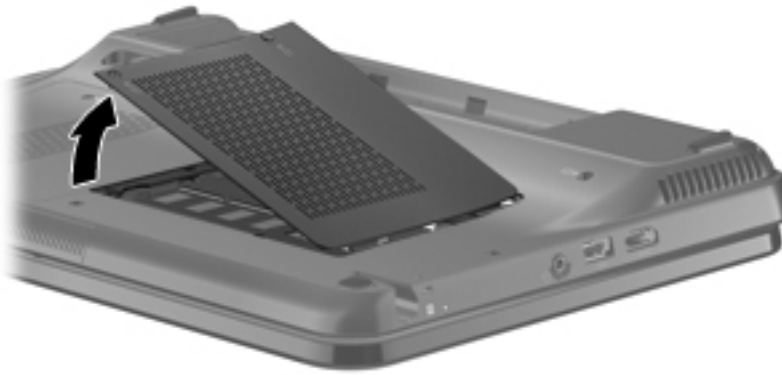

4. Remove the memory module compartment cover.

 **NOTE:** The memory module compartment cover is included in the Plastics Kit, spare part number 592971-001.

5. Pull away the retention clips on each side of the memory module to release the memory module. (The memory module tilts up.)

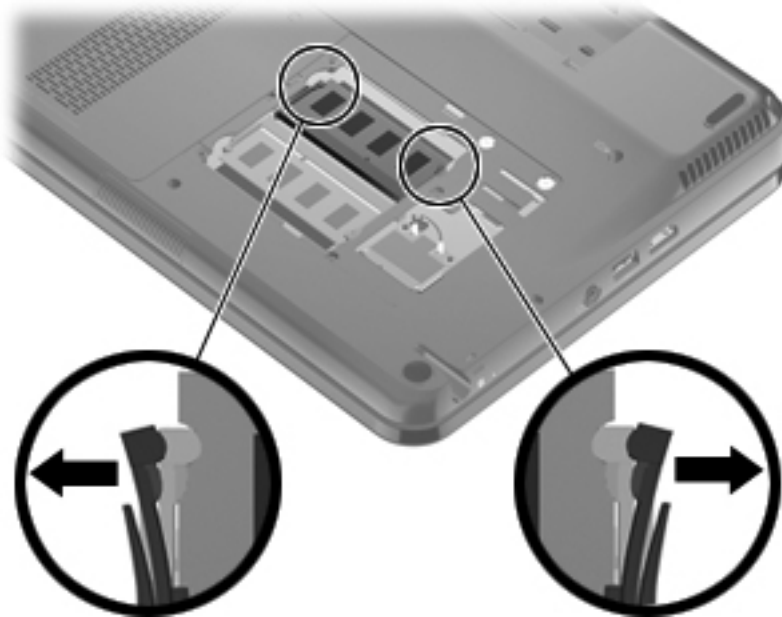

 **CAUTION:** To prevent damage to the memory module, hold it by the edges only. Do not touch the components on the memory module.

6. Grasp the edge of the memory module, and gently pull it out of the memory module slot.



Reverse this procedure to install a memory module.

WLAN module

Description	Spare part number
Atheros 9285G 802.11b/g/n 1x1 WiFi Adapter for use in Canada, the Cayman Islands, Guam, Puerto Rico, the U.S. Virgin Islands, and the United States	580101-001
Atheros 9285G 802.11b/g/n 1x1 WiFi Adapter for use in Afghanistan, Albania, Algeria, Andorra, Angola, Antigua and Barbuda, Argentina, Armenia, Aruba, Australia, Austria, Azerbaijan, the Bahamas, Bahrain, Bangladesh, Barbados, Belgium, Belize, Benin, Bermuda, Bolivia, Bosnia and Herzegovina, Botswana, Brazil, the British Virgin Islands, Brunei, Bulgaria, Burkina Faso, Burundi, Cameroon, Cape Verde, the Cayman Islands, the Central African Republic, Chad, Chile, Colombia, Comoros, the Congo, Costa Rica, Croatia, Cyprus, the Czech Republic, Denmark, Djibouti, Dominica, the Dominican Republic, East Timor, Ecuador, Egypt, El Salvador, Equatorial Guinea, Eritrea, Estonia, Ethiopia, Fiji, Finland, France, French Guiana, Gabon, Gambia, Georgia, Germany, Ghana, Gibraltar, Greece, Guadeloupe, Guam, Guatemala, Guinea, Guinea-Bissau, Guyana, Haiti, Honduras, Hong Kong, Hungary, Iceland, India, Ireland, Italy, the Ivory Coast, Jamaica, Jordan, Kenya, Kiribati, Kyrgyzstan, Laos, Latvia, Lesotho, Liberia, Liechtenstein, Lithuania, Luxembourg, Macedonia, Madagascar, Malawi, the Maldives, Mali, Malta, the Marshall Islands, Martinique, Mauritania, Mauritius, Mexico, Micronesia, Monaco, Mongolia, Montenegro, Morocco, Mozambique, Namibia, Nauru, Nepal, the Netherlands, New Zealand, Nicaragua, Niger, Nigeria, Norway, Oman, Pakistan, Palau, Panama, Papua New Guinea, Paraguay, the People's Republic of China, Peru, the Philippines, Poland, Portugal, Puerto Rico, the Republic of Moldova, Romania, Russia, Rwanda, Samoa, San Marino, Sao Tome and Principe, Saudi Arabia, Senegal, Serbia, the Seychelles, Sierra Leone, Singapore, Slovakia, Slovenia, the Solomon Islands, Somalia, South Africa, Spain, Sri Lanka, St. Kitts and Nevis, St. Lucia, St. Vincent and the Grenadines, Suriname, Swaziland, Sweden, Switzerland, Taiwan, Tajikistan, Tanzania, Togo, Tonga, Trinidad and Tobago, Tunisia, Turkey, Turkmenistan, Tuvalu, Uganda, the United Arab Emirates, the United Kingdom, Uruguay, Uzbekistan, Venezuela, Vietnam, Yemen, Zaire, Zambia, and Zimbabwe	580101-002
Broadcom 4313 802.11b/g/n 1x1 WiFi Adapter	593836-001
Intel Centrino Wireless-N 1000 802.11b/g 1x2 WiFi Adapter	593530-001
Ralink RT3090BC4 802.11b/g/n 1x1 WiFi and Bluetooth 2.1+EDR Combo Adapter	602992-001

Before removing the WLAN module, follow these steps:

1. Shut down the computer. If you are unsure whether the computer is off or in Hibernation, turn the computer on, and then shut it down through the operating system.
2. Disconnect all external devices connected to the computer.
3. Disconnect the power cord.
4. Remove the battery (see [Battery on page 35](#)).
5. Remove the memory module compartment cover (see [Memory module on page 40](#)).

Remove the WLAN module:

△ **CAUTION:** To prevent an unresponsive system, replace the wireless module only with a wireless module authorized for use in the computer by the governmental agency that regulates wireless devices in your country or region. If you replace the module and then receive a warning message, remove the module to restore computer functionality, and then contact technical support through Help and Support.

1. Disconnect the WLAN antenna cables from the WLAN module.

 **NOTE:** The black WLAN antenna cable is connected to the WLAN module “Main” terminal. The white WLAN antenna cable is connected to the WLAN module “Aux” terminal.

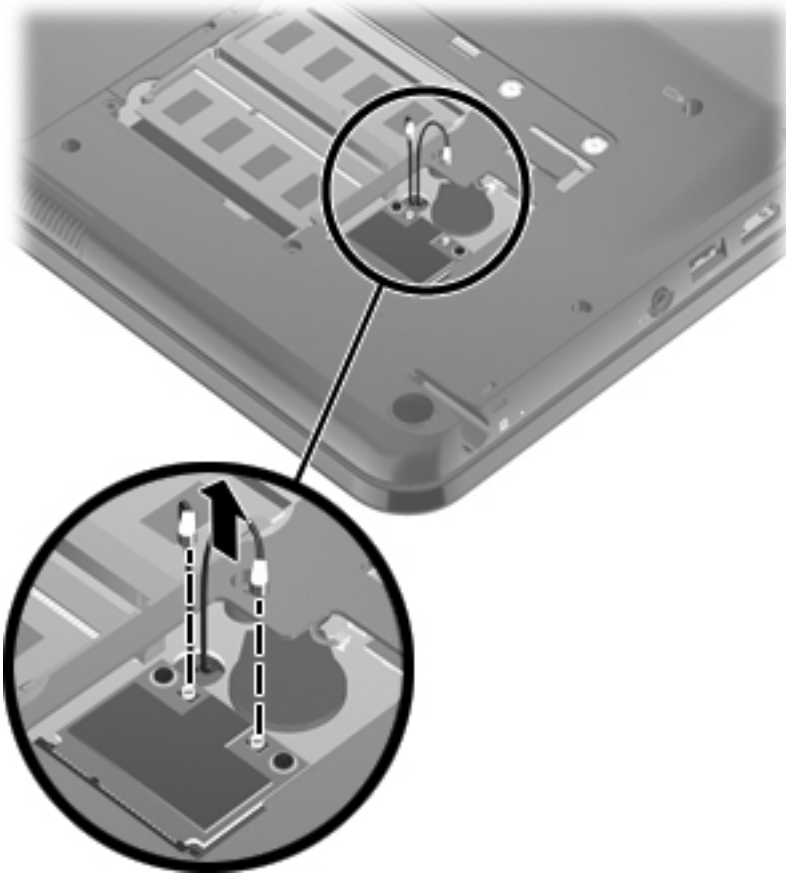

2. Remove the two Phillips PM2.0×4.0 screws that secure the WLAN module to the system board. (The edge of the module opposite the slot rises away from the computer.)

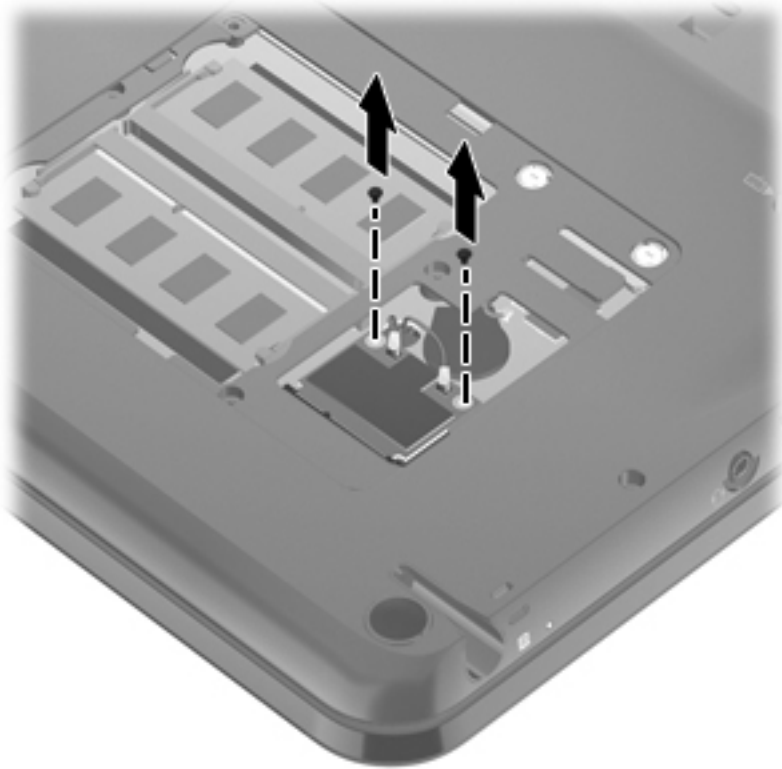

3. Pull the WLAN module away from the slot at an angle and remove it.



Reverse this procedure to install a WLAN module.

RTC battery

Description	Spare part number
RTC battery (includes cable and double-sided tape)	592965-001

Before removing the RTC battery, follow these steps:

1. Shut down the computer. If you are unsure whether the computer is off or in Hibernation, turn the computer on, and then shut it down through the operating system.
2. Disconnect all external devices connected to the computer.
3. Disconnect the power cord.
4. Remove the battery (see [Battery on page 35](#)).
5. Remove the memory cover (see [Memory module on page 40](#)).

Remove the RTC battery:

1. Disconnect the RTC battery cable **(1)** from the system board.
2. Release the RTC battery **(2)** from the system board. (The RTC battery is attached to the system board by double-sided tape.)

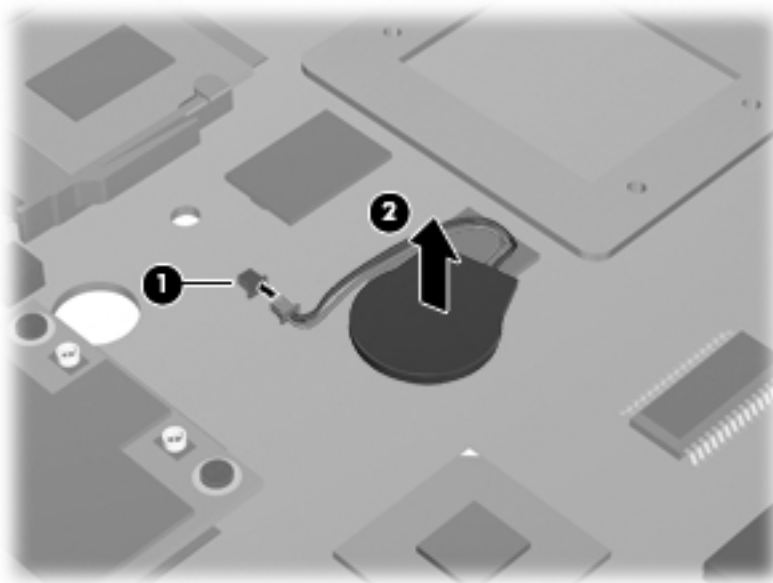

Reverse this procedure to install the RTC battery.

Top cover

Description	Spare part number
Top cover (includes TouchPad and TouchPad cable, caps lock light board and cable, and top cover bumper pads)	592964-001

Before removing the top cover, follow these steps:

1. Shut down the computer. If you are unsure whether the computer is off or in Hibernation, turn the computer on, and then shut it down through the operating system.
2. Disconnect all external devices connected to the computer.
3. Disconnect the power cord.
4. Remove the battery (see [Battery on page 35](#)).
5. Remove the hard drive (see [Hard drive on page 37](#)).
6. Remove the memory cover (see [Memory module on page 40](#)).

Remove the top cover:

1. Remove the two front rubber feet **(1)**. The computer feet are available in the Rubber Kit, spare part number 592966-001.
2. Remove the 17 Phillips PM2.5×6.0 screws **(2)** that secure the top cover to the computer.

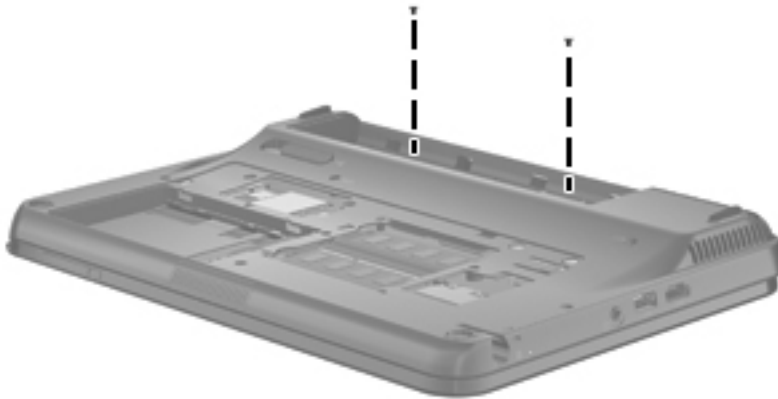

3. Remove the two Phillips PM2.0×4.0 screws in the battery bay that secure the top cover to the computer.

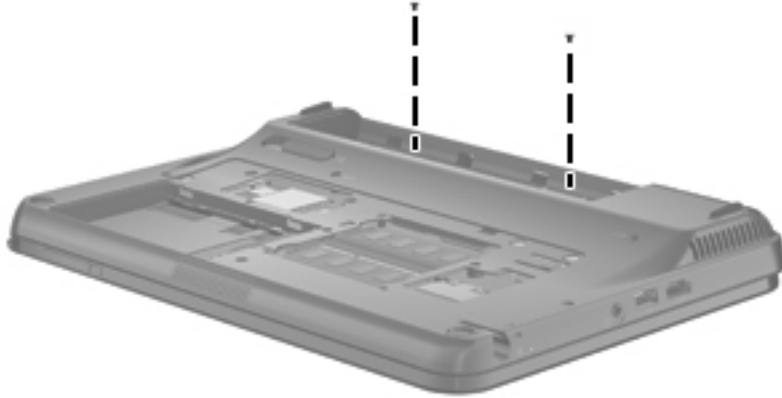

4. Turn the computer right-side up, with the front toward you.
5. Lift the front edge of the top cover **(1)** until it rests at an angle.
6. Release the zero insertion force (ZIF) connector to which the TouchPad cable is connected and disconnect the TouchPad cable **(2)** from the system board.
7. Release the ZIF connector to which the keyboard cable is connected and disconnect the keyboard cable **(3)** from the system board.

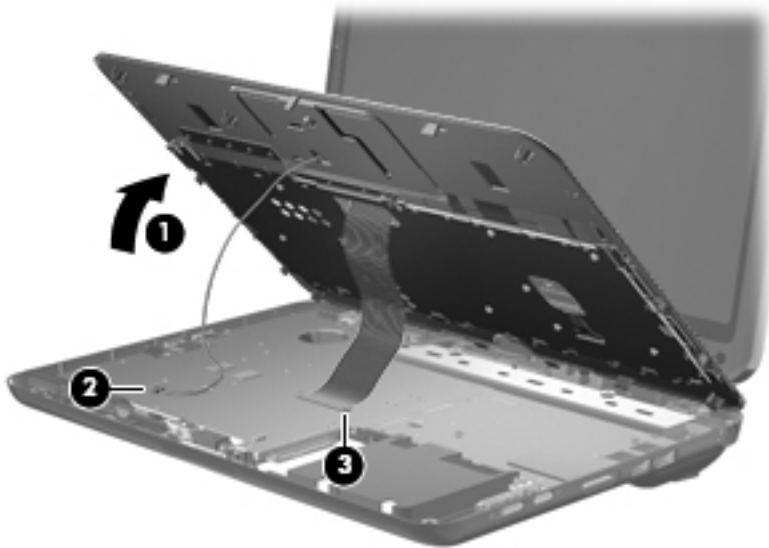

8. Remove the top cover.

Reverse this procedure to install the top cover.

Keyboard

 **NOTE:** The keyboard spare part kit includes a cable and 2 retention clips.

Country or region	Spare part number	Country or region	Spare part number
Belgium	584161-A41	Portugal	584161-131
Brazil	584161-201	Russia	584161-251
Canada	584161-121	Saudi Arabia	584161-171
Denmark, Finland, and Norway	584161-DH1	South Korea	584161-AD1
France	584161-051	Spain	584161-071
Germany	584161-041	Switzerland	584161-111
Greece	584161-DJ1	Taiwan	584161-AB1
Israel	584161-BB1	Thailand	584161-281
Italy	584161-061	Turkey	584161-141
Latin America	584161-161	The United Kingdom	584161-031
The Netherlands	584161-B31	The United States	584161-001

Before removing the keyboard, follow these steps:

1. Shut down the computer. If you are unsure whether the computer is off or in Hibernation, turn the computer on, and then shut it down through the operating system.
2. Disconnect all external devices connected to the computer.
3. Disconnect the power cord.
4. Remove the battery (see [Battery on page 35](#)).
5. Remove the hard drive (see [Hard drive on page 37](#)).
6. Remove the top cover (see [Top cover on page 48](#)).

Remove the keyboard:

1. Turn the top cover upside down, with the front toward you.
2. Release the two tabs **(1)** built into the keyboard shielding.

3. Remove the two retention clips **(2)** by sliding them toward the back of the top cover.

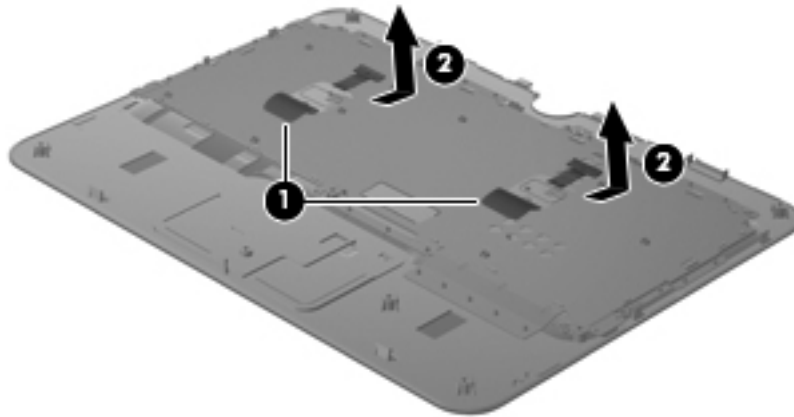

4. Turn the top cover right-side up, with the front toward you.
5. Lift the rear edge of the keyboard **(1)** until it rests at an angle.
6. Slide the keyboard back **(2)** until the four tabs on the bottom edge of the keyboard are clear of the openings in the top cover.
7. Release the keyboard cable **(3)** from the opening in the top cover.

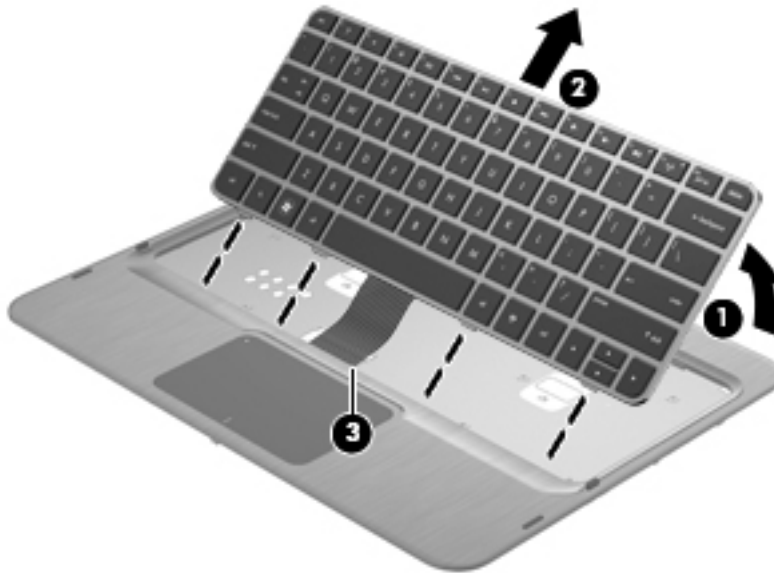

8. Remove the keyboard.

Reverse this procedure to install the keyboard.

Pen holder and eject assembly

Description	Spare part number
Pen holder and eject assembly	592972-001

Before removing the pen holder and eject assembly, follow these steps:

1. Shut down the computer. If you are unsure whether the computer is off or in Hibernation, turn the computer on, and then shut it down through the operating system.
2. Disconnect all external devices connected to the computer.
3. Disconnect the power cord.
4. Remove the battery (see [Battery on page 35](#)).
5. Remove the following components:
 - a. Hard drive (see [Hard drive on page 37](#)).
 - b. Memory cover (see [Memory module on page 40](#)).
 - c. Top cover (see [Top cover on page 48](#)).

Remove the pen holder and eject assembly:

1. Remove the three Phillips PM2.0×4.0 screws **(1)** that secure the pen holder and eject assembly to the base enclosure.
2. Remove the pen holder **(2)** and eject assembly **(3)** from the base enclosure.

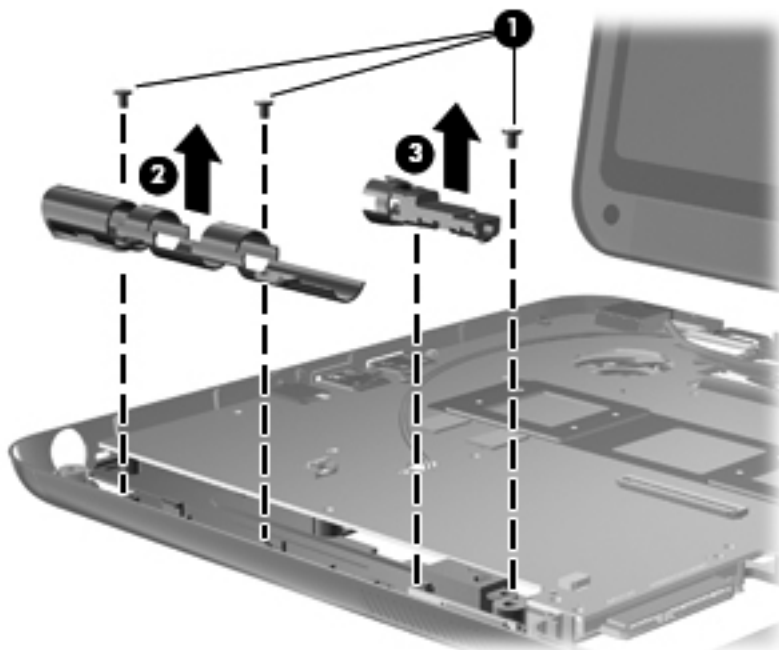

Reverse this procedure to install the pen holder and eject assembly.

Bluetooth module

 **NOTE:** The Bluetooth module spare part kit does not include a Bluetooth module cable. The Bluetooth module cable is available using spare part number 613451-001.

Description	Spare part number
Bluetooth module	537921-001

Before removing the Bluetooth module, follow these steps:

1. Shut down the computer. If you are unsure whether the computer is off or in Hibernation, turn the computer on, and then shut it down through the operating system.
2. Disconnect all external devices connected to the computer.
3. Disconnect the power cord.
4. Remove the battery (see [Battery on page 35](#)).
5. Remove the following components:
 - a. Hard drive (see [Hard drive on page 37](#)).
 - b. Memory cover (see [Memory module on page 40](#)).
 - c. Top cover (see [Top cover on page 48](#)).

Remove the Bluetooth module:

1. Disconnect the Bluetooth module cable (1) from the system board.
2. Release the Bluetooth module (2) from the slot built into the base enclosure.

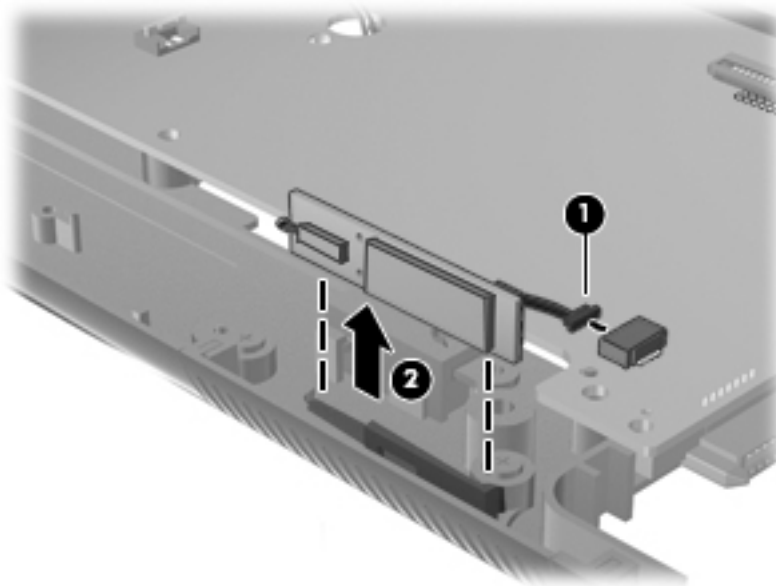

Reverse this procedure to install the Bluetooth module.

Power switch board

Description	Spare part number
Power switch board (includes cable)	611498-001

Before removing the power switch board, follow these steps:

1. Shut down the computer. If you are unsure whether the computer is off or in Hibernation, turn the computer on, and then shut it down through the operating system.
2. Disconnect all external devices connected to the computer.
3. Disconnect the power cord.
4. Remove the battery (see [Battery on page 35](#)).
5. Remove the following components:
 - a. Hard drive (see [Hard drive on page 37](#)).
 - b. Memory cover (see [Memory module on page 40](#)).
 - c. Top cover (see [Top cover on page 48](#)).

Remove the power switch board:

1. Release the ZIF connector to which the power switch board cable is connected, and then disconnect the power switch board cable (**1**) from the system board.
2. Remove the power switch board (**2**) from the slot built into the base enclosure.

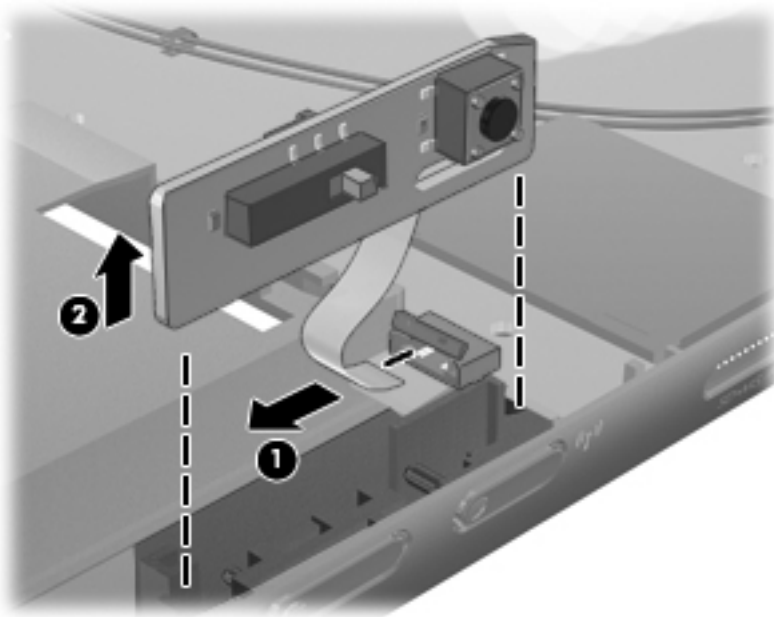

Reverse this procedure to install the power switch board.

Display assembly

Description	Spare part number
12.1-inch, WXGA, BrightView, LED touch-screen display assembly (includes Web camera and cable, microphones and cables, fingerprint reader and cable, WLAN antenna cables, and WWAN antenna cables)	611492-001

Before removing the display assembly, follow these steps:

1. Shut down the computer. If you are unsure whether the computer is off or in Hibernation, turn the computer on, and then shut it down through the operating system.
2. Disconnect all external devices connected to the computer.
3. Disconnect the power cord.
4. Remove the battery (see [Battery on page 35](#)).
5. Disconnect the WLAN antenna cables from the WLAN module (see [WLAN module on page 43](#)).
6. Remove the hard drive (see [Hard drive on page 37](#)).
7. Remove the top cover (see [Top cover on page 48](#)).

Remove the display assembly:

1. Close the computer and turn it upside down, with the rear panel toward you.
2. Remove the two Phillips PM2.0×4.0 screws that secure the display hinge cover to the computer.

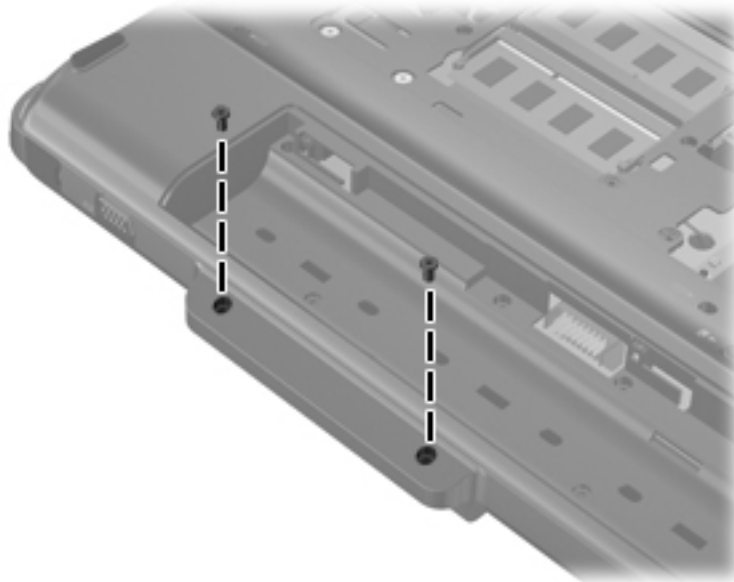

3. Turn the computer display-side up, with the rear panel toward you.
4. Open the computer display to the upright position and rotate the display **(1)** 90-degrees clockwise.

5. Remove the display hinge cover **(2)**.

 **NOTE:** The display hinge cover is included in the Plastics Kit, spare part number 592971-001.



6. Position the computer with the front toward you.
7. Release the tape **(1)** that secures the WLAN antenna cables to the system board.
8. Release the grounding tape **(2)** that grounds the WLAN antenna cables to the base enclosure.
9. Release the WLAN antenna cables **(3)** from the opening in the system board.

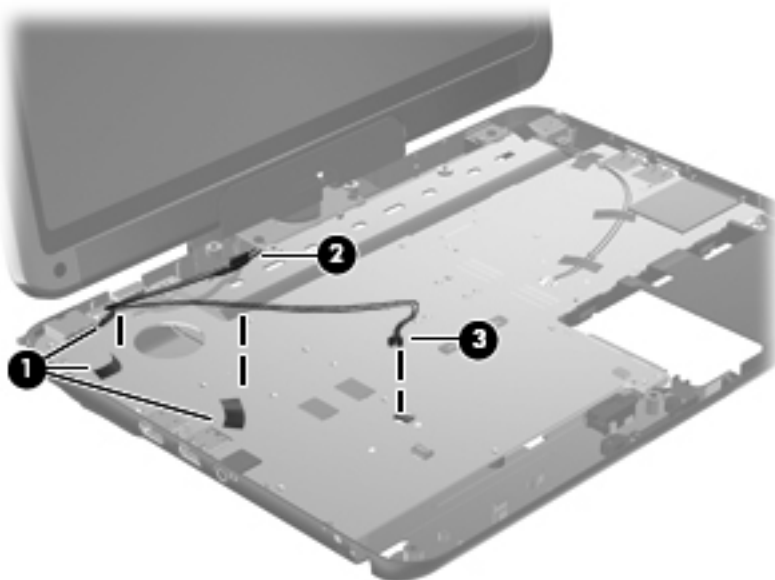

10. Release the grounding tape **(1)** that grounds the webcam cable to the base enclosure.

11. Disconnect the webcam cable **(2)** from the system board.

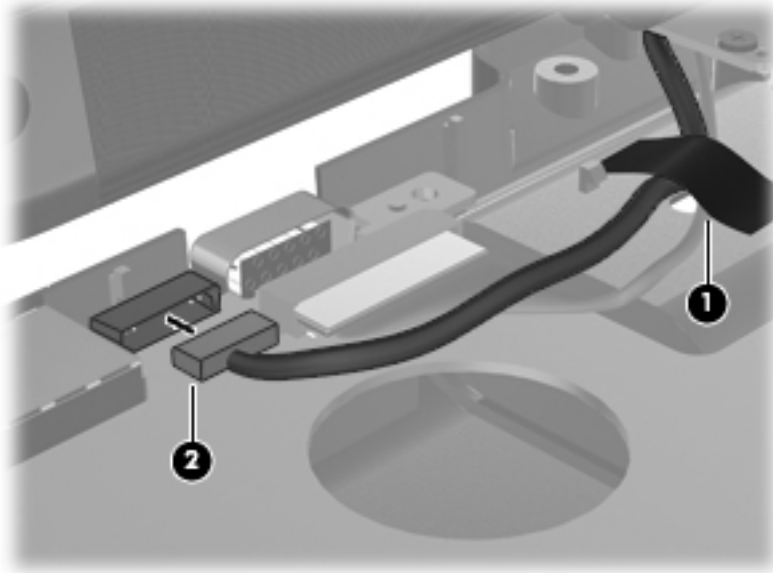

12. Release the grounding tape **(1)** that grounds the display panel cable to the base enclosure.
13. Disconnect the display panel cable **(2)** from the system board.

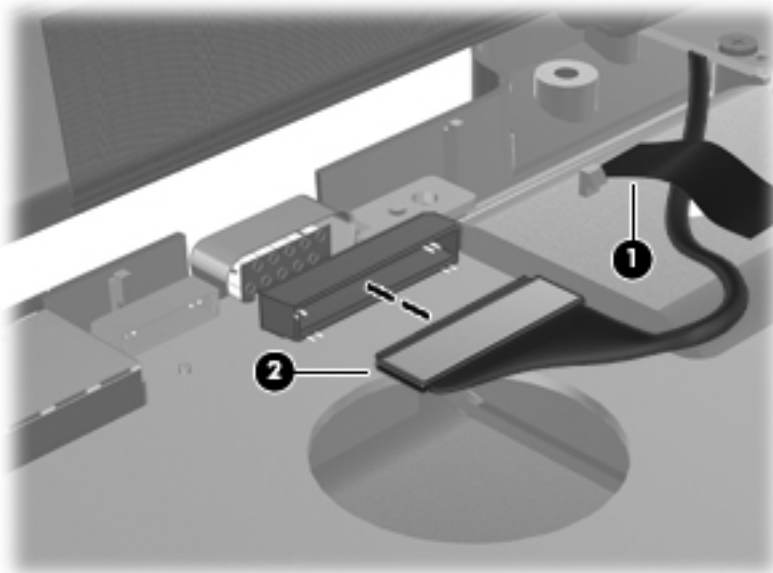

14. Release the tape **(1)** that secures the wireless module antenna cables to the system board.
15. Release the grounding tape **(2)** that grounds the wireless module antenna cables to the base enclosure.

- 16.** Release the wireless module antenna cables **(3)** from the opening in the system board.

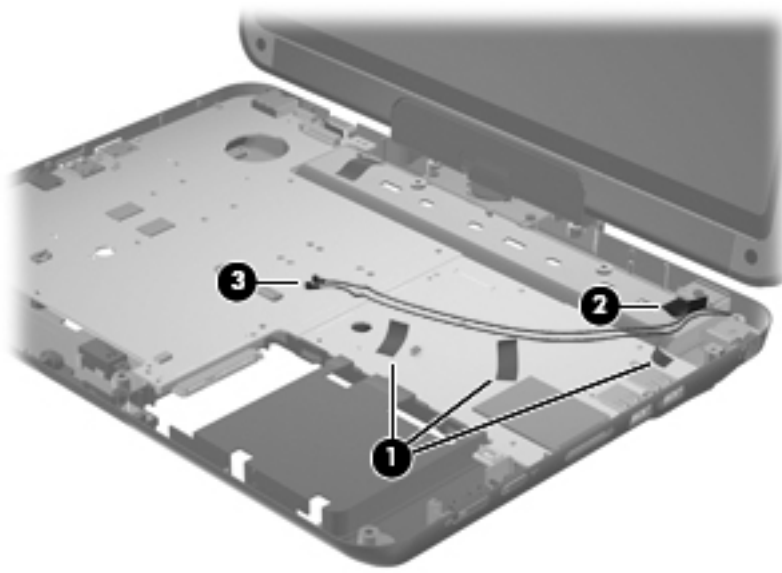

△ **CAUTION:** Support the display assembly when removing the following screws. Failure to support the display assembly can result in damage to the display assembly and other computer components.

- 17.** Remove the four Phillips PM2.5×6.0 screws **(1)** that secure the display assembly to the computer.

- 18.** Lift the display assembly **(2)** straight up and remove it.

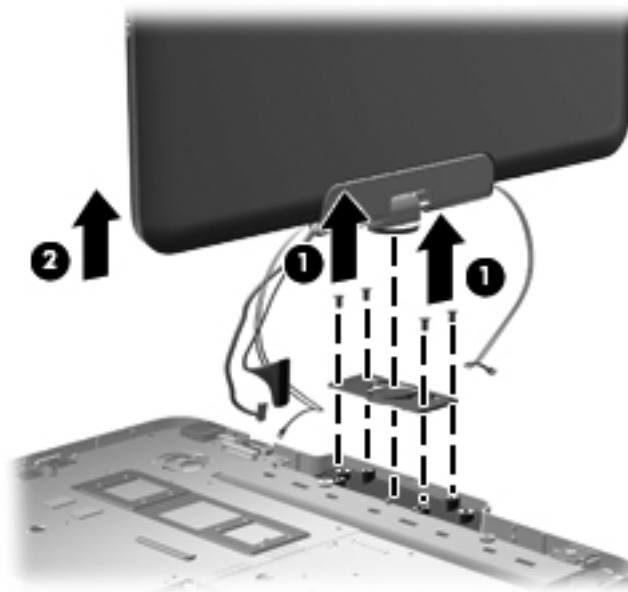

Reverse this procedure to install the display assembly.

System board

 **NOTE:** The system board spare part kit includes replacement thermal material.

Description	Spare part number
Equipped with discrete graphics subsystem and Intel Core i5-430UM 1.20-GHz turbo processor (800-MHz FSB, 3-MB L2 cache, 18-W)	611491-001
Equipped with discrete graphics subsystem and Intel Core i3-330UM 1.20-GHz processor (800-MHz FSB, 3-MB L2 cache, 18-W)	611489-001
Equipped with discrete graphics subsystem and Intel Pentium U5400 1.20-GHz processor (800-MHz FSB, 2-MB L2 cache, 18-W)	611487-001
Equipped with UMA graphics subsystem and Intel Core i5-430UM 1.20-GHz turbo processor (800-MHz FSB, 3-MB L2 cache, 18-W)	611490-001
Equipped with UMA graphics subsystem and Intel Core i3-330UM 1.20-GHz processor (800-MHz FSB, 3-MB L2 cache, 18-W)	611488-001
Equipped with UMA graphics subsystem and Intel Pentium U5400 1.20-GHz processor (800-MHz FSB, 2-MB L2 cache, 18-W)	611486-001

Before removing the system board, follow these steps:

1. Shut down the computer. If you are unsure whether the computer is off or in Hibernation, turn the computer on, and then shut it down through the operating system.
2. Disconnect all external devices connected to the computer.
3. Disconnect the power cord.
4. Remove the battery (see [Battery on page 35](#)).
5. Remove the hard drive (see [Hard drive on page 37](#)).
6. Disconnect the WLAN antenna cables from the WLAN module (see [WLAN module on page 43](#)).
7. Remove the following components:
 - a. Hard drive (see [Hard drive on page 37](#)).
 - b. Top cover (see [Top cover on page 48](#))
 - c. Display assembly (see [Display assembly on page 55](#))

When replacing the system board, be sure that the following components are removed from the defective system board and installed on the replacement system board:

- Memory module (see [Memory module on page 40](#))
- WLAN module (see [WLAN module on page 43](#))
- RTC battery (see [RTC battery on page 47](#))
- Power connector and cable (see [Power connector and cable on page 62](#))

- Fan (see [Fan on page 63](#))
- Heat sink (see [Heat sink on page 64](#))

Remove the system board:

1. Disconnect the Bluetooth module cable **(1)** from the system board.
2. Release the ZIF connector to which the power switch board cable is connected, and disconnect the power switch board cable **(2)** from the system board.

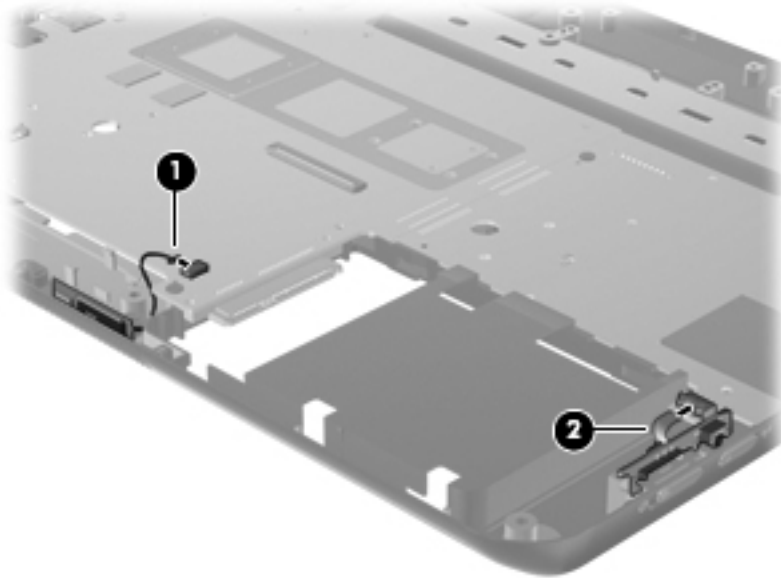

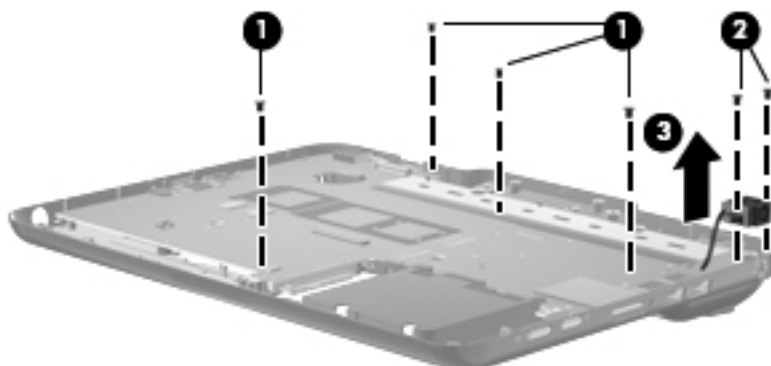

3. Remove the four Phillips PM2.5×4.0 screws **(1)** that secure the system board to the base enclosure.
4. Remove the two Phillips PM2.5×4.0 screws **(2)** that secure the power connector to the base enclosure.
5. Release the power connector **(3)** from the base enclosure.

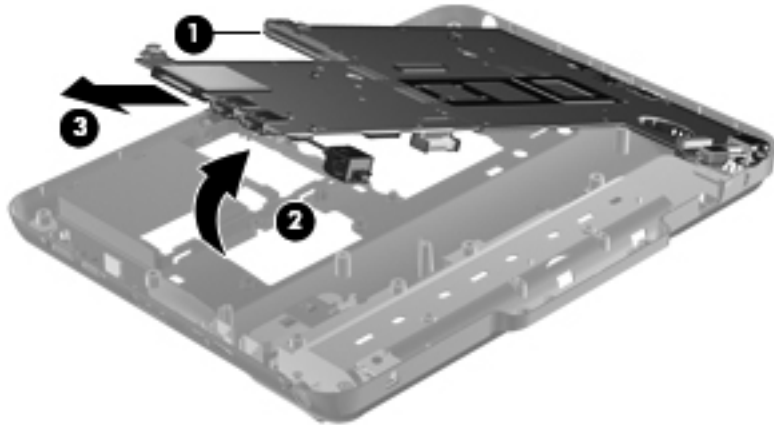

6. Use the hard drive connector **(1)** to lift the right side of the system board **(2)** until it rests at an angle.

7. Remove the system board **(3)** by sliding it up and to the right.



 **NOTE:** After removing the system board, it may be necessary to replace the RJ-45 connector cover. The RJ-45 connector cover is included in the Plastics Kit, spare part number 592971-001.



Reverse this procedure to install the system board.

Power connector and cable

Description	Spare part number
Power connector and cable	592967-001

Before removing the power connector and cable, follow these steps:

1. Shut down the computer. If you are unsure whether the computer is off or in Hibernation, turn the computer on, and then shut it down through the operating system.
2. Disconnect all external devices connected to the computer.
3. Disconnect the power cord.
4. Remove the battery (see [Battery on page 35](#)).
5. Remove the following components:
 - a. Hard drive (see [Hard drive on page 37](#))
 - b. Top cover (see [Top cover on page 48](#))
 - c. Keyboard (see [Keyboard on page 50](#))
 - d. Display assembly (see [Display assembly on page 55](#))
 - e. System board (see [System board on page 59](#))

Remove the power connector and cable:

1. Turn the system board upside down, with the rear toward you.
2. Disconnect the power connector and cable from the system board.

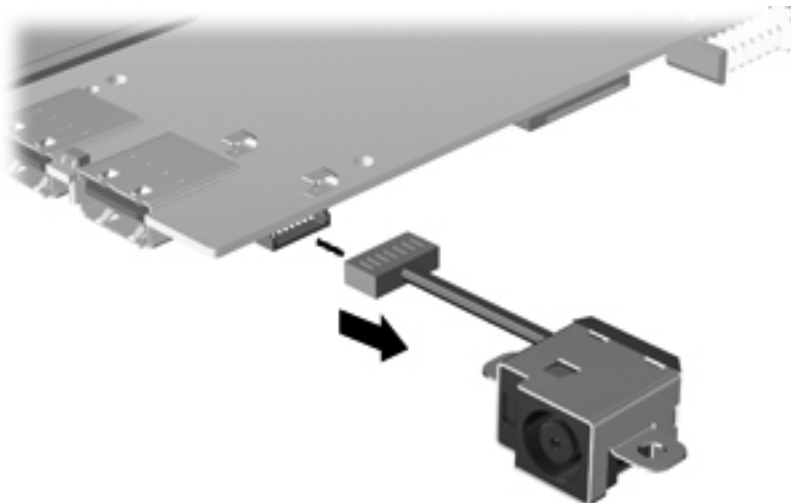

Reverse this procedure to install the power connector and cable.

Fan

Description	Spare part number
Fan	592970-001

 **NOTE:** To properly ventilate the computer, allow at least a 7.6-cm (3-inch) clearance on the right side and rear panel of the computer.

The computer uses an electric fan for ventilation. The fan is controlled by a temperature sensor and is designed to turn on automatically when high temperature conditions exist. These conditions are affected by high external temperatures, system power consumption, power management/battery conservation configurations, battery fast charging, and software requirements. Exhaust air is displaced through the ventilation grill located on the left side of the computer.

Before removing the fan, follow these steps:

1. Shut down the computer. If you are unsure whether the computer is off or in Hibernation, turn the computer on, and then shut it down through the operating system.
2. Disconnect all external devices connected to the computer.
3. Disconnect the power cord.
4. Remove the battery (see [Battery on page 35](#)).
5. Remove the following components:
 - a. Hard drive (see [Hard drive on page 37](#))
 - b. Top cover (see [Top cover on page 48](#))
 - c. Keyboard (see [Keyboard on page 50](#))
 - d. Display assembly (see [Display assembly on page 55](#))
 - e. System board (see [System board on page 59](#))

Remove the fan:

1. Turn the system board upside down, with the rear toward you.
2. Disconnect the fan cable **(1)** from the system board.
3. Remove the two Phillips PM2.5×6.0 screws **(2)** that secure the fan to the system board.

4. Remove the fan (3).

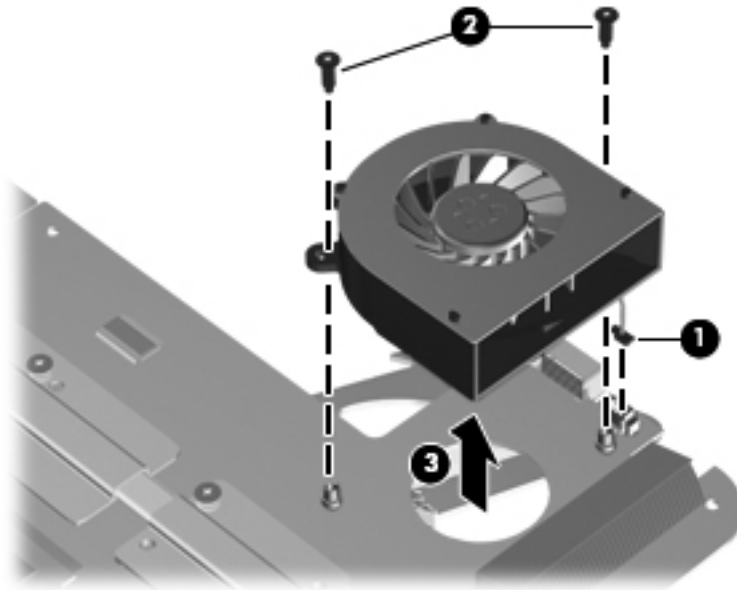

Reverse this procedure to install the fan.

Heat sink

 **NOTE:** The heat sink spare part kit includes replacement thermal material.

Description	Spare part number
For use only on computer models equipped with discrete graphics subsystem	611499-001
For use only on computer models equipped with UMA graphics subsystem	611500-001

Before removing the heat sink, follow these steps:

1. Shut down the computer. If you are unsure whether the computer is off or in Hibernation, turn the computer on, and then shut it down through the operating system.
2. Disconnect all external devices connected to the computer.
3. Disconnect the power cord.
4. Remove the battery (see [Battery on page 35](#)).
5. Remove the following components:
 - a. Hard drive (see [Hard drive on page 37](#))
 - b. Top cover (see [Top cover on page 48](#))
 - c. Keyboard (see [Keyboard on page 50](#))

- d. Display assembly (see [Display assembly on page 55](#))
- e. System board (see [System board on page 59](#))

Remove the heat sink:

1. Turn the system board upside down, with the rear toward you.

 **NOTE:** Steps 2 and 3 apply only to computer models equipped with a discrete graphics subsystem. See steps 4 and 5 for heat sink removal instructions for computer models equipped with a UMA graphics subsystem.

2. Following the 1, 2, 3, 4, 5, 6 sequence stamped into each section of the heat sink, loosen the six Phillips PM2.5×10.0 captive screws **(1)** that secure the heat sink to the system board.
3. Remove the heat sink **(2)**.

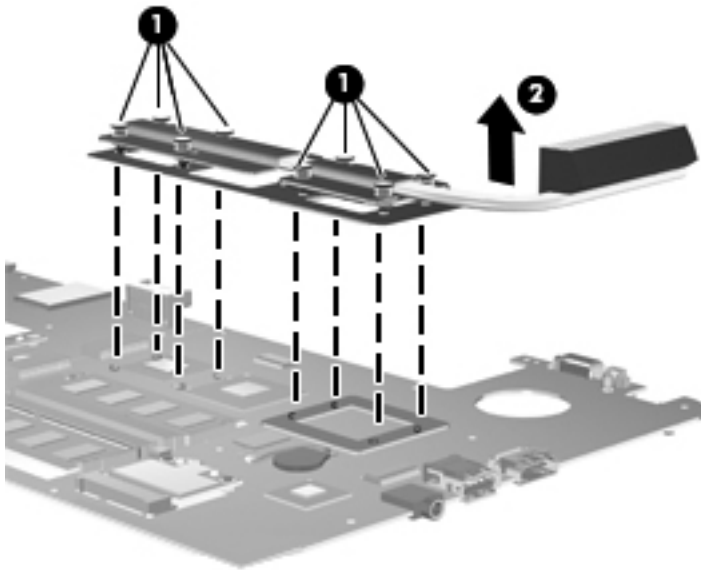

 **NOTE:** Steps 4 and 5 apply only to computer models equipped with a UMA graphics subsystem. See steps 2 and 3 for heat sink removal instructions for computer models equipped with a discrete graphics subsystem.

4. Following the 1, 2, 3, 4 sequence stamped into each section of the heat sink, loosen the four Phillips PM2.5×10.0 captive screws **(1)** that secure the heat sink to the system board.

5. Remove the heat sink (2).

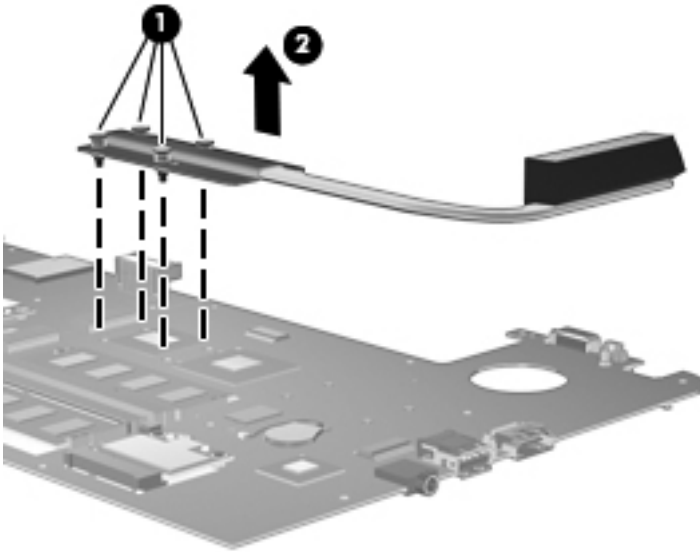

 **NOTE:** Due to the adhesive quality of the thermal material located between the heat sink and system board components, it may be necessary to move the heat sink from side to side to detach the assembly.

NOTE: The thermal material must be thoroughly cleaned from the surfaces of the heat sink and the system board each time the heat sink is removed. Thermal pads are used on the video processor (1) and the heat sink section (2) that services it, and the PCH chip (3) and the heat sink section (4) that services it. Thermal paste is used on the processor (5) and the heat sink section (6) that services it. Replacement thermal material is included with all system board and heat sink spare part kits.

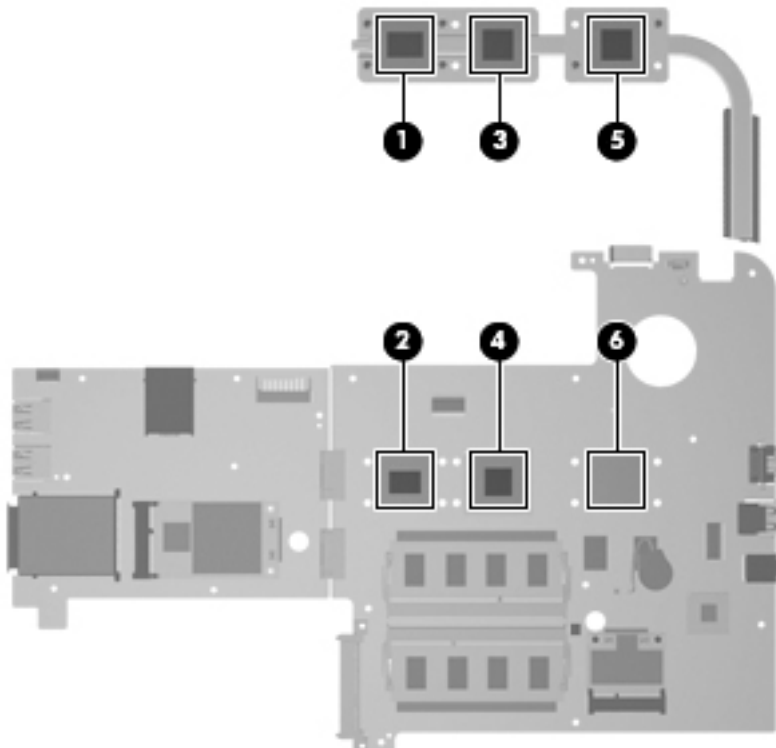

 **NOTE:** Due to the adhesive quality of the thermal material located between the heat sink and system board components, it may be necessary to move the heat sink from side to side to detach the assembly.

NOTE: The thermal material must be thoroughly cleaned from the surfaces of the heat sink and the system board each time the heat sink is removed. Thermal pads are used on the PCH chip **(1)** and the heat sink section **(2)** that services it. Thermal paste is used on the processor **(3)** and the heat sink section **(4)** that services it. Replacement thermal material is included with all system board and heat sink spare part kits.

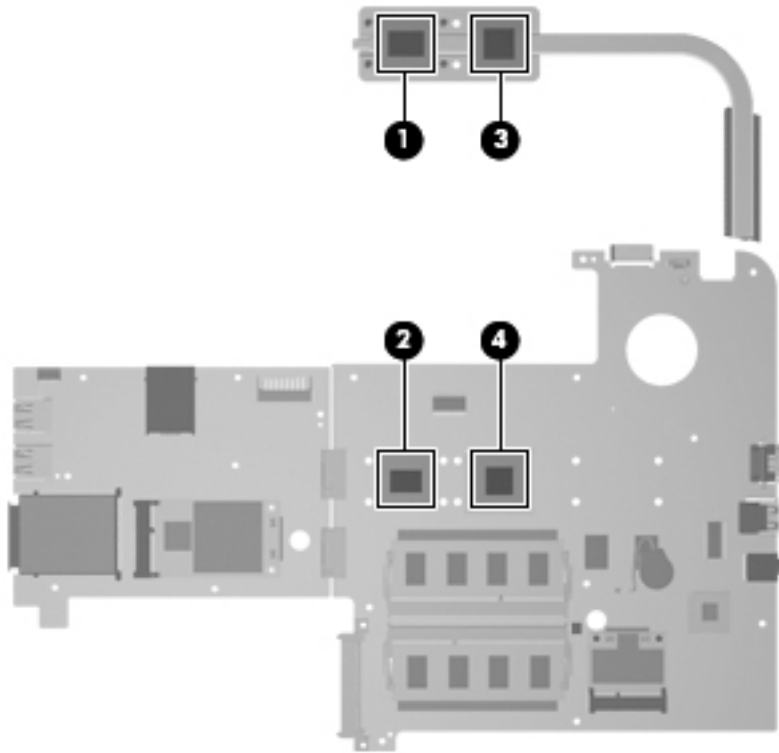

Reverse this procedure to install the heat sink.

5 Setup Utility (BIOS)

Starting Setup Utility

Setup Utility is a ROM-based information and customization utility that can be used even when your Windows operating system is not working.

The utility reports information about the computer and provides settings for startup, security, and other preferences.

To start Setup Utility:

- ▲ Open Setup Utility by turning on or restarting the computer. While the “Press the ESC key for Startup Menu” message is displayed in the lower-left corner of the screen, press **f10**.

– or –

1. Open Setup Utility by turning on or restarting the computer. While the “Press the ESC key for Startup Menu” message is displayed in the lower-left corner of the screen, press **esc**.
2. When the Startup Menu is displayed, press **f10**.

Using Setup Utility

Changing the language of Setup Utility

The following procedure explains how to change the language of Setup Utility. If Setup Utility is not already running, begin at step 1. If Setup Utility is already running, begin at step 2.

1. Open Setup Utility by turning on or restarting the computer. While the “Press the ESC key for Startup Menu” message is displayed in the lower-left corner of the screen, press **f10**.

– or –

Open Setup Utility by turning on or restarting the computer. While the “Press the ESC key for Startup Menu” message is displayed in the lower-left corner of the screen, press **esc**. When the Startup Menu is displayed, press **f10**.

2. Use the arrow keys to select System Configuration > Language, and then press **enter**.
3. Use the arrow keys to select a language, and then press **enter**.
4. When a confirmation prompt with your language selected is displayed, press **enter**.
5. To save your change and exit Setup Utility, use the arrow keys to select **Exit > Exit Saving Changes**, and then press **enter**.

Your change goes into effect immediately.

Navigating and selecting in Setup Utility

Because Setup Utility is not Windows based, it does not support the TouchPad. Navigation and selection are by keystroke.

- To choose a menu or a menu item, use the arrow keys.
- To choose an item in a list or to toggle a field, for example an Enable/Disable field, use either the arrow keys or **f5** or **f6**.
- To select an item, press **enter**.
- To close a text box or return to the menu display, press **esc**.
- To display additional navigation and selection information while Setup Utility is open, press **f1**.

Display system information

The following procedure explains how to display system information in Setup Utility. If Setup Utility is not open, begin at step 1. If Setup Utility is open, begin at step 2.

1. Open Setup Utility by turning on or restarting the computer. While the “Press the ESC key for Startup Menu” message is displayed in the lower-left corner of the screen, press **f10**.

– or –

Open Setup Utility by turning on or restarting the computer. While the “Press the ESC key for Startup Menu” message is displayed in the lower-left corner of the screen, press **esc**. When the Startup Menu is displayed, press **f10**.

2. Select the **Main** menu. System information such as the system time and date, and identification information about the computer is displayed.
3. To exit Setup Utility without changing any settings, use the arrow keys to select **Exit > Exit Discarding Changes**, and then press **enter**.

Restoring default settings in Setup Utility

The following procedure explains how to restore the Setup Utility default settings. If Setup Utility is not already running, begin at step 1. If Setup Utility is already running, begin at step 2.

1. Open Setup Utility by turning on or restarting the computer. While the “Press the ESC key for Startup Menu” message is displayed in the lower-left corner of the screen, press **f10**.

– or –

Open Setup Utility by turning on or restarting the computer. While the “Press the ESC key for Startup Menu” message is displayed in the lower-left corner of the screen, press **esc**. When the Startup Menu is displayed, press **f10**.

2. Use the arrow keys to select **Exit > Load Setup Defaults**, and then press **enter**.
3. When the Setup Confirmation is displayed, press **enter**.
4. To save your change and exit Setup Utility, use the arrow keys to select **Exit > Exit Saving Changes**, and then press **enter**.

The Setup Utility default settings go into effect when the computer restarts.

 **NOTE:** Your password, security, and language settings are not changed when you restore the factory default settings.

Exiting Setup Utility

You can exit Setup Utility with or without saving changes.

- To exit Setup Utility and save your changes from the current session:

If the Setup Utility menus are not visible, press **esc** to return to the menu display. Then use the arrow keys to select **Exit > Exit Saving Changes**, and then press **enter**.

- To exit Setup Utility without saving your changes from the current session:

If the Setup Utility menus are not visible, press **esc** to return to the menu display. Then use the arrow keys to select **Exit > Exit Discarding Changes**, and then press **enter**.

After either choice, the computer restarts in Windows.

Setup Utility menus

The menu tables in this section provide an overview of Setup Utility options.

 **NOTE:** Some of the Setup Utility menu items listed in this section may not be supported by your computer.

Main menu

Select	To do this
System information	<ul style="list-style-type: none">• View and change the system time and date.• View identification information about the computer.• View specification information, such as processor information, memory size, and system BIOS.

Security menu

Select	To do this
Administrator password	Enter, change, or delete an administrator password.
Power-On Password	Enter, change, or delete a power-on password.

System Configuration menu

Select	To do this
Language	Change the Setup Utility language.
Virtualization Technology (select models only)	Enable/disable the processor Virtualization Technology.
LAN Power Saving	Enable/disable the LAN power saving. Reduces the power consumption of the LAN controller.
Fan Always On	Enabled/disable Fan Always On. When enabled, the computer fan will always be on.
Action Keys Mode	Enable/disable the Action Keys.
Boot Options	Set the following boot options: <ul style="list-style-type: none">• POST Hot Key Delay (sec.)—Set the delay for the user to press hotkeys in intervals of 5 seconds each (0, 5, 10, 15, 20).• Floppy Boot—Enable/disable boot from diskette.• Internal Network Adapter Boot—Enable/disable boot from external Network Adapter.• Boot Order—Set the boot order for:<ul style="list-style-type: none">◦ Notebook Hard Drive◦ USB Diskette on Key/USB Hard Disk◦ USB CD/DVD ROM Drive◦ USB Floppy◦ Network Adapter

Diagnostics menu

Select	To do this
Primary Hard Disk Self Test	Run a comprehensive self-test on the hard drive.
Memory Test	Run a diagnostic test on the system memory.

Updating the BIOS

Updated versions of the BIOS may be available on the HP Web site.

Most BIOS updates on the HP Web site are packaged in compressed files called SoftPaqs.

Some download packages contain a file named Readme.txt, which contains information regarding installing and troubleshooting the file.

Determining the BIOS

To determine whether available BIOS updates contain later BIOS versions than those currently installed on the computer, you need to know the version of the system BIOS currently installed.

BIOS version information (also known as *ROM date* and *System BIOS*) can be displayed by pressing **fn +esc** (if you are already in Windows) or by opening Setup Utility.

To use Setup Utility for displaying BIOS information:

1. Open Setup Utility by turning on or restarting the computer. While the “Press the ESC key for Startup Menu” message is displayed in the lower-left corner of the screen, press **f10**.
2. If Setup Utility does not open with the system information displayed, use the arrow keys to select the **Main** menu.

When the Main menu is selected, BIOS and other system information is displayed.

3. To exit Setup Utility, use the arrow keys to select **Exit > Exit Discarding Changes**, and then press **enter**.

Downloading a BIOS update

- △ **CAUTION:** To prevent damage to the computer or an unsuccessful installation, download and install a BIOS update only when the computer is connected to reliable external power using the AC adapter. Do not download or install a BIOS update while the computer is running on battery power, docked in an optional docking device, or connected to an optional power source. During the download and installation, follow these instructions:

Do not disconnect power from the computer by unplugging the power cord from the AC outlet.

Do not shut down the computer or initiate Sleep or Hibernation.

Do not insert, remove, connect, or disconnect any device, cable, or cord.

To download a BIOS update:

1. Access the page on the HP Web site that provides software for your computer:
Select **Start > Help and Support > Maintain**.
2. Follow the instructions on the screen to identify your computer and access the BIOS update you want to download.
3. At the download area, follow these steps:
 - a. Identify the BIOS update that is later than the BIOS version currently installed on your computer. Make a note of the date, name, or other identifier. You may need this information to locate the update later, after it has been downloaded to your hard drive.
 - b. Follow the instructions on the screen to download your selection to the hard drive.

Make a note of the path to the location on your hard drive where the BIOS update will be downloaded. You will need to access this path when you are ready to install the update.

 **NOTE:** If you connect your computer to a network, consult the network administrator before installing any software updates, especially system BIOS updates.

BIOS installation procedures vary. Follow any instructions that are displayed on the screen after the download is complete. If no instructions are displayed, follow these steps:

1. Open Windows Explorer by selecting **Start > Computer**.
2. Double-click your hard drive designation. The hard drive designation is typically Local Disk (C:).
3. Using the hard drive path you recorded earlier, open the folder on your hard drive that contains the update.
4. Double-click the file that has an .exe extension (for example, *filename.exe*).

The BIOS installation begins.
5. Complete the installation by following the instructions on the screen.

 **NOTE:** After a message on the screen reports a successful installation, you can delete the downloaded file from your hard drive.

6 Specifications

Computer specifications

	Metric	U.S.
Dimensions		
Width	30.40 cm	11.97 in
Depth	22.30 cm	8.76 in
Height (front to back)	2.63 to 3.96 mm	1.04 to 1.56 in
Weight	2.15 kg	4.72 lbs
Input power		
Operating voltage	18.5 V dc @ 3.5 A - 65W	
Operating current	3.5 A	
Temperature		
Operating (writing to optical disc)	5°C to 35°C	41°F to 95°F
Nonoperating	-20°C to 60°C	-4°F to 140°F
Relative humidity		
Operating	10% to 90	
Nonoperating	5% to 95%	
Maximum altitude (unpressurized)		
Operating	-15 m to 3,048 m	-50 ft to 10,000 ft
Nonoperating	-15 m to 12,192 m	-50 ft to 40,000 ft
NOTE: Applicable product safety standards specify thermal limits for plastic surfaces. The computer operates well within this range of temperatures.		

12.1-inch display specifications

	Metric	U.S.
Dimensions		
Height	16.9 cm	6.7 in
Width	26.2 cm	10.3 in
Diagonal	30.8 cm	12.1 in
Number of colors	Up to 16.8 million	
Contrast ratio	250:1 (typical)	
Brightness	200 nits (typical)	
Pixel resolution		
Pitch	0.279 × 0.279 mm	
Format	1366 × 768	
Configuration	RGB vertical stripe	
Backlight	LED	
Character display	80 × 25	
Total power consumption	4.0 W	
Viewing angle	±40° horizontal, +120°/-40° vertical (typical)	

Hard drive specifications

	640-GB*	500-GB*	320-GB*	250-GB*
Dimensions				
Height	9.5 mm	9.5 mm	9.5 mm	9.5 mm
Width	70 mm	70 mm	70 mm	70 mm
Weight	101 g	101 g	101 g	101 g
Interface type	SATA	SATA	SATA	SATA
Transfer rate	100 MB/sec	100 MB/sec	100 MB/sec	100 MB/sec
Security	ATA security	ATA security	ATA security	ATA security
Seek times (typical read, including setting)				
Single track	1.5 ms	1.5 ms	1.5 ms	1.5 ms
Average	12.0 ms	12.0 ms	12.0 ms	12.0 ms
Maximum	22.0 ms	22.0 ms	22.0 ms	22.0 ms
Logical blocks	1,250,291,258	976,785,075	625,142,448	488,397,168
Disc rotational speed	5400 rpm	7200 rpm	7200 rpm	7200 rpm
Operating temperature	5°C to 55°C (41°F to 131°F)			
*1 GB = 1 billion bytes when referring to hard drive storage capacity. Actual accessible capacity is less. Actual drive specifications may differ slightly.				
NOTE: Certain restrictions and exclusions apply. Contact technical support for details.				

Blu-ray ROM DVD±RW SuperMulti Double-Layer Drive specifications

Applicable disc	Read	Write
	BD-ROM, BD-ROM-DL, BD-R, BD-R-DL, BD-RE, BD-RE-DL, DVD-ROM, DVD+R, DVD+R-DL, DVD+RW, DVD-R, DVD-R-DL, DVD-RW, DVD-RAM (Ver.2), CD-DA, CD-ROM (mode 1 and mode 2), CD-ROM XA (mode 2, form 1 and form 2), Photo CD (single and multiple sessions), CD Extra, CD-R, CD-RW, and CD-TEXT	DVD-RAM (Ver.2), DVD+R, DVD-R, CD-R, and CD-ROM
Access time	BD	DVD
Random	< 230 ms	< 180 ms
Cache buffer	4.5 MB	
Data transfer rate		
2X BD-RAM	9 MB/sec	
8X DVD	2,400 KB/sec	
16X CD-R	2,400 KB/sec	
16X CD-RW	2,400 KB/sec	

DVD±RW and CD-RW SuperMulti Double-Layer Combo Drive specifications

Applicable disc	Read	Write
	CD-DA, CD+(E)G, CD-MIDI, CD-TEXT, CDROM, CD-ROM XA, MIXED MODE CD, CD-I, CD-I Bridge (Photo-CD, Video CD), Multisession CD (Photo-CD, CD-EXTRA, Portfolio, CD-R, CD-RW), CD-R, CD-RW, DVD-ROM (DVD-5, DVD-9, DVD-10, DVD-18), DVD-R, DVD-RW, DVD+R, DVD+RW, DVD-RAM	CD-R and CD-RW DVD+R, DVD+RW, DVD-R, DVD-RW, DVD-RAM
Access time	CD	DVD
Random	< 175 ms	< 230 ms
Cache buffer	2.5 MB	
Data transfer rate		
24X CD-ROM	3,600 KB/sec	
8X DVD	10,800 KB/sec	
24X CD-R	3,600 KB/sec	
16X CD-RW	2,400 KB/sec	
8X DVD+R	10,800 KB/sec	
4X DVD+RW	5,400 KB/sec	
8X DVD-R	10,800 KB/sec	
4X DVD-RW	5,400 KB/sec	
2.4X DVD+R(9)	2,700 KB/sec	
5X DVD-RAM	6,750 KB/sec	
Transfer mode	Multiword DMA mode	

7 Backup and recovery

Recovery after a system failure is as complete as your most current backup. HP recommends that you create recovery discs immediately after software setup. As you add new software and data files, you should continue to back up your system on a regular basis to maintain a reasonably current backup.

Tools provided by the operating system and HP Recovery Manager software are designed to help you with the following tasks for safeguarding your information and restoring it in case of a system failure:

- Creating a set of recovery discs (Recovery Manager software feature). Recovery discs are used to start up (boot) your computer and restore the operating system and software programs to factory settings in case of system failure or instability.
- Backing up your information regularly to protect your important system files.
- Creating system restore points (operating system feature). System restore points allow you to reverse undesirable changes to your computer by restoring the computer to an earlier state.
- Recovering a program or driver (Recovery Manager software feature). This feature helps you reinstall a program or driver without performing a full system recovery.
- Performing a full system recovery (Recovery Manager software feature). With Recovery Manager, you can recover your full factory image if you experience system failure or instability. Recovery Manager works from a dedicated recovery partition (select models only) on the hard drive or from recovery discs you create.

 **NOTE:** Computers with a solid-state drive (SSD) may not have a recovery partition. Recovery discs have been included for computers that do not have a partition. Use these discs to recover your operating system and software. To check for the presence of a recovery partition, click **Start**, right-click **Computer**, click **Manage**, and then click **Disk Management**. If the partition is present, an HP Recovery drive is listed in the window.

Creating recovery discs

HP recommends that you create recovery discs to be sure that you can restore your system to its original factory state if you experience serious system failure or instability. Create these discs after setting up the computer for the first time.

Handle these discs carefully and keep them in a safe place. The software allows the creation of only one set of recovery discs.

 **NOTE:** If your computer does not include an integrated optical drive, you can use an optional external optical drive (purchased separately) to create recovery discs, or you can purchase recovery discs for your computer from the HP Web site.

Note the following guidelines before creating recovery discs:

- You will need high-quality DVD-R, DVD+R, BD-R (writable Blu-ray), or CD-R discs. All these discs are purchased separately. DVDs and BDs have a much higher capacity than CDs. If you use CDs, up to 20 discs may be required, whereas only a few DVDs or BDs are required.

 **NOTE:** Read-write discs, such as CD-RW, DVD±RW, double-layer DVD±RW, and BD-RE (rewritable Blu-ray) discs, are not compatible with the Recovery Manager software.

- The computer must be connected to AC power during this process.
- Only one set of recovery discs can be created per computer.
- Number each disc before inserting it into the optical drive.
- If necessary, you can exit the program before you have finished creating the recovery discs. The next time you open Recovery Manager, you will be prompted to continue the disc creation process.

To create a set of recovery discs:

1. Select **Start > All Programs > Recovery Manager > Recovery Disc Creation**.
2. Follow the on-screen instructions.

Backing up your information

As you add new software and data files, you should back up your system on a regular basis to maintain a reasonably current backup. Back up your system at the following times:

- At regularly scheduled times

 **NOTE:** Set reminders to back up your information periodically.

- Before the computer is repaired or restored
- Before you add or modify hardware or software

Note the following when backing up:

- Create system restore points using the Windows System Restore feature, and periodically copy them to disc.
- Store personal files in the Documents library and back up this folder periodically.
- Back up templates stored in their associated programs.
- Save customized settings in a window, toolbar, or menu bar by taking a screen shot of your settings. The screen shot can be a time-saver if you have to reset your preferences.

To copy the screen and paste it into a word-processing document, follow these steps:

1. Display the screen.

2. Copy the screen:

To copy only the active window, press **alt+prt sc**.

To copy the entire screen, **press prt sc**.

3. Open a word-processing document, and then select **Edit > Paste**.

4. Save the document.

- You can back up your information to an optional external hard drive, a network drive, or discs.
- When backing up to discs, use any of the following types of discs (purchased separately): CD-R, CD-RW, DVD+R, DVD-R, or DVD±RW. The discs you use will depend on the type of optical drive installed in your computer.

 **NOTE:** DVDs store more information than CDs, so using them for backup reduces the number of recovery discs required.

- When backing up to discs, number each disc before inserting it into the optical drive of the computer.

Using Windows Backup and Restore

To create a backup using Windows Backup and Restore, follow these steps:

 **NOTE:** Be sure that the computer is connected to AC power before you start the backup process.

NOTE: The backup process may take over an hour, depending on file size and the speed of the computer.

1. Select **Start > All Programs > Maintenance > Backup and Restore**.
2. Follow the on-screen instructions to set up and create a backup.

 **NOTE:** Windows includes the User Account Control feature to improve the security of your computer. You may be prompted for your permission or password for tasks such as installing software, running utilities, or changing Windows settings. Refer to Help and Support for more information.

Using system restore points

When you back up your system, you are creating a system restore point. A system restore point allows you to save and name a snapshot of your hard drive at a specific point in time. You can then recover back to that point if you want to reverse subsequent changes made to your system.

 **NOTE:** Recovering to an earlier restore point does not affect data files saved or e-mails created since the last restore point.

You also can create additional restore points to provide increased protection for your system files and settings.

When to create restore points

- Before you add or extensively modify software or hardware
- Periodically, whenever the system is performing optimally

 **NOTE:** If you revert to a restore point and then change your mind, you can reverse the restoration.

Create a system restore point

1. Select **Start > Control Panel > System and Security > System**.
2. In the left pane, click **System Protection**.
3. Click the **System Protection** tab.
4. Under **Protection Settings**, select the disk for which you want to create a restore point.
5. Click **Create**.
6. Follow the on-screen instructions.

Restore to a previous date and time

To revert to a restore point (created at a previous date and time), when the computer was functioning optimally, follow these steps:

1. Select **Start > Control Panel > System and Security > System**.
2. In the left pane, click **System protection**.
3. Click the **System Protection** tab.
4. Click **System Restore**.
5. Follow the on-screen instructions.

Performing a recovery

 **NOTE:** You can recover only files that you have previously backed up. HP recommends that you use HP Recovery Manager to create a set of recovery discs (entire drive backup) as soon as you set up your computer.

Recovery Manager software allows you to repair or restore the system if you experience system failure or instability. Recovery Manager works from recovery discs or from a dedicated recovery partition (select models only) on the hard drive. However, if your computer includes a solid-state drive (SSD), you may not have a recovery partition. If that is the case, recovery discs have been included with your computer. Use these discs to recover your operating system and software.

 **NOTE:** Windows has its own built-in repair features, such as System Restore. If you have not already tried these features, try them before using Recovery Manager.

NOTE: Recovery Manager recovers only software that was preinstalled at the factory. Software not provided with this computer must be downloaded from the manufacturer's Web site or reinstalled from the disc provided by the manufacturer.

Recovering from the recovery discs

To restore the system from the recovery discs:

1. Back up all personal files.
2. Insert the first recovery disc into an optional external optical drive and restart the computer.
3. Follow the on-screen instructions.

Recovering from the dedicated recovery partition (select models only)

 **NOTE:** Computers with an SSD may not have a recovery partition. If the computer does not have a recovery partition, you will not be able to recover using this procedure. Recovery discs have been included for computers that do not have a partition. Use these discs to recover your operating system and software.

On some models, you can perform a recovery from the partition on the hard drive, accessed by pressing either the Start button or **f11**. This restores the computer to its factory condition.

To restore the system from the partition, follow these steps:

1. Access Recovery Manager in either of the following ways:
 - Select **Start > All Programs > Recovery Manager > Recovery Manager**.
 - or –
 - Turn on or restart the computer, and then press **esc** while the “Press the ESC key for Startup Menu” message is displayed at the bottom of the screen. Then, press **f11** while the “Press <F11> for recovery” message is displayed on the screen.
2. Click System Recovery in the Recovery Manager window.
3. Follow the on-screen instructions.

8 Connector pin assignments

Audio-in (microphone)

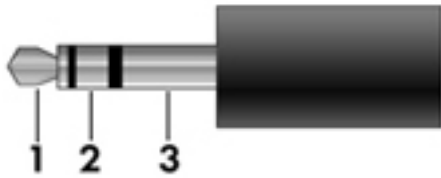

Pin	Signal
1	Audio signal in
2	Audio signal in
3	Ground

Audio-out (headphone)

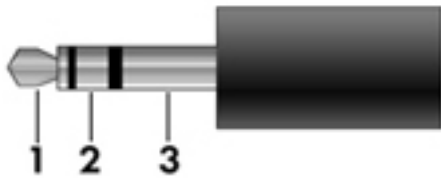

Pin	Signal
1	Audio out, left channel
2	Audio out, right channel
3	Ground

External monitor

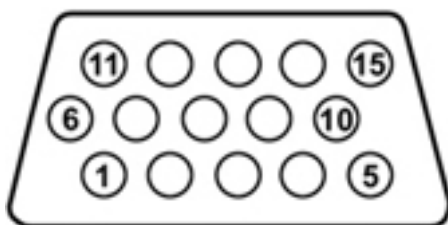

Pin	Signal
1	Red analog
2	Green analog
3	Blue analog
4	Not connected
5	Ground
6	Ground analog
7	Ground analog
8	Ground analog
9	+5 VDC
10	Ground
11	Monitor detect
12	DDC 2B data
13	Horizontal sync
14	Vertical sync
15	DDC 2B clock

HDMI

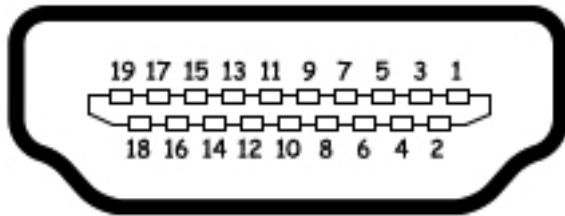

Pin	Signal	Pin	Signal
1	TMDS data 2+	11	TMDS clock shield
2	TMDS data 2 shield	12	TMDS clock-
3	TMDS data 2-	13	CEC
4	TMDS data 1+	14	No connect
5	TMDS data 1 shield	15	DDC clock
6	TMDS data 1-	16	DDC data
7	TMDS data 0+	17	Ground
8	TMDS data 0 shield	18	+5V power
9	TMDS data 0-	19	Hot plug detect
10	TMDS clock+		

RJ-45 (network)

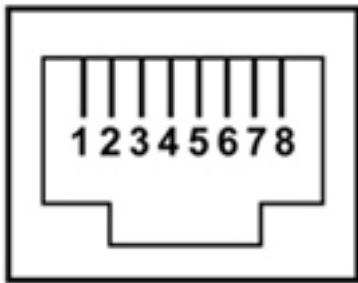

Pin	Signal
1	Transmit +
2	Transmit -
3	Receive +
4	Unused
5	Unused
6	Receive -
7	Unused
8	Unused

Universal Serial Bus

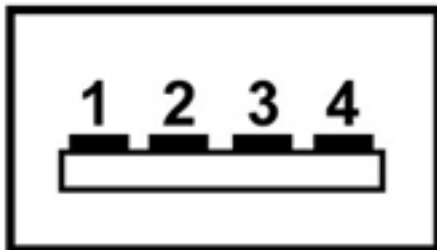

Pin	Signal
1	+5 VDC
2	Data
3	Data +
4	Ground

9 Power cord set requirements

The wide-range input feature of the computer permits it to operate from any line voltage from 100 to 120 volts AC, or from 220 to 240 volts AC

The 3-conductor power cord set included with the computer meets the requirements for use in the country or region where the equipment is purchased.

Power cord sets for use in other countries and regions must meet the requirements of the country or region where the computer is used.

Requirements for all countries

The following requirements are applicable to all countries and regions:

- The length of the power cord set must be at least **1.5 m** (5.0 ft) and no more than **2.0 m** (6.5 ft).
- All power cord sets must be approved by an acceptable accredited agency responsible for evaluation in the country or region where the power cord set will be used.
- The power cord sets must have a minimum current capacity of 10 amps and a nominal voltage rating of 125 or 250 V AC, as required by the power system of each country or region.
- The appliance coupler must meet the mechanical configuration of an EN 60 320/IEC 320 Standard Sheet C13 connector for mating with the appliance inlet on the back of the computer.

Requirements for specific countries and regions

Country/region	Accredited agency	Applicable note number
Australia	EANSW	1
Austria	OVE	1
Belgium	CEBC	1
Canada	CSA	2
Denmark	DEMKO	1
Finland	FIMKO	1
France	UTE	1
Germany	VDE	1
Italy	IMQ	1
Japan	METI	3
The Netherlands	KEMA	1
Norway	NEMKO	1
The People's Republic of China	COC	5
South Korea	EK	4
Sweden	SEMKO	1
Switzerland	SEV	1
Taiwan	BSMI	4
The United Kingdom	BSI	1
The United States	UL	2

1. The flexible cord must be Type HO5VV-F, 3-conductor, 1.0-mm² conductor size. Power cord set fittings (appliance coupler and wall plug) must bear the certification mark of the agency responsible for evaluation in the country or region where it will be used.
2. The flexible cord must be Type SPT-3 or equivalent, No. 18 AWG, 3-conductor. The wall plug must be a two-pole grounding type with a NEMA 5-15P (15 A, 125 V) or NEMA 6-15P (15 A, 250 V) configuration.
3. The appliance coupler, flexible cord, and wall plug must bear a "T" mark and registration number in accordance with the Japanese Dentori Law. The flexible cord must be Type VCT or VCTF, 3-conductor, 1.00-mm² conductor size. The wall plug must be a two-pole grounding type with a Japanese Industrial Standard C8303 (7 A, 125 V) configuration.
4. The flexible cord must be Type RVV, 3-conductor, 0.75-mm² conductor size. Power cord set fittings (appliance coupler and wall plug) must bear the certification mark of the agency responsible for evaluation in the country or region where it will be used.
5. The flexible cord must be Type VCTF, 3-conductor, 0.75-mm² conductor size. Power cord set fittings (appliance coupler and wall plug) must bear the certification mark of the agency responsible for evaluation in the country or region where it will be used.

10 Recycling

Battery

When a battery has reached the end of its useful life, do not dispose of the battery in general household waste. Follow the local laws and regulations in your area for computer battery disposal.

Display

- ⚠ **WARNING!** The backlight contains mercury. Caution must be exercised when removing and handling the backlight to avoid damaging this component and causing exposure to the mercury.
- ⚠ **CAUTION:** The procedures in this chapter can result in damage to display components. The only components intended for recycling purposes are the liquid crystal display (LCD) panel and the backlight. When you remove these components, handle them carefully.
- 📄 **NOTE:** Materials Disposal. This HP product contains mercury in the backlight in the display assembly that might require special handling at end-of-life. Disposal of mercury may be regulated because of environmental considerations. For disposal or recycling information, contact your local authorities, or see the Electronic Industries Alliance (EIA) Web site at <http://www.eiai.org>.

This section provides disassembly instructions for the display assembly. The display assembly must be disassembled to gain access to the backlight **(1)** and the liquid crystal display (LCD) panel **(2)**.

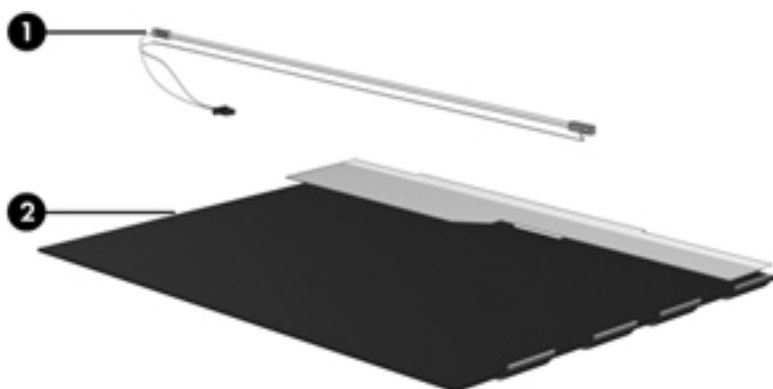

- 📄 **NOTE:** The procedures provided in this chapter are general disassembly instructions. Specific details, such as screw sizes, quantities, and locations, and component shapes and sizes, can vary from one computer model to another.

Perform the following steps:

1. Remove all screw covers **(1)** and screws **(2)** that secure the display bezel to the display assembly.

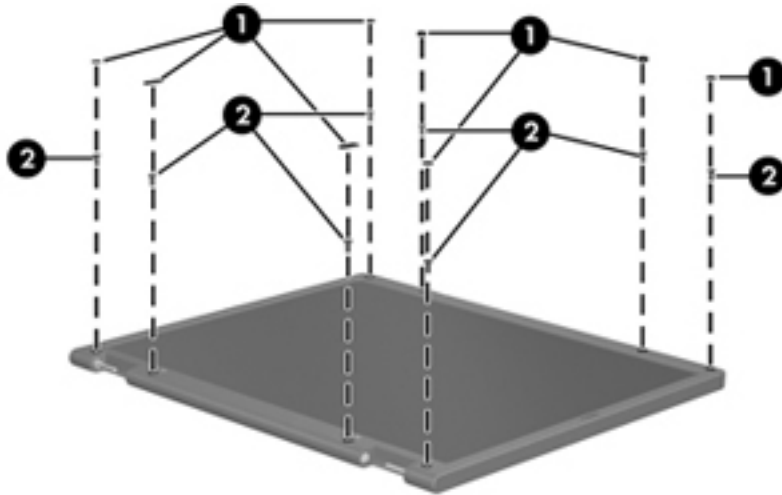

2. Lift up and out on the left and right inside edges **(1)** and the top and bottom inside edges **(2)** of the display bezel until the bezel disengages from the display assembly.
3. Remove the display bezel 3.

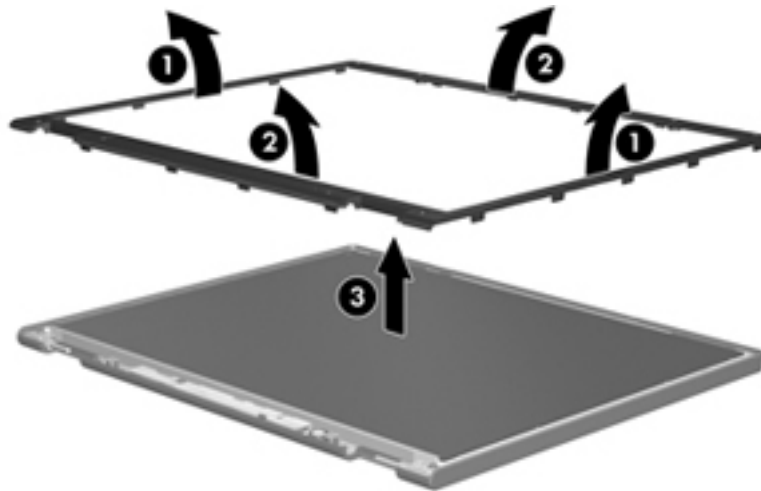

4. Disconnect all display panel cables (1) from the display inverter and remove the inverter 2.

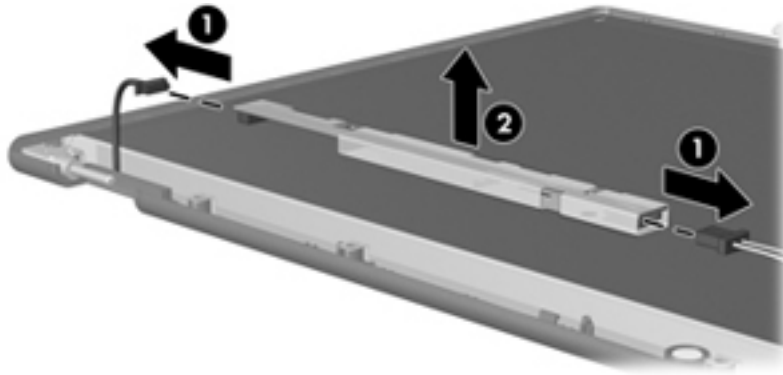

5. Remove all screws (1) that secure the display panel assembly to the display enclosure.
6. Remove the display panel assembly (2) from the display enclosure.

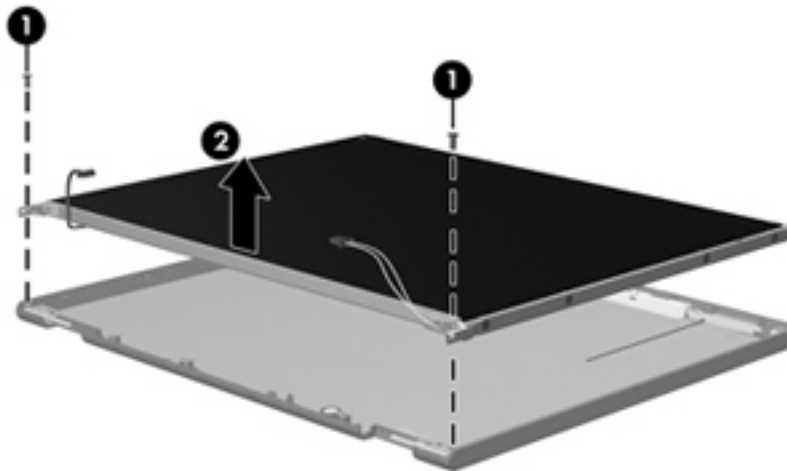

7. Turn the display panel assembly upside down.
8. Remove all screws that secure the display panel frame to the display panel.

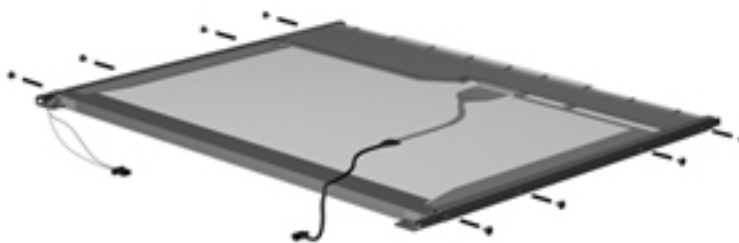

9. Use a sharp-edged tool to cut the tape (1) that secures the sides of the display panel to the display panel frame.

- 10.** Remove the display panel frame **(2)** from the display panel.

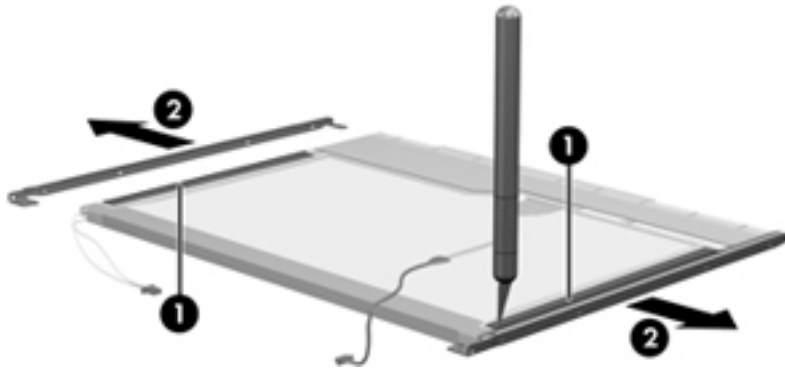

- 11.** Remove the screws **(1)** that secure the backlight cover to the display panel.

- 12.** Lift the top edge of the backlight cover **(2)** and swing it outward.

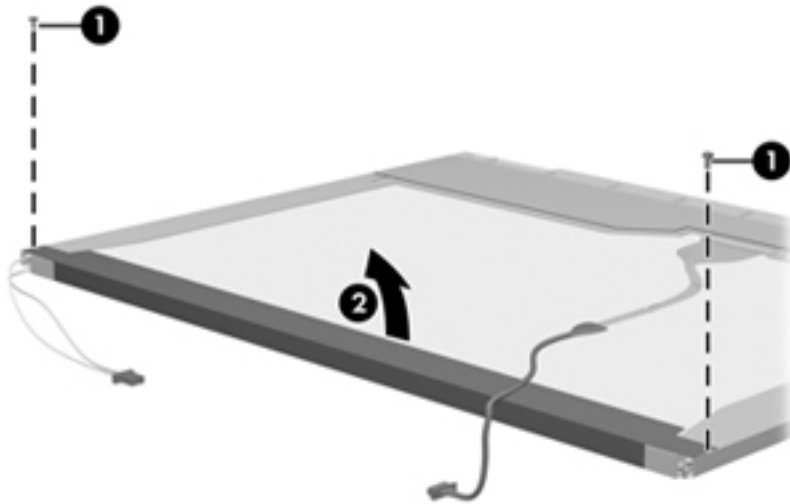

- 13.** Remove the backlight cover.

- 14.** Turn the display panel right-side up.

15. Remove the backlight cables (1) from the clip (2) in the display panel.

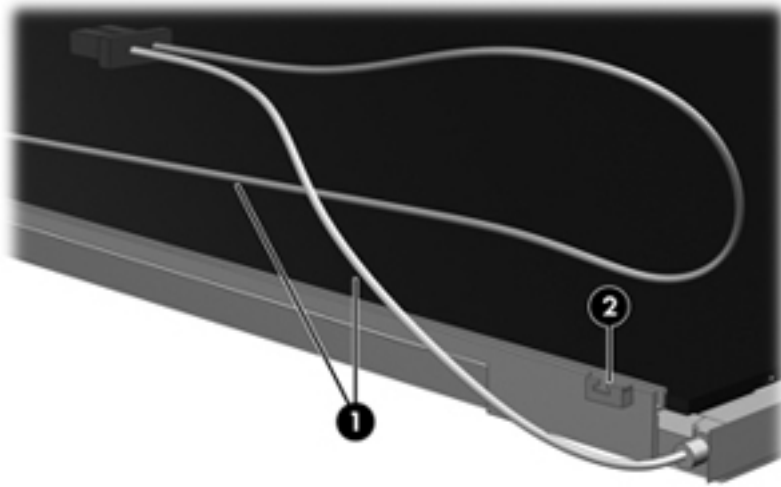

16. Turn the display panel upside down.
17. Remove the backlight frame from the display panel.

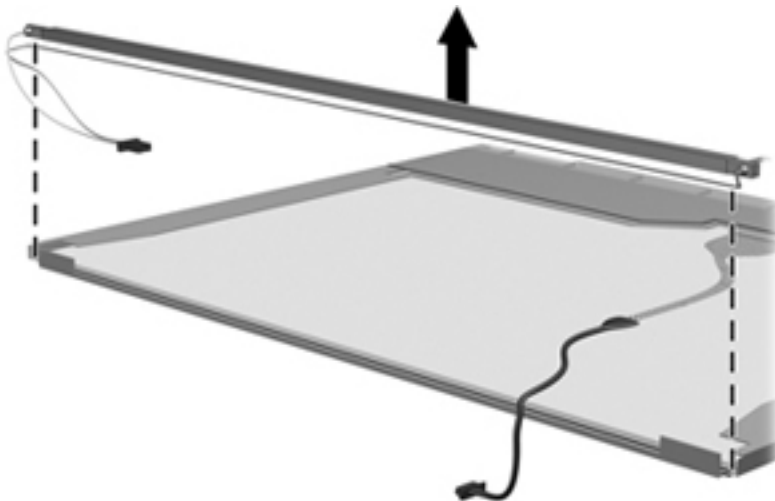

⚠ WARNING! The backlight contains mercury. Exercise caution when removing and handling the backlight to avoid damaging this component and causing exposure to the mercury.

18. Remove the backlight from the backlight frame.

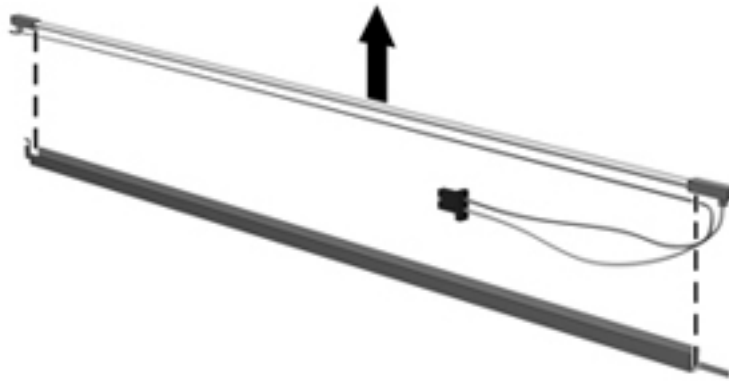

19. Disconnect the display cable **(1)** from the LCD panel.

20. Remove the screws **(2)** that secure the LCD panel to the display rear panel.

21. Release the LCD panel **(3)** from the display rear panel.

22. Release the tape **(4)** that secures the LCD panel to the display rear panel.

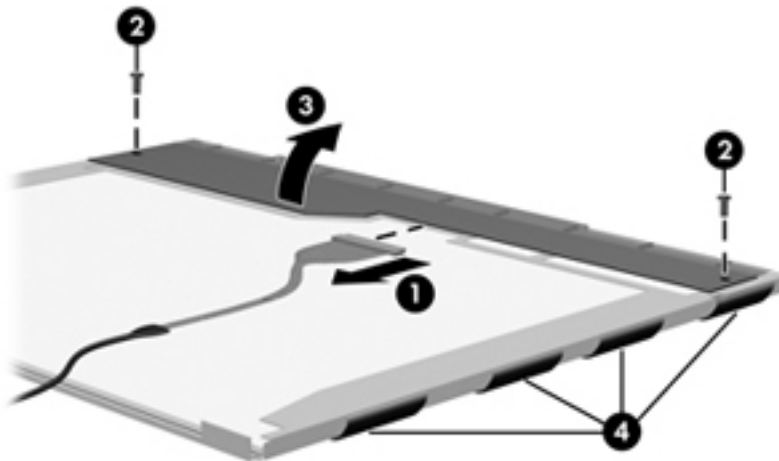

23. Remove the LCD panel.

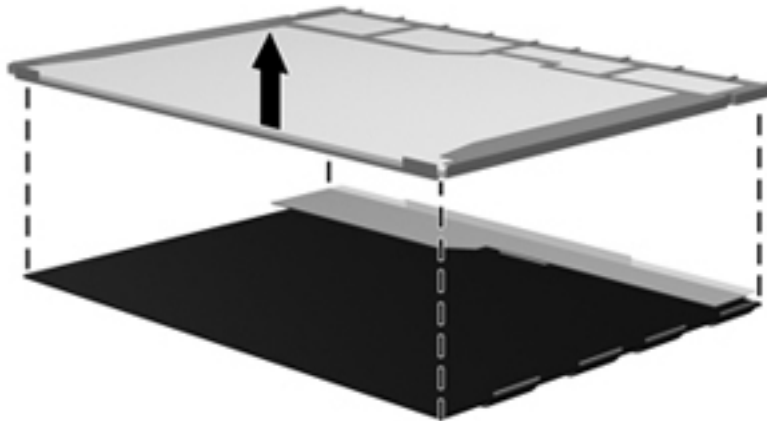

24. Recycle the LCD panel and backlight.

Index

- A**
 - AC adapter, spare part
 - numbers 22, 26
 - action keys 5
 - administrator password 71
 - antenna, location 4
 - applications key, Windows 5
 - audio, product description 2
 - audio-in jack
 - connector pinout 86
 - location 9
 - audio-out jack
 - connector pinout 86
 - location 9
- B**
 - base enclosure, spare part
 - number 17, 26
 - battery
 - removal 35
 - spare part number 19, 25, 35
 - battery bay 12
 - battery light 11
 - battery release latch 12
 - Blu-ray ROM DVD±RW SuperMulti Double-Layer Drive
 - precautions 28
 - spare part number 21, 25
 - specifications 78
 - Bluetooth module
 - removal 53
 - spare part number 17, 23, 53
 - bottom components 12
 - buttons
 - rotate 10
 - wireless 11
- C**
 - Cable Kit, spare part
 - number 17, 26
 - cables, service considerations 28
 - caps lock light 6
 - chipset, product description 1
 - components
 - bottom 12
 - front 8
 - keys 5
 - left-side 9
 - lights 6
 - rear 8
 - right-side 10
 - TouchPad 7
 - computer feet
 - locations 34
 - spare part number 17, 34
 - computer specifications 75
 - connector pinout
 - audio-in jack 86
 - audio-out jack 86
 - external monitor port 87
 - HDMI port 88
 - headphone 86
 - microphone 86
 - monitor port 87
 - network jack 89
 - RJ-45 jack 89
 - Universal Serial Bus (USB) port 89
 - connectors, service
 - considerations 28
 - convertible hinge 5
- D**
 - Diagnostics menu 72
 - Digital Media Slot 11
 - diskette drive
 - precautions 28
 - product description 2
 - display assembly
 - removal 55
 - spare part number 16, 26, 55
 - spare part numbers 55
 - specifications 76
 - display bezel, spare part
 - number 16, 25
 - display components 4
 - display enclosure, spare part
 - number 16, 25
 - display hinge 5
 - display hinge cover
 - illustrated 20
 - removal 55, 56
 - display panel, product
 - description 1
 - Display Screw Kit, spare part
 - number 16, 25
 - docking support, product
 - description 3
 - drive light 9
 - drives, preventing damage 28
 - DVD±RW and CD-RW SuperMulti Double-Layer Combo Drive
 - precautions 28
 - spare part number 21, 25
 - specifications 79
- E**
 - electrostatic discharge 29
 - esc key 5
 - Ethernet, product description 2
 - external media cards, product
 - description 2
 - external monitor port
 - connector pinout 87
 - location 8

F

- fan
 - removal 63
 - spare part number 17, 25, 63
- feet
 - locations 34
 - spare part number 17, 34
- fingerprint reader 10
- fingerprint reader board, spare part number 16, 25
- fn key 5
- front components 8

G

- graphics, product description 1
- grounding equipment and methods 31

H

- hard drive
 - precautions 28
 - product description 1
 - removal 37
 - spare part
 - numbers 18, 21, 25, 26, 37
 - specifications 77
- hard drive bay 12
- hard drive cover
 - illustrated 20
 - removal 38
- Hard Drive Hardware Kit, spare part number 19, 21, 25, 37
- hard drive self test 72
- HDMI port
 - connector pinout 88
 - location 9
- headphone jack
 - connector pinout 86
 - location 9
- headset, spare part number 22, 23
- heat sink
 - removal 64
 - spare part
 - numbers 17, 26, 64

J

- jacks
 - audio-in 9
 - audio-out 9
 - headphone 9

- microphone 9
- network 8
- RJ-45 8

K

- key components 5
- keyboard
 - product description 3
 - removal 50
 - spare part
 - numbers 16, 24, 25, 50
- keys
 - action 5
 - esc 5
 - fn 5
 - Windows applications 5
 - Windows logo 5

L

- left-side components 9
- Light components 6
- lights
 - battery 11
 - caps lock 6
 - drive 9
 - mute 6
 - power 10
 - TouchPad off indicator 6
 - webcam 4
 - wireless 6, 10

M

- Main menu 71
- mass storage devices, spare part numbers 21
- memory module
 - product description 1
 - removal 40
 - spare part
 - numbers 18, 26, 40
- memory module compartment 12
- memory module compartment cover
 - illustrated 20
 - removal 41
- memory test 72
- microphone 4
- microphone jack
 - connector pinout 86
 - location 9
- model name 1

- monitor port
 - connector pinout 87
 - location 8
- mute light 6

N

- network jack
 - connector pinout 89
 - location 8

O

- operating system, product description 3
- optical drive
 - precautions 28
 - product description 2
 - spare part numbers 21, 25

P

- packing guidelines 30
- passwords 71
- pen
 - removal 36
 - spare part number 17, 25, 36
- pen eject assembly
 - removal 52
 - spare part number 17, 25, 52
- pen holder
 - location 9
 - removal 52
 - spare part number 17, 25, 52
- pen tether hole 9
- plastic parts 27
- Plastics Kit
 - contents 20
 - spare part number 17, 20, 25
- pointing devices, product description 3
- ports
 - external monitor 8
 - HDMI 9
 - monitor 8
 - product description 2
 - USB 9, 11
- power connector 11
- power connector and cable
 - removal 62
 - spare part number 17, 25, 62
- power cord
 - set requirements 90
 - spare part numbers 22, 23

- power light 10
 - power requirements, product
 - description 3
 - power switch 10
 - power switch board
 - removal 54
 - spare part number 17, 26, 54
 - power-on password 71
 - processor, product description 1
 - product description
 - audio 2
 - chipset 1
 - diskette drive 2
 - display panel 1
 - docking support 3
 - Ethernet 2
 - external media cards 2
 - graphics 1
 - hard drives 1
 - keyboard 3
 - memory module 1
 - operating system 3
 - optical drives 2
 - pointing devices 3
 - ports 2
 - power requirements 3
 - processors 1
 - product name 1
 - security 3
 - serviceability 3
 - webcam 2
 - wireless 2
 - product name 1
 - protective sleeve, spare part
 - number 22, 25
- R**
- rear components 8
 - removal/replacement
 - preliminaries 27
 - procedures 32
 - reset board, spare part
 - number 16, 26
 - right-side components 10
 - RJ-45 jack
 - connector pinout 89
 - location 8
 - rotate button 10
- S**
- RTC battery
 - removal 47
 - spare part number 17, 25, 47
 - Rubber Kit, spare part
 - number 17, 25, 34
 - Screw Kit, spare part
 - number 22, 25
 - security cable slot 8
 - Security menu 71
 - security, product description 3
 - service considerations 27
 - service tag 13, 32
 - serviceability, product
 - description 3
 - Setup Utility
 - Diagnostics menu 72
 - Main menu 71
 - overview 68
 - Security menu 71
 - starting 68
 - System Configuration menu 72
 - speakers 4
 - speakers, spare part
 - number 16, 25
 - specifications
 - Blu-ray ROM DVD±RW SuperMulti Double-Layer Drive 78
 - computer 75
 - display assembly 76
 - DVD±RW and CD-RW SuperMulti Double-Layer Combo Drive 79
 - hard drive 77
 - static-shielding materials 31
 - system board
 - removal 59
 - spare part
 - numbers 17, 26, 59
 - System Configuration menu 72
 - system information 71
- T**
- thermal material,
 - replacement 66, 67
 - tools required 27
- U**
- top cover
 - removal 48
 - spare part number 17, 25, 48
 - TouchPad components 7
 - TouchPad left button 7
 - TouchPad off indicator 7
 - TouchPad off indicator light 6
 - TouchPad right button 7
 - TouchPad zone 7
 - transporting guidelines 30
- V**
- vents 8, 9, 12
- W**
- web camera/microphone module,
 - spare part number 16, 25
 - webcam
 - location 4
 - product description 2
 - webcam light 4
 - Windows applications key 5
 - Windows logo key 5
 - wireless antenna, location 4
 - wireless button 11
 - wireless light 6, 10
 - wireless, product description 2
 - WLAN module
 - removal 43
 - spare part
 - numbers 18, 23, 24, 25, 26, 43
 - workstation guidelines 30

