

Notebook PC User Guide

© Copyright 2010 Hewlett-Packard
Development Company, L.P.

ATI and ATI Mobility Radeon are trademarks of Advanced Micro Devices, Inc. Bluetooth is a trademark owned by its proprietor and used by Hewlett-Packard Company under license. Intel is a trademark of Intel Corporation in the U.S. and other countries. Microsoft and Windows are U.S. registered trademarks of Microsoft Corporation. SD Logo is a trademark of its proprietor.

The information contained herein is subject to change without notice. The only warranties for HP products and services are set forth in the express warranty statements accompanying such products and services. Nothing herein should be construed as constituting an additional warranty. HP shall not be liable for technical or editorial errors or omissions contained herein.

First Edition: April 2010

Document Part Number: 609867-001

Product notice

This user guide describes features that are common to most models. Some features might not be available on the computer.

Safety warning notice

-
- △ **WARNING!** To reduce the possibility of heat-related injuries or of overheating the computer, do not place the computer directly on your lap or obstruct the computer air vents. Use the computer only on a hard, flat surface. Do not allow another hard surface, such as an adjoining optional printer, or a soft surface, such as pillows or rugs or clothing, to block airflow. Also, do not allow the AC adapter to contact the skin or a soft surface, such as pillows or rugs or clothing, during operation. The computer and the AC adapter comply with the user-accessible surface temperature limits defined by the International Standard for Safety of Information Technology Equipment (IEC 60950).
-

Table of contents

1 Features	1
Identifying hardware	1
Components	1
Top components	1
TouchPad	1
Lights	2
Buttons and Fingerprint Reader (select models only)	3
Keys	4
Front components	5
Right-side components	5
Left-side components	6
Bottom components	7
Display components	8
Wireless antennas	9
Additional hardware components	10
Labels	10
2 Networking	12
Using wireless devices	12
Identifying wireless and network status icons	13
Using the wireless controls	13
Using the wireless key	14
Using HP Wireless Assistant	14
Using operating system controls	15
Using a WLAN	15
Setting up a WLAN	15
Protecting your WLAN	16
Connecting to a WLAN	17
Roaming to another network	17
Using Bluetooth wireless devices (select models only)	17
Bluetooth and Internet Connection Sharing (ICS)	18
Connecting to a local area network	18
3 Pointing devices and keyboard	20
Using pointing devices	20
Setting pointing device preferences	20
Using the TouchPad	20
Turning the TouchPad on and off	20

Using TouchPad gestures	21
Scrolling	21
Pinching	21
Connecting an external mouse	22
Using the action keys	22
Using the hotkeys	23
Using the keypads	24
Using an integrated numeric keypad	24
Using an optional external numeric keypad	25
Cleaning the TouchPad and keyboard	25

4 Multimedia 26

Multimedia features	26
Identifying your multimedia components	27
Adjusting the volume	28
Using the media activity keys	29
Multimedia software	29
Using HP MediaSmart software	29
Using other preinstalled multimedia software	30
Installing multimedia software from a disc	30
Audio	30
Connecting external audio devices	30
Checking your audio functions	31
Video	31
Connecting an external monitor or projector	31
Connecting an HDMI device	33
Configuring audio for HDMI (select models only)	33
Webcam	34

5 Power management 35

Setting power options	35
Using power-saving states	35
Initiating and exiting Sleep	35
Initiating and exiting Hibernation	36
Using the battery meter	36
Using power plans	36
Viewing the current power plan	36
Selecting a different power plan	37
Customizing power plans	37
Setting password protection on wakeup	37
Using external AC power	37
Connecting the AC adapter	39
Using battery power	39

Finding battery information in Help and Support	40
Using Battery Check	40
Displaying the remaining battery charge	40
Inserting or removing the battery	40
Charging a battery	41
Maximizing battery discharge time	42
Managing low battery levels	42
Identifying low battery levels	42
Resolving a low battery level	42
Resolving a low battery level when external power is available	43
Resolving a low battery level when a charged battery is available	43
Resolving a low battery level when no power source is available	43
Resolving a low battery level when the computer cannot exit Hibernation	43
Calibrating a battery	43
Conserving battery power	45
Storing a battery	45
Disposing of a used battery	46
Replacing the battery	46
Switching between graphics modes (select models only)	46
Shutting down the computer	46
6 Drives	48
Handling drives	48
Optical drive	48
Identifying the installed optical drive	49
Using optical discs	49
Selecting the right disc (CDs, DVDs, and BDs)	49
CD-R discs	50
CD-RW discs	50
DVD±R discs	50
DVD±RW discs	50
LightScribe DVD+R discs	50
Blu-ray discs (BD)	50
Playing a CD, DVD, or BD	51
Configuring AutoPlay	51
Changing DVD region settings	52
Observing the copyright warning	53
Copying a CD or DVD	53
Creating (burning) a CD or DVD	54
Removing a CD, DVD, or BD	55
Using external drives	55

Improving hard drive performance	56
Using Disk Defragmenter	56
Using Disk Cleanup	56
Replacing a drive in the primary hard drive bay	56
Replacing a drive in the secondary hard drive bay	59
7 External devices	62
Using a USB device	62
Connecting a USB device	62
Removing a USB device	63
Using an eSATA device	63
Connecting an eSATA device	64
Removing an eSATA device	64
8 External media cards	65
Using Digital Media Slot cards	65
Inserting a digital card	65
Removing a digital card	66
9 Memory modules	67
10 Security	71
Protecting the computer	71
Using passwords	71
Setting passwords in Windows	72
Setting passwords in Setup Utility	72
Administrator password	73
Managing an administrator password	73
Entering an administrator password	73
Power-on password	73
Managing a power-on password	74
Entering a power-on password	74
Using antivirus software	74
Using firewall software	74
Installing critical security updates	75
Installing an optional security cable	75
Using the Fingerprint Reader (select models only)	76
Locating the Fingerprint Reader	76
Registering fingerprints	77
Using your registered fingerprint to log on to Windows	78

11 Setup Utility (BIOS)	79
Starting Setup Utility	79
Using Setup Utility	79
Changing the language of Setup Utility	79
Navigating and selecting in Setup Utility	79
Displaying system information	80
Restoring default settings in Setup Utility	80
Exiting Setup Utility	81
Setup Utility menus	81
Main menu	81
Security menu	81
System Configuration menu	82
Diagnostics menu	82
12 Software updates	83
Updating the BIOS	83
Determining the BIOS version	83
Downloading a BIOS update	84
Updating programs and drivers	85
13 Backup and recovery	86
Creating recovery discs	86
Backing up your information	87
Using Windows Backup and Restore	88
Using system restore points	88
When to create restore points	88
Create a system restore point	88
Restore to a previous date and time	88
Performing a recovery	89
Recovering from the recovery discs	89
Recovering from the dedicated recovery partition (select models only)	89
14 Troubleshooting	90
Cannot connect to a WLAN	90
Cannot connect to a preferred network	90
Network icon is not displayed	91
Current network security codes are unavailable	91
WLAN connection is very weak	92
Cannot connect to the wireless router	92
The optical disc tray does not open for removal of a CD, a DVD, or a BD	93
The computer does not detect the CD, DVD, or BD drive	93
A CD, DVD, or BD does not play	94
A CD, DVD, or BD does not play automatically	95

A DVD or BD movie stops, skips, or plays erratically	95
A DVD or BD movie is not visible on an external display	95
The process of burning a CD or DVD does not begin, or it stops before completion	95
A DVD or BD playing in Windows Media Player produces no sound or display	96
A device driver must be reinstalled	96
Obtaining the latest HP device drivers	96
Obtaining the latest Windows device drivers	97

Index	98
--------------------	-----------

1 Features

Identifying hardware

To see a list of hardware installed on the computer:

1. Select **Start > Control Panel > System and Security**.
2. In the System area, click **Device Manager**.

Use Device Manager to add hardware or modify device configurations.

 **NOTE:** Windows® includes the User Account Control feature that improves the security of the computer. You might be prompted for your permission or password for tasks such as installing applications, running utilities, or changing Windows settings. For more information, see Help and Support.

Components

Top components

TouchPad

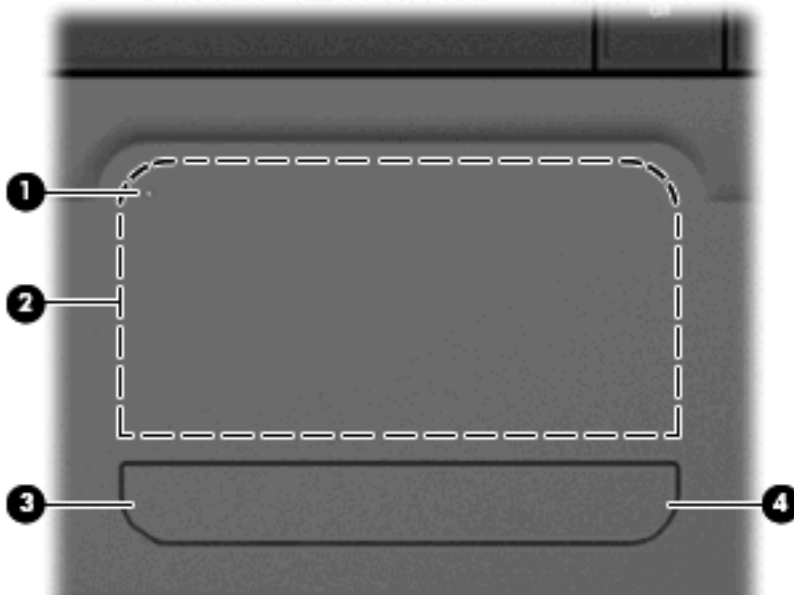

Component	Description
(1) TouchPad on/off button	Turns the TouchPad on and off. Quickly double-tap the button to turn the TouchPad on and off.
(2) TouchPad zone*	Moves the pointer and selects or activates items on the screen.
(3) Left TouchPad button*	Functions like the left button on an external mouse.

Component	Description
(4) Right TouchPad button*	Functions like the right button on an external mouse.

*This table describes factory settings. To view or change pointing device preferences, select **Start > Devices and Printers**. Then, right-click the icon representing your device, and select **Mouse settings**.

Lights

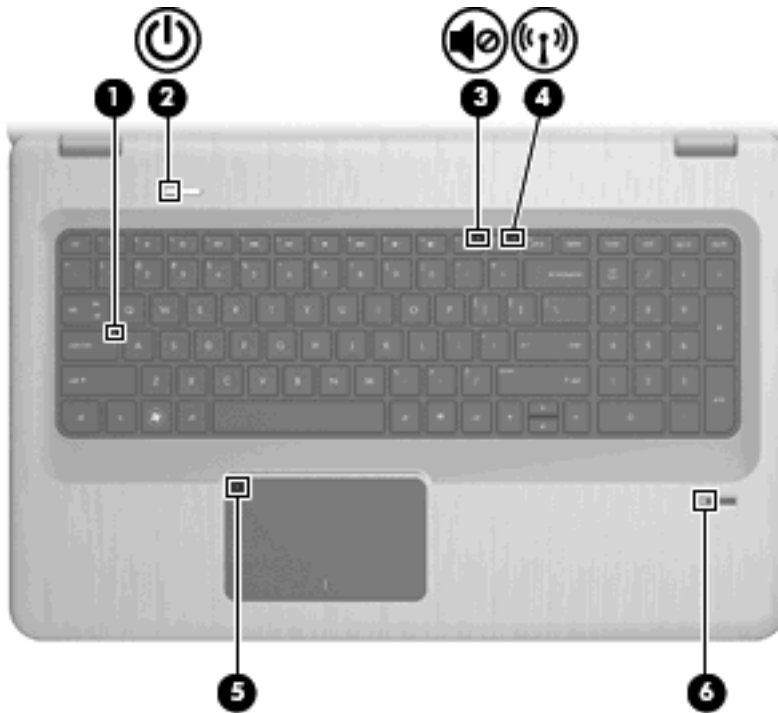

Item	Description	Function
(1)	Caps Lock light	On—The Caps Lock is on.
(2)	Power light	<ul style="list-style-type: none"> On—The computer is on. Flashing—The computer is in Sleep. Off—The computer is off or in Hibernation.
(3)	Volume Mute light	Amber—The computer sound is off.
(4)	Wireless light	<ul style="list-style-type: none"> White—An integrated wireless device, such as a wireless local area network (WLAN) device and/or a Bluetooth® device, is detected. Amber—No wireless devices are detected.
(5)	TouchPad light	Amber—The TouchPad is disabled.
(6)	Fingerprint Reader light	<ul style="list-style-type: none"> White—The fingerprint was read. Amber—The fingerprint was not read.

Buttons and Fingerprint Reader (select models only)



Item	Description	Function
(1)	Power button	<p>Press the Power button to:</p> <ul style="list-style-type: none">• Turn on the computer.• Initiate Sleep.• Exit Sleep.• Exit Hibernation. <p>If the computer has stopped responding and Windows shutdown procedures are ineffective, press and hold the Power button for at least 5 seconds to shut down the computer.</p> <p>For more information about the power settings, select Start > Control Panel > System and Security > Power Options.</p>
(2)	Fingerprint Reader (select models only)	<p>Allows a fingerprint logon to Windows, instead of a password logon.</p>

This table describes the factory settings. For information about changing the factory settings, see Help and Support.

Keys

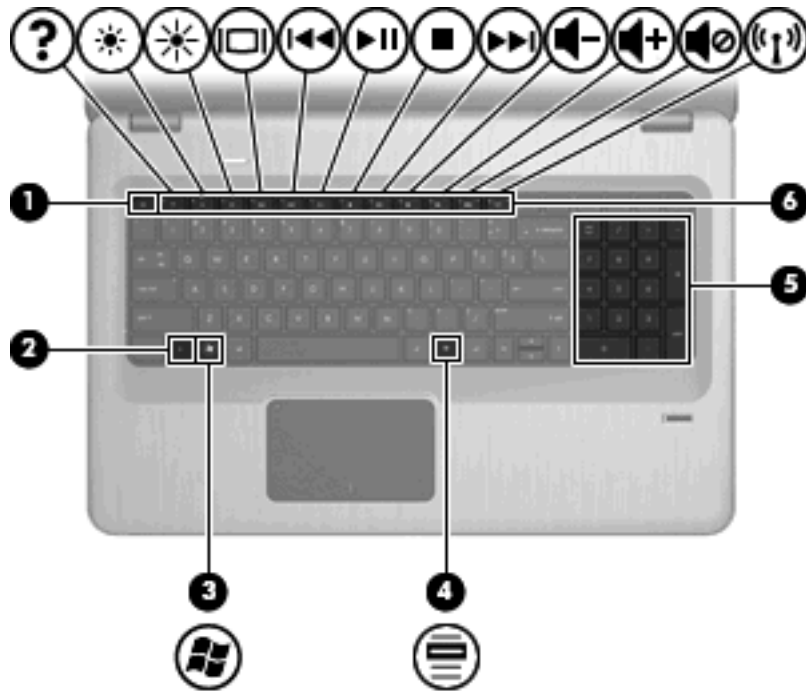

Item	Description	Function
(1)	esc key	Press the esc and fn keys at the same time to display system information.
(2)	fn key	Press the fn key at the same time as a function key or the esc key to execute frequently used system functions.
(3)	Windows Logo key	Displays the Windows Start menu.
(4)	Windows Applications key	Displays a shortcut menu for items beneath the cursor.
(5)	Integrated numeric keypad	Functions like the keys on an external numeric keypad.
(6)	Action keys	Press a function key and the fn key at the same time to execute frequently used system functions.

Front components



Description	Function
Speakers	Produce sound.

Right-side components

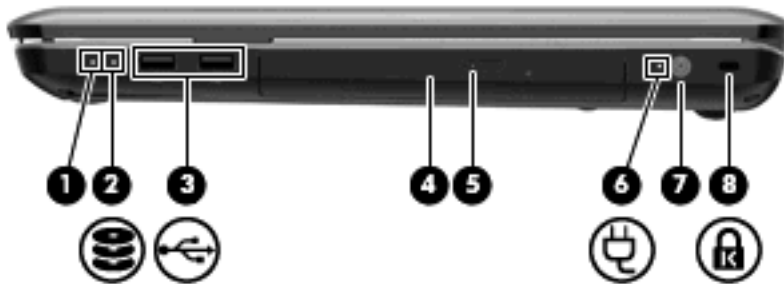

Item	Description	Function
(1)	Power light	<ul style="list-style-type: none"> On—The computer is on. Flashing—The computer is in Sleep. Off—The computer is off or in Hibernation.
(2)	Hard Disk Drive light	<ul style="list-style-type: none"> White—The hard disk drive is active. Amber—The hard disk drive is parked.
(3)	USB ports (2)	Connect optional USB devices.
(4)	Optical Drive light	Flashing—Accessing the optical drive.
(5)	Optical drive	Reads optical discs and, on select models, writes to optical discs.
(6)	AC Adapter light	<ul style="list-style-type: none"> On—The computer is connected to external power. Off—The computer is not connected to external power.
(7)	Power connector	Connects an AC adapter.
(8)	Security Cable slot	Connects an optional security cable. The security cable is designed to act as a deterrent, but might not prevent the computer from being mishandled or stolen.

Left-side components

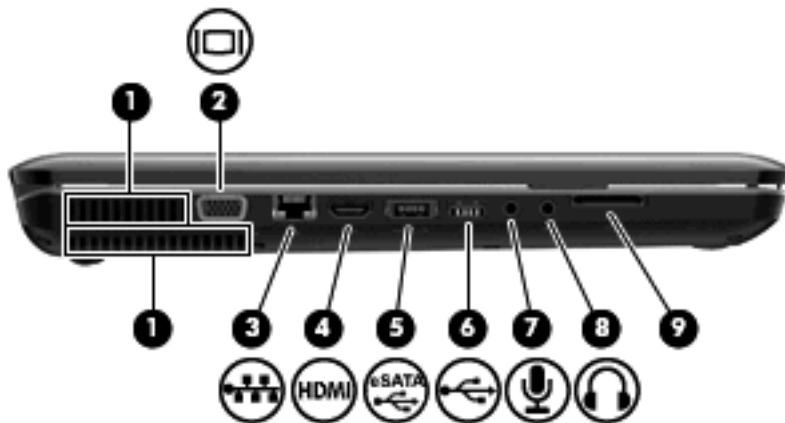

Item	Description	Function
(1)	Vents (2)	Enables airflow to cool internal components. NOTE: The computer fan starts up automatically to cool internal components and prevent overheating. It is normal for the internal fan to cycle on and off during routine operation.
(2)	External Monitor port	Connects an external VGA monitor or projector.
(3)	RJ-45 (network) jack	Connects a network cable.
(4)	HDMI port	Connects an optional video or audio device, such as a high-definition television, or any compatible digital or audio component.
(5)	eSATA/USB port (select models only)	Connects an optional high-performance eSATA component, such as an eSATA external hard drive, or connects an optional USB device. NOTE: Depending on the computer model, the computer might include only a USB port.
(6)	USB port	Connects an optional USB device.
(7)	Audio-in (microphone) jack	Connects an optional computer headset microphone, stereo array microphone, monarural microphone.
(8)	Audio-out (headphone) jack	Produces sound when connected to optional powered stereo speakers, headphones, ear buds, a headset, or television audio.
(9)	SD card reader	Reads SD cards that are inserted into the reader.

Bottom components

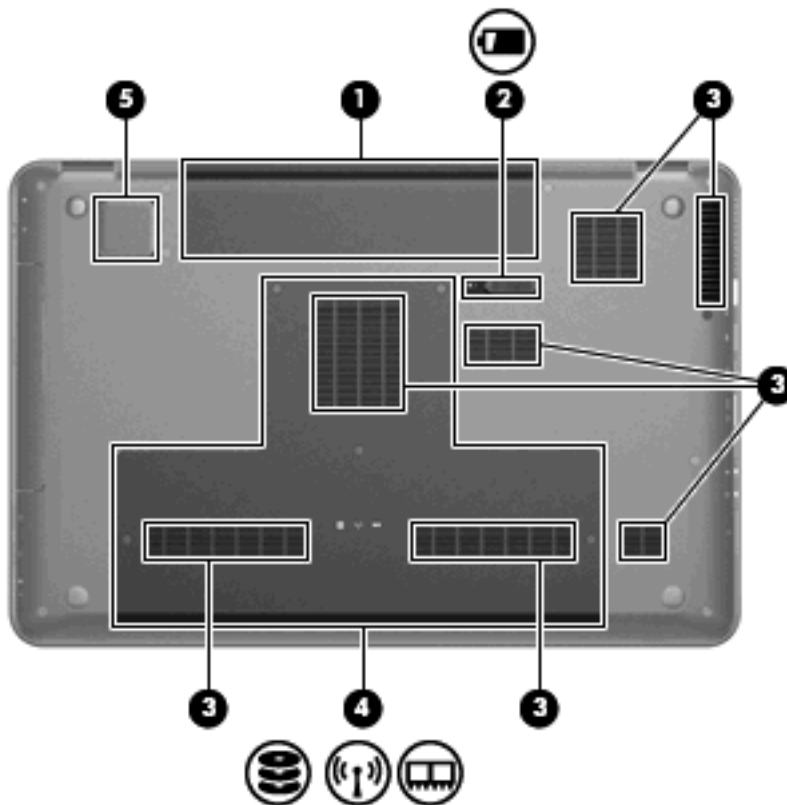

Item	Description	Function
(1)	Battery bay	Holds the battery.
(2)	Battery Release latch	Releases the battery from the battery bay.
(3)	Vents (7)	Enables airflow to cool internal components. NOTE: The computer fan starts up automatically to cool internal components and prevent overheating. It is normal for the internal fan to cycle on and off during routine operation.
(4)	Primary Hard Drive bay	Holds the primary hard drive, the memory module slots, and the WLAN module (select models only). CAUTION: To prevent an unresponsive system, replace the wireless module with a wireless module authorized for use by the governmental agency that regulates wireless devices in your country or region. If you replace the module and then receive a warning message, remove the module to restore computer functionality, and then contact technical support through Help and Support.
(5)	Integrated subwoofer (select models only)	Provides superior bass sound.

Display components



Item	Description	Function
(1)	Internal microphones (2)	Record sound.
(2)	Webcam light	On—The webcam is in use.
(3)	Webcam	Records video, and captures still photographs.

Wireless antennas

On select computer models, at least 2 antennas send and receive signals from one or more wireless devices. These antennas are not visible from the outside of the computer.

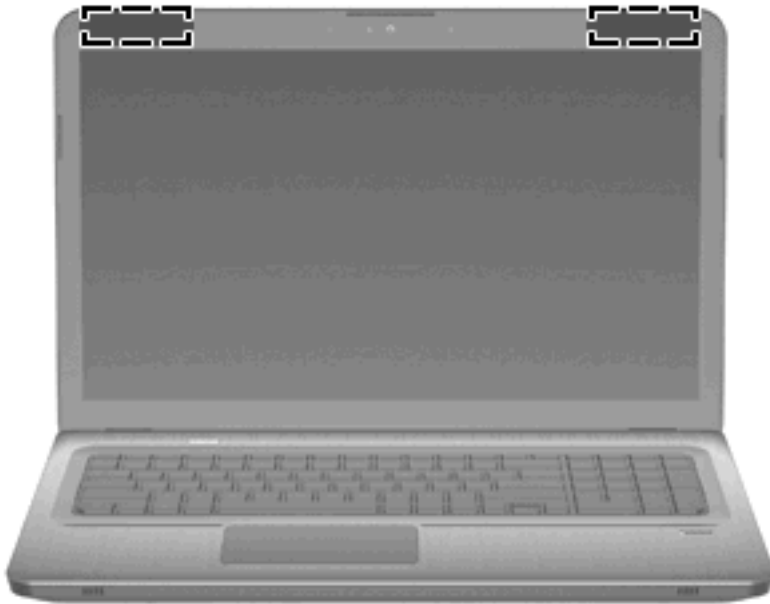

 **NOTE:** For optimal transmission, keep the areas immediately around the antennas free from obstructions.

To see wireless regulatory notices, refer to the section of the *Regulatory, Safety and Environmental Notices* that applies to your country or region. These notices are located in Help and Support.

Additional hardware components



Item	Description	Function
(1)	Power cord*	Connects an AC adapter to an AC outlet.
(2)	AC adapter	Converts AC power to DC power.
(3)	Battery*	Provides power when the computer is not connected to an external power source.

* Batteries and power cords vary in appearance by region and country.

Labels

The labels affixed to the computer provide information needed when troubleshooting system problems or traveling internationally with the computer.

- Service tag—Provides important information including:

The service tag label is affixed to the bottom of the computer. When contacting technical support, have this information available.

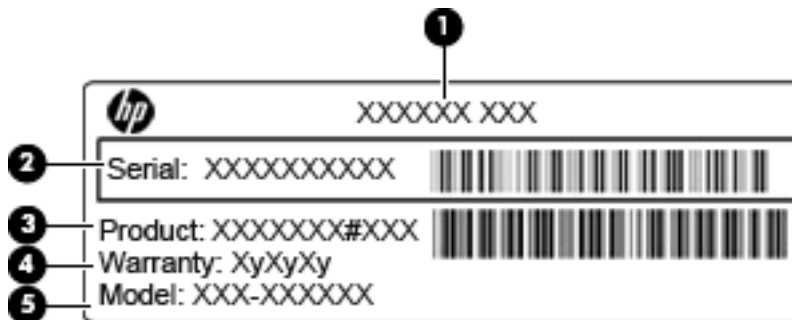

Item	Component	Description
(1)	Product name	This is the product name affixed to the front of the computer.

Item	Component	Description
(2)	Serial number	This is an alphanumeric identifier that is unique to each product.
(3)	Product number	This is an alphanumeric identifier that provides specific information about the hardware components. The product number helps a service technician to determine what components and parts are needed.
(4)	Warranty period	The duration (in years) of the warranty period for this computer.
(5)	Model description (select models only)	This is an alphanumeric identifier that you use to locate documents, drivers, and support for your computer.

- Microsoft Certificate of Authenticity—Contains the Windows Product Key. You might need the Product Key to update or troubleshoot the operating system. This certificate is affixed to the bottom of the computer.
- Regulatory label—Provides regulatory information about the computer. The regulatory label is affixed inside the battery bay.
- Wireless certification label(s) (select models only)—Provides information about optional wireless devices and the approval markings of some of the countries or regions where the devices have been approved for use. An optional device might be a wireless local area network (WLAN) device or an optional Bluetooth device. If the computer model includes one or more wireless devices, one or more certification labels are included with the computer. You might need this information when traveling internationally. Wireless certification labels are affixed inside the battery bay..
- SIM (subscriber identity module) label (select models only)—Provides the ICCID (Integrated Circuit Card Identifier) of the SIM. This label is located inside the battery bay.
- HP Mobile Broadband Module serial number label (select models only)—Provides the serial number of the HP Mobile Broadband Module. This label is located inside the battery bay.

2 Networking

Using wireless devices

Wireless technology transfers data across radio waves instead of wires. The computer might be equipped with one or more of the following wireless devices:

- Wireless local area network (WLAN) device—Connects the computer to wireless local area networks (commonly referred to as Wi-Fi networks, wireless LANs, or WLANs) in corporate offices, your home, and public places such as airports, restaurants, coffee shops, hotels, and universities. In a WLAN, each mobile wireless device communicates with a wireless router or a wireless access point.
- Bluetooth device (select models only)—Creates a personal area network (PAN) to connect to other Bluetooth-enabled devices such as computers, phones, printers, headsets, speakers, and cameras. In a PAN, each device communicates directly with other devices, and devices must be relatively close together—typically within 10 meters (approximately 33 feet) of each other.

Computers with WLAN devices support one or more of the following IEEE industry standards:

- 802.11b, the first popular standard, supports data rates of up to 11 Mbps and operates at a frequency of 2.4 GHz.
- 802.11g supports data rates of up to 54 Mbps and operates at a frequency of 2.4 GHz. An 802.11g WLAN device is backward compatible with 802.11b devices, so that they can operate on the same network.
- 802.11a supports data rates of up to 54 Mbps and operates at a frequency of 5 GHz.









NOTE: 802.11a is not compatible with 802.11b and 802.11g.

- 802.11n supports data rates of up to 450 Mbps and might operate at 2.4 GHz or 5 GHz, making it backward compatible with 802.11a, b, and g.

For more information on wireless technology, see the information and website links provided in Help and Support.

Identifying wireless and network status icons

Icon	Name	Description
	Wireless (connected)	Identifies the location of the wireless light and the wireless key on the computer. Also identifies the HP Wireless Assistant software on the computer and indicates that one or more of the wireless devices are on.
	Wireless (disconnected)	Identifies the HP Wireless Assistant software on the computer and indicates that all of the wireless devices are off.
	Wired network (connected)	Indicates that one or more network drivers are installed, and one or more network devices are connected to a wired network.
	Wired network (disabled/ disconnected)	Indicates that one or more network drivers are installed, but no network devices are connected (or all network devices are disabled in Windows Control Panel).
	Network (connected)	Indicates that one or more network drivers are installed, and one or more network devices are connected to a wireless network.
	Network (disconnected)	Indicates that one or more network drivers are installed and wireless connections are available, but no network devices are connected to a wireless network.
	Network (disabled/ disconnected)	Indicates that one or more network drivers are installed, but no wireless connections are available (or all wireless network devices are disabled by the wireless key or HP Wireless Assistant).

Using the wireless controls

Control the wireless devices on the computer using:

- Wireless action key or hotkey ([fn+f12](#))
- HP Wireless Assistant software
- HP Connection Manager software (select models only)
- Operating system controls

Using the wireless key

The computer has a wireless key, one or more wireless devices, and one or two wireless lights, depending on the model. All of the wireless devices on the computer are enabled at the factory, so the wireless light illuminates white when you turn on the computer.

The wireless light indicates the overall power state of your wireless devices, not the status of individual devices. If the wireless light illuminates white, at least one wireless device is on. If the wireless light illuminates amber, all wireless devices are off.

Because the wireless devices are enabled at the factory, use the wireless key to turn on or turn off the wireless devices simultaneously. Individual wireless devices are controlled through HP Wireless Assistant.

Using HP Wireless Assistant

A wireless device is turned on or off using HP Wireless Assistant. If a wireless device is disabled by Setup Utility, it must be re-enabled by Setup Utility before it can be turned on or off using Wireless Assistant.

 **NOTE:** Enabling or turning on a wireless device does not automatically connect the computer to a network or a Bluetooth-enabled device.

To view the state of the wireless devices, click the **Show hidden icons** icon, the arrow at the left of the notification area, and position the mouse pointer over the wireless icon.

If the wireless icon is not displayed in the notification area:

1. Select **Start > Control Panel > Hardware and Sound > Windows Mobility Center**.
2. Click the Wireless icon in the Wireless Assistant tile, which is located in the bottom row of Windows Mobility Center. Wireless Assistant appears.
3. Click **Properties**.
4. Select the check box next to **HP Wireless Assistant icon in notification area**.
5. Click **Apply**.
6. Click **Close**.

For more information, see the Wireless Assistant software Help. To access Help:

1. Open Wireless Assistant by clicking the Wireless icon in Windows Mobility Center.
2. Click the **Help** button.

Using operating system controls

Some operating systems offer a way to manage integrated wireless devices and the wireless connection. For example, Windows provides the Network and Sharing Center that allows you to set up a connection or network, connect to a network, manage wireless networks, and diagnose and repair network problems.

To access the Network and Sharing Center, select **Start > Control Panel > Network and Internet > Network and Sharing Center**.

For more information, select **Start > Help and Support**.

Using a WLAN

With a WLAN device, you can access a wireless local area network (WLAN), which is composed of other computers and accessories that are linked by a wireless router or a wireless access point.

 **NOTE:** The terms wireless router and wireless access point are often used interchangeably.

- A large-scale WLAN, such as a corporate or public WLAN, typically uses wireless access points that accommodate a large number of computers and accessories and can separate critical network functions.
- A home or small office WLAN uses a wireless router, which allows several wireless and wired computers to share an Internet connection, a printer, and files without requiring additional pieces of hardware or software.

To use the WLAN device in the computer, connect to a WLAN infrastructure (provided through a service provider or a public or corporate network).

Setting up a WLAN

To set up a WLAN and connect to the Internet, you need:

- A broadband modem (either DSL or cable) **(1)** and high-speed Internet service purchased from an Internet service provider (ISP)
- A wireless router (purchased separately) **(2)**
- The wireless computer **(3)**

The illustration below shows an example of a wireless network installation that is connected to the Internet.

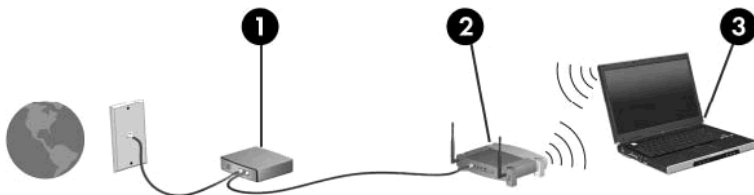

As your network grows, additional wireless and wired computers can be connected to the network to access the Internet.

For help in setting up your WLAN, see the information provided by your router manufacturer or your ISP.

Protecting your WLAN

Because the WLAN standard was designed with only limited security capabilities—basically to foil casual eavesdropping rather than more powerful forms of attack—it is essential to understand that WLANs are vulnerable to well-known and well-documented security weaknesses.

WLANs in public areas, or “hotspots,” like coffee shops and airports might not provide any security. New technologies are being developed by wireless manufacturers and hotspot service providers that make the public environment more secure and anonymous. If you are concerned about the security of the computer in a hotspot, limit your network activities to noncritical e-mail and basic Internet surfing.

When setting up a WLAN or access an existing WLAN, always enable security features to protect your network from unauthorized access. The common security levels are Wi-Fi Protected Access (WPA)-Personal and Wired Equivalent Privacy (WEP). Because wireless radio signals travel outside the network, other WLAN devices can pick up unprotected signals and either connect to your network (uninvited) or capture information being sent across it. To protect the WLAN:

- Use a wireless transmitter with built-in security

Many wireless base stations, gateways, or routers provide built-in security features such as wireless security protocols and firewalls. With the correct wireless transmitter, you can protect your network from the most common wireless security risks.

- Work behind a firewall

A firewall is a barrier that checks both data and requests that are sent to the network, and discards any suspicious items. Firewalls are available in many varieties, both software and hardware. Some networks use a combination of both types.

- Use wireless encryption

A variety of sophisticated encryption protocols is available for your WLAN. Find the solution that works best for your network security:

- Wired Equivalent Privacy (WEP) is a wireless security protocol that encodes or encrypts all network data before it is transmitted using a WEP key. The network assigns the WEP key, but you can set up your own key, generate a different key, or choose other advanced options. Without the correct key, others cannot access the WLAN.
- WPA (Wi-Fi Protected Access), like WEP, uses security settings to encrypt and decrypt data that is transmitted over the network. However, instead of using one static security key for encryptions as WEP does, WPA uses “temporal key integrity protocol” (TKIP) to dynamically generate a new key for every packet. It also generates different sets of keys for each computer on the network.

Connecting to a WLAN

To connect to the WLAN:

1. Be sure that the WLAN device is on. If it is on, the wireless light is illuminated white. If the wireless light is off, press the wireless key.

 **NOTE:** On some models, the wireless light is amber when all wireless devices are off.

2. Click the Network icon in the notification area at the far right of the taskbar.
3. Select your WLAN from the list.
4. Click **Connect**.

 **NOTE:** If no WLANs are listed, you are out of range of a wireless router or access point.

- If the network is a security-enabled WLAN, enter a network security key at the prompt, which is a security code, and then click **OK** to complete the connection.
- If you do not see the network you want to connect to, click **Open Network and Sharing Center**, and then click **Set up a new connection or network**. A list of options appears. Search for and connect to a network or to create a new network connection.

After the connection is made, place the mouse pointer over the Network icon in the notification area to verify the name and status of the connection.

 **NOTE:** The functional range (how far your wireless signals travel) depends on WLAN implementation, router manufacturer, and interference from other electronic devices or structural barriers such as walls and floors.

More information about using a WLAN is available through:

- Your ISP and the user guides included with the wireless router and other WLAN equipment
- Help and Support information and website links

For a list of public WLANs near you, contact your ISP or search the Web. Websites that list public WLANs include Cisco Internet Mobile Office Wireless Locations, Hotspotlist, and Geektools. Check with each public WLAN location for cost and connection requirements.

Roaming to another network

When you move the computer within range of another WLAN, Windows attempts to connect to that network. If the attempt is successful, the computer is automatically connected to the new network. If Windows does not recognize the new network, follow the instructions in “Connecting to a WLAN.”

Using Bluetooth wireless devices (select models only)

A Bluetooth device provides short-range wireless communications that replace the physical cable connections that traditionally link electronic devices such as:

- Computers (desktop, notebook, PDA)
- Phones (cellular, cordless, smart phone)
- Imaging devices (printer, camera)
- Audio devices (headset, speakers)

Bluetooth devices provide peer-to-peer capability that allows you to set up a personal area network (PAN) of Bluetooth devices. For information on configuring and using Bluetooth devices, see the Bluetooth software Help.

Bluetooth and Internet Connection Sharing (ICS)

HP does **not** recommend setting up a host, Bluetooth computer and using it as a gateway through which other computers connect to the Internet. When two or more computers are connected using Bluetooth, and Internet Connection Sharing (ICS) is enabled on one of the computers, the other computers cannot connect to the Internet using the Bluetooth network.

The strength of Bluetooth is in synchronizing information transfers between the computer and wireless devices including cellular phones, printers, cameras, and PDAs. The inability to consistently connect two or more computers to share the Internet through Bluetooth is a limitation of Bluetooth and the Windows operating system.

Connecting to a local area network

Connecting to a local area network (LAN) requires an 8-pin, RJ-45 network cable (purchased separately). If the network cable contains noise suppression circuitry (**1**), which prevents interference from TV and radio reception, orient the circuitry end of the cable (**2**) toward the computer.



⚠ WARNING! To reduce the risk of electric shock, fire, or damage to the equipment, do not connect a modem or telephone cable to the RJ-45 (network) jack.

To connect the network cable:

1. Connect the network cable to the network jack (**1**) on the computer.

2. Connect the other end of the cable to a network wall jack (2).

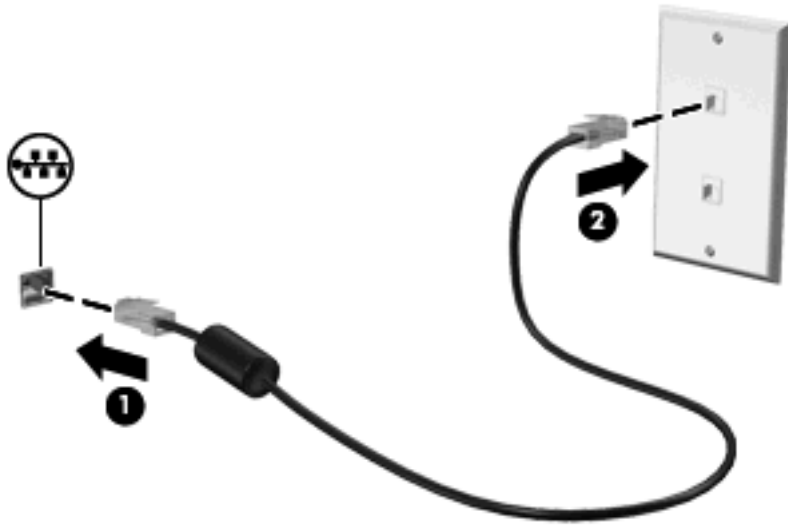

3 Pointing devices and keyboard

Using pointing devices

Setting pointing device preferences

Use Mouse Properties in Windows to customize settings for pointing devices, such as button configuration, click speed, and pointer options.

To access Mouse Properties:

1. Select **Start > Devices and Printers**.
2. Right-click the device representing the computer.
3. Select **Mouse settings**.

Using the TouchPad

Turning the TouchPad on and off

The TouchPad is turned on at the factory. When the TouchPad zone is active, the light is off. To turn the TouchPad on and off, quickly double-tap the TouchPad off indicator.

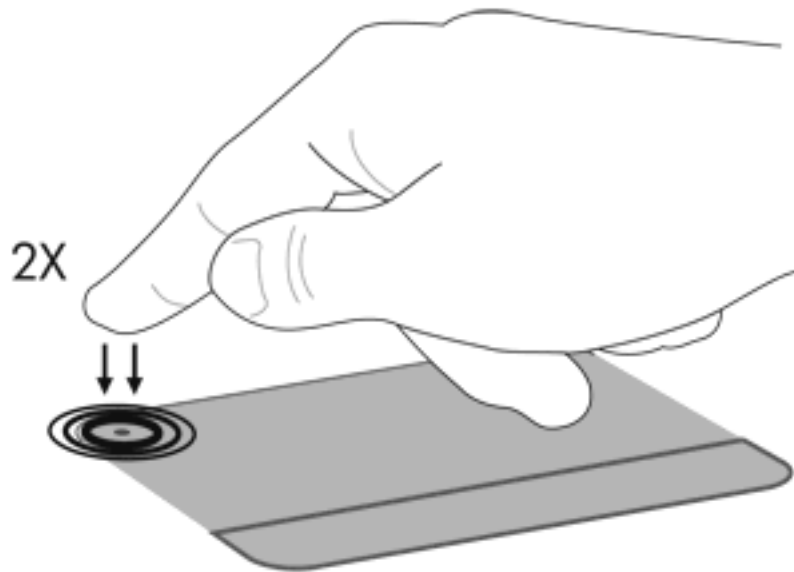

To move the pointer, slide your finger across the TouchPad surface in the direction you want the pointer to go. Use the left and right TouchPad buttons like the corresponding buttons on an external mouse. To scroll up and down using the TouchPad scroll zone, slide your finger vertically along the right edge of the TouchPad.

 **NOTE:** If you are using the TouchPad to move the pointer, you must lift your finger off the TouchPad before moving it to the scroll zone. Simply sliding your finger from the TouchPad to the scroll zone will not activate the scrolling function.

Using TouchPad gestures

The TouchPad supports a variety of TouchPad gestures. To activate the TouchPad gestures, place two fingers on the TouchPad as described in the following sections.

To enable or disable gestures, click the **Synaptics** icon in the notification area, at the far right of the taskbar, and then check or uncheck **Disable gestures**. To enable or disable a specific gesture, select **Control Panel > Hardware and Sound > Mouse > Device settings > Settings**, and then check or clear the check box next to the gesture you want to enable or disable.

Scrolling

Scrolling is useful for moving up or down on a page or image. To scroll, place two fingers slightly apart on the TouchPad and drag them across the TouchPad in an up, down, left, or right motion.

 **NOTE:** Scrolling speed is controlled by finger speed.

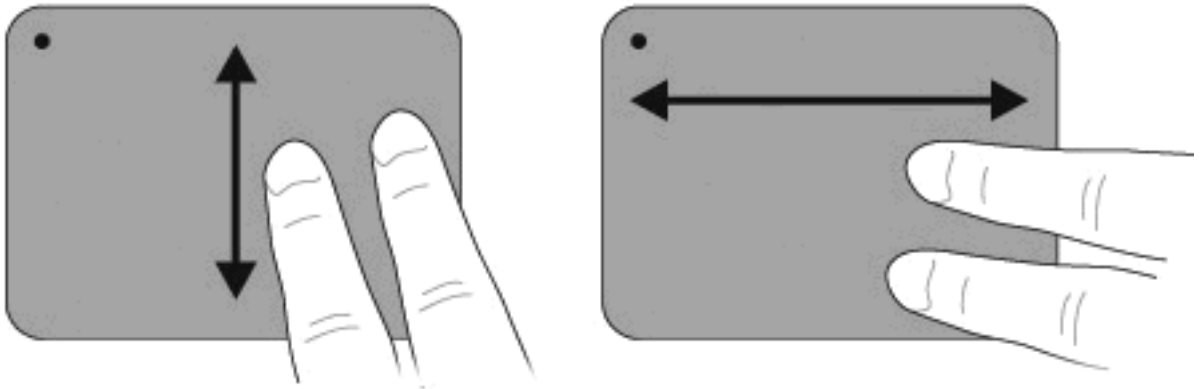

Pinching

Pinching allows you to zoom in or out on items such as PDFs, images, and photos.

To pinch:

- Zoom in by holding two fingers together on the TouchPad, and then pull the fingers apart to increase an object's size.
- Zoom out by holding two fingers apart on the TouchPad, and then pull the fingers together to decrease an object's size.

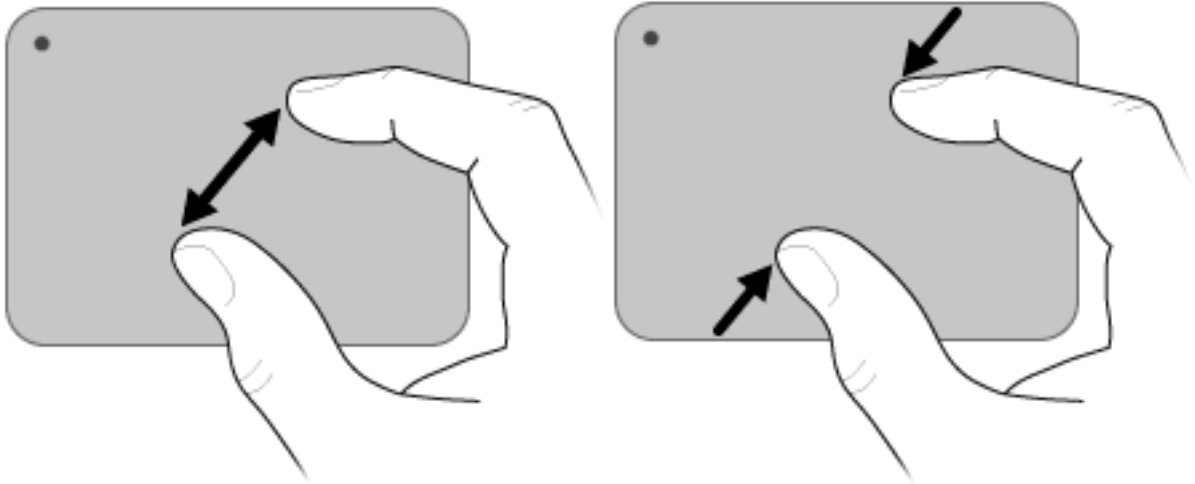

Connecting an external mouse

Connect an external USB mouse to the computer using one of the USB ports on the computer. A USB mouse also connects to the computer by using optional docking device ports or an optional expansion product.

Using the action keys



Action keys are customized actions that are assigned to specific keys at the top of the keyboard.









To use an action key, press and hold this key to activate the assigned function.

 **NOTE:** Depending on the application you are using, pressing **fn** and one of the action keys opens a specific shortcut menu within that application.

NOTE: The action key feature is enabled at the factory. You can disable this feature in Setup Utility. If this feature is disabled in Setup Utility, you will need to press **fn** and an action key to activate the assigned function. Refer to [Setup Utility \(BIOS\) on page 79](#) for additional information.



Icon	Description
	Opens Help and Support, which provides information about the Windows operating system and computer, answers to questions and tutorials, and updates to the computer. Help and Support also provides automated troubleshooting and links to support specialists.
	Decreases the screen brightness level incrementally when holding down this key.
	Increases the screen brightness level incrementally when holding down this key.

Icon	Description
	<p>Switches the screen image among display devices connected to the system. For example, if a monitor is connected to the computer, pressing this key alternates the screen image from computer display to monitor display to simultaneous display on both the computer and the monitor.</p> <p>Most external monitors receive video information from the computer using the external VGA video standard. The Switch Screen Image key also alternates images among other devices that are receiving video information from the computer.</p>
	Plays the previous track of an audio CD or the previous section of a DVD or a BD.
	Plays, pauses, or resumes an audio CD, a DVD, or a BD.
	Stops audio or video playback of a CD, a DVD, or a BD.
	Plays the next track of an audio CD or the next section of a DVD or a BD.
	Decreases speaker sound incrementally when holding down this key.
	Increases speaker sound incrementally when holding down this key.
	Mutes or restores speaker sound.
	<p>Turns the wireless feature on or off.</p> <p>NOTE: This key does not establish a wireless connection. To establish a wireless connection, a wireless network must be set up.</p>
<code>prt sc</code>	Takes a snapshot or picture of the computer screen and copies it to the clipboard.

Using the hotkeys

Hotkeys are combinations of the [esc](#) key (1) and the [fn](#) key (2).



Press **fn+esc** to display information about system hardware components and the system BIOS version number.

To use a hotkey command:

- Press the **fn** key, and then press the second key of the hotkey command.
– or –
- Press and hold down the **fn** key, press the second key of the hotkey command, and then release both keys at the same time.

Using the keypads

The computer has an integrated numeric keypad and also supports an optional numeric keypad or an optional external keyboard that includes a numeric keypad.



Item	Description	Function
(1)	num lk key	Enables or disables the integrated numeric keypad. NOTE: The keypad function that is active when the computer is turned off is reinstated when the computer is turned back on.
(2)	Integrated numeric keypad	Functions like the keys on an external numeric keypad.

Using an integrated numeric keypad

Keys on the integrated numeric keypad function differently according to whether num lock is on or off. Num lock is turned off at the factory.

- When num lock is on, keypad keys type numbers.
- When num lock is off, keypad keys function like the arrow, page up, or page down keys.

To turn num lock on or off, press the **num lk** key on the integrated keypad.

Using an optional external numeric keypad

Keys on most external numeric keypads function differently according to whether num lock is on or off. (Num lock is turned off at the factory.)

- When num lock is on, most keypad keys type numbers.
- When num lock is off, most keypad keys function like the arrow, page up, or page down keys.

When num lock on an external keypad is turned on, the num lock light on the computer is illuminated. When num lock on an external keypad is turned off, the num lock light on the computer is off.

To turn num lock on or off on an external keypad, press the **num lk** key on the external keypad, not on the computer.

Cleaning the TouchPad and keyboard

Dirt and grease on the TouchPad cause the pointer to jump around on the screen. To avoid this, clean the TouchPad with a damp cloth, and wash your hands frequently when using the computer.

⚠ WARNING! To reduce the risk of electric shock or damage to internal components, do not use a vacuum cleaner attachment to clean the keyboard. A vacuum cleaner deposits household debris on the keyboard surface.

Clean the keyboard regularly to prevent keys from sticking and to remove dust, lint, and particles that become trapped beneath the keys. A can of compressed air with a straw extension can blow air around and under the keys to loosen and remove debris.



4 Multimedia

Multimedia features

The computer includes multimedia features that allow you to listen to music, watch movies, and view pictures. The computer might include the following multimedia components:

- Optical drive for playing audio and video discs
- Integrated speakers for listening to music
- Integrated microphone for recording your own audio
- Integrated webcam that allows you to capture and share video
- Preinstalled multimedia software that allows you to play and manage your music, movies, and pictures
- Multimedia keys that provide fast access to multimedia tasks



NOTE: The computer might not include all of the components listed.

Identifying your multimedia components

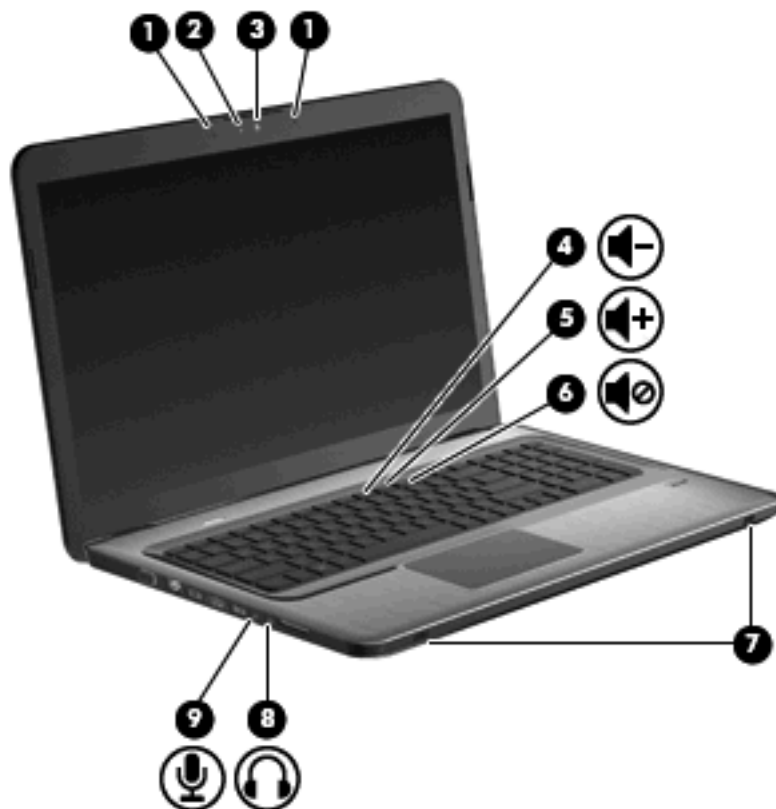



Item	Description	Function
(1)	Internal digital dual array microphones (2)	Record sound.
(2)	Webcam light	Illuminates when video software accesses the webcam.
(3)	Webcam	Records video, and captures still photographs.
(4)	Volume Down key	Decreases the volume.
(5)	Volume Up key	Increases the volume.
(6)	Volume Mute key	Mutes and restores speaker sound.
(7)	Speakers (2)	Produce sound.
(8)	Audio-out (headphone) jack	Produces sound when connected to optional powered stereo speakers, headphones, earbuds, headset, or television audio. WARNING! To reduce the risk of personal injury, adjust the volume before putting on headphones, earbuds, or a headset. For additional safety information, see <i>Regulatory, Safety and Environmental Notices</i> . NOTE: When a device is connected to the headphone jack, the computer speakers are disabled.
(9)	Audio-in (microphone) jack	Connects an optional computer headset microphone, stereo array microphone, or monaural microphone.

Adjusting the volume

Adjust the volume using the computer volume keys.

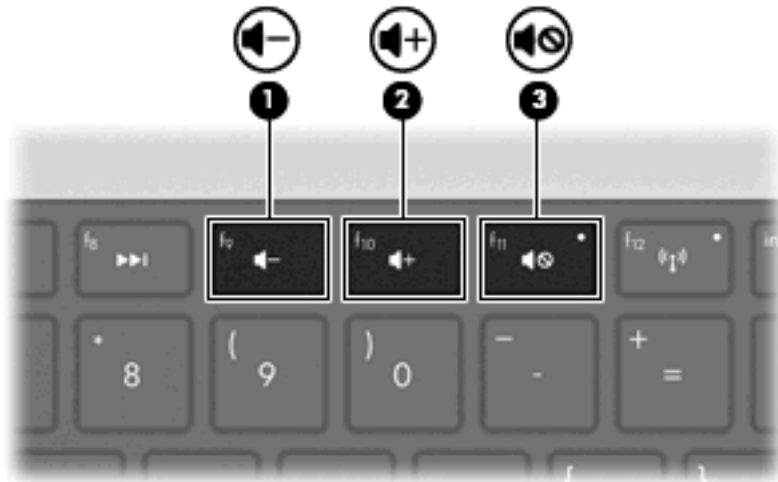
- To decrease volume, press the [Volume Down](#) key (1).
- To increase volume, press the [Volume Up](#) key (2).
- To mute or restore volume, press the [Volume Mute](#) key (3).



 **NOTE:** Volume is controlled through the Windows operating system and some programs.

Using the media activity keys

The media activity keys control the play of an audio CD or a DVD or BD that is inserted into an external optical drive (purchased separately).

- When an audio CD or a DVD is not playing, press the [Play/Pause](#) key **(2)**.
- When an audio CD or a DVD is playing, use the following keys:
 - To play the previous track of an audio CD or the previous section of a DVD, press the [Previous Track](#) key **(1)**.
 - To pause or resume playing the disc, press [Play/Pause](#) key **(2)**.
 - To stop the disc, press the [Stop](#) key **(3)**.
 - To play the next track of an audio CD or the next section of a DVD, press the [Next Track](#) key **(4)**.

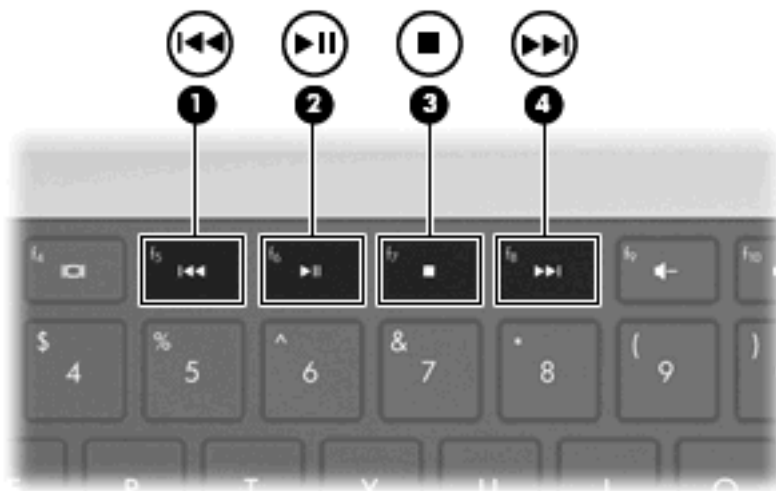

Multimedia software

Preinstalled multimedia software allows you to play music, watch movies, and view pictures.

Using HP MediaSmart software

HP MediaSmart turns the computer into a mobile entertainment center. Enjoy music and DVD and BD movies, view Internet TV, and manage and edit your photo collections.

MediaSmart includes:

- Internet TV—With an Internet connection, play classic oldies, choose from a range of TV shows and channels, and watch the HP-TV channel streamed in full-screen.
- Photo and video upload support
 - Upload MediaSmart photos to Internet photo storage sites, such as Snapfish.
 - Upload home videos (for example, fun videos created with the integrated webcam) to YouTube.
- Pandora Internet radio (North America only)—Listen to music selected just for you, streamed from the Internet.

To start MediaSmart, double-click the MediaSmart icon on the computer desktop.

For more information on using MediaSmart, select **Start > Help and Support**, and then type `MediaSmart` in the search box.

Using other preinstalled multimedia software

 **NOTE:** Some programs might be located in subfolders.

To locate other preinstalled multimedia software:

1. Select **Start > All Programs**
2. Open the multimedia program you want to use. For example, if you want to use Windows Media Player to play an audio CD, click **Windows Media Player**.

Installing multimedia software from a disc

To install any multimedia software from a CD or DVD:

1. Insert the disc into the optical drive.
2. When the installation wizard opens, follow the on-screen instructions.
3. Restart the computer, if prompted.

 **NOTE:** For details about using software included with the computer, see the software manufacturer's instructions. The instructions might be provided with the software, on the software disc, or on the manufacturer's website.

Audio

The computer has a variety of audio features that allow you to:

- Play music using the computer speakers and/or connected external speakers.
- Record sound using the internal microphone or a connected external microphone.
- Download music from the Internet.
- Create multimedia presentations using audio and images.
- Transmit sound and images with instant messaging programs.
- Stream radio programs (select models only) or receiving FM radio signals.
- Create or “burn” audio CDs.

Connecting external audio devices

 **WARNING!** To reduce the risk of personal injury, adjust the volume before putting on headphones, earbuds, or a headset. For additional safety information, see the *Regulatory, Safety and Environmental Notices*.

To connect external devices such as external speakers, headphone, or a microphone, see the information provided with the device. For best results:

- Be sure that the device cable is securely connected to the correct jack on the computer. Cable connectors are normally color-coded to match the corresponding jacks on the computer.
- Be sure that you install all drivers required by the external device.

 **NOTE:** A driver is a required program that acts like a translator between the device and the programs that use the device.

Checking your audio functions

To check the system sound on the computer:

1. Select **Start >Control Panel**.
2. Click **Hardware and Sound**.
3. Click **Sound**.
4. When the Sound window appears, click the **Sounds** tab.
5. Under **Program Events**, select any sound event, such as a beep or alarm.
6. Click the **Test** button. You should hear sound through the speakers or through connected headphones.

To check the record functions:

1. Select **Start >All Programs >Accessories >Sound Recorder**.
2. Click **Start Recording** and speak into the microphone. For best results when recording, speak directly into the microphone and record sound in a setting free of background noise.
3. Save the file to the desktop.
4. Open Windows Media Player or MediaSmart, and play back the sound.

To confirm or change the audio settings on the computer, select **Start >Control Panel >Hardware and Sound >Sound**.

Video

The computer has a variety of video features that allow you to:

- Watch movies.
- Play games over the Internet.
- Edit pictures and video to create presentations.
- Connect external video devices.
- Watch TV, including high-definition TV (select models only).

Connecting an external monitor or projector

The external monitor port connects an external display device such as an external monitor or a projector to the computer.

To connect a display device, connect the device cable to the external monitor port.

 **NOTE:** If a properly connected external display device does not display an image, press the [Switch Screen Image](#) key to transfer the image to the device. Repeatedly pressing the [Switch Screen Image](#) key alternates the screen image between the computer display and the device.

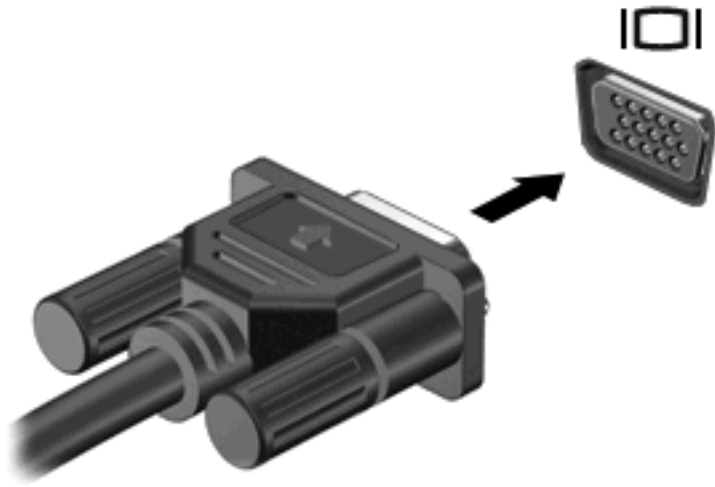

Connecting an HDMI device

The computer includes an HDMI (High Definition Multimedia Interface) port. The HDMI port connects the computer to an optional video or audio device, such as a high-definition television, or any compatible digital or audio component.

The computer supports one HDMI device connected to the HDMI port, while simultaneously supporting an image on the computer display or any other supported external display.

 **NOTE:** To transmit video signals through the HDMI port, you need an HDMI cable (purchased separately), available from most electronic retailers.

To connect a video or audio device to the HDMI port:

1. Connect one end of the HDMI cable to the HDMI port on the computer.

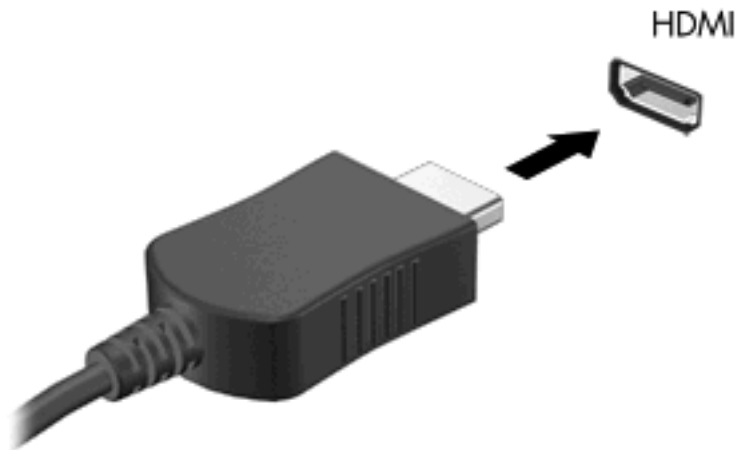

2. Connect the other end of the cable to the video device, according to the device manufacturer's instructions.
3. Press the [Switch Screen Image](#) key to switch the image between the display devices connected to the computer.

Configuring audio for HDMI (select models only)

To configure HDMI audio:

1. Connect an audio or video device, such as a high-definition TV, to the HDMI port.
2. Configure the default audio playback device:
 - a. Right-click the **Speakers** icon in the notification area at the far right of the taskbar.
 - b. Click **Playback devices**.
 - c. On the Playback tab, click either **Digital Output** or **Digital Output Device (HDMI)**.
 - d. Click **Set Default**.
 - e. Click **OK**.

To return audio to the computer speakers:

1. Right-click the **Speakers** icon in the notification area at the far right of the taskbar.
2. Click **Playback devices**.

3. On the Playback tab, click **Speakers**.
4. Click **Set Default**.
5. Click **OK**.

Webcam

The computer includes an integrated webcam, located at the top of the display. The webcam is an input device that captures and shares video.

To use the webcam:

1. Click the **HP MediaSmart** icon on the desktop.
2. Select the Video icon on the MediaSmart SmartMenu.
3. Click **Webcam**.

For more information on using HP MediaSmart, click **Start > Help and Support**, and type `MediaSmart` in the Search box.

For optimum webcam performance:

- If you are having trouble viewing or sending multimedia files to someone on another LAN or outside your network firewall, temporarily disable the firewall, perform the task you want to perform, and then reenable the firewall. To permanently resolve the problem, reconfigure the firewall as necessary, and then adjust the policies and settings of other intrusion detection systems.
- Whenever possible, place bright light sources behind the camera and out of the picture area.

5 Power management

Setting power options

Using power-saving states

The computer has two power-saving states enabled at the factory: Sleep and Hibernation.

When Sleep is initiated, the power lights blink and the screen clears. Your work is saved to memory, letting you exit Sleep faster than exiting Hibernation. If the computer is in the Sleep state for an extended period or if the battery reaches a critical battery level while in the Sleep state, the computer initiates Hibernation.

When Hibernation is initiated, your work is saved to a hibernation file on the hard drive and the computer turns off.

△ **CAUTION:** To prevent possible audio and video degradation, loss of audio or video playback functionality, or loss of information, do not initiate Sleep or Hibernation while reading from or writing to a disc or an external media card.

📝 **NOTE:** You cannot initiate any type of networking connection or perform any computer functions while the computer is in the Sleep state or in Hibernation.

Initiating and exiting Sleep

The system is set at the factory to initiate Sleep after 15 minutes of inactivity when running on battery power and 30 minutes of inactivity when running on external power.

Power settings and timeouts are changed using Power Options in Windows Control Panel.

To initiate Sleep while the computer is on:

- Press the Power button.
- Close the display.
- Click **Start**, click the arrow next to the Shut Down button, and then click **Sleep**.

To exit Sleep:

- Press the Power button
- If the display is closed, open the display.
- Press a key on the keyboard or button on the remote control (select models only).
- Activate the TouchPad.

When the computer exits Sleep, the Power light illuminates, and you return to the screen where you entered Sleep.

📝 **NOTE:** If a password is required when exiting Sleep, enter your Windows password at the prompt.

Initiating and exiting Hibernation

Hibernation initiates after 1,080 minutes (18 hours) of inactivity when running on both battery power and external power, or when the battery reaches a critical battery level.

Power settings and timeouts are changed using Power Options in Windows Control Panel.

To initiate Hibernation, click **Start**, click the arrow next to the Shut down button, and then click **Hibernate**.

To exit Hibernation, press the Power button. The power light illuminates, and you return to the screen where you entered Hibernation.

 **NOTE:** If a password is required when exiting Hibernation, enter your Windows password at the prompt.

Using the battery meter

The battery meter is located in the notification area at the far right of the taskbar. The battery meter allows you to quickly access power settings, view remaining battery charge, and select a different power plan.

- To display the percentage of remaining battery charge and the current power plan, move the pointer over the battery meter icon.
- To access Power Options or to change the power plan, click the Battery Meter icon, and then select an item from the list.

Different Battery Meter icons indicate whether the computer is running on battery or external power. The icons also display a message if the battery has reached a low battery level, critical battery level, or reserve battery level.

To hide or display the battery meter icon:

1. Right-click the **Show hidden icons** icon, which is the arrow at the left side of the notification area.
2. Click **Customize notification icons**.
3. Under the Behaviors column, select **Show icons and notifications** for the Power icon.
4. Click **OK**.

Using power plans

A power plan is a collection of system settings that manages how the computer uses power. Power plans can help you conserve power or maximize performance.

You can change power plan settings or create your own power plan.

Viewing the current power plan

To view to current power plan:

- Click the Battery Meter icon in the notification area at the far right of the task bar.
– or –
- Select **Start >Control Panel >System and Security >Power Options**.

Selecting a different power plan

To select a different power plan:

- Click the Battery Meter icon in the notification area at the far right of the task bar, and then select a power plan from the list.
– or –
- Select **Start >Control Panel >System and Security>Options**, and then select a power plan from the list.

Customizing power plans

To customize a power plan:

1. Click the Battery Meter icon in the notification area at the far right of the task bar, and then click **More power options**.
– or –
Select **Start > Control Panel > System and Security > Power Options**.
2. Select a power plan, and then click **Change plan settings**.
3. Change the settings as needed.
4. To change additional settings, click **Change advanced power settings**, and then make changes.

Setting password protection on wakeup

To set a password prompt when the computer exits Sleep or Hibernation:

1. Select **Start > Control Panel > System and Security > Power Options**.
2. In the left pane, click **Require a password on wakeup**.
3. Click **Change Settings that are currently unavailable**.
4. Click **Require a password (recommended)**.
5. Click **Save changes**.

Using external AC power

⚠ WARNING! To reduce potential safety issues, use only the AC adapter provided with the computer, a replacement AC adapter provided by HP, or a compatible AC adapter purchased from HP.

WARNING! Do not charge the computer battery while on board an aircraft.

External AC power is supplied through:

- An approved AC adapter
- An optional docking device or expansion product

Connect the computer to external AC power:

- When charging or calibrating a battery.
- When installing or modifying system software.
- When writing information to a CD or DVD.

When connecting to external AC power:

- The battery begins to charge.
- If the computer is turned on, the Battery Meter icon in the notification area changes appearance.

When disconnecting from external AC power:

- The computer switches to battery power.
- The display brightness is automatically decreased to save battery life. To increase display brightness, press the [Increase Screen Brightness](#) key or reconnect the AC adapter.

Connecting the AC adapter

⚠ **WARNING!** To reduce the risk of electric shock or damage to the equipment:

Connect the power cord into an AC outlet that is easily accessible at all times.

Disconnect power from the computer by disconnecting the power cord from the AC outlet (not by disconnecting the power cord from the computer).

If the power cord has a 3-pin connector, connect the cord into a grounded (earthed) 3-pin outlet. Do not disable the power cord grounding pin, for example, by attaching a 2-pin adapter. The grounding pin is an important safety feature.

To connect the computer to external AC power:

1. Connect the AC adapter to the power connector **(1)** on the computer.
2. Connect the power cord to the AC adapter **(2)**.
3. Connect the other end of the power cord to an AC outlet **(3)**.

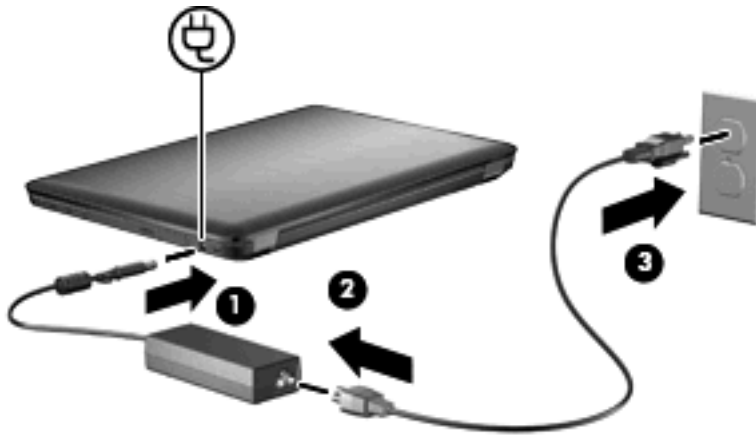

Using battery power

When a charged battery is in the computer and the computer is not connected to external power, the computer runs on battery power. When the computer is connected to external AC power, the computer runs on AC power.

If the computer contains a charged battery and is running on external AC power supplied through the AC adapter, the computer switches to battery power if the AC adapter is disconnected from the computer.

📖 **NOTE:** The display brightness is decreased to save battery life when you disconnect AC power. To increase display brightness, press the [Increase Screen Brightness](#) key or reconnect the AC adapter.

Keep a battery in the computer or in storage, depending on how you work. Keeping the battery in the computer whenever the computer is connected to AC power charges the battery and also protects your work in case of a power outage. However, a battery in the computer slowly discharges when the computer is off and disconnected from external power.

⚠ **WARNING!** To reduce potential safety issues, use only the battery provided with the computer, a replacement battery provided by HP, or a compatible battery purchased from HP.

Computer battery life varies, depending on power management settings, programs running on the computer, display brightness, external devices connected to the computer, and other factors.

Finding battery information in Help and Support

Help and Support provides the following tools and information about the battery:

- Battery Check tool to test battery performance
- Information on calibration, power management, and proper care and storage to maximize battery life
- Information on battery types, specifications, life cycles, and capacity

To access battery information, select **Start > Help and Support > Learn > Power Plans: Frequently Asked Questions**.

Using Battery Check

Help and Support provides information on the status of the battery installed in the computer.

 **NOTE:** The computer must be connected to external power for Battery Check to function properly.

To run Battery Check:

1. Connect the AC adapter to the computer.
2. Select **Start > Help and Support > Troubleshoot > Power, Thermal and Mechanical**.
3. Click the Power tab, and then click **Battery Check**.

Battery Check examines the battery and its cells to verify that they are functioning properly, and then reports the results of the examination.

Displaying the remaining battery charge

To display the remaining battery charge, move the pointer over the battery meter icon in the notification area.

Inserting or removing the battery

 **CAUTION:** Removing a battery that is the sole power source causes loss of information. To prevent loss of information, initiate Hibernation or shut down the computer through Windows before removing the battery.

To insert the battery:

1. Close the display.
2. Turn the computer upside down on a flat surface.
3. Insert the battery into the battery bay **(1)** and rotate it downward until it is seated **(2)**.

The battery release latch automatically locks the battery into place.



To remove the battery:

1. Close the display.
2. Turn the computer upside down on a flat surface.
3. Slide the battery release latch to release the battery (1).
4. Pivot the battery upward (2), and then remove the battery from the computer (3).

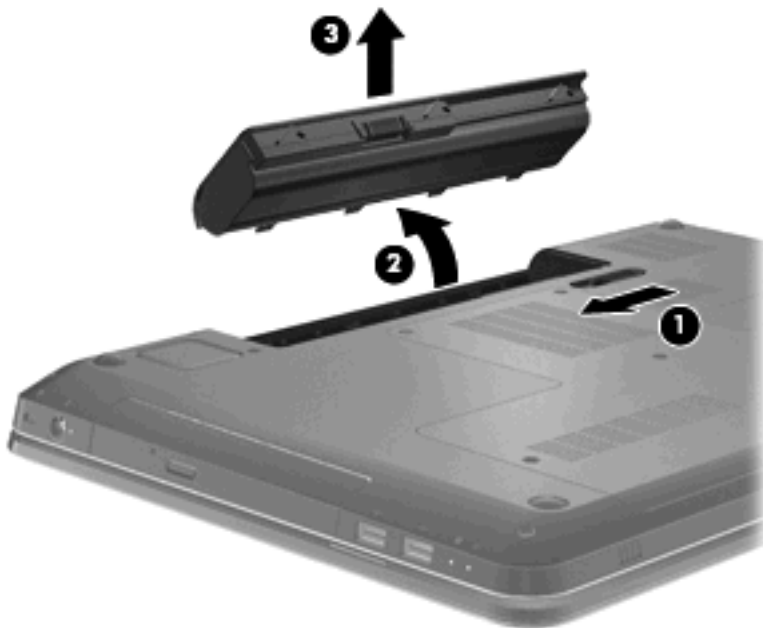

Charging a battery

⚠ WARNING! Do not charge the computer battery while on board aircraft.

The battery charges whenever the computer is plugged into external power through an AC adapter, an optional power adapter, an optional expansion product, or an optional docking device.

The battery charges whether the computer is off or in use, but it charges faster when the computer is off.

Charging might take longer if a battery is new, has been unused for two weeks or more, or is much warmer or cooler than room temperature.

To prolong battery life and optimize the accuracy of battery charge displays:

- If charging a new battery, charge it fully before turning on the computer.
- Allow the battery to discharge below five percent of a full charge through normal use before charging it.
- If the battery has been unused for one month or more, calibrate the battery instead of simply charging it.

Maximizing battery discharge time

Battery discharge time varies depending on the features used while on battery power. Maximum discharge time gradually shortens, as the battery storage capacity naturally degrades.

To maximize battery discharge time:

- Lower the brightness on the display.
- Check the Power saver setting in Power Options.
- Remove the battery from the computer when it is not being used or charged.
- Store the battery in a cool, dry location.

Managing low battery levels

The information in this section describes the alerts and system responses set at the factory. Some low-battery alerts and system responses can be changed using Power Options in Windows Control Panel. Preferences set using Power Options do not affect lights.

Identifying low battery levels

If a low battery level is not resolved, the computer enters a critical battery level.

The computer takes the following actions for a critical battery level:

- If Hibernation is enabled and the computer is on or in Sleep, the computer initiates Hibernation.
- If Hibernation is disabled and the computer is on or in Sleep, the computer remains briefly in Sleep, and then shuts down and loses any unsaved information.

Resolving a low battery level

CAUTION: To reduce the risk of losing information when the computer reaches a critical battery level and has initiated Hibernation, do not restore power until the power lights turn off.

Resolving a low battery level when external power is available

To resolve a low battery level when external power is available, connect one of the following devices:

- AC adapter
- Optional expansion product or docking device
- Optional power adapter

Resolving a low battery level when a charged battery is available

To resolve a low battery level when a charged battery is available:

1. Shut down the computer or initiate Hibernation.
2. Remove the discharged battery, and then insert a charged battery.
3. Turn on the computer.

Resolving a low battery level when no power source is available

To resolve a low battery level when no power source is available, initiate Hibernation or save your work and then shut down the computer.

Resolving a low battery level when the computer cannot exit Hibernation

To resolve a low battery level when the computer cannot exit Hibernation:

1. Insert a charged battery or connect the computer into external power.
2. Press the Power button to exit Hibernation.

Calibrating a battery

Calibrate the battery when:

- The battery charge displays seem inaccurate.
- You observe a significant change in battery run time.

A heavily used battery should only be calibrated once a month. Do not calibrate a new battery.

To calibrate the battery:

1. Fully charge the battery.

 **WARNING!** Do not charge the computer battery while on board an aircraft.

 **NOTE:** The battery charges while the computer is off or in use, but it charges faster when the computer is off.

To fully charge the battery:

- a. Insert the battery into the computer.
 - b. Connect the computer to an AC adapter, optional power adapter, optional expansion product, or optional docking device, and then connect the adapter or device to an external power source.
 - c. Leave the computer connected to external power until the battery is fully charged.
2. Disable Hibernation and Sleep. To disable Hibernation and Sleep:
- a. Click the Battery Meter icon in the notification area, and then click **More power options**.
– or –
Select **Start > Control Panel > System and Security > Power Options**.
 - b. Under the current power plan, click **Change plan settings**.
 - c. Record the Turn off the display settings listed in the On battery column so they can be reset after the calibration.
 - d. Change the Turn off the display settings to Never.
 - e. Click **Change advanced power settings**.
 - f. Click the plus sign next to Sleep, and then click the plus sign next to Hibernate after.
 - g. Record the On battery setting under Hibernate so it can be reset after the calibration.
 - h. Change the On battery setting to Never.
 - i. Click **OK**.
 - j. Click **Save changes**.
3. Discharge the battery. To discharge the battery:
- a. Disconnect the computer from the external power source, but do not shut down the computer.
 - b. Run the computer on battery power until the battery is discharged.

The computer must remain on while the battery is being discharged. The battery discharges whether or not you are using the computer, but the battery discharges faster while you are using it.

- If you plan to leave the computer unattended during the discharge, save your information before beginning the discharge procedure.
- If you use the computer occasionally during the discharge procedure and have set energy-saving timeouts, expect the following performance from the system during the discharge process:
 - The monitor does not shut down automatically.
 - The hard drive speed does not decrease automatically when the computer is idle.
 - System-initiated Hibernation does not occur.

4. Recharge the battery. To recharge the battery:
 - a. Connect the computer to external power until the battery is fully recharged.

The computer can be used while the battery is recharging, but the battery charges faster if the computer is off.
 - b. If the computer is off, turn it on when the battery is fully charged.
5. Re-enable Hibernation and Sleep. To re-enable Hibernation and Sleep:

△ **CAUTION:** Failure to re-enable Hibernation after calibration might result in a full battery discharge and information loss if the computer reaches a critical battery level.

 - a. Click the Battery Meter icon in the notification area, and then click **More power options**.

– or –

Select **Start > Control Panel > System and Security > Power Options**.
 - b. Under the current power plan, click **Change plan settings**.
 - c. Re-enter the settings that you recorded for the items in the On battery column.
 - d. Click **Change advanced power settings**.
 - e. Click the plus sign next to Sleep, and then click the plus sign next to Hibernate after.
 - f. Re-enter the setting that you recorded for On battery.
 - g. Click **OK**.
 - h. Click **Save changes**.

Conserving battery power

To conserve battery power:

- Select **Windows Control Panel > System and Security > Power Options > Power Saver power plan**.
- Shut down wireless and local area network (LAN) connections and exit modem applications when you are not using them.
- Disconnect external devices that are not connected to an external power source when you are not using them.
- Stop, disable, or remove any external media cards that you are not using.
- Press the [Decrease Screen Brightness](#) key or [Increase Screen Brightness](#) key to adjust screen brightness as needed.
- If leaving your work, initiate Sleep or Hibernation, or shut down the computer.

Storing a battery

-
- △ **CAUTION:** To prevent damage to a battery, do not expose it to high temperatures for extended periods of time.
-

If a computer is unused and disconnected from external power for more than 2 weeks, remove the battery and store it separately.

To prolong the charge of a stored battery, place it in a cool, dry place.

 **NOTE:** Check a stored battery every six months. If the capacity is less than 50 percent, recharge the battery before returning it to storage.

Calibrate a battery before using it if it has been stored for one month or more.

Disposing of a used battery

 **WARNING!** To reduce the risk of fire or burns, do not disassemble, crush, or puncture the battery. Do not short external contacts. Do not dispose of the battery in fire or water.

For more information, see the *Regulatory, Safety and Environmental Notices* included with this computer.

Replacing the battery

Computer battery life varies, depending on power management settings, programs running on the computer, display brightness, external devices connected to the computer, and other factors.

Battery Check notifies you to replace the battery when an internal cell is not charging properly, or when the battery storage capacity has reached a weak condition. A message refers you to the HP website for more information about ordering a replacement battery. If the battery is covered by an HP warranty, instructions include a warranty ID.

 **NOTE:** HP recommends purchasing a new battery when the storage capacity light illuminates green-yellow.

Switching between graphics modes (select models only)

The computer is equipped with switchable graphics and has two modes for processing graphics. When switching from AC power to battery power, the computer switches from High-performance mode to Power-saving mode to conserve battery life. Similarly, when switching from battery power to AC power, the computer switches back to the High-performance mode.

 **NOTE:** In order to optimize computer performance, the system might not allow switching modes, or prompt you to switch modes. It might be necessary to close all programs before switching.

NOTE: HDMI only works in the High-performance mode. HDMI cannot be used in Power-saving mode.

When switching between AC and battery power, you are notified that the computer is about to switch graphics modes. If you prefer, choose to continue using the same graphics mode. While the computer switches modes, the screen goes blank for a few seconds. When the switch is complete, a notification appears in the notification area, and the screen image reappears.

 **NOTE:** When select computer models are in slate mode, the screen orientations are reset when switching between graphics modes.

To determine which graphics mode you are using, right-click on the Windows desktop, and then click **Configure Switchable Graphics** or **Configure ATI PowerXpress™**.

Shutting down the computer

 **CAUTION:** Unsaved information is lost when the computer shuts down.

 **NOTE:** If the computer is in the Sleep or in Hibernation, exit Sleep or Hibernation before shutting down.

The shut down command closes all open programs, including the operating system, and then turns off the display and computer.

Shut down the computer when:

- Replacing the battery or accessing components inside the computer.
- Connecting an external hardware device that does not connect to a USB port.
- Disconnecting from external power for an extended period.

Although the computer can be shut down with the Power button, HP recommends using the Windows shut down command.

To shut down the computer:

1. Save your work, and close all open programs.
2. Click **Start**.
3. Click **Shut down**.

If the computer is unresponsive and you are unable to use the recommended shutdown procedures, try the following emergency procedures:

1. Press **ctrl+alt+delete**, and then press the Power button.
2. Press and hold the Power button for at least five seconds.
3. Disconnect the computer from external power, and remove the battery.

6 Drives

Handling drives

Drives are fragile computer components that must be handled with care. Adhere to the following cautions before handling drives:

- △ **CAUTION:** To reduce the risk of damage to the computer, damage to a drive, or loss of information:
 - Before moving a computer that is connected to an external hard drive, initiate Sleep and allow the screen to clear, or properly disconnect the external hard drive.
 - Before handling a drive, discharge static electricity by touching the unpainted metal surface of the drive.
 - Do not touch the connector pins on a removable drive or on the computer.
 - Handle a drive carefully. Do not drop a drive or place items on it.
 - Before removing or inserting a drive, shut down the computer. If you are unsure whether the computer is off, in Sleep, or in Hibernation, turn on the computer and then shut it down through the operating system.
 - Do not use excessive force when inserting a drive into a drive bay.
 - Do not type on the keyboard or move the computer while the optical drive is writing to a disc. The write process is sensitive to vibration.
 - When the battery is the only source of power, be sure that the battery is sufficiently charged before writing to media.
 - Avoid exposing a drive to temperature or humidity extremes.
 - Avoid exposing a drive to liquids. Do not spray the drive with cleaning products.
 - Remove media from a drive before removing the drive from the drive bay, or traveling with, shipping, or storing a drive.
 - If a drive must be mailed, place the drive in a bubble-pack mailer or other suitable protective packaging and label the package “FRAGILE.”
 - Avoid exposing a drive to magnetic fields. Security devices with magnetic fields include airport walk-through devices and security wands. The airport security devices that check carry-on luggage, such as conveyor belts, use x-rays instead of magnetism and do not damage a drive.

Optical drive

The computer includes an optical drive that expands the functionality of the computer. The optical drive allows you to read data discs, play music, and watch movies. If the computer includes a Blu-ray Disc (BD) ROM Drive, then high-definition video can also be watched.

Identifying the installed optical drive

To identify an optical drive:

1. Select **Start > Computer**.

A list of all the drives installed in the computer appears.

2. Identify the optical drive installed in the computer. Optical drives that might be installed in the computer include:

 **NOTE:** Some drives might not be supported by the computer.

- LightScribe DVD±RW/R and CD-RW Combo drive with Double-Layer (DL) support
- Blu-ray ROM DVD+/-RW SuperMulti DL Drivet
- Blu-ray ROM with LightScribe DVD+/-RW SuperMulti DL Drive

Using optical discs

 **CAUTION:** To prevent audio and video degradation, loss of information, or loss of audio or video playback functionality, do not initiate Sleep or Hibernation while reading or writing to a CD or DVD.

An optical drive, such as a DVD-ROM drive, supports optical discs (CDs and DVDs). These discs store information, such as music, photos, and movies. If the optical drive is a Blu-ray Disc ROM Drive, it also reads Blu-ray Discs.

 **NOTE:** Some drives listed might not be supported by the computer.

Optical drive type	Write to CD-RW	Write to DVD±RW/R	Write to DVD+RW DL	Write label to LightScribe CD or DVD ±RW/R
SuperMulti LightScribe DVD±RW and CD-RW Combo with DL support	Yes	Yes	Yes	Yes
Blu-ray ROM with LightScribe DVD+/-RW SuperMulti DL Drive	Yes	Yes	Yes	Yes
Blu-ray ROM DVD+/-RW SuperMulti DL Drivet	Yes	Yes	Yes	No

Selecting the right disc (CDs, DVDs, and BDs)

CDs, used to store digital data, are also used for commercial audio recordings and are convenient for your personal storage needs. DVDs and BDs are used primarily for movies, software, and data backup purposes. DVDs and BDs are the same form factor as CDs, but have a much higher storage capacity.

 **NOTE:** The optical drive might not support all types of optical discs.

CD-R discs

CD-R (write-once) discs are widely used for creating a permanent copy of data that can be shared as needed. Typical uses include the following:

- Distributing large presentations
- Sharing scanned and digital photos, video clips, and written data
- Making your own music CDs
- Keeping permanent archives of computer files and scanned home records
- Offloading files from your hard drive to free up disk space

CD-RW discs

Use CD-RW discs (a rewritable version of a CD) to store large projects that must be updated frequently. Typical uses include:

- Developing and maintaining large documents and project files
- Transporting work files
- Making weekly backups of hard drive files
- Updating photos, video, audio, and data continuously

DVD±R discs

Use DVD±R discs to permanently store large amounts of information. After data is recorded, it cannot be erased or written over.

DVD±RW discs

Use DVD±RW discs to erase or write over data that you saved earlier. This type of disc is ideal for testing audio or video recordings before burning them to a CD or DVD that cannot be changed.

LightScribe DVD+R discs

Use LightScribe DVD+R discs for sharing and storing data, home videos, and photos. These discs are read-compatible with most DVD-ROM drives and DVD video players. With a LightScribe-enabled drive and LightScribe software, write data to the disc, and then add a designer label to the outside of the disc.

Blu-ray discs (BD)

 **NOTE:** Blu-ray is a new format containing new technologies. Certain disc, digital connection, compatibility, and/or performance issues might arise, and do not constitute defects in the product. Flawless playback on all systems is not guaranteed.

BD is a high-density optical disc format for the storage of digital information, including high-definition video. A single-layer Blu-ray disc stores 25 GB, over five times the storage capacity of a single-layer 4.7 GB DVD. A dual-layer Blu-ray Disc stores 50 GB, almost six times the storage capacity of an 8.5 GB dual-layer DVD.

Typical uses include:

- Storage of large amounts of data
- High-definition video playback and storage
- Video games

Playing a CD, DVD, or BD

To play an optical disc:

1. Turn on the computer.
2. Press the release button (1) on the drive bezel to release the disc tray.
3. Pull out the tray (2).
4. Hold the disc by the edges to avoid touching the flat surfaces and position the disc label-side up over the tray spindle.

 **NOTE:** If the tray is not fully accessible, tilt the disc carefully to position it over the spindle.

5. Gently press the disc (3) down onto the tray spindle until the disc snaps into place.
6. Close the disc tray.

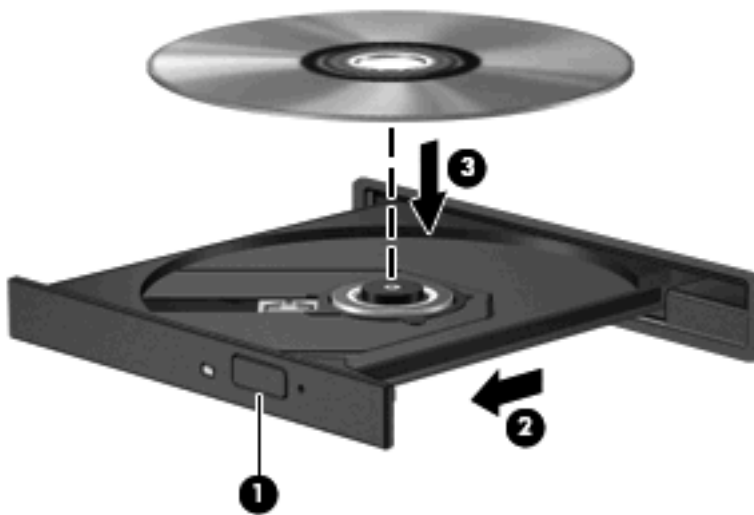

If you have not configured AutoPlay, an AutoPlay dialog box appears. You are prompted to select how you want to use the media content. For more information, see [Configuring AutoPlay](#).

 **NOTE:** For best results, be sure that the AC adapter is connected to an external power source while playing a BD.

Configuring AutoPlay

To configure AutoPlay:

1. Select **Start > Default Programs > Change AutoPlay settings**.
2. Confirm that the Use AutoPlay for all media and devices check box is selected.
3. Click **Choose a default**, and then select one of the available options for each media type listed.

 **NOTE:** Choose HP MediaSmart to play DVDs.

4. Click **Save**.

For more information about AutoPlay, see [Help and Support](#).

Changing DVD region settings

△ **CAUTION:** The region settings on the DVD drive can be changed five times.

The region setting selected the fifth time becomes the permanent region setting on the DVD drive.

The number of region changes remaining is displayed on the DVD Region tab.

Most DVDs containing copyrighted files also contain region codes. The region codes help protect copyrights internationally.

Play a DVD containing a region code only if the region code on the DVD matches the region setting on your DVD drive.

To change region settings through the operating system:

1. Select **Start > Control Panel > System and Security**.
2. In the System area, click **Device Manager**.

 **NOTE:** Windows includes the User Account Control feature to improve security of the computer. You might be prompted for your permission or password for tasks such as installing software, running utilities, or changing Windows settings. For more information, see Windows Help and Support.

3. Expand the DVD/CD-ROM drives to show all of the installed drives.
4. Right-click the DVD drive where you want to change region settings, and then click **Properties**.
5. Click the **DVD Region** tab, and change the settings.
6. Click **OK**.

Observing the copyright warning

It is a criminal offense, under applicable copyright laws, to make unauthorized copies of copyright-protected material, including computer programs, films, broadcasts, and sound recordings. Do not use this computer for such purposes.

△ **CAUTION:** To prevent loss of information or damage to a disc:

Before writing to a disc, connect the computer to a reliable external power source. Do not write to a disc while the computer is running on battery power.

Before writing to a disc, close all open programs except the disc software you are using.

Do not copy directly from a source disc to a destination disc or from a network drive to a destination disc. Save the information to the hard drive, and then burn from the hard drive to the destination disc.

Do not use the computer keyboard or move the computer while the computer is writing to a disc. The write process is sensitive to vibration.

For details about using software included with the computer, see the software manufacturer's instructions, which might be provided on disc, in the software Help, or on the manufacturer's website.

Copying a CD or DVD

To copy a CD or DVD:

1. Select **Start > All Programs > CyberLink DVD Suites > Power2Go**.
2. Insert the disc you want to copy into the optical drive.
3. Click **Copy** at the bottom right of the screen.

Power2Go reads the source disc and copies the data to a temporary folder on the hard drive.

4. When prompted, remove the source disc from the optical drive, and then insert a blank disc into the drive.

After the information is copied, the disc created ejects automatically.

Creating (burning) a CD or DVD

- △ **CAUTION:** Observe the copyright warning. It is a criminal offense, under applicable copyright laws, to make unauthorized copies of copyright-protected material, including computer programs, films, broadcasts, and sound recordings. Do not use this computer for such purposes.

If the computer includes a CD-RW, DVD-RW, or DVD±RW optical drive, use software such as Windows Media Player or CyberLink Power2Go to burn data, video, and audio files, including MP3 and WAV music files.

Observe the following guidelines when burning a CD or DVD:

- Before burning a disc, save and close any open files and close all programs.
- A CD-R or DVD-R is best for burning audio files because after the information is copied, it cannot be changed.



NOTE: An audio DVD cannot be created with CyberLink Power2Go.

- Use CD-Rs to burn music CDs, because some home and car stereos do not play CD-RWs.
- A CD-RW or DVD-RW is generally best for burning data files or for testing audio or video recordings before burning them to a CD or DVD that cannot be changed.
- DVD players used in home systems do not support all DVD formats. For a list of supported formats, see the user guide that came with the DVD player.
- An MP3 file uses less space than other music file formats, and the process for creating an MP3 disc is the same as the process for creating a data file. MP3 files play on MP3 players or on computers with MP3 software installed.

To burn a CD or DVD:

1. Download or copy the source files into a folder on the hard drive.
2. Insert a blank CD or DVD into the optical drive.
3. Select **Start > All Programs**, and then select the name of the software you want to use.



NOTE: Some programs might be located in subfolders.

4. Select the kind of CD or DVD you want to create—data, audio, or video.
5. Right-click **Start**, click **Open Windows Explorer**, and navigate to the folder where the source files are stored.
6. Open the folder, and then drag and drop the files into the drive that contains the blank optical disc.
7. Initiate the burning process as directed by the program selected.

For specific instructions, see the software manufacturer's instructions, which might be provided with the software, on disc, or on the manufacturer's website.

Removing a CD, DVD, or BD



To remove an optical disc:

1. Press the release button on the drive bezel to release the disc tray (1).
2. Gently pull out the tray until it stops (2).
3. Remove the disc from the tray by gently pressing down on the spindle while lifting the outer edges of the disc (3). Hold the disc by the edges and avoid touching the flat surfaces.

 **NOTE:** If the tray is not fully accessible, tilt the disc carefully as you remove it.

4. Close the disc tray, and then place the disc in a protective case.

Using external drives

Removable external drives expand storing options and information access. A USB mouse can be connected to the system using the ports on an optional docking device or optional expansion product.

USB drives include:

- 1.44-megabyte diskette drive
- Hard drive module (a hard drive with an adapter attached)
- DVD-ROM Drive
- DVD/CD-RW Combo Drive
- DVD±RW and CD-RW Combo Drive

For more information about required software and drivers or to learn which computer port to use, see the manufacturer's instructions.

To connect an external drive to the computer:

△ **CAUTION:** To reduce the risk of damage to the equipment when connecting a powered drive, be sure that the AC power cord is disconnected.

1. Connect the drive to the computer.
2. If connecting a powered drive, connect the drive power cord to a grounded AC outlet.

To disconnect a powered drive:

1. Disconnect the drive from the computer.
2. Disconnect the AC power cord.

Improving hard drive performance

Using Disk Defragmenter

As you use the computer, files on the hard drive become fragmented. Disk Defragmenter consolidates the fragmented files and folders on the hard drive so that the system runs more efficiently.

After starting Disk Defragmenter, it works without supervision. Depending on the size of the hard drive and the number of fragmented files, Disk Defragmenter might take more than an hour to complete. Set it to run during the night or another time when you do not need access to the computer.

HP recommends defragmenting the hard drive at least once a month. Set Disk Defragmenter to run on a monthly schedule, but the computer can be defragmented manually at any time.

To run Disk Defragmenter:

1. Select **Start > All Programs > Accessories > System Tools > Disk Defragmenter**.
2. Click **Defragment disk**.

 **NOTE:** Windows includes the User Account Control feature to improve the security of the computer. You might be prompted for your permission or password for tasks such as installing software, running utilities, or changing Windows settings. For more information, see Help and Support.

For more information, see the Disk Defragmenter software Help.

Using Disk Cleanup

Disk Cleanup searches the hard drive for unnecessary files that, when safely deleted, free up disk space and help the computer to run more efficiently.

To run Disk Cleanup:

1. Select **Start > All Programs > Accessories > System Tools > Disk Cleanup**.
2. Follow the on-screen instructions.

Replacing a drive in the primary hard drive bay

△ **CAUTION:** To prevent information loss or an unresponsive system:

Shut down the computer before removing the hard drive from the hard drive bay. Do not remove the hard drive while the computer is on or in Sleep or Hibernation.

If you are not sure whether the computer is off or in Hibernation, turn on the computer by pressing the Power button, and then shut down the computer through the operating system.

To remove the primary hard drive:

1. Save your work.
2. Shut down the computer and close the display.
3. Disconnect all external hardware devices connected to the computer.

4. Disconnect the power cord from the AC outlet.
5. Turn the computer upside down on a flat surface, with the hard drive bay toward you.
6. Remove the battery from the computer.
7. Remove the five hard drive cover screws (1).
8. Lift the hard drive cover away from the computer (2).

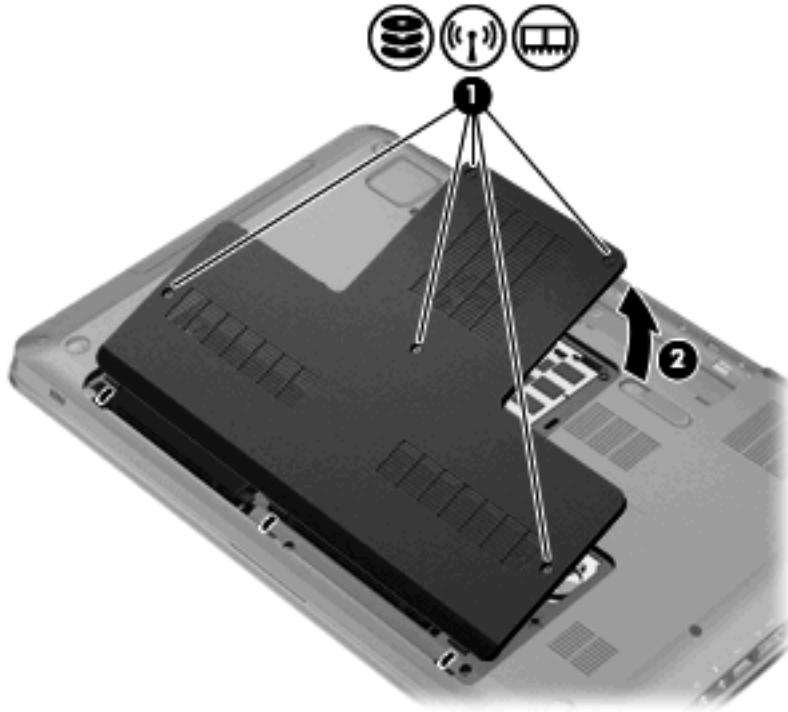

9. Disconnect the hard drive cable connector from the system board (1).
10. Remove the four hard drive screws (2).

11. Remove the hard drive vertically (3) from the computer.

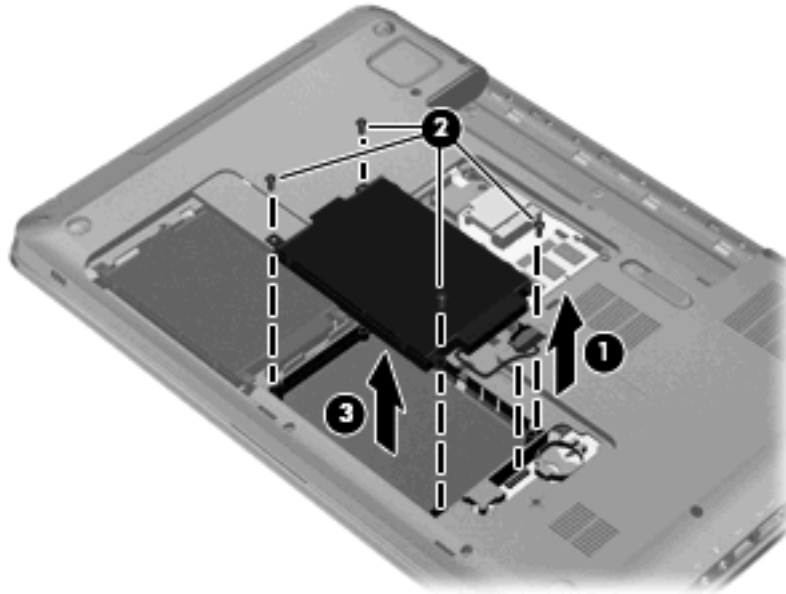

To install the primary hard drive:

1. Insert the hard drive into the hard drive bay (1).
2. Tighten the four hard drive screws (2).
3. Connect the hard drive cable to the hard drive connector on the system board (3).

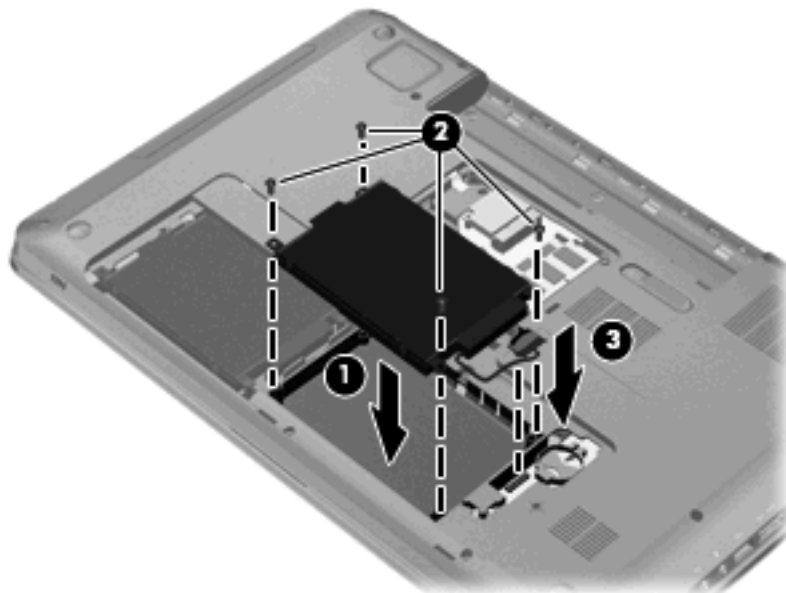

4. Align the tabs on the hard drive cover with the notches on the computer (1).
5. Close the cover (2).

6. Tighten the hard drive cover screws (3).

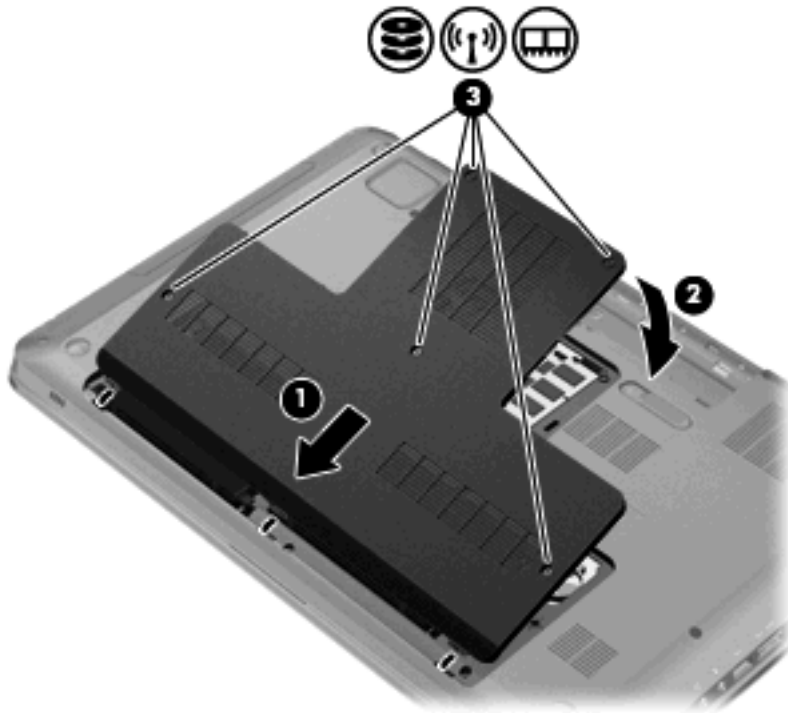

7. Replace the battery.
8. Turn the computer right-side up, and then reconnect external power and external devices.
9. Turn on the computer.

Replacing a drive in the secondary hard drive bay

△ **CAUTION:** To prevent information loss or an unresponsive system:

Shut down the computer before removing the hard drive from the hard drive bay. Do not remove the hard drive while the computer is on or in Sleep or Hibernation.

If you are not sure whether the computer is off or in Hibernation, turn on the computer by pressing the Power button, and then shut down the computer through the operating system.

The computer is equipped with a secondary hard drive bay. This bay might be empty or occupied by a secondary hard drive.

To remove the secondary hard drive:

1. Save your work.
2. Shut down the computer and close the display.
3. Disconnect all external hardware devices connected to the computer.
4. Disconnect the power cord from the AC outlet.
5. Turn the computer upside down on a flat surface, with the hard drive bay toward you.
6. Remove the battery from the computer.
7. Remove the five hard drive cover screws (1).

8. Lift the hard drive cover away from the computer (2).

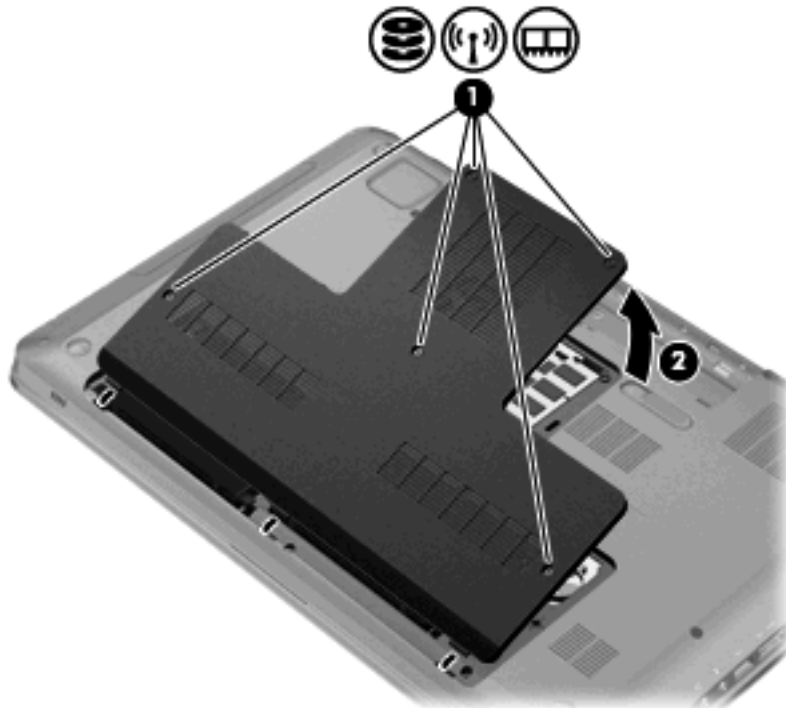

9. Disconnect the hard drive cable connector from the system board (1).
10. Remove the four hard drive screws (2).
11. Remove the hard drive vertically (3) from the computer.

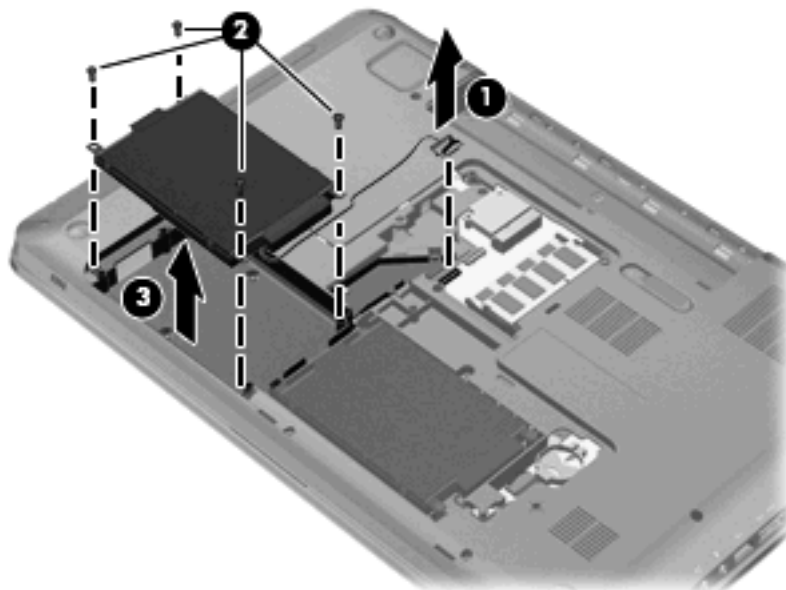

To install the secondary hard drive:

1. Insert the hard drive into the hard drive bay (1).
2. Tighten the four hard drive screws (2).

3. Connect the hard drive cable to the hard drive connector on the system board (3).

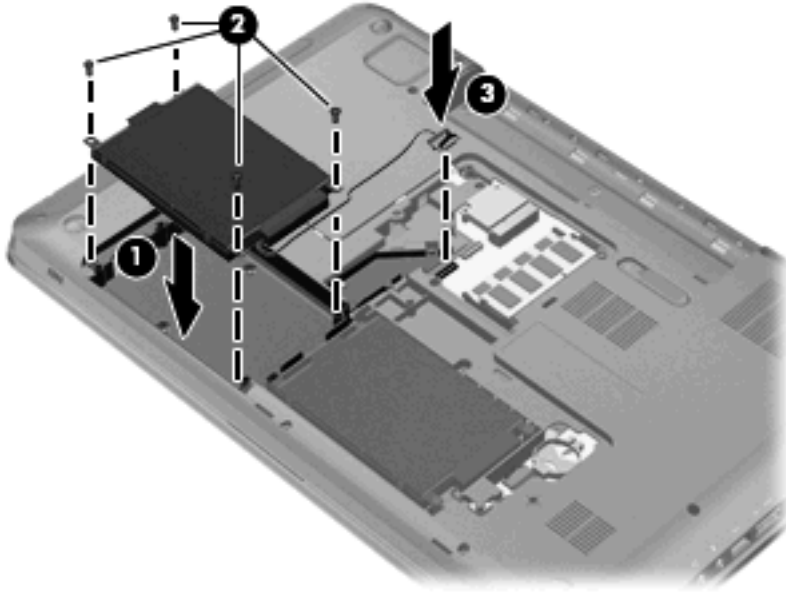

4. Align the tabs on the hard drive cover with the notches on the computer (1).
5. Close the cover (2).
6. Tighten the hard drive cover screws (3).

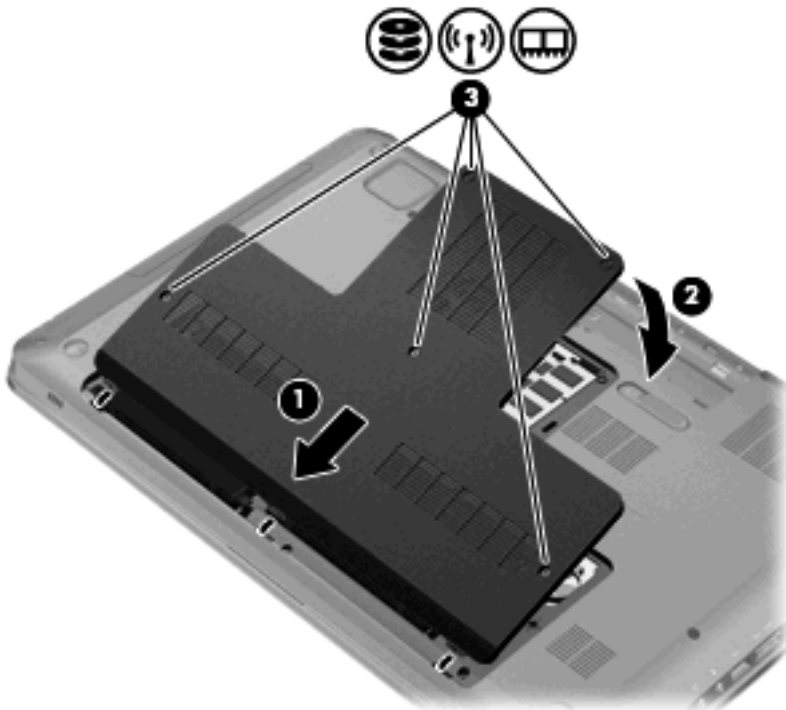

7. Replace the battery.
8. Turn the computer right-side up, and then reconnect external power and external devices.
9. Turn on the computer.

7 External devices

Using a USB device

A USB port connects an optional external device, such as a USB keyboard, mouse, drive, printer, scanner, or hub, to the computer or to an optional expansion product.

Some USB devices might require additional support software, which is usually included with the device. For more information about device-specific software, see the manufacturer's instructions.

The computer has 3 USB ports, which support USB 1.0, USB 1.1, and USB 2.0 devices. To add more USB ports, connect an optional hub or optional expansion product.

Connecting a USB device

△ **CAUTION:** To prevent damage to a USB connector, use minimal force to connect a USB device.

To connect a USB device to the computer, connect the USB cable for the device to the USB port.



A sound alerts you when the USB device is detected.

📄 **NOTE:** The first time a USB device is connected, the Installing device driver software message displays in the notification area at the far right of the taskbar.

Removing a USB device

△ **CAUTION:** To prevent loss of information or an unresponsive system, adhere to the instructions in “Removing a USB device.”

CAUTION: To prevent damage to a USB connector, do not pull on the cable to remove the USB device.

To remove a USB device:

1. Click the **Safely Remove Hardware and Eject Media** icon in the notification area at the far right of the taskbar.

To display the Safely Remove Hardware and Eject Media icon, click the **Show hidden icons** icon, which is the arrow at the left of the notification area.

2. Click the name of the device in the list.

You are prompted that it is safe to remove the device.

3. Remove the device.

Using an eSATA device

An eSATA port connects an optional high-performance eSATA component, such as an eSATA external hard drive.

Some eSATA devices might require additional support software, which is usually included with the device. For more information about device-specific software, see the software manufacturer's instructions. These instructions are provided with the software, on disk, in the software Help, or on the manufacturer's website.

 **NOTE:** The eSATA port also supports an optional USB device.

Connecting an eSATA device

- △ **CAUTION:** To prevent damage to an eSATA port connector, use minimal force to connect an eSATA device.

To connect an eSATA device to the computer, connect the eSATA cable for the device to the eSATA port.

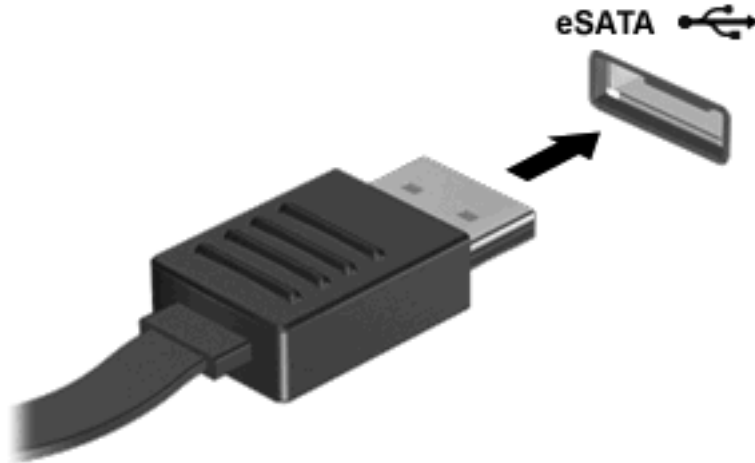

A sound alerts you that the device is connected to the computer.

Removing an eSATA device

- △ **CAUTION:** To prevent loss of information or an unresponsive system, adhere to the instructions in “Removing an eSATA device.”

CAUTION: To prevent damage to an eSATA connector, do not pull on the cable to remove the eSATA device.

To remove an eSATA device:

1. Click the **Safely Remove Hardware and Eject Media** icon in the notification area at the far right of the taskbar.
To display the Safely Remove Hardware and Eject Media icon, click the **Show hidden icons** icon, which is the arrow at the left of the notification area.
2. Click the name of the device in the list.
You are prompted that it is safe to remove the device.
3. Remove the device.

8 External media cards

Using Digital Media Slot cards

Optional digital cards provide secure data storage and convenient data sharing. These cards are used with digital media-equipped cameras and PDAs, as well as with other computers.

The Digital Media Slot supports the following digital card formats:

- Memory Stick (MS)
- Memory Stick Pro (MSP)
- MultiMediaCard (MMC)
- Secure Digital (SD) Memory Card
- Secure Digital High Capacity (SDHC) Memory Card
- xD-Picture Card (XD)
- xD-Picture Card (XD) Type H
- xD-Picture Card (XD) Type M

Inserting a digital card

△ **CAUTION:** To avoid damaging the digital card or the computer, do not insert any adapter into the Digital Media Slot.

CAUTION: To prevent damage to the digital card connectors, use minimal force to insert a digital card.

1. Hold the digital card label-side up, with the connectors facing the computer.
2. Insert the card into the Digital Media Slot, and then push in on the card until it is firmly seated.

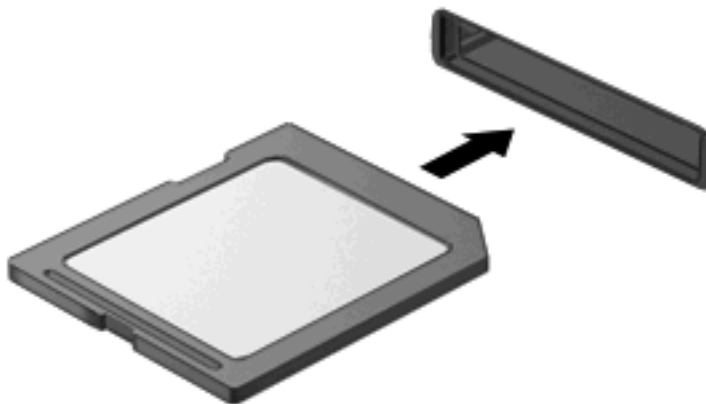

A sound alerts you when a device is detected, and a menu of options appears.

Removing a digital card

△ **CAUTION:** To prevent loss of data or an unresponsive system, adhere to the instructions in “Removing a digital card.”

📄 **NOTE:** To stop a data transfer, click **Cancel** in the operating system Copying window.

To remove a digital card:

1. Save all information and close all programs associated with the digital card.
2. Click the **Safely Remove Hardware and Eject Media** icon in the notification area at the far right of the taskbar.

To display the Safely Remove Hardware and Eject Media icon, click the **Show hidden icons** icon, which is the arrow at the left side of the notification area.

3. Click the name of the digital card in the list.

You are prompted that it is safe to remove the hardware device.

4. Press in on the digital card (**1**), and then remove the card from the slot (**2**).

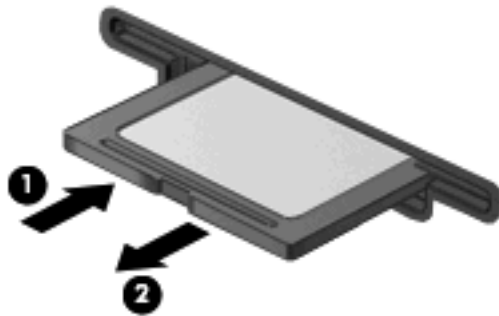

9 Memory modules

The computer has one memory module compartment, which is located on the bottom of the computer. The memory capacity of the computer is upgraded by adding a memory module to the vacant expansion memory module slot or by upgrading the existing memory module in the primary memory module slot.

- ⚠ **WARNING!** To reduce the risk of electric shock and damage to the equipment, disconnect the power cord and remove all batteries before installing a memory module.
- ⚠ **CAUTION:** Electrostatic discharge (ESD) damages electronic components. Before beginning any procedure, be sure that you are discharged of static electricity by touching a grounded metal object.
- 📖 **NOTE:** To use a dual-channel configuration when adding a second memory module, be sure that both memory modules are the same size.

To add or replace a memory module:

1. Save your work.
2. Shut down the computer, and close the display.
If you are not sure whether the computer is off or in Hibernation, turn on the computer by pressing the Power button, and then shut down the computer through the operating system.
3. Disconnect all external devices connected to the computer.
4. Disconnect the power cord from the AC outlet.
5. Turn the computer upside down on a flat surface.
6. Remove the battery from the computer.
7. Remove the five memory module compartment screws **(1)**.

8. Lift the memory module compartment cover (2) away from the computer.

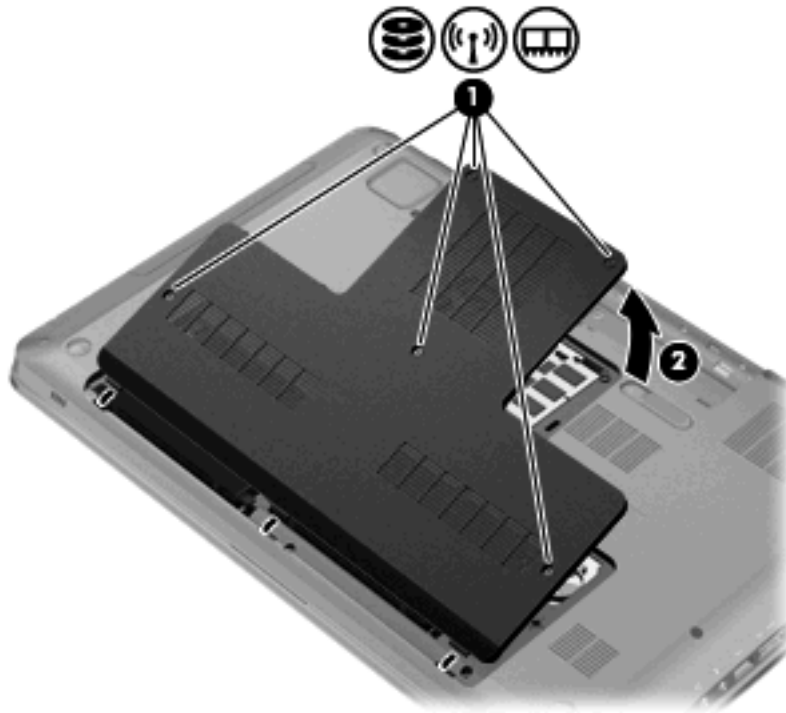

9. If replacing a memory module, remove the existing memory module by:
 - a. Pulling away the retention clips (1) on each side of the memory module.
The memory module tilts up.

△ **CAUTION:** To prevent damage to the memory module, hold the memory module by the edges only. Do not touch the components on the memory module.

- b. Grasping the edge of the memory module (2), and gently pulling the module out of the memory module slot.

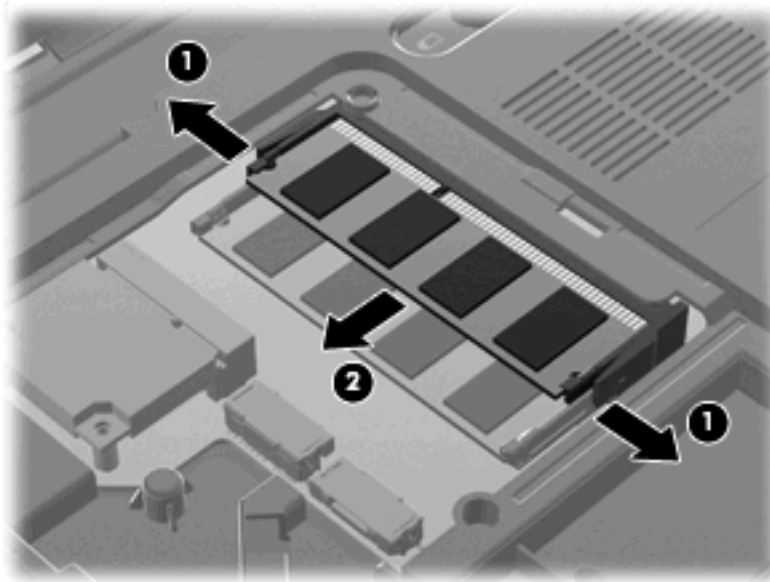

To protect a memory module after removal, place it in an electrostatic-safe container.

10. Insert a new memory module by:

CAUTION: To prevent damage to the memory module, hold the memory module by the edges only. Do not touch the components on the memory module, and do not bend the memory module.

- Aligning the notched edge (1) of the memory module with the tab in the memory module slot.
- With the memory module at a 45-degree angle from the surface of the memory module compartment, pressing the module (2) into the memory module slot until it is seated.
- Gently pressing the memory module (3) down, applying pressure to both the left and right edges of the memory module, until the retention clips snap into place.

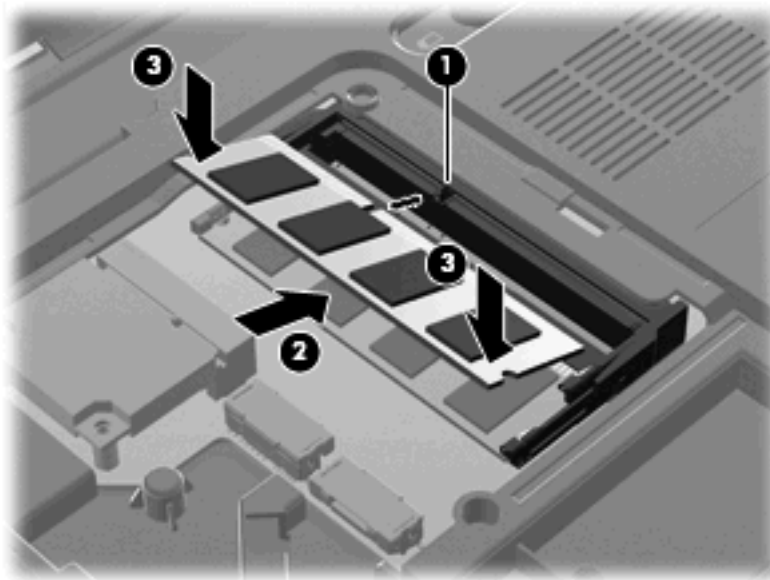

11. Align the tabs (1) on the memory module compartment cover with the notches on the computer.

12. Close the cover (2).
13. Tighten the five memory module compartment screws (3).

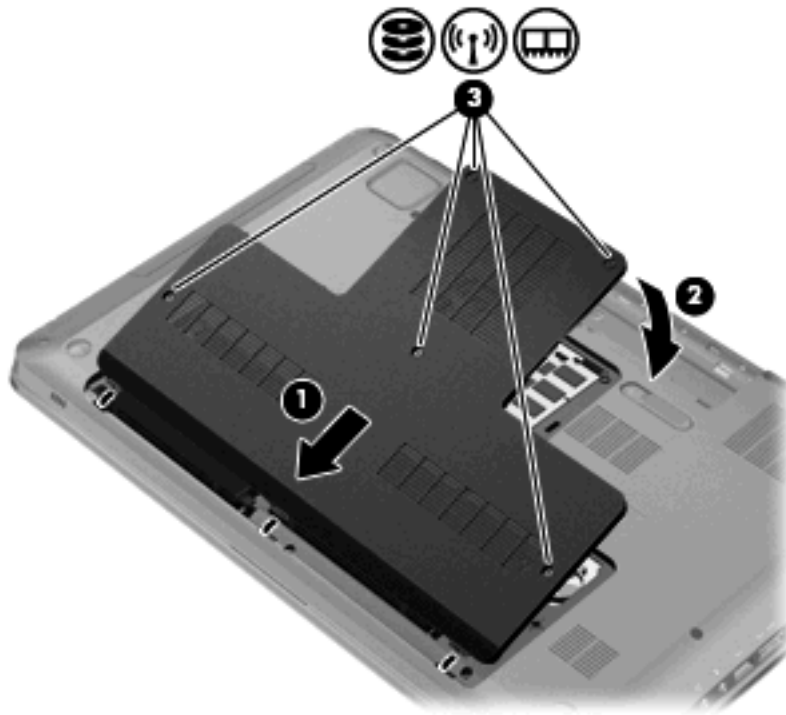

14. Replace the battery.
15. Turn over the computer.
16. Connect external devices to the computer.
17. Connect the computer to AC power.
18. Turn on the computer.

10 Security

Protecting the computer

Standard security features provided by the Windows operating system and the non-Windows Setup Utility protect your personal settings and data from a variety of risks.

Follow the procedures in this guide to use:

- Passwords
- Antivirus software
- Firewall software
- Critical security updates
- Optional security cable
- Fingerprint Reader (select models only)

 **NOTE:** Security solutions are designed to act as deterrents, but they might not deter software attacks or prevent the computer from being mishandled or stolen.

NOTE: Before sending the computer for service, remove all password and fingerprint settings.

Computer risk	Security feature
Unauthorized use of the computer	Power-on password
Computer viruses	Norton Internet Security software
Unauthorized access to data	<ul style="list-style-type: none">• Firewall software• Windows updates
Unauthorized access to Setup Utility, BIOS settings, and other system identification information	Administrator password
Ongoing or future threats to the computer	Critical security updates from Microsoft®
Unauthorized access to a Windows user account	User password
Unauthorized removal of the computer	Security cable slot (used with an optional security cable)

Using passwords

A password is a group of characters that you choose to secure computer information. Several types of passwords can be set, depending on how you want to control access to your information. Passwords are set in Windows or in the non-Windows Setup Utility preinstalled on the computer.

△ **CAUTION:** To prevent being locked out of the computer, record each password set. Because most passwords are not displayed as they are set, changed, or deleted, it is essential to record each password immediately and store it in a secure place.

Use the same password for a Setup Utility feature and for a Windows security feature, and the same password can be used for more than one Setup Utility feature.

To setup a password in Setup Utility:

- Combine up to 8 letters and numbers. Passwords are case sensitive.
- Enter the password at the Setup Utility prompt. A password set in Windows must be entered at a Windows prompt.

To safely create and save passwords:

- Follow requirements set by the program.
- Write down your passwords and store them in a secure place away from the computer.
- Do not store passwords in a file on the computer.
- Do not use your name or other personal information that can easily be discovered by an outsider.

For additional information about Windows passwords, such as screen-saver passwords, select **Start > Help and Support**.

Setting passwords in Windows

Password	Function
Administrator password	Protects administrator-level access to computer contents. NOTE: This password cannot be used to access Setup Utility contents.
User password	Protects access to a Windows user account. It also protects access to the computer contents and must be entered when you exit Sleep or Hibernation.

Setting passwords in Setup Utility

Password	Function
Administrator password	<ul style="list-style-type: none">• Protects access to Setup Utility.• After this password is set, it is entered each time you access Setup Utility. CAUTION: If you forget your administrator password, Setup Utility cannot be accessed.
Power-on password	<ul style="list-style-type: none">• Protects access to the computer contents.• After this password is set, it must be entered each time you turn on or restart the computer, or exit Hibernation. CAUTION: If you forget your power-on password, the computer cannot be turned on or restarted, or exit Hibernation.

For details about passwords, see Administrator password or Power-on password.

Administrator password

Your administrator password protects the configuration settings and system identification information in Setup Utility. After this password is set, you must enter it each time you access Setup Utility.

Your administrator password is not interchangeable with an administrator password set in Windows, nor is it displayed as it is set, entered, changed, or deleted. Be sure that you record your password and store it in a safe place.

Managing an administrator password

To set, change, or delete this password:

1. Open Setup Utility by turning on or restarting the computer. When the Press the ESC key for Startup Menu message appears in the lower left corner of the screen, press the **f10** key.

– or –

Open Setup Utility by turning on or restarting the computer. When the Press the ESC key for Startup Menu message appears in the lower left corner of the screen, press the **esc** key. When the Startup Menu appears, press the **f10** key.

2. Use the arrow keys to select **Security > Set Administrator Password**, and then press **enter**.
 - To set an administrator password, type your password in the Enter New Password and Confirm New Password fields, and then press the **enter** key.
 - To change an administrator password, type your current password in the Enter Current Password field, type a new password in the Enter New Password and Confirm New Password fields, and then press the **enter** key.
 - To delete an administrator password, type your current password in the Enter Password field, and then press the **enter** key four times.
3. To save your changes and exit Setup Utility, use the arrow keys to select **Exit > Exit Saving Changes**.

Changes go into effect when the computer restarts.

Entering an administrator password

At the Enter Password prompt, type your administrator password, and then press the **enter** key. After three unsuccessful attempts to enter the administrator password, restart the computer and try again.

Power-on password

Your power-on password prevents unauthorized use of the computer. After this password is set, it must be entered each time you turn on or restart the computer, or exit Hibernation. A power-on password is not displayed as it is set, entered, changed, or deleted.

Managing a power-on password

To set, change, or delete the power-on password:

1. Open Setup Utility by turning on or restarting the computer. When the Press the ESC key for Startup Menu message appears in the lower left corner of the screen, press the **f10** key.
– or –
Open Setup Utility by turning on or restarting the computer. When the Press the ESC key for Startup Menu message appears in the lower left corner of the screen, press the **esc** key. When the Startup Menu appears, press the **f10** key.
2. Use the arrow keys to select **Security > Set Power-On Password**, and then press the **enter** key.
 - To set a power-on password, type your password in the Enter New Password and Confirm New Password fields, and then press the **enter** key.
 - To change a power-on password, type your current password in the Enter Current Password field, type a new password in the Enter New Password and Confirm New Password fields, and then press the **enter** key.
 - To delete a power-on password, type your current password in the Enter Current Password field, and then press the **enter** key four times.
3. To save your changes and exit Setup Utility, use the arrow keys to select **Exit > Exit Saving Changes**.

Changes go into effect when the computer restarts.

Entering a power-on password

At the Enter Password prompt, type your password, and then press the **enter** key. After three unsuccessful attempts to enter the password, restart the computer and try again.

Using antivirus software

When using the computer to access e-mail, a network, or the Internet, the computer is exposed to viruses. Computer viruses disable the operating system, programs, or utilities, or cause them to function abnormally.

Antivirus software detects most viruses, destroys them, and in most cases, repairs any damage caused. To provide ongoing protection against newly discovered viruses, keep antivirus software up-to-date.

Norton Internet Security, an antivirus program, is preinstalled on the computer. The software includes 60 days of free updates. HP recommends protecting the computer against new viruses beyond 60 days by purchasing extended update service. Instructions for using and updating Norton Internet Security software and for purchasing extended update service are provided within the program. To view and access Norton Internet Security, select **Start > All Programs > Norton Internet Security**.

For more information about computer viruses, type `viruses` in the Help and Support search box.

Using firewall software

When using the computer for e-mail, network, or Internet access, unauthorized persons might gain access to the computer, your personal files, and information about you. Use the firewall software preinstalled on the computer to protect your privacy.

Firewall features include logging and reporting of network activity, and automatic monitoring of all incoming and outgoing traffic. For more information, see the firewall user guide or contact the firewall manufacturer.

 **NOTE:** Under some circumstances a firewall blocks access to Internet games, interferes with printer or file sharing on a network, or blocks authorized e-mail attachments. To temporarily resolve the problem, disable the firewall, perform the task, and then reenable the firewall. To permanently resolve the problem, reconfigure the firewall.

Installing critical security updates

 **CAUTION:** Microsoft sends alerts regarding critical updates. To protect the computer from security breaches and computer viruses, install all critical updates from Microsoft as soon as you receive an alert.

Updates to the operating system and other software might have become available after the computer was shipped. To be sure that all available updates are installed on the computer:

- Run Windows Update after you set up the computer. Use the update link at **Start > All Programs > Windows Update**.
- Run Windows Update monthly thereafter.
- Obtain updates to Windows and other Microsoft programs, as they are released, from the Microsoft website and through the updates link in Help and Support.

Installing an optional security cable

 **NOTE:** A security cable is designed to act as a deterrent, but it might not prevent the computer from being mishandled or stolen.

NOTE: The location of the security cable slot varies by computer model.

To attached the security cable:

1. Loop the security cable around a secured object.
2. Insert the key **(1)** into the cable lock **(2)**.
3. Insert the cable lock into the security cable slot on the computer **(3)**, and then lock the cable lock with the key.

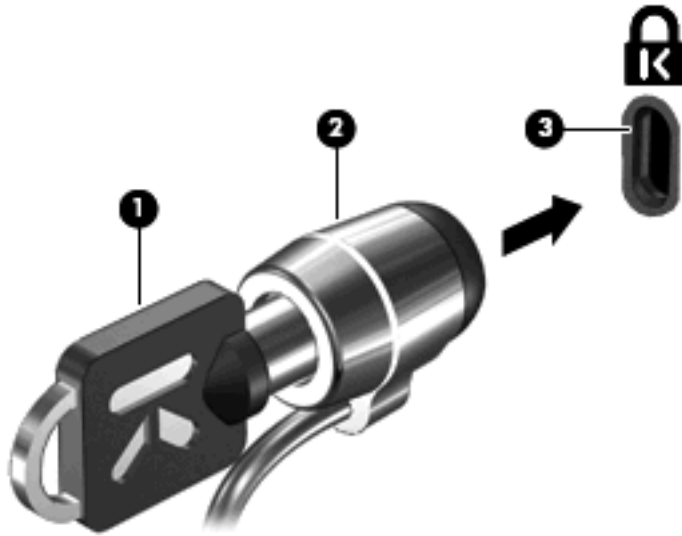

Using the Fingerprint Reader (select models only)

 **NOTE:** The location of the Fingerprint Reader varies by computer model.



Locating the Fingerprint Reader

The Fingerprint Reader is a small metallic sensor that is located:

- Near the bottom of the TouchPad
- On the right side of the keyboard
- On the upper-right side of the display
- On the left side of the display

Depending on the computer model, the Fingerprint Reader might be oriented horizontally or vertically. Both orientations require that you swipe your finger perpendicular to the metallic sensor.



Registering fingerprints

A Fingerprint Reader allows you to log on to Windows using a fingerprint that you have registered using DigitalPersona Personal software, instead of using a Windows password.

To register one or more fingerprints:

1. In Windows, click the DigitalPersona Personal icon in the notification area.
2. Read the welcome text, and then click **Next**.

The Verify Your Identity window appears.

3. Type your Windows password, if one has been established, and then click **Next**.

 **NOTE:** If you do not have a Windows password, the Protect Your Windows Account window appears. Create a Windows password at this time, or skip this step by clicking **Next**. However, setting a Windows password optimizes the security of the computer.

The Fingerprint Registration Training window appears.

4. View the demonstration, and then click **Next**.

The Register a Fingerprint window appears.

5. Click the finger on the screen that corresponds to the finger you want to register.

The next window appears, outlining that finger in green.

6. Slowly swipe your chosen finger over the Fingerprint Reader.

 **NOTE:** If the swipe is not completed correctly, a message explains why the swipe was unsuccessful.

NOTE: For best results, swipe the same finger in the same direction each time you use the Fingerprint Reader.

7. Continue swiping the same finger over the Fingerprint Reader until you have completed four successful swipes.

When the fingerprint is registered successfully, the Register a Fingerprint window appears, allowing you to register more fingerprints. Repeat steps 5 through 7 to register additional fingerprints.

8. When you are finished registering fingerprints, click **Next**.

If you register only one fingerprint, a message recommends that you register additional fingerprints. Click **Yes** to register more fingerprints, and then repeat steps 1 through 8 for each fingerprint registered.

– or –

Click **No** if you do not want to register additional fingerprints. The Registration Complete window appears.

9. Click **Finish**.

 **NOTE:** Repeat steps 1 through 9 for each additional user.

Using your registered fingerprint to log on to Windows

To log on to Windows using your fingerprint:

1. After you register your fingerprints, restart Windows.
2. Swipe any of your registered fingers to log on to Windows.

11 Setup Utility (BIOS)

Starting Setup Utility

Setup Utility is a ROM-based information and customization utility is used even when the Windows operating system is not working.

 **NOTE:** The fingerprint reader (select models only) cannot be used to access Setup Utility.

The utility reports information about the computer and provides settings for startup, security, and other preferences.

To start Setup Utility:

- ▲ Open Setup Utility by turning on or restarting the computer. When the Press the ESC key for Startup Menu screen appears, press the **f10** key.

– or –

Open Setup Utility by turning on or restarting the computer. When the Press the ESC key for Startup Menu screen appears, press the **esc** key. When the Startup Menu appears, press the **f10** key.

Using Setup Utility

Changing the language of Setup Utility

To change the language of Setup Utility:

 **NOTE:** If Setup Utility is not running, begin at step 1. If Setup Utility is running, begin at step 2.

1. Open Setup Utility by turning on or restarting the computer. When the Press the ESC key for Startup Menu screen appears, press the **f10** key.

– or –

Open Setup Utility by turning on or restarting the computer. When the Press the ESC key for Startup Menu screen appears, press the **esc** key. When the Startup Menu appears, press the **f10** key.

2. Use the arrow keys to select **System Configuration > Language**, and then press the **enter** key.
3. Use the arrow keys to select a language, and then press the **enter** key.
4. When a confirmation prompt with your language selected appears, press the **enter** key.
5. To save the change and exit Setup Utility, use the arrow keys to select **Exit > Exit Saving Changes**, and then press the **enter** key.

Changes go into effect immediately.

Navigating and selecting in Setup Utility

Because Setup Utility is not Windows-based, it does not support the TouchPad. Navigation and selections are by keystroke.

To navigate Setup Utility:

- Use the arrow keys to choose a menu or a menu item.
- Use either the arrow keys or the **f5** or **f6** keys to choose an item in a list or to toggle a field, for example an Enable/Disable field.
- Press the **enter** key to select an item.
- Press the **esc** key to close a text box or return to the menu display.
- Press the **f1** key to display additional navigation and selection information.

Displaying system information

Use Setup Utility to view the system time and date and information that identifies the computer.

To display the system information using Setup Utility:

 **NOTE:** If Setup Utility is running, begin at step 1. If Setup Utility is not running, begin at step 2.

1. Open Setup Utility by turning on or restarting the computer. When the Press the ESC key for Startup Menu screen appears, press the **f10** key.

– or –

Open Setup Utility by turning on or restarting the computer. When the Press the ESC key for Startup Menu screen appears, press the **esc** key. When the Startup Menu appears, press the **f10** key.

2. Select the **Main** menu.
3. To exit Setup Utility without changing any settings, use the arrow keys to select **Exit > Exit Discarding Changes**, and then press the **enter** key.

Restoring default settings in Setup Utility

To restore Setup Utility default settings:

 **NOTE:** If Setup Utility is not running, begin at step 1. If Setup Utility is running, begin at step 2.

1. Open Setup Utility by turning on or restarting the computer. When the Press the ESC key for Startup Menu screen appears, press the **f10** key.

– or –

Open Setup Utility by turning on or restarting the computer. When the Press the ESC key for Startup Menu screen appears, press the **esc** key. When the Startup Menu appears, press the **f10** key.

2. Use the arrow keys to select **Exit > Load Setup Defaults**, and then press the **enter** key.
3. When the Setup Confirmation screen appears, press the **enter** key.
4. To save the change and exit Setup Utility, use the arrow keys to select **Exit > Exit Saving Changes**, and then press the **enter** key.

Setup Utility default settings go into effect when the computer restarts.

 **NOTE:** Password, security, and language settings are not changed when you restore the factory default settings.

Exiting Setup Utility

Exit Setup Utility with or without saving changes.

- To exit Setup Utility and save the changes from the current session:

If the Setup Utility menus are not visible, press the **esc** key to return to the menu display. Use the arrow keys to select **Exit > Exit Saving Changes**, and then press the **enter** key.

- To exit Setup Utility without saving your changes from the current session:

If the Setup Utility menus are not visible, press the **esc** key to return to the menu display. Use the arrow keys to select **Exit > Exit Discarding Changes**, and then press the **enter** key.

After either choice, the computer restarts in Windows.

Setup Utility menus

The menu tables provide an overview of Setup Utility options.

 **NOTE:** Some of the Setup Utility menu items might not be supported by the computer.

Main menu

Select	Function
System information	<ul style="list-style-type: none">• View and change the system time and date.• View identification information about the computer.• View specification information about the processor, memory size, system BIOS, and keyboard controller version (select models only).

Security menu

Select	Function
Administrator password	Enter, change, or delete an administrator password.
Power-On Password	Enter, change, or delete a power-on password.

System Configuration menu

Select	Function
Language Support	Change the language of Setup Utility.
Virtualization Technology (select models only)	Enable/disable the processor Virtualization Technology.
LAN Power Saving (select models only)	Enable/disable LAN Power Saving. When enabled, saves power when the computer is in DC mode.
Fan Always On	Enable/disable Fan Always On. When enabled, the computer fan is always on.
Action Keys Mode	Enable/disable the Action Keys.
Boot Options	<ul style="list-style-type: none">• POST (power-on self test) f10 and f12 Delay (sec.)—Set the delay for the f10 and f12 functions of Setup Utility in intervals of 5 seconds each (0, 5, 10, 15, 20).• CD-ROM Boot—Enable/disable boot from CD-ROM.• Floppy Boot—Enable/disable boot from diskette.• Internal Network Adapter Boot—Enable/disable boot from the internal network adapter.• Boot Order—Set the boot order for:<ul style="list-style-type: none">◦ Notebook Hard Drive◦ Internal CD/DVD ROM Drive◦ USB Diskette on Key/USB Hard Drive◦ USB CD/DVD ROM Drive◦ USB Floppy◦ Network Adapter

Diagnostics menu

Select	Function
Primary Hard Disk Self Test	Run a comprehensive self-test on the hard drive.
Secondary Hard Disk Self Test (select models only)	Run a comprehensive self-test on a secondary hard drive.
Memory Test	Run a diagnostic test on the system memory.

12 Software updates

Updated versions of the software provided with the computer might be available on the HP website.

Most software and BIOS updates on the HP website are packaged in compressed files called SoftPaqs.

Some download packages contain a file named Readme.txt, which contains information about installing and troubleshooting the software.

To update the software:

1. Identify the computer model, product category, and series or family. Prepare for a system BIOS update by identifying the BIOS version currently installed on the computer.

If the computer is connected to a network, consult the network administrator before installing any software updates, especially system BIOS updates.

 **NOTE:** The computer system BIOS is stored on the system ROM. The BIOS initializes the operating system, determines how the computer interacts with the hardware devices, and provides for data transfer among hardware devices, including the time and date.

NOTE: Windows includes the User Account Control feature to improve the security of the computer. You might be prompted for your permission or password for tasks such as installing software, running utilities, or changing Windows settings. For more information, see Help and Support.

2. Access the updates on the HP website at <http://www.hp.com>.
3. Install the updates.

Updating the BIOS

To update the BIOS, first determine what BIOS version you currently have and then download and install the new BIOS.

Determining the BIOS version

To determine whether available BIOS updates contain later BIOS versions than those currently installed on the computer, you need to know the version of the system BIOS currently installed.

BIOS version information (also known as ROM date and System BIOS) is displayed by pressing **fn +esc** (if you are already in Windows) or by opening Setup Utility.

To use Setup Utility for displaying BIOS information:

1. Open Setup Utility by turning on or restarting the computer. When the Press the ESC key for Startup Menu appears, press the **f10** key.
2. If Setup Utility does not open with the system information displayed, use the arrow keys to select the **Main** menu.

When the Main menu is selected, BIOS and other system information appears.

3. To exit Setup Utility, use the arrow keys to select **Exit > Exit Discarding Changes**, and then press the **enter** key.

Downloading a BIOS update

△ **CAUTION:** To prevent damage to the computer or an unsuccessful installation, download and install a BIOS update only when the computer is connected to reliable external power using the AC adapter. Do not download or install a BIOS update while the computer is running on battery power, docked in an optional docking device, or connected to an optional power source. During the download and installation, follow these instructions:

Do not disconnect power from the computer by disconnecting the power cord from the AC outlet.

Do not shut down the computer or initiate Sleep or Hibernation.

Do not insert, remove, connect, or disconnect any device, cable, or cord.

To download a BIOS update:

1. Select **Start > Help and Support > Maintain > Software Updates** to access the page on the HP website that provides software for the computer.
2. Follow the instructions on the screen to identify the computer and access the BIOS update you want to download.
3. In the download:
 - a. Identify the BIOS update that is later than the BIOS version currently installed on the computer. Make a note of the date, name, or other identifier. You might need this information to locate the update later, after it has been downloaded to the hard drive.
 - b. Follow the instructions on the screen to download your selection to the hard drive.

Make a note of the path to the location on the hard drive where the BIOS update is downloaded. Access this path when you are ready to install the update.

 **NOTE:** If you connect the computer to a network, consult the network administrator before installing any software updates, especially system BIOS updates.

BIOS installation procedures vary. Follow any instructions that appear on the screen after the download is complete. If no instructions appear:

1. Open Windows Explorer by selecting **Start > Computer**.
2. Double-click the hard drive designation. The hard drive designation is typically Local Disk (C:).
3. Using the hard drive path recorded earlier, open the folder on the hard drive that contains the update.
4. Double-click the file that has an .exe extension (for example, *filename.exe*).

The BIOS installation begins.
5. Complete the installation by following the on-screen instructions.

The system automatically shuts down after the BIOS has successfully updated.

 **NOTE:** After a message on the screen reports a successful installation, delete the downloaded file from the hard drive.

Updating programs and drivers

To download and install software other than a BIOS update:

1. Open a browser window, go to <http://www.hp.com/support>, and then select your country or region.
2. Click the option for software and driver downloads, type the computer model number in the Search box, and then press the **enter** key.
3. Click your specific product from the models listed.
4. Select the operating system.
5. When the list of drivers appears, click an updated driver to open a window containing additional information.
6. Click **Install now** to install the updated driver.

 **NOTE:** In some locations you might be able to download the driver and install it later. To do this, click **Download only** to save the file to the computer. When prompted, click **Save** and then select a storage location on the hard drive. After the file is downloaded, navigate to the folder where the file was stored, and double-click the file to install.

7. If prompted, restart the computer after the installation is complete, and then verify the operation of the device.

13 Backup and recovery

Recovery after a system failure is as complete as the most current backup. HP recommends creating recovery discs immediately after software setup. As you add new software and data files, continue to back up the system on a regular basis to maintain a reasonably current backup.

Tools provided by the operating system and HP Recovery Manager software are designed to help you with the following tasks for safeguarding your information and restoring it in case of a system failure:

- Creating a set of recovery discs (Recovery Manager software feature)—Recovery discs are used to start up (boot) the computer and restore the operating system and software programs to factory settings in case of system failure or instability.
- Backing up your information regularly to protect your important system files.
- Creating system restore points (operating system feature)—System restore points reverse undesirable changes to the computer by restoring the computer to an earlier state.
- Recovering a program or driver (Recovery Manager software feature)—This feature helps you reinstall a program or driver without performing a full system recovery.
- Performing a full system recovery (Recovery Manager software feature)—Recovery Manager recovers the full factory image if you experience system failure or instability. Recovery Manager works from a dedicated recovery partition (select models only) on the hard drive or from recovery discs you create.

 **NOTE:** If the computer includes a solid-state drive (SSD), a recovery partition might not be included. Recovery discs are included for computers that do not have a partition. Use these discs to recover the operating system and software. To check for the presence of a recovery partitions, select **Start > Computer**. If the partition is present, an HP recovery drive is listed in the Hard Disk Drives section of the window.

Creating recovery discs

HP recommends creating recovery discs so that the system can be restored to its original factory state if you experience serious system failure or instability. Create these discs after setting up the computer for the first time.

Handle these discs carefully and keep them in a safe place. The software creates only one set of recovery discs.

 **NOTE:** If the computer does not include an internal optical drive, use an optional external optical drive (purchased separately) to create recovery discs, or purchase recovery discs from the HP website.

Before creating recovery discs:

- You need high-quality DVD-R, DVD+R, BD-R (writable Blu-ray), or CD-R discs. All these discs are purchased separately. DVDs and BDs have a much higher capacity than CDs. If you use CDs, up to 20 discs might be required, whereas only a few DVDs or BDs are required.

 **NOTE:** Read-write discs, such as CD-RW, DVD±RW, double-layer DVD±RW, and BD-RE (rewritable Blu-ray) discs, are not compatible with the Recovery Manager software.

- The computer must be connected to AC power during this process.

- Only one set of recovery discs are created per computer.
- Number each disc before inserting it into the optical drive.
- If necessary, exit the program before you have finished creating the recovery discs. The next time you open Recovery Manager, you are prompted to continue the disc creation process.

To create a set of recovery discs:

1. Select **Start > All Programs > Recovery Manager > Recovery Disc Creation**.
2. Follow the on-screen instructions.

Backing up your information

As you add new software and data files, back up your system on a regular basis to maintain a reasonably current backup.

Back up your system at the following times:

- At regularly scheduled times

 **NOTE:** Set reminders to back up your information periodically.

- Before the computer is repaired or restored
- Before adding or modifying hardware or software

When backing up:

- Create system restore points using the Windows System Restore feature, and periodically copy them to disc.
- Store personal files in the Documents library and periodically back up this folder.
- Back up templates stored in their associated programs.
- Save customized settings in a window, toolbar, or menu bar by taking a screen shot of your settings. The screen shot is a time-saver if you have to reset your preferences.

To copy the screen and paste it into a word-processing document:

1. Display the screen.
2. Copy the screen:
 - To copy only the active window, press **alt+fn+prt sc**.
 - To copy the entire screen, press **fn+prt sc**.
3. Open a word-processing document, and then select **Edit > Paste**.
4. Save the document.

- Back up your information to an optional external hard drive, a network drive, or discs.
- When backing up to discs, use any of the following types of discs (purchased separately): CD-R, CD-RW, DVD+R, DVD-R, or DVD±RW. The discs used depend on the type of optical drive installed in the computer.

 **NOTE:** DVDs store more information than CDs, so using them for backup reduces the number of recovery discs required.

- When backing up to discs, number each disc before inserting it into the optical drive of the computer.

Using Windows Backup and Restore

To create a backup using Windows Backup and Restore:

 **NOTE:** Be sure that the computer is connected to AC power before starting the backup process.

NOTE: The backup process might take over an hour, depending on file size and the speed of the computer.

1. Select **Start > All Programs > Maintenance > Backup and Restore**.
2. Follow the on-screen instructions.

 **NOTE:** Windows includes the User Account Control feature to improve the security of the computer. You might be prompted for your permission or password for tasks such as installing software, running utilities, or changing Windows settings. For more information, see Help and Support.

Using system restore points

When backing up your system, you are creating a system restore point. A system restore point saves and names a snapshot of the hard drive at a specific point in time. You can then recover back to that point if you want to reverse subsequent changes made to the system.

 **NOTE:** Recovering to an earlier restore point does not affect data files saved or e-mails created since the last restore point.

Create additional restore points to provide increased protection for the system files and settings.

When to create restore points

Create restore points:

- Before adding or extensively modifying software or hardware
- Periodically, whenever the system is performing optimally

 **NOTE:** If you revert to a restore point and then change your mind, reverse the restoration.

Create a system restore point

To create a system restore point:

1. Select **Start > Control Panel > System and Security > System**.
2. In the left pane, click **System Protection**.
3. Click the **System Protection** tab.
4. Under **Protection Settings**, select the disk for which you want to create a restore point.
5. Click **Create**.
6. Follow the on-screen instructions.

Restore to a previous date and time

To revert to a restore point (created at a previous date and time), when the computer was functioning optimally:

1. Select **Start > Control Panel > System and Security > System**.
2. In the left pane, click **System protection**.

3. Click the **System Protection** tab.
4. Click **System Restore**.
5. Follow the on-screen instructions.

Performing a recovery

 **NOTE:** Recover only files that you have previously backed up. HP recommends using HP Recovery Manager to create a set of recovery discs (entire drive backup) as soon as you set up the computer.

Recovery Manager software repairs or restores the system if you experience system failure or instability. Recovery Manager works from recovery discs or from a dedicated recovery partition (select models only) on the hard drive. However, if the computer includes a solid-state drive (SSD), you might not have a recovery partition. If that is the case, recovery discs are included with the computer. Use these discs to recover the operating system and software.

 **NOTE:** Windows has its own built-in repair features, such as System Restore. If you have not already tried these features, try them before using Recovery Manager.

NOTE: Recovery Manager recovers only software that was preinstalled at the factory. Software not provided with this computer must be downloaded from the manufacturer's website or reinstalled from the disc provided by the manufacturer.

Recovering from the recovery discs

To restore the system from the recovery discs:

1. Back up all personal files.
2. Insert the first recovery disc into the optical drive, and then restart the computer.
3. Follow the on-screen instructions.

Recovering from the dedicated recovery partition (select models only)

 **NOTE:** If the computer includes a solid-state drive (SSD), a recovery partition might not be included. Recovery discs are included for computers that do not have a partition. Use these discs to recover the operating system and software. To check for the presence of a recovery partitions, select **Start > Computer**. If the partition is present, an HP recovery drive is listed in the Hard Disk Drives section of the window.

On some models, a recovery from the partition can be performed on the hard drive. This restores the computer to its factory condition.

To restore the system from the partition:

1. Access Recovery Manager by either:
 - Selecting **Start > All Programs > Recovery Manager > Recovery Manager**.
 - or –
 - Turning on or restarting the computer, and then pressing the **esc** key when the Press the ESC key for Startup Menu screen appears. Then, press the **f11** key when the Press <F11> for recovery screen appears.
2. Click **System Recovery** in the Recovery Manager window.
3. Follow the on-screen instructions.

14 Troubleshooting

Cannot connect to a WLAN

Before troubleshooting a network connection problem, be sure that device drivers are installed for all wireless devices.

 **NOTE:** Wireless networking devices are included with select computer models only. If wireless networking is not listed in the feature list on the side of the original computer package, add wireless networking capability to the computer by purchasing a wireless networking device.

Possible causes for wireless connection problems include:

- Changing the network configuration (SSID or security)
- Disabling or incorrectly installing the wireless device
- Failing wireless device or router hardware
- Encountering interference from other devices

If you have a problem connecting to a WLAN, confirm that the integrated WLAN device is properly installed on the computer:

 **NOTE:** Windows includes the User Account Control feature to improve the security of the computer. You might be prompted for your permission or password for tasks such as installing software, running utilities, or changing Windows settings. For more information, see Help and Support.

1. Select **Start > Control Panel > System and Security**.
2. In the System area, click **Device Manager**.
3. Expand the list of Network adapters by clicking the plus (+) sign.
4. Identify the WLAN device from the Network adapters list. The listing for a WLAN device might include the term *wireless*, *wireless LAN*, *WLAN*, *Wi-Fi*, or *802.11*.

If no WLAN device is listed, either the computer does not have an integrated WLAN device, or the driver for the WLAN device is not properly installed.

For more information on troubleshooting WLANs, see the website links provided in Help and Support.

Cannot connect to a preferred network

Windows automatically repairs a corrupted WLAN connection:

- If there is a Network icon in the notification area, right-click the icon, and then click **Troubleshoot problems**.

Windows resets your network device and attempts to reconnect to one of the preferred networks.

- If there is no Network icon in the notification area:
 1. Select **Start > Control Panel > Network and Internet > Network and Sharing Center**.
 2. Click **Troubleshoot problems** and select the network you want to repair.

Network icon is not displayed

If the network icon is not displayed in the notification area after configuring the WLAN, the software driver is either missing or corrupted. A Windows “Device not Found” error message might appear. Reinstall the driver.

Get the latest version of the WLAN device software and drivers for the computer from the HP website at <http://www.hp.com>. If the WLAN device was purchased separately, consult the manufacturer's website for the latest software.

For the latest version of the WLAN device software:

1. Open a web browser and go to <http://www.hp.com/support>.
2. Select your country or region.
3. Click the option for software and driver downloads.
4. Type the computer model number in the search box.
5. Press the **enter** key, and then follow the on-screen instructions.

 **NOTE:** If the WLAN device was purchased separately, consult the manufacturer's website for the latest software.

Current network security codes are unavailable

If prompted for a network key or a name (SSID) when connecting to a WLAN, the network is protected by security. Enter the current codes to make a connection on a secure network. The SSID and network key are alphanumeric codes that are entered to identify the computer to the network. To find the codes:

- For a network connected to your personal wireless router, review the router user guide for instructions on setting up the same codes on both the router and the WLAN device.
- For a private network, such as a network in an office or at a public Internet chat room, contact the network administrator to obtain the codes, and then enter the codes when prompted.

Some networks change the SSID or network keys used in their routers or access points on a regular basis to improve security. Change the corresponding code in the computer accordingly.

If provided with new wireless network keys and SSID, and if you have previously connected to that network, follow the steps below to connect to the network:

1. Select **Start > Control Panel > Network and Internet > Network and Sharing Center**.
2. In the left panel, click **Manage wireless networks**.

A list showing the available WLANs appears. If you are in a hotspot where several WLANs are active, multiple networks appear.

3. Select the network in the list, right-click the network, and then click **Properties**.

 **NOTE:** If the network you want is not listed, check with the network administrator to be sure that the router or access point is operating.

4. Click the **Security** tab and enter the correct wireless encryption data into the **Network security key** box.
5. Click **OK** to save these settings.

WLAN connection is very weak

If the connection is very weak, or if the computer cannot make a connection to a WLAN, minimize interference from other devices by:

- Moving the computer closer to the wireless router or access point.
- Temporarily disconnecting devices such as a microwave, cordless phone, or cellular phone.

To force the device to reestablish all connection values:

1. Select **Start > Control Panel > Network and Internet > Network and Sharing Center**.
2. In the left panel, click **Manage wireless networks**.

A list showing the available WLANs appears. If you are in a hotspot where several WLANs are active, multiple networks appear.

3. Select a network, and then click **Remove**.

Cannot connect to the wireless router

If you are trying to connect to the wireless router and are unsuccessful, reset the wireless router by removing power from the router for 10 to 15 seconds.

If the computer cannot make a connection to a WLAN, restart the wireless router. For details, see the router manufacturer's instructions.

The optical disc tray does not open for removal of a CD, a DVD, or a BD

1. Insert the end of a paper clip into the release access in the front bezel of the drive (1).
 2. Press in gently on the paper clip until the disc tray is released, and then pull out the tray until it stops (2).
 3. Remove the disc from the tray by gently pressing down on the spindle while lifting the outer edges of the disc (3). Hold the disc by the edges and avoid touching the flat surfaces.
-
-  **NOTE:** If the tray is not fully accessible, tilt the disc carefully as you remove it.
4. Close the disc tray, and then place the disc in a protective case.



The computer does not detect the CD, DVD, or BD drive

If Windows does not detect an installed device, the device driver software might be missing or corrupted. If you suspect that the optical drive is not being detected, verify that the optical drive is listed in the Device Manager utility by:

1. Removing any discs from the optical drive.
2. Selecting **Start > Control Panel > System and Security**.
3. In the **System** area, clicking **Device Manager**.
4. In the Device Manager window, clicking the arrow next to DVD/CD-ROM drives to expand the list to show all of the installed drives.
5. Right-clicking the optical device listing to perform the following tasks:
 - Update the driver software
 - Disable

- Uninstall
- Scann for hardware changes. Windows scans your system for installed hardware and installs any required drivers
- Click **Properties** to verify that the device is working properly
 - The Properties window provides details about the device to help you troubleshoot issues
 - Click the **Driver** tab to update, disable, or uninstall drivers for this device

A CD, DVD, or BD does not play

To play a CD, DVD, or BD:

- Save your work and close all open programs before playing a disc.
- Log off the Internet before playing a disc.
- Be sure that you insert the disc properly.
- Be sure that the disc is clean. If necessary, clean the disc with filtered water and a lint-free cloth. Wipe from the center of the disc to the outer edge.
- Check the disc for scratches. If you find scratches, treat the disc with an optical disc repair kit available at many electronics stores.
- Disable Sleep before playing the disc.

Do not initiate Hibernation or Sleep while playing a disc. Otherwise, you might see a warning message asking if you want to continue. If this message appears, click **No**. After clicking No, the computer might:

- Resume playback.
- Close the playback window in the multimedia program. To return to playing the disc, click the **Play** button in your multimedia program. In some cases, you might need to exit the program, and then restart it.
- Increase system resources.
 - Shut down printers and scanners, and unplug cameras and portable handheld devices. Disconnecting these Plug and Play devices frees up valuable system resources and results in better playback performance.
 - Change desktop color properties. Because the human eye cannot easily tell the difference between colors beyond 16 bits, you should not notice any loss of color while watching a movie if you lower system color properties to 16-bit color by:
 1. Right-clicking on a blank area of the computer desktop, and selecting **Screen resolution**.
 2. Selecting **Advanced Settings > Monitor** tab.
 3. Selecting **High Color (16 bit)**, if this setting is not already selected.
 4. Clicking **OK**.

A CD, DVD, or BD does not play automatically

1. Click **Start > Default Programs > Change AutoPlay Settings**.
2. Confirm that the **Use AutoPlay for all media and devices** check box is selected.
3. Click **Save**.

A disc should now start automatically when it is inserted into the optical drive.

A DVD or BD movie stops, skips, or plays erratically

- Clean the disc.
- Conserve system resources by:
 - Logging off the Internet.
 - Changing the color properties of the desktop.
 1. Right-click on a blank area of the computer desktop, and then select **Screen resolution**.
 2. Select **Advanced Settings > Monitor** tab.
 3. Select **High Color (16 bit)**, if this setting is not already selected.
 4. Click **OK**.
 - Disconnecting external devices, such as a printer, scanner, camera, or handheld device.

A DVD or BD movie is not visible on an external display

1. If both the computer display and an external display are on, press the [Switch Screen Image](#) key one or more times to switch between the 2 displays.
2. Configure the monitor settings to make the external display primary:
 - a. Right-click on a blank area of the computer desktop, and select **Screen resolution**.
 - b. Specify a primary display and a secondary display.

 **NOTE:** When using both displays, the movie image does appear on any display designated as the secondary display.

For information about a multimedia question not covered in this guide, go to **Start > Help and Support**.

The process of burning a CD or DVD does not begin, or it stops before completion

- Be sure that all other programs are closed.
- Disable Sleep and Hibernation.
- Be sure that you are using the right kind of disc for your drive. For more information about disc types, see the user guides.
- Be sure that the disc is inserted properly.
- Select a slower write speed and try again.

- If copying a disc, save the information on the source disc to your hard drive before trying to burn the contents to a new disc, and then burn from the hard drive.
- Reinstall the disc-burning device driver located in the DVD/CD-ROM drives category in Device Manager.

A DVD or BD playing in Windows Media Player produces no sound or display

Use MediaSmart to play a DVD or BD. MediaSmart is installed on the computer, and is also available from the HP website at <http://www.hp.com>.

A device driver must be reinstalled

1. Remove any discs from the optical drive.
2. Select **Start > Control Panel > System and Security**.
3. In the System area, click **Device Manager**.
4. In the Device Manager window, click the arrow next to the type of driver you want to uninstall and reinstall (for example, DVD/CD ROMs, Modems, and so on).
5. Right-click the device listing and click **Uninstall**. When prompted, confirm that you want to delete the device, but do not restart the computer. Repeat for any other drivers you want to delete.
6. In the Device Manager window, click **Action**, and then click **Scan for hardware changes**. Windows scans the system for installed hardware and installs default drivers for any devices requiring drivers.

 **NOTE:** If you are prompted to restart the computer, save all open files, and then continue with the restart.

7. Reopen Device Manager, if necessary, and then verify that the drivers are once again listed.
8. Try running the program again.

If uninstalling and reinstalling the device drivers does not correct the problem, you might need to update your drivers using the procedures in the following sections.

Obtaining the latest HP device drivers

1. Open a web browser, go to <http://www.hp.com/support>, and then select your country or region.
2. Click the option for software and driver downloads, type the computer model number in the search box, and then press the **enter** key.
3. Click your specific product from the models listed.
4. Click the Windows 7 operating system.
5. When the list of drivers is displayed, click an updated driver to open a window containing additional information.
6. Click **Install now** to install the updated driver without downloading the file.

– or –

Click **Download only** to save the file to the computer. When prompted, click **Save** and then select a storage location on the hard drive.

After the file is downloaded, navigate to the folder where the file was stored, and then double-click the file to install.

7. If prompted, restart the computer after the installation is complete, and then verify the operation of the device.

Obtaining the latest Windows device drivers

Obtain the latest Windows device drivers by using Windows Update. This feature automatically checks for and installs updates for the Windows operating system and other Microsoft products.

To use Windows Update:

1. Click **Start > All Programs > Windows Update**.

 **NOTE:** If you have not previously set up Windows Update, a prompt appears asking you to enter settings before checking for updates.

2. Click **Check for Updates**.
3. Follow the on-screen instructions.

Index

- A**
 - AC adapter
 - connecting 39
 - identifying 10
 - action keys
 - adjusting volume 23
 - audio CD, DVD, or BD
 - controls 23
 - decrease screen brightness 22
 - Help and Support 22
 - increase screen brightness 22
 - muting speaker sound 23
 - switching screen image 23
 - using 22
 - volume 28
 - wireless 23
 - administrator password
 - creating 73
 - entering 73
 - managing 73
 - airport security devices 48
 - antennas 9
 - antivirus software 74
 - applications key, Windows 4
 - audio devices, connecting
 - external 30
 - audio features 30
 - audio functions, checking 31
 - audio-in (microphone) jack 27
 - audio-out (headphone) jacks 27
 - AutoPlay 51
- B**
 - backing up
 - customized window, toolbar, and menu bar settings 87
 - personal files 87
 - templates 87
 - battery
 - calibrating 43
 - charging 41, 43
 - conserving power 45
 - discharging 42
 - disposing 46
 - inserting 40
 - low battery levels 42
 - removing 40
 - replacing 46
 - storing 45
 - battery bay 11
 - battery bay, identifying 7
 - Battery Check 40
 - battery power 39
 - battery release latch 40
 - battery release latch, identifying 7
 - battery temperature 45
 - battery, identifying 10
 - bays
 - battery 7, 11
 - primary hard drive 7
 - BD
 - playing 51
 - removing 55
 - BIOS, updating 83
 - Blu-ray ROM DVD+/-RW SuperMulti DL Drivet 49
 - Blu-ray ROM with LightScribe DVD +/-RW SuperMulti DL Drive 49
 - Bluetooth device 12, 17
 - Bluetooth label 11
 - boot options 82
 - boot order 82
 - buttons
 - left TouchPad 1
 - power 3
 - right TouchPad 2
 - TouchPad, on/off button 1
- C**
 - cables
 - eSATA 64
 - LAN 18
 - security 75
 - USB 62
 - calibrating battery 43
 - caps lock light, identifying 2
 - CD
 - burning 54, 95
 - copying 53
 - playing 51
 - removing 55
 - CD drive 55
 - Certificate of Authenticity label 11
 - changing the language of Setup Utility 79
 - charging batteries 41, 43
 - checking audio functions 31
 - compartments
 - memory module 7
 - components
 - additional hardware 10
 - bottom 7
 - display 8
 - front 5
 - left-side 6
 - right-side 5
 - top 1
 - connecting to a WLAN 17
 - Connection Manager icon 13
 - connection, external power 39
 - connectors, power 5
 - conservation, power 45
 - copyright warning 53
 - cord, power 10
 - corporate WLAN connection 17
 - critical battery level 42
 - critical updates, software 75
- D**
 - device drivers
 - HP drivers 96
 - Windows drivers 97
 - Diagnostics menu 82
 - digital card
 - defined 65
 - inserting 65
 - removing 66
 - stopping 66
 - digital dual array microphones, identifying 27

- Disk Cleanup software 56
- Disk Defragmenter software 56
- disk performance 56
- diskette drive 55
- display image, switching 23
- displaying system information 80
- drive media 35
- drives
 - boot order 82
 - caring for 48
 - diskette 55
 - external 55
 - hard 55, 56, 58, 59, 60
 - optical 55
 - See *also* hard drive; optical drive
- DVD
 - burning 54, 95
 - changing region setting 52
 - copying 53
 - playing 51
 - removing 55
- DVD drive 55
- DVD region settings 52

E

- earbuds 27
- encryption 16
- entering a power-on password 74
- entering an administrator password 73
- eSATA cable, connecting 64
- eSATA devices
 - connecting 64
 - description 63
 - removing 64
- eSATA/USB port, identifying 6
- esc key, identifying 4
- exiting Setup Utility 81
- external audio devices, connecting 30
- external drive 55
- external monitor port 31
- external monitor port, identifying 6

F

- f11 89
- fan always on 82

- fingerprint reader, identifying 3, 76
- firewall 16
- firewall software 74
- fn key, identifying 4, 23
- full system recovery 86
- function keys, identifying 4

G

- graphic modes, switching 46

H

- hard drive
 - external 55
 - primary, installing 58
 - secondary, installing 60
- hard drive self test 82
- HDMI port 33
- HDMI port, identifying 6
- HDMI, connecting 33
- headphone (audio-out) jacks 27
- headphones 27
- Help and Support key 22
- Hibernation
 - exiting 36
 - initiated during critical battery level 42
 - initiating 36
- high-definition devices, connecting 33
- hotkeys
 - description 23
 - using 24
- HP MediaSmart, starting 30
- HP Mobile Broadband Module
 - serial number label 11
- hubs 62

I

- icons
 - Connection Manager 13
 - network 13, 91
 - wired network 13
 - wireless 13
- integrated webcam light, identifying 8
- interference, minimizing 92
- internal digital dual array microphones, identifying 27
- internal microphones, identifying 8

- Internet connection setup 15

J

- jacks
 - audio-in (microphone) 27
 - audio-out (headphone) 27
 - RJ-45 (network) 6

K

- keyboard hotkeys, identifying 23
- keypad keys, identifying 4
- keypad, external
 - num lock 25
 - using 25
- keypad, integrated
 - identifying 24
 - num lock 24
 - using 24
- keys
 - esc 4
 - fn 4
 - function 4
 - keypad 4
 - mute 28
 - Windows applications 4
 - Windows logo 4

L

- labels
 - Bluetooth 11
 - HP Mobile Broadband Module 11
 - Microsoft Certificate of Authenticity 11
 - regulatory 11
 - service tag 10
 - SIM 11
 - wireless certification 11
 - WLAN 11
- LAN Power Saving 82
- language support 82
- latch, battery release 7
- left TouchPad button, identifying 1
- lights
 - caps lock 2
 - mute 2
 - power 2
 - TouchPad 2
 - volume mute 2

- webcam 8
- wireless 2
- local area network (LAN)
 - cable required 18
 - connecting cable 18
- low battery level 42

M

- Main menu 81
- maintenance
 - Disk Cleanup 56
 - Disk Defragmenter 56
- managing a power-on password 74
- managing an administrator password 73
- media activity keys 29
- media controls, keys 23
- memory module
 - inserting 69
 - removing 68
- memory module compartment
 - cover
 - removing 68
 - replacing 70
- memory module compartment, identifying 7
- memory test 82
- microphones, internal 27
- Microsoft Certificate of Authenticity label 11
- minimizing interference 92
- monitor port, external 6
- monitor, connecting 31
- mouse, external
 - connecting 22
 - setting preferences 20
- multimedia components, identifying 27
- multimedia software 29, 30
- mute key
 - identifying 23
 - using 28
- mute light, identifying 2

N

- navigating in Setup Utility 79
- network cable
 - connecting 18
 - noise suppression circuitry 18

- network icons 13, 91
- network key 91
- network security codes
 - network key 91
 - SSID 91
- noise suppression circuitry
 - network cable 18
- num lock
 - external keypad 25
 - integrated keypad 24

O

- operating system
 - Microsoft Certificate of Authenticity label 11
 - Product Key 11
- optical disc
 - playing 51
 - removing 55
- optical drive 5, 48, 55

P

- passwords
 - administrator 73
 - power-on 73
 - set in Setup Utility 72
 - set in Windows 72
- performing a recovery 89
- pinching TouchPad gesture 21
- pointing devices, setting preferences 20
- ports
 - eSATA/USB 6
 - external monitor 6
 - HDMI 6, 33
 - USB 5, 6, 62
- ports, external monitor 31
- power
 - connecting 39
 - conserving 45
- power button, identifying 3
- power connector, identifying 5
- power cord, identifying 10
- power lights, identifying 2
- power-on password
 - creating 74
 - entering 74
 - managing 74
- primary hard drive bay, identifying 7

- primary hard drive, replacing 56
- Product Key 11
- product name and number, computer 10
- programs, updating 85
- projector, connecting 31
- public WLAN connection 17

R

- readable media 35
- recovering a program or driver 86
- recovering from the dedicated recovery partition 89
- recovering from the recovery discs 89
- recovery discs 86
- Recovery Manager 86, 89
- recovery partition 86
- recovery, system 89
- region codes, DVD 52
- registering fingerprints 77
- regulatory information
 - regulatory label 11
 - wireless certification labels 11
- restore points 88
- restoring default settings 80
- right TouchPad button, identifying 2
- RJ-45 (network) jack, identifying 6

S

- screen brightness keys 22
- screen image, switching 23
- scrolling TouchPad gesture 21
- secondary hard drive self test 82
- secondary hard drive, replacing 59
- security
 - features 71
 - passwords 71
- security cable 75
- security cable slot, identifying 5
- Security menu 81
- security, wireless 16
- selecting in Setup Utility 79
- serial number, computer 10
- service tag 10
- setup of WLAN 15
- Setup Utility, passwords set in 72

- shutdown 47
- shutting down 47
- SIM label 11
- Sleep
 - exiting 35
 - initiating 35
- slots, security cable 5
- software
 - antivirus 74
 - critical updates 75
 - Disk Cleanup 56
 - Disk Defragmenter 56
 - firewall 74
 - installing 30
 - multimedia 30
 - Windows Media Player 30
 - Wireless Assistant 14
- solid-state drive (SSD) 86, 89
- speakers 5, 27
- starting Setup Utility 79
- storing battery 45
- SuperMulti LightScribe DVD±RW and CD-RW Combo with DL support 49
- supported discs 86
- switchable graphics 46
- System Configuration menu 82
- system failure or instability 86
- system information 81
- system recovery 89
- system restore points 86, 88

T

- temperature 45
- TouchPad
 - buttons 1
 - gestures 20
 - identifying 20
 - using 20
- TouchPad gestures
 - pinching 21
 - scrolling 21
 - zooming 21
- TouchPad light, identifying 2
- TouchPad on/off button, identifying 1
- TouchPad zone
 - identifying 1
- traveling with the computer
 - wireless certification labels 11

- troubleshooting
 - burning discs 95
 - device driver 96
 - disc play 94, 95
 - DVD movie play 95
 - external display 95
 - HP device drivers 96
 - optical disc tray 93
 - optical drive detection 93
 - Windows drivers 97
- turning off the computer 47

U

- unresponsive system 47
- USB cable, connecting 62
- USB devices
 - connecting 62
 - description 62
 - removing 63
- USB hubs 62
- USB ports, identifying 5, 6, 62
- using Setup Utility 79
- using system restore 88

V

- vents, identifying 7
- video, using 31
- Virtualization Technology 82
- volume
 - adjust 28
 - keys 28
 - mute 28
- volume keys, identifying 23
- volume mute light, identifying 2

W

- webcam 8, 27
- webcam light 27
- webcam, using 34
- Windows applications key, identifying 4
- Windows logo key, identifying 4
- Windows, passwords set in 72
- wireless antennas 9
- Wireless Assistant software 13, 14
- wireless certification label 11
- wireless controls
 - Connection Manager software 13
 - key 13

- operating system 13
 - Wireless Assistant software 13
- wireless devices, types 12
- wireless icon 13
- wireless key
 - identifying 23
 - using 14
- wireless light 2, 13
- wireless network (WLAN)
 - connecting 17
 - corporate WLAN connection 17
 - described 12
 - equipment needed 15
 - functional range 17
 - identifying 7
 - label 11
 - public WLAN connection 17
 - security 16
- writable media 35

Z

- zooming TouchPad gesture 21

