



# **HP ProBook 5320m Notebook PC**

## Maintenance and Service Guide

Document Part Number: 609313-001

June 2010

This guide is a troubleshooting reference used for maintaining and servicing the computer. It provides comprehensive information on identifying computer features, components, and spare parts; troubleshooting computer problems; and performing computer disassembly procedures.

© Copyright 2010 Hewlett-Packard Development Company, L.P.

Bluetooth is a trademark owned by its proprietor and used by Hewlett-Packard Company under license. Intel, Celeron, and Core are trademarks of Intel Corporation in the U.S. and other countries. Microsoft, Windows, and Windows Vista are U.S. registered trademarks of Microsoft Corporation. SD Logo is a trademark of its proprietor.

The information contained herein is subject to change without notice. The only warranties for HP products and services are set forth in the express warranty statements accompanying such products and services. Nothing herein should be construed as constituting an additional warranty. HP shall not be liable for technical or editorial errors or omissions contained herein.

First Edition: June 2010

Document Part Number: 609313-001

## Safety warning notice

---



**WARNING:** To reduce the possibility of heat-related injuries or of overheating the computer, do not place the computer directly on your lap or obstruct the computer air vents. Use the computer only on a hard, flat surface. Do not allow another hard surface, such as an adjoining optional printer, or a soft surface, such as pillows or rugs or clothing, to block airflow. Also, do not allow the AC adapter to contact the skin or a soft surface, such as pillows or rugs or clothing, during operation. The computer and the AC adapter comply with the user-accessible surface temperature limits defined by the International Standard for Safety of Information Technology Equipment (IEC 60950).

---

## 1 Product description

## 2 External component identification

Identifying hardware .....	2-1
Top components .....	2-2
Display components .....	2-2
Wireless antennas (select models only) .....	2-3
Buttons .....	2-4
Keys .....	2-5
Lights .....	2-6
Pointing devices .....	2-7
Front components .....	2-8
Right-side components .....	2-8
Left-side components .....	2-9
Bottom components .....	2-10

## 3 Illustrated parts catalog

Serial number label location .....	3-1
Computer major components .....	3-2
Cable Kit .....	3-6
Display assembly subcomponents .....	3-7
Mass storage devices .....	3-8
Plastics Kit .....	3-9
Miscellaneous parts .....	3-10
Sequential part number listing .....	3-11

## 4 Removal and replacement procedures

Preliminary replacement requirements .....	4-1
Tools required .....	4-1
Service considerations .....	4-1
Grounding guidelines .....	4-2
Component replacement procedures .....	4-5
Serial number location .....	4-5
Computer feet .....	4-6
Battery .....	4-7
SIM .....	4-8
Mass storage device .....	4-9
Bluetooth module .....	4-12
WLAN module .....	4-14
WWAN module .....	4-17
RTC battery .....	4-20
Memory module .....	4-21

Keyboard . . . . .	4-23
Button board and cable . . . . .	4-26
Top cover . . . . .	4-28
Power button board and cable . . . . .	4-31
Bluetooth module cable . . . . .	4-32
System board . . . . .	4-33
Fan and heat sink . . . . .	4-36
Speaker assembly . . . . .	4-39
USB board . . . . .	4-40
Battery eject arm . . . . .	4-41
Display assembly . . . . .	4-43

## 5 Computer Setup

Computer Setup in Windows 7 . . . . .	5-1
Starting Computer Setup . . . . .	5-1
Using Computer Setup . . . . .	5-1
Computer Setup menus . . . . .	5-3
File menu . . . . .	5-3
Security menu . . . . .	5-3
Diagnostics menu . . . . .	5-4
System Configuration menu . . . . .	5-5
Computer Setup in Windows Vista . . . . .	5-7
Starting Computer Setup . . . . .	5-7
Using Computer Setup . . . . .	5-7
Computer Setup menus . . . . .	5-8
File menu . . . . .	5-8
Security menu . . . . .	5-9
Diagnostics menu . . . . .	5-10
System Configuration menu . . . . .	5-10
Computer Setup in Windows XP . . . . .	5-13
Starting Computer Setup . . . . .	5-13
Using Computer Setup . . . . .	5-13
Computer Setup menus . . . . .	5-14
File menu . . . . .	5-14
Security menu . . . . .	5-15
Diagnostics menu . . . . .	5-16
System Configuration menu . . . . .	5-17

## 6 Specifications

Computer specifications . . . . .	6-1
13.3-in display specifications . . . . .	6-2
Hard drive specifications . . . . .	6-3
. . . . .	6-4

## 7 Backup and recovery

Backup and recovery in Windows 7 . . . . .	8-1
Overview . . . . .	8-1
Backing up your information . . . . .	8-1
Performing a recovery . . . . .	8-3
Backup and recovery in Windows Vista . . . . .	8-5

Overview . . . . .	8-5
Backing up your information . . . . .	8-5
Performing a recovery . . . . .	8-6
Backup and recovery in Windows XP . . . . .	8-9
Overview . . . . .	8-9
Backing up your information . . . . .	8-9
Performing a recovery . . . . .	8-10

**8 Connector pin assignments**

Audio-in (microphone) . . . . .	8-1
Audio-out (headphone) . . . . .	8-1
External monitor . . . . .	8-2
RJ-45 (network) . . . . .	8-3
Universal Serial Bus . . . . .	8-4

**9 Power cord set requirements**

Requirements for all countries and regions . . . . .	9-1
Requirements for specific countries and regions . . . . .	9-2

**10 Recycling**

Battery . . . . .	10-1
Display . . . . .	10-1

**Index**

## Product description

Category	Description
<b>Product name</b>	HP ProBook 5320m Notebook PC
<b>Processors</b>	<ul style="list-style-type: none"> <li>■ Intel® Dual Core i5-45M 2.40-GHz processor (Turbo up to 2.53 GHz), 3-M L3 cache, 4 threads (35W)</li> <li>■ Intel Dual Core i3-370M 2.40-GHz processor, 3-M L3 cache, 4 threads (35W)</li> <li>■ Intel Dual Core i3-350M 2.26-GHz processor, 3-M L3 cache, 4 threads (35W)</li> <li>■ Intel U3400 1.06-GHz processor</li> </ul>
<b>Chipset</b>	Intel HM57
<b>Graphics</b>	Mobile Intel Graphics Media Accelerator HD unified memory architecture (UMA)
<b>Panel</b>	<ul style="list-style-type: none"> <li>■ 13.3-in, high-definition (HD, 1366 × 768), AntiGlare, LED display assembly</li> <li>■ 13.3-in, HD (1366 × 768), BrightView, LED display assembly</li> <li>■ Supports privacy filter</li> </ul>
<b>Memory</b>	<p>One customer-accessible/upgradable memory module slot</p> <p>Supports the following DDR3 configurations at 1333 MHz in all countries and regions:</p> <ul style="list-style-type: none"> <li>■ 4096-MB total system memory (4096 × 1)</li> <li>■ 2048-MB total system memory (2048 × 1)</li> <li>■ 1024-MB total system memory (1024 × 1) (not available on Microsoft 64-bit operating systems)</li> </ul>
<b>Hard drives</b>	<p>Supports <b>9.50-mm, 6.35-cm</b> (2.50-in) hard drives</p> <p>Customer-accessible</p> <p>Supports the following hard drives:</p> <ul style="list-style-type: none"> <li>■ 500-GB, 7200 rpm</li> <li>■ 320-GB, 7200 rpm</li> <li>■ 250-GB, 7200 rpm</li> </ul> <p>Supports the following solid-state drives only with computer models running Windows 7 operating system, 2 GB or 4 GB:</p> <ul style="list-style-type: none"> <li>■ 128-GB</li> <li>■ 80-GB</li> </ul>
<b>Microphone</b>	Integrated dual-array digital microphone
<b>Audio</b>	<p>High-definition audio</p> <p>Stereo speakers (2)</p>
<b>Webcam</b>	Integrated 2-megapixel camera

(Continued)

Category	Description
<b>Ethernet</b>	<p>Realtek RTL811DL-VR10/100/1000 network interface card (NIC)</p> <p>NIC Power Down technology</p> <p>S3/S4/S5 wake on LAN (AC mode only)</p> <p>Ethernet cable not included</p>
<b>Wireless</b>	<p>Integrated wireless local-area network (WLAN) options via half MiniCard:</p> <ul style="list-style-type: none"> <li>■ Broadcom 802.11 b/g/n WLAN module</li> <li>■ Broadcom 43224 802.11a/b/g/n 2x2 WiFi adapter</li> </ul> <p>Supports no-WLAN option</p> <p>2 WLAN antennas built into the display assembly</p> <hr/> <p>Integrated wireless wide-area network (WWAN) options via Mini PCI module:</p> <p>UNDP High-speed packet access (HSPA), evolution-data optimized (EV-DO) WWAN module</p> <p>WWAN security provided by subscriber identity module (SIM), user-accessible behind battery</p> <p>2 WWAN antennas (worldwide, 5-band) built into the display assembly</p> <p>Supports no-WWAN option</p> <p>Supports WWAN aftermarket option</p> <hr/> <p>Integrated wireless personal-area network (WPAN) options via Bluetooth® module</p> <p>Supports no-WPAN option</p>
<b>External media cards</b>	<p>SD Card Reader supporting the following optional digital card formats:</p> <ul style="list-style-type: none"> <li>■ MultiMediaCard (MMC)</li> <li>■ Secure Digital (SD) Memory Card</li> </ul>
<b>Ports</b>	<p>Combo headphone microphone (supports audio-in/stereo microphone and audio-out/stereo headphone)</p> <p>Multi-pin AC power</p> <p>RJ-45 (Ethernet, includes link and activity lights)</p> <p>USB v. 2.0 (3, one powered)</p> <p>DisplayPort (Dsub 15-pin) supporting 1600 × 1200 external resolution at 75 GHz</p>
<b>Keyboard/pointing devices</b>	<p>Keyboard with Dura-Keys</p> <p>TouchPad with TouchPad buttons</p> <p>Supports 2-way and 4-way scroll with legend</p> <p>Supports gestures (enabled by default)</p> <p>Taps enabled by default</p>
<b>Power requirements</b>	<p>65-W AC HP Smart Adapter</p> <p>65-W AC HP Slim Adapter (for use only in Japan)</p> <p>Supports multi-pin AC connector and 3-wire plug (with ground pin)</p> <p>Supports 6-cell, 2.80-Ah battery</p> <p>Supports 4-cell, 2.80-Ah battery</p> <p>Supports HP Fast Charge technology only on 6-cell battery</p>
<b>Security</b>	<p>Security cable slot</p> <p>HP fingerprint sensor (optional)</p> <p>Full-volume encryption</p> <p>Intel AT support</p> <p>HP face recognition</p> <p>Privacy filter</p> <p>Preboot authentication (password and smart card)</p>

(Continued)



Category	Description
Operating system	<p><b>Preinstalled:</b></p> <ul style="list-style-type: none"> <li>■ Windows 7 Home Premium 32 (French Canada and Japan)</li> <li>■ Windows 7 Home Premium 64 (French Canada and Japan)</li> <li>■ Windows 7 Professional (Pro) 32 (French Canada and Japan)</li> <li>■ Windows 7 Professional 64 (French Canada and Japan)</li> <li>■ Windows 7 Professional (with Windows XP Pro images) ( French Canada and Japan)</li> <li>■ Windows Vista Home Basic (fFrench Canada and Japan)</li> <li>■ FreeDOS (all countries and regions)</li> <li>■ Red Flag Linux (the People’s Republic of China only)</li> <li>■ SuSe Linux (all countries and regions)</li> </ul> <hr/> <p><b>Preinstalled with Microsoft® Office:</b></p> <ul style="list-style-type: none"> <li>■ Windows 7 Home Basic 32 with Office 2007 Ready (limited Europe, MIddle East, Asia (EMEA) region)</li> <li>■ Windows 7 Home Basic 32 with Office 2010 Ready (limited Asia Pacific, Japan (APJ) region)</li> <li>■ Windows 7 Home Premium 32 with Office 2007 Ready (EMEA region)</li> <li>■ Windows 7 Home Premium 32 with Office 2010 Ready (APJ region)</li> <li>■ Windows 7 Home Premium 32 with Home and Business 2010 (Japan)</li> <li>■ Windows 7 Home Premium 32 Personal 2010 (Japan)</li> <li>■ Windows 7 Home Premium 32 Professional 2010(Japan)</li> <li>■ Windows 7 Home Premium 64 with Office 2007 Ready (EMEA region)</li> <li>■ Windows 7 Home Premium 64 with Office 2010 Ready (APJ region)</li> <li>■ Windows 7 Home Premium 64 with Home and Business 2010 (Japan)</li> <li>■ Windows 7 Home Premium 64 Personal 2010 (Japan)</li> <li>■ Windows 7 Home Premium 64 Professional 2010 (Japan)</li> <li>■ Windows 7 Pro 32 with Office 2007 Ready (EMEA region)</li> <li>■ Windows 7 Pro 32 with Office 2010 Ready (APJ region)</li> <li>■ Windows 7 Pro 32 with Home and Business 2010 (Japan)</li> <li>■ Windows 7 Pro 32 Personal 2010 (Japan)</li> <li>■ Windows 7 Pro 32 Pro 2010 (Japan)</li> <li>■ Windows 7 Pro 64 with Office 2007 Ready (EMEA region)</li> <li>■ Windows 7 Pro 64 with Office 2010 Ready (APJ region)</li> <li>■ Windows 7 Pro 64 with Home and Business 2010 (Japan)</li> <li>■ Windows 7 Pro 64 Personal 2010 (Japan)</li> <li>■ Windows 7 Pro 64 Pro 2010 (Japan)</li> <li>■ Windows 7 Pro 32 (with Windows XP Pro images) with Office 2007 Ready</li> <li>■ Windows 7 Pro 32 (with Windows XP Pro images) with Office Personal (Japan)</li> <li>■ Windows 7 Pro 32 (with Windows XP Pro images) with Office Personal with PowerPoint (Japan)</li> <li>■ Windows 7 Pro 32 (with Windows XP Pro images) with Office Pro (Japan)</li> <li>■ Windows Vista Home Basic with Office 2007 Ready (Europe, Middle East, Asia region)</li> <li>■ Windows Vista Home Basic with Office 2010 Ready (Asia Pacific and Japan region)</li> </ul>

(Continued)

Category	Description
	<p><b>Restore media:</b>  <b>Available with Windows 7 Pro 32, Windows 7 Pro 64, Windows 7 Pro with Windows XP images:</b></p> <ul style="list-style-type: none"> <li>■ Windows XP Pro</li> <li>■ Windows 7 Pro 32</li> <li>■ Windows 7 Pro 64</li> <li>■ DRDVD Windows XP Pro</li> </ul> <p><b>Available with Windows 7 Home Premium 32, Windows 7 Home Premium 64</b></p> <ul style="list-style-type: none"> <li>■ Windows 7 Home Premium 32</li> <li>■ Windows 7 Home Premium 64</li> </ul> <p><b>Available with Windows Vista Home Basic</b></p> <ul style="list-style-type: none"> <li>■ Windows Vista Home Basic</li> <li>■ DRDVD Windows Vista</li> <li>■ DRDVD Windows 7 (Windows 7)</li> <li>■ Windows 7 Home Basic 32 (Windows 7 Basic 32)</li> </ul> <hr/> <p><b>Certified:</b></p> <ul style="list-style-type: none"> <li>■ Microsoft WHQL</li> </ul> <hr/> <p><b>Web-only support:</b></p> <ul style="list-style-type: none"> <li>■ Windows Vista Enterprise 64 and 32</li> <li>■ Windows Vista Business</li> </ul>
<p><b>Serviceability</b></p>	<p><b>End-user replaceable parts:</b></p> <ul style="list-style-type: none"> <li>AC adapter</li> <li>Battery (system)</li> <li>Hard drive</li> <li>Memory module</li> <li>SIM</li> <li>Solid-state drive</li> <li>WLAN module</li> <li>WWAN module</li> </ul>

---

## External component identification

### Identifying hardware

Components included with the computer may vary by region and model. The illustrations in this chapter identify the standard features on most computer models.

To see a list of hardware installed in the computer, follow these steps:

In Windows 7:

» Select **Start > Control Panel > System and Security > Device Manager**.



---

Windows includes the User Account Control feature to improve the security of your computer. You may be prompted for your permission or password for tasks such as installing software, running utilities, or changing Windows settings. Refer to Help and Support for more information.

---

In Windows Vista:

1. Select **Start > Computer > System Properties**.
2. In the left pane, click **Device Manager**.



---

Windows includes the User Account Control feature to improve the security of your computer. You may be prompted for your permission or password for tasks such as installing software, running utilities, or changing Windows settings. Refer to Help and Support for more information.

---

In Windows XP:

1. Select **Start > My Computer**.
2. In the left pane of the System Tasks window, select **View system information**.
3. Select **Hardware** tab > **Device Manager**.

You can also add hardware or modify device configurations using Device Manager.

## Top components

### Display components



Your computer may look slightly different from the illustration in this section.

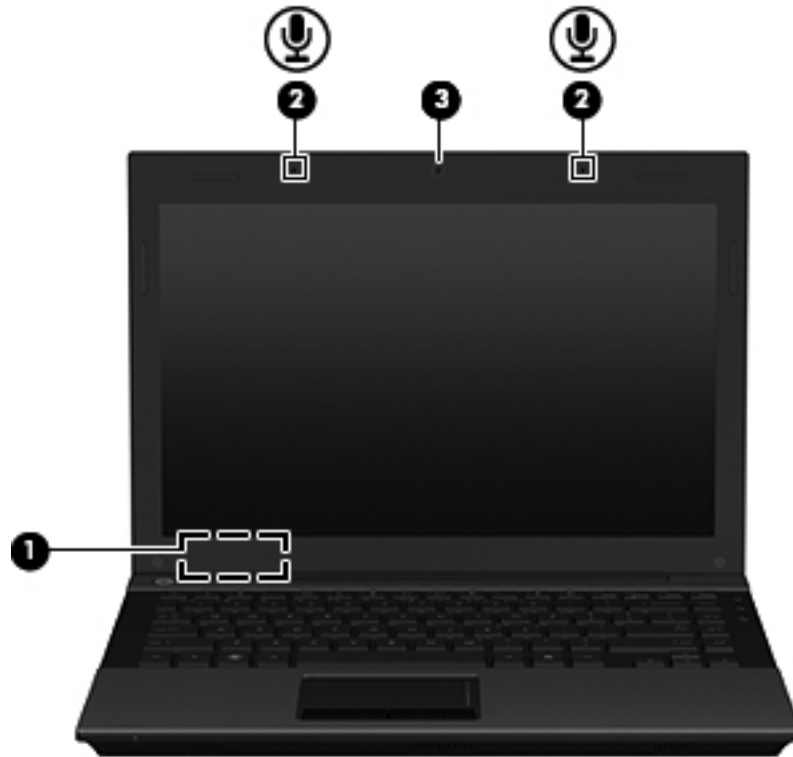

Item	Component	Description
(1)	Internal display switch	Turns off the display and initiates Sleep (Windows 7 and Windows Vista) or Standby (Windows XP) if the display is closed while the power is on.
(2)	Internal microphones (2)	Record sound.  If there is a microphone icon next to each microphone opening, your computer has internal microphones.
(3)	Webcam	Records video and captures still photographs.

## Wireless antennas (select models only)

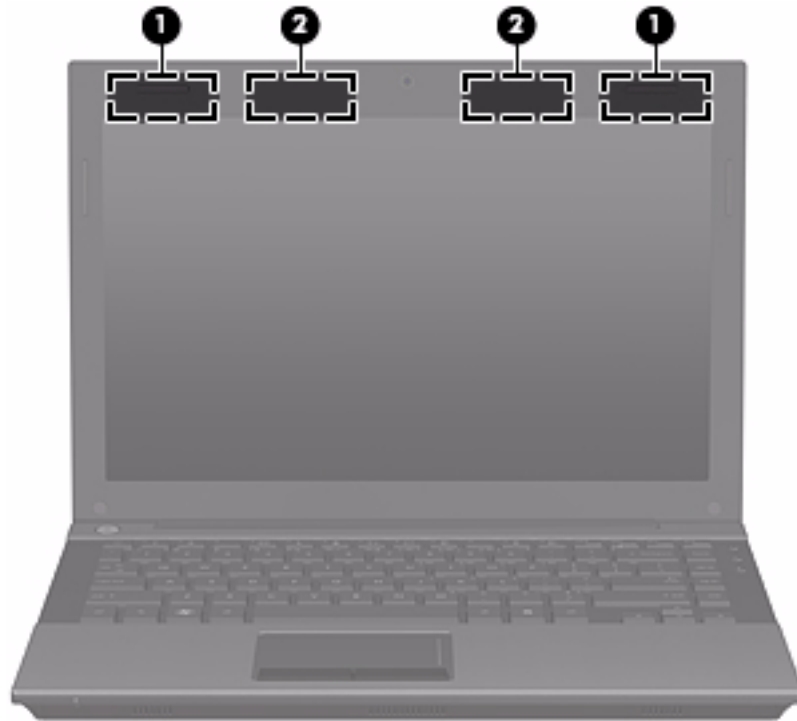

Item	Component	Description
(1)	WWAN antennas (2)* (select models only)	Send and receive wireless signals to communicate with wireless wide-area networks (WWANs).
(2)	WLAN antennas (2)* (select models only)	Send and receive wireless signals to communicate with wireless local area networks (WLANs).

\*The antennas are not visible from the outside of the computer. For optimal transmission, keep the areas immediately around the antennas free from obstructions.

To see wireless regulatory notices, refer to the section of the *Regulatory, Safety and Environmental Notices* that applies to your country or region. These notices are located in Help and Support.

## Buttons



Item	Component	Description
(1)	Power button	<ul style="list-style-type: none"> <li>■ When the computer is off, press the button to turn on the computer.</li> <li>■ When the computer is on, press the button to shut down the computer.</li> </ul> <p> Although you can shut down the computer with the power button, the recommended procedure is to use the Windows Shut Down command.</p> <ul style="list-style-type: none"> <li>■ When the computer is in the Sleep state (Windows 7 and Windows Vista) or Standby (Windows XP), press the button briefly to exit the Sleep state (Windows 7 and Windows Vista) or Standby (Windows XP).</li> <li>■ When the computer is in Hibernation, press the button briefly to exit Hibernation.</li> </ul> <p>If the computer has stopped responding and Windows shutdown procedures are ineffective, press and hold the power button for at least 5 seconds to turn off the computer.</p> <p>To learn more about your power settings:</p> <ul style="list-style-type: none"> <li>■ In Windows 7: Select <b>Start &gt; Control Panel &gt; System and Security &gt; Power Options</b>.</li> <li>■ In Windows Vista: Select <b>Start &gt; Control Panel &gt; System and Maintenance &gt; Power Options</b>.</li> <li>■ In Windows XP: Select <b>Start &gt; Control Panel &gt; Performance and Maintenance &gt; Power Options</b>.</li> </ul>
(2)	Wireless button	Turns the wireless feature on or off but does not establish a wireless connection.
(3)	QuickLook button	Allows you to save calendar, contact, inbox, and task information from Microsoft Outlook to the hard drive of your computer. When the computer is off or in Hibernation, you can press the QuickLook button to view this information without waiting for the operating system to restart.
(4)	QuickWeb button	Opens the Web browser.

## Keys



Your computer may look slightly different from the illustration in this section.

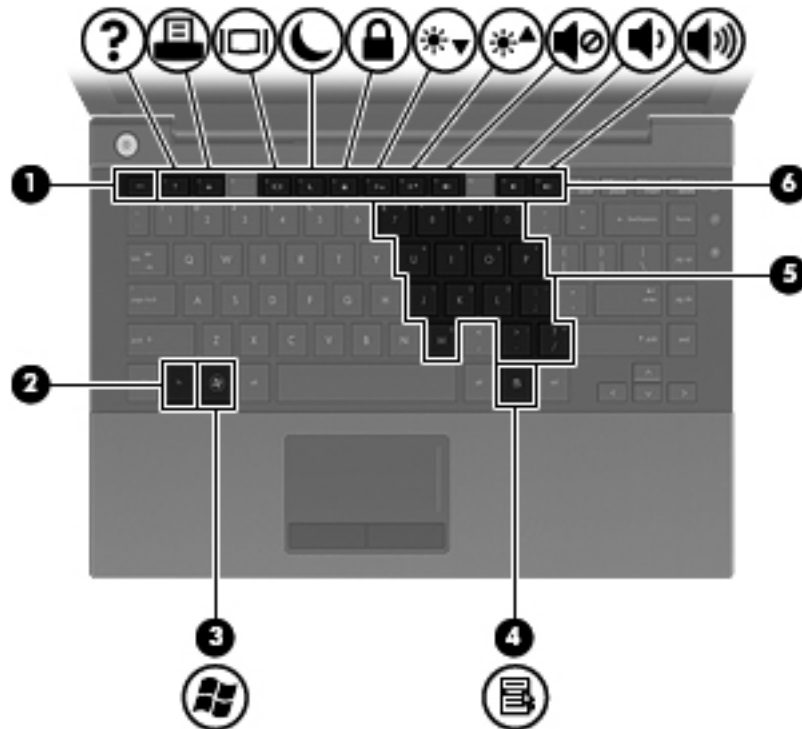

Item	Component	Description
(1)	<b>esc</b> key	Displays system information when pressed in combination with the <b>fn</b> key.
(2)	<b>fn</b> key	Executes frequently used system functions when pressed in combination with a function key or the <b>esc</b> key.
(3)	Windows logo key	Displays the Windows Start menu.
(4)	Windows applications key	Displays a shortcut menu for items beneath the pointer.
(5)	Embedded numeric keypad keys	Can be used like the keys on an external numeric keypad.
(6)	Function keys	Execute frequently used system functions when pressed in combination with the <b>fn</b> key.

## Lights



Your computer may look slightly different from the illustration in this section.



Item	Component	Description
(1)	Power light	<ul style="list-style-type: none"> <li>■ On: The computer is on.</li> <li>■ Blinking: The computer is in the Sleep state (Windows 7 and Windows Vista) or Standby (Windows XP).</li> <li>■ Off: The computer is off or in Hibernation.</li> </ul>
(2)	Caps lock light	On: Caps lock is on.
(3)	Wireless light	<ul style="list-style-type: none"> <li>■ Blue: An integrated wireless device, such as a WLAN device, the HP Mobile Broadband Module (select models only), and/or a Bluetooth device, is on.</li> <li>■ Amber: All wireless devices are off.</li> </ul>
(4)	QuickLook light	Turns on briefly when the QuickLook button is pressed.
(5)	QuickWeb light	Turns on briefly when the QuickWeb button is pressed.



## Pointing devices

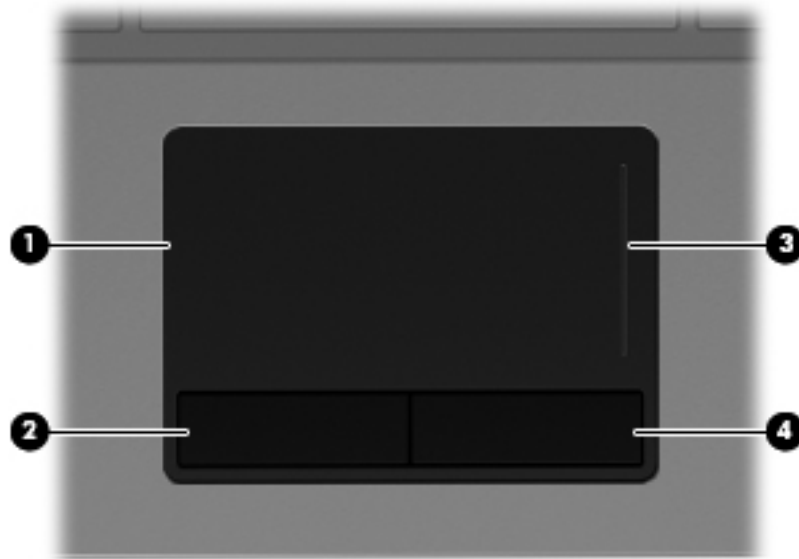



Item	Component	Description
(1)	TouchPad*	Moves the pointer and selects or activates items on the screen.
(2)	Left TouchPad button*	Functions like the left button on an external mouse.
(3)	TouchPad scroll zone	Scrolls up or down.
(4)	Right TouchPad button*	Functions like the right button on an external mouse.

\*This table describes factory settings. To view or change pointing device preferences:

- In Windows 7: Select **Start > Devices and Printers**. Then, right-click the device representing your computer, and select **Mouse settings**.
- In Windows Vista: Select **Start > Control Panel > Hardware and Sound > Mouse**.
- In Windows XP: Select **Start > Control Panel > Printers and Other Hardware > Mouse**.

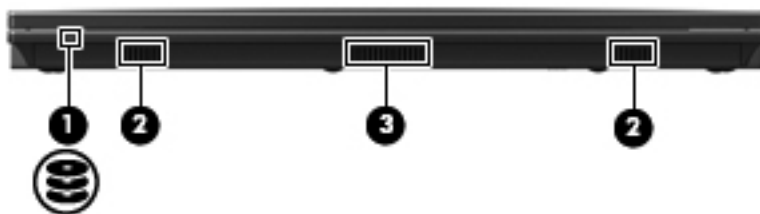

## Front components

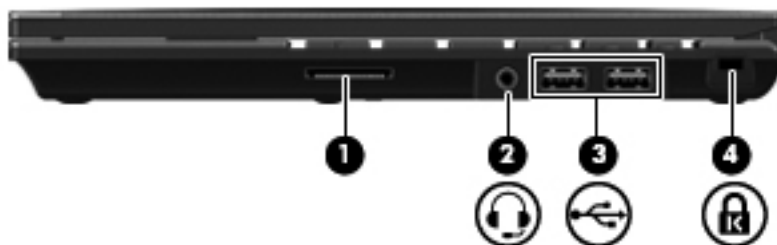

Item	Component	Description
(1)	Drive light	Blinking: The hard drive or an external optical drive is being accessed.
(2)	Speakers (2)	Produce sound.
(3)	Vent	Enables airflow to cool internal components. <p> The computer fan starts up automatically to cool internal components and prevent overheating. It is normal for the internal fan to cycle on and off during routine operation.</p>

## Right-side components



Item	Component	Description
(1)	SD Card Reader	Supports the following optional digital card formats: <ul style="list-style-type: none"> <li>■ MultiMediaCard (MMC)</li> <li>■ Secure Digital (SD) Memory Card</li> </ul>
(2)	Combo headphone microphone jack	Produces sound when connected to optional powered stereo speakers, headphones, ear buds, a headset, or television audio. Also connects an optional headset microphone. <p> When a device is connected to the headphone jack, the computer speakers are disabled.</p>
(3)	USB ports (2)	Connect optional USB devices.
(4)	Security cable slot	Attaches an optional security cable to the computer. <p> The security cable is designed to act as a deterrent, but it may not prevent the computer from being mishandled or stolen.</p>

## Left-side components

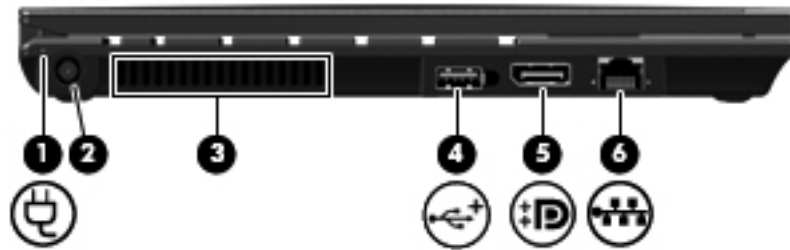

Item	Component	Description
(1)	Battery light	<ul style="list-style-type: none"> <li>■ Amber: A battery is charging.</li> <li>■ Blue: A battery is close to full charge capacity.</li> <li>■ Blinking amber: A battery that is the only available power source has reached a low battery level. When the battery reaches a critical battery level, the battery light begins blinking rapidly.</li> <li>■ Off: If the computer is plugged into an external power source, the light turns off when all batteries in the computer are fully charged. If the computer is not plugged into an external power source, the light stays off until the battery reaches a low battery level.</li> </ul>
(2)	Power connector	Connects an AC adapter.
(3)	Vent	<p>Enables airflow to cool internal components.</p> <p> The computer fan starts up automatically to cool internal components and prevent overheating. It is normal for the internal fan to cycle on and off during routine operation.</p>
(4)	Powered USB port	Provides power to a USB device, such as an optional external MultiBay or an optional external optical drive, if used with a powered USB cable.
(5)	DisplayPort	Connects an external VGA monitor or projector.
(6)	RJ-45 (network) jack	Connects a network cable.

## Bottom components

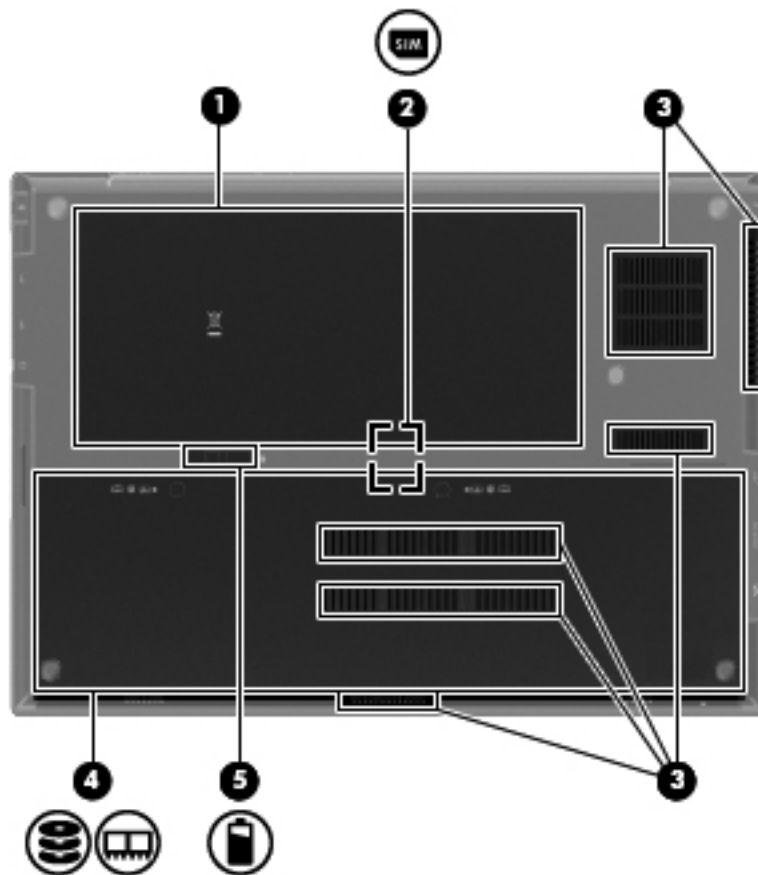

Item	Component	Description
(1)	Battery bay	Holds the battery.
(2)	SIM slot (select models only)	Contains a wireless subscriber identity module (SIM). The SIM slot is located inside the battery bay.
(3)	Vents (6)	Enable airflow to cool internal components.  The computer fan starts up automatically to cool internal components and prevent overheating. It is normal for the internal fan to cycle on and off during routine operation.
(4)	Hard drive bay	Holds the hard drive and contains the memory module slot.
(5)	Battery release latch	Releases the battery from the battery bay.

## Illustrated parts catalog

### Serial number label location

When ordering parts or requesting information, the serial number label, located on the bottom of the computer, provides important information that you may need when contacting technical support.



Serial number label location, format, and color vary on select models.

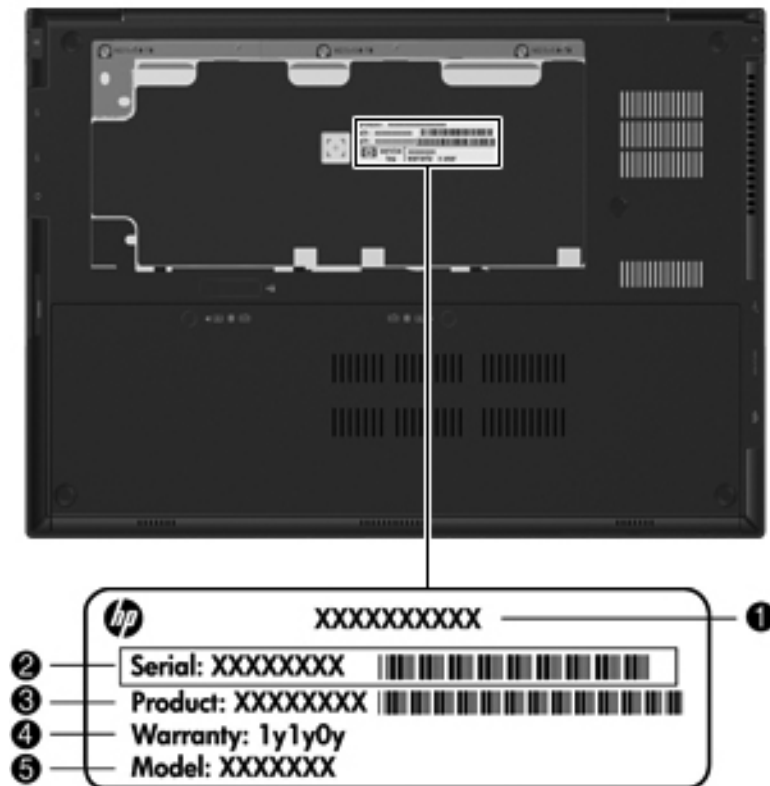

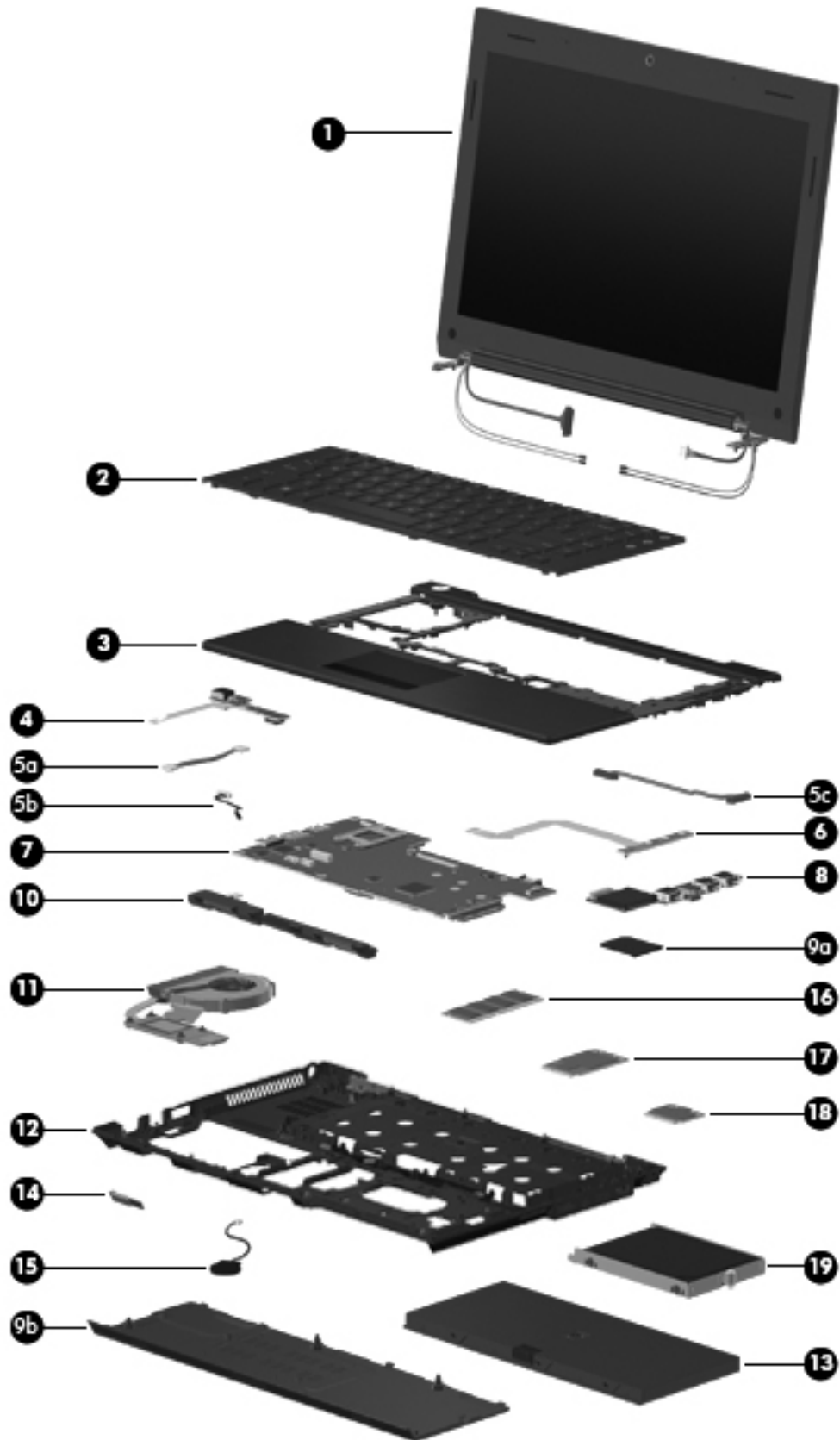

(1)	Product name	(4)	Warranty period
(2)	Serial number	(5)	Model description (select models only)
(3)	Product number		

# Computer major components



Item	Description	Spare part number
(1)	<b>Display assembly</b> (includes 2 WLAN antenna transceivers and cables, 2 WWAN antenna transceivers and cables, webcam, nameplate, and logo):	
	13.3-in, high-definition (HD), LED, AntiGlare display assembly	618827-001
	13.3-in, HD, LED, BrightView display assembly	618828-001
	 See <a href="#">"Display assembly subcomponents"</a> on page 3-7 for display assembly internal component spare part information.	
(2)	<b>Keyboard</b> (includes keyboard cable):	
	For use in Belgium	618843-A41
	For use in Bulgaria	618843-261
	For use in the Czech Republic and Slovakia	618843-A81
	For use in Denmark	618843-081
	For use in France	618843-051
	For use in France and Arabia	618843-DW1
	For use in French Canada	618843-121
	For use in Germany	618843-041
	For use in Greece	618843-DJ1
	For use in Hungary	618843-211
	For use in Iceland	618843-DD1
	For use in Israel	618843-BB1
	For use in Italy	618843-061
	For use in Japan	618843-291
	For use in the Netherlands	618843-B31
	For use in Norway	618843-091
	For use in Portugal	618843-131
	For use in Russia	618843-251
	For use in Saudi Arabia	618843-171
	For use in Slovenia	618843-BA1
	For use in South Korea	618843-AD1
	For use in Spain	618843-071
	For use in Sweden and Finland	618843-B71
	For use in Switzerland	618843-BG1
	For use in Taiwan	618843-AB1
	For use in Thailand	618843-281
	For use in Turkey	618843-141
	For use in the United Kingdom	618843-031
	For use in the United States	618843-001

(Continued)

Item	Description	Spare part number
(3)	<b>Top cover</b> with fingerprint reader (includes TouchPad button board and cable, and TouchPad board and cable)	618840-001
	<b>Top cover</b> with fingerprint reader (includes TouchPad button board and cable, and TouchPad board and cable)	618841-001
(4)	<b>Power button board</b> with FFC (includes cable)	618816-001
	<b>Cable Kit</b> , includes:	618826-001
(5a)	Power button board cable	
(5b)	Bluetooth module cable	
(5c)	USB board cable	
	 See <a href="#">"Cable Kit" on page 3-6</a> for more Cable Kit spare part information.	
(6)	<b>Button board with FFC</b> (includes cable)	618815-001
(7)	<b>System board</b> (includes processor and replacement thermal material):	
	System board with Intel® Dual Core i5-45M 2.40-GHz processor (Turbo up to 2.53 GHz), 3-M L3 cache, 4 threads (35W)	618821-001
	System board with Intel® Dual Core i5-45M 2.40-GHz processor (Turbo up to 2.53 GHz), 3-M L3 cache, 4 threads (35W), for use in China and Russia	618822-001
	System board with Intel Dual Core i3-370M 2.40-GHz processor, 3-M L3 cache, 4 threads (35W)	618819-001
	System board with Intel Dual Core i3-370M 2.40-GHz processor, 3-M L3 cache, 4 threads (35W), for use in China and Russia	618820-001
	System board with Intel Dual Core i3-350M 2.26-GHz processor, 3-M L3 cache, 4 threads (35W)	618817-001
	System board with Intel Dual Core i3-350M 2.26-GHz processor, 3-M L3 cache, 4 threads (35W), for use in China and Russia	618818-001
	System board with Intel U3400 1.06-GHz processor	618823-001
	System board with Intel U3400 1.06-GHz processor, for use in China and Russia	618824-001
(8)	<b>USB board</b> (includes cable)	618825-001
	<b>Plastics Kit</b> , includes:	618835-001
(9a)	SD Card Reader slot bezel	
(9b)	Accessory cover (includes 2 captive screws)	
	 See <a href="#">"Plastics Kit" on page 3-9</a> for more Plastics Kit spare part information.	
(10)	<b>Speaker assembly</b> (includes cable)	618839-001
(11)	<b>Fan/Heat sink</b> (includes replacement thermal material)	618830-001
(12)	<b>Base enclosure</b> (includes 6 rubber feet)	618813-001
	<b>Latch Kit</b> (not illustrated, includes battery eject arm, latch, and spring)	581090-001
	<b>Rubber Feet Kit</b> (not illustrated, includes 6 rubber feet and 2 display bezel screw covers)	581101-001
(13)	<b>4-cell, 41-WHr, 2.8-Ah battery</b>	580956-001
	<b>6-cell, 62-WHr, 2.8-Ah battery</b> (supports HP Fast Charge Technology)	594796-001
(14)	<b>Bluetooth module</b>	537921-001
	 The Bluetooth module spare part kit does not include a Bluetooth module cable. The Bluetooth module cable is included in the Cable Kit, spare part number 618826-001.	

(Continued)



Item	Description	Spare part number
(15)	<b>RTC battery</b> (includes double-sided tape)	481089-001
(16)	<b>Memory module:</b>	
	4096-MB (1333-MHz, DDR3, PC3-10600 Shared)	599092-001
	2048-MB (1066-MHz, DDR3, PC3-10600)	581096-001
	1024-MB (1066-MHz, DDR3, PC3-10600 Shared) (not available on Microsoft 64-bit operating systems)	598859-001
(17)	<b>HSPA EV-DO WWAN module</b> (does not support Linux operating system; available in all countries and regions, except China)	531993-001
(18)	<b>WLAN module:</b>	
	<b>802.11 a/b/g/n WLAN module:</b>	
	■ Broadcom 43224 802.11 a/g/n WLAN module for use in Antigua and Barbuda, Barbados, Belize, Canada, the Cayman Islands, Guam, Puerto Rico, Trinidad and Tobago, the U.S. Virgin Islands, and the United States	582564-001
	■ Broadcom 43224 802.11 a/g/n WLAN module for use in Afghanistan, Albania, Algeria, Andorra, Angola, Argentina, Armenia, Aruba, Australia, Austria, Azerbaijan, the Bahamas, Bahrain, Bangladesh, Barbados, Belarus, Belgium, Belize, Benin, Bermuda, Bhutan, Bolivia, Bosnia and Herzegovina, Botswana, Brazil, the British Virgin Islands, Brunei, Bulgaria, Burkina Faso, Burundi, Cambodia, Cameroon, Cape Verde, the Central African Republic, Chad, Chile, Colombia, Comoros, the Congo, Costa Rica, Croatia, Cyprus, the Czech Republic, Denmark, Djibouti, Dominica, the Dominican Republic, East Timor, Ecuador, Egypt, El Salvador, Equatorial Guinea, Eritrea, Estonia, Ethiopia, Fiji, Finland, France, French Guiana, Gabon, Gambia, Georgia, Germany, Ghana, Gibraltar, Greece, Grenada, Guadeloupe, Guatemala, Guinea, Guinea-Bissau, Guyana, Haiti, Honduras, Hong Kong, Hungary, Iceland, India, Indonesia, Ireland, Italy, the Ivory Coast, Jamaica, Japan, Jordan, Kazakhstan, Kenya, Kiribati, Kuwait, Kyrgyzstan, Laos, Latvia, Lebanon, Lesotho, Liberia, Liechtenstein, Lithuania, Luxembourg, Macedonia, Madagascar, Malawi, Malaysia, the Maldives, Mali, Malta, the Marshall Islands, Martinique, Mauritania, Mauritius, Mexico, Micronesia, Monaco, Mongolia, Montenegro, Morocco, Mozambique, Namibia, Nauru, Nepal, the Nether Antilles, the Netherlands, New Zealand, Nicaragua, Niger, Nigeria, Norway, Oman, Pakistan, Palau, Panama, Papua New Guinea, Paraguay, the People's Republic of China, Peru, the Philippines, Poland, Portugal, Qatar, the Republic of Moldova, Romania, Russia, Rwanda, Samoa, San Marino, Sao Tome and Principe, Saudi Arabia, Senegal, Serbia, the Seychelles, Sierra Leone, Singapore, Slovakia, Slovenia, the Solomon Islands, Somalia, South Africa, South Korea, Spain, Sri Lanka, St. Kitts and Nevis, St. Lucia, St. Vincent, Suriname, Swaziland, Sweden, Switzerland, Taiwan, Tajikistan, Tanzania, Thailand, Togo, Tonga, Tunisia, Turkey, Turkmenistan, Tuvalu, Uganda, Ukraine, the United Arab Emirates, the United Kingdom, Uruguay, Uzbekistan, Vanuatu, Venezuela, Vietnam, Yemen, Zaire, Zambia, and Zimbabwe	582564-002
(18)	<b>802.11 b/g/n WLAN module:</b>	
	■ Broadcom 4312G 802.11 b/g/n WLAN module for use in Canada, the Cayman Islands, Guam, Puerto Rico, the United States, and the U.S. Virgin Islands	593836-001
(19)	<b>Mass storage device</b> (includes bracket):	
	<b>Hard drive:</b>	
	■ 500-GB, 7200 rpm	618829-001
	■ 320-GB, 7200 rpm	581084-001
	■ 250-GB, 7200 rpm	581083-001
	<b>Solid-state drive</b> (only with computer models running Windows 7 operating system, 2 GB or 4 GB):	
	■ 128-GB	581085-001
	■ 80-GB	581086-001

## Cable Kit

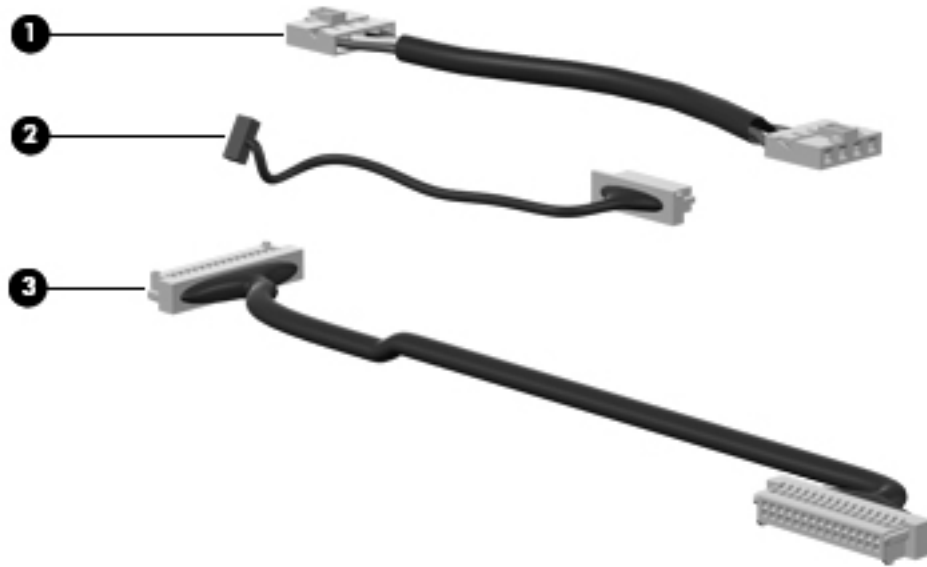

Item	Description	Spare part number
	<b>Cable Kit:</b>	618826-001
(1)	Power button board cable	
(2)	Bluetooth module cable	
(3)	USB board cable	

## Display assembly subcomponents

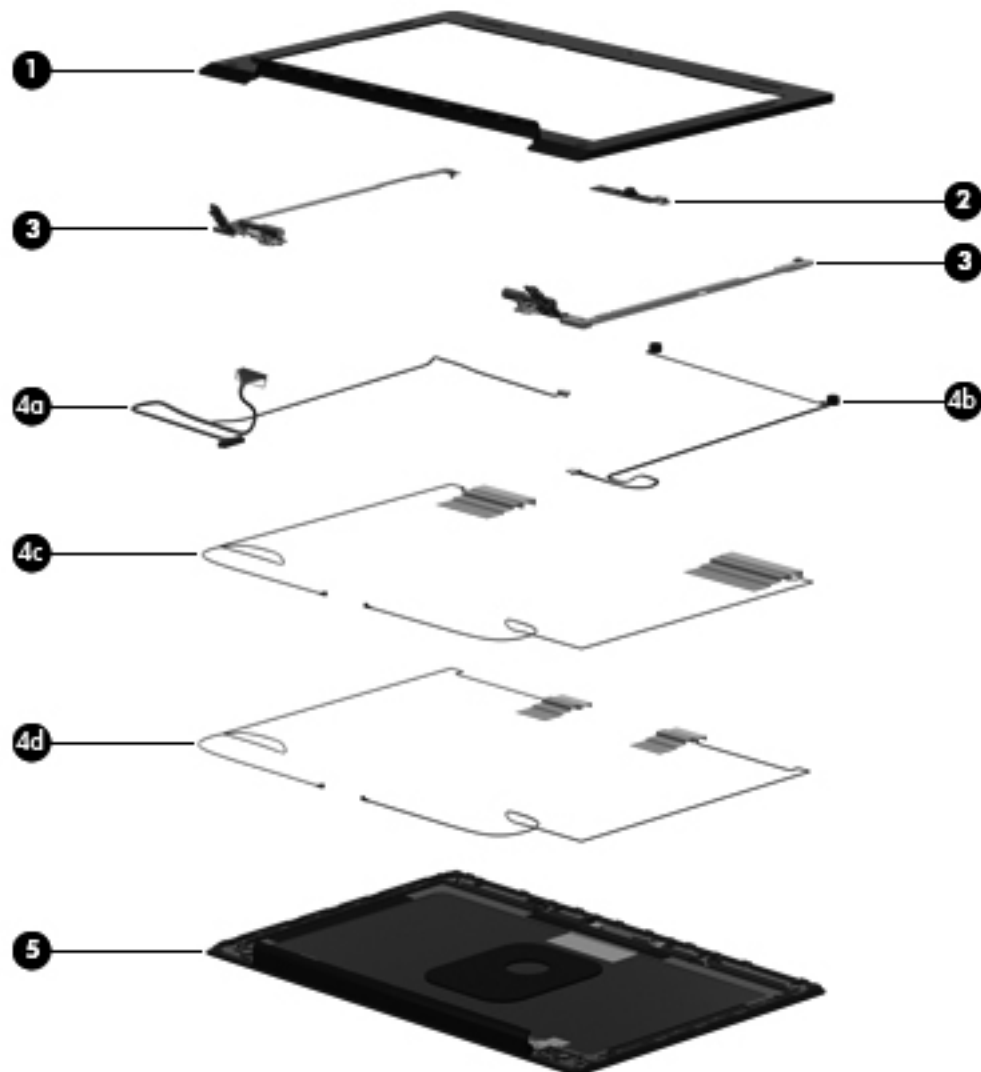

Item	Description	Spare part number
(1)	Display bezel	618832-001
(2)	Webcam module	618842-001
(3)	Display Hinge Kit (includes left and right hinges)	581094-001
	Display Cable Kit, includes:	618833-001
(4a)	Display panel cable and webcam cable	
(4b)	Microphones and cables	
(4c)	WWAN antenna transceivers and cables	
(4d)	WLAN antenna transceivers and cables	
(5)	Display enclosure (includes microphones and cables, WLAN antenna transceivers and cables, and WWAN antenna transceivers and cables)	618831-001

## Mass storage devices

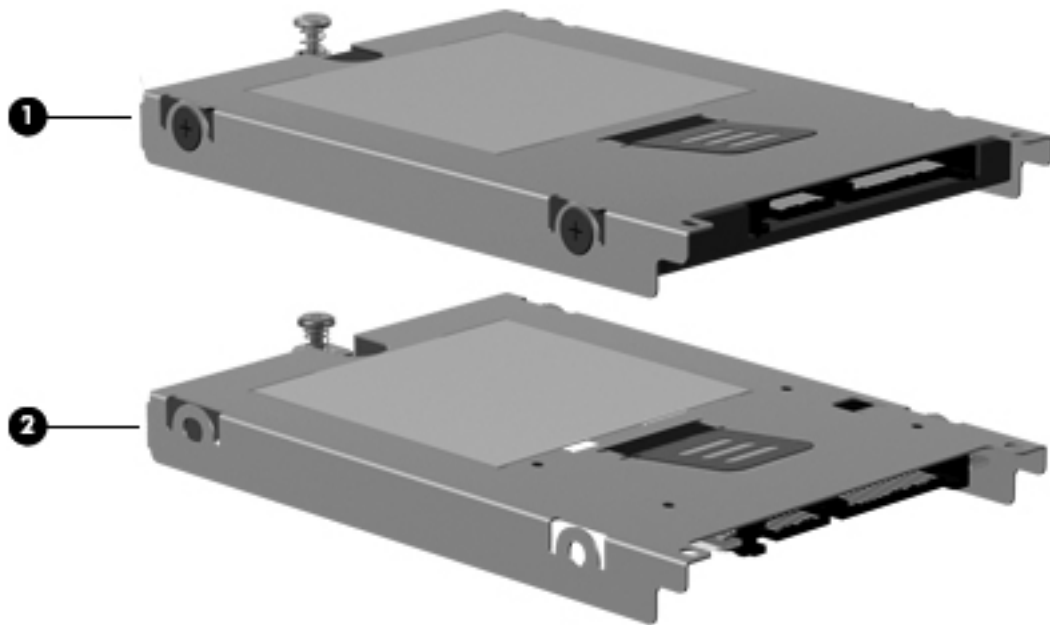

Item	Description	Spare part number
(1)	<b>Hard drive</b> (includes bracket):	
	500-GB, 7200 rpm	618829-001
	320-GB, 7200 rpm	581084-001
	250-GB, 7200 rpm	581083-001
(2)	<b>Solid-state drive</b> (includes bracket), only with computer models running Windows 7 operating system, either 2 GB or 4 GB:	
	128-GB	581085-001
	80-GB	581086-001

## Plastics Kit

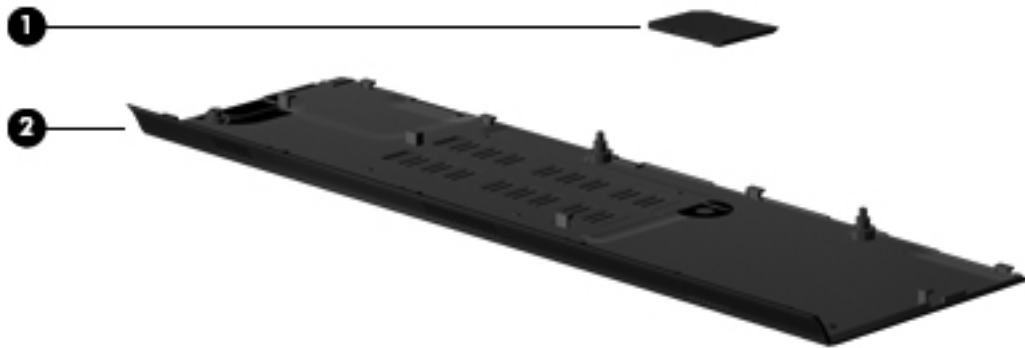

Item	Description	Spare part number
	<b>Plastics Kit:</b>	618835-001
(1)	SD Card Reader slot bezel	
(2)	Accessory cover (includes 2 captive screws)	

## Miscellaneous parts

Description	Spare part number
<b>65-W PFC RC/V HP Smart Adapter</b>	613161-001
<b>65-W PFC RC/V HP Slim Adapter</b> (for use only in Japan)	613152-001
<b>Power cord:</b>	
For use in Australia	490371-011
For use in Denmark	490371-081
For use in Europe, the Middle East, and Africa	490371-021
For use in India	490371-D61
For use in Israel	490371-BB1
For use in Italy	490371-061
For use in Japan	490371-291
For use in the People's Republic of China	490371-AA1
For use in South Africa	490371-AR1
For use in South Korea	490371-AD1
For use in Switzerland	490371-111
For use in Taiwan	490371-AB1
For use in the United Kingdom and Singapore	490371-031
For use in the United States	490371-001
<b>Screw Kit:</b>	618838-001
Phillips PM3.0x4.0 screw	
Phillips PM2.5x11.0 captive screw	
Phillips PM2.5x6.0 captive screw	
Phillips PM2.5x5.0 screw	
Phillips PM2.5x4.0 broadhead screw	
Phillips PM2.5x4.0 screw	
Phillips PM2.5x2.0 broadhead screw	
Slotted Torx T8M2.5x7.0 screw	
Torx T8M2.5x9.0 screw	
Torx T8M2.0x7.0 captive screw	
Torx T8M2.5x6.0 screw	
Torx T8M2.5x5.0 screw	
Torx T8M2.5x4.0 screw	

## Sequential part number listing

Spare part number	Description
481089-001	RTC battery (includes double-sided tape)
490371-001	Power cord for use in the United States
490371-011	Power cord for use in Australia
490371-021	Power cord for use in Europe, the Middle East, and Africa
490371-031	Power cord for use in the United Kingdom and Singapore
490371-061	Power cord for use in Italy
490371-081	Power cord for use in Denmark
490371-111	Power cord for use in Switzerland
490371-291	Power cord for use in Japan
490371-AA1	Power cord for use in the People's Republic of China
490371-AB1	Power cord for use in Taiwan
490371-AD1	Power cord for use in South Korea
490371-AR1	Power cord for use in South Africa
490371-BB1	Power cord for use in Israel
490371-D61	Power cord for use in India
531993-001	HSPA EV-DO WWAN module (does not support Linux operating system; available in all countries and regions, except China)
537921-001	Bluetooth module  The Bluetooth module spare part kit does not include a Bluetooth module cable. The Bluetooth module cable is included in the Cable Kit, spare part number 618826-001.
580956-001	4-cell, 41-WHr, 2.8-Ah battery
581094-001	Display Hinge Kit (includes left and right hinges)
581096-001	2048-MB memory module (1333-MHz, DDR3)
581083-001	250-GB, 7200-rpm hard drive (includes bracket)
581084-001	320-GB, 7200-rpm hard drive (includes bracket)
581085-001	128-GB solid-state drive (includes bracket), only with computer models running Windows 7 operating system, either 2 GB or 4 GB
581086-001	80-GB solid-state drive (includes bracket), only with computer models running Windows 7 operating system, either 2 GB or 4 GB
581090-001	Latch Kit (includes battery eject arm, latch, and spring)
581101-001	Rubber Feet Kit (includes 6 rubber feet and 2 display bezel screw covers)
582564-001	Broadcom 43224 802.11 a/b/g/n WLAN module for use in Antigua and Barbuda, Barbados, Belize, Canada, the Cayman Islands, Guam, Puerto Rico, Trinidad and Tobago, the U.S. Virgin Islands, and the United States

(Continued)

Spare part number	Description
582564-002	Broadcom 43224 802.11 a/b/g/n WLAN module for use in Afghanistan, Albania, Algeria, Andorra, Angola, Argentina, Armenia, Aruba, Australia, Austria, Azerbaijan, the Bahamas, Bahrain, Bangladesh, Barbados, Belarus, Belgium, Belize, Benin, Bermuda, Bhutan, Bolivia, Bosnia and Herzegovina, Botswana, Brazil, the British Virgin Islands, Brunei, Bulgaria, Burkina Faso, Burundi, Cambodia, Cameroon, Cape Verde, the Central African Republic, Chad, Chile, Colombia, Comoros, the Congo, Costa Rica, Croatia, Cyprus, the Czech Republic, Denmark, Djibouti, Dominica, the Dominican Republic, East Timor, Ecuador, Egypt, El Salvador, Equatorial Guinea, Eritrea, Estonia, Ethiopia, Fiji, Finland, France, French Guiana, Gabon, Gambia, Georgia, Germany, Ghana, Gibraltar, Greece, Grenada, Guadeloupe, Guatemala, Guinea, Guinea-Bissau, Guyana, Haiti, Honduras, Hong Kong, Hungary, Iceland, India, Indonesia, Ireland, Italy, the Ivory Coast, Jamaica, Japan, Jordan, Kazakhstan, Kenya, Kiribati, Kuwait, Kyrgyzstan, Laos, Latvia, Lebanon, Lesotho, Liberia, Liechtenstein, Lithuania, Luxembourg, Macedonia, Madagascar, Malawi, Malaysia, the Maldives, Mali, Malta, the Marshall Islands, Martinique, Mauritania, Mauritius, Mexico, Micronesia, Monaco, Mongolia, Montenegro, Morocco, Mozambique, Namibia, Nauru, Nepal, the Nether Antilles, the Netherlands, New Zealand, Nicaragua, Niger, Nigeria, Norway, Oman, Pakistan, Palau, Panama, Papua New Guinea, Paraguay, the People's Republic of China, Peru, the Philippines, Poland, Portugal, Qatar, the Republic of Moldova, Romania, Russia, Rwanda, Samoa, San Marino, Sao Tome and Principe, Saudi Arabia, Senegal, Serbia, the Seychelles, Sierra Leone, Singapore, Slovakia, Slovenia, the Solomon Islands, Somalia, South Africa, South Korea, Spain, Sri Lanka, St. Kitts and Nevis, St. Lucia, St. Vincent, Suriname, Swaziland, Sweden, Switzerland, Taiwan, Tajikistan, Tanzania, Thailand, Togo, Tonga, Tunisia, Turkey, Turkmenistan, Tuvalu, Uganda, Ukraine, the United Arab Emirates, the United Kingdom, Uruguay, Uzbekistan, Vanuatu, Venezuela, Vietnam, Yemen, Zaire, Zambia, and Zimbabwe
593836-001	Broadcom 4312G 802.11 b/g/n WLAN module for use in Canada, the Cayman Islands, Guam, Puerto Rico, the United States, and the U.S. Virgin Islands
594796-001	6-cell, 62-WHr, 2.8-Ah battery (supports HP Fast Charge technology)
598859-001	1024-MB memory module (1333-MHz, DDR3, PC3-10600 Shared) (not available on Microsoft 64-bit operating systems)
599092-001	4096-MB memory module (1333-MHz, DDR3, PC3-10600 Shared)
613152-001	65-W PFC RC/V HP Slim Adapter
613161-001	65-W PFC RC/V HP Smart Adapter (for use only in Japan)
618813-001	Base enclosure (includes 6 rubber feet)
618815-001	Button board with FFC (includes cable)
618816-001	Power button board with FFC (includes cable)
618817-001	System board with Intel Dual Core i3-350M 2.26-GHz processor, 3-M L3 cache, 4 threads (35W)
618818-001	System board with Intel Dual Core i3-350M 2.26-GHz processor, 3-M L3 cache, 4 threads (35W), for use in China and Russia
618819-001	System board with Intel Dual Core i3-370M 2.40-GHz processor, 3-M L3 cache, 4 threads (35W)
618820-001	System board with Intel Dual Core i3-370M 2.40-GHz processor, 3-M L3 cache, 4 threads (35W), for use in China and Russia
618821-001	System board with Intel® Dual Core i5-45M 2.40-GHz processor (Turbo up to 2.53 GHz), 3-M L3 cache, 4 threads (35W)
618822-001	System board with Intel® Dual Core i5-45M 2.40-GHz processor (Turbo up to 2.53 GHz), 3-M L3 cache, 4 threads (35W), for use in China and Russia
618823-001	System board with Intel U3400 1.06-GHz processor
618824-001	System board with Intel U3400 1.06-GHz processor, for use in China and Russia
618825-001	USB board (includes cable)
618826-001	Cable Kit
	 See "Cable Kit" on page 3-6 for more Cable Kit spare part information.

(Continued)



Spare part number	Description
618827-001	13.3-in, HD, LED, AntiGlare display assembly (includes 2 WLAN antenna transceivers and cables, 2 WWAN antenna transceivers and cables, webcam, nameplate, and logo)
618828-001	13.3-in, HD, LED, BrightView display assembly (includes 2 WLAN antenna transceivers and cables, 2 WWAN antenna transceivers and cables, webcam, nameplate, and logo)
618829-001	500-GB, 7200-rpm hard drive (includes bracket)
618830-001	Fan/Heat sink (includes replacement thermal material)
618831-001	Display enclosure (includes microphones and cables, WLAN antenna transceivers and cables, and WWAN antenna transceivers and cables)
618832-001	Display bezel
618833-001	Display Cable Kit (includes display panel cable and webcam cable, microphones and cables, WLAN antenna transceivers and cables, and WWAN antenna transceivers and cables)
618835-001	Plastics Kit  See "Plastics Kit" on page 3-9 for more Plastics Kit spare part information.
618838-001	Screw Kit
618839-001	Speaker assembly (includes cable)
618840-001	Top cover with fingerprint reader (includes TouchPad button board and cable, and TouchPad board and cable)
618841-001	Top cover with no fingerprint reader (includes TouchPad button board and cable, and TouchPad board and cable)
618842-001	Webcam module
618843-001	Keyboard for use in the United States (includes keyboard cable)
618843-031	Keyboard for use in the United Kingdom (includes keyboard cable)
618843-041	Keyboard for use in Germany (includes keyboard cable)
618843-051	Keyboard for use in France (includes keyboard cable)
618843-061	Keyboard for use in Italy (includes keyboard cable)
618843-071	Keyboard for use in Spain (includes keyboard cable)
618843-081	Keyboard for use in Denmark (includes keyboard cable)
618843-091	Keyboard for use in Norway (includes keyboard cable)
618843-121	Keyboard for use in French Canada (includes keyboard cable)
618843-131	Keyboard for use in Portugal (includes keyboard cable)
618843-141	Keyboard for use in Turkey (includes keyboard cable)
618843-171	Keyboard for use in Saudi Arabia (includes keyboard cable)
618843-211	Keyboard for use in Hungary (includes keyboard cable)
618843-251	Keyboard for use in Russia (includes keyboard cable)
618843-261	Keyboard for use in Bulgaria (includes keyboard cable)
618843-281	Keyboard for use in Thailand (includes keyboard cable)
618843-291	Keyboard for use in Japan (includes keyboard cable)
618843-A41	Keyboard for use in Belgium (includes keyboard cable)
618843-A81	Keyboard for use in the Czech Republic and Slovakia(includes keyboard cable)
618843-AB1	Keyboard for use in Taiwan (includes keyboard cable)

(Continued)

<b>Spare part number</b>	<b>Description</b>
618843-AD1	Keyboard for use in South Korea (includes keyboard cable)
618843-B31	Keyboard for use in the Netherlands (includes keyboard cable)
618843-B71	Keyboard for use in Sweden and Finland (includes keyboard cable)
618843-BA1	Keyboard for use in Slovenia (includes keyboard cable)
618843-BB1	Keyboard for use in Israel (includes keyboard cable)
618843-BG1	Keyboard for use in Switzerland (includes keyboard cable)
618843-DD1	Keyboard for use in Iceland (includes keyboard cable)
618843-DJ1	Keyboard for use in Greece (includes keyboard cable)
618843_DW1	Keyboard for use in France and Arabia (includes keyboard cable)

---

# Removal and replacement procedures

## Preliminary replacement requirements

### Tools required

You will need the following tools to complete the removal and replacement procedures:

- Flat-bladed screwdriver
- Phillips P0 screwdriver
- Phillips P1 screwdriver
- Torx T8 screwdriver

### Service considerations

The following sections include some of the considerations that you must keep in mind during disassembly and assembly procedures.



---

As you remove each subassembly from the computer, place the subassembly (and all accompanying screws) away from the work area to prevent damage.

---

### Plastic parts



---

**CAUTION:** Using excessive force during disassembly and reassembly can damage plastic parts. Use care when handling the plastic parts. Apply pressure only at the points designated in the maintenance instructions.

---

### Cables and connectors



---

**CAUTION:** When servicing the computer, be sure that cables are placed in their proper locations during the reassembly process. Improper cable placement can damage the computer.

---

Cables must be handled with extreme care to avoid damage. Apply only the tension required to unseat or seat the cables during removal and insertion. Handle cables by the connector whenever possible. In all cases, avoid bending, twisting, or tearing cables. Be sure that cables are routed in such a way that they cannot be caught or snagged by parts being removed or replaced. Handle flex cables with extreme care; these cables tear easily.

## Drive handling

-  **CAUTION:** Drives are fragile components that must be handled with care. To prevent damage to the computer, damage to a drive, or loss of information, observe these precautions:
- Before removing or inserting a hard drive, shut down the computer. If you are unsure whether the computer is off or in Hibernation, turn the computer on, and then shut it down through the operating system.
  - Before handling a drive, be sure that you are discharged of static electricity. While handling a drive, avoid touching the connector.
  - Handle drives on surfaces covered with at least one inch of shock-proof foam.
  - Avoid dropping drives from any height onto any surface.
  - After removing a hard drive, an optical drive, or a diskette drive, place it in a static-proof bag.
  - Avoid exposing a hard drive to products that have magnetic fields, such as monitors or speakers.
  - Avoid exposing a drive to temperature extremes or liquids.
  - If a drive must be mailed, place the drive in a bubble pack mailer or other suitable form of protective packaging and label the package "FRAGILE."
- 

## Grounding guidelines

### Electrostatic discharge damage

Electronic components are sensitive to electrostatic discharge (ESD). Circuitry design and structure determine the degree of sensitivity. Networks built into many integrated circuits provide some protection, but in many cases, ESD contains enough power to alter device parameters or melt silicon junctions.

A discharge of static electricity from a finger or other conductor can destroy static-sensitive devices or microcircuitry. Even if the spark is neither felt nor heard, damage may have occurred.

An electronic device exposed to ESD may not be affected at all and can work perfectly throughout a normal cycle. Or, the device may function normally for a while, and then degrade in the internal layers, reducing its life expectancy.

-  **CAUTION:** To prevent damage to the computer when you are removing or installing internal components, observe these precautions:
- Keep components in their electrostatic-safe containers until you are ready to install them.
  - Use nonmagnetic tools.
  - Before touching an electronic component, discharge static electricity by using the guidelines described in this section.
  - Avoid touching pins, leads, and circuitry. Handle electronic components as little as possible.
  - If you remove a component, place it in an electrostatic-safe container.
-

The following table shows how humidity affects the electrostatic voltage levels generated by different activities.



**CAUTION:** A product can be degraded by as little as 700 V.

Typical electrostatic voltage levels			
Event	Relative humidity		
	10%	40%	55%
Walking across carpet	35,000 V	15,000 V	7,500 V
Walking across vinyl floor	12,000 V	5,000 V	3,000 V
Motions of bench worker	6,000 V	800 V	400 V
Removing DIPS from plastic tube	2,000 V	700 V	400 V
Removing DIPS from vinyl tray	11,500 V	4,000 V	2,000 V
Removing DIPS from Styrofoam	14,500 V	5,000 V	3,500 V
Removing bubble pack from PCB	26,500 V	20,000 V	7,000 V
Packing PCBs in foam-lined box	21,000 V	11,000 V	5,000 V

## Packaging and transporting guidelines

Follow these grounding guidelines when packaging and transporting equipment:

- To avoid hand contact, transport products in static-safe tubes, bags, or boxes.
- Protect ESD-sensitive parts and assemblies with conductive or approved containers or packaging.
- Keep ESD-sensitive parts in their containers until they arrive at static-free workstations.
- Place items on a grounded surface before them from their containers.
- Always be properly grounded when touching a component or assembly.
- Store reusable ESD-sensitive parts from assemblies in protective packaging or nonconductive foam.
- Use transporters and conveyors made of antistatic belts and roller bushings. Be sure that mechanized equipment used for moving materials is wired to ground, and that proper materials are selected to avoid static charging. When grounding is not possible, use an ionizer to dissipate electric charges.

## Workstation guidelines

Follow these workstation grounding guidelines:

- Cover the workstation with approved static-shielding material.
- Use a wrist strap connected to a properly grounded work surface, and use properly grounded tools and equipment.
- Use conductive field service tools, such as cutters, screwdrivers, and vacuums.
- When fixtures must directly contact dissipative surfaces, use fixtures made only of static-safe materials.
- Keep the work area free of nonconductive materials, such as ordinary plastic assembly aids and Styrofoam.
- Handle ESD-sensitive components, parts, and assemblies by the case or PCM laminate. Handle these items only at static-free workstations.
- Avoid contact with pins, leads, or circuitry.
- Turn off power and input signals before inserting or removing connectors or test equipment.

## Equipment guidelines

Grounding equipment must include either a wrist strap or a foot strap at a grounded workstation.

- When seated, wear a wrist strap connected to a grounded system. Wrist straps are flexible straps with a minimum of one megohm  $\pm 10\%$  resistance in the ground cords. To provide proper ground, wear a strap snugly against the skin at all times. On grounded mats with banana-plug connectors, use alligator clips to connect a wrist strap.
- When standing, use foot straps and a grounded floor mat. Foot straps (heel, toe, or boot straps) can be used at standing workstations and are compatible with most types of shoes or boots. On conductive floors or dissipative floor mats, use foot straps on both feet with a minimum of one megohm resistance between the operator and ground. To be effective, the conductive strips must be worn in contact with the skin.

The following grounding equipment is recommended to prevent electrostatic damage:

- Antistatic tape
- Antistatic smocks, aprons, and sleeve protectors
- Conductive bins and other assembly or soldering aids
- Nonconductive foam
- Conductive tabletop workstations with ground cords of one megohm resistance
- Static-dissipative tables or floor mats with hard ties to the ground
- Field service kits
- Static awareness labels
- Material-handling packages
- Nonconductive plastic bags, tubes, or boxes
- Metal tote boxes
- Electrostatic voltage levels and protective materials

The following table lists the shielding protection provided by antistatic bags and floor mats.

Material	Use	Voltage protection level
Antistatic plastic	Bags	1,500 V
Carbon-loaded plastic	Floor mats	7,500 V
Metallized laminate	Floor mats	5,000 V

## Component replacement procedures

This chapter provides removal and replacement procedures.

There are as many as 62 screws, in 12 different sizes, that must be removed, replaced, or loosened when servicing the computer. Make special note of each screw size and location during removal and replacement.

### Serial number location

The serial number location, located on the bottom of the computer, provides important information that you may need when contacting technical support.



Serial number label location, format, and color vary on select models.

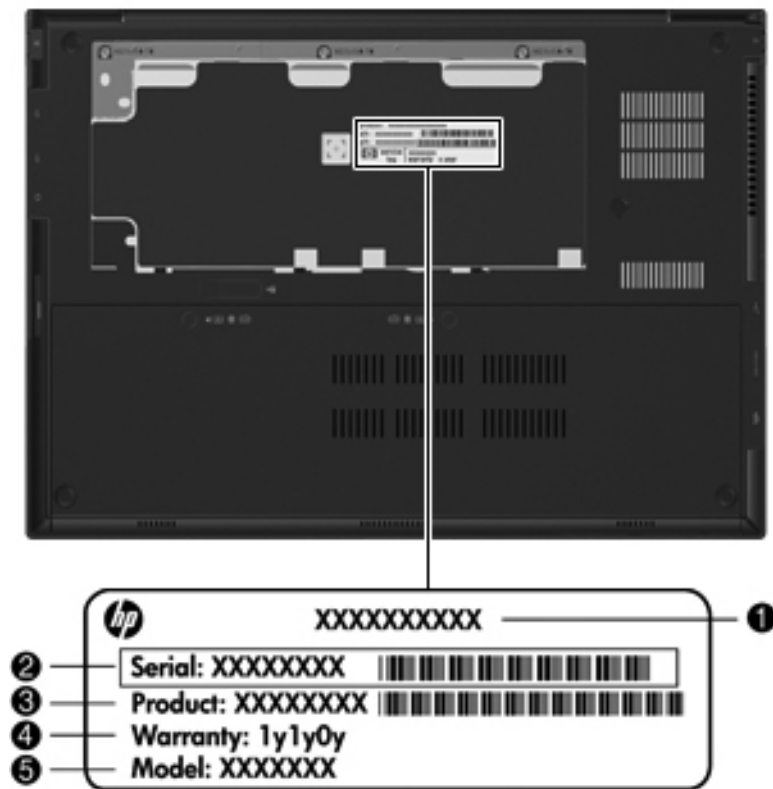

(1)	Product name	(4)	Warranty period
(2)	Serial number	(5)	Model description
(3)	Product number		

## Computer feet

The computer feet are adhesive-backed rubber pads. The feet are included in the Rubber Feet Kit, spare part number 581101-001. There are 6 rubber feet that attach to the base enclosure in the locations shown in the following illustration.



The four rubber feet ❶ in the corners of the computer are larger than the two rubber feet ❷ in the middle of the computer.

---

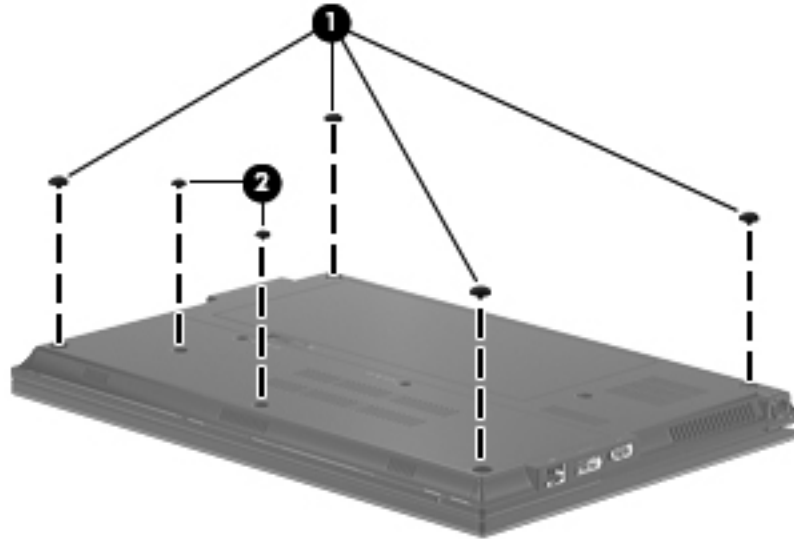



## Battery

Description	Spare part number
4-cell, 41-WHr, 2.8-Ah battery	580956-001
6-cell, 62-WHr, 2.8-Ah battery (supports HP Fast Charge technology)	594796-001

Before removing the battery, follow these steps:

1. Shut down the computer. If you are unsure whether the computer is off or in Hibernation, turn the computer on, and then shut it down through the operating system.
2. Disconnect all external devices connected to the computer.
3. Disconnect the power from the computer by first unplugging the power cord from the AC outlet, and then unplugging the AC adapter from the computer.

Remove the battery:

1. Turn the computer upside down on a flat surface, with the front toward you.
2. Slide the battery release latch **1** to release the battery.
3. Pivot the front edge of the battery **2** upward.
4. Remove the battery **3**.

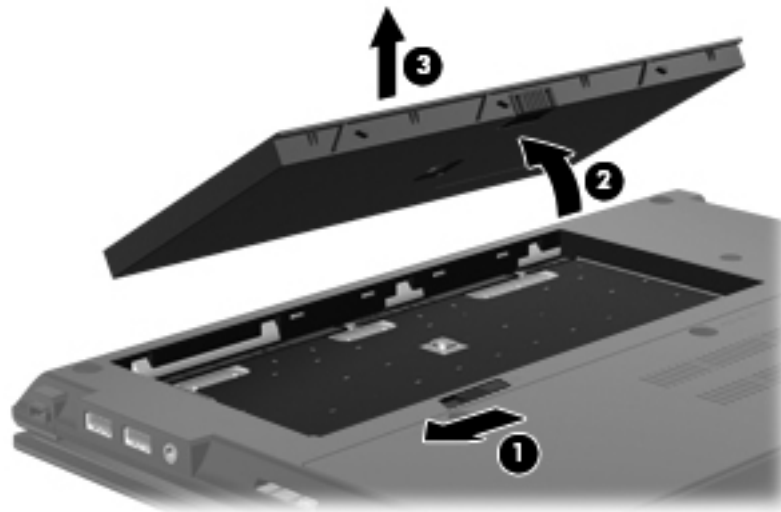

Install the battery by inserting it into the battery bay and pivoting it downward until it is seated. The battery release latch automatically locks the battery into place.

## SIM



The SIM is provided by the end user as a security measure for the WWAN module. The SIM should be removed, placed into a static-dissipative container, and then replaced when the computer is reassembled.

---

Before removing the SIM, follow these steps:

1. Shut down the computer. If you are unsure whether the computer is off or in Hibernation, turn the computer on, and then shut it down through the operating system.
2. Disconnect all external devices connected to the computer.
3. Disconnect the power from the computer by first unplugging the power cord from the AC outlet, and then unplugging the AC adapter from the computer.
4. Remove the battery (see [“Battery” on page 4-7](#)).

Remove the SIM:

1. Press in on the SIM **1** to release it from the SIM slot.
2. Remove the SIM **2** from the SIM slot.

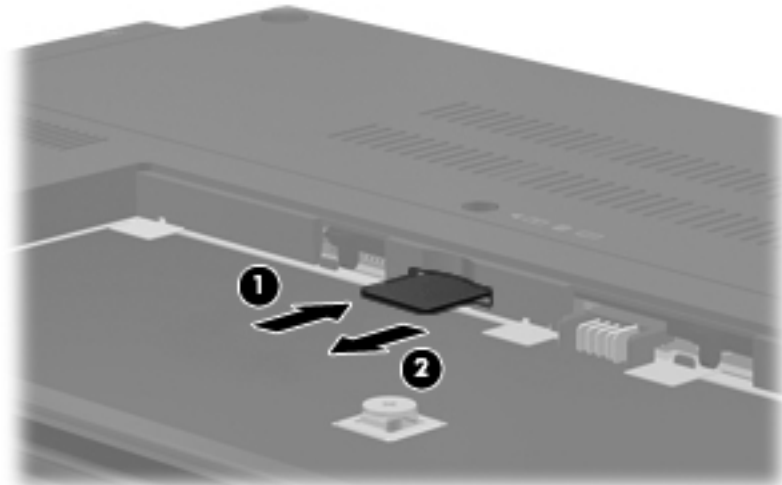

Install the SIM by inserting it into the SIM slot until you hear a click.

## Mass storage device



The mass storage device spare part kit includes a bracket.

Description	Spare part number
<b>Hard drive:</b>	
500-GB, 7200 rpm	618829-001
320-GB, 7200 rpm	581084-001
250-GB, 7200 rpm	581083-001
<b>Solid-state drive</b> (only with computer models running Windows 7 operating system, either 2 GB or 4 GB):	
128-GB	581085-001
80-GB	581086-001

Before removing the mass storage device, follow these steps:

1. Shut down the computer. If you are unsure whether the computer is off or in Hibernation, turn the computer on, and then shut it down through the operating system.
2. Disconnect all external devices connected to the computer.
3. Disconnect the power from the computer by first unplugging the power cord from the AC outlet, and then unplugging the AC adapter from the computer.
4. Remove the battery (see [“Battery” on page 4-7](#)).

Remove the mass storage device:

1. Position the computer with the front toward you.
2. Loosen the two Phillips PM2.5×6.0 captive screws that secure the accessory cover to the computer.

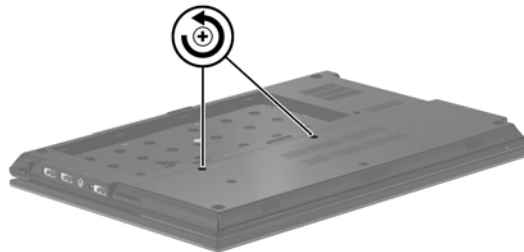

3. Slide the rear edge ❶ of the accessory cover to detach it from the computer.
4. Remove the accessory cover ❷. The accessory cover is included in the Plastics Kit, spare part number 618835-001.

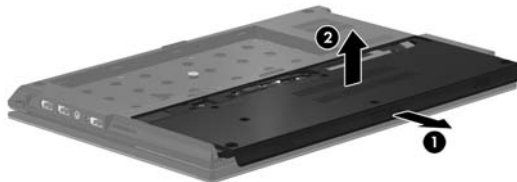

5. Loosen the Phillips PM2.5×11.0 captive screw ❶ that secures the mass storage device in the mass storage device bay.
6. Remove the two Phillips PM2.5×4.0 screws ❷ that secure the mass storage device in the mass storage device bay.

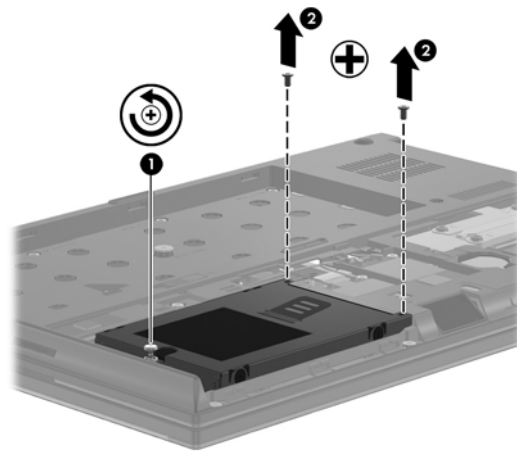

7. Grasp the Mylar tab ❶ on the mass storage device bracket, and slide the mass storage device to the left ❷ to disconnect it from the system board.
8. Remove the mass storage device ❸ from the mass storage device bay.

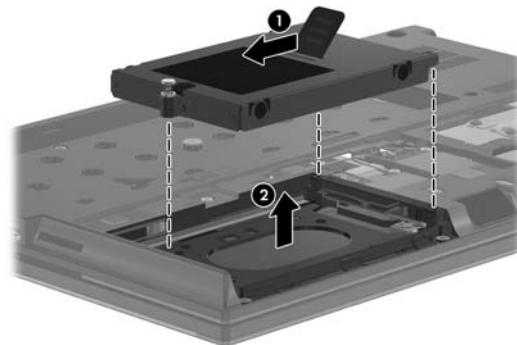

9. If it is necessary to replace the mass storage device bracket, follow these steps:
- Remove the four Phillips PM3.0×4.0 screws ❶ that secure the mass storage device bracket to the mass storage device.
  - Lift the bracket ❷ straight up to remove it from the mass storage device.

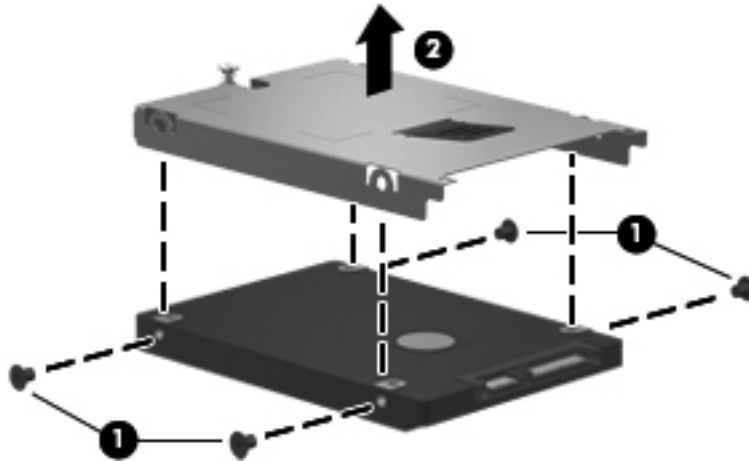

Reverse this procedure to reassemble and install the mass storage device.

## Bluetooth module



The Bluetooth module spare part kit does not include a Bluetooth module cable. The Bluetooth module cable is included in the Cable Kit, spare part number 618826-001.

Description	Spare part number
Bluetooth module	537921-001

Before removing the Bluetooth module, follow these steps:

1. Shut down the computer. If you are unsure whether the computer is off or in Hibernation, turn the computer on, and then shut it down through the operating system.
2. Disconnect all external devices connected to the computer.
3. Disconnect the power from the computer by first unplugging the power cord from the AC outlet, and then unplugging the AC adapter from the computer.
4. Remove the battery (see [“Battery” on page 4-7](#)).
5. Remove the accessory cover (see [“Mass storage device” on page 4-9](#)).

Remove the Bluetooth module:

1. Release the Bluetooth module ❶ by sliding it to the left until the right side of the module is clear of the opening in the base enclosure, and then swinging the right side of the module ❷ away from the base enclosure.

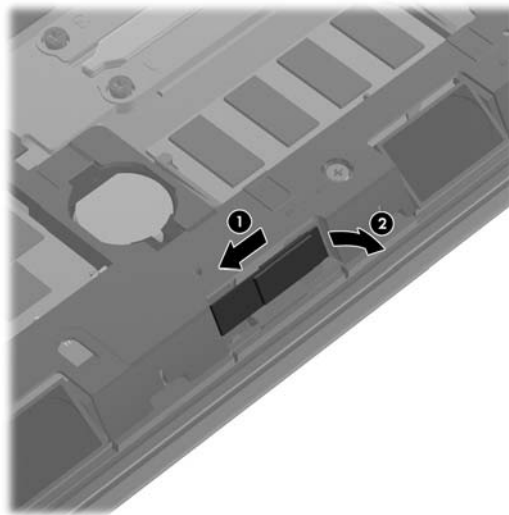

2. Disconnect the Bluetooth module cable from the Bluetooth module.

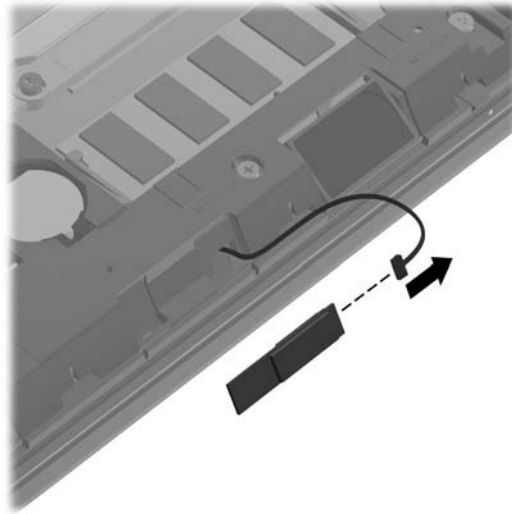

3. Remove the Bluetooth module.

Reverse this procedure to install the Bluetooth module.

## WLAN module

Description	Spare part number
<b>802.11 a/b/g/n WLAN module:</b>	
Broadcom 43224 802.11 a/b/g/n WLAN module for use in Antigua and Barbuda, Barbados, Belize, Canada, the Cayman Islands, Guam, Puerto Rico, Trinidad and Tobago, the U.S. Virgin Islands, and the United States	582564-001
Broadcom 43224 802.11 a/b/g/n WLAN module for use in Afghanistan, Albania, Algeria, Andorra, Angola, Argentina, Armenia, Aruba, Australia, Austria, Azerbaijan, the Bahamas, Bahrain, Bangladesh, Barbados, Belarus, Belgium, Belize, Benin, Bermuda, Bhutan, Bolivia, Bosnia and Herzegovina, Botswana, Brazil, the British Virgin Islands, Brunei, Bulgaria, Burkina Faso, Burundi, Cambodia, Cameroon, Cape Verde, the Central African Republic, Chad, Chile, Colombia, Comoros, the Congo, Costa Rica, Croatia, Cyprus, the Czech Republic, Denmark, Djibouti, Dominica, the Dominican Republic, East Timor, Ecuador, Egypt, El Salvador, Equatorial Guinea, Eritrea, Estonia, Ethiopia, Fiji, Finland, France, French Guiana, Gabon, Gambia, Georgia, Germany, Ghana, Gibraltar, Greece, Grenada, Guadeloupe, Guatemala, Guinea, Guinea-Bissau, Guyana, Haiti, Honduras, Hong Kong, Hungary, Iceland, India, Indonesia, Ireland, Italy, the Ivory Coast, Jamaica, Japan, Jordan, Kazakhstan, Kenya, Kiribati, Kuwait, Kyrgyzstan, Laos, Latvia, Lebanon, Lesotho, Liberia, Liechtenstein, Lithuania, Luxembourg, Macedonia, Madagascar, Malawi, Malaysia, the Maldives, Mali, Malta, the Marshall Islands, Martinique, Mauritania, Mauritius, Mexico, Micronesia, Monaco, Mongolia, Montenegro, Morocco, Mozambique, Namibia, Nauru, Nepal, the Nether Antilles, the Netherlands, New Zealand, Nicaragua, Niger, Nigeria, Norway, Oman, Pakistan, Palau, Panama, Papua New Guinea, Paraguay, the People's Republic of China, Peru, the Philippines, Poland, Portugal, Qatar, the Republic of Moldova, Romania, Russia, Rwanda, Samoa, San Marino, Sao Tome and Principe, Saudi Arabia, Senegal, Serbia, the Seychelles, Sierra Leone, Singapore, Slovakia, Slovenia, the Solomon Islands, Somalia, South Africa, South Korea, Spain, Sri Lanka, St. Kitts and Nevis, St. Lucia, St. Vincent, Suriname, Swaziland, Sweden, Switzerland, Taiwan, Tajikistan, Tanzania, Thailand, Togo, Tonga, Tunisia, Turkey, Turkmenistan, Tuvalu, Uganda, Ukraine, the United Arab Emirates, the United Kingdom, Uruguay, Uzbekistan, Vanuatu, Venezuela, Vietnam, Yemen, Zaire, Zambia, and Zimbabwe	582564-002
<b>802.11 b/g/n WLAN module:</b>	
Broadcom 4312G 802.11 b/g/n WLAN module for use in Canada, the Cayman Islands, Guam, Puerto Rico, the United States, and the U.S. Virgin Islands	593836-001

Before removing the WLAN module, follow these steps:

1. Shut down the computer. If you are unsure whether the computer is off or in Hibernation, turn the computer on, and then shut it down through the operating system.
2. Disconnect all external devices connected to the computer.
3. Disconnect the power from the computer by first unplugging the power cord from the AC outlet, and then unplugging the AC adapter from the computer.
4. Remove the battery (see [“Battery” on page 4-7](#)).
5. Remove the accessory cover (see [“Mass storage device” on page 4-9](#)).



Remove the WLAN module:

**CAUTION:** To prevent an unresponsive system, replace the wireless module only with a wireless module authorized for use in the computer by the governmental agency that regulates wireless devices in your country or region. If you replace the module and then receive a warning message, remove the module to restore computer functionality, and then contact technical support through Help and Support.

1. Position the computer with the front toward you.
2. Disconnect the WLAN antenna cables from the terminals on the WLAN module.

 The black WLAN antenna cable is connected to the WLAN module “Main” terminal. The white WLAN antenna cable is connected to the WLAN module “Aux” terminal.

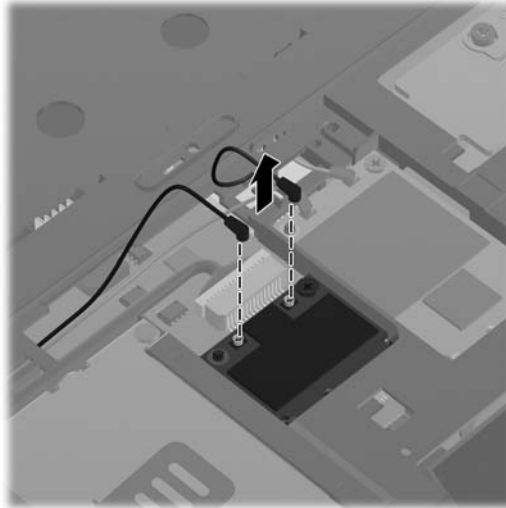

3. Remove the Phillips PM2.5×4.0 screw that secures the WLAN module to the system board. (The WLAN module tilts up.)

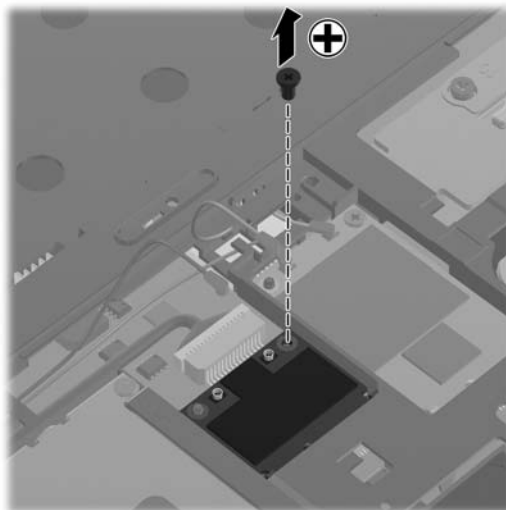

4. Remove the WLAN module by pulling it away from the slot at an angle.

 WLAN modules are designed with a notch to prevent incorrect insertion of the WLAN module into the WLAN module slot.

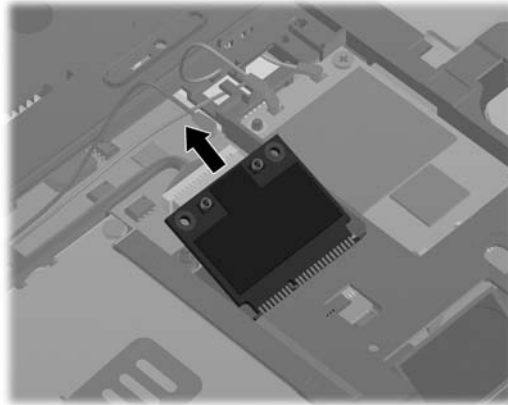

---

 If the WLAN antennas are not connected to the terminals on the WLAN module, the protective sleeves must be installed on the antenna connectors, as shown in the following illustration.

---

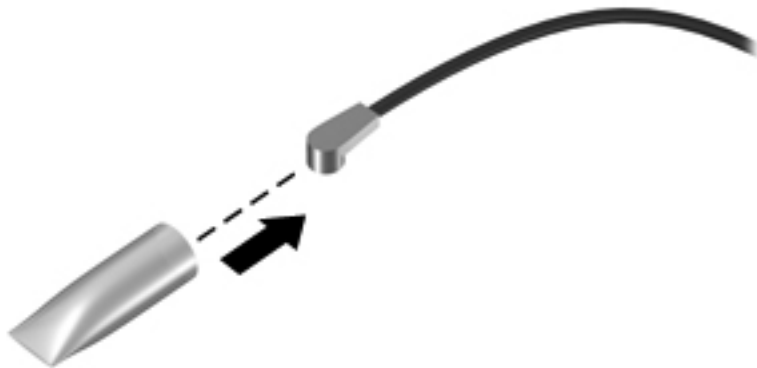

Reverse this procedure to install the WLAN module.

## WWAN module

Description	Spare part number
UNDP HSPA EV-DO WWAN module (does not support Linux operating system; available in all countries and regions, except China)	531993-001

Before removing the WWAN module, follow these steps:

1. Shut down the computer. If you are unsure whether the computer is off or in Hibernation, turn the computer on, and then shut it down through the operating system.
2. Disconnect all external devices connected to the computer.
3. Disconnect the power from the computer by first unplugging the power cord from the AC outlet, and then unplugging the AC adapter from the computer.
4. Remove the battery (see [“Battery” on page 4-7](#)).
5. Remove the accessory cover (see [“Mass storage device” on page 4-9](#)).

Remove the WWAN module:

**CAUTION:** To prevent an unresponsive system, replace the wireless module only with a wireless module authorized for use in the computer by the governmental agency that regulates wireless devices in your country or region. If you replace the module and then receive a warning message, remove the module to restore computer functionality, and then contact technical support through Help and Support.

1. Position the computer with the front toward you.
2. Disconnect the WWAN antenna cables from the terminals on the WWAN module.
  -  The red WWAN antenna cable is connected to the WWAN module “Main” terminal. The blue WWAN antenna cable is connected to the WWAN module “Aux” terminal.

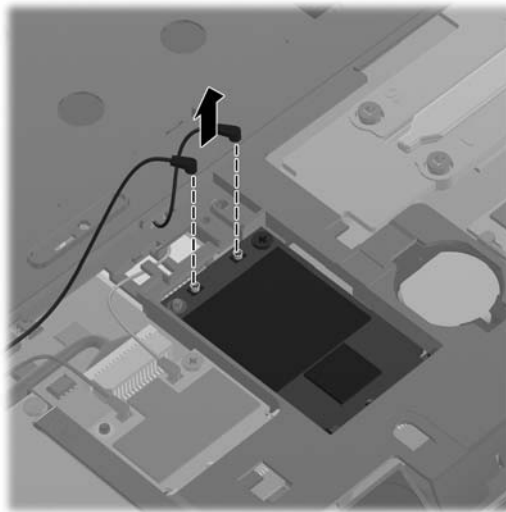

3. Remove the Phillips PM2.5×4.0 screw that secures the WWAN module to the system board. (The WWAN module tilts up.)

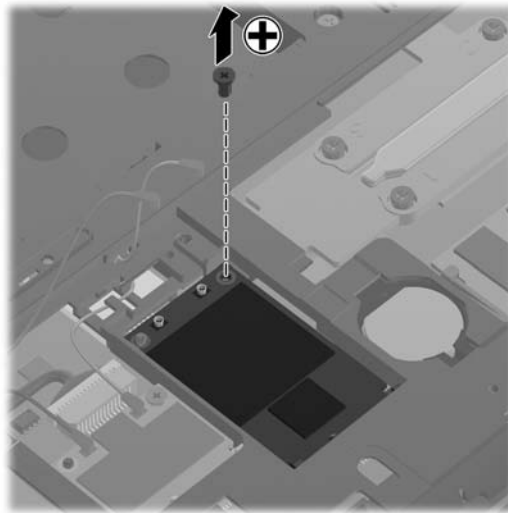

4. Remove the WWAN module by pulling it away from the slot at an angle.

 WWAN modules are designed with a notch to prevent incorrect insertion of the WWAN module into the WWAN module slot.

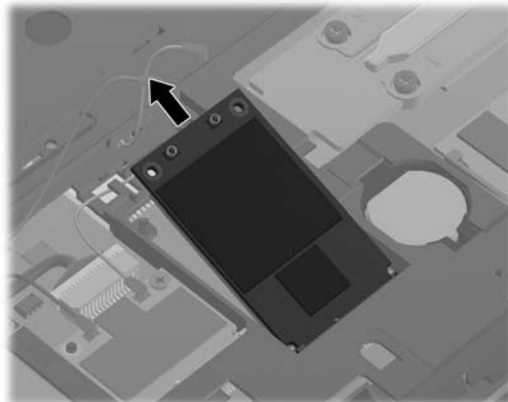

---

 If the WWAN antennas are not connected to the terminals on the WWAN module, the protective sleeves must be installed on the antenna connectors, as shown in the following illustration.

---

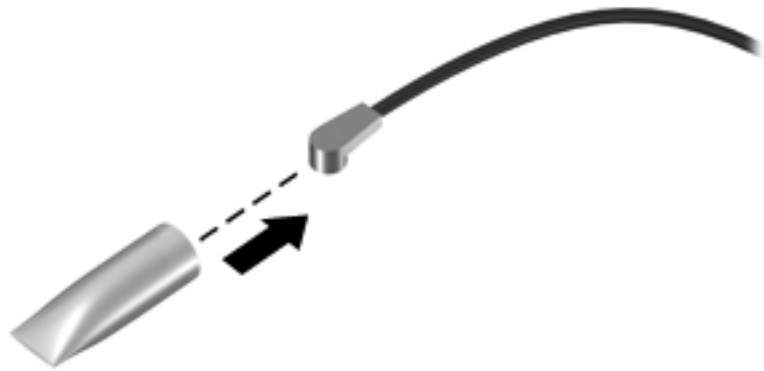

Reverse this procedure to install the WWAN module.

## RTC battery

Description	Spare part number
RTC battery (includes double-sided tape)	481089-001

Before removing the RTC battery, follow these steps:

1. Shut down the computer. If you are unsure whether the computer is off or in Hibernation, turn the computer on, and then shut it down through the operating system.
2. Disconnect all external devices connected to the computer.
3. Disconnect the power from the computer by first unplugging the power cord from the AC outlet, and then unplugging the AC adapter from the computer.
4. Remove the battery (see [“Battery” on page 4-7](#)).
5. Remove the accessory cover (see [“Mass storage device” on page 4-9](#)).

Remove the RTC battery:

1. Disconnect the RTC battery cable ❶ from the system board.
2. Detach the RTC battery ❷ from the system board. (The RTC battery is attached to the system board with double-sided tape.)

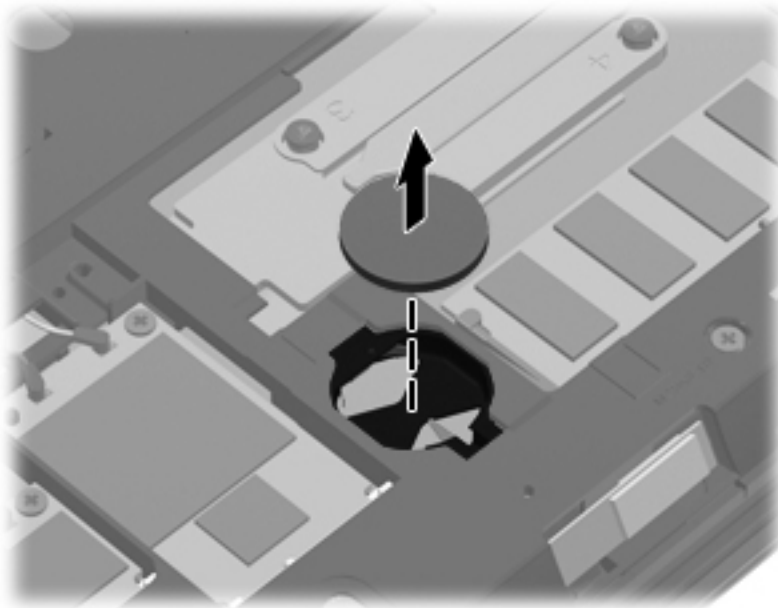

Reverse this procedure to install the RTC battery.

## Memory module

Description	Spare part number
4096-MB memory module (1333-MHz, DDR3, PC3-10600 Shared)	599092-001
2048-MB memory module (1333-MHz, DDR3, PC3-10600)	581096-001
1024-MB memory module (1333-MHz, DDR3, PC3-10600 Shared) (not available on Microsoft 64-bit operating systems)	598859-001

Before removing the memory module, follow these steps:

1. Shut down the computer. If you are unsure whether the computer is off or in Hibernation, turn the computer on, and then shut it down through the operating system.
2. Disconnect all external devices connected to the computer.
3. Disconnect the power from the computer by first unplugging the power cord from the AC outlet, and then unplugging the AC adapter from the computer.
4. Remove the battery (see [“Battery” on page 4-7](#)).
5. Remove the accessory cover (see [“Mass storage device” on page 4-9](#)).

Remove the memory module:

1. Pull away the retention clips on each side of the memory module to release the memory module. (The memory module tilts up.)

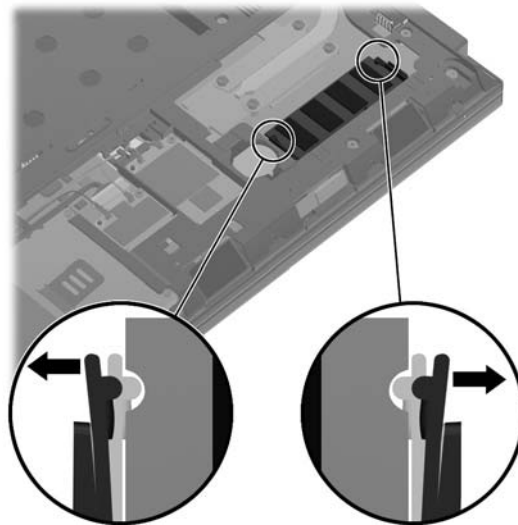



**CAUTION:** To prevent damage to the memory module, hold it by the edges only. Do not touch the components on the memory module.

---

2. Grasp the edge of the memory module, and then pull it out of the memory module slot.

 Memory modules are designed with a notch to prevent incorrect insertion into the memory module slot.

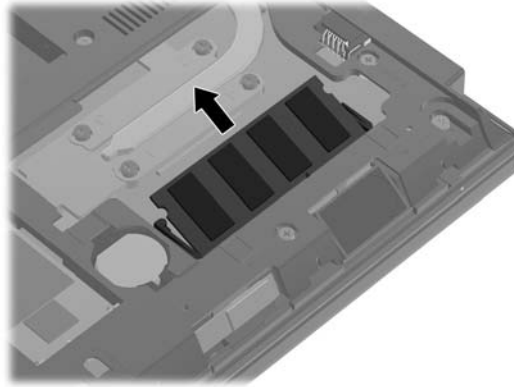

Reverse this procedure to install a memory module.



## Keyboard



The keyboard spare part kit includes a keyboard cable.

Keyboard for use in country or region	Spare part number	Keyboard for use in country or region	Spare part number
Belgium	618843-A41	Norway	618843-091
Bulgaria	618843-261	Portugal	618843-131
The Czech Republic and Slovakia	618843-A81	Russia	618843-251
Denmark	618843-081	Saudi Arabia	618843-171
France	618843-051	Slovenia	618843-BA1
France and Arabia	618843_DW1	South Korea	618843-AD1
French Canada	618843-121	Spain	618843-071
Germany	618843-041	Sweden and Finland	618843-B71
Greece	618843-DJ1	Switzerland	618843-BG1
Hungary	618843-211	Taiwan	618843-AB1
Iceland	618843-DD1	Thailand	618843-281
Israel	618843-BB1	Turkey	618843-141
Italy	618843-061	The United Kingdom	618843-031
Japan	618843-291	The United States	618843-001
The Netherlands	618843-B31		

Before removing the keyboard, follow these steps:

1. Shut down the computer. If you are unsure whether the computer is off or in Hibernation, turn the computer on, and then shut it down through the operating system.
2. Disconnect all external devices connected to the computer.
3. Disconnect the power from the computer by first unplugging the power cord from the AC outlet, and then unplugging the AC adapter from the computer.
4. Remove the battery (see [“Battery” on page 4-7](#)).
5. Remove the accessory cover (see [“Mass storage device” on page 4-9](#)).

Remove the keyboard:

1. Position the computer with the front toward you.
2. Remove the following screws:
  - ❑ Two Torx T8M2.5×5.0 screws ❶ in the mass storage device bay and the wireless module compartment
  - ❑ One Phillips PM2.5×2.0 broadhead screw ❷ in the battery bay

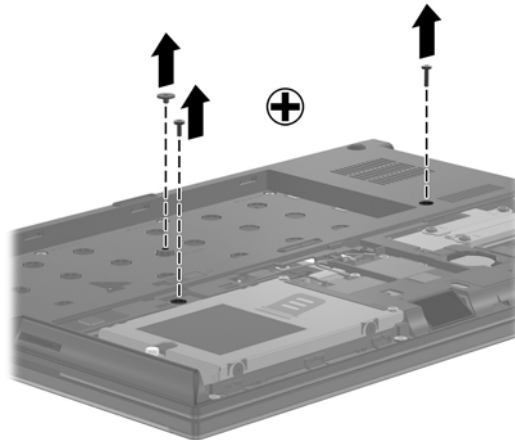

3. Turn the computer display-side up, with the front toward you.
4. Open the computer as far as possible.
5. Slide the keyboard ❶ back until it rests on the display.
6. Lift the rear edge of the keyboard ❷ until it rests at an angle.



7. Release the zero insertion force (ZIF) connector ❶ to which the keyboard cable is attached, disconnect the keyboard cable ❷ from the system board, and then remove the keyboard ❸.

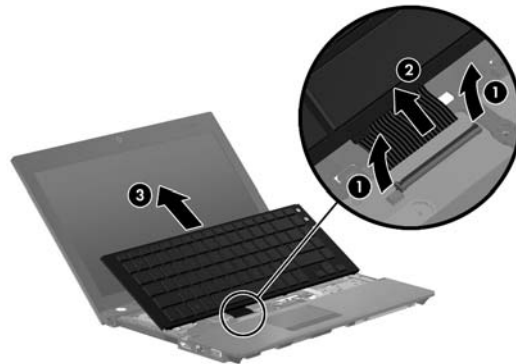

Reverse this procedure to install the keyboard.

## Button board and cable

Description	Spare part number
Button board with FFC (includes cable)	618815-001

Before removing the button board and cable, follow these steps:

1. Shut down the computer. If you are unsure whether the computer is off or in Hibernation, turn the computer on, and then shut it down through the operating system.
2. Disconnect all external devices connected to the computer.
3. Disconnect the power from the computer by first unplugging the power cord from the AC outlet, and then unplugging the AC adapter from the computer.
4. Remove the battery (see [“Battery” on page 4-7](#)).
5. Remove the accessory cover (see [“Mass storage device” on page 4-9](#)).
6. Remove the keyboard (see [“Keyboard” on page 4-23](#)).

Remove the button board and cable:

1. Release the ZIF connector ❶ to which the button board cable is attached, and then disconnect the button board cable ❷ from the system board.

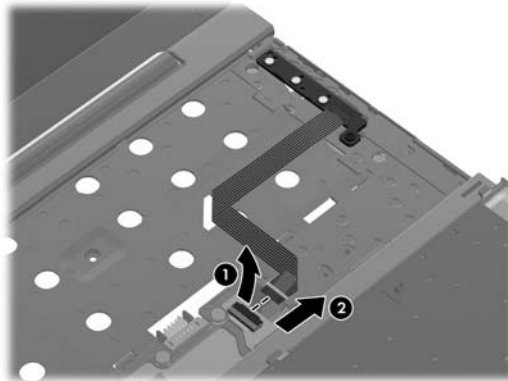

2. Release the button board cable from the top cover. (The button board cable is attached to the top cover with double-sided tape.)

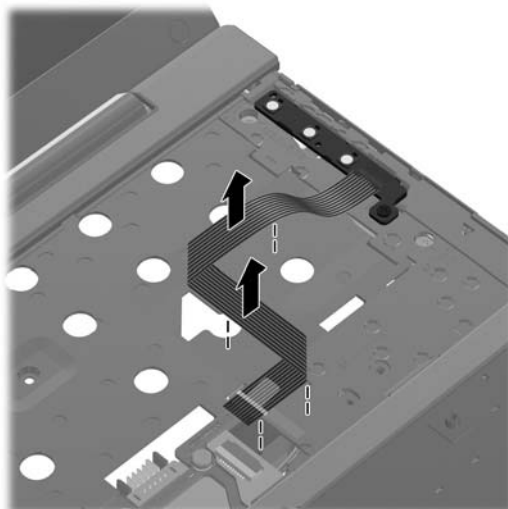

3. Remove the Torx T8M2.5×4.0 screw that secures the button board to the top cover.

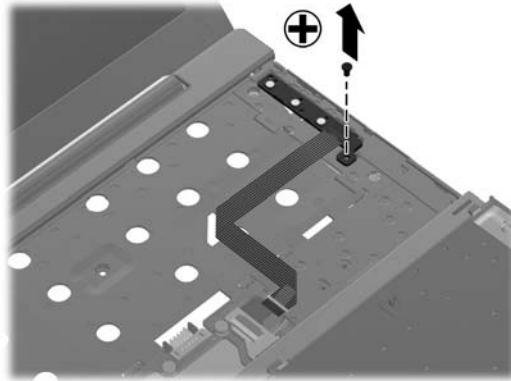

4. Lift the button board to release it from the clips built into the top cover.

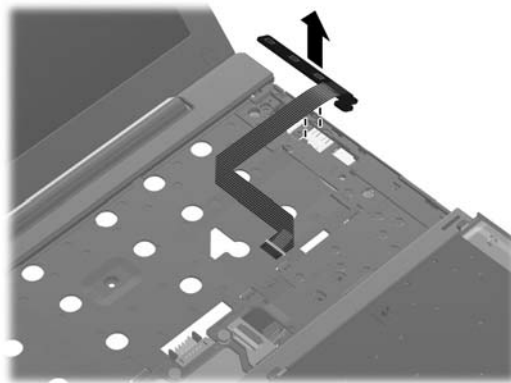

5. Remove the button board and cable.

Reverse this procedure to install the button board and cable.

## Top cover

Description	Spare part number
Top cover with fingerprint reader (includes TouchPad button board and cable, and TouchPad board and cable)	618840-001
Top cover with no fingerprint reader (includes TouchPad button board and cable, and TouchPad board and cable)	618841-001

Before removing the top cover, follow these steps:

1. Shut down the computer. If you are unsure whether the computer is off or in Hibernation, turn the computer on, and then shut it down through the operating system.
2. Disconnect all external devices connected to the computer.
3. Disconnect the power from the computer by first unplugging the power cord from the AC outlet, and then unplugging the AC adapter from the computer.
4. Remove the battery (see [“Battery” on page 4-7](#)).
5. Remove the following components:
  - a. Accessory cover (see [“Mass storage device” on page 4-9](#))
  - b. Keyboard (see [“Keyboard” on page 4-23](#))
  - c. Button board and cable (see [“Button board and cable” on page 4-26](#))

Remove the top cover:

1. Turn the computer upside down, with the front toward you.
2. Remove the following screws:
  - Three Torx T8M2.5×5.0 screws ❶ in the battery bay
  - Three Torx T8M2.5×6.0 screws ❷ in the mass storage device bay
  - Two Torx T8M2.5×9.0 screws ❸ in the RTC battery compartment

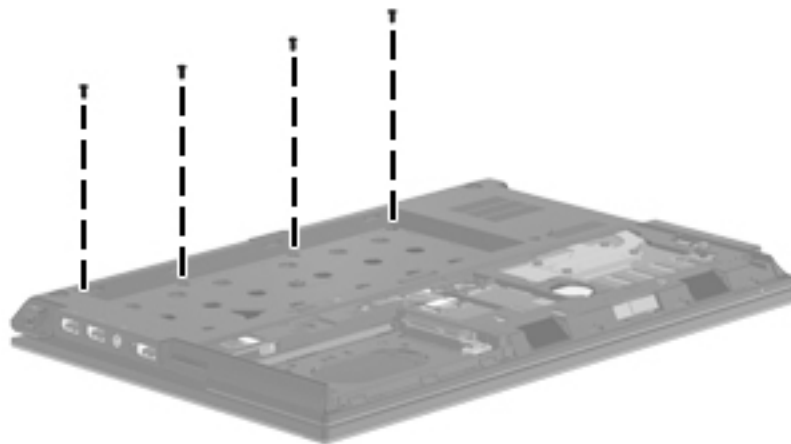

3. Turn the computer display-side up, with the front toward you.
4. Open the computer as far as possible.
5. Release the ZIF connector **1** to which the power button board cable is attached, and then disconnect the power button board cable from the system board.
6. Release the ZIF connector **2** to which the TouchPad cable is attached, and then disconnect the TouchPad cable from the system board.

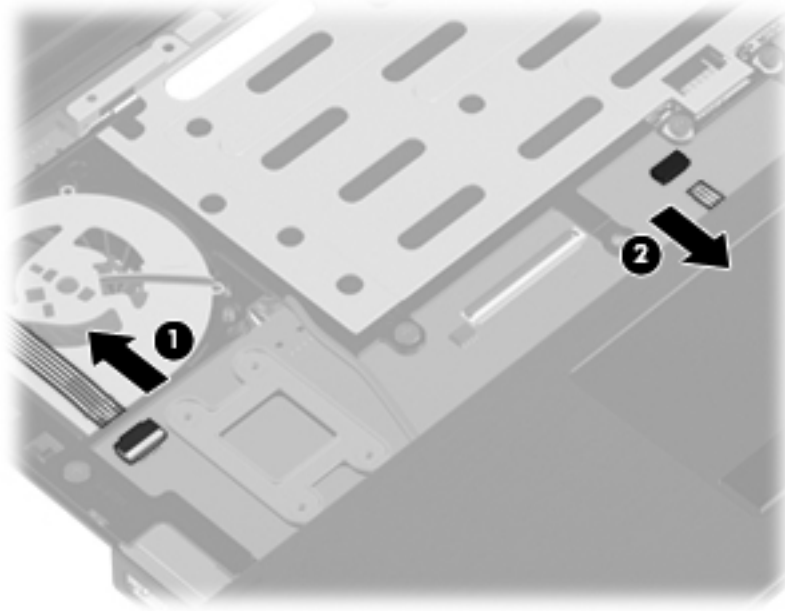

7. Remove the seven slotted Torx T8M2.5×7.0 screws that secure the top cover to the base enclosure.

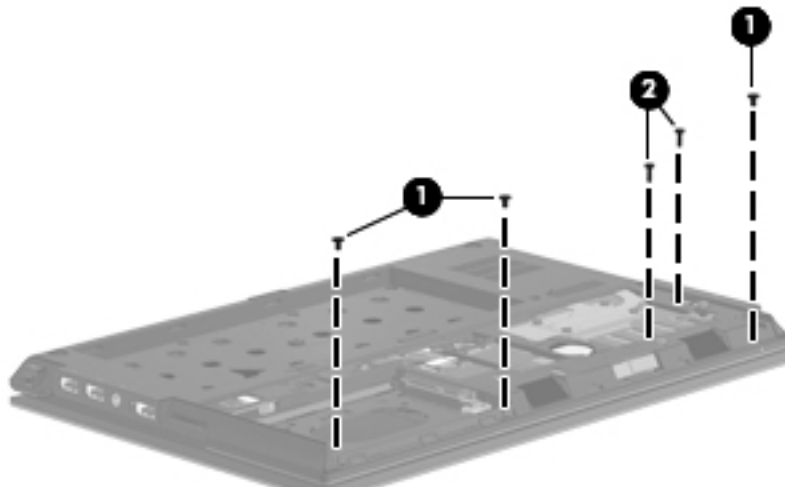

8. Lift the rear edge ❶ of the top cover until it detaches from the base enclosure.
9. Remove the top cover ❷ by lifting it straight up.

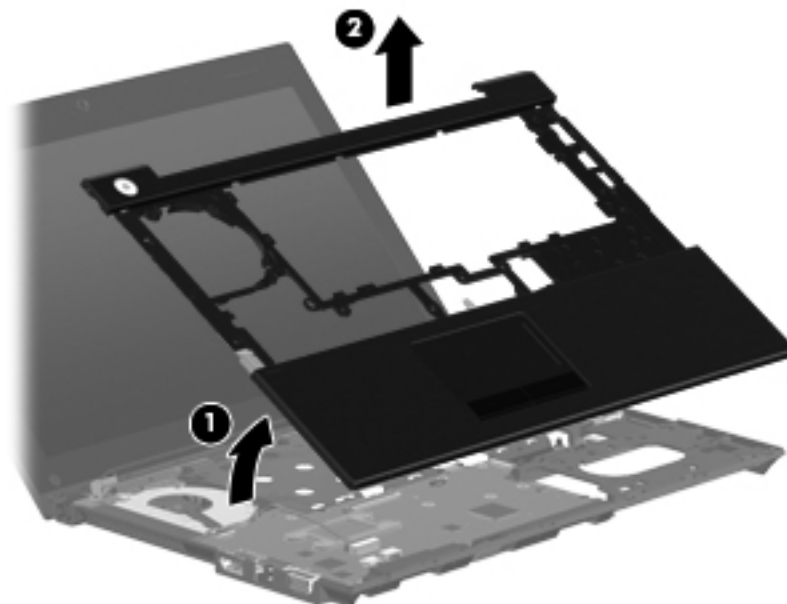

Reverse this procedure to install the top cover.



## Power button board and cable

Description	Spare part number
Power button board with FFC (includes cable)	618816-001

Before removing the power button board and cable, follow these steps:

1. Shut down the computer. If you are unsure whether the computer is off or in Hibernation, turn the computer on, and then shut it down through the operating system.
2. Disconnect all external devices connected to the computer.
3. Disconnect the power from the computer by first unplugging the power cord from the AC outlet, and then unplugging the AC adapter from the computer.
4. Remove the battery (see [“Battery” on page 4-7](#)).
5. Remove the following components:
  - a. Accessory cover (see [“Mass storage device” on page 4-9](#))
  - b. Keyboard (see [“Keyboard” on page 4-23](#))
  - c. Button board and cable (see [“Button board and cable” on page 4-26](#))
  - d. Top cover (see [“Top cover” on page 4-28](#))

Remove the power button board and cable:

1. Release the ZIF connector **1** to which the power button board cable is attached, and then disconnect the cable from the system board.
2. Disconnect the power cable **2** from the system board.
3. Remove the two Torx T8M2.5×6.0 screws **3** that secure the power button board to the base enclosure.
4. Remove the power button board and cable **4** by lifting them straight up.

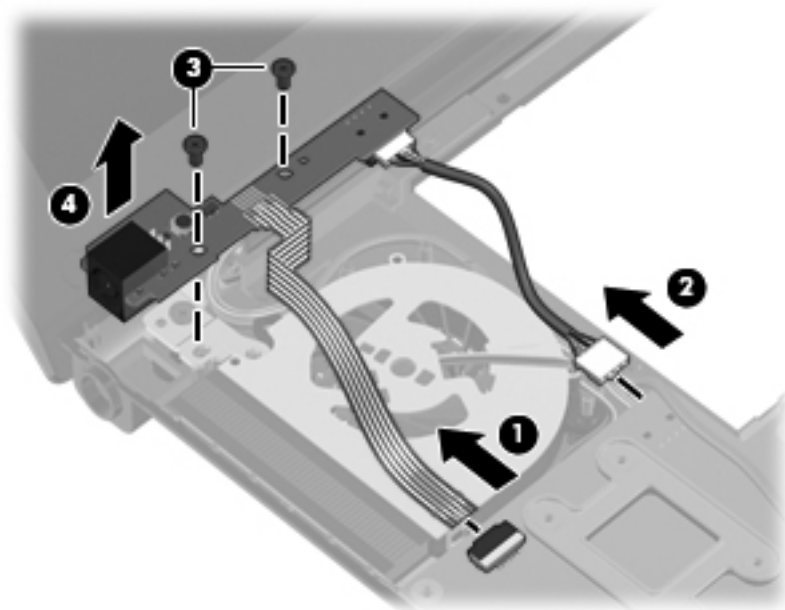

Reverse this procedure to install the power button board and cable.

## Bluetooth module cable



The Bluetooth module cable is included in the Cable Kit, spare part number 618826-001.

Before removing the Bluetooth module cable, follow these steps:

1. Shut down the computer. If you are unsure whether the computer is off or in Hibernation, turn the computer on, and then shut it down through the operating system.
2. Disconnect all external devices connected to the computer.
3. Disconnect the power from the computer by first unplugging the power cord from the AC outlet, and then unplugging the AC adapter from the computer.
4. Remove the battery (see [“Battery” on page 4-7](#)).
5. Remove the following components:
  - a. Accessory cover (see [“Mass storage device” on page 4-9](#))
  - b. Keyboard (see [“Keyboard” on page 4-23](#))
  - c. Button board and cable (see [“Button board and cable” on page 4-26](#))
  - d. Top cover (see [“Top cover” on page 4-28](#))

Remove the Bluetooth module cable:

1. Disconnect the Bluetooth module cable ❶ from the system board.
2. Remove the Bluetooth module cable ❷.

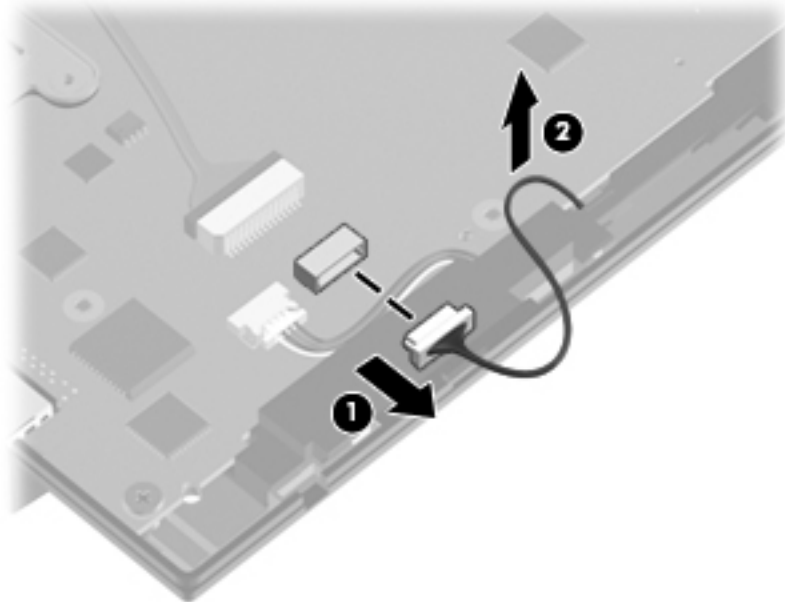

Reverse this procedure to install the Bluetooth module cable.

## System board



The system board spare part kit includes a processor and replacement thermal material.

Description	Spare part number
Intel® Dual Core i5-45M 2.40-GHz processor (Turbo up to 2.53 GHz), 3-M L3 cache, 4 threads (35W)	618821-001
Intel® Dual Core i5-45M 2.40-GHz processor (Turbo up to 2.53 GHz), 3-M L3 cache, 4 threads (35W), for use in China and Russia	618822-001
Intel Dual Core i3-370M 2.40-GHz processor, 3-M L3 cache, 4 threads (35W)	618819-001
Intel Dual Core i3-370M 2.40-GHz processor, 3-M L3 cache, 4 threads (35W), for use in China and Russia	618820-001
Intel Dual Core i3-350M 2.26-GHz processor, 3-M L3 cache, 4 threads (35W)	618817-001
Intel Dual Core i3-350M 2.26-GHz processor, 3-M L3 cache, 4 threads (35W), for use in China and Russia	618818-001
Intel U3400 1.06-GHz processor	618823-001
Intel U3400 1.06-GHz processor, for use in China and Russia	618824-001

Before removing the system board, follow these steps:

1. Shut down the computer. If you are unsure whether the computer is off or in Hibernation, turn the computer on, and then shut it down through the operating system.
2. Disconnect all external devices connected to the computer.
3. Disconnect the power from the computer by first unplugging the power cord from the AC outlet, and then unplugging the AC adapter from the computer.
4. Remove the battery (see [“Battery” on page 4-7](#)).
5. Remove the following components:
  - a. Accessory cover (see [“Mass storage device” on page 4-9](#))
  - b. Keyboard (see [“Keyboard” on page 4-23](#))
  - c. Button board and cable (see [“Button board and cable” on page 4-26](#))
  - d. Top cover (see [“Top cover” on page 4-28](#))

When replacing the system board, be sure that the following additional components are removed from the defective system board and installed on the replacement system board:

- SIM (see [“SIM” on page 4-8](#))
- Bluetooth module (see [“Bluetooth module” on page 4-12](#))
- WLAN module (see [“WLAN module” on page 4-14](#))
- WWAN module (see [“WWAN module” on page 4-17](#))
- RTC battery (see [“RTC battery” on page 4-20](#))
- Memory module (see [“Memory module” on page 4-21](#))
- Bluetooth module cable (see [“Bluetooth module cable” on page 4-32](#))
- Fan and heat sink (see [“Fan and heat sink” on page 4-36](#))

Remove the system board:

1. Turn the computer upside down, with the front toward you.
2. Disconnect the SD Card Reader board cable from the system board.

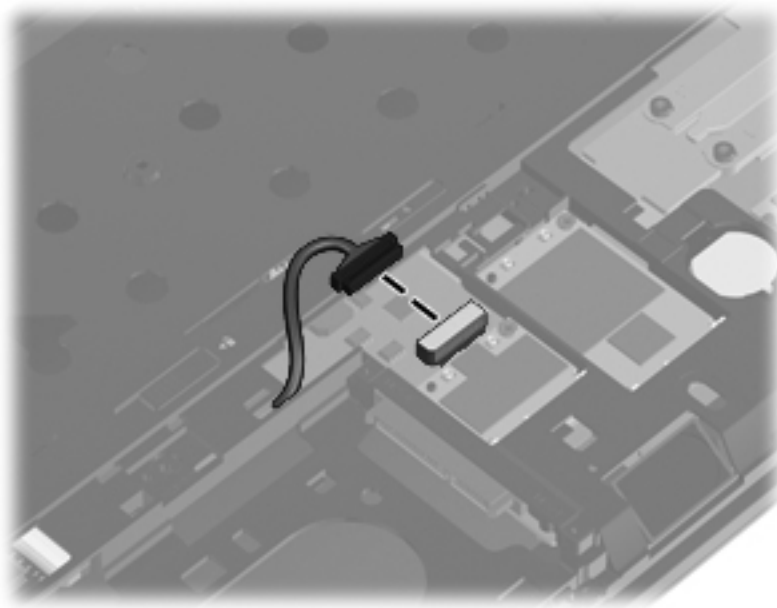

3. Turn the computer display-side up, with the front toward you.
4. Open the computer as far as possible.
5. Disconnect the speaker cable ❶ from the system board.
6. Disconnect the display panel cable ❷ from the system board.
7. Release the ZIF connector ❸ to which the power button board cable is attached, and then disconnect the cable from the system board.
8. Disconnect the power cable ❹ from the system board.

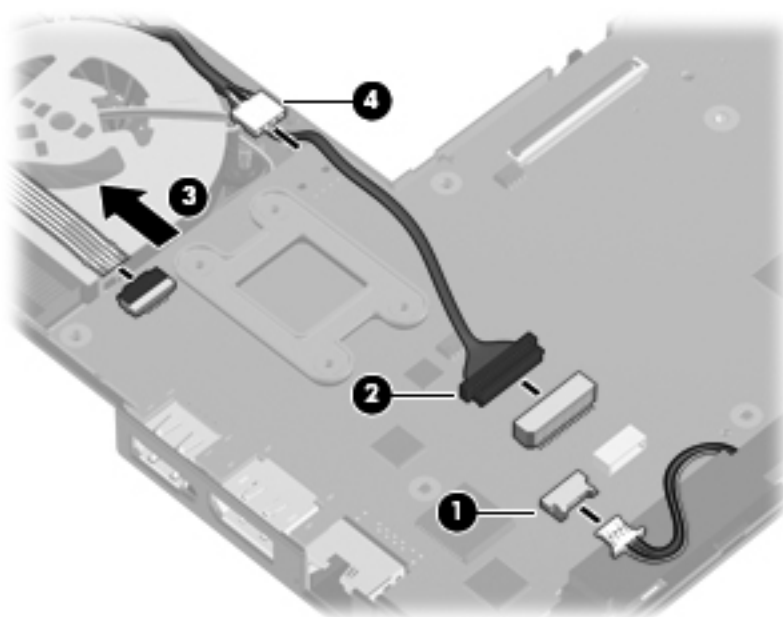

9. Remove the three Torx T8M2.5×4.0 screws that secure the system board to the base enclosure.

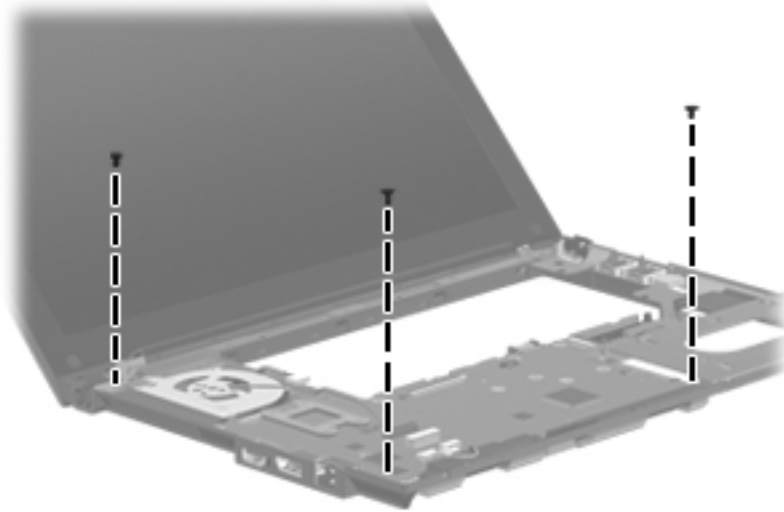

10. Lift the left side of the system board ❶ until it rests at an angle.

11. Remove the system board ❷ by sliding it away from the base enclosure at an angle.

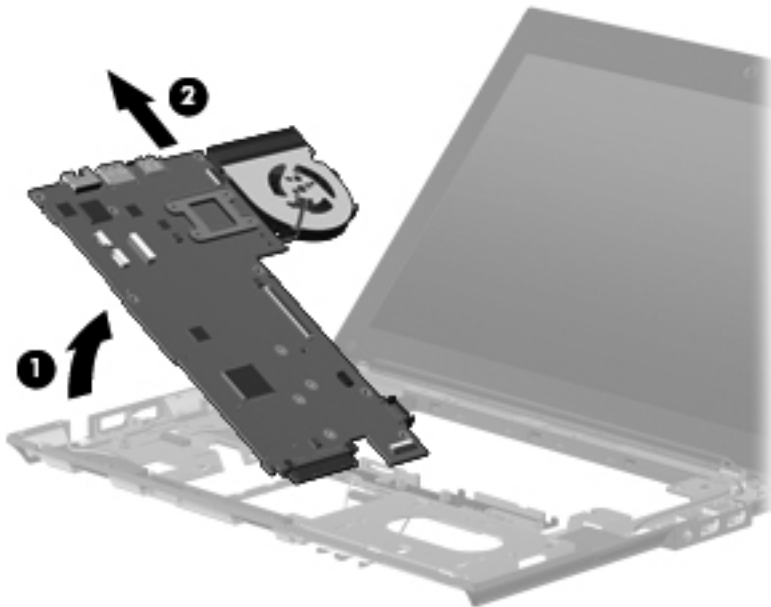

Reverse this procedure to install the system board.

## Fan and heat sink



The fan and heat sink spare part kit includes replacement thermal material.

Description	Spare part number
Fan/Heat sink	618830-001



To properly ventilate the computer, allow at least **7.6 cm** (3 in) of clearance on the left side of the computer. The computer uses an electric fan for ventilation. The fan is controlled by a temperature sensor and is designed to turn on automatically when high temperature conditions exist. These conditions are affected by high external temperatures, system power consumption, power management/battery conservation configurations, battery fast charging, and software requirements. Exhaust air is displaced through the ventilation grill located on the left side of the computer.

Before removing the fan and heat sink, follow these steps:

1. Shut down the computer. If you are unsure whether the computer is off or in Hibernation, turn the computer on, and then shut it down through the operating system.
2. Disconnect all external devices connected to the computer.
3. Disconnect the power from the computer by first unplugging the power cord from the AC outlet, and then unplugging the AC adapter from the computer.
4. Remove the battery (see [“Battery” on page 4-7](#)).
5. Remove the following components:
  - a. Accessory cover (see [“Mass storage device” on page 4-9](#))
  - b. Keyboard (see [“Keyboard” on page 4-23](#))
  - c. Button board and cable (see [“Button board and cable” on page 4-26](#))
  - d. Top cover (see [“Top cover” on page 4-28](#))
  - e. System board (see [“System board” on page 4-33](#))

Remove the fan and heat sink:

1. Turn the system board upside down, with the front toward you.
2. Disconnect the fan cable ❶ from the system board.
3. Following the 1, 2, 3, 4 sequence stamped into the heat sink, loosen the four Torx T8M2.0×7.0 captive screws ❷ that secure the fan and heat sink to the system board.

 Due to the adhesive quality of the thermal material located between the heat sink and system board components, it may be necessary to move the heat sink from side to side to detach it.

4. Remove the fan and heat sink ❸.

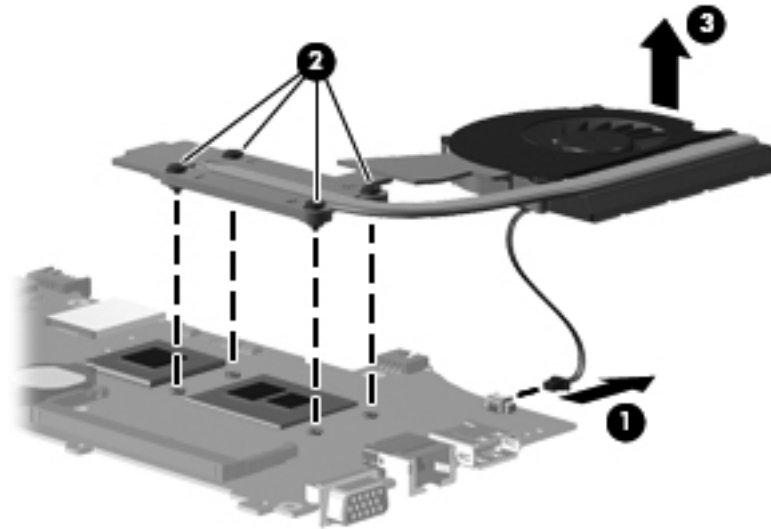

 The thermal material must be thoroughly cleaned from the surfaces of the heat sink and the system board each time the heat sink is removed:

- Thermal paste is used on the processor **1** and the heat sink section **2** that services it.
- Thermal pads are used on the Northbridge chip **3** and the heat sink section **4** that services it.

Replacement thermal material is included with all system board and heat sink spare part kits.

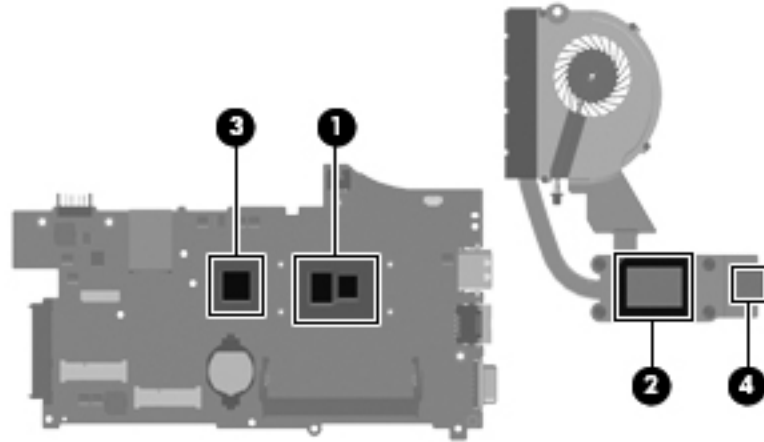

5. Lift the fan straight up to remove it from the heat sink. (The fan is attached to the heat sink with double-sided tape.)

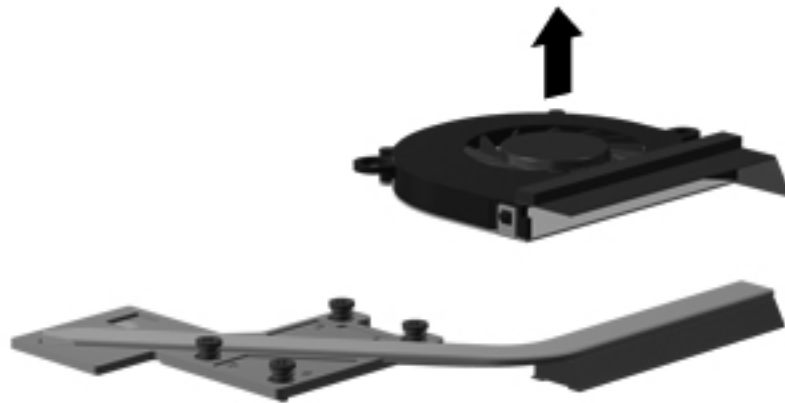

Reverse this procedure to install the fan and heat sink.



## Speaker assembly

Description	Spare part number
Speaker assembly (includes cable)	618839-001

Before removing the speaker assembly, follow these steps:

1. Shut down the computer. If you are unsure whether the computer is off or in Hibernation, turn the computer on, and then shut it down through the operating system.
2. Disconnect all external devices connected to the computer.
3. Disconnect the power from the computer by first unplugging the power cord from the AC outlet, and then unplugging the AC adapter from the computer.
4. Remove the battery (see [“Battery” on page 4-7](#)).
5. Remove the following components:
  - a. Accessory cover (see [“Mass storage device” on page 4-9](#))
  - b. Keyboard (see [“Keyboard” on page 4-23](#))
  - c. Button board and cable (see [“Button board and cable” on page 4-26](#))
  - d. Top cover (see [“Top cover” on page 4-28](#))
  - e. System board (see [“System board” on page 4-33](#))

Remove the speaker assembly:

1. Remove the three Torx T8M2.5×4.0 screws ❶ that secure the speaker assembly to the base enclosure.
2. Remove the speaker assembly ❷.

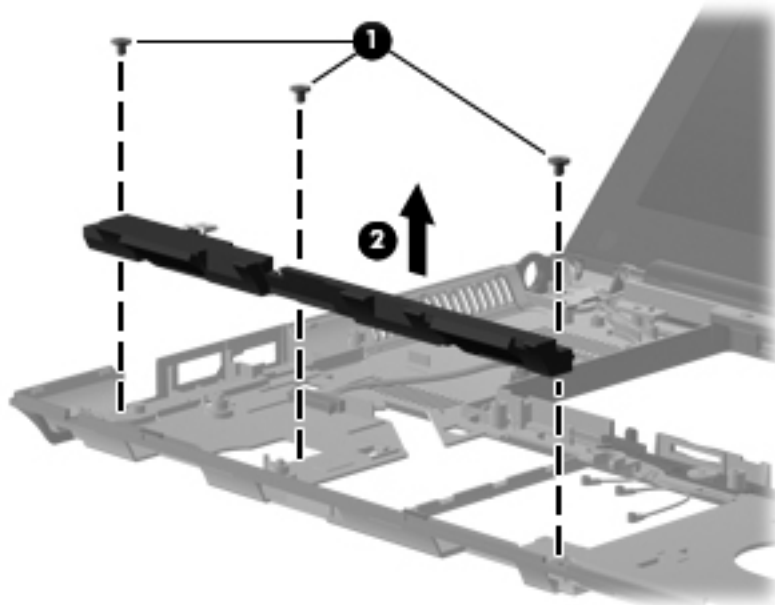

Reverse this procedure to install the speaker assembly.

## USB board

Description	Spare part number
USB board (includes cable)	618825-001

Before removing the USB board, follow these steps:

1. Shut down the computer. If you are unsure whether the computer is off or in Hibernation, turn the computer on, and then shut it down through the operating system.
2. Disconnect all external devices connected to the computer.
3. Disconnect the power from the computer by first unplugging the power cord from the AC outlet, and then unplugging the AC adapter from the computer.
4. Remove the battery (see [“Battery” on page 4-7](#)).
5. Remove the following components:
  - a. Accessory cover (see [“Mass storage device” on page 4-9](#))
  - b. Keyboard (see [“Keyboard” on page 4-23](#))
  - c. Button board and cable (see [“Button board and cable” on page 4-26](#))
  - d. Top cover (see [“Top cover” on page 4-28](#))
  - e. System board (see [“System board” on page 4-33](#))

Remove the USB board:

1. Disconnect the microphone cable ❶ from the USB board.
2. Remove the two Torx T8M2.5×4.0 screws ❷ that secure the USB board to the base enclosure.
3. Remove the USB board ❸ and cable.

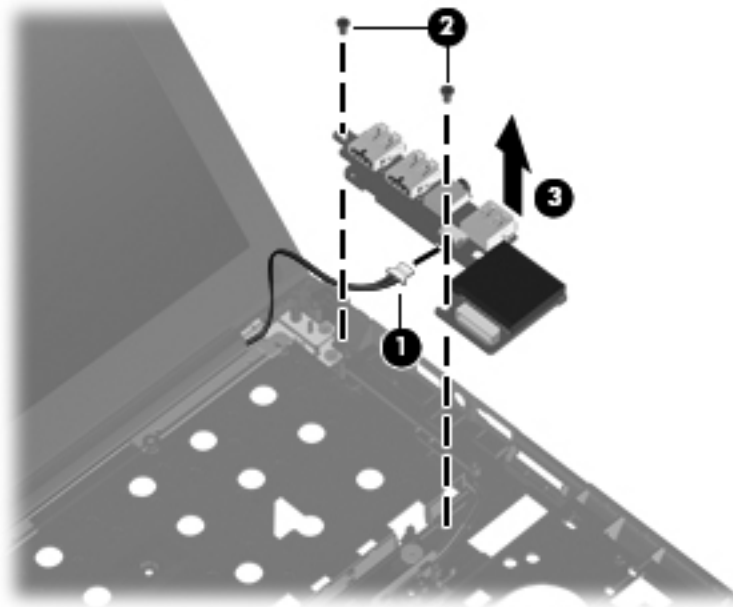

Reverse this procedure to install the USB board.

## Battery eject arm

Description	Spare part number
Latch Kit (includes battery eject arm, latch, and spring)	581090-001

Before removing the battery eject arm, follow these steps:

1. Shut down the computer. If you are unsure whether the computer is off or in Hibernation, turn the computer on, and then shut it down through the operating system.
2. Disconnect all external devices connected to the computer.
3. Disconnect the power from the computer by first unplugging the power cord from the AC outlet, and then unplugging the AC adapter from the computer.
4. Remove the battery (see [“Battery” on page 4-7](#)).
5. Remove the following components:
  - a. Accessory cover (see [“Mass storage device” on page 4-9](#))
  - b. Keyboard (see [“Keyboard” on page 4-23](#))
  - c. Button board and cable (see [“Button board and cable” on page 4-26](#))
  - d. Top cover (see [“Top cover” on page 4-28](#))
  - e. System board (see [“System board” on page 4-33](#))

Remove the battery eject arm:

1. Turn the base enclosure upside down, with the front toward you.
2. Use a flat-bladed screw driver **1** or similar tool to release the battery eject latch from the base enclosure.
3. Remove the the battery eject latch **2**.

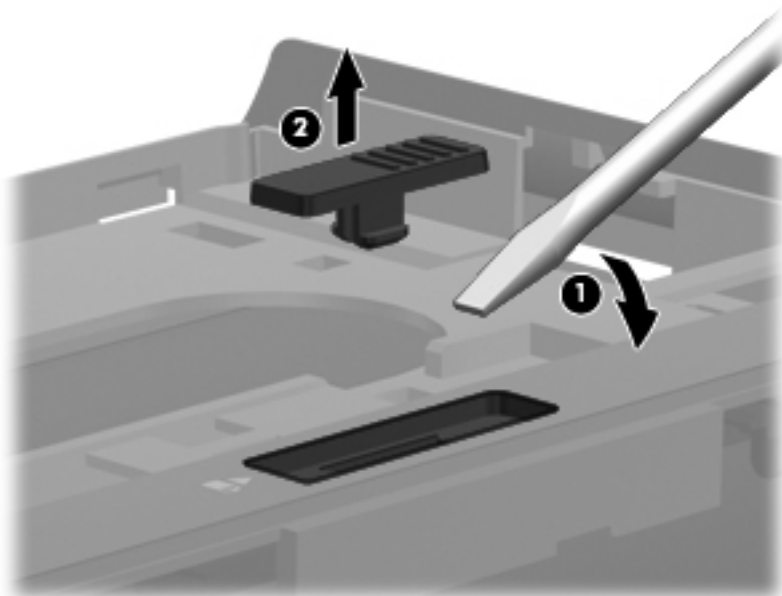

4. Release the battery eject arm spring ❶ from the tab built into the base enclosure.
5. Remove the two Phillips PM2.5×4.0 broadhead screws ❷ that secure the battery eject arm to the base enclosure.
6. Remove the the battery eject arm ❸.

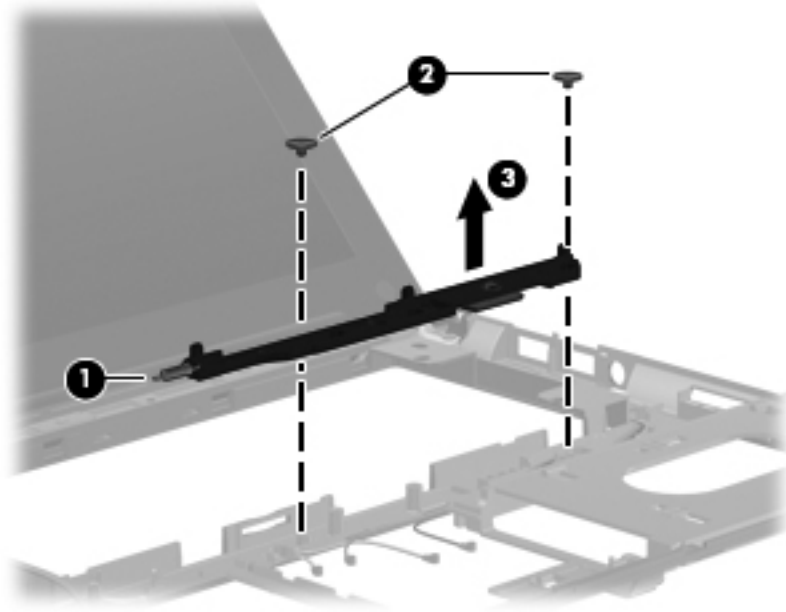

Reverse this procedure to install the battery eject arm.

## Display assembly



The display assembly spare part kit includes 2 WLAN antenna transceivers and cables, 2 WWAN antenna transceivers and cables, webcam, nameplate, and logo.

Description	Spare part number
13.3-in, HD, LED, AntiGlare display assembly	618827-001
13.3-in, HD, LED, BrightView display assembly	618828-001

Before removing the display assembly, follow these steps:

1. Shut down the computer. If you are unsure whether the computer is off or in Hibernation, turn the computer on, and then shut it down through the operating system.
2. Disconnect all external devices connected to the computer.
3. Disconnect the power from the computer by first unplugging the power cord from the AC outlet, and then unplugging the AC adapter from the computer.
4. Remove the battery (see [“Battery”](#) on page 4-7).
5. Remove the following components:
  - a. Accessory cover (see [“Mass storage device”](#) on page 4-9)
  - b. Keyboard (see [“Keyboard”](#) on page 4-23)
  - c. Button board and cable (see [“Button board and cable”](#) on page 4-26)
  - d. Top cover (see [“Top cover”](#) on page 4-28)
  - e. System board (see [“System board”](#) on page 4-33)

Remove the display assembly:

1. Remove the WLAN and WWAN antenna cables ❶ from the clips ❷ built into the base enclosure.

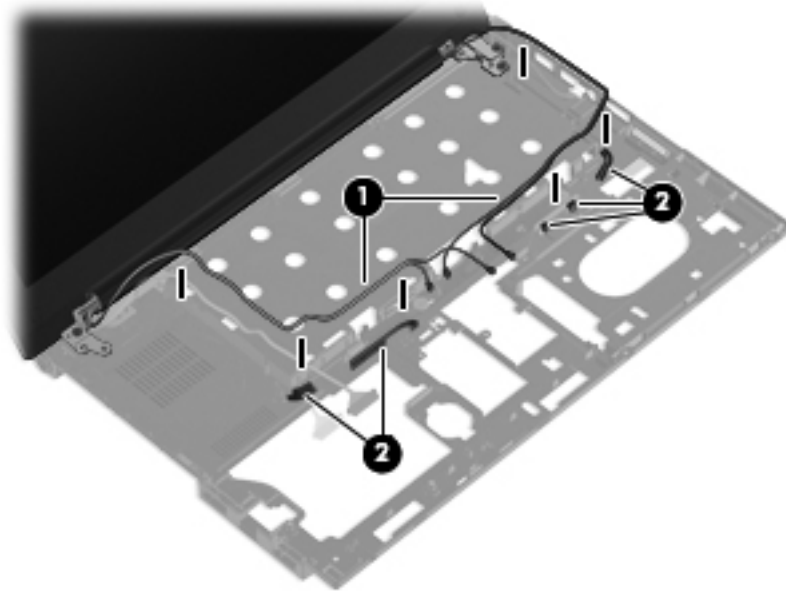

**CAUTION:** Support the display assembly when removing the following screws. Failure to support the display assembly can result in damage to the display assembly and other computer components.

2. Remove the two Torx T8M2.5×4.0 screws ❶ and the Torx T8M2.5×9.0 screw ❷ that secure the display assembly to the base enclosure.
3. Lift the display assembly ❸ straight up and remove it.

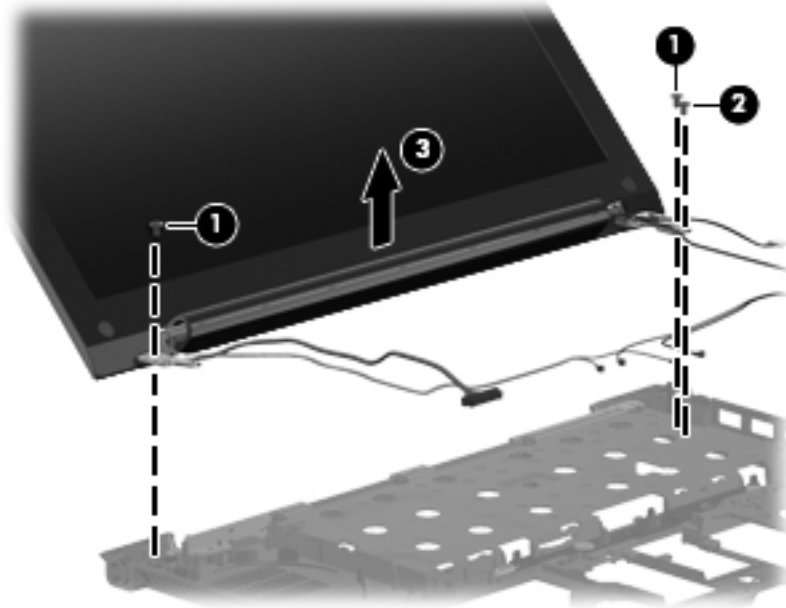

4. If it is necessary to replace the display bezel or any of the display assembly internal components:
  - a. Remove the two rubber screw covers ❶ and the two Phillips PM2.5×5.0 screws ❷ that secure the display bezel to the display enclosure.

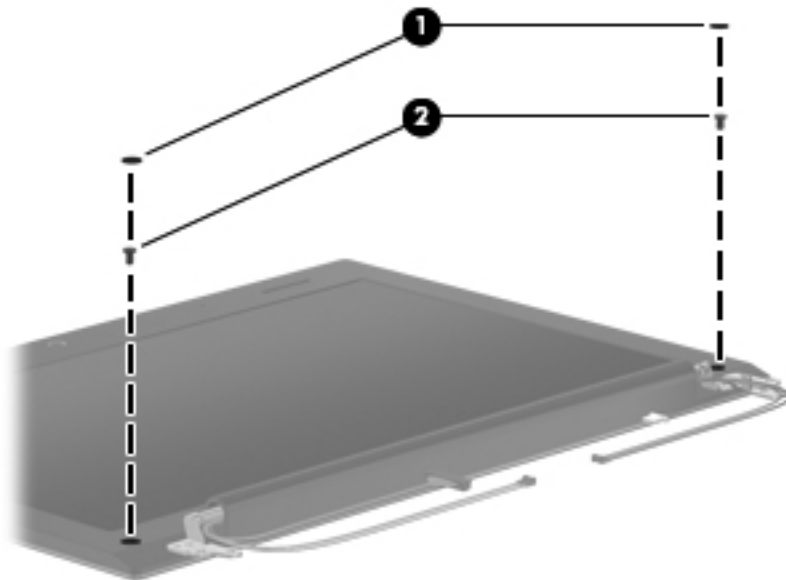

- b. Flex the inside edges of the top edge **1**, the left and right sides **2**, and the bottom edge **3** of the display bezel until the bezel disengages from the display enclosure.
- c. Remove the display bezel **4**. The display bezel is available using spare part number 618832-001.

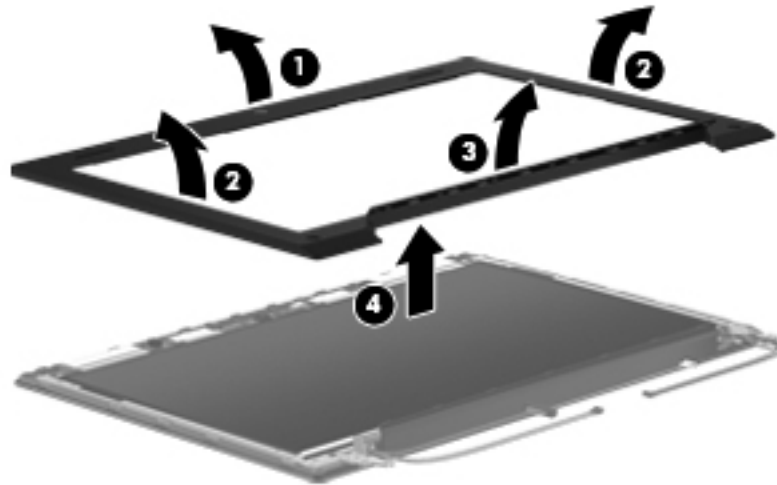

5. If it is necessary to replace the webcam module:
  - a. Release the webcam module **1** as far from the display enclosure as the webcam module cable allows. (The webcam module is attached to the display enclosure with double-sided tape.)
  - b. Disconnect the webcam module cable **2** from the webcam module.

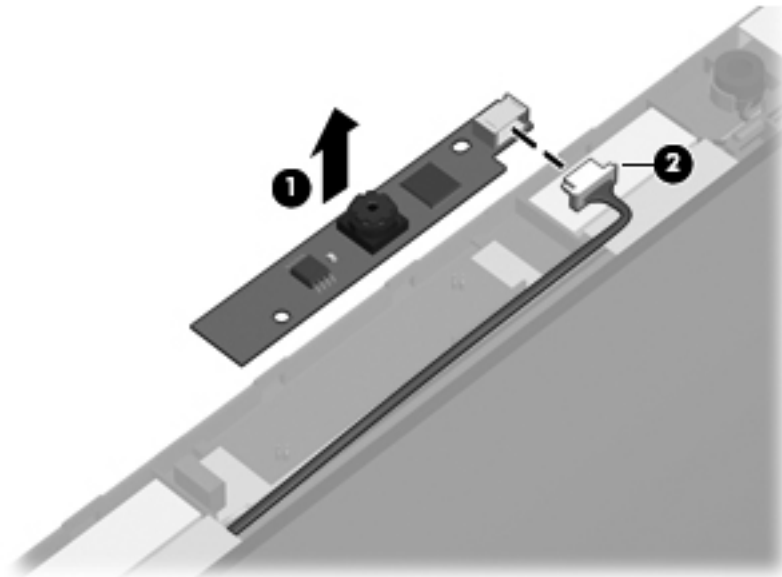

- c. Remove the webcam module. The webcam module is available using spare part number 618842-001.

6. If it is necessary to replace the display hinges:

- a. Remove the eight Torx T8M2.5×4.0 screws ❶ that secure the display hinges to the display enclosure.
- b. Remove the display hinges ❷. The display hinges are available in the Display Hinge Kit, spare part number 581094-001.

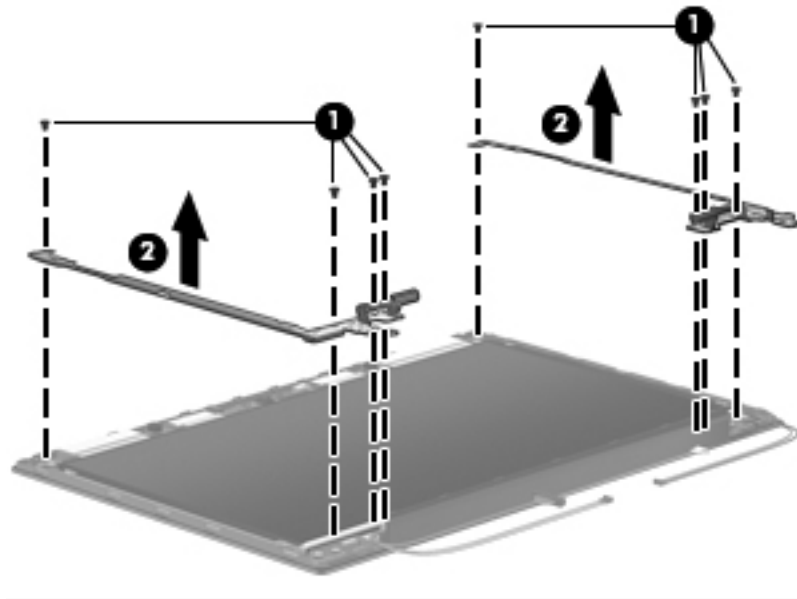



7. If it is necessary to replace the display panel cable:

- a. Lift the top edge of the display panel ❶ until it detaches from the display enclosure.
- b. Release the support bar ❷ that secures the display panel cable connector to the display panel.
- c. Disconnect the display panel cable ❸ from the display panel.

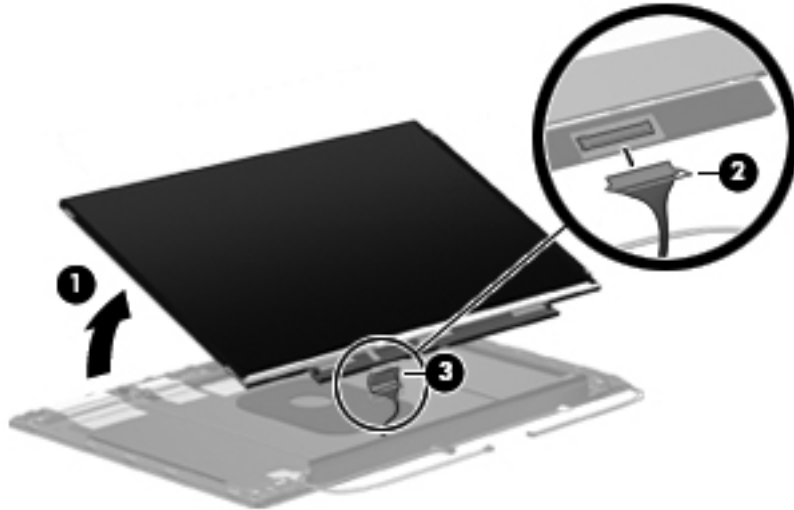

- d. Remove the display panel.
- e. Remove the display panel cable. The display panel cable is included in the Display Cable Kit, spare part number 618833-001.

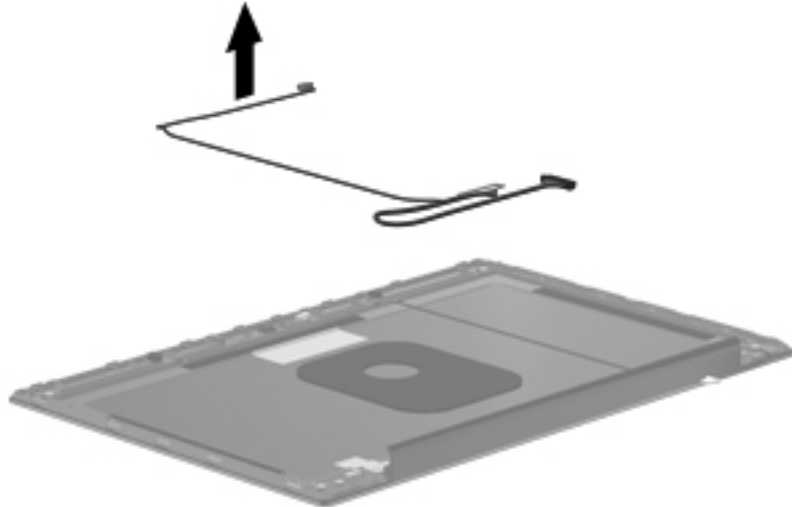

8. If it is necessary to replace the WWAN antenna transceivers and cables:

- a. Detach the WWAN antenna transceivers ❶ from the display enclosure. (The transceivers are attached to the enclosure with double-sided tape.)
- b. Release the WWAN antenna cables ❷ from the clips and routing channels built into the left and right sides of the display enclosure.

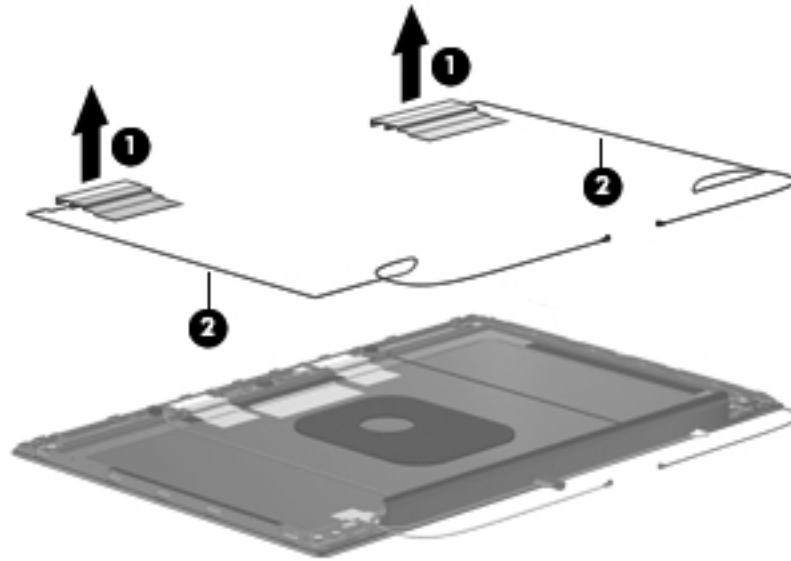

- c. Remove the WWAN wireless antenna transceivers and cables. The wireless antenna transceivers and cables are included in the Display Cable Kit, spare part number 618833-001.

9. If it is necessary to replace the WLAN antenna transceivers and cables:

- a. Detach the WLAN antenna transceivers ❶ from the display enclosure. (The transceivers are attached to the enclosure with double-sided tape.)
- b. Release the WLAN antenna cables ❷ from the clips and routing channel built into the left and right sides of the display enclosure.

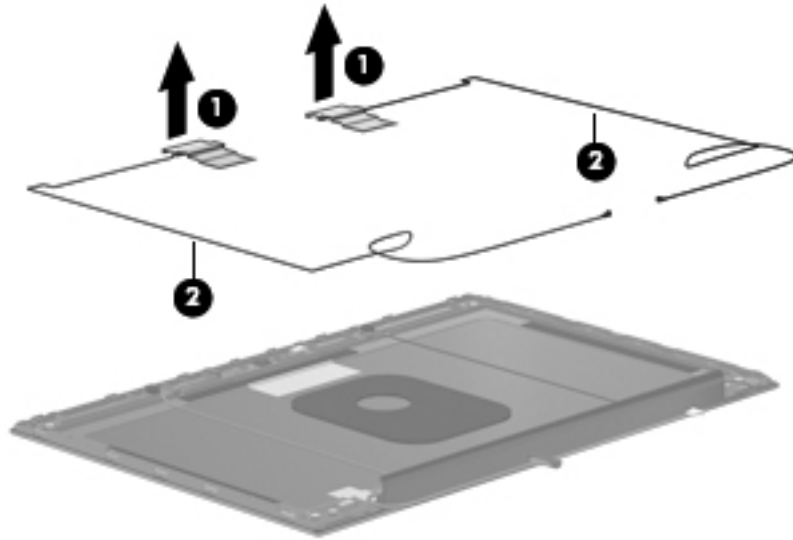

- c. Remove the WLAN wireless antenna transceivers and cables. The wireless antenna transceivers and cables are included in the Display Cable Kit, spare part number 618833-001.

10. If it is necessary to replace the microphones and cables:

- a. Release the microphone receivers ❶ from the clips built into the display enclosure.
- b. Release the microphone cables ❷ from the clips and routing channel built into the left side of the display enclosure.

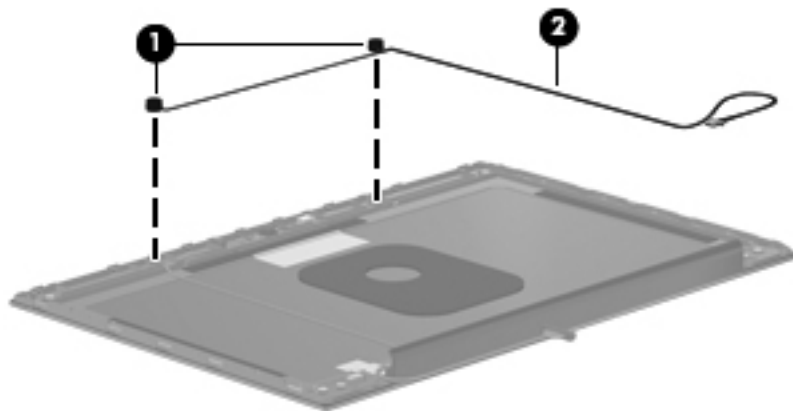

- c. Remove the microphones and cables. The microphones and cables are included in the Display Cable Kit, spare part number 618833-001.

Reverse this procedure to reassemble and install the display assembly.



## Computer Setup in Windows 7

### Starting Computer Setup

Computer Setup is a preinstalled, ROM-based utility that can be used even when the operating system is not working or will not load.



---

Some of the Computer Setup menu items listed in this guide may not be supported by your computer.

---



---

An external keyboard or mouse connected to a USB port can be used with Computer Setup only if USB legacy support is enabled.

---

To start Computer Setup, follow these steps:

1. Turn on or restart the computer, and then press **esc** while the “Press the ESC key for Startup Menu” message is displayed at the bottom of the screen.
2. Press **f10** to enter BIOS Setup.

### Using Computer Setup

#### Navigating and selecting in Computer Setup

The information and settings in Computer Setup are accessed from the File, Security, Diagnostics, and System Configuration menus.

To navigate and select in Computer Setup, follow these steps:

1. Turn on or restart the computer, and then press **esc** while the “Press the ESC key for Startup Menu” message is displayed at the bottom of the screen.
  - ❑ To select a menu or a menu item, use the **tab** key and the keyboard arrow keys and then press **enter**, or use a pointing device to click the item.
  - ❑ To scroll up and down, click the up arrow or the down arrow in the upper-right corner of the screen, or use the up arrow key or the down arrow key.
  - ❑ To close open dialog boxes and return to the main Computer Setup screen, press **esc**, and then follow the on-screen instructions.



You can use either a pointing device (TouchPad, pointing stick, or USB mouse) or the keyboard to navigate and make selections in Computer Setup.

2. Press **f10** to enter BIOS Setup.
3. Select the **File, Security, Diagnostics, or System Configuration** menu.

To exit Computer Setup menus, choose one of the following methods:

- To exit Computer Setup menus without saving your changes, click the **Exit** icon in the lower-left corner of the screen, and then follow the on-screen instructions.

– or –

Use the **tab** key and the arrow keys to select **File > Ignore Changes and Exit**, and then press **enter**.

– or –

- To save your changes and exit Computer Setup menus, click the **Save** icon in the lower-left corner of the screen, and then follow the on-screen instructions.

– or –

Use the **tab** key and the arrow keys to select **File > Save Changes and Exit**, and then press **enter**.

Your changes go into effect when the computer restarts.

## Restoring factory settings in Computer Setup



Restoring defaults will not change the hard drive mode.

---

To return all settings in Computer Setup to the values that were set at the factory, follow these steps:

1. Turn on or restart the computer, and then press **esc** while the “Press the ESC key for Startup Menu” message is displayed at the bottom of the screen.
2. Press **f10** to enter BIOS Setup.
3. Use a pointing device or the arrow keys to select **File > Restore Defaults**.
4. Follow the on-screen instructions.
5. To save your changes and exit, click the **Save** icon in the lower-left corner of the screen, and then follow the on-screen instructions.

– or –

Use the arrow keys to select **File > Save Changes and Exit**, and then press **enter**.

Your changes go into effect when the computer restarts.



Your password settings and security settings are not changed when you restore the factory settings.

---

## Computer Setup menus

The menu tables in this section provide an overview of Computer Setup options.



Some of the Computer Setup menu items listed in this chapter may not be supported by your computer.

### File menu

Select	To do this
System Information	<ul style="list-style-type: none"> <li>■ View identification information for the computer and the batteries in the system.</li> <li>■ View specification information for the processor, memory size, system ROM, video revision, and keyboard controller version, and wireless identification numbers.</li> </ul>
Restore Defaults	Replace the configuration settings in Computer Setup with the original factory settings. (Hard drive mode, password settings, and security settings are not changed when you restore the factory settings.)
Reset BIOS security to factory default	Resets password to the factory default in case of a forgotten password.
Ignore Changes and Exit	Cancel any changes entered during the current session. Then exit and restart the computer.
Save Changes and Exit	Save any changes entered during the current session. Then exit and restart the computer. Your changes go into effect when the computer restarts.



### Security menu



Some of the menu items listed in this section may not be supported by your computer.

Select	To do this
Setup BIOS Administrator Password	Set up a BIOS administrator password.
User Management (requires a BIOS administrator password)	<ul style="list-style-type: none"> <li>■ Create a new BIOS user account.</li> <li>■ View a list of ProtectTools users.</li> </ul>
Password Policy (requires a BIOS administrator password)	Revise password policy criteria.
HP SpareKey	Enable/disable HP SpareKey (enabled by default).
Always Prompt for HP SpareKey Enrollment	Enable/disable HP SpareKey enrollment (enabled by default).
Fingerprint Reset on Reboot (If Present)	Reset/clear the fingerprint reader ownership (select models only; disabled by default).
Allow reset of HP ProtectTools security keys	Enable/disable reset of HP ProtectTools security keys.
Change Password	Enter, change, or delete a BIOS administrator password.
HP SpareKey Enrollment	Enroll or reset HP SpareKey, which is a set of security questions and answers used if you forget your password.

(Continued)

Select	To do this
<b>Security menu</b> <i>(continued)</i>	
DriveLock Passwords	<ul style="list-style-type: none"> <li>■ Enable/disable DriveLock on any computer hard drive (enabled by default).</li> <li>■ Change a DriveLock user password or master password.</li> </ul> <p> DriveLock settings are accessible only when you enter Computer Setup by turning on (not restarting) the computer.</p>
TPM Embedded Security	<p>Enable/disable support for Trusted Platform Module (TPM) Embedded Security, which protects the computer from unauthorized access to owner functions available in Embedded Security for ProtectTools. For more information, refer to the ProtectTools software Help.</p> <p> You must have a setup password to change this setting.</p>
Automatic DriveLock	Enable/disable Automatic DriveLock support.
Disk Sanitizer	<p>Run Disk Sanitizer to destroy all existing data on the primary hard drive or the drive in the upgrade bay.</p> <p> If you run Disk Sanitizer, the data on the selected drive is destroyed permanently.</p>
System IDs	Enter a user-defined computer asset tracking number and ownership tag.

## Diagnostics menu

Select	To do this
System Diagnostics menu	<ul style="list-style-type: none"> <li>■ F1 System Information—Displays the following information: <ul style="list-style-type: none"> <li><input type="checkbox"/> Identification information for the computer and the batteries in the system.</li> <li><input type="checkbox"/> Specification information for the processor, memory size, system ROM, video revision, keyboard controller version, and wireless identification numbers.</li> </ul> </li> <li>■ F2 Start-up Test—Verifies the system components needed for starting the computer.</li> <li>■ F3 Run-In Test—Runs a comprehensive check on system memory.</li> <li>■ F4 Hard Disk Test—Runs a comprehensive self-test on any hard drive in the system.</li> <li>■ F5 Error Log—Displays a log file if any errors have occurred.</li> </ul>





## System Configuration menu



Some of the listed System Configuration options may not be supported by your computer.

Select	To do this
Language	Change the Computer Setup language.
Boot Options	<ul style="list-style-type: none"> <li>■ Set a Startup Menu delay (in seconds).</li> <li>■ Enable/disable Custom Logo (disabled by default).</li> <li>■ Enable/disable Display Diagnostic URL (enabled by default).</li> <li>■ Enable/disable CD-ROM boot (enabled by default).</li> <li>■ Enable/disable SD Card boot (enabled by default).</li> <li>■ Enable/disable floppy boot (enabled by default).</li> <li>■ Enable/disable PXE Internal NIC boot (enabled by default).</li> <li>■ Set the Express Boot Popup delay in seconds.</li> <li>■ Set the boot order.</li> </ul>
Device Configurations	<ul style="list-style-type: none"> <li>■ Enable/disable USB legacy support (enabled by default). When enabled, USB legacy support allows the following: <ul style="list-style-type: none"> <li><input type="checkbox"/> Use of a USB keyboard in Computer Setup even when a Windows operating system is not running.</li> <li><input type="checkbox"/> Startup from bootable USB devices, including a hard drive, diskette drive, or optical drive connected by a USB port to the computer.</li> </ul> </li> <li>■ Select a parallel port mode: ECP (Enhanced Capabilities Port), standard, bidirectional, or EPP (Enhanced Parallel Port).</li> <li>■ Enable/disable fan always on while connected to an AC outlet (enabled by default).</li> <li>■ Enable/disable Data Execution Prevention. When enabled, the processor can disable some virus code execution, which helps to improve computer security.</li> <li>■ Enable/disable LAN Power Save (select models only). When enabled, saves power by turning off the LAN when not in use (enabled by default).</li> <li>■ SATA (Serial Advanced Technology Attachment) device mode. The following options are available: <ul style="list-style-type: none"> <li><input type="checkbox"/> AHCI (Advanced Host Controller Interface)</li> <li><input type="checkbox"/> IDE (Integrated Drive Electronics)</li> <li><input type="checkbox"/> RAID (select models only)</li> </ul> </li> <li> Availability of the options above varies by computer model.</li> <li>■ Enable/disable secondary battery fast charge (enabled by default).</li> <li>■ Enable/disable HP QuickLook 3 (enabled by default).</li> <li>■ Enable/disable Virtualization Technology (select models only; disabled by default).</li> <li>■ Enable/disable TXT (Intel Trusted Execution Technology) (select models only; disabled by default).</li> </ul>

(Continued)

Select	To do this
<b>System Configuration menu</b> <i>(continued)</i>	
Device Configurations <i>(continued)</i>	<ul style="list-style-type: none"> <li>■ Enable/disable Dual Core CPU (select models only; enabled by default).</li> <li>■ Enable/Disable Unified Extensible Firmware Interface (UEFI) mode (disabled by default).</li> <li>■ Turn the Numlock state at boot on or off.</li> </ul>
Built-In Device Options	<ul style="list-style-type: none"> <li>■ Enable/disable the wireless button state (enabled by default).</li> <li>■ Enable/disable the embedded WLAN device (enabled by default).</li> <li>■ Enable/disable embedded WWAN device radio (select models only; enabled by default).</li> <li>■ Enable/disable embedded Bluetooth device radio (enabled by default).</li> <li>■ Enable/disable the Network Interface Controller (LAN) (enabled by default).</li> <li>■ Enable/disable LAN/WLAN switching (disabled by default).</li> <li>■ Set the wake on LAN state. Options include the following: <ul style="list-style-type: none"> <li><input type="checkbox"/> Disabled</li> <li><input type="checkbox"/> Boot to Network (set by default)</li> <li><input type="checkbox"/> Follow Boot Order</li> </ul> </li> <li>■ Enable/disable the fingerprint device (enabled by default).</li> <li>■ Enable/disable a modem device (enabled by default).</li> <li>■ Enable the ambient light sensor (enabled by default).</li> <li>■ Enable/disable the Notebook MultiBay device (enabled by default).</li> <li>■ Enable/disable the integrated camera (select models only; enabled by default).</li> <li>■ Enable/disable optical disk drive (enabled by default).</li> <li>■ Enable/disable internal microphones (enabled by default).</li> </ul>
Port Options (all are enabled by default)	<p> All port options are enabled by default.</p> <ul style="list-style-type: none"> <li>■ Enable/disable the Smart Card slot.</li> <li>■ Enable/disable the ExpressCard slot.</li> <li>■ Enable/disable the serial port.</li> <li>■ Enable/disable the parallel port.</li> <li>■ Enable/disable the flash media reader.</li> <li>■ Enable/disable the USB port.</li> </ul> <p> Disabling the USB port also disables MultiBay devices and ExpressCard devices on the advanced port replicator.</p> <ul style="list-style-type: none"> <li>■ Enable/disable the 1394 port.</li> </ul>
Set Security Level	Change, view, or hide security levels for all BIOS menu items.
Restore Security Defaults	Restore the default security settings.

# Computer Setup in Windows Vista

## Starting Computer Setup

Computer Setup is a preinstalled, ROM-based utility that can be used even when the operating system is not working or will not load.



Some of the Computer Setup menu items listed in this guide may not be supported by your computer.



An external keyboard or mouse connected to a USB port can be used with Computer Setup only if USB legacy support is enabled.

To start Computer Setup, follow these steps:

1. Turn on or restart the computer, and then press **esc** while the “Press the ESC key for Startup Menu” message is displayed at the bottom of the screen.
2. Press **f10** to enter BIOS Setup.

## Using Computer Setup

### Navigating and selecting in Computer Setup

The information and settings in Computer Setup are accessed from the File, Security, Diagnostics, and System Configuration menus.

To navigate and select in Computer Setup, follow these steps:

1. Turn on or restart the computer, and then press **esc** while the “Press the ESC key for Startup Menu” message is displayed at the bottom of the screen.
  - To select a menu or a menu item, use the **tab** key and the keyboard arrow keys and then press **enter**, or use a pointing device to click the item.
  - To scroll up and down, click the up arrow or the down arrow in the upper-right corner of the screen, or use the up arrow key or the down arrow key.
  - To close open dialog boxes and return to the main Computer Setup screen, press **esc**, and then follow the on-screen instructions.

 You can use either a pointing device (TouchPad, pointing stick, or USB mouse) or the keyboard to navigate and make selections in Computer Setup.

2. Press **f10** to enter BIOS Setup.
3. Select the **File**, **Security**, **Diagnostics**, or **System Configuration** menu.

To exit Computer Setup menus, choose one of the following methods:

- To exit Computer Setup menus without saving your changes, click the **Exit** icon in the lower-left corner of the screen, and then follow the on-screen instructions.

– or –

Use the **tab** key and the arrow keys to select **File > Ignore Changes and Exit**, and then press **enter**.

– or –

- To save your changes and exit Computer Setup menus, click the **Save** icon in the lower-left corner of the screen, and then follow the on-screen instructions.

– or –

Use the **tab** key and the arrow keys to select **File > Save Changes and Exit**, and then press **enter**.

Your changes go into effect when the computer restarts.

## Restoring factory settings in Computer Setup



Restoring defaults will not change the hard drive mode.

To return all settings in Computer Setup to the values that were set at the factory, follow these steps:

1. Turn on or restart the computer, and then press **esc** while the “Press the ESC key for Startup Menu” message is displayed at the bottom of the screen.
2. Press **f10** to enter BIOS Setup.
3. Use a pointing device or the arrow keys to select **File > Restore Defaults**.
4. Follow the on-screen instructions.
5. To save your changes and exit, click the **Save** icon in the lower-left corner of the screen, and then follow the on-screen instructions.

– or –

Use the arrow keys to select **File > Save Changes and Exit**, and then press **enter**.

Your changes go into effect when the computer restarts.



Your password settings and security settings are not changed when you restore the factory settings.

## Computer Setup menus

The menu tables in this section provide an overview of Computer Setup options.



Some of the Computer Setup menu items listed in this chapter may not be supported by your computer.



### File menu

Select	To do this
System Information	<ul style="list-style-type: none"> <li>■ View identification information for the computer and the batteries in the system.</li> <li>■ View specification information for the processor, memory size, system ROM, video revision, keyboard controller version, and wireless identification numbers.</li> </ul>
Restore Defaults	Replace the configuration settings in Computer Setup with the original factory settings. (Hard drive mode, password settings, and security settings are not changed when you restore the factory settings.)
Reset BIOS security to factory default	Resets password to the factory default in case of a forgotten password.
Ignore Changes and Exit	Cancel any changes entered during the current session. Then exit and restart the computer.
Save Changes and Exit	Save any changes entered during the current session. Then exit and restart the computer. Your changes go into effect when the computer restarts.

## Security menu



Some of the menu items listed in this section may not be supported by your computer.

Select	To do this
Setup BIOS Administrator Password	Set up a BIOS administrator password.
User Management (requires a BIOS administrator password)	<ul style="list-style-type: none"> <li>■ Create a new BIOS user account.</li> <li>■ View a list of ProtectTools users.</li> </ul>
Password Policy (requires a BIOS administrator password)	Revise password policy criteria.
HP SpareKey	Enable/disable HP SpareKey (enabled by default).
Always Prompt for HP SpareKey Enrollment	Enable/disable HP SpareKey enrollment (enabled by default).
Fingerprint Reset on Reboot (If Present)	Reset/clear the fingerprint reader ownership (select models only; disabled by default).
Allow reset of HP ProtectTools security keys	Enable/disable reset of HP ProtectTools security keys.
Change Password	Enter, change, or delete a BIOS administrator password.
HP SpareKey Enrollment	Enroll or reset HP SpareKey, which is a set of security questions and answers used if you forget your password.
DriveLock Passwords	<ul style="list-style-type: none"> <li>■ Enable/disable DriveLock on any computer hard drive (enabled by default).</li> <li>■ Change a DriveLock user password or master password.</li> </ul> <p> DriveLock settings are accessible only when you enter Computer Setup by turning on (not restarting) the computer.</p>
TPM Embedded Security	<p>Enable/disable support for Trusted Platform Module (TPM) Embedded Security, which protects the computer from unauthorized access to owner functions available in Embedded Security for ProtectTools. For more information, refer to the ProtectTools software Help.</p> <p> You must have a setup password to change this setting.</p>
Automatic DriveLock	Enable/disable Automatic DriveLock support.
Disk Sanitizer	<p>Run Disk Sanitizer to destroy all existing data on the primary hard drive or the drive in the upgrade bay.</p> <p> If you run Disk Sanitizer, the data on the selected drive is destroyed permanently.</p>
System IDs	Enter a user-defined computer asset tracking number and ownership tag.

## Diagnostics menu

Select	To do this
System Diagnostics menu	<ul style="list-style-type: none"> <li>■ F1 System Information—Displays the following information:               <ul style="list-style-type: none"> <li><input type="checkbox"/> Identification information for the computer and the batteries in the system.</li> <li><input type="checkbox"/> Specification information for the processor, memory size, system ROM, video revision, keyboard controller version, and wireless identification numbers.</li> </ul> </li> <li>■ F2 Start-up Test—Verifies the system components needed for starting the computer.</li> <li>■ F3 Run-In Test—Runs a comprehensive check on system memory.</li> <li>■ F4 Hard Disk Test—Runs a comprehensive self-test on any hard drive in the system.</li> <li>■ F5 Error Log—Displays a log file if any errors have occurred.</li> </ul>

## System Configuration menu





Some of the listed System Configuration options may not be supported by your computer.

Select	To do this
Language	Change the Computer Setup language.
Boot Options	<ul style="list-style-type: none"> <li>■ Set a Startup Menu delay (in seconds).</li> <li>■ Enable/disable Custom Logo (disabled by default).</li> <li>■ Enable/disable Display Diagnostic URL (enabled by default).</li> <li>■ Enable/disable CD-ROM boot (enabled by default).</li> <li>■ Enable/disable SD Card boot (enabled by default).</li> <li>■ Enable/disable floppy boot (enabled by default).</li> <li>■ Enable/disable PXE Internal NIC boot (enabled by default).</li> <li>■ Set the Express Boot Popup delay in seconds.</li> <li>■ Set the boot order.</li> </ul>
Device Configurations	<ul style="list-style-type: none"> <li>■ Enable/disable USB legacy support (enabled by default). When enabled, USB legacy support allows the following:               <ul style="list-style-type: none"> <li><input type="checkbox"/> Use of a USB keyboard in Computer Setup even when a Windows operating system is not running.</li> <li><input type="checkbox"/> Startup from bootable USB devices, including a hard drive, diskette drive, or optical drive connected by a USB port to the computer.</li> </ul> </li> <li>■ Select a parallel port mode: ECP (Enhanced Capabilities Port), standard, bidirectional, or EPP (Enhanced Parallel Port).</li> <li>■ Enable/disable fan always on while connected to an AC outlet (enabled by default).</li> </ul>

(Continued)

Select	To do this
<b>System Configuration menu</b> <i>(continued)</i>	
Device Configurations <i>(continued)</i>	<ul style="list-style-type: none"> <li>■ Enable/disable Data Execution Prevention. When enabled, the processor can disable some virus code execution, which helps to improve computer security.</li> <li>■ Enable/disable LAN Power Save (select models only). When enabled, saves power by turning off the LAN when not in use (enabled by default).</li> <li>■ SATA (Serial Advanced Technology Attachment) device mode. The following options are available: <ul style="list-style-type: none"> <li><input type="checkbox"/> AHCI (Advanced Host Controller Interface)</li> <li><input type="checkbox"/> IDE (Integrated Drive Electronics)</li> <li><input type="checkbox"/> RAID (select models only)</li> </ul> </li> <li> Availability of the options above varies by computer model.</li> <li>■ Enable/disable secondary battery fast charge (enabled by default).</li> <li>■ Enable/disable HP QuickLook 3 (enabled by default).</li> <li>■ Enable/disable Virtualization Technology (select models only; disabled by default).</li> <li>■ Enable/disable TXT (Intel Trusted Execution Technology) (select models only; disabled by default).</li> <li>■ Enable/disable Dual Core CPU (select models only; enabled by default).</li> <li>■ Enable/Disable Unified Extensible Firmware Interface (UEFI) mode (disabled by default).</li> <li>■ Turn the Numlock state at boot on or off.</li> </ul>
Built-In Device Options	<ul style="list-style-type: none"> <li>■ Enable/disable the wireless button state (enabled by default).</li> <li>■ Enable/disable the embedded WLAN device (enabled by default).</li> <li>■ Enable/disable embedded WWAN device radio (select models only; enabled by default).</li> <li>■ Enable/disable embedded Bluetooth device radio (enabled by default).</li> <li>■ Enable/disable the Network Interface Controller (LAN) (enabled by default).</li> <li>■ Enable/disable LAN/WLAN switching (disabled by default).</li> <li>■ Set the wake on LAN state. Options include the following: <ul style="list-style-type: none"> <li><input type="checkbox"/> Disabled</li> <li><input type="checkbox"/> Boot to Network (set by default)</li> <li><input type="checkbox"/> Follow Boot Order</li> </ul> </li> <li>■ Enable/disable the fingerprint device (enabled by default).</li> </ul>

*(Continued)*

Select	To do this
<b>System Configuration menu</b> <i>(continued)</i>	
Built-In Device Options <i>(continued)</i>	<ul style="list-style-type: none"> <li>■ Enable/disable a modem device (enabled by default).</li> <li>■ Enable the ambient light sensor (enabled by default).</li> <li>■ Enable/disable the Notebook MultiBay device (enabled by default).</li> <li>■ Enable/disable the integrated camera (select models only; enabled by default).</li> <li>■ Enable/disable optical disk drive (enabled by default).</li> <li>■ Enable/disable internal microphones (enabled by default).</li> </ul>
Port Options (all are enabled by default)	<p> All port options are enabled by default.</p> <ul style="list-style-type: none"> <li>■ Enable/disable the Smart Card slot.</li> <li>■ Enable/disable the ExpressCard slot.</li> <li>■ Enable/disable the serial port.</li> <li>■ Enable/disable the parallel port.</li> <li>■ Enable/disable the flash media reader.</li> <li>■ Enable/disable the USB port.</li> </ul> <p> Disabling the USB port also disables MultiBay devices and ExpressCard devices on the advanced port replicator.</p> <ul style="list-style-type: none"> <li>■ Enable/disable the 1394 port.</li> </ul>
Set Security Level	Change, view, or hide security levels for all BIOS menu items.
Restore Security Defaults	Restore the default security settings.



# Computer Setup in Windows XP

## Starting Computer Setup

Computer Setup is a preinstalled, ROM-based utility that can be used even when the operating system is not working or will not load.



Some of the Computer Setup menu items listed in this guide may not be supported by your computer.



An external keyboard or mouse connected to a USB port can be used with Computer Setup only if USB legacy support is enabled.

To start Computer Setup, follow these steps:

1. Turn on or restart the computer, and then press **esc** while the “Press the ESC key for Startup Menu” message is displayed at the bottom of the screen.
2. Press **f10** to enter BIOS Setup.

## Using Computer Setup

### Navigating and selecting in Computer Setup

The information and settings in Computer Setup are accessed from the File, Security, Diagnostics, and System Configuration menus.

To navigate and select in Computer Setup, follow these steps:

1. Turn on or restart the computer, and then press **esc** while the “Press the ESC key for Startup Menu” message is displayed at the bottom of the screen.
  - To select a menu or a menu item, use the **tab** key and the keyboard arrow keys and then press **enter**, or use a pointing device to click the item.
  - To scroll up and down, click the up arrow or the down arrow in the upper-right corner of the screen, or use the up arrow key or the down arrow key.
  - To close open dialog boxes and return to the main Computer Setup screen, press **esc**, and then follow the on-screen instructions.



You can use either a pointing device (TouchPad, pointing stick, or USB mouse) or the keyboard to navigate and make selections in Computer Setup.

2. Press **f10** to enter BIOS Setup.
3. Select the **File**, **Security**, **Diagnostics**, or **System Configuration** menu.

To exit Computer Setup menus, choose one of the following methods:

- To exit Computer Setup menus without saving your changes, click the **Exit** icon in the lower-left corner of the screen, and then follow the on-screen instructions.

– or –

Use the **tab** key and the arrow keys to select **File > Ignore Changes and Exit**, and then press **enter**.

– or –

- To save your changes and exit Computer Setup menus, click the **Save** icon in the lower-left corner of the screen, and then follow the on-screen instructions.

– or –

Use the **tab** key and the arrow keys to select **File > Save Changes and Exit**, and then press **enter**.

Your changes go into effect when the computer restarts.

## Restoring factory settings in Computer Setup



Restoring defaults will not change the hard drive mode.

To return all settings in Computer Setup to the values that were set at the factory, follow these steps:

1. Turn on or restart the computer, and then press **esc** while the “Press the ESC key for Startup Menu” message is displayed at the bottom of the screen.
2. Press **f10** to enter BIOS Setup.
3. Use a pointing device or the arrow keys to select **File > Restore Defaults**.
4. Follow the on-screen instructions.
5. To save your changes and exit, click the **Save** icon in the lower-left corner of the screen, and then follow the on-screen instructions.

– or –

Use the arrow keys to select **File > Save Changes and Exit**, and then press **enter**.

Your changes go into effect when the computer restarts.



Your password settings and security settings are not changed when you restore the factory settings.

## Computer Setup menus

The menu tables in this section provide an overview of Computer Setup options.



Some of the Computer Setup menu items listed in this chapter may not be supported by your computer.



### File menu

Select	To do this
System Information	<ul style="list-style-type: none"> <li>■ View identification information for the computer and the batteries in the system.</li> <li>■ View specification information for the processor, memory size, system ROM, video revision, keyboard controller version, and wireless identification version.</li> </ul>
Restore Defaults	Replace the configuration settings in Computer Setup with the original factory settings. (Hard drive mode, password settings, and security settings are not changed when you restore the factory settings.)
Reset BIOS security to factory default	Resets password to the factory default in case of a forgotten password.
Ignore Changes and Exit	Cancel any changes entered during the current session. Then exit and restart the computer.
Save Changes and Exit	Save any changes entered during the current session. Then exit and restart the computer. Your changes go into effect when the computer restarts.

## Security menu



Some of the menu items listed in this section may not be supported by your computer.

Select	To do this
Setup BIOS Administrator Password	Set up a BIOS administrator password.
User Management (requires a BIOS administrator password)	<ul style="list-style-type: none"> <li>■ Create a new BIOS user account.</li> <li>■ View a list of ProtectTools users.</li> </ul>
Password Policy (requires a BIOS administrator password)	Revise password policy criteria.
HP SpareKey	Enable/disable HP SpareKey (enabled by default).
Always Prompt for HP SpareKey Enrollment	Enable/disable HP SpareKey enrollment (enabled by default).
Fingerprint Reset on Reboot (If Present)	Reset/clear the fingerprint reader ownership (select models only; disabled by default).
Allow reset of HP ProtectTools security keys	Enable/disable reset of HP ProtectTools security keys.
Change Password	Enter, change, or delete a BIOS administrator password.
HP SpareKey Enrollment	Enroll or reset HP SpareKey, which is a set of security questions and answers used if you forget your password.
DriveLock Passwords	<ul style="list-style-type: none"> <li>■ Enable/disable DriveLock on any computer hard drive (enabled by default).</li> <li>■ Change a DriveLock user password or master password.</li> </ul> <p> DriveLock settings are accessible only when you enter Computer Setup by turning on (not restarting) the computer.</p>
TPM Embedded Security	<p>Enable/disable support for Trusted Platform Module (TPM) Embedded Security, which protects the computer from unauthorized access to owner functions available in Embedded Security for ProtectTools. For more information, refer to the ProtectTools software Help.</p> <p> You must have a setup password to change this setting.</p>
Automatic DriveLock	Enable/disable Automatic DriveLock support.
Disk Sanitizer	<p>Run Disk Sanitizer to destroy all existing data on the primary hard drive or the drive in the upgrade bay.</p> <p> If you run Disk Sanitizer, the data on the selected drive is destroyed permanently.</p>
System IDs	Enter a user-defined computer asset tracking number and ownership tag.

## Diagnostics menu

Select	To do this
System Diagnostics menu	<ul style="list-style-type: none"><li>■ F1 System Information—Displays the following information:<ul style="list-style-type: none"><li><input type="checkbox"/> Identification information for the computer and the batteries in the system.</li><li><input type="checkbox"/> Specification information for the processor, memory size, system ROM, video revision, keyboard controller version, and wireless identification numbers.</li></ul></li><li>■ F2 Start-up Test—Verifies the system components needed for starting the computer.</li><li>■ F3 Run-In Test—Runs a comprehensive check on system memory.</li><li>■ F4 Hard Disk Test—Runs a comprehensive self-test on any hard drive in the system.</li><li>■ F5 Error Log—Displays a log file if any errors have occurred.</li></ul>



## System Configuration menu



Some of the listed System Configuration options may not be supported by your computer.

Select	To do this
Language	Change the Computer Setup language.
Boot Options	<ul style="list-style-type: none"> <li>■ Set a Startup Menu delay (in seconds).</li> <li>■ Enable/disable Custom Logo (disabled by default).</li> <li>■ Enable/disable Display Diagnostic URL (enabled by default).</li> <li>■ Enable/disable CD-ROM boot (enabled by default).</li> <li>■ Enable/disable SD Card boot (enabled by default).</li> <li>■ Enable/disable floppy boot (enabled by default).</li> <li>■ Enable/disable PXE Internal NIC boot (enabled by default).</li> <li>■ Set the Express Boot Popup delay in seconds.</li> <li>■ Set the boot order.</li> </ul>
Device Configurations	<ul style="list-style-type: none"> <li>■ Enable/disable USB legacy support (enabled by default). When enabled, USB legacy support allows the following:               <ul style="list-style-type: none"> <li><input type="checkbox"/> Use of a USB keyboard in Computer Setup even when a Windows operating system is not running.</li> <li><input type="checkbox"/> Startup from bootable USB devices, including a hard drive, diskette drive, or optical drive connected by a USB port to the computer.</li> </ul> </li> <li>■ Select a parallel port mode: ECP (Enhanced Capabilities Port), standard, bidirectional, or EPP (Enhanced Parallel Port).</li> <li>■ Enable/disable fan always on while connected to an AC outlet (enabled by default).</li> <li>■ Enable/disable Data Execution Prevention. When enabled, the processor can disable some virus code execution, which helps to improve computer security.</li> <li>■ Enable/disable LAN Power Save (select models only). When enabled, saves power by turning off the LAN when not in use (enabled by default).</li> <li>■ SATA (Serial Advanced Technology Attachment) device mode. The following options are available:               <ul style="list-style-type: none"> <li><input type="checkbox"/> AHCI (Advanced Host Controller Interface)</li> <li><input type="checkbox"/> IDE (Integrated Drive Electronics)</li> <li><input type="checkbox"/> RAID (select models only)</li> </ul> </li> <li> Availability of the options above varies by computer model.</li> <li>■ Enable/disable secondary battery fast charge (enabled by default).</li> <li>■ Enable/disable HP QuickLook 3 (enabled by default).</li> <li>■ Enable/disable Virtualization Technology (select models only; disabled by default).</li> <li>■ Enable/disable TXT (Intel Trusted Execution Technology) (select models only; disabled by default).</li> </ul>

(Continued)

Select	To do this
<b>System Configuration menu</b> <i>(continued)</i>	
Device Configurations <i>(continued)</i>	<ul style="list-style-type: none"> <li>■ Enable/disable Dual Core CPU (select models only; enabled by default).</li> <li>■ Enable/Disable Unified Extensible Firmware Interface (UEFI) mode (disabled by default).</li> <li>■ Turn the Numlock state at boot on or off.</li> </ul>
Built-In Device Options	<ul style="list-style-type: none"> <li>■ Enable/disable the wireless button state (enabled by default).</li> <li>■ Enable/disable the embedded WLAN device (enabled by default).</li> <li>■ Enable/disable embedded WWAN device radio (select models only; enabled by default).</li> <li>■ Enable/disable embedded Bluetooth device radio (enabled by default).</li> <li>■ Enable/disable the Network Interface Controller (LAN) (enabled by default).</li> <li>■ Enable/disable LAN/WLAN switching (disabled by default).</li> <li>■ Set the wake on LAN state. Options include the following: <ul style="list-style-type: none"> <li><input type="checkbox"/> Disabled</li> <li><input type="checkbox"/> Boot to Network (set by default)</li> <li><input type="checkbox"/> Follow Boot Order</li> </ul> </li> <li>■ Enable/disable the fingerprint device (enabled by default).</li> <li>■ Enable/disable a modem device (enabled by default).</li> <li>■ Enable the ambient light sensor (enabled by default).</li> <li>■ Enable/disable the Notebook MultiBay device (enabled by default).</li> <li>■ Enable/disable the integrated camera (select models only; enabled by default).</li> <li>■ Enable/disable optical disk drive (enabled by default).</li> <li>■ Enable/disable internal microphones (enabled by default).</li> </ul>
Port Options (all are enabled by default)	<p> All port options are enabled by default.</p> <ul style="list-style-type: none"> <li>■ Enable/disable the Smart Card slot.</li> <li>■ Enable/disable the ExpressCard slot.</li> <li>■ Enable/disable the serial port.</li> <li>■ Enable/disable the parallel port.</li> <li>■ Enable/disable the flash media reader.</li> <li>■ Enable/disable the USB port.</li> </ul> <p> Disabling the USB port also disables MultiBay devices and ExpressCard devices on the advanced port replicator.</p> <ul style="list-style-type: none"> <li>■ Enable/disable the 1394 port.</li> </ul>
Set Security Level	Change, view, or hide security levels for all BIOS menu items
Restore Security Defaults	Restore the default security settings.

# Specifications

## Computer specifications

	Metric	U.S.
<b>Dimensions</b>		
Depth	22.1 cm	8.7 in
Width	32.8 cm	12.9 in
Height (front to back)	2.4 cm	0.93 in
<b>Weight</b>		
	1.72 kg	3.79 lbs
<b>Input power</b>		
Operating voltage	18.5 V dc @ 3.5 A - 65 W	
Operating current	3.5 A	
<b>Temperature</b>		
Operating (not writing to optical disc)	0°C to 35°C	32°F to 95°F
Operating (writing to optical disc)	5°C to 35°C	41°F to 95°F
Nonoperating	-20°C to 60°C	-4°F to 140°F
<b>Relative humidity</b>		
Operating	10% to 90%	
Nonoperating	5% to 95%	
<b>Maximum altitude</b> (unpressurized)		
Operating	-15 m to 3,048 m	-50 ft to 10,000 ft
Nonoperating	-15 m to 12,192 m	-50 ft to 40,000 ft



Applicable product safety standards specify thermal limits for plastic surfaces. The computer operates well within this range of temperatures.

## 13.3-in display specifications

	Metric	U.S.
<b>Dimensions</b>		
Height	<b>17.8 cm</b>	7.0 in
Width	<b>28.4 cm</b>	11.2 in
Diagonal	<b>33.6 cm</b>	13.3 in
<b>Number of colors</b>	Up to 16.8 million	
<b>Contrast ratio</b>	250:1 (typical)	
<b>Brightness</b>	200 nits (typical)	
<b>Pixel resolution</b>		
Pitch	<b>0.279 × 0.279 mm</b>	
Format	<b>1366 × 768</b>	
Configuration	RGB vertical stripe	
<b>Backlight</b>	LED	
<b>Character display</b>	80 × 25	
<b>Total power consumption</b>	4.0 W	
<b>Viewing angle</b>	±40° horizontal, +120°/-40° vertical (typical)	



## Hard drive specifications

	500-GB*	320-GB*	250-GB*
<b>Dimensions</b>			
Height	9.5 mm	9.5 mm	9.5 mm
Width	70 mm	70 mm	70 mm
Weight	101 g	101 g	101 g
<b>Interface type</b>			
	SATA	SATA	SATA
<b>Transfer rate</b>			
	100 MB/sec	100 MB/sec	100 MB/sec
<b>Security</b>			
	ATA security	ATA security	ATA security
<b>Seek times</b> (typical read, including setting)			
Single track	1.5 ms	1.5 ms	2.0 ms
Average	12.0 ms	12.0 ms	12.0 ms
Maximum	22.0 ms	22.0 ms	22.0 ms
<b>Logical blocks</b>			
	625,142,448	625,142,448	488,397,168
<b>Disc rotational speed</b>			
	7200 rpm	7200 rpm	7200 rpm
<b>Operating temperature</b>			
	5°C to 55°C (41°F to 131°F)		
*1 GB = 1 billion bytes when referring to hard drive storage capacity. Actual accessible capacity is less. Actual drive specifications may differ slightly.			
 Certain restrictions and exclusions apply. Contact technical support for details.			



---

## Backup and recovery

### Backup and recovery in Windows 7

#### Overview

To protect your information, use Windows Backup and Restore to back up individual files and folders, back up our entire hard drive (select models only), create system repair discs (select models only), or create system restore points. In case of system failure, you can use the backup files to restore the contents of your computer.

Windows Backup and Restore provides the following options:

- Creating a system repair disc (select models only)
- Backing up individual files and folders
- Creating a system image (select models only)
- Scheduling automatic backups (select models only)
- Creating system restore points
- Recovering individual files
- Restoring the computer to a previous state
- Recovering information using recovery tools



For detailed instructions, perform a search for these topics in Help and Support.

---



In case of system instability, HP recommends that you print the recovery procedures and save them for later use.

---

#### Backing up your information

Recovery after a system failure is as complete as your most current backup. You should create system repair discs (select models only) and your initial backup immediately after software setup. As you add new software and data files, you should continue to back up your system on a regular basis to maintain a reasonably current backup. The system repair discs (select models only) are used to start up (boot) the computer and repair the operating system in case of system instability or failure. Your initial and subsequent backups allow you to restore your data and settings if a failure occurs.

You can back up your information to an optional external hard drive, a network drive, or discs.

Note the following when backing up:

- Store personal files in the Documents library, and back it up regularly.
- Back up templates that are stored in their associated programs.
- Save customized settings that appear in a window, toolbar, or menu bar by taking a screen shot of your settings. The screen shot can be a time-saver if you have to reset your preferences.

To create a screen shot:

1. Display the screen you want to save.
2. Copy the screen image:

To copy only the active window, press **alt+fn+prt sc**.

To copy the entire screen, press **fn+prt sc**.

3. Open a word-processing document, and then select **Edit > Paste**.

The screen image is added to the document.

4. Save the document.

- When backing up to discs, use any of the following types of discs (purchased separately): CD-R, CD-RW, DVD+R, DVD+R DL, DVD-R, DVD-R DL, or DVD+/-RW. The discs you use will depend on the type of optical drive installed in your computer.

 DVDs and DVDs with double-layer (DL) support store more information than CDs, so using them for backup reduces the number of recovery discs required.

- When backing up to discs, number each disc before inserting it into the optical drive of the computer.

To create a backup using Backup and Restore, follow these steps:

---

 Be sure that the computer is connected to AC power before you start the backup process.

---

 The backup process may take over an hour, depending on file size and the speed of the computer.

---

1. Select **Start > All Programs > Maintenance > Backup and Restore**.
2. Follow the on-screen instructions to set up your backup, create a system image (select models only), or create a system repair disc (select models only).

 Windows includes the User Account Control feature to improve the security of your computer. You may be prompted for your permission or password for tasks such as installing software, running utilities, or changing Windows settings. Refer to Help and Support for more information.

---

## Performing a recovery

In case of system failure or instability, the computer provides the following tools to recover your files:

- **Windows recovery tools:** You can use Windows Backup and Restore to recover information you have previously backed up. You can also use Windows Startup Repair to fix problems that might prevent Windows from starting correctly.
- **f11 recovery tools:** You can use the **f11** recovery tools to recover your original hard drive image. The image includes the Windows operating system and software programs installed at the factory.



If you are unable to boot (start up) your computer and you cannot use the system repair discs you previously created (select models only), you must purchase a Windows 7 operating system DVD to reboot the computer and repair the operating system. For additional information, refer to the “Using a Windows 7 operating system DVD (purchased separately)” section in this chapter.

## Using the Windows recovery tools

To recover information you previously backed up, follow these steps:

1. Select **Start > All Programs > Maintenance > Backup and Restore**.
2. Follow the on-screen instructions to recover your system settings, your computer (select models only), or your files.



Windows includes the User Account Control feature to improve the security of your computer. You may be prompted for your permission or password for tasks such as installing software, running utilities, or changing Windows settings. Refer to Help and Support for more information.

To recover your information using Startup Repair, follow these steps:



**CAUTION:** Using Startup Repair completely erases hard drive contents and reformats the hard drive. All files you have created and any software installed on the computer are permanently removed. When reformatting is complete, the recovery process restores the operating system, as well as the drivers, software, and utilities from the backup used for recovery.

1. If possible, back up all personal files.
2. If possible, check for the presence of the Windows partition and the HP Recovery partition.  
To check for the Windows partition, select **Start > Computer**.  
To check for the HP Recovery partition, select **Start**, right-click **Computer**, click **Manage**, and then click **Disk Management**.
- 
 If the Windows partition and the HP Recovery partition are not listed, you must recover your operating system and programs using the Windows 7 operating system DVD and the *Driver Recovery* disc (both purchased separately). For additional information, refer to the “Using a Windows 7 operating system DVD (purchased separately)” section in this guide.
3. If the Windows partition and the HP Recovery partition are listed, restart the computer, and then press **f8** before the Windows operating system loads.
4. Select **Startup Repair**.
5. Follow the on-screen instructions.



For additional information on recovering information using the Windows tools, perform a search for these topics in Help and Support.

## Using f11 recovery tools

---

**CAUTION:** Using **f11** completely erases hard drive contents and reformats the hard drive. All files you have created and any software installed on the computer are permanently removed. The **f11** recovery tool reinstalls the operating system and HP programs and drivers that were installed at the factory. Software not installed at the factory must be reinstalled.

---

To recover the original hard drive image using **f11**, follow these steps:

1. If possible, back up all personal files.
2. If possible, check for the presence of the HP Recovery partition: select **Start**, right-click **Computer**, click **Manage**, and then click **Disk Management**.

 If the HP Recovery partition is not listed, you must recover your operating system and programs using the Windows 7 operating system DVD and the *Driver Recovery disc* (both purchased separately). For additional information, refer to the “Using a Windows 7 operating system DVD (purchased separately)” section in this chapter.

3. If the HP Recovery partition is listed, restart the computer, and then press **esc** while the “Press the ESC key for Startup Menu” message is displayed at the bottom of the screen.
4. Press **f11** while the “Press <F11> for recovery” message is displayed on the screen.
5. Follow the on-screen instructions.

## Using a Windows 7 operating system DVD (purchased separately)

If you are unable to boot (start up) your computer and you cannot use the system repair discs you previously created (select models only), you must purchase a Windows 7 operating system DVD to reboot the computer and repair the operating system. Make sure that your most recent backup (stored on discs or on an external drive) is easily accessible. To order a Windows 7 operating system DVD, go to <http://www.hp.com/support>, select your country or region, and follow the on-screen instructions. You can also order the DVD by calling technical support. For contact information, refer to the *Worldwide Telephone Numbers* booklet included with the computer.



---

**CAUTION:** Using a Windows 7 operating system DVD completely erases hard drive contents and reformats the hard drive. All files you have created and any software installed on the computer are permanently removed. When reformatting is complete, the recovery process helps you restore the operating system, as well as drivers, software, and utilities.

---

To initiate recovery using a Windows 7 operating system DVD, follow these steps:



---

This process takes several minutes.

---

1. If possible, back up all personal files.
2. Restart the computer, and then insert the Windows 7 operating system DVD into the optical drive before the Windows operating system loads.
3. When prompted, press any keyboard key.
4. Follow the on-screen instructions.
5. Click **Next**.
6. Select **Repair your computer**.
7. Follow the on-screen instructions.

# Backup and recovery in Windows Vista

## Overview

To protect your information, use the Backup and Restore Center to back up individual files and folders, back up your entire hard drive (select models only), or create system restore points. In case of system failure, you can use the backup files to restore the contents of your computer.

The Backup and Restore Center provides the following options:

- Backing up individual files and folders
- Backing up the entire hard drive (select models only)
- Scheduling automatic backups (select models only)
- Creating system restore points
- Recovering individual files
- Restoring the computer to a previous state
- Recovering information using recovery tools



---

For detailed instructions, perform a search for these topics in Help and Support.

In case of system instability, HP recommends that you print the recovery procedures and save them for later use.

---

## Backing up your information

Recovery after a system failure is as complete as your most current backup. You should create your initial backup immediately after software setup. As you add new software and data files, you should continue to back up your system on a regular basis to maintain a reasonably current backup.

You can back up your information to an optional external hard drive, a network drive, or discs.

Note the following when backing up:

- Store personal files in the Documents folder, and back it up regularly.
- Back up templates that are stored in their associated programs.
- Save customized settings that appear in a window, toolbar, or menu bar by taking a screen shot of your settings. The screen shot can be a time-saver if you have to reset your preferences.

To create a screen shot:

- a. Display the screen you want to save.
- b. Copy the screen image:
  - To copy only the active window, press **alt+fn+prt sc**.
  - To copy the entire screen, press **fn+prt sc**.
- c. Open a word-processing document, and then select **Edit > Paste**.
  - The screen image is added to the document.
- d. Save the document.

- When backing up to discs, use any of the following types of discs (purchased separately): CD-R, CD-RW, DVD+R, DVD+R DL, DVD-R, DVD-R DL, or DVD±RW. The discs you use will depend on the type of optical drive installed in your computer.

 DVDs and DVDs with double-layer (DL) support store more information than CDs, so using them for backup reduces the number of recovery discs required.

- When backing up to discs, number each disc before inserting it into the optical drive of the computer.

To create a backup using Backup and Restore Center, follow these steps:

---

 Be sure that the computer is connected to AC power before you start the backup process.

The backup process may take over an hour, depending on file size and the speed of the computer.

- 
1. Select **Start > All Programs > Maintenance > Backup and Restore Center**.
  2. Follow the on-screen instructions to back up your entire computer (select models only) or your files.

---

 Windows includes the User Account Control feature to improve the security of your computer. You may be prompted for your permission or password for tasks such as installing software, running utilities, or changing Windows settings. Refer to Help and Support for more information.

---

## Performing a recovery

In case of system failure or instability, the computer provides the following tools to recover your files:

- Windows recovery tools: You can use the Backup and Restore Center to recover information you have previously backed up. You can also use Windows Startup Repair to fix problems that might prevent Windows from starting correctly.
- **f11** recovery tools: You can use the **f11** recovery tools to recover your original hard drive image. The image includes the Windows operating system and software programs installed at the factory.

---

 If you are unable to boot (start up) your computer, you must purchase a Windows Vista operating system DVD to reboot the computer and repair the operating system. For additional information, refer to the “Using a Windows Vista operating system DVD (purchased separately)” section in this chapter.

---

## Using the Windows recovery tools

To recover information you previously backed up, follow these steps:

1. Select **Start > All Programs > Maintenance > Backup and Restore Center**.
2. Follow the on-screen instructions to recover your entire computer (select models only) or your files.

---

 Windows includes the User Account Control feature to improve the security of your computer. You may be prompted for your permission or password for tasks such as installing software, running utilities, or changing Windows settings. Refer to Help and Support for more information.

---



To recover your information using Startup Repair, follow these steps:



**CAUTION:** Using Startup Repair completely erases hard drive contents and reformats the hard drive. All files you have created and any software installed on the computer are permanently removed. When reformatting is complete, the recovery process restores the operating system, as well as the drivers, software, and utilities from the backup used for recovery.

1. If possible, back up all personal files.
2. If possible, check for the presence of the Windows partition and the HP Recovery partition. To find the partitions, select **Start > Computer**.

 If the Windows partition and the HP Recovery partition have been deleted, you must recover your operating system and programs using the Windows Vista operating system DVD and the *Driver Recovery* disc (both purchased separately). For additional information, refer to the “Using a Windows Vista operating system DVD (purchased separately)” section in this chapter.

3. Restart the computer, and then press **f8** before the Windows operating system loads.
4. Select **Repair your computer**.
5. Follow the on-screen instructions.



For additional information on recovering information using the Windows tools, perform a search for these topics in Help and Support.

## Using f11 recovery tools



**CAUTION:** Using **f11** completely erases hard drive contents and reformats the hard drive. All files you have created and any software installed on the computer are permanently removed. The **f11** recovery tool reinstalls the operating system and HP programs and drivers that were installed at the factory. Software not installed at the factory must be reinstalled.



If your computer includes a solid-state drive (SSD), you may not have a recovery partition. Recovery discs have been included for computers that do not have a partition. Use these discs to recover your operating system and software. To check for the presence of a recovery partition select **Start > Computer**. If the partition is present, an HP Recovery drive is listed in the Hard Disk Drives section of the window.

To recover the original hard drive image using **f11**, follow these steps:

1. If possible, back up all personal files.
2. If possible, check for the presence of the HP Recovery partition. To find the partition, select **Start > Computer**.

 If the HP Recovery partition has been deleted, you must recover your operating system and programs using the Windows Vista operating system DVD and the *Driver Recovery* disc (both purchased separately). For additional information, refer to the “Using a Windows Vista operating system DVD (purchased separately)” section in this chapter.

3. Turn on or restart the computer, and then press **esc** while the “Press the ESC key for Startup Menu” message is displayed at the bottom of the screen.
4. Press **f11** while the “Press <F11> for recovery” message is displayed on the screen.
5. Follow the on-screen instructions.

## Using a Windows Vista operating system DVD (purchased separately)

If you are unable to boot (start up) your computer, you must purchase a Windows Vista operating system DVD to reboot the computer and repair the operating system. Make sure that your most recent backup (stored on discs or on an external drive) is easily accessible. To order a Windows Vista operating system DVD, go to <http://www.hp.com/support>, select your country or region, and follow the on-screen instructions. You can also order the DVD by calling technical support. For contact information, refer to the *Worldwide Telephone Numbers* booklet included with the computer.



**CAUTION:** Using a Windows Vista operating system DVD completely erases hard drive contents and reformats the hard drive. All files you have created and any software installed on the computer are permanently removed. When reformatting is complete, the recovery process helps you restore the operating system, as well as drivers, software, and utilities.

---

To initiate recovery using a Windows Vista operating system DVD, follow these steps:

---



This process takes several minutes.

---

1. If possible, back up all personal files.
2. Restart the computer, and then insert the Windows Vista operating system DVD into the optical drive before the Windows operating system loads.
3. When prompted, press any keyboard key.
4. Follow the on-screen instructions.
5. Click **Next**.
6. Select **Repair your computer**.
7. Follow the on-screen instructions.

# Backup and recovery in Windows XP

## Overview

To protect your information, use the Windows Backup utility (select models only) to back up files and folders or create recovery points. In case of system failure, you can use the backup files to restore your computer.

Windows provides the following options:

- Backing up individual files and folders
- Backing up all files and folders
- Scheduling automatic backups
- Creating recovery points
- Recovering information



For detailed instructions, perform a search for these topics in Help and Support.

In case of system instability, HP recommends that you print the recovery procedures and save them for later use.

## Backing up your information

Recovery after a system failure is as complete as your most current backup. You should create your initial backup immediately after software setup. As you add new software and data files, you should continue to back up your system on a regular basis to maintain a reasonably current backup.

You can back up individual files or folders to an optional external hard drive or to a network drive.

Note the following when backing up:

- Store personal files in the My Documents folder, and back it up periodically.
- Back up templates stored in their associated programs.
- Save customized settings that appear in a window, toolbar, or menu bar by taking a screen shot of your settings. The screen shot can be a time saver if you have to reset your preferences.

To copy the screen and paste it into a word-processing document:

- a. Display the screen you want to save.
- b. Copy the screen image:
  - To copy only the active window, press **alt+fn+prt sc**.
  - To copy the entire screen, press **fn+prt sc**.
- c. Open a word-processing document, and then select **Edit > Paste**.  
The screen image is added to the document.
- d. Save the document.

To create a backup using the Windows Backup utility (select models only), follow these steps:



Be sure that the computer is connected to AC power before you start the backup process.

The backup process may take over an hour, depending on file size and the speed of the computer.

1. Select **Start > All Programs > Accessories > System Tools > Backup**.
2. Follow the on-screen instructions.

## Performing a recovery

In case of system failure or instability, the computer provides the following tools to recover your files:

- Windows recovery tools (select models only): You can use the Windows Backup utility to recover information you have previously backed up.
- *Operating System* and *Driver Recovery* discs (included with your computer): You can use the discs to recover your operating system and programs installed at the factory.

## Recovering your information

To recover information you previously backed up, follow these steps:

1. If possible, back up all personal files.
2. Select **Start > All Programs > Accessories > System Tools > Backup**.  
The Backup or Restore Wizard opens.
3. Click **Restore files and settings**, and then click **Next**.
4. Follow the on-screen instructions.



For additional information on initiating a recovery in Windows, perform a search for this topic in Help and Support.

---

## Recovering the operating system and programs



**CAUTION:** The recovery process reformats and completely erases the hard drive. All files you have created and any software installed on the computer are permanently removed. The recovery process reinstalls the original operating system, software, and drivers. Software, drivers, and updates not installed by HP must be manually reinstalled.

---

To recover your operating system and programs, follow these steps:

1. If possible, back up all personal files.
2. Insert the *Operating System* disc into the optical drive.
3. Shut down the computer.
4. Turn on the computer.
5. Follow the on-screen instructions to install the operating system.
6. After the operating system is installed, remove the *Operating System* disc and insert the *Driver Recovery* disc.
7. Follow the on-screen instructions to install the drivers and programs.

## Connector pin assignments

### Audio-in (microphone)

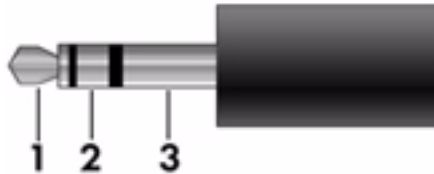

Pin	Signal
1	Audio signal in
2	Audio signal in
3	Ground

### Audio-out (headphone)

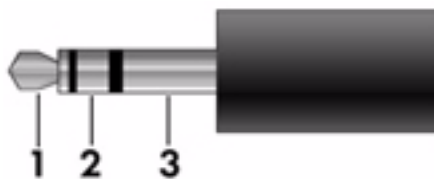

Pin	Signal
1	Audio out, left channel
2	Audio out, right channel
3	Ground

## External monitor

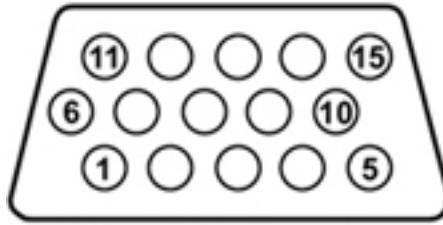

Pin	Signal
1	Red analog
2	Green analog
3	Blue analog
4	Not connected
5	Ground
6	Ground analog
7	Ground analog
8	Ground analog
9	+5 VDC
10	Ground
11	Monitor detect
12	DDC 2B data
13	Horizontal sync
14	Vertical sync
15	DDC 2B clock

## RJ-45 (network)

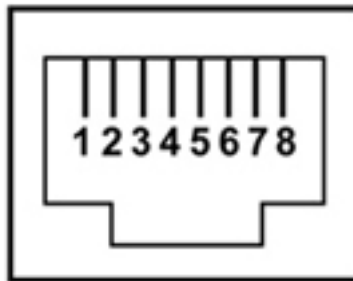

Pin	Signal
1	Transmit +
2	Transmit -
3	Receive +
4	Unused
5	Unused
6	Receive -
7	Unused
8	Unused

## Universal Serial Bus

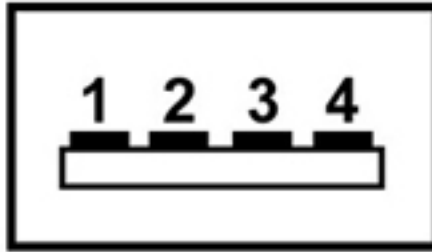

Pin	Signal
1	+5 VDC
2	Data
3	Data +
4	Ground



---

## Power cord set requirements

The wide-range input feature of the computer permits it to operate from any line voltage from 100 to 120 volts AC, or from 220 to 240 volts AC.

The 3-conductor power cord set included with the computer meets the requirements for use in the country or region where the equipment is purchased.

Power cord sets for use in other countries and regions must meet the requirements of the country or region where the computer is used.

### Requirements for all countries and regions

The following requirements are applicable to all countries and regions:

- The length of the power cord set must be at least 1.5 m (5.0 ft) and no more than 2.0 m (6.5 ft).
- All power cord sets must be approved by an acceptable accredited agency responsible for evaluation in the country or region where the power cord set will be used.
- The power cord sets must have a minimum current capacity of 10 amps and a nominal voltage rating of 125 or 250 V AC, as required by the power system of each country or region.
- The appliance coupler must meet the mechanical configuration of an EN 60 320/IEC 320 Standard Sheet C13 connector for mating with the appliance inlet on the back of the computer.

## Requirements for specific countries and regions

Country/region	Accredited agency	Applicable note number
Australia	EANSW	1
Austria	OVE	1
Belgium	CEBC	1
Canada	CSA	2
Denmark	DEMKO	1
Finland	FIMKO	1
France	UTE	1
Germany	VDE	1
Italy	IMQ	1
Japan	METI	3
The Netherlands	KEMA	1
Norway	NEMKO	1
The People's Republic of China	CCC	5
South Korea	EK	4
Sweden	SEMKO	1
Switzerland	SEV	1
Taiwan	BSMI	4
The United Kingdom	BSI	1
The United States	UL	2

1. The flexible cord must be Type HO5VV-F, 3-conductor, **1.0-mm<sup>2</sup>** conductor size. Power cord set fittings (appliance coupler and wall plug) must bear the certification mark of the agency responsible for evaluation in the country or region where it will be used.
2. The flexible cord must be Type SPT-3 or equivalent, No. 18 AWG, 3-conductor. The wall plug must be a two-pole grounding type with a NEMA 5-15P (15 A, 125 V) or NEMA 6-15P (15 A, 250 V) configuration.
3. The appliance coupler, flexible cord, and wall plug must bear a "T" mark and registration number in accordance with the Japanese Dentori Law. The flexible cord must be Type VCT or VCTF, 3-conductor, **1.00-mm<sup>2</sup>** conductor size. The wall plug must be a two-pole grounding type with a Japanese Industrial Standard C8303 (7 A, 125 V) configuration.
4. The flexible cord must be Type RVV, 3-conductor, **0.75-mm<sup>2</sup>** conductor size. Power cord set fittings (appliance coupler and wall plug) must bear the certification mark of the agency responsible for evaluation in the country or region where it will be used.
5. The flexible cord must be Type VCTF, 3-conductor, **0.75-mm<sup>2</sup>** conductor size. Power cord set fittings (appliance coupler and wall plug) must bear the certification mark of the agency responsible for evaluation in the country or region where it will be used.

## Battery

When a battery has reached the end of its useful life, do not dispose of the battery in general household waste. Follow the local laws and regulations in your area for computer battery disposal.

## Display

 **WARNING:** The backlight contains mercury. Caution must be exercised when removing and handling the backlight to avoid damaging this component and causing exposure to the mercury.

 **CAUTION:** The procedures in this chapter can result in damage to display components. The only components intended for recycling purposes are the liquid crystal display (LCD) panel and the backlight. When you remove these components, handle them carefully.

 **Materials Disposal.** This HP product contains mercury in the backlight in the display assembly that might require special handling at end-of-life. Disposal of mercury may be regulated because of environmental considerations. For disposal or recycling information, contact your local authorities, or see the Electronic Industries Alliance (EIA) Web site at <http://www.eiae.org>.

This section provides disassembly instructions for the display assembly. The display assembly must be disassembled to gain access to the backlight ❶ and the liquid crystal display (LCD) panel ❷.



 The procedures provided in this chapter are general disassembly instructions. Specific details, such as screw sizes, quantities, and locations, and component shapes and sizes, can vary from one computer model to another.

Perform the following steps to disassemble the display assembly:

1. Remove all screw covers ❶ and screws ❷ that secure the display bezel to the display assembly.

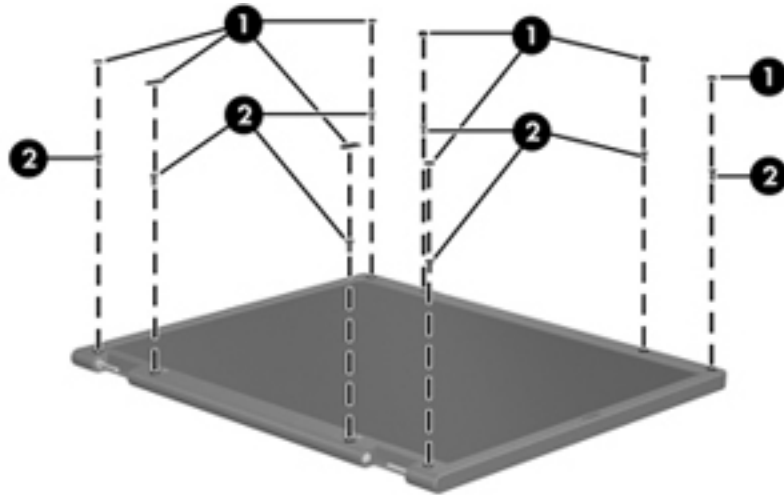

2. Lift up and out on the left and right inside edges ❶ and the top and bottom inside edges ❷ of the display bezel until the bezel disengages from the display assembly.
3. Remove the display bezel ❸.

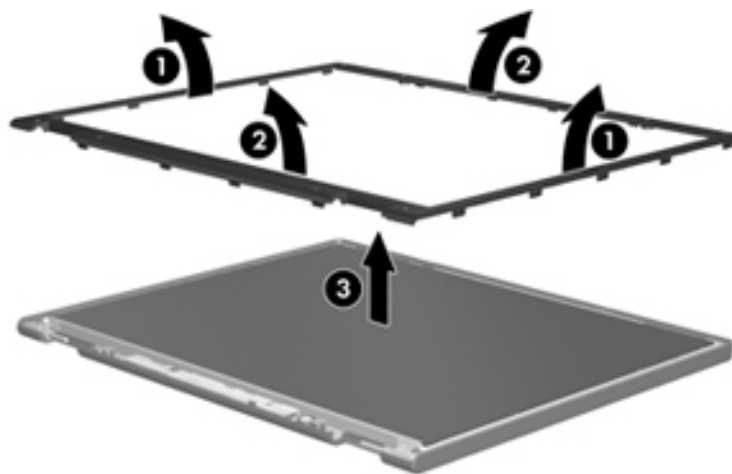

4. Disconnect all display panel cables ❶ from the display inverter and remove the inverter ❷.

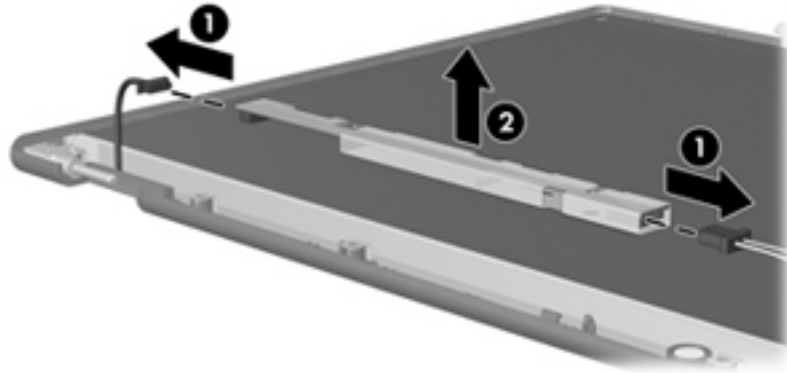

5. Remove all screws ❶ that secure the display panel assembly to the display enclosure.

6. Remove the display panel assembly ❷ from the display enclosure.

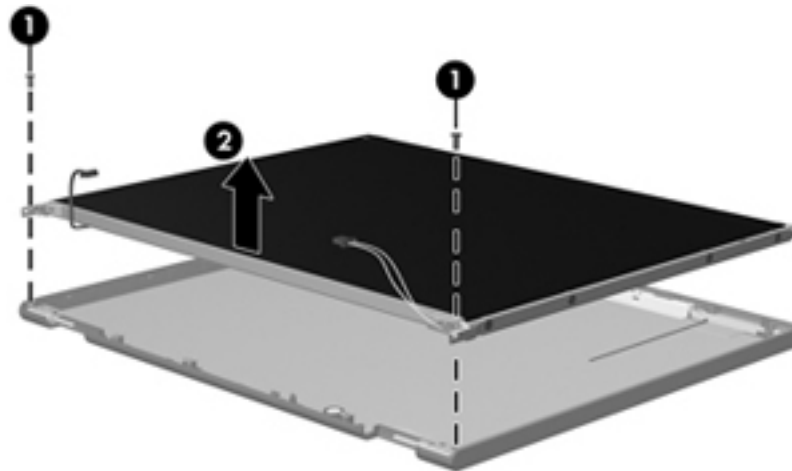

7. Turn the display panel assembly upside down.

8. Remove all screws that secure the display panel frame to the display panel.

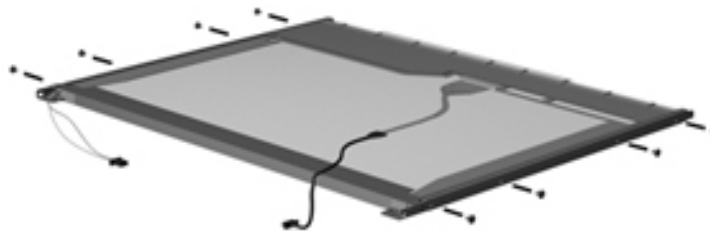

9. Use a sharp-edged tool to cut the tape ❶ that secures the sides of the display panel to the display panel frame.
10. Remove the display panel frame ❷ from the display panel.

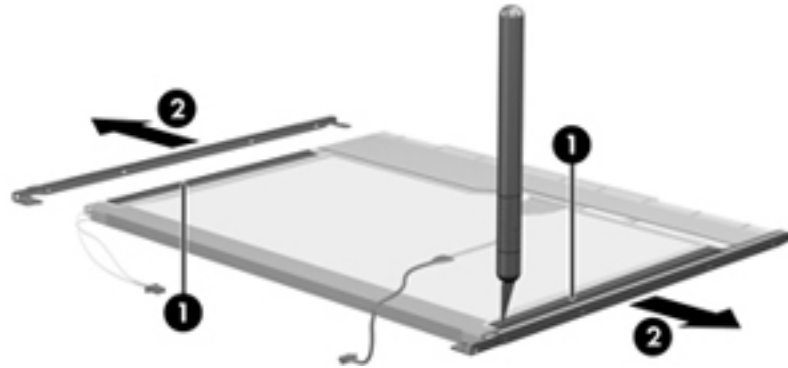

11. Remove the screws ❶ that secure the backlight cover to the display panel.
12. Lift the top edge of the backlight cover ❷ and swing it outward.

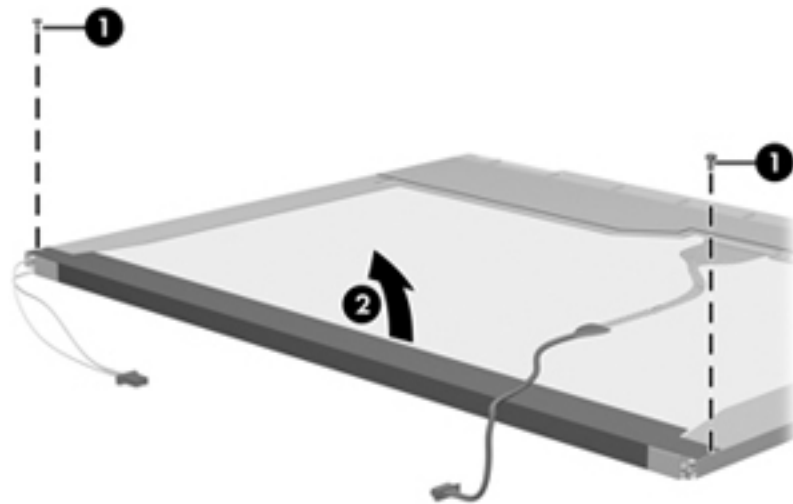

13. Remove the backlight cover.
14. Turn the display panel right-side up.
15. Remove the backlight cables ❶ from the clip ❷ in the display panel.

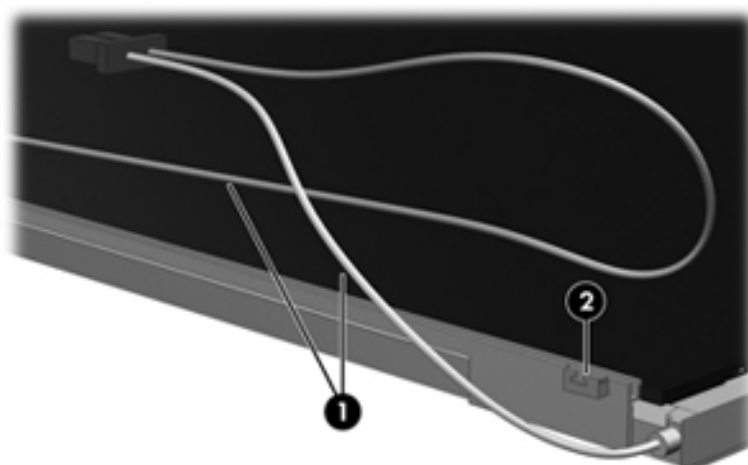

16. Turn the display panel upside down.
17. Remove the backlight frame from the display panel.



**WARNING:** The backlight contains mercury. Exercise caution when removing and handling the backlight to avoid damaging this component and causing exposure to the mercury.

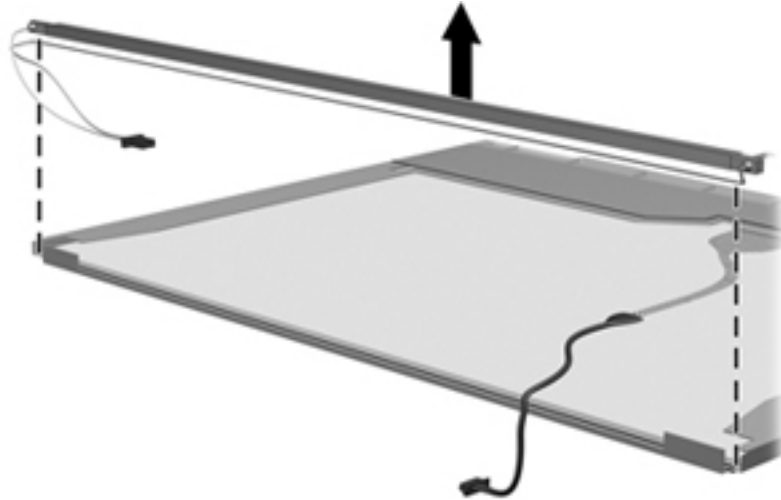

18. Remove the backlight from the backlight frame.

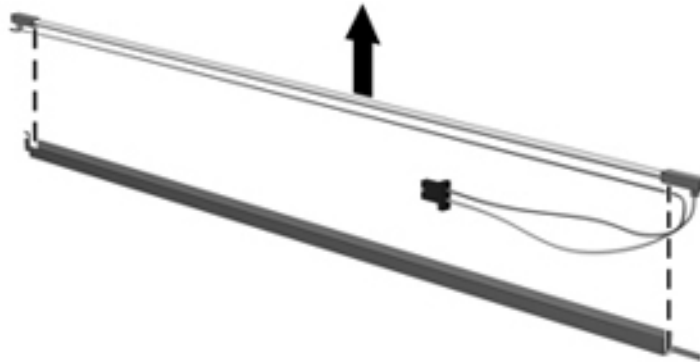

19. Disconnect the display cable ❶ from the LCD panel.
20. Remove the screws ❷ that secure the LCD panel to the display rear panel.
21. Release the LCD panel ❸ from the display rear panel.
22. Release the tape ❹ that secures the LCD panel to the display rear panel.

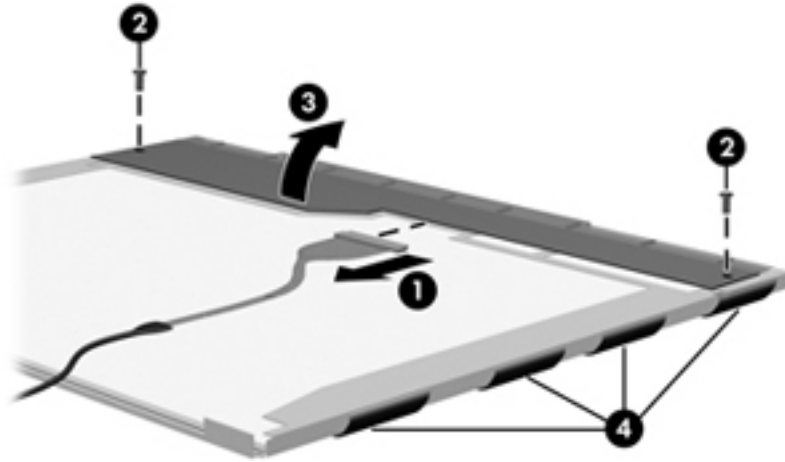

23. Remove the LCD panel.

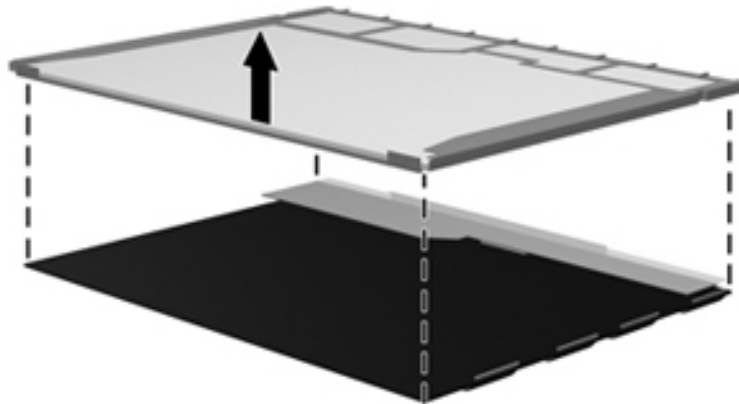

24. Recycle the LCD panel and backlight.



## A

AC adapter, spare part number 3-10, 3-12

accessory cover  
illustrated 3-9  
removal 4-9

antennas

disconnecting 4-15, 4-17

illustrated 3-7

locations 2-3

removal 4-48, 4-49

spare part number 4-48, 4-49

audio, product description 1-1

audio-in jack

connector pinout 8-1

location 2-8

audio-out jack

connector pinout 8-1

location 2-8

## B

backing up files 8-5

Backup and Restore Center 8-5, 8-6

base enclosure, spare part number 3-4, 3-12

battery

removal 4-7

spare part number 3-4, 3-11, 3-12, 4-7

battery bay 2-10

battery eject arm

removal 4-41

spare part number 4-41

battery light 2-9

battery release latch 2-10

BIOS administrator password 5-15

Bluetooth module

removal 4-12

spare part number 3-4, 3-11, 4-12

Bluetooth module cable

illustrated 3-6

removal 4-32

boot options 5-5, 5-10, 5-17

boot order 5-5, 5-10, 5-17

bottom components 2-10

built-in device options 5-6, 5-11, 5-12, 5-18

button board

removal 4-26

spare part number 3-4, 3-12, 4-26

buttons

power 2-4

QuickLook 2-4

QuickWeb 2-4

TouchPad 2-7

wireless 2-4

## C

Cable Kit

components 3-6

spare part number 3-4, 3-6, 3-12

cables, service considerations 4-1

caps lock light 2-6

chipset, product description 1-1

combo headphone microphone jack, location 2-8

components

bottom 2-10

buttons 2-4

display 2-2, 2-3

fingerprint reader 2-4

front 2-8

keys 2-5

left-side 2-9

lights 2-6

pointing device 2-7

right-side 2-8

computer feet

locations 4-6

spare part number 4-6

Computer Setup

Diagnostics menu 5-4, 5-10, 5-16

File menu 5-3, 5-8, 5-14

Security menu 5-3, 5-9, 5-15

System Configuration menu 5-5, 5-10, 5-17

computer specifications 6-1

connector pinout

audio-in jack 8-1

audio-out jack 8-1

external monitor port 8-2

headphone jack 8-1

microphone jack 8-1

monitor port 8-2

network jack 8-3

RJ-45 jack 8-3

- USB port 8–4
- connectors, service considerations 4–1
- creating a backup 8–5

**D**

- device configurations 5–5, 5–6, 5–10, 5–11, 5–17, 5–18
- Diagnostics menu 5–4, 5–10, 5–16
- Disk Sanitizer 5–15
- display assembly
  - removal 4–43
  - spare part numbers 3–3, 3–13, 4–43
- display bezel
  - illustrated 3–7, 3–13
  - removal 4–44
  - spare part number 3–7, 3–13, 4–45
- Display Cable Kit
  - illustrated 3–7
  - spare part number 3–7, 3–13
- display components
  - illustrated 2–2, 2–3
  - recycling 10–1
  - spare part numbers 3–7
- display enclosure
  - illustrated 3–7, 3–13
  - spare part number 3–7, 3–13
- display hinge
  - illustrated 3–7, 3–11
  - removal 4–46
  - spare part number 3–7, 3–11, 4–46
- display inverter, removal 10–3
- display panel cable
  - illustrated 3–7
  - removal 4–47
  - spare part numbers 4–47
- display panel, product description 1–1
- display switch, location 2–2
- DisplayPort, location 2–9
- drive light 2–8
- DriveLock password 5–15
- DriveLock, automatic 5–15
- drives, boot order 5–5, 5–10, 5–17

**E**

- electrostatic discharge 4–2
- equipment guidelines 4–4
- esc** key 2–5
- Ethernet, product description 1–2
- external media card, product description 1–2
- external monitor port
  - connector pinout 8–2
  - location 2–9

**F**

- f11 recovery 8–7
- fan
  - removal 4–36
  - spare part number 3–4, 3–13, 4–36
- feet
  - locations 4–6
  - spare part number 4–6
- File menu 5–3, 5–8, 5–14
- fn** key 2–5
- front components 2–8
- function keys 2–5

**G**

- graphics, product description 1–1
- grounding equipment and methods 4–2

**H**

- hard drive
  - precautions 4–2
  - product description 1–1
  - removal 4–9
  - spare part numbers 3–5, 3–8, 3–11, 4–9
  - specifications 6–3
- hard drive bay 2–10
- hard drive recovery 8–7
- headphone jack
  - connector pinout 8–1
  - location 2–8
- heat sink
  - removal 4–36
  - spare part number 4–36
- hinge
  - illustrated 3–7, 3–11
  - removal 4–46
  - spare part number 3–7, 3–11, 4–46
- HP SpareKey Enrollment 5–15

**J**

- jacks
  - audio-in 2–8
  - audio-out 2–8
  - combo headphone microphone 2–8
  - headphone 2–8
  - microphone 2–8
  - network 2–9
  - RJ-45 2–9

**K**

- key components 2–5
- keyboard
  - product description 1–2
  - removal 4–23
  - spare part numbers 3–3, 3–13, 3–14, 4–23

- keys
  - esc** 2–5
  - fn** 2–5
  - function 2–5
  - numeric keypad 2–5
  - Windows applications 2–5
  - Windows logo 2–5
- L**
- language, changing in Computer Setup 5–5, 5–10, 5–17
- Latch Kit, spare part number 3–4, 3–11
- left-side components 2–9
- light components 2–6
- lights
  - battery 2–9
  - caps lock 2–6
  - drive 2–8
  - power 2–6
  - QuickLook 2–6
  - QuickWeb 2–6
  - wireless 2–6
- M**
- mass storage device
  - removal 4–9
  - spare part numbers 3–5, 3–8, 4–9
- memory module
  - removal 4–21
  - spare part numbers 3–5, 3–11, 3–12, 4–21
- memory, product description 1–1
- microphone
  - illustrated 3–7
  - locations 2–2
  - product description 1–1
  - removal 4–49
  - spare part number 4–49
- microphone jack
  - connector pinout 8–1
  - location 2–8
- model name 4–5
- monitor port
  - connector pinout 8–2
  - location 2–9
- N**
- network jack
  - connector pinout 8–3
  - location 2–9
- numeric keypad keys 2–5
- O**
- operating system, product description 1–3
- P**
- packing guidelines 4–3
- passwords 5–15
- plastic parts 4–1
- Plastics Kit
  - components 3–9
  - contents 3–9
  - spare part number 3–4, 3–9, 3–13
- pointing device
  - components 2–7
  - illustrated 2–7
  - product description 1–2
- port options 5–12
- ports
  - DisplayPort 2–9
  - external monitor port 2–9
  - monitor port 2–9
  - powered USB 2–9
  - product description 1–2
  - USB 2–8, 2–9
- power button 2–4
- power button board
  - removal 4–31
  - spare part number 3–4, 3–12, 4–31
- power button board cable, illustrated 3–6
- power connector 2–9
- power cord
  - set requirements 9–1
  - spare part numbers 3–10, 3–11
- power light 2–6
- power requirements, product description 1–2
- powered USB port
  - location 2–9
- processor, product description 1–1
- product description
  - audio 1–1
  - chipset 1–1
  - display panel 1–1
  - Ethernet 1–2
  - external media card 1–2
  - graphics 1–1
  - hard drive 1–1
  - keyboard 1–2
  - memory 1–1
  - microphone 1–1
  - operating system 1–3
  - pointing device 1–2
  - ports 1–2
  - power requirements 1–2
  - processor 1–1
  - security 1–2
  - serviceability 1–4
  - webcam 1–1
  - wireless 1–2

product name 1-1, 3-1, 4-5

## Q

QuickLook button 2-4

QuickLook light 2-6

QuickWeb button 2-4

QuickWeb light 2-6

## R

recovering information 8-6

recovery partition 8-7

recovery, system 8-1

recycling

    battery 10-1

    display components 10-1

removal/replacement

    preliminaries 4-1

    procedures 4-5

restoring factory settings 5-3, 5-14

restoring security defaults 5-6, 5-12, 5-18

restoring the hard drive 8-5

right-side components 2-8

RJ-45 jack

    connector pinout 8-3

    location 2-9

RTC battery

    removal 4-20

    spare part number 3-5, 3-11, 4-20

Rubber Feet Kit, spare part number 3-4, 3-11, 4-6

## S

Screw Kit, spare part number 3-10, 3-13

SD Card Reader 2-8

SD Card Reader slot bezel, illustrated 3-9

security cable slot 2-8

Security menu 5-3, 5-9, 5-15

    allow reset of HP ProtectTools security keys 5-15

    always prompt for HP SpareKey enrollment 5-15

    Automatic DriveLock 5-15

    change password 5-15

    Disk Sanitizer 5-15

    DriveLock 5-15

    HP SpareKey 5-15

    HP SpareKey enrollment 5-15

    password policy 5-15

    set up BIOS administrator password 5-15

    System IDs 5-15

    user management 5-15

security, product description 1-2

service considerations 4-1

serviceability, product description 1-4

set security level 5-6, 5-12, 5-18

SIM slot 2-10

SIM, removal 4-8

solid-state drive

    removal 4-9

    spare part numbers 3-5, 3-8, 3-11, 4-9

speaker assembly

    removal 4-39

    spare part number 3-4, 3-13, 4-39

speakers 2-8

specifications

    computer 6-1

    display assembly 6-2

    hard drive 6-3

system board

    removal 4-33

    spare part numbers 3-4, 3-12, 4-33

System Configuration menu 5-5, 5-10, 5-17

system IDs 5-15

system recovery 8-1

## T

tools required 4-1

top cover

    removal 4-28

    spare part number 3-4, 3-13, 4-28

TouchPad 2-7

TouchPad buttons 2-7

TouchPad scroll zone 2-7

## U

Universal Serial Bus (USB) port

    connector pinout 8-4

    location 2-8, 2-9

USB board

    removal 4-40

    spare part number 3-4, 3-12, 4-40

USB board cable, illustrated 3-6

## V

vents 2-8, 2-9, 2-10

## W

warranty period 4-5

webcam

    location 2-2

    product description 1-1

webcam cable, illustrated 3-7

webcam module

    illustrated 3-7

    removal 4-45

    spare part number 3-7, 3-13, 4-45

Windows applications key 2-5

Windows logo key 2-5

Windows Vista operating system DVD 8-6

wireless antennas

    disconnecting 4-15, 4-17

---

- illustrated 3–7
- locations 2–3
- removal 4–48, 4–49
  - spare part number 4–48, 4–49
- wireless button 2–4
- wireless light 2–6
- wireless, product description 1–2
- WLAN module
  - removal 4–14
    - spare part numbers 3–5, 3–11, 3–12, 4–14
- workstation guidelines 4–4
- WWAN module
  - removal 4–17
    - spare part number 3–5, 3–11, 4–17