

# HP ProBook Notebook PC

## User Guide

© Copyright 2010 Hewlett-Packard  
Development Company, L.P.

Bluetooth is a trademark owned by its proprietor and used by Hewlett-Packard Company under license. Intel is a trademark of Intel Corporation in the U.S. and other countries or regions. Java is a U.S. trademark of Sun Microsystems, Inc. Microsoft, Windows, and Windows Vista are U.S. registered trademarks of Microsoft Corporation. SD Logo is a trademark of its proprietor.

The information contained herein is subject to change without notice. The only warranties for HP products and services are set forth in the express warranty statements accompanying such products and services. Nothing herein should be construed as constituting an additional warranty. HP shall not be liable for technical or editorial errors or omissions contained herein.

First Edition: March 2010

Document Part Number: 598087-002

### **Product notice**

This user guide describes features that are common to most models. Some features may not be available on your computer.

Due to the fast-moving product development cycle, some hardware and software content in the user guides found on the hard drive or CD may have been updated over time. Go to <http://www.hp.com/support>, select your country or region, and then follow the on-screen instructions to navigate to your product for up-to-date user guides.

## Safety warning notice

- 
- ⚠ **WARNING!** To reduce the possibility of heat-related injuries or of overheating the computer, do not place the computer directly on your lap or obstruct the computer air vents. Use the computer only on a hard, flat surface. Do not allow another hard surface, such as an adjoining optional printer, or a soft surface, such as pillows or rugs or clothing, to block airflow. Also, do not allow the AC adapter to contact the skin or a soft surface, such as pillows or rugs or clothing, during operation. The computer and the AC adapter comply with the user-accessible surface temperature limits defined by the International Standard for Safety of Information Technology Equipment (IEC 60950).
-



---

# Table of contents

<b>1 Features</b>	<b>1</b>
Identifying hardware	1
Top components	1
TouchPad	1
Lights	3
Buttons, speakers, switches, and fingerprint reader (select models only)	4
Keys	6
Front components	7
Right-side components	8
Left-side components	9
Bottom components	11
Display	11
Wireless antennas (select models only)	12
Additional hardware components	14
Identifying the labels	14
<b>2 Wireless, modem, and local area network</b>	<b>16</b>
Using wireless devices (select models only)	16
Identifying wireless and network icons	17
Using the wireless controls	17
Using the wireless button	17
Using Wireless Assistant software (select models only)	18
Using HP Connection Manager (select models only)	18
Using operating system controls	18
Using a WLAN	19
Setting up a WLAN	19
Protecting your WLAN	19
Connecting to a WLAN	21
Roaming to another network	21
Using HP Mobile Broadband (select models only)	22
Inserting a SIM	22
Removing a SIM	23
Using Bluetooth wireless devices (select models only)	25
Bluetooth and Internet Connection Sharing (ICS)	25

Troubleshooting wireless connection problems .....	26
Cannot create a WLAN connection .....	26
Cannot connect to a preferred network .....	27
Network status icon is not displayed .....	27
Current network security codes are unavailable .....	27
WLAN connection is very weak .....	28
Cannot connect to the wireless router .....	28
Using the modem (select models only) .....	29
Connecting a modem cable .....	29
Connecting a country-specific modem cable adapter .....	30
Selecting a location setting .....	30
Viewing the current location selection .....	30
Adding new locations when traveling .....	31
Solving travel connection problems .....	32
Connecting to a local area network (LAN) .....	33
<b>3 Pointing devices and keyboard .....</b>	<b>34</b>
Using pointing devices .....	34
Setting pointing device preferences .....	34
Using the TouchPad .....	34
Turning the TouchPad on and off .....	34
Navigating .....	34
Selecting .....	35
Using TouchPad gestures .....	36
Scrolling .....	36
Pinching/Zooming .....	36
Rotating .....	37
Three-finger flick .....	37
Connecting an external mouse .....	38
Using the keyboard .....	38
Using hotkeys .....	38
Displaying system information .....	40
Initiating Sleep .....	40
Decreasing screen brightness .....	40
Increasing screen brightness .....	40
Switching the screen image .....	40
Opening the default e-mail application .....	41
Opening the default Web browser .....	41
Muting speaker sound .....	41
Decreasing speaker sound .....	41
Increasing speaker sound .....	41
Playing the previous track or section of an audio CD or a DVD .....	41
Playing, pausing, or resuming an audio CD or a DVD .....	41

Playing the next track or section of an audio CD or a DVD .....	41
Using QuickLook .....	41
Using QuickWeb .....	43
Using the embedded numeric keypad .....	44
Enabling and disabling the embedded numeric keypad .....	44
Switching key functions on the embedded numeric keypad .....	44
Using an optional external numeric keypad .....	45
Cleaning the TouchPad and keyboard .....	46
<b>4 Multimedia .....</b>	<b>47</b>
Multimedia features .....	47
Identifying your multimedia components .....	47
Adjusting the volume .....	48
Multimedia software .....	49
Opening preinstalled multimedia software .....	50
Using multimedia software .....	50
Installing multimedia software from a disc .....	51
Audio .....	52
Connecting external audio devices .....	52
Checking your audio functions .....	52
Video .....	54
Connecting an external monitor or projector .....	54
Using the external monitor port .....	54
Using the HDMI port .....	54
Configuring audio for HDMI .....	55
Optical drive (select models only) .....	56
Identifying the installed optical drive .....	56
Using optical discs (CDs, DVDs, and BDs) .....	56
Selecting the right disc (CDs, DVDs, and BDs) .....	56
CD-R discs .....	57
CD-RW discs .....	57
DVD±R discs .....	57
DVD±RW discs .....	57
LightScribe DVD+R discs .....	57
Blu-ray Discs (BDs) .....	57
Playing a CD, DVD, or BD .....	58
Configuring AutoPlay .....	58
Changing DVD region settings .....	59
Observing the copyright warning .....	59
Copying a CD or DVD .....	59
Creating (burning) a CD, DVD, or BD .....	60
Removing an optical disc (CD, DVD, or BD) .....	60
Troubleshooting .....	61

The optical disc tray does not open for removal of a CD, DVD, or BD .....	61
The computer does not detect the optical drive .....	62
Preventing playback disruptions .....	63
A disc does not play .....	63
A disc does not play automatically .....	64
A movie stops, skips, or plays erratically .....	64
A movie is not visible on an external display .....	64
The process of burning a disc does not begin, or it stops before completion .....	64
A device driver must be reinstalled .....	65
Obtaining the latest HP device drivers .....	65
Obtaining Microsoft device drivers .....	66
Webcam .....	67
Webcam tips .....	67
Adjusting webcam properties .....	67
<b>5 Power management .....</b>	<b>69</b>
Setting power options .....	69
Using power-saving states .....	69
Initiating and exiting Sleep .....	69
Initiating and exiting Hibernation .....	70
Using the battery meter .....	70
Using power plans .....	70
Viewing the current power plan .....	71
Selecting a different power plan .....	71
Customizing power plans .....	71
Setting password protection on wakeup .....	71
Using external AC power .....	72
Connecting the AC adapter .....	72
Using battery power .....	73
Finding battery information in Help and Support .....	73
Using Battery Check .....	74
Displaying the remaining battery charge .....	74
Inserting or removing the battery .....	74
Charging a battery .....	75
Maximizing battery discharge time .....	76
Managing low battery levels .....	76
Identifying low battery levels .....	76
Resolving a low battery level .....	78
Resolving a low battery level when external power is available .....	78
Resolving a low battery level when a charged battery is available .....	78
Resolving a low battery level when no power source is available .....	78



Resolving a low battery level when the computer cannot exit Hibernation .....	78
Calibrating a battery .....	78
Step 1: Fully charge the battery .....	78
Step 2: Disable Hibernation and Sleep .....	79
Step 3: Discharge the battery .....	79
Step 4: Fully recharge the battery .....	81
Step 5: Reenable Hibernation and Sleep .....	81
Conserving battery power .....	81
Storing a battery .....	81
Disposing of a used battery .....	82
Replacing the battery .....	82
Testing an AC adapter .....	83
Shutting down the computer .....	83
<b>6 Drives .....</b>	<b>85</b>
Identifying installed drives .....	85
Handling drives .....	85
Improving hard drive performance .....	87
Using Disk Defragmenter .....	87
Using Disk Cleanup .....	87
Using HP 3D DriveGuard .....	88
Identifying HP 3D DriveGuard status .....	88
Using HP 3D DriveGuard software .....	89
Using external drives .....	90
Using optional external devices .....	90
Replacing the hard drive .....	91
<b>7 External devices .....</b>	<b>105</b>
Using a USB device .....	105
Connecting a USB device .....	105
Stopping and removing a USB device .....	105
Using USB legacy support .....	106
Using an eSATA device .....	107
Connecting an eSATA device .....	107
Stopping and removing an eSATA device .....	107
Using external drives .....	109
Using optional external devices .....	109
<b>8 External media cards .....</b>	<b>110</b>
Using Media Card Reader cards .....	110
Inserting a digital card .....	110
Stopping and removing a digital card .....	111

Using ExpressCards (select models only) .....	112
Configuring an ExpressCard .....	112
Inserting an ExpressCard .....	112
Stopping and removing an ExpressCard .....	113
<b>9 Memory modules .....</b>	<b>115</b>
Adding or replacing memory modules .....	116
<b>10 Security .....</b>	<b>127</b>
Protecting the computer .....	127
Using passwords .....	128
Setting passwords in Windows .....	128
Setting passwords in Computer Setup .....	128
BIOS administrator password .....	129
Managing a BIOS administrator password .....	130
Entering a BIOS administrator password .....	131
Using Computer Setup DriveLock .....	131
Setting a DriveLock password .....	132
Entering a DriveLock password .....	133
Changing a DriveLock password .....	134
Removing DriveLock protection .....	135
Using Computer Setup Auto DriveLock .....	135
Entering an Automatic DriveLock password .....	135
Removing Automatic DriveLock protection .....	136
Using Computer Setup security features .....	137
Securing system devices .....	137
Viewing Computer Setup System Information .....	137
Using Computer Setup System IDs .....	138
Using antivirus software .....	139
Using firewall software .....	140
Installing critical updates .....	141
Using HP ProtectTools Security Manager (select models only) .....	142
Installing a security cable .....	143
<b>11 Software updates .....</b>	<b>144</b>
Updating software .....	144
Updating the BIOS .....	146
Determining the BIOS version .....	146
Downloading a BIOS update .....	147
Updating programs and drivers .....	149
Using SoftPaq Download Manager .....	150

<b>12 Backup and recovery</b> .....	<b>151</b>
Backing up your information .....	152
Performing a recovery .....	153
Using the Windows recovery tools .....	153
Using f11 .....	154
Using a Windows Vista operating system DVD (purchased separately) .....	154
<b>13 Computer Setup</b> .....	<b>155</b>
Starting Computer Setup .....	155
Using Computer Setup .....	155
Navigating and selecting in Computer Setup .....	155
Restoring factory settings in Computer Setup .....	156
Computer Setup menus .....	156
File menu .....	157
Security menu .....	157
System Configuration menu .....	158
<b>14 MultiBoot</b> .....	<b>163</b>
About the boot device order .....	163
Enabling boot devices in Computer Setup .....	165
Considering boot order changes .....	166
Choosing MultiBoot preferences .....	167
Setting a new boot order in Computer Setup .....	167
Dynamically choosing a boot device using the F9 prompt .....	167
Setting a MultiBoot Express prompt .....	168
Entering MultiBoot Express preferences .....	168
<b>15 Management and printing</b> .....	<b>169</b>
Using Client Management Solutions .....	169
Configuring and deploying a software image .....	169
Managing and updating software .....	170
HP Client Manager for Altiris (select models only) .....	170
HP Client Configuration Manager (CCM) (select models only) .....	172
HP System Software Manager (SSM) .....	173
<b>Index</b> .....	<b>174</b>



---

# 1 Features

## Identifying hardware

To see a list of hardware installed in the computer, follow these steps:

1. Select **Start > Computer > System properties**.
2. In the left pane, click **Device Manager**.

You can also add hardware or modify device configurations using Device Manager.

 **NOTE:** Windows® includes the User Account Control feature to improve the security of your computer. You may be prompted for your permission or password for tasks such as installing software, running utilities, or changing Windows settings. Refer to Windows Help and Support for more information.

## Top components

### TouchPad

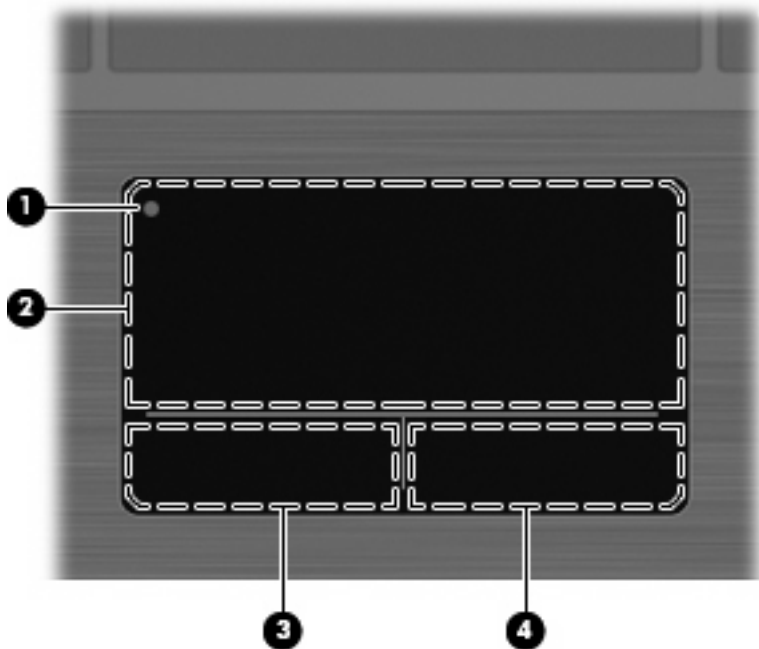

Component	Description
(1) TouchPad off indicator	To turn the TouchPad zone on and off, quickly double-tap the TouchPad off indicator.  <b>NOTE:</b> When the TouchPad zone is active, the light is off.
(2) TouchPad zone*	Moves the pointer and selects or activates items on the screen.
(3) Left TouchPad button*	Functions like the left button on an external mouse.
(4) Right TouchPad button*	Functions like the right button on an external mouse.

\*This table describes factory settings. To view or change pointing device preferences, select **Start > Control Panel > Hardware and Sound > Mouse**.

## Lights

 **NOTE:** Refer to the illustration that most closely matches your computer.

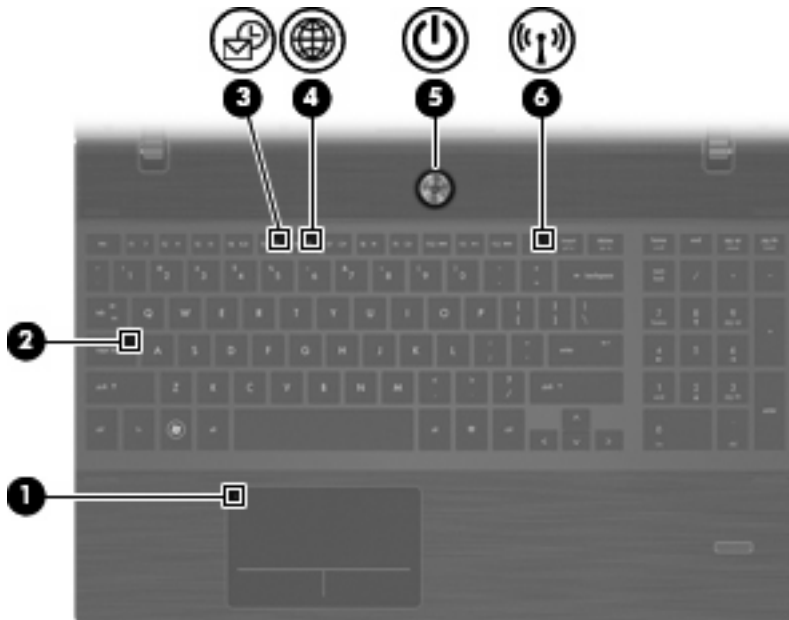
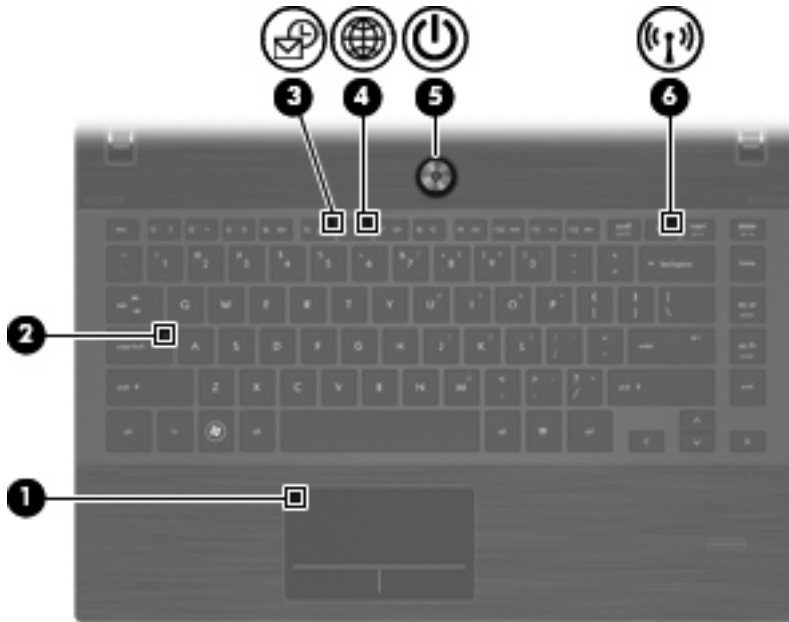

Component	Description
(1) TouchPad off indicator	<ul style="list-style-type: none"><li>• Amber: The TouchPad is off.</li><li>• Off: The TouchPad is on.</li></ul>
(2) Caps lock light	On: Caps lock is on.
(3) HP QuickLook light	Blinking: QuickLook is being opened or closed.
(4) HP QuickWeb light	Blinking: The Web browser is being opened or closed.

Component	Description
(5) Power light	<ul style="list-style-type: none"> <li>On: The computer is on.</li> <li>Blinking: The computer is in the Sleep state.</li> <li>Off: The computer is off or in Hibernation.</li> </ul>
(6) Wireless light	<ul style="list-style-type: none"> <li>White: An integrated wireless device, such as a wireless local area network (WLAN) device and/or a Bluetooth® device, is on.</li> <li>Amber: All wireless devices are off.</li> </ul>

## Buttons, speakers, switches, and fingerprint reader (select models only)

 **NOTE:** Your computer may look slightly different from the illustration in this section.

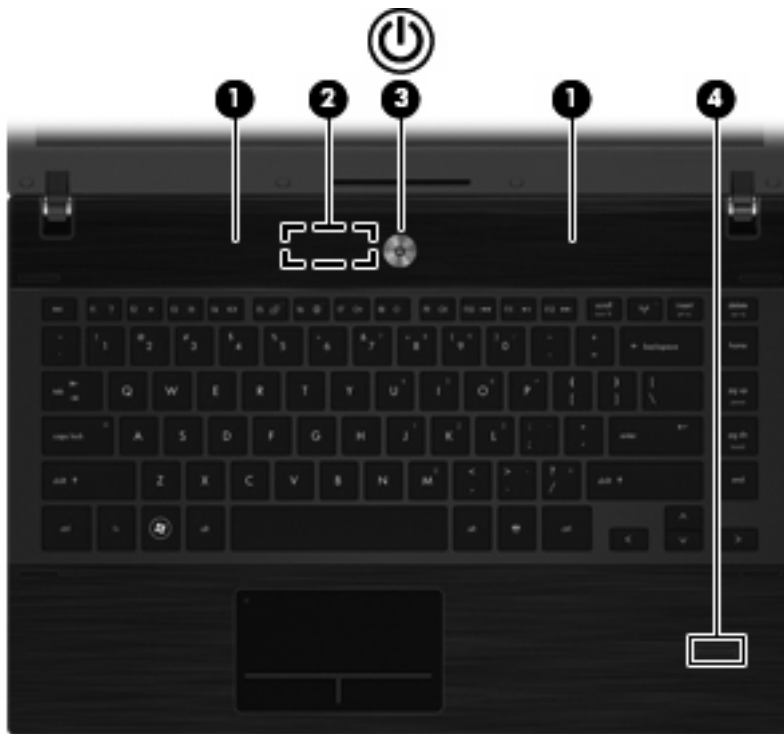

Component	Description
(1) Speakers (2)	Produce sound.
(2) Internal display switch	Turns off the display if the display is closed while the power is on.



Component	Description
(3) Power button	<ul style="list-style-type: none"><li>• When the computer is off, press the button to turn on the computer.</li><li>• When the computer is on, press the button to shut down the computer.</li><li>• When the computer is in the Sleep state, press the button briefly to exit Sleep.</li><li>• When the computer is in Hibernation, press the button briefly to exit Hibernation.</li></ul> <p>If the computer has stopped responding and Windows shutdown procedures are ineffective, press and hold the power button for at least 5 seconds to turn off the computer.</p> <p>To learn more about your power settings and how to change them, select <b>Start &gt; Control Panel &gt; System and Maintenance &gt; Power Options</b>.</p>
(4) Fingerprint reader (select models only)	Allows a fingerprint logon to Windows, instead of a password logon.

## Keys

 **NOTE:** Refer to the illustration that most closely matches your computer.

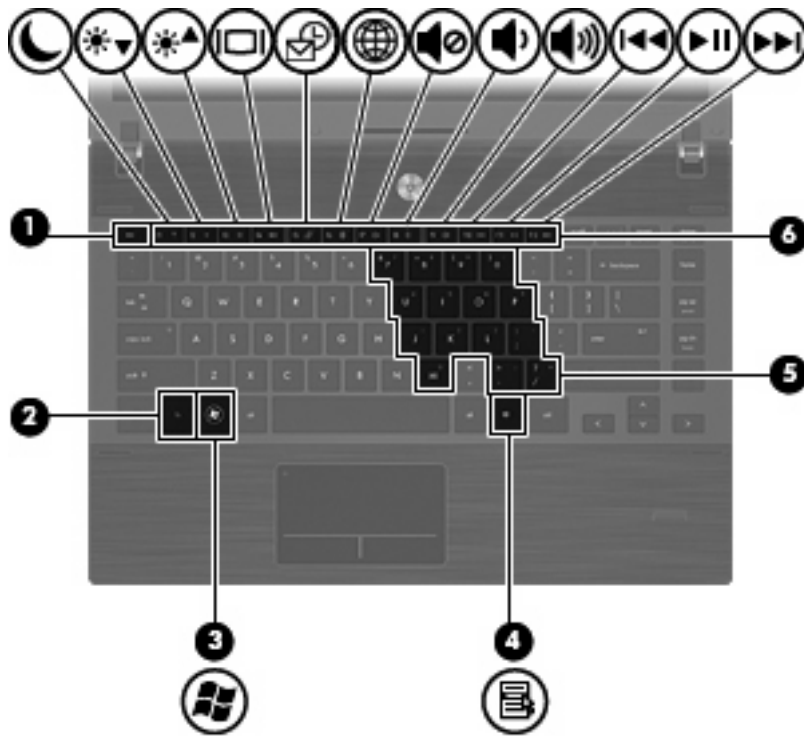

Component	Description
(1) <code>esc</code> key	Displays system information when pressed in combination with the <code>fn</code> key.
(2) <code>fn</code> key	Executes frequently used system functions when pressed in combination with a function key or the <code>esc</code> key.
(3) Windows logo key	Displays the Windows Start menu.
(4) Windows applications key	Displays a shortcut menu for items beneath the cursor.
(5) Embedded numeric keypad keys	Can be used like the keys on an external numeric keypad when pressed in combination with the <code>fn</code> and <code>num lk</code> keys.
(6) Function keys	Execute frequently used system functions when pressed in combination with the <code>fn</code> key.

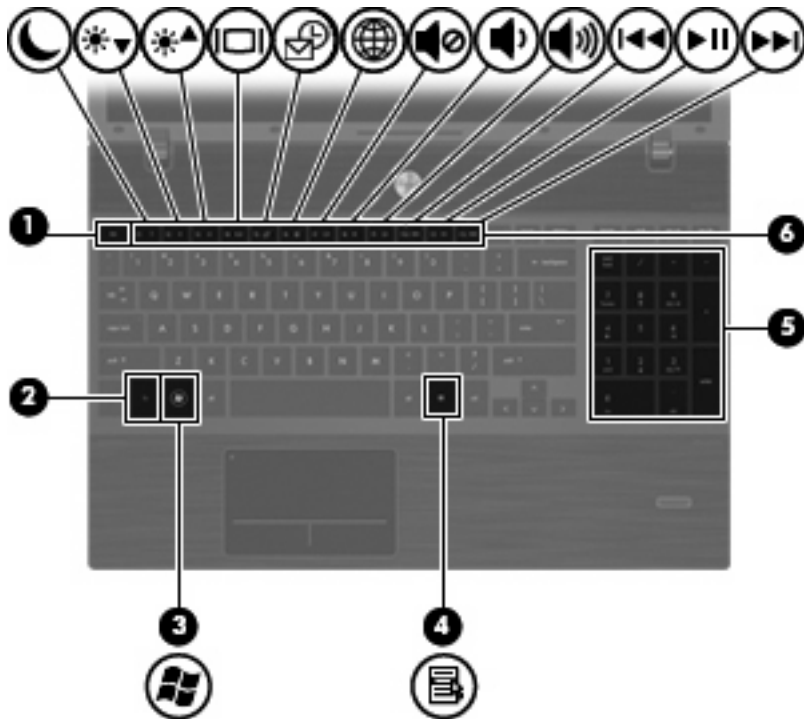

Component	Description
(1) <a href="#">esc</a> key	Displays system information when pressed in combination with the <a href="#">fn</a> key.
(2) <a href="#">fn</a> key	Executes frequently used system functions when pressed in combination with a function key or the <a href="#">esc</a> key.
(3) Windows logo key	Displays the Windows Start menu.
(4) Windows applications key	Displays a shortcut menu for items beneath the pointer.
(5) Integrated numeric keypad keys	Can be used like the keys on an external numeric keypad.
(6) Function keys	Execute frequently used system functions when pressed in combination with the <a href="#">fn</a> key.

## Front components



Component	Description
(1) Drive light	<ul style="list-style-type: none"> <li>Blinking white: The hard drive or optical drive is being accessed.</li> <li>Amber: HP 3D DriveGuard has temporarily parked the hard drive.</li> </ul>

Component	Description
(2) Media Card Reader	<p>Supports the following optional digital card formats:</p> <ul style="list-style-type: none"> <li>• Memory Stick</li> <li>• Memory Stick Duo (adapter required)</li> <li>• Memory Stick Pro (adapter required)</li> <li>• MultiMediaCard (MMC)</li> <li>• Secure Digital (SD) Memory Card</li> <li>• xD-Picture Card (XD)</li> <li>• xD-Picture Card (XD) Type H</li> <li>• xD-Picture Card (XD) Type M</li> </ul>
(3) Audio-out (headphone) jack	<p>Produces sound when connected to optional powered stereo speakers, headphones, ear buds, a headset, or television audio.</p> <p><b>NOTE:</b> When a device is connected to the headphone jack, the computer speakers are disabled.</p>
(4) Audio-in (microphone) jack	<p>Connects an optional computer headset microphone, stereo array microphone, or monaural microphone.</p>

## Right-side components

 **NOTE:** Refer to the illustration that most closely matches your computer.

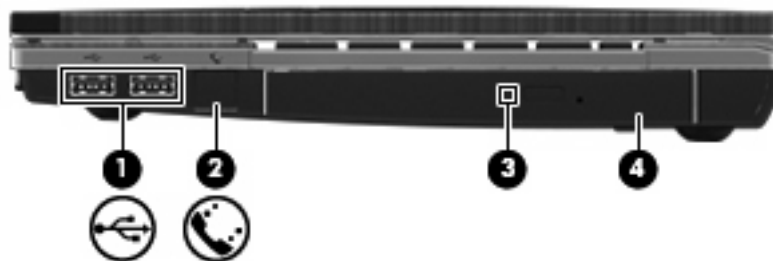

Component	Description
(1) USB ports (2)	Connect optional USB devices.
(2) RJ-11 (modem) jack (select models only)	Connects a modem cable.
(3) Optical drive light (select models only)	Blinking: The optical drive is being accessed.
(4) Optical drive (select models only)	Reads optical discs and, on select models, also writes to optical discs.

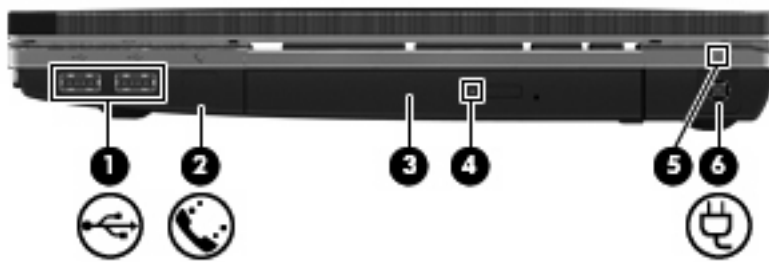

Component	Description
(1) USB ports (2)	Connect optional USB devices.
(2) RJ-11 (modem) jack (select models only)	Connects a modem cable.
(3) Optical drive (select models only)	Reads optical discs and, on select models, also writes to optical discs.
(4) Optical drive light (select models only)	Blinking: The optical drive is being accessed.
(5) AC adapter light	<ul style="list-style-type: none"> <li>On: The computer is connected to external power and the battery is charging.</li> <li>Off: The computer is not connected to external power.</li> </ul>
(6) Power connector	Connects an AC adapter.

## Left-side components

 **NOTE:** Refer to the illustration that most closely matches your computer.

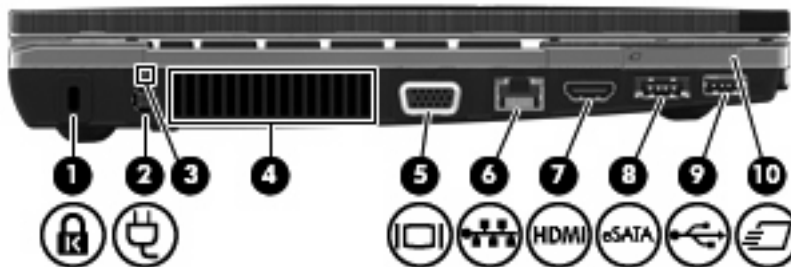

Component	Description
(1) Security cable slot	Attaches an optional security cable to the computer.  <b>NOTE:</b> The security cable is designed to act as a deterrent, but it may not prevent the computer from being mishandled or stolen.
(2) Power connector	Connects an AC adapter.
(3) AC adapter light	<ul style="list-style-type: none"> <li>On: The computer is connected to external power and the battery is charging.</li> <li>Off: The computer is not connected to external power.</li> </ul>
(4) Vent	Enables airflow to cool internal components.  <b>NOTE:</b> The computer fan starts up automatically to cool internal components and prevent overheating. It is normal for the internal fan to cycle on and off during routine operation.

Component	Description
(5) External monitor port	Connects an external VGA monitor or projector.
(6) RJ-45 (network) jack	Connects a network cable.
(7) HDMI port	Connects an optional HDMI device.
(8) Combo eSATA/USB port	Connects an optional USB device or high-performance eSATA components, such as an eSATA external hard drive.
(9) USB port	Connects optional USB device.
(10) ExpressCard slot	Supports optional ExpressCards.

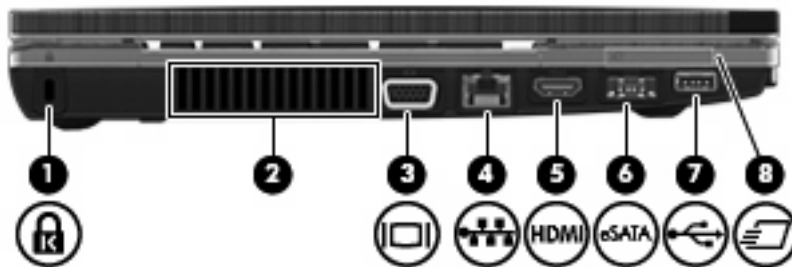

Component	Description
(1) Security cable slot	Attaches an optional security cable to the computer.  <b>NOTE:</b> The security cable is designed to act as a deterrent, but it may not prevent the computer from being mishandled or stolen.
(2) Vent	Enables airflow to cool internal components.  <b>NOTE:</b> The computer fan starts up automatically to cool internal components and prevent overheating. It is normal for the internal fan to cycle on and off during routine operation.
(3) External monitor port	Connects an external VGA monitor or projector.
(4) RJ-45 (network) jack	Connects a network cable.
(5) HDMI port	Connects an optional HDMI device.
(6) Combo eSATA/USB port	Connects an optional USB device or high-performance eSATA components, such as an eSATA external hard drive.
(7) USB port	Connects optional USB device.
(8) ExpressCard slot	Supports optional ExpressCards.

## Bottom components

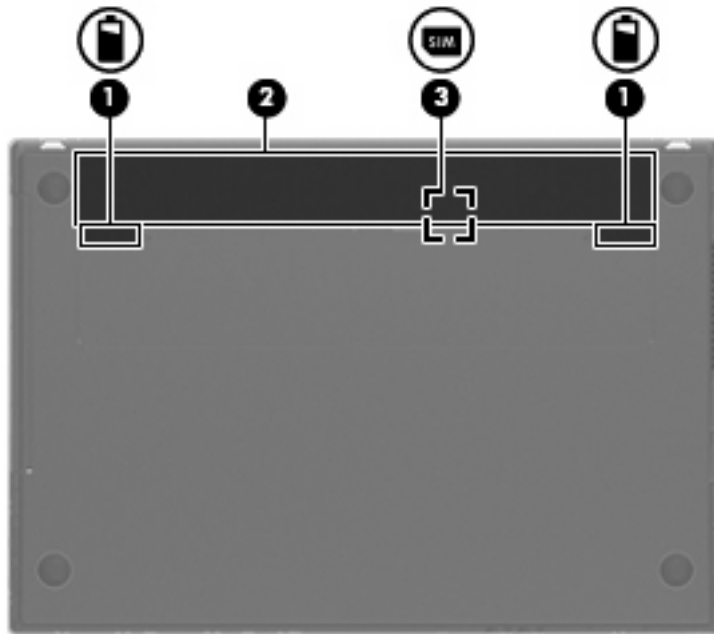

Component	Description
(1) Battery release latches (2)	Release the battery from the battery bay.
(2) Battery bay	Holds the battery.
(3) SIM slot (select models only)	Contains a wireless subscriber identity module (SIM). The SIM slot is located inside the battery bay.

## Display

 **NOTE:** Your computer may look slightly different from the illustration in this section.

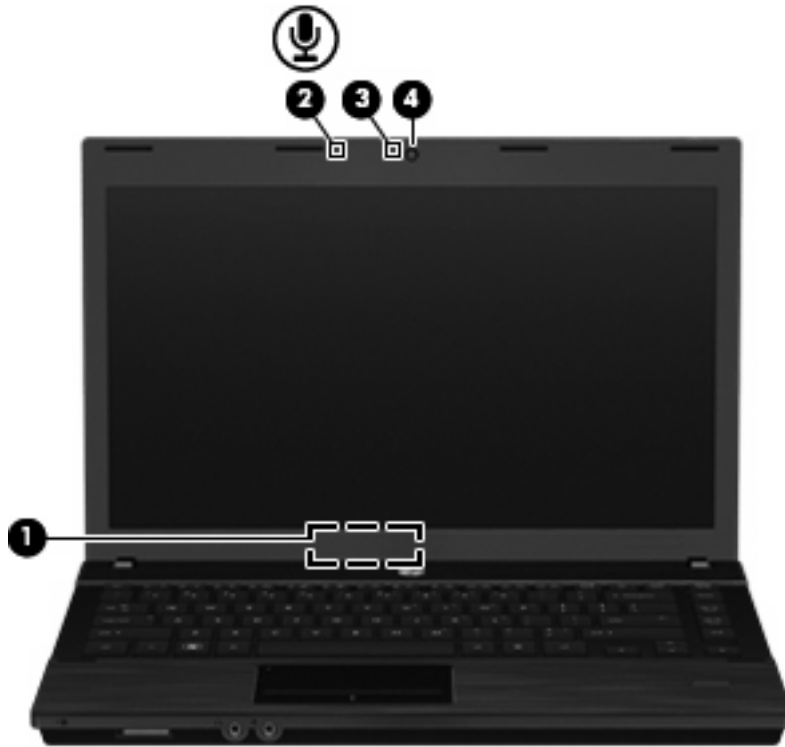

Component	Description
(1) Internal display switch	Turns off the display if the display is closed while the power is on.
(2) Internal microphone	Records sound.
(3) Webcam light (select models only)	On: The webcam is in use.
(4) Webcam (select models only)	Records video and captures still photographs.

## Wireless antennas (select models only)

The antennas send and receive signals from one or more wireless devices. These antennas are not visible from the outside of the computer.



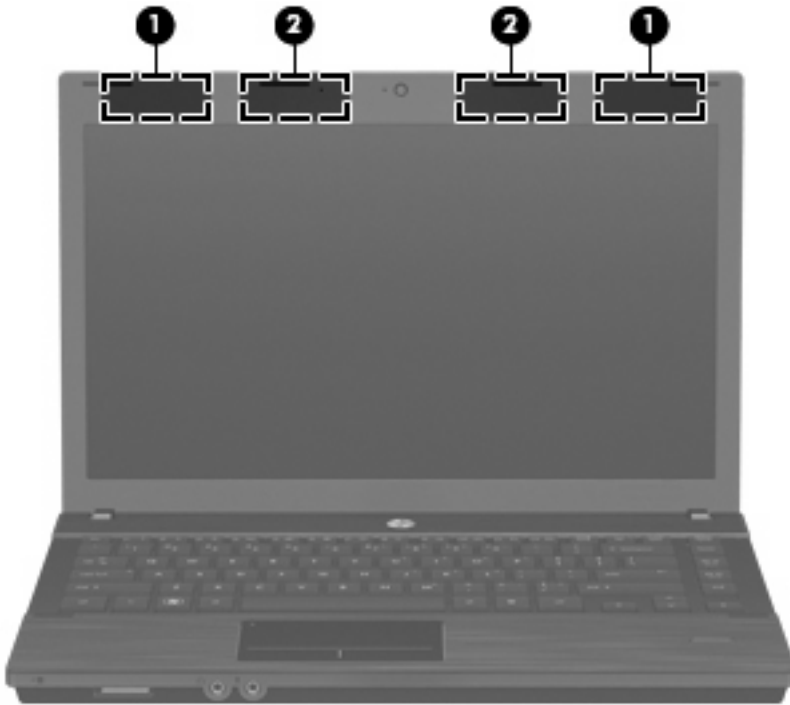

Component	Description
(1) WWAN antennas (2)*	Send and receive wireless signals to communicate with wireless wide area networks (WWANs).
(2) WLAN antennas (2)*	Send and receive wireless signals to communicate with wireless local area networks (WLANs).

\*The antennas are not visible from the outside of the computer. For optimal transmission, keep the areas immediately around the antennas free from obstructions.

To see wireless regulatory notices, refer to the section of the *Regulatory, Safety and Environmental Notices* that applies to your country or region. These notices are located in Help and Support.

## Additional hardware components

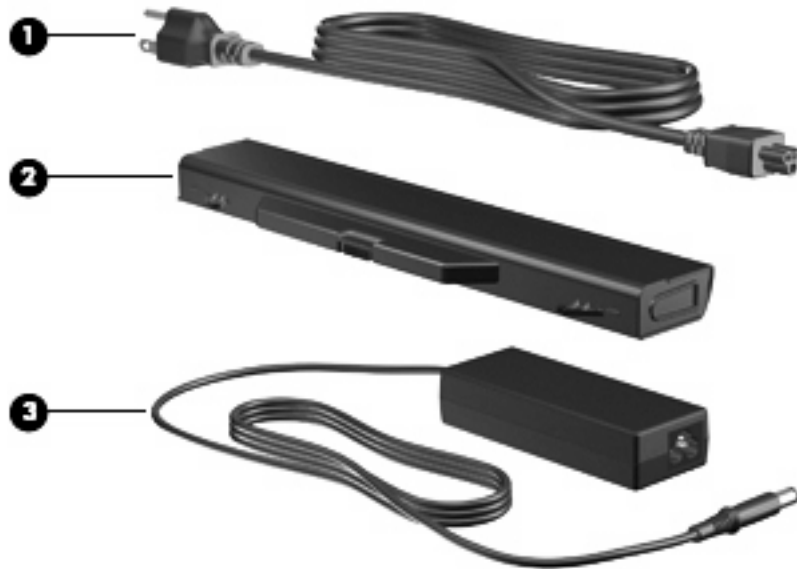

Component	Description
(1) Power cord*	Connects an AC adapter to an AC outlet.
(2) Battery*	Powers the computer when the computer is not plugged into an external power source.
(3) AC adapter	Converts AC power to DC power.

\*Batteries and power cords vary in appearance by country or region.

## Identifying the labels

The labels affixed to the computer provide information you may need when you troubleshoot system problems or travel internationally with the computer:

- Service tag—Provides important information, including the following:

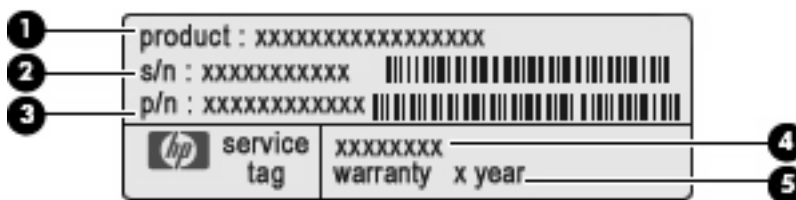

- Product name **(1)**. This is the product name affixed to the front of your notebook.
- Serial number (s/n) **(2)**. This is an alphanumeric number that is unique to each product.
- Part number/Product number (p/n) **(3)**. This number provides specific information about the product's hardware components. The part number helps a service technician to determine what components and parts are needed.

- Model description **(4)**. This is the number you use to locate documents, drivers, and support for your notebook.
- Warranty period **(5)**. Describes the duration of the warranty period for this computer.

Have this information available when you contact technical support. The service tag label is affixed to the bottom of the computer.

- Microsoft® Certificate of Authenticity—Contains the Windows Product Key. You may need the Product Key to update or troubleshoot the operating system. This certificate is affixed to the bottom of the computer.
- Regulatory label—Provides regulatory information about the computer. The regulatory label is affixed to the bottom of the computer.
- Modem approval label—Provides regulatory information about the modem and lists the agency approval markings required by some of the countries in which the modem has been approved for use. You may need this information when traveling internationally. The modem approval label is affixed to the bottom of the computer.
- Wireless certification label(s) (select models only)—Provide information about optional wireless devices and the approval markings of some of the countries in which the devices have been approved for use. An optional device may be a WLAN device or a Bluetooth device. If your computer model includes one or more wireless devices, one or more certification labels are included with your computer. You may need this information when traveling internationally. Wireless certification labels are affixed to the bottom of the computer.
- SIM (subscriber identity module) label (select models only)—Provides the ICCID (Integrated Circuit Card Identifier) of your SIM. This label is located inside the battery bay.
- HP Mobile Broadband Module serial number label (select models only)—Provides the serial number of your HP Mobile Broadband Module. This label is affixed to the bottom of the computer.

---

## 2 Wireless, modem, and local area network

### Using wireless devices (select models only)

Wireless technology transfers data across radio waves instead of wires. Your computer may be equipped with one or more of the following wireless devices:

- **WLAN device**—Connects the computer to wireless local area networks (commonly referred to as Wi-Fi networks, wireless LANs, or WLANs) in corporate offices, your home, and public places such as airports, restaurants, coffee shops, hotels, and universities. In a WLAN, each mobile wireless device communicates with a wireless router or a wireless access point.
- **HP Mobile Broadband Module**—A wireless wide area network (WWAN) device that provides access to information wherever mobile network operator service is available. In a WWAN, each mobile device communicates to a mobile network operator's base station. Mobile network operators install networks of base stations (similar to cell phone towers) throughout large geographic areas, effectively providing coverage across entire states, regions, or even countries.
- **Bluetooth device**—Creates a personal area network (PAN) to connect to other Bluetooth-enabled devices such as computers, phones, printers, headsets, speakers, and cameras. In a PAN, each device communicates directly with other devices, and devices must be relatively close together—typically within 10 meters (approximately 33 feet) of each other.

Computers with WLAN devices support one or more of the following IEEE industry standards:

- 802.11b, the first popular standard, supports data rates of up to 11 Mbps and operates at a frequency of 2.4 GHz.
- 802.11g supports data rates of up to 54 Mbps and operates at a frequency of 2.4 GHz. An 802.11g WLAN device is backward compatible with 802.11b devices, so they can operate on the same network.
- 802.11a supports data rates of up to 54 Mbps and operates at a frequency of 5 GHz.

---







 **NOTE:** 802.11a is not compatible with 802.11b and 802.11g.

---

- 802.11n supports data rates of up to 450 Mbps and may operate at 2.4 GHz or 5 GHz, making it backward compatible with 802.11a, b, and g.

For more information on wireless technology, refer to the information and Web site links provided in Help and Support.

## Identifying wireless and network icons

Icon	Name	Description
	Wireless (connected)	Identifies the location of the wireless lights and the wireless buttons on the computer. Also identifies the Wireless Assistant software on the computer and indicates that one or more of the wireless devices are on.
	Wireless (disconnected)	Identifies the Wireless Assistant software on the computer and indicates that all of the wireless devices are off.
	HP Connection Manager	Opens HP Connection Manager, which enables you to create a connection with an HP Mobile Broadband device (select models only).
	Network status (connected)	Indicates that one or more of your network drivers are installed and one or more network devices are connected to the network.
	Network status (unidentified)	Indicates that one or more of your network drivers are installed and one or more network devices are connected to the network, but the network is unidentified.
	Network status (disconnected)	Indicates that one or more of your network drivers are installed, but no network devices are connected to the network.

## Using the wireless controls

You can control the wireless devices in your computer using these features:

- Wireless button or wireless switch (referred to in this guide as the wireless button)
- Wireless Assistant software (select models only)
- HP Connection Manager software (select models only)
- Operating system controls

## Using the wireless button

The computer has a wireless button, one or more wireless devices, and one or two wireless lights, depending on the model. All of the wireless devices on your computer are enabled at the factory, so the wireless light is on (white) when you turn on the computer.

The wireless light indicates the overall power state of your wireless devices, not the status of individual devices. If the wireless light is white, at least one wireless device is on. If the wireless light is off, all wireless devices are off.

Because the wireless devices are enabled at the factory, you can use the wireless button to turn on or turn off the wireless devices simultaneously. Individual wireless devices can be controlled through Wireless Assistant software (select models only) or through Computer Setup.

 **NOTE:** If the wireless devices are disabled by Computer Setup, the wireless button will not work until you reenables your devices.

## Using Wireless Assistant software (select models only)

A wireless device can be turned on or off using the Wireless Assistant software. If a wireless device is disabled by Computer Setup, it must be reenabled by Computer Setup before it can be turned on or off using Wireless Assistant.

 **NOTE:** Enabling or turning on a wireless device does not automatically connect the computer to a network or a Bluetooth-enabled device.

To view the state of the wireless devices, position the cursor over the wireless icon in the notification area, at the far right of the taskbar.

If the wireless icon is not displayed in the notification area, complete the following steps to change the Wireless Assistant properties:

1. Select **Start > Control Panel > Mobile PC > Windows Mobility Center**.
2. Click the wireless icon in the Wireless Assistant tile, which is located in the bottom row of Windows Mobility Center.
3. Click **Properties**.
4. Select the check box next to **HP Wireless Assistant icon in notification area**.
5. Click **Apply**.

For more information, refer to the Wireless Assistant software Help:

1. Open Wireless Assistant by clicking the wireless icon in Windows Mobility Center.
2. Click the **Help** button.

## Using HP Connection Manager (select models only)

You can use HP Connection Manager to connect to WWANs using the HP Mobile Broadband device in your computer (select models only).

To start Connection Manager, click the **Connection Manager** icon in the notification area, at the far right of the taskbar.

– or –

Select **Start > All Programs > HP > HP Connection Manager**.

For more details about using Connection Manager, refer to the Connection Manager software Help.

## Using operating system controls

Some operating systems also offer a way to manage integrated wireless devices and the wireless connection. For example, Windows provides the Network and Sharing Center that allows you to set up a connection or network, connect to a network, manage wireless networks, and diagnose and repair connections.

To access the Network and Sharing Center, click **Start > Control Panel > Network and Internet > Network and Sharing Center**.

For more information, refer to Windows Help and Support. Click **Start > Help and Support**.

## Using a WLAN

With a WLAN device, you can access a WLAN, which is composed of other computers and accessories that are linked by a wireless router or a wireless access point.

 **NOTE:** The terms *wireless router* and *wireless access point* are often used interchangeably.

- A large-scale WLAN, such as a corporate or public WLAN, typically uses wireless access points that can accommodate a large number of computers and accessories and can separate critical network functions.
- A home or small office WLAN typically uses a wireless router, which allows several wireless and wired computers to share an Internet connection, a printer, and files without requiring additional pieces of hardware or software.

To use the WLAN device in your computer, you must connect to a WLAN infrastructure (provided through a service provider or a public or corporate network).

## Setting up a WLAN

To set up a WLAN and connect to the Internet, you need the following equipment:

- A broadband modem (either DSL or cable) **(1)** and high-speed Internet service purchased from an Internet service provider (ISP)
- A wireless router (purchased separately) **(2)**
- The wireless computer **(3)**

The illustration below shows an example of a wireless network installation that is connected to the Internet.

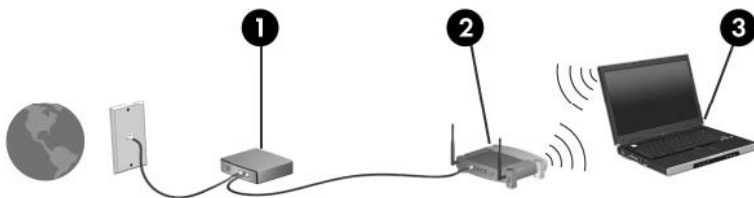

As your network grows, additional wireless and wired computers can be connected to the network to access the Internet.

For help in setting up your WLAN, refer to the information provided by your router manufacturer or your ISP.

## Protecting your WLAN

Because the WLAN standard was designed with only limited security capabilities—basically to foil casual eavesdropping rather than more powerful forms of attack—it is essential to understand that WLANs are vulnerable to well-known and well-documented security weaknesses.

WLANs in public areas, or “hotspots,” like coffee shops and airports, may not provide any security. New technologies are being developed by wireless manufacturers and hotspot service providers that make the public environment more secure and anonymous. If you are concerned about the security of your computer in a hotspot, limit your network activities to noncritical e-mail and basic Internet surfing.

When you set up a WLAN or access an existing WLAN, always enable security features to protect your network from unauthorized access. The common security levels are Wi-Fi Protected Access (WPA) and Wired Equivalent Privacy (WEP). Because wireless radio signals travel outside the network, other WLAN devices can pick up unprotected signals and either connect to your network (uninvited) or capture information being sent across it. However, you can take precautions to protect your WLAN:

- **Use a wireless transmitter with built-in security**

Many wireless base stations, gateways, and routers provide built-in security features such as wireless security protocols and firewalls. With the correct wireless transmitter, you can protect your network from the most common wireless security risks.

- **Work behind a firewall**

A firewall is a barrier that checks both data and requests for data that are sent to your network and then discards any suspicious items. Firewalls are available in many varieties, both software and hardware. Some networks use a combination of both types.

- **Use wireless encryption**

A variety of sophisticated encryption protocols is available for your WLAN. Find the solution that works best for your network security:

- **Wired Equivalent Privacy (WEP)** is a wireless security protocol that uses a WEP key to encode or encrypt all network data before it is transmitted. Usually, you can allow the network to assign the WEP key. Alternatively, you can set up your own key, generate a different key, or choose other advanced options. Without the correct key, others will not be able to use the WLAN.
- **WPA (Wi-Fi Protected Access)**, like WEP, uses security settings to encrypt and decrypt data that is transmitted over the network. However, instead of using one static security key for encryptions as WEP does, WPA uses *temporal key integrity protocol* (TKIP) to dynamically generate a new key for every packet. It also generates different sets of keys for each computer on the network.

- **Close your network**

If possible, prevent your network name (SSID) from being broadcast by the wireless transmitter. Most networks initially broadcast the name, telling any computer nearby that your network is available. By closing the network, other computers are less likely to know that your network exists.

 **NOTE:** If your network is closed and the SSID is not broadcast, you will need to know or remember the SSID to connect new devices to the network. Write down the SSID and store it in a secure place before closing the network.



## Connecting to a WLAN

To connect to the WLAN, follow these steps:

1. Be sure that the WLAN device is on. If it is on, the wireless light is on (white). If the wireless light is off (amber), press the wireless button.
2. Select **Start > Connect to**.
3. Select your WLAN from the list, and then type the network security key, if required.
  - If the network is unsecured, meaning that anyone can access the network, a warning is displayed. Click **Connect Anyway** to accept the warning and complete the connection.
  - If the network is a security-enabled WLAN, you are prompted to enter a network security key, which is a security code. Type the code, and then click **Connect** to complete the connection.

---

 **NOTE:** If no WLANs are listed, you are out of range of a wireless router or access point.

**NOTE:** If you do not see the network you want to connect to, click **Set up a connection or network**. A list of options is displayed. You can choose to manually search for and connect to a network or create a new network connection.

---

After the connection is made, place the cursor over the network status icon in the notification area, at the far right of the taskbar, to verify the name and status of the connection.

---

 **NOTE:** The functional range (how far your wireless signals travel) depends on WLAN implementation, router manufacturer, and interference from other electronic devices or structural barriers such as walls and floors.

---

More information about using a WLAN is available through the following resources:

- Information from your ISP and the manufacturer's instructions included with your wireless router and other WLAN equipment
- Information and Web site links provided in Help and Support

For a list of public WLANs near you, contact your ISP or search the Web. Web sites that list public WLANs include Cisco Internet Mobile Office Wireless Locations, Hotspotlist, and Geektools. Check with each public WLAN location for cost and connection requirements.

For additional information on connecting your computer to a corporate WLAN, contact your network administrator or IT department.

## Roaming to another network

When you move your computer within range of another WLAN, Windows attempts to connect to that network. If the attempt is successful, your computer is automatically connected to the new network. If Windows does not recognize the new network, follow the same procedure you used initially to connect to your WLAN.

## Using HP Mobile Broadband (select models only)

HP Mobile Broadband enables your computer to use wireless wide area networks (WWANs) to access the Internet from more places and over larger areas than it can by using WLANs. Using HP Mobile Broadband requires a network service provider (called a *mobile network operator*), which in most cases is a mobile phone network operator. Coverage for HP Mobile Broadband is similar to mobile phone voice coverage.

When used with mobile network operator service, HP Mobile Broadband gives you the freedom to stay connected to the Internet, send e-mail, or connect to your corporate network whether you are on the road or outside the range of Wi-Fi hotspots.

HP supports the following technologies:

- HSPA (High Speed Packet Access) module, which provides access to networks based on the Global System for Mobile Communications (GSM) telecommunications standard.
- EV-DO (Evolution Data Optimized) module, which provides access to networks based on the code division multiple access (CDMA) telecommunications standard.

You may need the HP Mobile Broadband Module serial number to activate mobile broadband service. The serial number is printed on a label inside the battery bay of your computer.

Some mobile network operators require the use of a subscriber identity module (SIM). A SIM contains basic information about you, such as a PIN, as well as network information. Some computers include a SIM that is preinstalled in the battery bay. If the SIM is not preinstalled, it may be provided in the HP Mobile Broadband information provided with your computer or the mobile network operator may provide it separately from the computer.

For information on inserting and removing the SIM, refer to the “Inserting a SIM” and “Removing a SIM” sections in this chapter.

For information on HP Mobile Broadband and how to activate service with a preferred mobile network operator, refer to the mobile broadband information included with your computer. For additional information, see the HP Web site at <http://www.hp.com/go/mobilebroadband> (US only).

### Inserting a SIM

---

△ **CAUTION:** To prevent damage to the connectors, use minimal force when inserting a SIM.

---

To insert a SIM:

1. Shut down the computer. If you are not sure whether the computer is off or in Hibernation, turn the computer on by pressing the power button. Then, shut down the computer through the operating system.
2. Close the display.
3. Disconnect all external devices connected to the computer.
4. Unplug the power cord from the AC outlet.
5. Turn the computer upside down on a flat surface, with the battery bay toward you.
6. Remove the battery.

7. Insert the SIM into the SIM slot, and gently push the SIM into the slot until it is firmly seated.

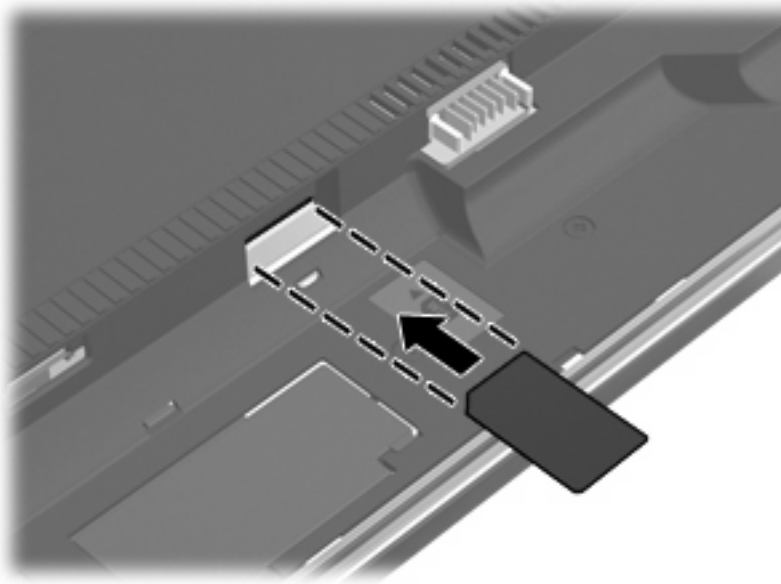

8. Replace the battery.

 **NOTE:** HP Mobile Broadband will be disabled if the battery is not replaced.

9. Turn the computer right-side up, and then reconnect external power and external devices.
10. Turn on the computer.

## Removing a SIM

To remove a SIM:

1. Shut down the computer. If you are not sure whether the computer is off or in Hibernation, turn the computer on by pressing the power button. Then, shut down the computer through the operating system.
2. Close the display.
3. Disconnect all external devices connected to the computer.
4. Unplug the power cord from the AC outlet.
5. Turn the computer upside down on a flat surface, with the battery bay toward you.
6. Remove the battery.

7. Press in on the SIM (1), and then remove it from the slot (2).

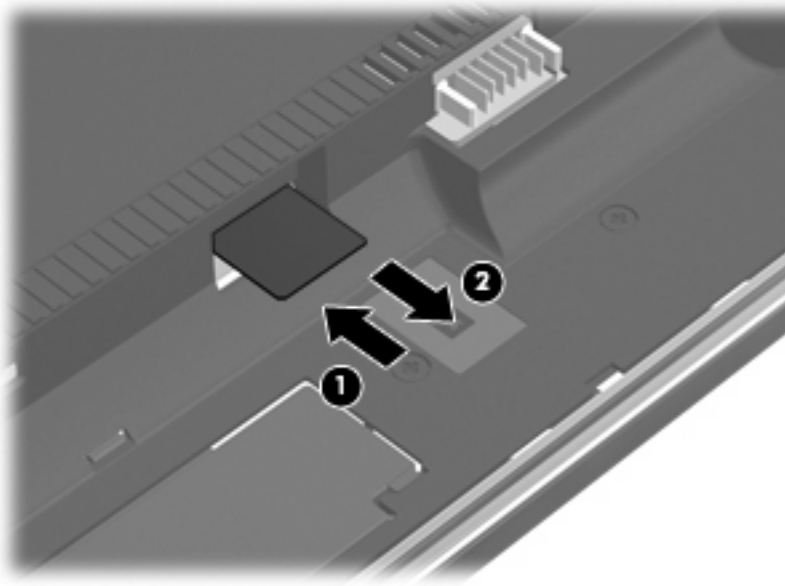

8. Replace the battery.
9. Turn the computer right-side up, and then reconnect external power and external devices.
10. Turn on the computer.

## Using Bluetooth wireless devices (select models only)

A Bluetooth device provides short-range wireless communications that replace the physical cable connections that traditionally link electronic devices, such as the following:

- Computers (desktop, notebook, PDA)
- Phones (cellular, cordless, smart phone)
- Imaging devices (printer, camera)
- Audio devices (headset, speakers)

Bluetooth devices provide peer-to-peer capability that allows you to set up a personal area network (PAN) of Bluetooth devices. For information on configuring and using Bluetooth devices, refer to the Bluetooth software Help.

## Bluetooth and Internet Connection Sharing (ICS)

HP does **not** recommend setting up one computer with Bluetooth as a host and using it as a gateway through which other computers may connect to the Internet. When two or more computers are connected using Bluetooth, and Internet Connection Sharing (ICS) is enabled on one of the computers, the other computers may not be able to connect to the Internet using the Bluetooth network.

The strength of Bluetooth is in synchronizing information transfers between your computer and wireless devices including cellular phones, printers, cameras, and PDAs. The inability to consistently connect two or more computers to share the Internet through Bluetooth is a limitation of Bluetooth and the Windows operating system.

# Troubleshooting wireless connection problems

Some possible causes for wireless connection problems include the following:

- Wireless device is not installed correctly or has been disabled.
- Wireless device or router hardware has failed.
- Network configuration (SSID or security) has been changed.
- Wireless device encountered interference from other devices.

---

 **NOTE:** Wireless networking devices are included with select computer models only. If wireless networking is not listed in the feature list on the side of the original computer package, you may add wireless networking capability to the computer by purchasing a wireless networking device.

---

Before working your way through the sequence of possible solutions to your network connection problem, be sure that device drivers are installed for all wireless devices.

Use the procedures in this chapter to diagnose and repair a computer that does not connect to the network you want to use.

## Cannot create a WLAN connection

If you have a problem connecting to a WLAN, confirm that the integrated WLAN device is properly installed on your computer:

---

 **NOTE:** Windows includes the User Account Control feature to improve the security of your computer. You may be prompted for your permission or password for tasks such as installing software, running utilities, or changing Windows settings. Refer to Windows Help and Support for more information.

---

1. Select **Start > Computer > System properties**.
2. In the left pane, click **Device Manager**.
3. Identify the WLAN device from the Network adapters list. The listing for a WLAN device may include the term *wireless*, *wireless LAN*, *WLAN*, or *802.11*.

If no WLAN device is listed, either your computer does not have an integrated WLAN device, or the driver for the WLAN device is not properly installed.

For more information on troubleshooting WLANs, refer to the Web site links provided in Help and Support.

## Cannot connect to a preferred network

Windows can automatically repair a corrupted WLAN connection:

- If there is a network status icon in the notification area, at the far right of the taskbar, right-click the icon, and then click **Diagnose and repair** from the menu.

Windows resets your network device and attempts to reconnect to one of the preferred networks.

- If an “x” is superimposed over the network status icon, one or more of your WLAN or LAN drivers are installed, but the computer is not connected.
- If there is no network status icon in the notification area, follow these steps:
  1. Click **Start** and type `network and sharing` in the **Start Search** box.
  2. From the list of search results, click **Network and Sharing Center**.
  3. In the left pane, click **Diagnose and repair**.

The Network connections window is displayed, and Windows resets your network device and attempts to reconnect to one of the preferred networks.

## Network status icon is not displayed

If the network status icon is not displayed in the notification area after you configure the WLAN, the software driver is either missing or corrupted. A Windows “Device not Found” error message may also be displayed. The driver must be reinstalled.

To get the latest version of the WLAN device software for your computer, follow these steps:

1. Open your Internet browser and go to <http://www.hp.com/support>.
2. Select your country or region.
3. Click the option for software and driver downloads, and then type your computer model number in the Search box.
4. Press **enter**, and then follow the on-screen instructions.

 **NOTE:** If the WLAN device you are using was purchased separately, consult the manufacturer's Web site for the latest software.

---

## Current network security codes are unavailable

If you are prompted for a network key or an SSID when connecting to a WLAN, the network is protected by security. You must have the current codes to make a connection on a secure network. The SSID and network key are alphanumeric codes that you enter into your computer to identify your computer to the network.

- For a network connected to your personal wireless router, review the router user guide for instructions on setting up the same codes on both the router and the WLAN device.
- For a private network, such as a network in an office or at a public Internet chat room, contact the network administrator to obtain the codes, and then enter the codes when prompted to do so.

Some networks change the SSID or network keys used in their routers or access points on a regular basis to improve security. You must change the corresponding code in your computer accordingly.

If you are provided with new wireless network keys and SSID for a network, and if you have previously connected to that network, follow the steps below to connect to the network:

1. Select **Start > Network > Network and Sharing Center > Manage wireless networks**.

A list showing the available WLANs is displayed. If you are in a hotspot where several WLANs are active, several will be displayed.

2. Right-click the network, and then click **Properties**.



**NOTE:** If the network you want is not listed, check with the network administrator to be sure that the router or access point is operating.

3. Click the **Security** tab, and then enter the correct wireless encryption data into the **Network security key** field.
4. Click **OK** to save these settings.

## WLAN connection is very weak

If the connection is very weak, or if your computer cannot make a connection to a WLAN, minimize interference from other devices, as follows:

- Move your computer closer to the wireless router or access point.
- Temporarily disconnect other wireless devices such as a microwave, cordless phone, or cellular phone to be sure that they are not interfering.

If the connection does not improve, try forcing the device to reestablish all connection values:

1. Select **Start > Network > Network and Sharing Center > Manage wireless networks**.

A list showing the available WLANs is displayed. If you are in a hotspot where several WLANs are active, several will be displayed.

2. Right-click a network, and then click **Remove network**.

## Cannot connect to the wireless router

If you are trying to connect to the wireless router and are unsuccessful, reset the wireless router by removing power from the router for 10 to 15 seconds.

If the computer still cannot make a connection to a WLAN, restart the wireless router. For details, refer to the router manufacturer's instructions.



## Using the modem (select models only)

The modem must be connected to an analog telephone line using a 6-pin, RJ-11 modem cable (included with select models only). In some countries, a country-specific modem cable adapter is also required. Jacks for digital PBX systems may resemble analog telephone jacks, but they are not compatible with the modem.

⚠ **WARNING!** Connecting the internal analog modem to a digital line can permanently damage the modem. Immediately disconnect the modem cable if you accidentally connect it to a digital line.

If the modem cable contains noise suppression circuitry **(1)**, which prevents interference from TV and radio reception, orient the circuitry end **(2)** of the cable toward the computer.



## Connecting a modem cable

⚠ **WARNING!** To reduce the risk of electric shock, fire, or damage to the equipment, do not plug a modem cable (included with select models only) or telephone cable into the RJ-45 (network) jack.

To connect a modem cable:

1. Plug the modem cable into the modem jack **(1)** on the computer.
2. Plug the modem cable into the RJ-11 telephone wall jack **(2)**.

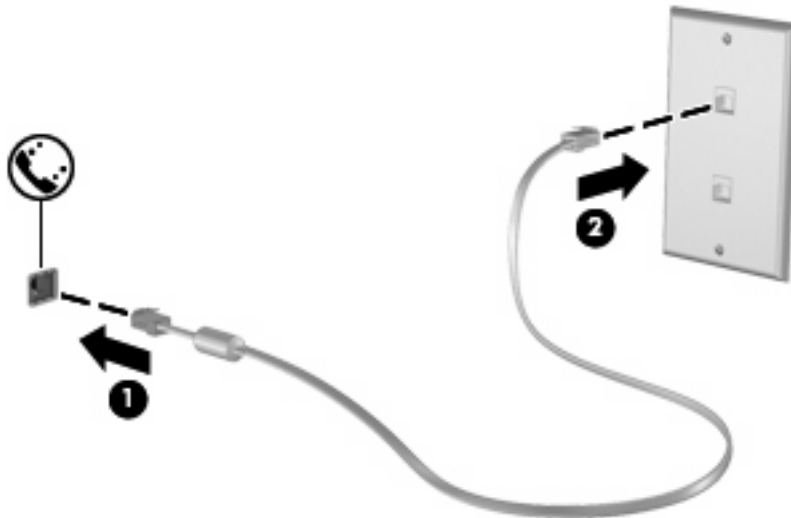

## Connecting a country-specific modem cable adapter

Telephone jacks vary by country. To use the modem and the modem cable (included with select models only) outside the country in which you purchased the computer, you must obtain a country-specific modem cable adapter (included with select models only).

To connect the modem to an analog telephone line that does not have an RJ-11 telephone jack, follow these steps:

1. Plug the modem cable into the modem jack **(1)** on the computer.
2. Plug the modem cable into the country-specific modem cable adapter **(2)**.
3. Plug the country-specific modem cable adapter **(3)** into the telephone wall jack.

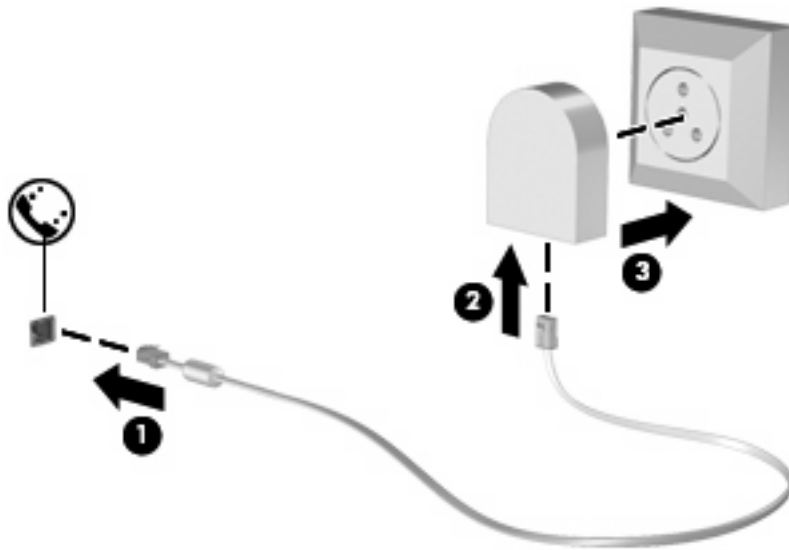

## Selecting a location setting

### Viewing the current location selection

To view the current location setting for the modem, follow these steps:

1. Select **Start > Control Panel**.
2. Click **Clock, Language, and Region**.
3. Click **Regional and Language Options**.
4. Your location is displayed under Location.

## Adding new locations when traveling

By default, the only location setting available to the modem is a location setting for the country in which you purchased the computer. As you travel to different countries, set the internal modem to a location setting that meets the operating standards of the country in which you are using the modem.

As you add new location settings, they are saved by the computer so that you can switch among settings at any time. You can add multiple location settings for any country.

△ **CAUTION:** To prevent losing your home country settings, do not delete your current modem country settings. To enable modem use in other countries while preserving your home country configuration, add a new configuration for each location in which you will use the modem.

**CAUTION:** To prevent configuring the modem in a way that violates the telecommunications regulations and laws of the country you are visiting, select the country in which the computer is located. The modem may not function properly if the correct country selection is not made.

To add a location setting for the modem, follow these steps:

1. Select **Start > Control Panel > Hardware and Sound > Phone and Modem Options**.
2. Click the **Dialing Rules** tab.
3. Click **New**. (The New Location window is displayed.)
4. In the **Location name** box, type a name (such as “home” or “work”) for the new location setting.
5. Select a country or region from the **Country/region** drop-down list. (If you select a country or region that is not supported by the modem, the Country/region selection for *USA* or *UK* is displayed by default.)
6. Enter the area code, a carrier code (if necessary), and the number to access an outside line (if necessary).
7. Next to **Dial using**, click **Tone** or **Pulse**.
8. Click **OK** to save your new location setting. (The Phone and Modem Options window is displayed.)
9. Do one of the following:
  - To set your new location setting as the current location, click **OK**.
  - To select another location setting as the current location setting, select your preference from the settings in the **Location** list, and then click **OK**.

📝 **NOTE:** You can use the preceding procedure to add location settings for places within your own country as well as in other countries. For example, you could add a setting named “Work” that includes dialing rules for accessing an outside line.

## Solving travel connection problems

If you experience modem connection problems when using the computer outside of the country in which you purchased it, try the following suggestions:

- **Check the telephone line type.**

The modem requires an analog, not a digital, telephone line. A line described as a PBX line is usually a digital line. A telephone line described as a data line, fax machine line, modem line, or standard telephone line is usually an analog line.

- **Check for pulse or tone dialing.**

An analog telephone line supports one of two dialing modes: pulse dialing or tone dialing. These dialing mode options are selected in the Phone and Modem Options settings. The dialing mode option selected must match the dialing mode supported by the telephone line in your location.

To determine the dialing mode supported by a telephone line, dial a few digits on the telephone, and then listen for clicks (pulses) or tones. Clicks indicate that the telephone line supports pulse dialing. Tones indicate that the telephone line supports tone dialing.

To change the dialing mode in your current modem location setting, follow these steps:

1. Select **Start > Control Panel > Hardware and Sound > Phone and Modem Options**.
2. Click the **Dialing Rules** tab.
3. Select your modem location setting.
4. Click **Edit**.
5. Click either **Tone** or **Pulse**.
6. Click **OK** twice.

- **Check the telephone number you are dialing and the response of the remote modem.**

Dial a telephone number, make sure there is a response from the remote modem, and then hang up.

- **Set the modem to ignore dial tones.**

If the modem receives a dial tone it does not recognize, it does not dial and displays a “No Dial Tone” error message.

To set the modem to ignore all dial tones before dialing, follow these steps:

1. Select **Start > Control Panel > Hardware and Sound > Phone and Modem Options**.
2. Click the **Modems** tab.
3. Click the listing for the modem.
4. Click **Properties**.
5. Click **Modem**.
6. Clear the check box for **Wait for dial tone before dialing**.
7. Click **OK** twice.

## Connecting to a local area network (LAN)

Connecting to a local area network (LAN) requires an 8-pin, RJ-45 network cable (not included). If the network cable contains noise suppression circuitry (1), which prevents interference from TV and radio reception, orient the circuitry end of the cable (2) toward the computer.



To connect the network cable:

1. Plug the network cable into the network jack (1) on the computer.
2. Plug the other end of the cable into a network wall jack (2).

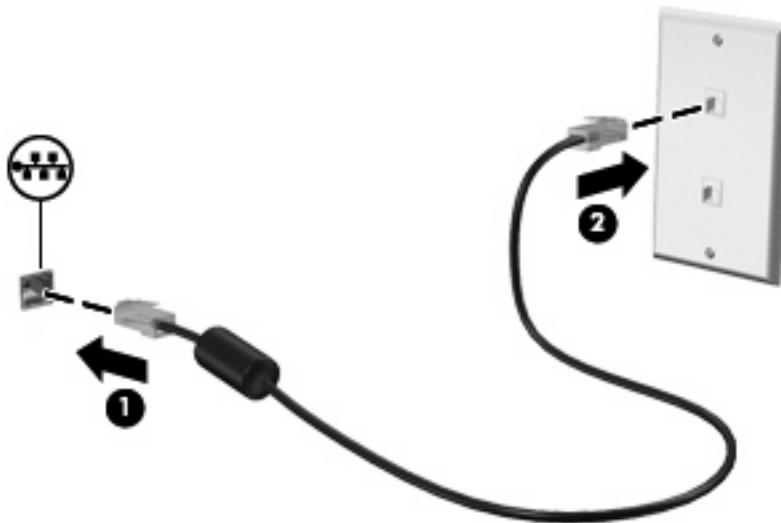

**⚠ WARNING!** To reduce the risk of electric shock, fire, or damage to the equipment, do not plug a modem or telephone cable into the RJ-45 (network) jack.

---

## 3 Pointing devices and keyboard

### Using pointing devices

#### Setting pointing device preferences

Use Mouse Properties in Windows to customize settings for pointing devices, such as button configuration, click speed, and pointer options.

To access Mouse Properties, select **Start > Control Panel > Hardware and Sound > Mouse**.

#### Using the TouchPad

##### Turning the TouchPad on and off

The TouchPad is turned on at the factory. When the TouchPad zone is active, the light is off.

To turn the TouchPad on and off, quickly double-tap the TouchPad off indicator.

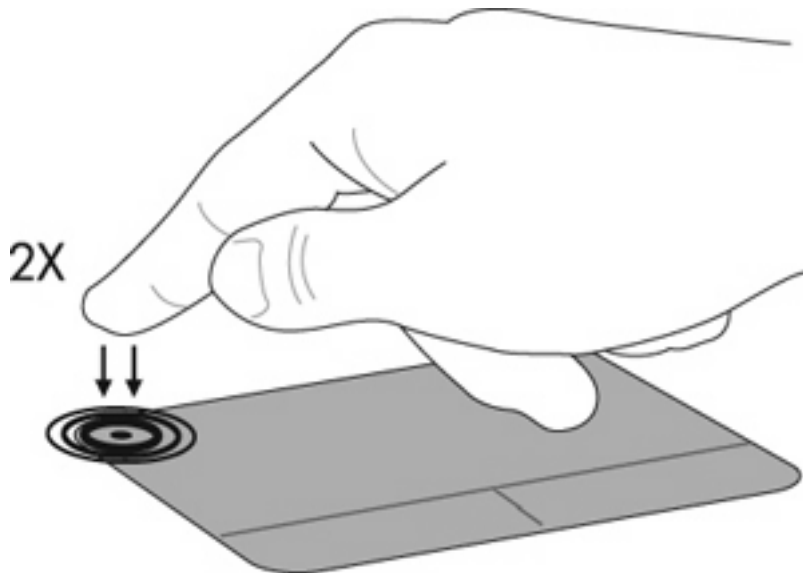

#### Navigating

To move the pointer, touch and slide your finger across the TouchPad in the direction you want the pointer to go. Use the left and right TouchPad buttons like the corresponding buttons on an external mouse. To scroll up and down using the TouchPad, touch and slide your finger up or down over the TouchPad.

 **NOTE:** If you are using the TouchPad to move the pointer, and then want to scroll, you must lift your finger off the TouchPad before starting to scroll.

---

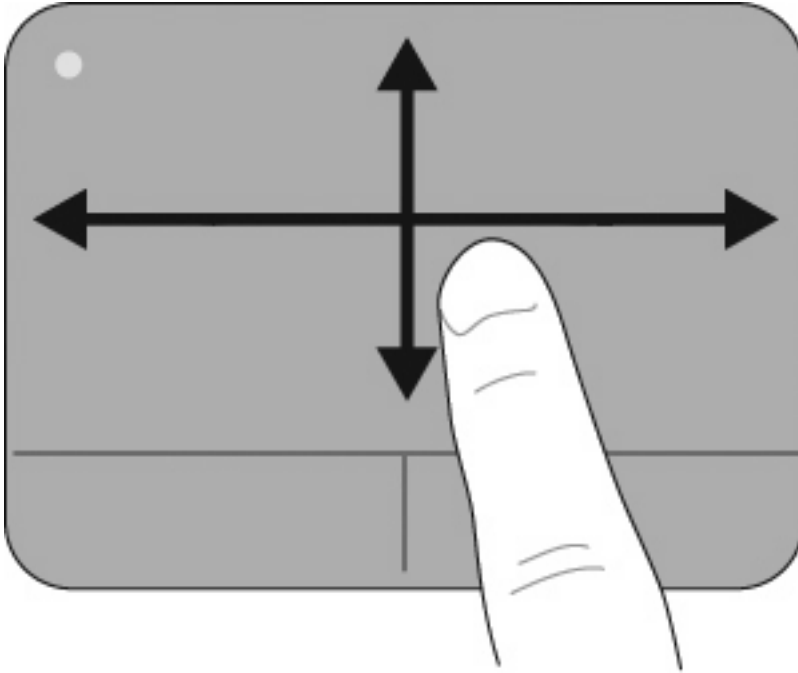

## Selecting

Use the left and right TouchPad buttons like the corresponding buttons on an external mouse.

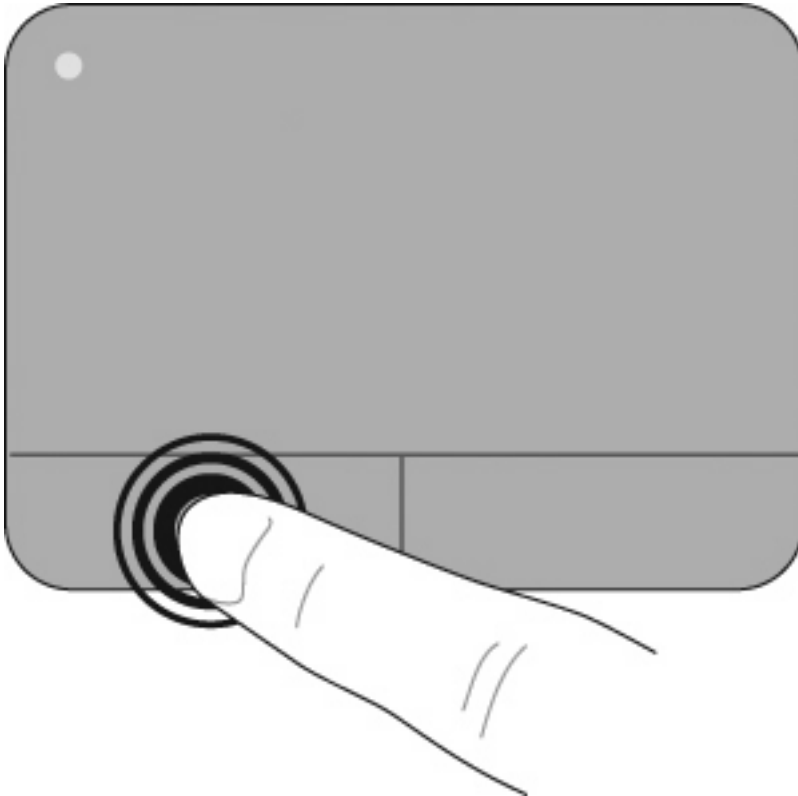

## Using TouchPad gestures

The TouchPad supports a variety of TouchPad gestures. To activate the TouchPad gestures, place two or three fingers on the TouchPad at the same time as described in the following sections.

 **NOTE:** You can scroll and pinch anywhere on the TouchPad. The rotate gesture must be done within the TouchPad zone.

The TouchPad gestures described in this section are enabled at the factory. To disable or reenable these gestures:

1. Double-click on the **Synaptics** icon in the notification area, at the far right of the taskbar, and then click the **Device Settings** tab.
2. Select the device, and then click **Settings**.
3. Select the gesture that you want to disable or reenable.
4. Click **Apply**, and then click **OK**.

 **NOTE:** Your computer also supports additional TouchPad features that are disabled at the factory. To view and enable these features, click the **Synaptics** icon in the notification area, at the far right of the taskbar, and then click the **Device Settings** tab. Select the device, and then click **Settings**.

### Scrolling

Scrolling is useful for moving up or down on a page or image. To scroll, place two fingers slightly apart on the TouchPad and drag them across the TouchPad in an up, down, left, or right motion.

 **NOTE:** Scrolling speed is controlled by finger speed.

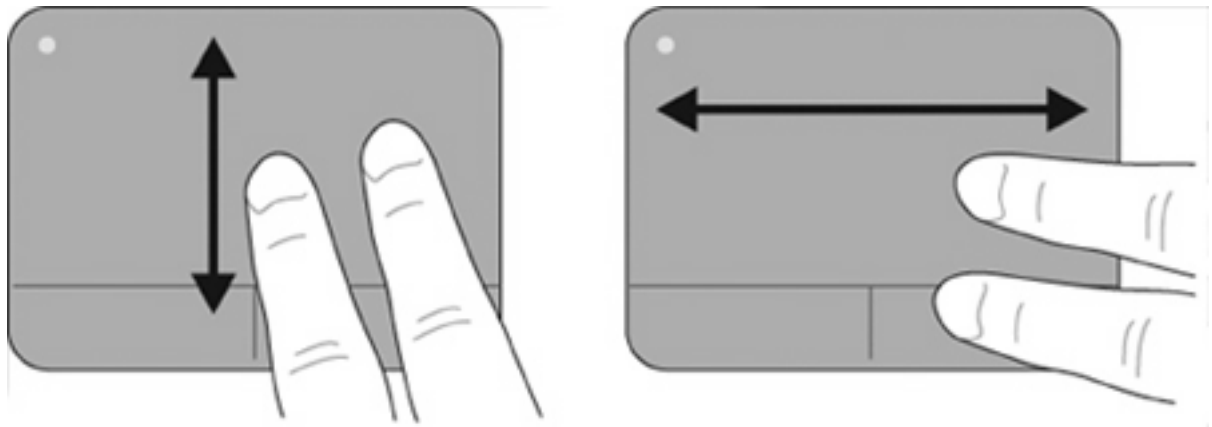

### Pinching/Zooming

Pinching allows you to zoom in or out on items such as PDFs, images, and photos.



To pinch:

- Zoom in by placing two fingers together on the TouchPad, and then moving them apart to gradually increase the object's size.
- Zoom out by placing two fingers apart on the TouchPad, and then moving them together to gradually decrease the object's size.

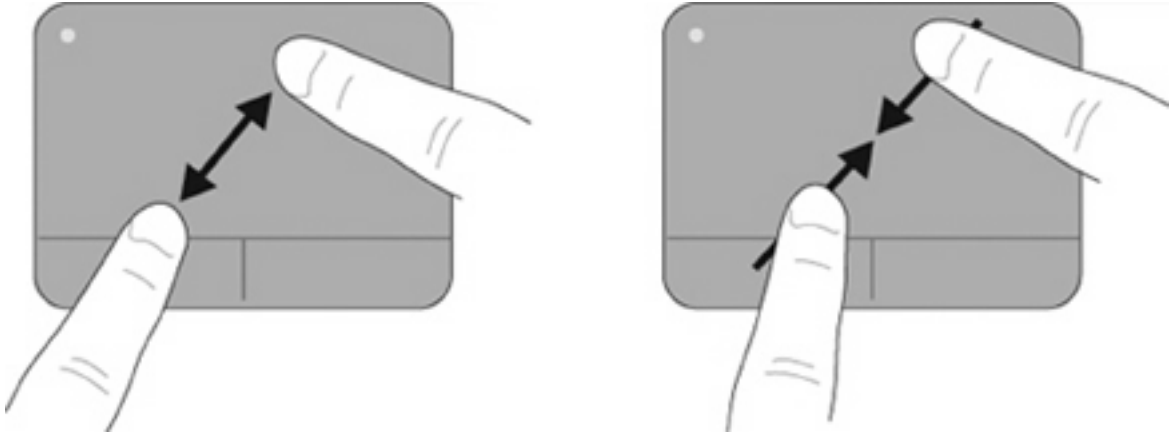

## Rotating

Rotating allows you to rotate items such as photos and pages. To rotate, anchor your left forefinger in the TouchPad zone. Move the right forefinger around the anchored finger in a sweeping motion, moving from twelve o'clock to three o'clock. To reverse the rotation, move your right forefinger from three o'clock to twelve o'clock.

 **NOTE:** Rotating must be done within the TouchPad zone.

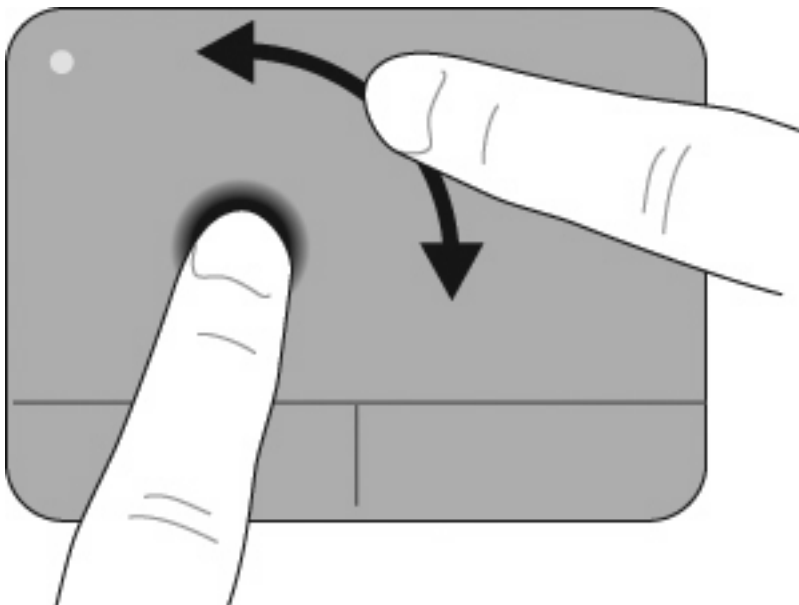

## Three-finger flick

Three-finger flicking allows you to enhance navigation and application control for rapidly paging through documents, photos, presentations, and other files.

Place three fingers slightly separated on the TouchPad. Flick your three fingers across the TouchPad in a linear, continuous motion (right for next, left for previous, up to start or play a presentation, or down to stop or end a presentation).

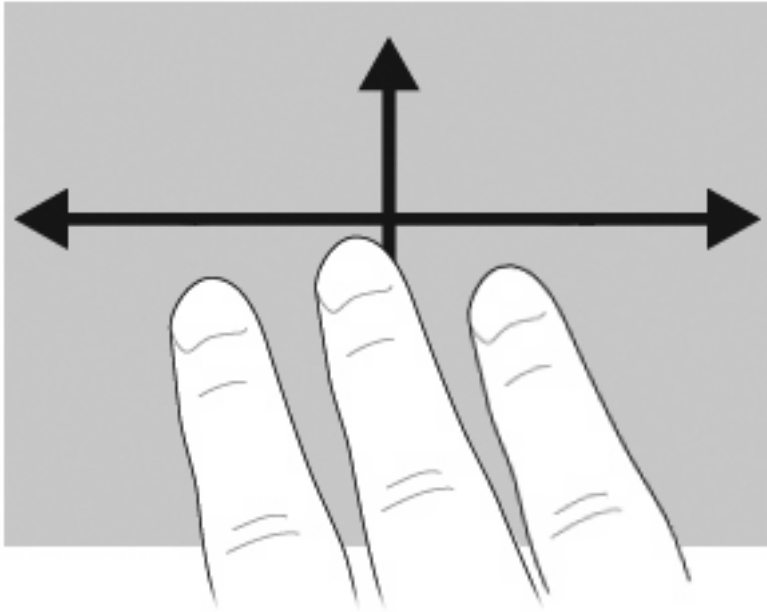

## Connecting an external mouse

You can connect an external USB mouse to the computer using one of the USB ports on the computer. A USB device can be added by connecting the device to a USB port on the computer or on an optional docking device (select models only).

## Using the keyboard

### Using hotkeys

Hotkeys are combinations of the **fn** key **(1)** and either the **esc** key **(2)** or one of the function keys **(3)**.

The icons on the **f1** through **f12** keys represent the hotkey functions. Hotkey functions and procedures are discussed in the following sections.

---

 **NOTE:** Your computer may look slightly different from the illustration in this section.

---

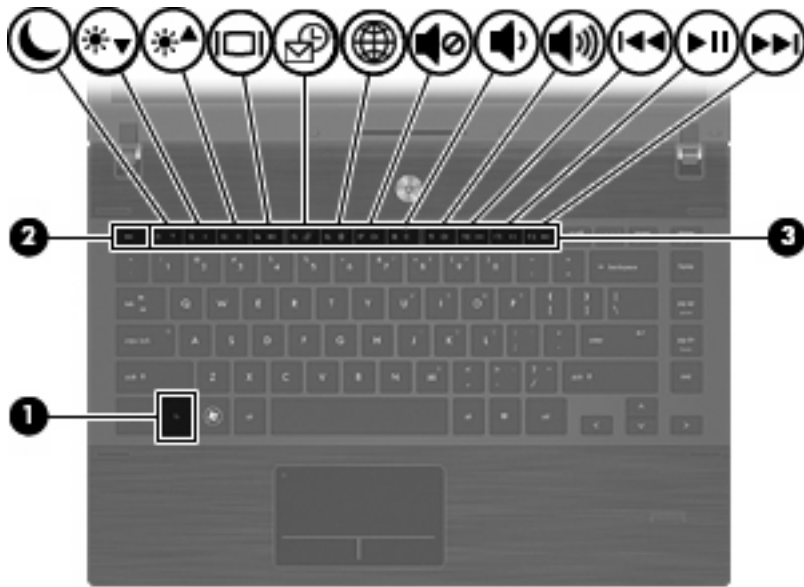

Function	Hotkey
Display system information.	<a href="#">fn+esc</a>
Initiate Sleep.	<a href="#">fn+f1</a>
Decrease screen brightness.	<a href="#">fn+f2</a>
Increase screen brightness.	<a href="#">fn+f3</a>
Switch the screen image.	<a href="#">fn+f4</a>
Open the default e-mail application.	<a href="#">fn+f5</a>
Open the default Web browser.	<a href="#">fn+f6</a>
Mute speaker sound.	<a href="#">fn+f7</a>
Decrease speaker sound.	<a href="#">fn+f8</a>
Increase speaker sound.	<a href="#">fn+f9</a>
Playing previous track.	<a href="#">fn+f10</a>
Playing, pausing, or resuming a CD, DVD, or BD.	<a href="#">fn+f11</a>
Playing next track.	<a href="#">fn+f12</a>

To use a hotkey command on the computer keyboard, follow either of these steps:

- Briefly press the [fn](#) key, and then briefly press the second key of the hotkey command.  
– or –
- Press and hold down the [fn](#) key, briefly press the second key of the hotkey command, and then release both keys at the same time.

## Displaying system information

Press **fn+esc** to display information about system hardware components and the system BIOS version number.

In the Windows **fn+esc** display, the version of the system BIOS (basic input-output system) is displayed as the BIOS date. On some computer models, the BIOS date is displayed in decimal format. The BIOS date is sometimes called the system ROM version number.

## Initiating Sleep

---

△ **CAUTION:** To reduce the risk of information loss, save your work before initiating Sleep.

---

Press **fn+f1** to initiate Sleep.

When Sleep is initiated, your information is stored in system memory, the screen is cleared, and power is conserved. While the computer is in the Sleep state, the power lights blink. The computer must be on before you can initiate Sleep.

📝 **NOTE:** If a critical battery level occurs while the computer is in the Sleep state, the computer initiates Hibernation and the information stored in memory is saved to the hard drive. The factory setting for critical battery action is Hibernate, but this setting can be changed using Power Options in Windows Control Panel.

---

To exit Sleep, briefly press the power button.

The function of the **fn+f1** hotkey can be changed. For example, you can set the **fn+f1** hotkey to initiate Hibernation instead of Sleep.

📝 **NOTE:** In all Windows operating system windows, references to the sleep button apply to the **fn+f1** hotkey.

---

## Decreasing screen brightness

Press **fn+f2** to decrease screen brightness. Hold down the hotkey to decrease the brightness level incrementally.

## Increasing screen brightness

Press **fn+f3** to increase screen brightness. Hold down the hotkey to increase the brightness level incrementally.

## Switching the screen image

Press **fn+f4** to switch the screen image among display devices connected to the system. For example, if a monitor is connected to the computer, pressing **fn+f4** alternates the screen image from computer display to monitor display to simultaneous display on both the computer and the monitor.

Most external monitors receive video information from the computer using the external VGA video standard. The **fn+f4** hotkey can also alternate images among other devices receiving video information from the computer.

The following video transmission types, with examples of devices that use them, are supported by the **fn+f4** hotkey:

- LCD (computer display)
- External VGA (most external monitors)

- HDMI (televisions, camcorders, DVD players, VCRs, and video capture cards with HDMI ports)
- Composite video (televisions, camcorders, DVD players, VCRs, and video capture cards with composite-video-in jacks)

 **NOTE:** Composite video devices can be connected to the system only by using an optional docking device.

---

## Opening the default e-mail application

Press **fn+f5** to open the default e-mail application.

## Opening the default Web browser

Press **fn+f6** to open the default Web browser.

## Muting speaker sound

Press **fn+f7** to mute speaker sound. Press the hotkey again to restore speaker sound.

## Decreasing speaker sound

Press **fn+f8** to decrease speaker volume. Hold down the hotkey to decrease speaker volume incrementally.

## Increasing speaker sound

Press **fn+f9** to increase speaker volume. Hold down the hotkey to increase speaker volume incrementally.

## Playing the previous track or section of an audio CD or a DVD

While an audio CD or a DVD is playing, press **fn+f10** to play the previous track of the CD or the previous section of the DVD.

## Playing, pausing, or resuming an audio CD or a DVD

The **fn+f11** hotkey functions only when an audio CD or a DVD is inserted.

- If the audio CD or the DVD is not playing, press **fn+f11** to begin or resume the play.
- If the audio CD or the DVD is playing, press **fn+f11** to pause the play.

## Playing the next track or section of an audio CD or a DVD

While an audio CD or a DVD is playing, press **fn+f12** to play the next track of the CD or the next section of the DVD.

## Using QuickLook

QuickLook allows you to save calendar, contact, inbox, and task information from Microsoft Outlook to the hard drive of your computer.

- ▲ Press **f5** when the computer is off or in Hibernation to open QuickLook. This allows you to view this information without waiting for the operating system to restart.

---

 **NOTE:** Pressing **f5** will not work when the computer is on or in Sleep mode.

---

Use QuickLook to manage contact information, calendar events, e-mail information, and tasks without restarting your computer.

HP DayStart is part of QuickLook, and it allows you to be immediately productive while Windows boots—displaying important meeting and conference call details along with the battery charge state. For more information, refer to the QuickLook and DayStart help.

## Using QuickWeb

QuickWeb is an instant-on environment that is separate from your Windows operating system. QuickWeb allows you to rapidly access a Web browser without the need to start Windows.

▲ Press **f6** when the computer is off or in Hibernation to open QuickWeb on your computer.

---

 **NOTE:** Pressing **f6** will not work when the computer is on or in Sleep mode.

---

## Using the embedded numeric keypad

The 15 keys of the embedded numeric keypad can be used like the keys on an external keypad. When the embedded numeric keypad is turned on, each key on the keypad performs the function indicated by the icon in the upper-right corner of the key.

### Enabling and disabling the embedded numeric keypad

Press **fn+num lk** to enable the embedded numeric keypad. Press **fn+num lk** again to return the keys to their standard keyboard functions.

---

 **NOTE:** The embedded numeric keypad will not function while an external keyboard or numeric keypad is connected to the computer.

---

### Switching key functions on the embedded numeric keypad

You can temporarily alternate the functions of keys on the embedded numeric keypad between their standard keyboard functions and their keypad functions by using the **fn** key or the **fn+shift** key combination.

- To change the function of a keypad key to keypad functions while the keypad is off, press and hold the **fn** key while pressing the keypad key.
- To use the keypad keys temporarily as standard keys while the keypad is on:
  - Press and hold the **fn** key to type in lowercase.
  - Press and hold **fn+shift** to type in uppercase.



## Using an optional external numeric keypad

Keys on most external numeric keypads function differently according to whether num lock is on or off. (Num lock is turned off at the factory.) For example:

- When num lock is on, most keypad keys type numbers.
- When num lock is off, most keypad keys function like the arrow, page up, or page down keys.

When num lock on an external keypad is turned on, the num lock light on the computer is turned on. When num lock on an external keypad is turned off, the num lock light on the computer is turned off.

To turn num lock on or off on an external keypad as you work:

- ▲ Press the **num lk** key on the external keypad, not on the computer.

## Cleaning the TouchPad and keyboard

Dirt and grease on the TouchPad can cause the pointer to jump around on the screen. To avoid this, clean the TouchPad with a damp cloth, and wash your hands frequently when using the computer.

---

⚠ **WARNING!** To reduce the risk of electric shock or damage to internal components, do not use a vacuum cleaner attachment to clean the keyboard. A vacuum cleaner can deposit household debris on the keyboard surface.

---

Clean the keyboard regularly to prevent keys from sticking and to remove dust, lint, and particles that can become trapped beneath the keys. A can of compressed air with a straw extension can be used to blow air around and under the keys to loosen and remove debris.



---

# 4 Multimedia

## Multimedia features

Your computer includes multimedia features that allow you to listen to music, watch movies, and view pictures. Your computer may include the following multimedia components:

- Optical drive for playing audio and video discs
- Integrated speakers for listening to music
- Integrated microphone for recording your own audio
- Integrated webcam that allows you to capture and share video
- Preinstalled multimedia software that allows you to play and manage your music, movies, and pictures
- Hotkeys that provide fast access to multimedia tasks

---

 **NOTE:** Your computer may not include all of the components listed.

---

The following sections explain how to identify and use the multimedia components included with your computer.

## Identifying your multimedia components

The following illustration and table describe the multimedia features of the computer.

---

 **NOTE:** Your computer may look slightly different from the illustration in this section.

---



Component	Description
(1) Internal microphone	Records sound.
(2) Webcam	Records video and captures still photographs.
(3) Speakers (2)	Produce sound.
(4) Audio-out (headphone) jack	Produces sound when connected to optional powered stereo speakers, headphones, ear buds, a headset, or television audio.  <b>NOTE:</b> When a device is connected to the headphone jack, the computer speakers are disabled.
(5) Audio-in (microphone) jack	Connects an optional computer headset microphone, stereo array microphone, or monaural microphone.

## Adjusting the volume

You can adjust the volume using the following controls:

- Computer volume keys:
  - To mute or restore volume, press and hold the **fn** key (1), and then press the mute key **f7** (2).
  - To decrease volume, press and hold the **fn** key (1), and then tap the volume down key **f8** (3) until the desired volume level is reached.

- To increase volume, press and hold the **fn** key (1), and then tap the volume up key **f9** (4) until the desired volume level is reached.

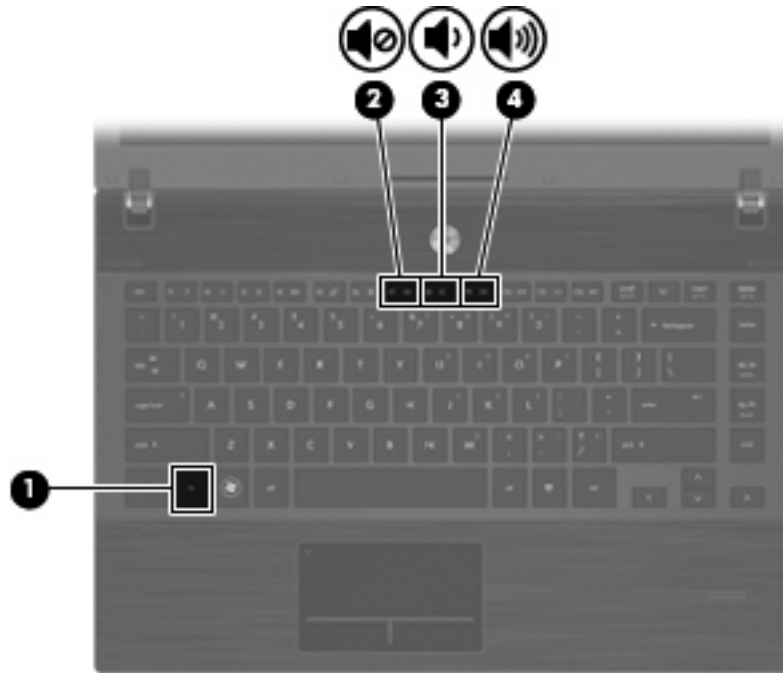

- Windows volume control:
  - a. Click the **Volume** icon in the notification area, at the far right of the taskbar.
  - b. Increase or decrease the volume by moving the slider up or down. Click the **Mute** icon to mute the volume.

– or –

  - a. Right-click the **Volume** icon in the notification area, and then click **Open Volume Mixer**.
  - b. In the Speakers column, you can increase or decrease the volume by moving the **Volume** slider up or down. You can also mute the volume by clicking the **Mute** icon.

If the Volume icon is not displayed in the notification area, follow these steps to add it:

  - a. Right-click in the notification area, and then click **Properties**.
  - b. Click the **Notification Area** tab.
  - c. Under System icons, select the **Volume** check box.
  - d. Click **OK**.
- Program volume control:

Volume can also be adjusted within some programs.

## Multimedia software

The computer includes preinstalled multimedia software. Some computer models also include additional multimedia software on an optical disc.

Depending on the hardware and software included with the computer, the following multimedia tasks may be supported:

- Playing digital media, including audio and video CDs, DVDs, and BDs, and Internet radio
- Creating or copying data CDs
- Creating, editing, and burning audio CDs
- Creating, editing, and burning a video or movie to a DVD or video CD

---

△ **CAUTION:** To prevent loss of information or damage to a disc, observe the following guidelines:

Before writing to a disc, connect the computer to a reliable external power source. Do not write to a disc while the computer is running on battery power.

Before writing to a disc, close all open programs except the disc software you are using.

Do not copy directly from a source disc to a destination disc or from a network drive to a destination disc. Instead, copy from a source disc or network drive to your hard drive, and then copy from your hard drive to the destination disc.

Do not use the computer keyboard or move the computer while the computer is writing to a disc. The write process is sensitive to vibration.

 **NOTE:** For information about using software included with the computer, refer to the software manufacturer's instructions that may be provided on disc, as online Help files, or on the software manufacturer's Web site.

---

## Opening preinstalled multimedia software

1. Select **Start > All Programs**.
2. Click the program that you want to open.

## Using multimedia software

1. Select **Start > All Programs**, and then open the multimedia program you want to use. For example, if you want to use Windows Media Player to play an audio CD, click **Windows Media Player**.

---

 **NOTE:** Some programs may be located in subfolders.

---

2. Insert the media disc, such as an audio CD, into the optical drive.
3. Follow the instructions on the screen.

– or –

1. Insert the media disc, such as an audio CD, into the optical drive.  
An AutoPlay dialog box opens.
2. Click a multimedia task from the list of tasks.

## Installing multimedia software from a disc

1. Insert the disc into the optical drive.
2. When the installation wizard opens, follow the on-screen instructions.
3. Restart the computer if prompted to do so.

# Audio

Your computer enables you to use a variety of audio features:

- Play music using your computer speakers and/or connected external speakers
- Record sound using the internal microphone or connect an external microphone
- Download music from the Internet
- Create multimedia presentations using audio and images
- Transmit sound and images with instant messaging programs
- Stream radio programs (select models only) or receive FM radio signals
- Create or “burn” audio CDs (select models only)

## Connecting external audio devices

---

 **WARNING!** To reduce the risk of personal injury, adjust the volume before putting on headphones, earbuds, or a headset. For additional safety information, refer to the *Regulatory, Safety and Environmental Notices*.

---

To connect external devices such as external speakers, headphones, or a microphone, refer to the information provided with the device. For best results, remember the following tips:

- Be sure that the device cable is securely connected to the correct jack on your computer. (Cable connectors are normally color-coded to match the corresponding jacks on the computer.)
- Be sure to install any drivers required by the external device.

---

 **NOTE:** A driver is a required program that acts like a translator between the device and the programs that use the device.

---

## Checking your audio functions

To check the system sound on your computer, follow these steps:

1. Right-click the Volume icon on the taskbar, and then select **Sounds**.  
– or –  
Select **Start > Control Panel > Hardware and Sound > Sound**.
2. When the Sound window opens, click the **Sounds** tab. Under **Program**, select any sound event, such as a beep or alarm, and click the **Test** button.

You should hear sound through the speakers or through connected headphones.

To check the record functions of the computer, follow these steps:

1. Select **Start > All Programs > Accessories > Sound Recorder**.
2. Click **Start Recording** and speak into the microphone. Save the file to your desktop.
3. Open Windows Media Player and play back the sound.



---

 **NOTE:** For best results when recording, speak directly into the microphone and record sound in a setting free of background noise.

---

- ▲ To confirm or change the audio settings on your computer, select **Start > Control Panel > Hardware and Sound > Sound**.

## Video

Your computer enables you to use a variety of video features:

- Watch movies
- Play games over the Internet
- Edit pictures and video to create presentations
- Connect external video devices

### Connecting an external monitor or projector

Your computer has an external monitor port that allows you to connect external monitors and projectors.

#### Using the external monitor port

The external monitor port connects an external display device, such as an external monitor or a projector, to the computer.

- ▲ To connect a display device, connect the device cable to the external monitor port.

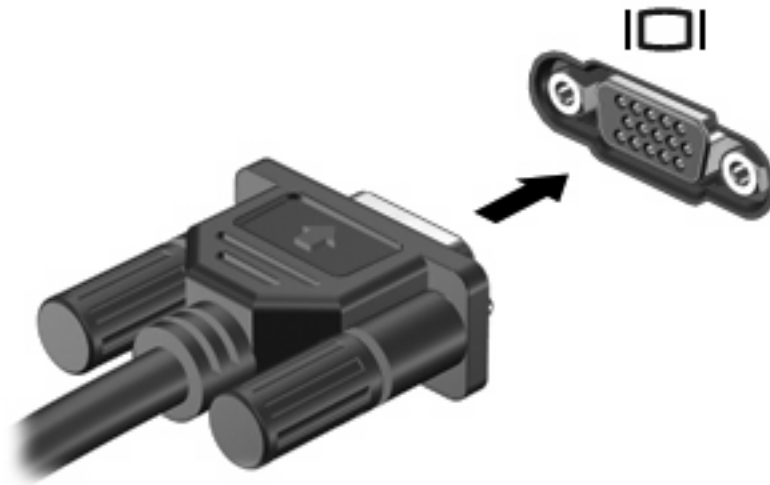

---

 **NOTE:** If a properly connected external display device does not display an image, press **fn+f4** to transfer the image to the device. Repeatedly pressing **fn+f4** alternates the screen image between the computer display and the device.

---

#### Using the HDMI port

Select computer models include an HDMI (High Definition Multimedia Interface) port. The HDMI port connects the computer to an optional video or audio device, such as a high-definition television, or any compatible digital or audio component.

The computer can support one HDMI device connected to the HDMI port, while simultaneously supporting an image on the computer display or any other supported external display.

---

 **NOTE:** To transmit video signals through the HDMI port, you need an HDMI cable (purchased separately), available from most electronics retailers.

---

To connect a video or audio device to the HDMI port:

1. Plug one end of the HDMI cable into the HDMI port on the computer.

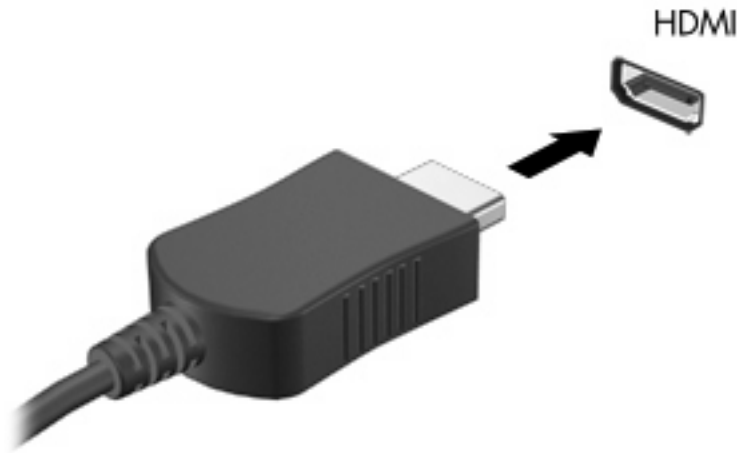

2. Connect the other end of the cable to the video device, according to the device manufacturer's instructions.
3. Press **fn+f4** to switch the image between the display devices connected to the computer.

## Configuring audio for HDMI

To configure HDMI audio, first connect an audio or video device, such as a high-definition TV, to the HDMI port on your computer. Then configure the default audio playback device as follows:

1. Right-click the **Speakers** icon in the notification area, at the far right of the taskbar, and then click **Playback devices**.
2. On the **Playback** tab, click either **Digital Output** or **Digital Output Device (HDMI)**.
3. Click **Set Default**, and then click **OK**.

To return audio to the computer speakers, follow these steps:

1. Right-click the **Speakers** icon in the notification area, at the far right of the taskbar, and then click **Playback devices**.
2. On the **Playback** tab, click **Speakers**.
3. Click **Set Default**, and then click **OK**.

## Optical drive (select models only)

Depending on the type of optical drive and software installed in your computer, the optical drive plays, copies, and creates CDs, DVDs, or BDs.

### Identifying the installed optical drive

▲ Select **Start > Computer**.

### Using optical discs (CDs, DVDs, and BDs)

An optical drive, such as a DVD-ROM drive, supports optical discs (CDs and DVDs). These discs store information, such as music, photos, and movies. DVDs have a higher storage capacity than CDs.

Your optical drive can read standard CD and DVD discs. If your optical drive is a Blu-ray Disc (BD) drive, it can also read BDs.

 **NOTE:** Some of the optical drives listed may not be supported by your computer. The listed drives are not necessarily all of the supported optical drives.

Some optical drives can also write to optical discs, as described in the following table.

Optical drive type	Write to CD-RW	Write to DVD±RW/R	Write to DVD±R DL	Write label to LightScribe CD or DVD ±RW/R	Write to BD R/RE
DVD-ROM Drive	No	No	No	No	No
DVD±R SuperMulti DL LightScribe Drive*†	Yes	Yes	Yes	Yes	No
Blu-ray ROM DVD±R SuperMulti DL Drive*	Yes	Yes	Yes	No	No
Blu-ray R/RE DVD+/-RW SuperMulti DL Drive*	Yes	Yes	Yes	No	Yes

\*Double-layer discs can store more data than single-layer discs. However, double-layer discs burned with this drive may not be compatible with many single-layer DVD drivers and players.

†LightScribe discs must be purchased separately. LightScribe creates a grayscale image similar to black-and-white photography.

△ **CAUTION:** To prevent possible audio and video degradation, loss of information, or loss of audio or video playback functionality, do not initiate Sleep or Hibernation while reading a CD, DVD, or BD, or writing to a CD or DVD.

### Selecting the right disc (CDs, DVDs, and BDs)

An optical drive supports optical discs (CDs, DVDs, and BDs). CDs, used to store digital data, are also used for commercial audio recordings and are convenient for your personal storage needs. DVDs and BDs are used primarily for movies, software, and data backup purposes. DVDs and BDs are the same form factor as CDs, but have a much higher storage capacity.

 **NOTE:** The optical drive on your computer may not support all the types of optical discs discussed in this section.

## CD-R discs

Use CD-R (write-once) discs to create permanent archives and to share files with virtually anyone. Typical uses include the following:

- Distributing large presentations
- Sharing scanned and digital photos, video clips, and written data
- Making your own music CDs
- Keeping permanent archives of computer files and scanned home records
- Offloading files from your hard drive to free up disk space

After data is recorded, it cannot be erased or written over.

## CD-RW discs

Use a CD-RW disc (a rewritable version of a CD) to store large projects that must be updated frequently. Typical uses include the following:

- Developing and maintaining large documents and project files
- Transporting work files
- Making weekly backups of hard drive files
- Updating photos, video, audio, and data continuously

## DVD±R discs

Use blank DVD±R discs to permanently store large amounts of information. After data is recorded, it cannot be erased or written over.

## DVD±RW discs

Use DVD±RW discs if you want to be able to erase or write over data that you saved earlier. This type of disc is ideal for testing audio or video recordings before you burn them to a CD or DVD that cannot be changed.

## LightScribe DVD+R discs

Use LightScribe DVD+R discs for sharing and storing data, home videos, and photos. These discs are read-compatible with most DVD-ROM drives and DVD video players. With a LightScribe-enabled drive and LightScribe software, you can write data to the disc and then add a designer label to the outside of the disc.

## Blu-ray Discs (BDs)

BD is a high-density optical disc format for the storage of digital information, including high-definition video. A single-layer Blu-ray Disc can store 25 GB, over 5 times the storage capacity of a single-layer DVD at 4.7 GB. A dual-layer Blu-ray Disc can store 50 GB, almost 6 times the storage capacity of a dual-layer DVD at 8.5 GB.

Typical uses include the following:

- Storage of large amounts of data
- High-definition video playback and storage
- Video games

 **NOTE:** As Blu-ray is a new format containing new technologies, certain disc, digital connection, compatibility and/or performance issues may arise, and do not constitute defects in the product. Flawless playback on all systems is not guaranteed.

## Playing a CD, DVD, or BD

1. Turn on the computer.
2. Press the release button **(1)** on the drive bezel to release the disc tray.
3. Pull out the tray **(2)**.
4. Hold the disc by the edges to avoid touching the flat surfaces and position the disc label-side up over the tray spindle.

 **NOTE:** If the tray is not fully accessible, tilt the disc carefully to position it over the spindle.

5. Gently press the disc **(3)** down onto the tray spindle until the disc snaps into place.

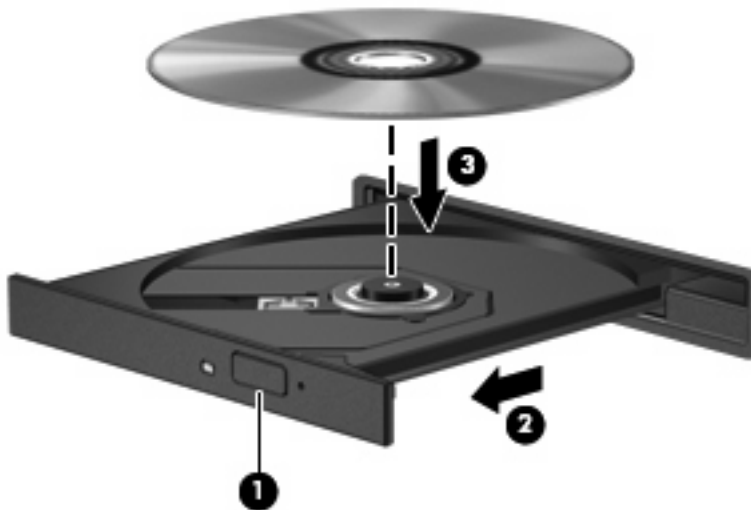

6. Close the disc tray.

If you have not yet configured AutoPlay, as described in the following section, an AutoPlay dialog box opens. It prompts you to select how you want to use the media content.

 **NOTE:** For best results, be sure that your AC adapter is plugged into an external power source while playing a BD.

## Configuring AutoPlay

1. Select **Start > Control Panel > Play CDs or other media automatically**.
2. Confirm that the **Use AutoPlay for all media and devices** check box is selected.

3. Click **Choose a default**, and then select one of the available options for each media type listed.

---

 **NOTE:** Choose WinDVD to play DVDs.

---

4. Click **Save**.

---

 **NOTE:** For more information about AutoPlay, select **Start > Help and Support**.

---

## Changing DVD region settings

Most DVDs that contain copyrighted files also contain region codes. The region codes help protect copyrights internationally.

You can play a DVD containing a region code only if the region code on the DVD matches the region setting on your DVD drive.

---

 **CAUTION:** The region settings on your DVD drive can be changed only 5 times.

The region setting you select the fifth time becomes the permanent region setting on the DVD drive.

The number of region changes remaining is displayed on the DVD Region tab.

---

To change settings through the operating system:

1. Select **Start > Computer > System properties**.
2. In the left pane, click **Device Manager**.

---

 **NOTE:** Windows includes the User Account Control feature to improve the security of your computer. You may be prompted for your permission or password for tasks such as installing software, running utilities, or changing Windows settings. Refer to Windows Help and Support for more information.

---

3. Click the plus sign (+) next to **DVD/CD-ROM drives**.
4. Right-click the DVD drive for which you want to change region settings, and then click **Properties**.
5. Make the desired changes on the **DVD Region** tab.
6. Click **OK**.

## Observing the copyright warning

It is a criminal offense, under applicable copyright laws, to make unauthorized copies of copyright-protected material, including computer programs, films, broadcasts, and sound recordings. Do not use this computer for such purposes.

## Copying a CD or DVD

1. Select **Start > All Programs > ArcSoft > Creator Business**.
2. In the right pane, click **Copy Disc**.
3. Insert the disc you want to copy into the optical drive.
4. Click **Copy** at the bottom right of the screen.

Creator Business reads the source disc and copies the data to a temporary folder on your hard drive.

5. When prompted, remove the source disc from the optical drive and insert a blank disc into the drive.

After the information is copied, the disc you created is ejected automatically.

## Creating (burning) a CD, DVD, or BD

△ **CAUTION:** Observe the copyright warning. It is a criminal offense, under applicable copyright laws, to make unauthorized copies of copyright-protected material, including computer programs, films, broadcasts, and sound recordings. Do not use this computer for such purposes.

If your optical drive is a CD-RW, DVD-RW, or DVD±RW optical drive, you can use software such as Windows Media Player to burn data and audio files, including MP3 and WAV music files.

Observe the following guidelines when burning a CD, DVD, or BD:

- Before burning a disc, save and close any open files and close all programs.
- A CD-R or DVD-R is usually best for burning audio files because after the information is copied, it cannot be changed.
- Because some home and car stereos will not play CD-RWs, use CD-Rs to burn music CDs.
- A CD-RW or DVD-RW is generally best for burning data files or for testing audio or video recordings before you burn them to a CD or DVD that cannot be changed.
- DVD players used in home systems usually do not support all DVD formats. Refer to the user guide that came with your DVD player for a list of supported formats.
- An MP3 file uses less space than other music file formats, and the process for creating an MP3 disc is the same as the process for creating a data file. MP3 files can be played only on MP3 players or on computers with MP3 software installed.

To burn a CD, DVD, or BD, follow these steps:

1. Download or copy the source files into a folder on your hard drive.
2. Insert a blank disc into the optical drive.
3. Select **Start > All Programs** and the name of the software you want to use.
4. Select the kind of disc you want to create—data, audio, or video.
5. Right-click **Start**, click **Open Windows Explorer**, and then navigate to the folder where the source files are stored.
6. Open the folder, and then drag the files to the drive that contains the blank disc.
7. Initiate the burning process as directed by the program you have selected.

For specific instructions, refer to the software manufacturer's instructions. These instructions may be provided with the software, on disc, or on the manufacturer's Web site.

## Removing an optical disc (CD, DVD, or BD)

1. Press the release button **(1)** on the drive bezel to release the disc tray, and then gently pull out the tray **(2)** until it stops.



2. Remove the disc **(3)** from the tray by gently pressing down on the spindle while lifting the outer edges of the disc. Hold the disc by the edges and avoid touching the flat surfaces.

 **NOTE:** If the tray is not fully accessible, tilt the disc carefully as you remove it.

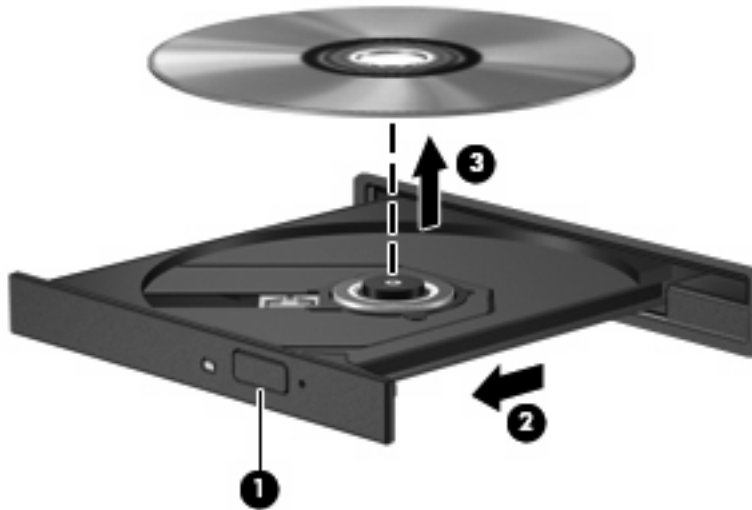

3. Close the disc tray and place the disc in a protective case.

## Troubleshooting

The following sections describe several common issues and resolutions.

### The optical disc tray does not open for removal of a CD, DVD, or BD

1. Insert the end of a paper clip **(1)** into the release access in the front bezel of the drive.
2. Press in gently on the paper clip until the disc tray is released, and then pull out the tray **(2)** until it stops.

3. Remove the disc (3) from the tray by gently pressing down on the spindle while lifting the outer edges of the disc. Hold the disc by the edges and avoid touching the flat surfaces.

 **NOTE:** If the tray is not fully accessible, tilt the disc carefully as you remove it.

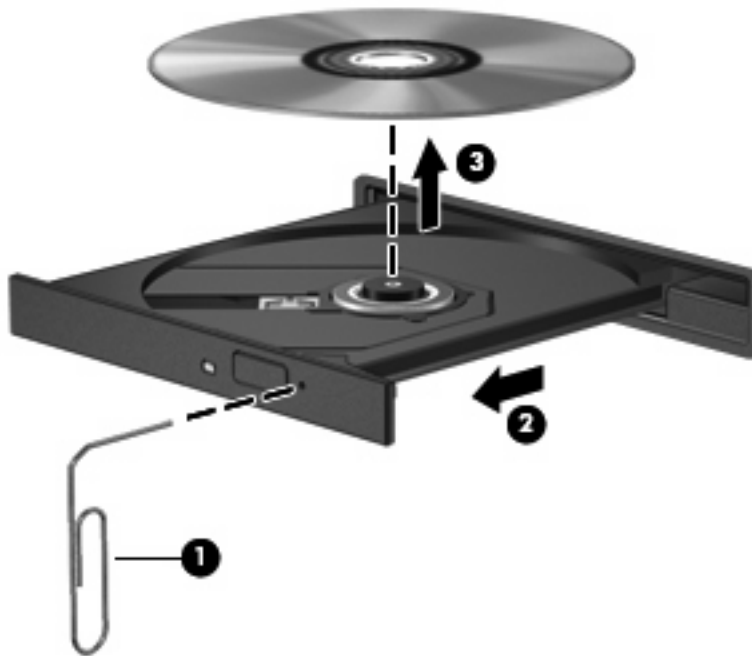

4. Close the disc tray and place the disc in a protective case.

### The computer does not detect the optical drive

If Windows does not detect an attached device, the device driver software may be missing or corrupted. If you suspect that the DVD/CD-ROM drive is not being detected, verify that the optical drive is listed in the Device Manager utility.

1. Remove any discs from the optical drive.
2. Select **Start > Control Panel > System and Maintenance > Device Manager**. If prompted by User Account Control, click **Continue**.
3. In the Device Manager window, click the plus sign (+) next to **Discs Drives** or **DVD/CD-ROM drives**, unless a minus sign (-) is already showing. Look for an optical drive listing.
4. Right-click the optical device listing to perform the following tasks:
  - Update the driver.
  - Uninstall the device.
  - Scan for hardware changes. Windows scans your system for installed hardware and installs any required default drivers.
  - Click **Properties** to see if the device is working properly.
    - Click **Troubleshoot** to fix problems.
    - Click the **Driver** tab to update, disable, or uninstall drivers for this device.

## Preventing playback disruptions

To reduce the possibility of playback disruption:

- Save your work and close all open programs before playing a CD, DVD, or BD.
- Do not connect or disconnect hardware while playing a disc.

Do not initiate Hibernation or Sleep while playing a disc. Otherwise, you may see a warning message asking if you want to continue. If this message is displayed, click **No**. After you click No, the computer may behave in either of the following ways:

- Playback may resume.  
– or –
- The playback window in the multimedia program may close. To return to playing the CD, DVD, or BD, click the **Play** button in your multimedia program to restart the disc. In rare cases, you may need to exit the program and then restart it.

## A disc does not play

- Save your work and close all open programs before playing a CD, DVD, or BD.
- Log off the Internet before playing a CD, DVD, or BD.
- Be sure that you insert the disc properly.
- Be sure that the disc is clean. If necessary, clean the disc with filtered water and a lint-free cloth. Wipe from the center of the disc to the outer edge.
- Check the disc for scratches. If you find scratches, treat the disc with an optical disc repair kit available at many electronics stores.
- Disable Sleep mode before playing the disc.

Do not initiate Hibernation or Sleep while playing a disc. Otherwise, you may see a warning message asking if you want to continue. If this message is displayed, click **No**. After you click No, the computer may behave in either of the following ways:

- Playback may resume.  
– or –
- The playback window in the multimedia program may close. To return to playing the disc, click the **Play** button in your multimedia program to restart the disc. In rare cases, you may need to exit the program and then restart it.
- Increase system resources:

Turn off external devices such as printers and scanners. Disconnecting these devices frees up valuable system resources and results in better playback performance.

Change desktop color properties. Because the human eye cannot easily tell the difference between colors beyond 16 bits, you should not notice any loss of color while watching a movie if you lower system color properties to 16-bit color, as follows:

1. Right-click anywhere on the desktop except on an icon, and then select **Personalize > Display Settings**.
2. Set **Colors** to **Medium (16 bit)**.

### A disc does not play automatically

1. Select **Start > Control Panel > Play CDs or other media automatically**.
2. Confirm that the **Use AutoPlay for all media and devices** check box is selected.
3. Click **Save**.

A CD, DVD, or BD should now start automatically when it is inserted into the optical drive.

### A movie stops, skips, or plays erratically

- Clean the disc.
- Conserve system resources by trying the following suggestions:
  - Log off the Internet.
  - Change the color properties of the desktop:
    1. Right-click on a blank area of the computer desktop, and then select **Personalize > Display Settings**.
    2. Set **Colors** to **Medium (16 bit)**, if this setting is not already selected.
  - Disconnect external devices, such as a printer, scanner, camera, or handheld device.

### A movie is not visible on an external display

1. If both the computer display and an external display are turned on, press **fn+f4** one or more times to switch between the two displays.
2. Configure the monitor settings to make the external display primary:
  - a. Right-click on a blank area of the computer desktop, and then select **Personalize > Display Settings**.
  - b. Specify a primary display and a secondary display.

---

 **NOTE:** When using both displays, the DVD image will not appear on any display designated as the secondary display.

---

To get information about a multimedia question not covered in this guide, select **Start > Help and Support**.

### The process of burning a disc does not begin, or it stops before completion

- Be sure that all other programs are closed.
- Turn off Sleep mode and Hibernation.

- Be sure that you are using the right kind of disc for your drive. See your user guides for more information about disc types.
- Be sure that the disc is inserted properly.
- Select a slower write speed and try again.
- If you are copying a disc, save the information on the source disc to your hard drive before trying to burn the contents to a new disc, and then burn from your hard drive.
- Reinstall the disc-burning device driver located in the DVD/CD-ROM drives category in Device Manager.

## A device driver must be reinstalled

1. Remove any discs from the optical drive.
2. Click **Start** and type `device manager` in the **Start Search** box.  
As you type, search results are listed in the pane above the box.
3. In the results pane, click **Device Manager**. If prompted by User Account Control, click **Continue**.
4. In the Device Manager window, click the plus sign (+) next to the type of driver you want to uninstall and reinstall (for example, DVD/CD-ROMs, Modems, and so on), unless a minus sign (-) is already showing.
5. Click a listed driver, and press the `delete` key. When prompted, confirm that you want to delete the driver, but do not restart the computer.

Repeat for any other drivers you want to delete.

6. In the Device Manager window, click the **Scan for hardware changes** icon in the toolbar. Windows scans your system for installed hardware and installs default drivers for anything requiring drivers.

---

 **NOTE:** If you are prompted to restart the computer, save all open files, and then continue with the restart.

---

7. Reopen Device Manager, if necessary, and then verify that the drivers are once again listed.
8. Try to use your device.

If uninstalling and reinstalling the default device drivers does not correct the problem, you may need to update your drivers using the procedures in the following section.

## Obtaining the latest HP device drivers

Follow either of the following procedures to obtain HP device drivers.

To use the HP Update Utility:

1. Select **Start > All Programs > HP > HP Update**.
2. On the HP Welcome screen, click **Settings**, and then select a time when the utility should check for software updates on the Web.
3. Click **Next** to immediately check for HP software updates.

To use the HP Web site:

1. Open your Internet browser, go to <http://www.hp.com/support>, and then select your country or region.
2. Click the option for software and driver downloads, and then type your computer model number in the product box.
3. Press **enter**, and then follow the on-screen instructions.

### Obtaining Microsoft device drivers

You can obtain the latest Windows device drivers by using Microsoft® Update. This Windows feature can be set to automatically check for and install updates for your hardware drivers, as well as for the Windows operating system and other Microsoft products.

To use Microsoft Update:

1. Open your Internet browser, go to <http://www.microsoft.com>, and click **Security & Updates**.
2. Click **Microsoft Update** to get the latest updates for your computer operating system, programs, and hardware.
3. Follow the on-screen instructions to install Microsoft Update. If prompted by User Account Control, click **Continue**.
4. Click **Change settings**, and then select a time for Microsoft Update to check for updates to the Windows operating system and other Microsoft products.
5. If prompted to do so, restart your computer.

# Webcam

 **NOTE:** This section describes features that are common to most models. Some features may not be available on your computer.

---

Your computer includes an integrated webcam, located at the top of the display. With the preinstalled software, you can use the webcam to take a photo, record a video, or make an audio recording. You can preview the photo, video recording, or audio recording, and save it on your computer hard drive.

To access the webcam and software, select **Start > All Programs > ArcSoft TotalMedia Suite > WebCam Companion**.

The webcam software enables you to experiment with the following features:

- Video—Record and play back webcam video.
- Audio—Record and play back audio.
- Streaming video—Use with instant message software solutions that support UVC (Universal Video Class) cameras.
- Snapshots—Take still photos.
- HP Business Card Reader (select models only)—Use to transform business cards into a usable database of contact information.

## Webcam tips

For optimum performance, observe the following guidelines while using the webcam:

- Be sure that you have the latest version of an instant message program before starting a video conversation.
- The webcam may not work properly across some network firewalls.

 **NOTE:** If you are having trouble viewing or sending multimedia files to someone on another LAN or outside your network firewall, temporarily disable the firewall, perform the task you want to perform, and then reenables the firewall. To permanently resolve the problem, reconfigure the firewall as necessary, and adjust the policies and settings of other intrusion detection systems. For additional information, contact your network administrator or IT department.

---

- Whenever possible, place bright light sources behind the webcam and out of the picture area.

 **NOTE:** For details about using your webcam, click the **Help** menu in the webcam software Help.

---

## Adjusting webcam properties

You can adjust webcam properties using the Properties dialog box, which is accessible from various programs that use the integrated webcam, usually from a configuration, settings, or properties menu:

- **Brightness**—Controls the amount of light that is incorporated into the image. A higher brightness setting creates a brighter image; a lower brightness setting creates a darker image.
- **Contrast**—Controls the difference between lighter and darker areas on the image. A higher contrast setting intensifies the image; a lower contrast setting maintains more of the original information's dynamic range, but leads to a flatter image.

- **Hue**—Controls the aspect of color that distinguishes it from another color (what makes a color red, green, or blue). Hue is distinct from saturation, which measures the intensity of the hue.
- **Saturation**—Controls the strength of color in the final image. A higher saturation setting creates a bolder image; a lower saturation setting creates a more subtle image.
- **Sharpness**—Controls the definition of edges in an image. A higher sharpness setting creates a more defined image; a lower sharpness setting creates a softer image.
- **Gamma**—Controls the contrast affecting the mid-level grays or midtones of an image. Adjusting the gamma of an image allows you to change the brightness values of the middle range of gray tones without dramatically altering the shadows and highlights. A lower gamma setting makes grays look black, and makes dark colors even darker.

For information about using the webcam, select **Start > Help and Support**.



---

# 5 Power management

## Setting power options

### Using power-saving states

The computer has two power-saving states enabled at the factory: Sleep and Hibernation.

When Sleep is initiated, the power lights blink and the screen clears. Your work is saved to memory. Exiting Sleep is faster than exiting Hibernation. If the computer is in the Sleep state for an extended period or if the battery reaches a critical battery level while in the Sleep state, the computer initiates Hibernation.

When Hibernation is initiated, your work is saved to a hibernation file on the hard drive and the computer turns off.

---

△ **CAUTION:** To prevent possible audio and video degradation, loss of audio or video playback functionality, or loss of information, do not initiate Sleep or Hibernation while reading from or writing to a disc or an external media card.

📝 **NOTE:** You cannot initiate any type of networking connection or perform any computer functions while the computer is in the Sleep state or in Hibernation.

**NOTE:** When HP 3D DriveGuard has parked a drive, the computer will not initiate Sleep or Hibernation, and the display will be turned off.

---

### Initiating and exiting Sleep

The system is set at the factory to initiate Sleep after 15 minutes of inactivity when running on battery power and 30 minutes of inactivity when running on external power.

Power settings and timeouts can be changed using Power Options in Windows Control Panel.

With the computer on, you can initiate Sleep in any of the following ways:

- Click **Start**, and then click the **Power** button.
- Click **Start**, click the arrow next to the Lock button, and then click **Sleep**.

To exit Sleep:

- ▲ Briefly press the power button.

When the computer exits Sleep, the power lights turn on and your work returns to the screen where you stopped working.

 **NOTE:** If you have set a password to be required when the computer exits Sleep, you must enter your Windows password before your work will return to the screen.

---

## Initiating and exiting Hibernation

The system is set at the factory to initiate Hibernation after 1080 minutes (18 hours) of inactivity when running on battery power, 1080 minutes (18 hours) of inactivity when running on external power, or when the battery reaches a critical battery level.

Power settings and timeouts can be changed using Power Options in Windows Control Panel.

To initiate Hibernation:

1. Click **Start**, and then click the arrow next to the Lock button.
2. Click **Hibernate**.

To exit Hibernation:

- ▲ Briefly press the power button.

The power lights turn on and your work returns to the screen where you stopped working.

 **NOTE:** If you have set a password to be required when the computer exits Hibernation, you must enter your Windows password before your work will return to the screen.

---

## Using the battery meter

The battery meter is located in the notification area, at the far right of the taskbar. The battery meter allows you to quickly access power settings, view remaining battery charge, and select a different power plan.

- To display the percentage of remaining battery charge and the current power plan, move the pointer over the battery meter icon.
- To access Power Options, or to change the power plan, click the battery meter icon and select an item from the list.

Different battery meter icons indicate whether the computer is running on battery or external power. The icon also displays a message if the battery has reached a critical battery level.

To hide or display the battery meter icon:

1. Right-click the taskbar, and then click **Properties**.
2. Click the **Notification Area** tab.
3. Under **System icons**, clear the **Power** check box to hide the battery meter icon, or select the **Power** check box to display the battery meter icon.
4. Click **OK**.

## Using power plans

A power plan is a collection of system settings that manages how the computer uses power. Power plans can help you conserve power or maximize performance.

You can change power plan settings or create your own power plan.

## Viewing the current power plan

- ▲ Move the pointer over the battery meter icon in the notification area, at the far right of the taskbar.  
– or –  
Select **Start > Control Panel > System and Maintenance > Power Options**.

## Selecting a different power plan

- ▲ Click the battery meter icon in the notification area, and then select a power plan from the list.  
– or –  
Select **Start > Control Panel > System and Maintenance > Power Options**, and then select a power plan from the list.

## Customizing power plans

1. Click the battery meter icon in the notification area and then click **More power options**.  
– or –  
Select **Start > Control Panel > System and Maintenance > Power Options**.
2. Select a power plan, and then click **Change plan settings**.
3. Change the **Turn off the display** and **Put the computer to sleep** timeout settings, as needed.
4. To change additional settings, click **Change advanced power settings** and make your changes.

## Setting password protection on wakeup

To set the computer to prompt for a password when the computer exits Sleep or Hibernation, follow these steps:

1. Select **Start > Control Panel > System and Maintenance > Power Options**.
2. In the left pane, click **Require a password on wakeup**.
3. Click **Change Settings that are currently unavailable**.
4. Click **Require a password (recommended)**.
5. Click **Save changes**.

## Using external AC power

External AC power is supplied through one of the following devices:

---

⚠ **WARNING!** To reduce potential safety issues, use only the AC adapter provided with the computer, a replacement AC adapter provided by HP, or a compatible AC adapter purchased from HP.

---

- Approved AC adapter
- Optional docking device or expansion product

Connect the computer to external AC power under any of the following conditions:

---

⚠ **WARNING!** Do not charge the computer battery while you are onboard an aircraft.

---

- When you are charging or calibrating a battery
- When you are installing or modifying system software
- When you are writing information to a CD, DVD, or BD

When you connect the computer to external AC power, the following events occur:

- The battery begins to charge.
- If the computer is turned on, the battery meter icon in the notification area changes appearance.

When you disconnect external AC power, the following events occur:

- The computer switches to battery power.
- The display brightness is automatically decreased to save battery life. To increase display brightness, press the **fn+f3** hotkey or reconnect the AC adapter.

## Connecting the AC adapter

---

⚠ **WARNING!** To reduce the risk of electric shock or damage to the equipment:

---

Plug the power cord into an AC outlet that is easily accessible at all times.

Disconnect power from the computer by unplugging the power cord from the AC outlet (not by unplugging the power cord from the computer).

If provided with a 3-pin attachment plug on the power cord, plug the cord into a grounded (earthed) 3-pin outlet. Do not disable the power cord grounding pin, for example, by attaching a 2-pin adapter. The grounding pin is an important safety feature.

---

To connect the computer to external AC power:

1. Plug the AC adapter into the power connector **(1)** on the computer.
2. Plug the power cord into the AC adapter **(2)**.

3. Plug the other end of the power cord into an AC outlet (3).

 **NOTE:** Your computer may look slightly different from the illustration in this section.

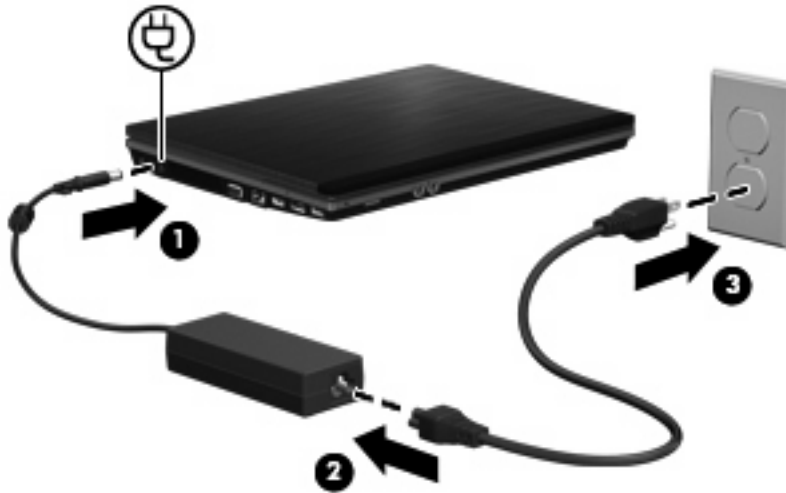

## Using battery power

When a charged battery is in the computer and the computer is not plugged into external power, the computer runs on battery power. When the computer is plugged into external AC power, the computer runs on AC power.

If the computer contains a charged battery and is running on external AC power supplied through the AC adapter, the computer switches to battery power if the AC adapter is disconnected from the computer.

 **NOTE:** The display brightness is decreased to save battery life when you disconnect AC power. To increase display brightness, use the **fn+f3** hotkey or reconnect the AC adapter.

You can keep a battery in the computer or in storage, depending on how you work. Keeping the battery in the computer whenever the computer is plugged into AC power charges the battery and also protects your work in case of a power outage. However, a battery in the computer slowly discharges when the computer is off and unplugged from external power.

 **WARNING!** To reduce potential safety issues, use only the battery provided with the computer, a replacement battery provided by HP, or a compatible battery purchased from HP.

Computer battery life varies, depending on power management settings, programs running on the computer, display brightness, external devices connected to the computer, and other factors.

## Finding battery information in Help and Support

The Battery information section of the Help and Support Learning Center provides the following tools and information:

- Battery Check tool to test battery performance
- Information on calibration, power management, and proper care and storage to maximize battery life
- Information on battery types, specifications, life cycles, and capacity

To access Battery information:

- ▲ Select **Start > Help and Support > Learning centers**. Scroll to the battery information once HP Support Assistant opens.

## Using Battery Check

Battery Check provides information on the status of the battery installed in the computer.

To run Battery Check:

1. Connect the AC adapter to the computer.

 **NOTE:** The computer must be connected to external power for Battery Check to function properly.

2. Select **Start > Help and Support > Troubleshoot > Power, Thermal and Mechanical**, and then click the **Power** tab.

Battery Check examines the battery and its cells to see if they are functioning properly, and then reports the results of the examination.

## Displaying the remaining battery charge

- ▲ Move the pointer over the battery meter icon in the notification area, at the far right of the taskbar.

– or –

View the estimated number of minutes of battery charge remaining in Windows Mobility Center:

- ▲ Click the battery meter icon, and then click **Windows Mobility Center**.

– or –

Select **Start > Control Panel > Mobile PC > Windows Mobility Center**.

The time shown indicates the approximate running time remaining on the battery *if the battery continues to provide power at the current level*. For example, the time remaining will decrease when a DVD is playing and will increase when a DVD stops playing.

## Inserting or removing the battery

- △ **CAUTION:** Removing a battery that is the sole power source can cause loss of information. To prevent loss of information, save your work, and initiate Hibernation or shut down the computer through Windows before removing the battery.

To insert the battery:

1. Turn the computer upside down on a flat surface, with the battery bay toward you.

2. Insert the battery into the battery bay (1) until it is seated.

The battery release latches (2) automatically lock the battery into place.

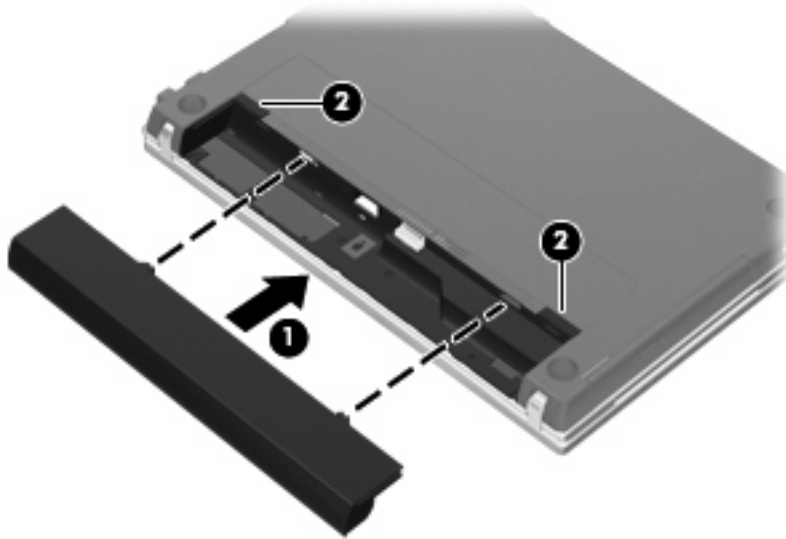

To remove the battery:

1. Turn the computer upside down on a flat surface, with the battery bay toward you.
2. Slide the battery release latches (1) to release the battery.
3. Remove the battery (2).

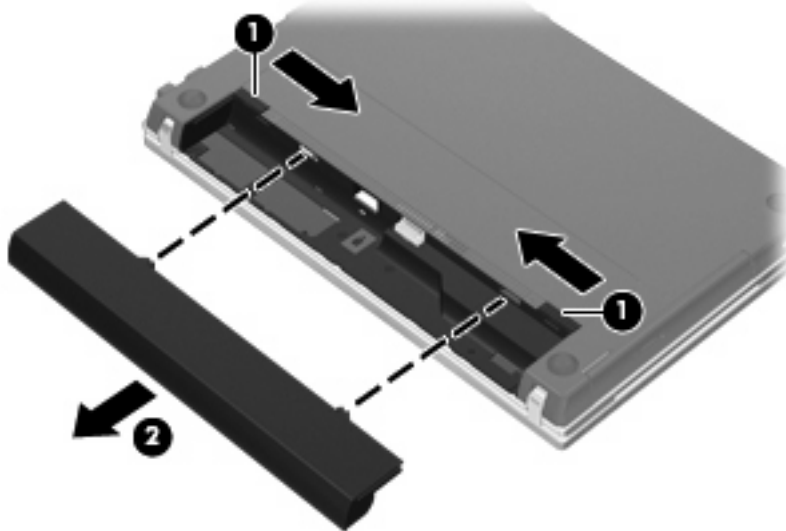

## Charging a battery

⚠ **WARNING!** Do not charge the computer battery while you are onboard aircraft.

The battery charges whenever the computer is plugged into external power through an AC adapter, an optional power adapter, an optional expansion product, or an optional docking device.

The battery charges whether the computer is off or in use, but it charges faster when the computer is off.

Charging may take longer if a battery is new, has been unused for 2 weeks or more, or is much warmer or cooler than room temperature.

To prolong battery life and optimize the accuracy of battery charge displays, follow these recommendations:

- If you are charging a new battery, charge it fully before turning on the computer.
- Charge the battery until the battery light turns off.

---

 **NOTE:** If the computer is on while the battery is charging, the battery meter in the notification area may show 100 percent charge before the battery is fully charged.

---

- Allow the battery to discharge below 5 percent of a full charge through normal use before charging it.
- If the battery has been unused for one month or more, calibrate the battery instead of simply charging it.

The battery light displays charge status:

- On: The battery is charging.
- Blinking: The battery has reached a low battery level or critical battery level and is not charging.
- Off: The battery is fully charged, in use, or not installed.

## Maximizing battery discharge time

Battery discharge time varies, depending on the features you use while on battery power. Maximum discharge time gradually shortens as the battery storage capacity naturally degrades.

Tips for maximizing battery discharge time:

- Lower the brightness on the display.
- Check the **Power saver** setting in Power Options.
- Remove the battery from the computer when it is not being used or charged.
- Store the battery in a cool, dry location.

## Managing low battery levels

The information in this section describes the alerts and system responses set at the factory. Some low-battery alerts and system responses can be changed using Power Options in Windows Control Panel. Preferences set using Power Options do not affect lights.

### Identifying low battery levels

When a battery that is the sole power source for the computer reaches a low battery level, the battery light blinks.

If a low battery level is not resolved, the computer enters a critical battery level, and the battery light blinks rapidly.



The computer takes the following actions for a critical battery level:

- If Hibernation is enabled and the computer is on or in the Sleep state, the computer initiates Hibernation.
- If Hibernation is disabled and the computer is on or in the Sleep state, the computer remains briefly in the Sleep state, and then shuts down and loses any unsaved information.

## Resolving a low battery level

---

△ **CAUTION:** To reduce the risk of losing information when the computer reaches a critical battery level and has initiated Hibernation, do not restore power until the power lights turn off.

---

### Resolving a low battery level when external power is available

- ▲ Connect one of the following devices:
  - AC adapter
  - Optional expansion product or docking device
  - Optional power adapter

### Resolving a low battery level when a charged battery is available

1. Turn off the computer or initiate Hibernation.
2. Remove the discharged battery, and then insert a charged battery.
3. Turn on the computer.

### Resolving a low battery level when no power source is available

- ▲ Initiate Hibernation.
  - or –
  - Save your work and shut down the computer.

### Resolving a low battery level when the computer cannot exit Hibernation

When the computer lacks sufficient power to exit Hibernation, follow these steps:

1. Insert a charged battery or plug the computer into external power.
2. Exit Hibernation by briefly pressing the power button.

## Calibrating a battery

Calibrate a battery under the following conditions:

- When battery charge displays seem inaccurate
- When you observe a significant change in battery run time

Even if a battery is heavily used, it should not need to be calibrated more than once a month. It is also not necessary to calibrate a new battery.

### Step 1: Fully charge the battery

---

⚠ **WARNING!** Do not charge the computer battery while you are onboard aircraft.

📝 **NOTE:** The battery charges whether the computer is off or in use, but it charges faster when the computer is off.

---

To fully charge the battery:

1. Insert the battery into the computer.
2. Connect the computer to an AC adapter, optional power adapter, optional expansion product, or optional docking device, and then plug the adapter or device into external power.

The battery light on the computer turns on.

3. Leave the computer plugged into external power until the battery is fully charged.

The battery light on the computer turns off.

## Step 2: Disable Hibernation and Sleep

1. Click the battery meter icon in the notification area, and then click **More power options**.

– or –

Select **Start > Control Panel > System and Maintenance > Power Options**.

2. Under the current power plan, click **Change plan settings**.
3. Record the **Turn off the display** and **Put the computer to sleep** settings listed in the **On battery** column so that you can reset them after the calibration.
4. Change the **Turn off the display** and **Put the computer to sleep** settings to **Never**.
5. Click **Change advanced power settings**.
6. Click the plus sign next to **Sleep**, and then click the plus sign next to **Hibernate after**.
7. Record the **On battery** setting under **Hibernate after** so that you can reset it after the calibration.
8. Change the **On battery** setting to **Never**.
9. Click **OK**.
10. Click **Save changes**.

## Step 3: Discharge the battery

The computer must remain on while the battery is being discharged. The battery can discharge whether or not you are using the computer, but the battery will discharge faster while you are using it.

- If you plan to leave the computer unattended during the discharge, save your information before beginning the discharge procedure.
- If you use the computer occasionally during the discharge procedure and have set energy-saving timeouts, expect the following performance from the system during the discharge process:
  - The monitor will not turn off automatically.
  - Hard drive speed will not decrease automatically when the computer is idle.
  - System-initiated Hibernation will not occur.

To discharge a battery:

1. Unplug the computer from its external power source, but do *not* turn off the computer.
2. Run the computer on battery power until the battery is discharged. The battery light begins to blink when the battery has discharged to a low battery level. When the battery is discharged, the battery light turns off, and the computer shuts down.

## Step 4: Fully recharge the battery

To recharge the battery:

1. Plug the computer into external power and maintain external power until the battery is fully recharged. When the battery is recharged, the battery light on the computer turns off.

You can use the computer while the battery is recharging, but the battery will charge faster if the computer is off.

2. If the computer is off, turn it on when the battery is fully charged and the battery light has turned off.

## Step 5: Reenable Hibernation and Sleep

**CAUTION:** Failure to reenable Hibernation after calibration may result in a full battery discharge and information loss if the computer reaches a critical battery level.

1. Click the battery meter icon in the notification area, and then click **More power options**.

– or –

Select **Start > Control Panel > System and Maintenance > Power Options**.

2. Under the current power plan, click **Change plan settings**.
3. Reenter the settings that you recorded for the items in the **On battery** column.
4. Click **Change advanced power settings**.
5. Click the plus sign next to **Sleep**, and then click the plus sign next to **Hibernate after**.
6. Reenter the setting that you recorded for **On battery**.
7. Click **OK**.
8. Click **Save changes**.

## Conserving battery power

- Select low power-use settings through Power Options in Windows Control Panel.
- Turn off wireless and local area network (LAN) connections and exit modem applications when you are not using them.
- Disconnect external devices that are not plugged into an external power source, when you are not using them.
- Stop, disable, or remove any external media cards that you are not using.
- Use the **fn+f2** and **fn+f3** hotkeys to adjust screen brightness as needed.
- If you leave your work, initiate Sleep or Hibernation, or shut down the computer.

## Storing a battery

**CAUTION:** To prevent damage to a battery, do not expose it to high temperatures for extended periods of time.

If a computer will be unused and unplugged from external power for more than 2 weeks, remove the battery and store it separately.

To prolong the charge of a stored battery, place it in a cool, dry place.

 **NOTE:** A stored battery should be checked every six months. If the capacity is less than 50 percent, recharge the battery before returning it to storage.

---

Calibrate a battery before using it if it has been stored for one month or more.

## Disposing of a used battery

 **WARNING!** To reduce the risk of fire or burns, do not disassemble, crush, or puncture a battery; short the external contacts on a battery; or dispose of a battery in fire or water. Do not expose a battery to temperatures above 60°C (140°F). Replace the battery only with a battery approved for this computer.

---

Refer to the *Regulatory, Safety and Environmental Notices* for battery disposal information.

## Replacing the battery

Computer battery life varies, depending on the power management settings, programs running on the computer, display brightness, external devices connected to the computer, and other factors.

Battery Check notifies you to replace the battery when an internal cell is not charging properly, or when the battery storage capacity has reached a “weak” condition. A message refers you to the HP Web site for more information about ordering a replacement battery. If the battery is possibly covered by an HP warranty, instructions include a warranty ID.

 **NOTE:** To ensure that you always have battery power when you need it, HP recommends purchasing a new battery when the storage capacity indicator turns green-yellow.

---

## Testing an AC adapter

Test the AC adapter if the computer exhibits any of the following symptoms:

- The computer will not turn on when connected to the AC adapter.
- The display does not turn on when the computer is connected to the AC adapter and external power.
- The power light is off when the computer is connected to the AC adapter.

To test the AC adapter:

1. Remove the battery from the computer.
2. Connect the AC adapter to the computer and to an AC outlet.
3. Turn on the computer.
  - If the power light turns **on**, the AC adapter is functioning properly.
  - If the power light remains **off**, the AC adapter is not functioning and should be replaced.

Contact technical support for information on obtaining a replacement AC power adapter. Select **Start > Help and Support > Get assistance**.

## Shutting down the computer

 **CAUTION:** Unsaved information will be lost when the computer is shut down.

The Shut Down command closes all open programs, including the operating system, and then turns off the display and computer.

Shut down the computer under any of the following conditions:

- When you need to replace the battery or access components inside the computer
- When you are connecting an external hardware device that does not connect to a USB port
- When the computer will be unused and disconnected from external power for an extended period

To shut down the computer, follow these steps:

 **NOTE:** If the computer is in the Sleep state or in Hibernation, you must first exit Sleep or Hibernation before shutdown is possible.

1. Save your work and close all open programs.
2. Click **Start**, and then click the arrow next to the Lock button.
3. Click **Shut Down**.

If the computer is unresponsive and you are unable to use the preceding shutdown procedures, try the following emergency procedures in the sequence provided:

- Press `ctrl+alt+delete`, and then click the **Power** button.
- Press and hold the power button for at least 5 seconds.
- Disconnect the computer from external power and remove the battery.



---

# 6 Drives

## Identifying installed drives

To view the drives installed on the computer, select **Start > Computer**.

 **NOTE:** Windows includes the User Account Control feature to improve the security of your computer. You may be prompted for your permission or password for tasks such as installing software, running utilities, or changing Windows settings. Refer to Windows Help and Support for more information.

## Handling drives

Drives are fragile computer components that must be handled with care. Refer to the following cautions before handling drives. Additional cautions are included with the procedures to which they apply.

---

△ **CAUTION:** To reduce the risk of damage to the computer, damage to a drive, or loss of information, observe these precautions:

Before you move a computer that is connected to an external hard drive, initiate Sleep and allow the screen to clear, or properly disconnect the external hard drive.

Before handling a drive, discharge static electricity by touching the unpainted metal surface of the drive.

Do not touch the connector pins on a removable drive or on the computer.

Handle a drive carefully; do not drop a drive or place items on it.

Before removing or inserting a drive, shut down the computer. If you are unsure whether the computer is off or in Hibernation, turn the computer on and then shut it down through the operating system.

Do not use excessive force when inserting a drive into a drive bay.

Do not type on the keyboard or move the computer while the optical drive (select models only) is writing to a disc. The write process is sensitive to vibration.

When the battery is the only source of power, be sure that the battery is sufficiently charged before writing to media.

Avoid exposing a drive to temperature or humidity extremes.

Avoid exposing a drive to liquids. Do not spray the drive with cleaning products.

Remove media from a drive before removing the drive from the drive bay, or traveling with, shipping, or storing a drive.

If a drive must be mailed, place the drive in a bubble-pack mailer or other suitable protective packaging and label the package "FRAGILE."

Avoid exposing a drive to magnetic fields. Security devices with magnetic fields include airport walk-through devices and security wands. The airport security devices that check carry-on luggage, such as conveyor belts, use X-rays instead of magnetism and will not damage a drive.

---

# Improving hard drive performance

## Using Disk Defragmenter

As you use the computer, files on the hard drive become fragmented. Disk Defragmenter consolidates the fragmented files and folders on the hard drive so that the system can run more efficiently.

After you start Disk Defragmenter, it works without supervision. Depending on the size of your hard drive and the number of fragmented files, Disk Defragmenter may take more than an hour to complete. You may want to set it to run during the night or another time when you do not need access to your computer.

HP recommends defragmenting your hard drive at least once a month. You may set Disk Defragmenter to run on a monthly schedule, but you can defragment your computer manually at any time.

To run Disk Defragmenter:

1. Select **Start > All Programs > Accessories > System Tools > Disk Defragmenter**.
2. Click **Defragment now**.

---

 **NOTE:** Windows includes the User Account Control feature to improve the security of your computer. You may be prompted for your permission or password for tasks such as installing software, running utilities, or changing Windows settings. Refer to Help and Support for more information.

---

For additional information, access the Disk Defragmenter software Help.

## Using Disk Cleanup

Disk Cleanup searches the hard drive for unnecessary files that you can safely delete to free up disk space and help the computer to run more efficiently.

To run Disk Cleanup:

1. Select **Start > All Programs > Accessories > System Tools > Disk Cleanup**.
2. Follow the on-screen instructions.

## Using HP 3D DriveGuard

HP 3D DriveGuard protects the hard drive by parking the drive and halting I/O requests under either of the following conditions:

- You drop the computer.
- You move the computer with the display closed while the computer is running on battery power.

A short time after the end of one of these events, HP 3D DriveGuard returns the hard drive to normal operation.

---

 **NOTE:** Hard drives that are in an optional docking device or are connected to a USB port are not protected by HP 3D DriveGuard.

---

For more information, refer to the HP 3D DriveGuard software Help.

## Identifying HP 3D DriveGuard status

The drive light on the computer changes to an amber color to show that the drive is parked. To determine whether drives are currently protected or whether a drive is parked, use Mobility Center:

- If the software is enabled, a green check mark is superimposed over the hard drive icon.
- If the software is disabled, a red X is superimposed over the hard drive icon.
- If the drives are parked, a yellow moon is superimposed over the hard drive icon.

---

 **NOTE:** The icon in the Mobility Center may not show the most up-to-date status for the drive. For immediate updates after a change in status, you need to enable the notification area icon.

---

To enable the notification area icon:

1. Select **Start > Control Panel > Hardware and Sound > HP 3D DriveGuard**.
2. Under **Icon in System Tray**, click **Show**.
3. Click **Apply**.

If HP 3D DriveGuard has parked the drive, the computer will behave in the following ways:

- The computer will not shut down.
- The computer will not initiate Sleep or Hibernation, except as described in the following Note.

---

 **NOTE:** If the computer is running on battery power and reaches a critical battery level, HP 3D DriveGuard allows the computer to initiate Hibernation.

---

- The computer will not activate battery alarms set on the Alarms tab in Power Options properties.

Before you move the computer, HP recommends that you either shut it down or initiate Sleep or Hibernation.

## Using HP 3D DriveGuard software

The HP 3D DriveGuard software enables you to perform the following tasks:

- Enable and disable HP 3D DriveGuard.

---

 **NOTE:** Depending on your user privileges, you may not be able to enable or disable HP 3D DriveGuard. Additionally, members of an Administrator group can change the privileges for non-Administrator users.

---

- Determine whether a drive in the system is supported.

To open the software and change settings, follow these steps:

1. In Mobility Center, click the hard drive icon to open the HP 3D DriveGuard window.

– or –

Select **Start > Control Panel > Hardware and Sound > HP 3D DriveGuard**.

2. Click the appropriate button to change settings.
3. Click **OK**.

## Using external drives

Removable external drives expand your options for storing and accessing information. A USB device can be added by connecting the device to a USB port on the computer or on an optional docking device (select models only).

USB drives include the following types:

- 1.44-megabyte diskette drive
- Hard drive module (a hard drive with an adapter attached)
- DVD-ROM Drive
- DVD+/-RW SuperMulti Double-Layer LightScribe Drive
- Blu-ray ROM DVD+/-RW SuperMulti Double-Layer LightScribe Drive

## Using optional external devices

---

 **NOTE:** For more information about required software and drivers, or to learn which computer port to use, refer to the manufacturer's instructions.

---

To connect an external device to the computer:

 **CAUTION:** To reduce the risk of damage to the equipment when connecting a powered device, be sure that the device is turned off and the AC power cord is unplugged.

---

1. Connect the device to the computer.
2. If you are connecting a powered device, plug the device power cord into a grounded AC outlet.
3. Turn on the device.

To disconnect an unpowered external device, turn off the device, and then disconnect it from the computer. To disconnect a powered external device, turn off the device, disconnect it from the computer, and then unplug the AC power cord.

# Replacing the hard drive

---

△ **CAUTION:** To prevent information loss or an unresponsive system:

Shut down the computer before removing the hard drive from the hard drive bay. Do not remove the hard drive while the computer is on, in the Sleep state, or in Hibernation.

If you are not sure whether the computer is off or in Hibernation, turn the computer on by pressing the power button. Then, shut down the computer through the operating system.

---

To remove a hard drive:

1. Save your work.
2. Shut down the computer and close the display.
3. Disconnect all external devices connected to the computer.
4. Unplug the power cord.
5. Turn the computer upside down on a flat surface, with the battery bay toward you.
6. Remove the battery from the computer.

7. Remove the screws from the battery area.

 **NOTE:** Refer to the illustration that most closely matches your computer.

---

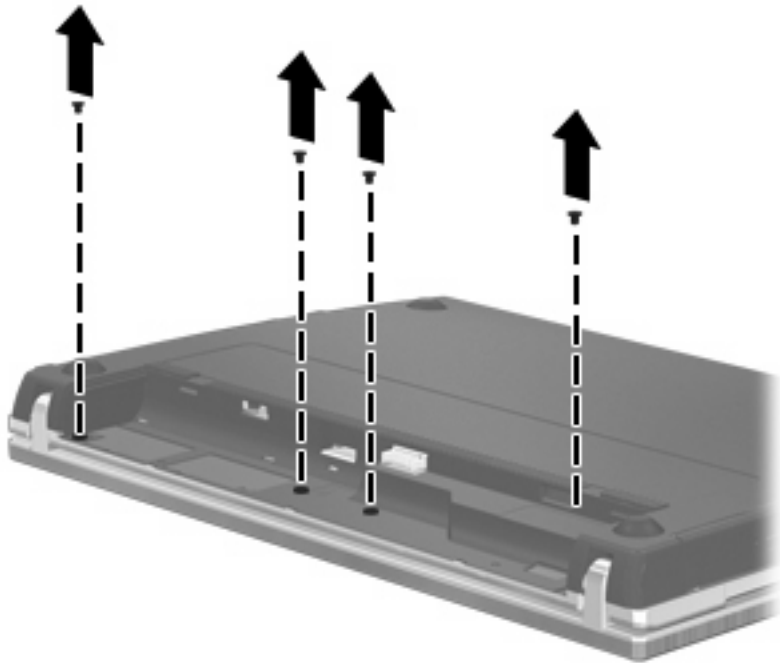
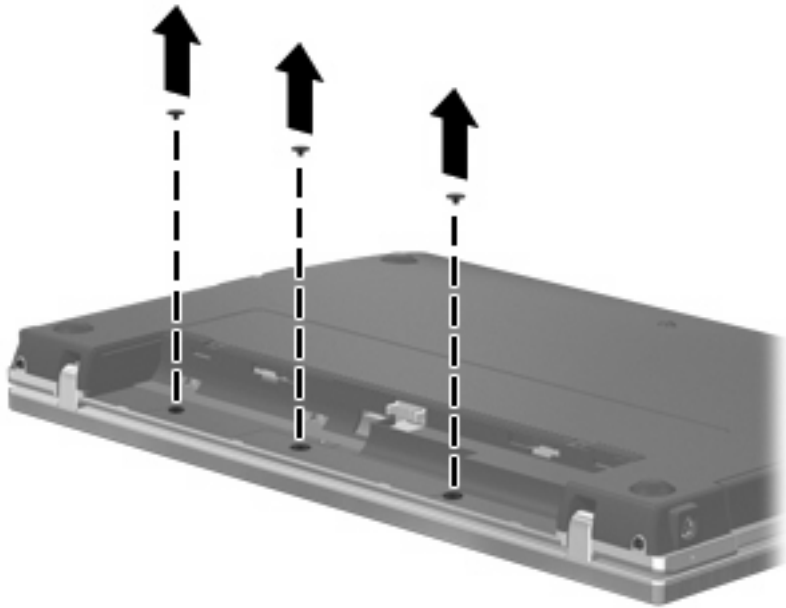



8. Remove the 2 screw covers (1) and screws (2) from the back edge of the computer.

 **NOTE:** Some models do not have any screw covers or screws to remove.

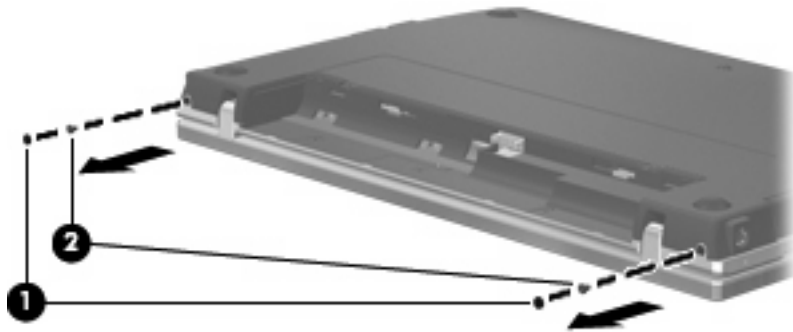

9. Turn the computer display-side up, and then open the computer as far as possible.

△ **CAUTION:** Do not use excessive force to open the computer beyond the limits of the display hinges. Forcing extension beyond these limits will cause damage to the display.

10. Slide the switch cover straight back toward the display (1), and then remove the switch cover (2).

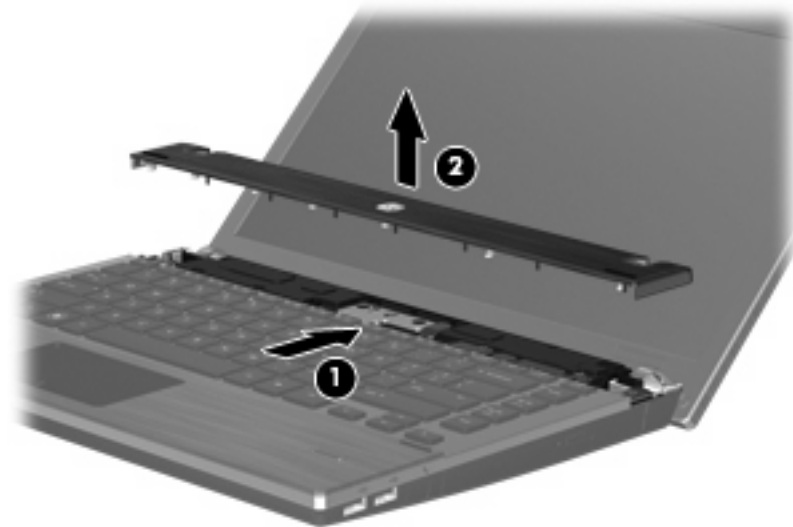

11. Remove the screws from the keyboard.

 **NOTE:** Refer to the illustration that most closely matches your computer.

---

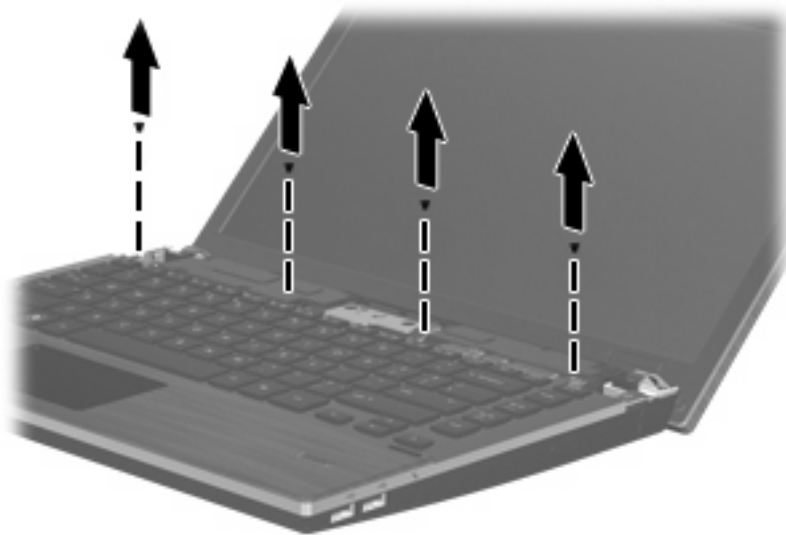
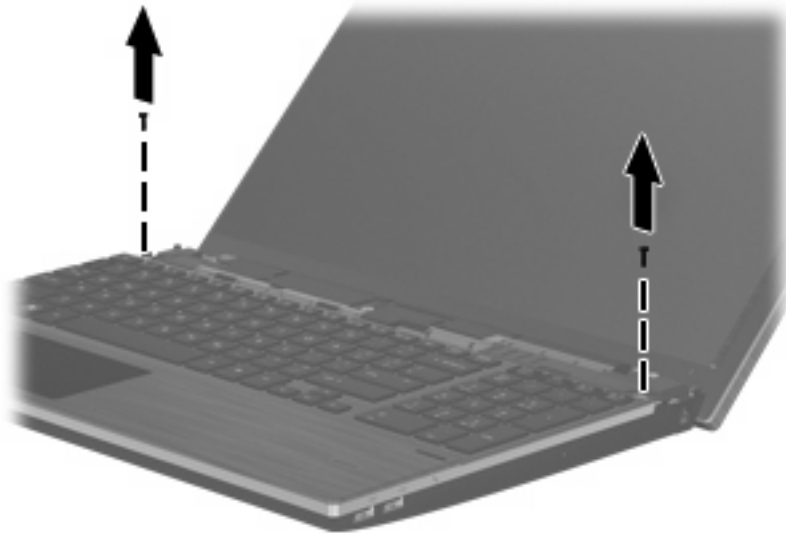

- Slide the keyboard back toward the display (1), and then rotate it forward (2) to gain access to the keyboard cable connector.

 **NOTE:** Refer to the illustration that most closely matches your computer.



△ **CAUTION:** Do not rip the keyboard cable.

– or –

Slide the keyboard back toward the display (1), and then rotate it to the right side (2) to gain access to the keyboard cable connector.

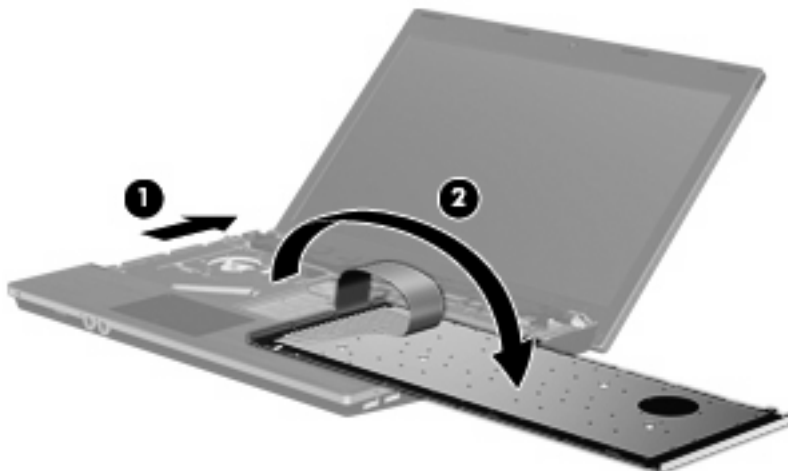

△ **CAUTION:** Do not rip the keyboard cable.

13. Release the ZIF connector (1) to which the keyboard cable is attached, disconnect the keyboard cable (2) from the system board by pulling upward, and then remove the keyboard from the computer (3).

 **NOTE:** Refer to the illustration that most closely matches your computer.

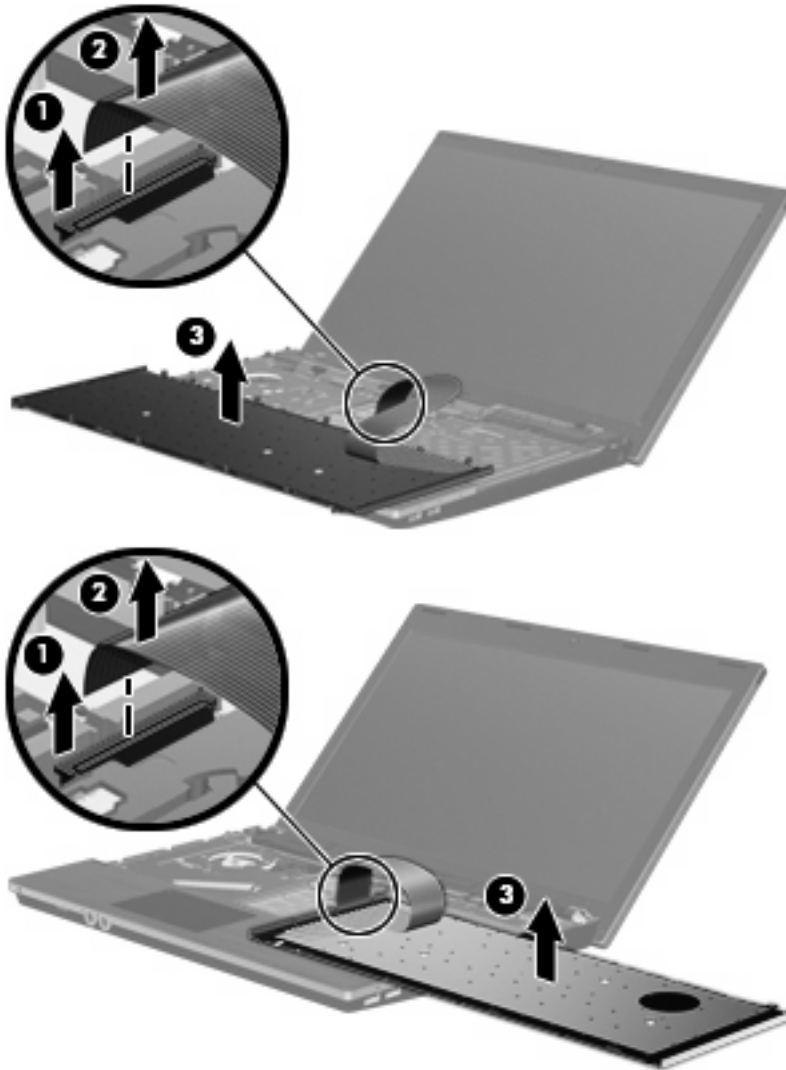

14. Remove the screws from the palm rest.

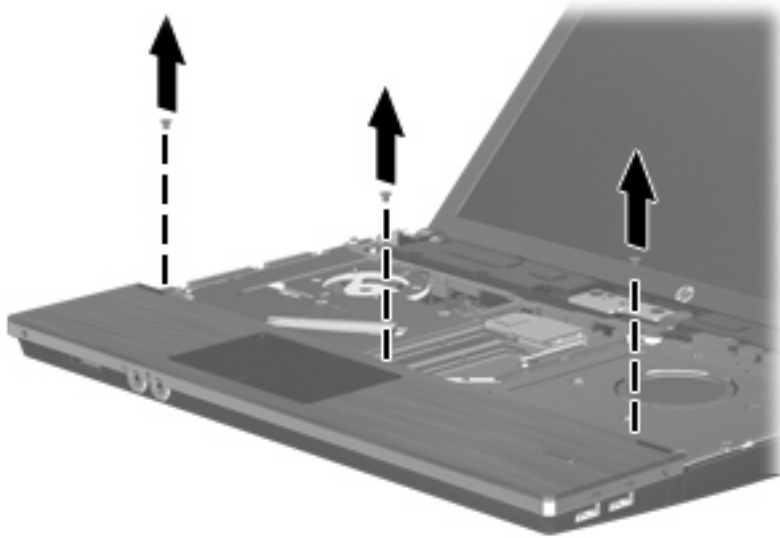

15. Slide the palm rest to the right until it disengages from the base enclosure (1), and then rest the palm rest on the computer (2).

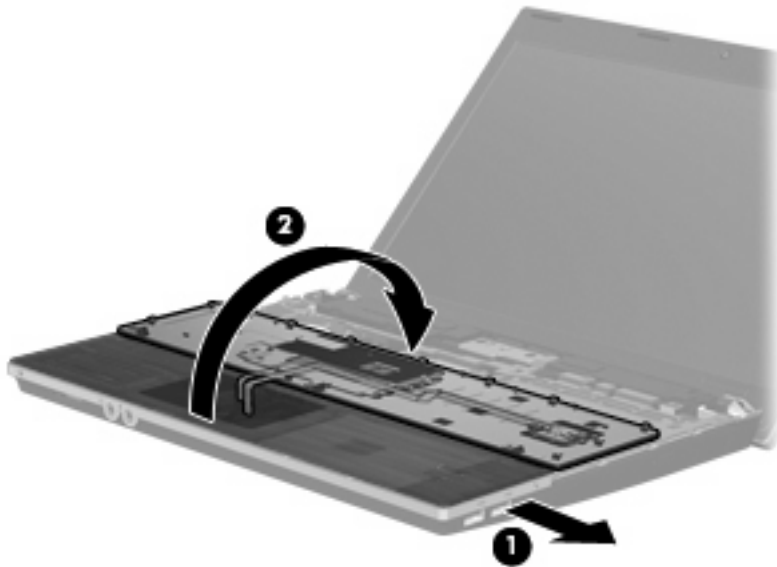

16. Remove the 2 hard drive screws (1), and then loosen the captive screw (2) that secures the hard drive.
17. Use the Mylar tab (3) on the hard drive to slide the hard drive to the right to disconnect it from the system board.

18. Lift the hard drive (4) out of the hard drive bay.

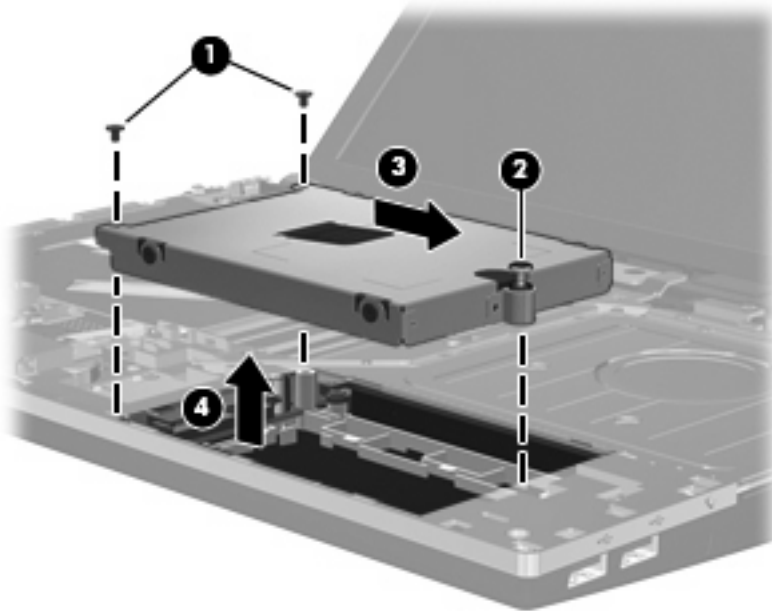

To install a hard drive:

1. Insert the hard drive into the hard drive bay (1).
2. Use the Mylar tab (2) on the hard drive to slide the hard drive to the left to connect it to the system board.
3. Replace the 2 hard drive screws (3), and then tighten the captive screw (4) to secure the hard drive to the computer.

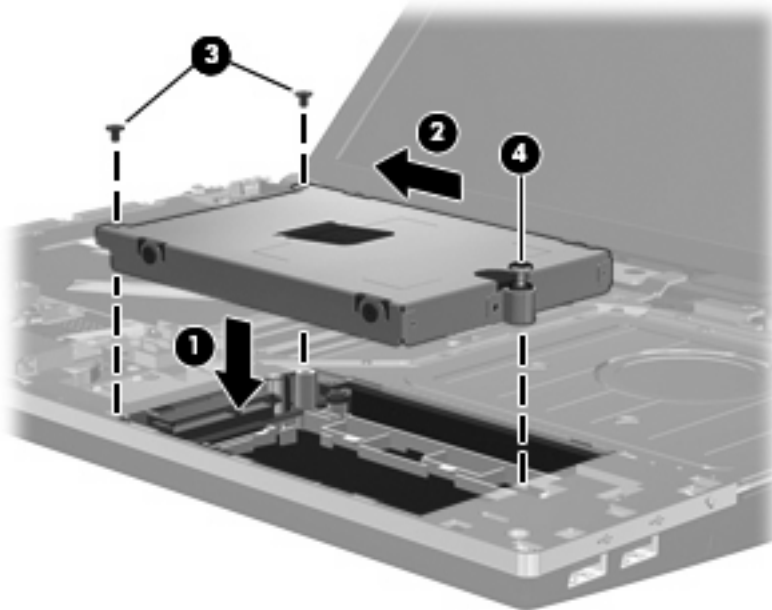

4. Turn over the palm rest (1), resting it in the palm rest tray, and then slide the palm rest to the left to reconnect it to the base enclosure (2).



5. Replace the screws in the palm rest.

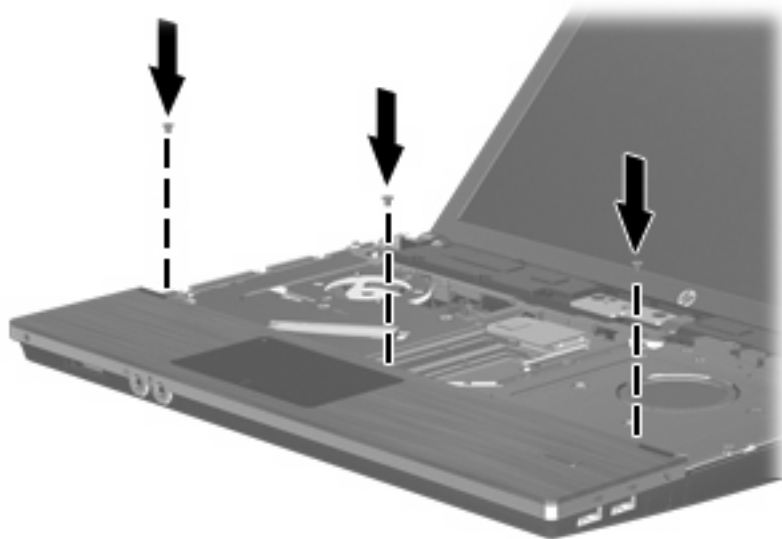

6. Place the keyboard upside down on the palm rest of the computer (1).

7. Insert the keyboard cable (2) into the ZIF connector (3) on the system board, and then secure the connector.

 **NOTE:** Refer to the illustration that most closely matches your computer.

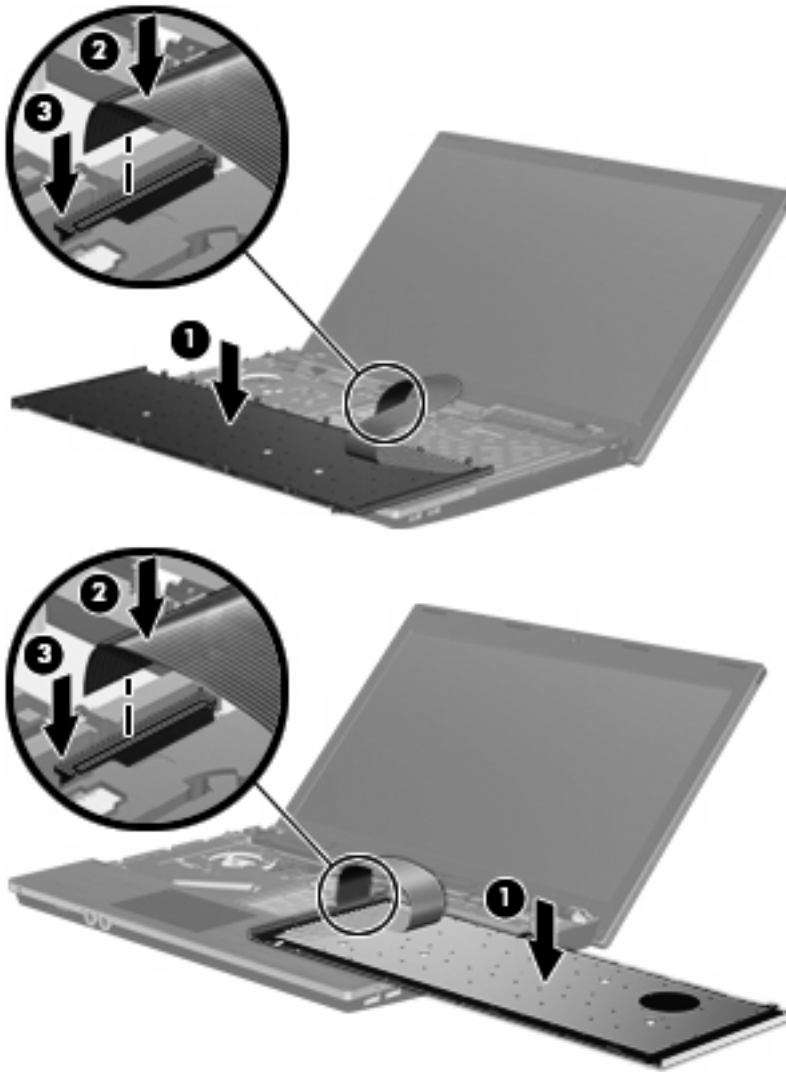



8. Turn over the keyboard (1) into the keyboard tray, and then slide the keyboard (2) into place.

 **NOTE:** Refer to the illustration that most closely matches your computer.

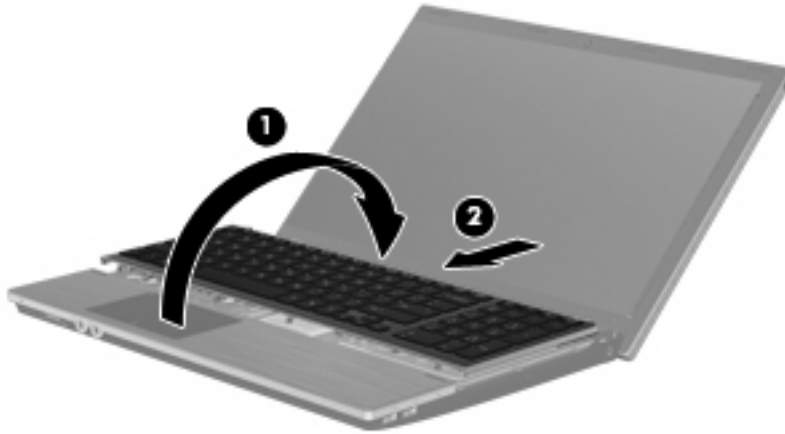

9. Replace the screws on the keyboard.

 **NOTE:** Refer to the illustration that most closely matches your computer.

---

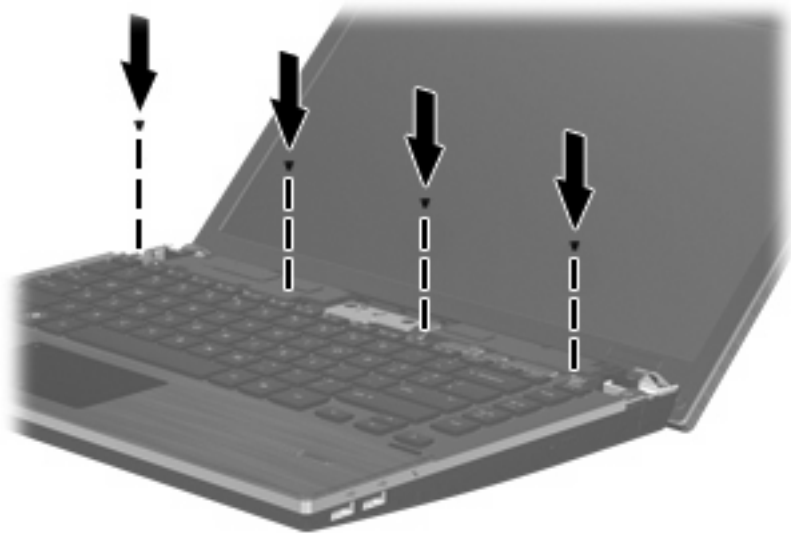
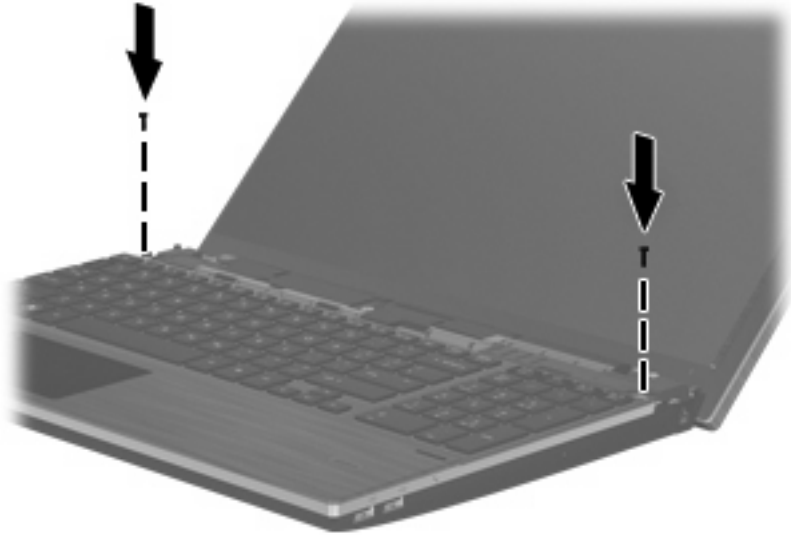

10. Place the switch cover on top of the switch cover tray (1), and then slide the switch cover into place (2).

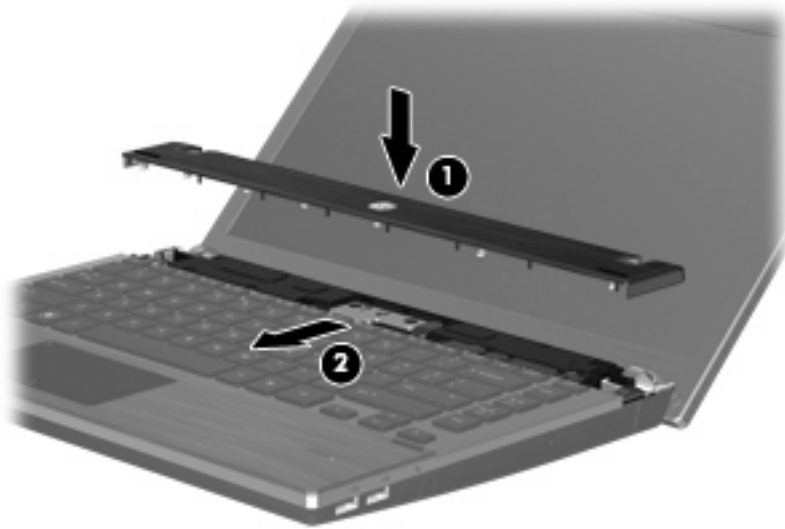

11. Close the computer display.
12. Turn the computer upside down on a flat surface, with the battery bay toward you.
13. Replace the 2 screws (1) and their covers (2) on the back edge of the computer.

 **NOTE:** Some models do not have any screws or screw covers to replace.

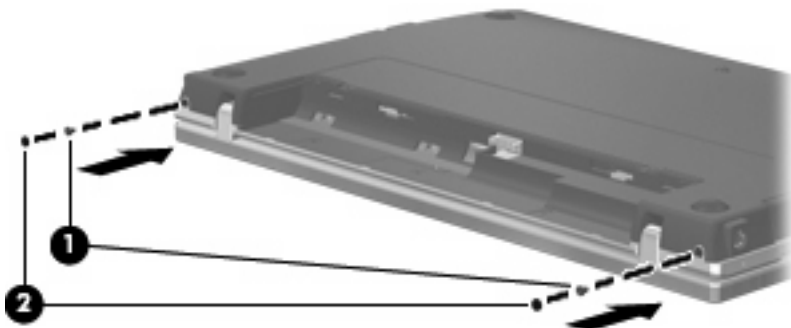

14. Replace the screws in the battery area.

 **NOTE:** Refer to the illustration that most closely matches your computer.

---

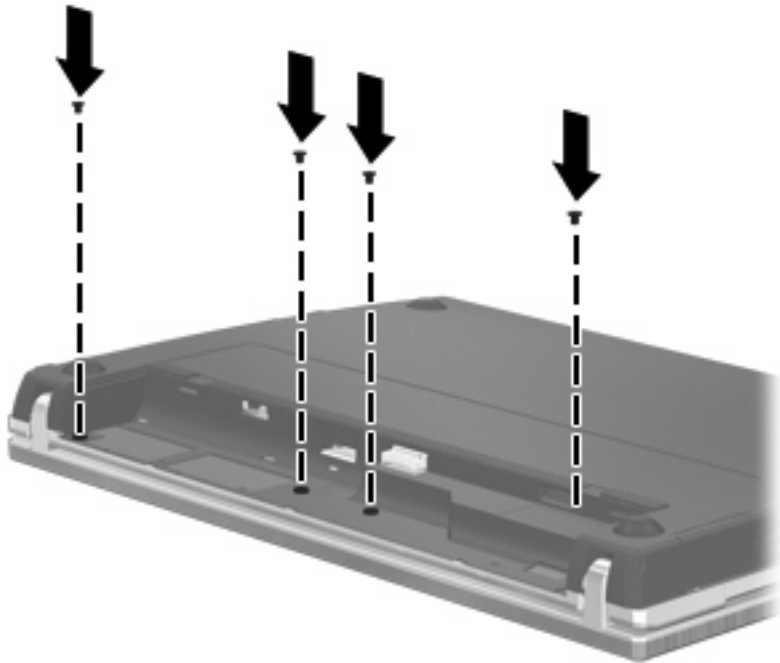
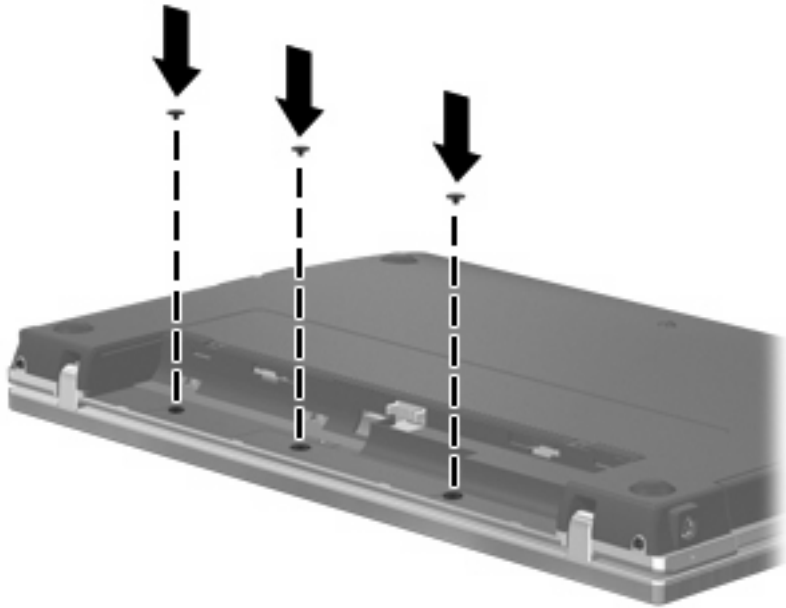

15. Replace the battery.
16. Turn the computer right-side up, and then reconnect external power and external devices.
17. Turn on the computer.

---

# 7 External devices

## Using a USB device

Universal Serial Bus (USB) is a hardware interface that can be used to connect an optional external device, such as a USB keyboard, mouse, drive, printer, scanner, or hub.

Some USB devices may require additional support software, which is usually included with the device. For more information about device-specific software, refer to the manufacturer's instructions.

Your computer model has 4 USB ports, which support USB 1.0, USB 1.1, and USB 2.0 devices. A USB hub provides additional USB ports that can be used with the computer.

## Connecting a USB device

---

△ **CAUTION:** To prevent damage to a USB connector, use minimal force to connect a USB device.

▲ To connect a USB device to the computer, connect the USB cable for the device to the USB port.



You will hear a sound when the device has been detected.

---

📄 **NOTE:** The first time you connect a USB device, a message is displayed in the notification area to let you know the device is recognized by the computer.

---

## Stopping and removing a USB device

---

△ **CAUTION:** To prevent loss of information or an unresponsive system, stop a USB device before removing it.

**CAUTION:** To prevent damage to a USB connector, do not pull on the cable to remove the USB device.

To stop and remove a USB device:

1. Double-click the **Safely Remove Hardware** icon in the notification area, at the far right of the taskbar.

 **NOTE:** To display the Safely Remove Hardware icon, click the **Show Hidden Icons** icon (< or <<) in the notification area.

2. Click the name of the device in the list.

 **NOTE:** If the USB device is not listed, you do not have to stop the device before you remove it.

3. Click **Stop**, and then click **OK**.
4. Remove the device.

## Using USB legacy support

USB legacy support (enabled by default) permits the following actions:

- Using a USB keyboard, mouse, or hub connected to a USB port on the computer during startup or in an MS-DOS-based program or utility
- Starting or restarting from an optional external MultiBay or an optional USB bootable device

USB legacy support is enabled at the factory. To disable or enable USB legacy support:

1. Open Computer Setup by turning on or restarting the computer, and then pressing **f10** while the “F10 = ROM Based Setup” message is displayed in the lower-left corner of the screen.
2. Use the arrow keys to select **System Configuration > Device configurations**, and then press **enter**.
3. Use the arrow keys to enable or disable USB legacy support, and then press **f10**.
4. To save your preferences and exit Computer Setup, use the arrow keys to select **File > Save Changes and Exit**. Then follow the instructions on the screen.

Your preferences go into effect when the computer restarts.

## Using an eSATA device

An eSATA port connects an optional high-performance eSATA component, such as an eSATA external hard drive.

Some eSATA devices may require additional support software, which is usually included with the device. For more information about device-specific software, refer to the software manufacturer's instructions. These instructions may be provided with the software, on disc, or on the manufacturer's Web site.

---

 **NOTE:** The eSATA port also supports an optional USB device.

---

## Connecting an eSATA device

---

△ **CAUTION:** To prevent damage to an eSATA port connector, use minimal force to connect an eSATA device.

---

▲ To connect an eSATA device to the computer, connect the eSATA cable for the device to the eSATA port.

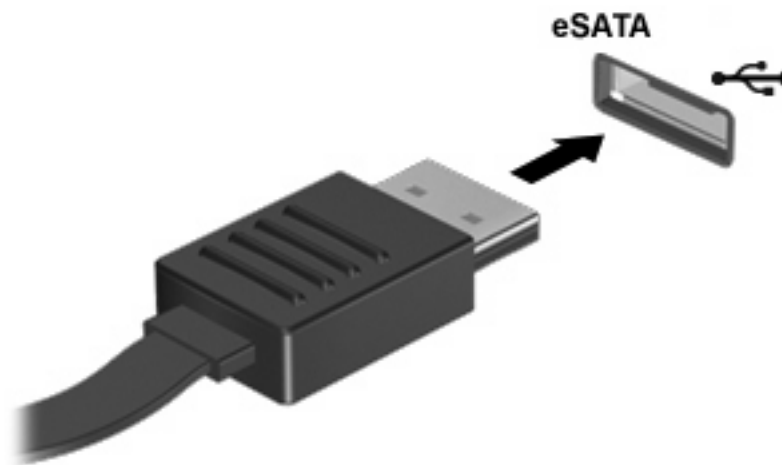

You will hear a sound when the device has been detected.

## Stopping and removing an eSATA device

---

△ **CAUTION:** To prevent loss of information or an unresponsive system, stop the eSATA device before removing it.

**CAUTION:** To prevent damage to an eSATA connector, do not pull on the cable to remove the eSATA device.

---

1. Double-click the **Safely Remove Hardware** icon in the notification area, at the far right of the taskbar.

---

 **NOTE:** To display the Safely Remove Hardware icon, click the **Show Hidden Icons** icon (< or <<) in the notification area.

---

2. Click the name of the device in the list.

---

 **NOTE:** If the device is not displayed, you do not have to stop the device before you remove it.

---

3. Click **Stop**, and then click **OK**.
4. Remove the device.



## Using external drives

Removable external drives expand your options for storing and accessing information. A USB drive can be added by connecting the drive to a USB port on the computer.

USB drives include the following types:

- 1.44-megabyte diskette drive
- Hard drive module (a hard drive with an adapter attached)
- DVD-ROM Drive
- DVD+/-RW SuperMulti DL LightScribe Drive
- Blu-ray ROM DVD+/-RW SuperMulti DL LightScribe Drive

## Using optional external devices

---

 **NOTE:** For more information about required software and drivers, or to learn which computer port to use, refer to the manufacturer's instructions.

---

To connect an external device to the computer:

---

 **CAUTION:** To reduce the risk of damage to the equipment when connecting a powered device, be sure that the device is turned off and the AC power cord is unplugged.

---

1. Connect the device to the computer.
2. If you are connecting a powered device, plug the device power cord into a grounded AC outlet.
3. Turn on the device.

To disconnect an unpowered external device, turn off the device, and then disconnect it from the computer. To disconnect a powered external device, turn off the device, disconnect it from the computer, and then unplug the AC power cord.

---

## 8 External media cards

### Using Media Card Reader cards

Optional digital cards provide secure data storage and convenient data sharing. These cards are often used with digital media-equipped cameras and PDAs, as well as with other computers.

The Digital Media Slot supports the following digital card formats:

- Memory Stick
- Memory Stick Duo (adapter required)
- Memory Stick Pro (adapter required)
- MultiMediaCard (MMC)
- Secure Digital (SD) Memory Card
- xD-Picture Card (XD)
- xD-Picture Card (XD) Type H
- xD-Picture Card (XD) Type M

### Inserting a digital card

△ **CAUTION:** To avoid damaging the digital card or the computer, do not insert any type of adapter into the SD Card Reader.

**CAUTION:** To prevent damage to the digital card connectors, use minimal force to insert a digital card.

1. Hold the digital card label-side up, with the connectors facing the computer.

2. Insert the card into the Media Card Reader, and then push in on the card until it is firmly seated.

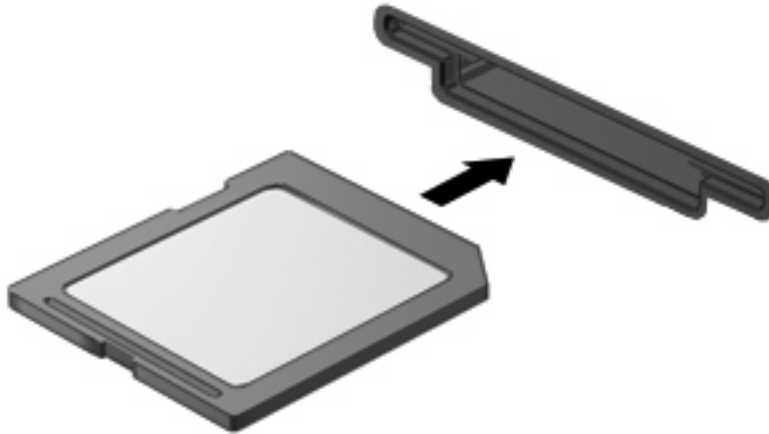

You will hear a sound when the device has been detected, and a menu of available options may be displayed.

## Stopping and removing a digital card

△ **CAUTION:** To prevent loss of data or an unresponsive system, stop a digital card before removing it.

1. Save your information and close all programs associated with the digital card.

📝 **NOTE:** To stop a data transfer, click **Cancel** in the operating system Copying window.

2. Stop the digital card:

- a. Double-click the **Safely Remove Hardware** icon in the notification area, at the far right of the taskbar.

📝 **NOTE:** To display the Safely Remove Hardware icon, click the **Show Hidden Icons** icon (< or <<) in the notification area.

- b. Click the name of the digital card in the list.
- c. Click **Stop**, and then click **OK**.

3. Press in on the digital card (1), and then remove the card from the slot (2).

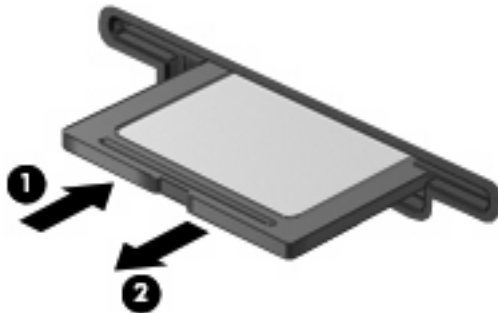

## Using ExpressCards (select models only)

An ExpressCard is a high-performance PC Card that is inserted into the ExpressCard slot.

Like standard PC Cards, ExpressCards are designed to conform to the standard specifications of the Personal Computer Memory Card International Association (PCMCIA).

### Configuring an ExpressCard

Install only the software required for your device. If you are instructed by the ExpressCard manufacturer to install device drivers:

- Install only the device drivers for your operating system.
- Do not install other software, such as card services, socket services, or enablers, supplied by the ExpressCard manufacturer.

### Inserting an ExpressCard

△ **CAUTION:** To prevent damage to the computer and external media cards, do not insert a PC Card into an ExpressCard slot.

**CAUTION:** To prevent damage to the connectors:

Use minimal force when inserting an ExpressCard.

Do not move or transport the computer when an ExpressCard is in use.

The ExpressCard slot may contain a protective insert. To remove the insert:

1. Press in on the insert **(1)** to unlock it.
2. Pull the insert out of the slot **(2)**.

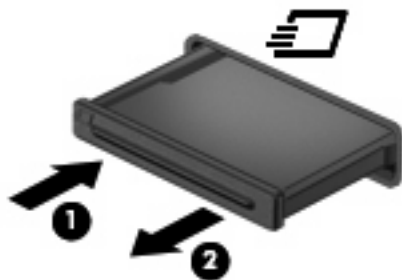

To insert an ExpressCard:

1. Hold the card label-side up, with the connectors facing the computer.

2. Insert the card into the ExpressCard slot, and then push in on the card until it is firmly seated.

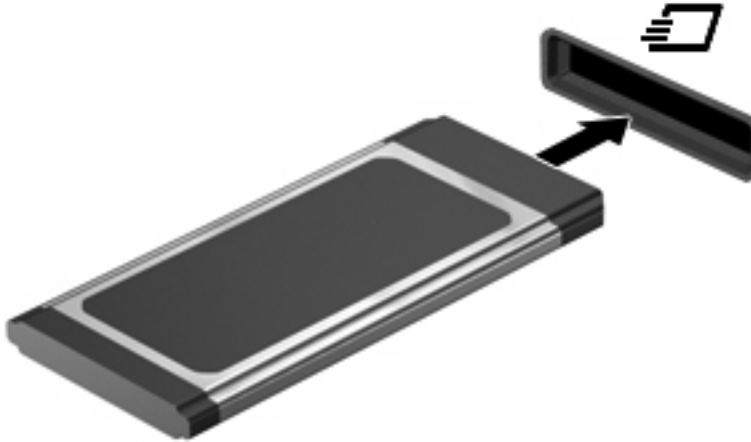

You will hear a sound when the device has been detected, and a menu of options may be displayed.

 **NOTE:** The first time you insert an ExpressCard, a message is displayed in the notification area to let you know the device is recognized by the computer.

 **NOTE:** An inserted ExpressCard uses power even when idle. To conserve power, stop or remove an ExpressCard when it is not in use.

## Stopping and removing an ExpressCard

 **CAUTION:** To prevent loss of data or an unresponsive system, stop an ExpressCard before removing it.

1. Save your information and close all programs associated with the ExpressCard.

 **NOTE:** To stop a data transfer, click **Cancel** in the operating system Copying window.

2. Stop the ExpressCard:

- a. Double-click the **Safely Remove Hardware** icon in the notification area, at the far right of the taskbar.

 **NOTE:** To display the Safely Remove Hardware icon, click the **Show Hidden Icons** icon (< or <<) in the notification area.

- b. Click the name of the ExpressCard in the list.
- c. Click **Stop**, and then click **OK**.

3. Release and remove the ExpressCard:

- a. Gently press in on the ExpressCard **(1)** to unlock it.
- b. Pull the ExpressCard out of the slot **(2)**.

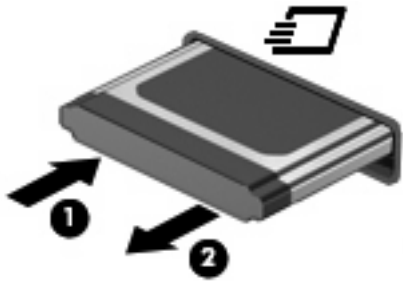

---

## 9 Memory modules

The computer has one memory module compartment, which is located under the keyboard. The memory capacity of the computer can be upgraded by adding a memory module to the vacant expansion memory module slot or by upgrading the existing memory module in the primary memory module slot.

All memory modules installed in the computer must be the same type. When upgrading memory capacity, verify that the upgrade modules are the same as those already installed in the computer.

- ⚠ **WARNING!** To reduce the risk of electric shock and damage to the equipment, unplug the power cord and remove all batteries before installing a memory module.
  - ⚠ **CAUTION:** Electrostatic discharge (ESD) can damage electronic components. Before beginning any procedure, touch a grounded metal object to be sure that you are discharged of static electricity.
  - 📝 **NOTE:** To use a dual-channel configuration when adding a second memory module, be sure that both memory modules are the same size and type.
-

## Adding or replacing memory modules

To add or replace a memory module:

1. Save your work.
2. Shut down the computer and close the display.

If you are not sure whether the computer is off or in Hibernation, turn the computer on by briefly pressing the power button. Then, shut down the computer through the operating system.

3. Disconnect all external devices connected to the computer.
4. Unplug the power cord.
5. Turn the computer upside down on a flat surface, with the battery bay toward you.
6. Remove the battery from the computer.



7. Remove the screws from the battery area.

 **NOTE:** Refer to the illustration that most closely matches your computer.

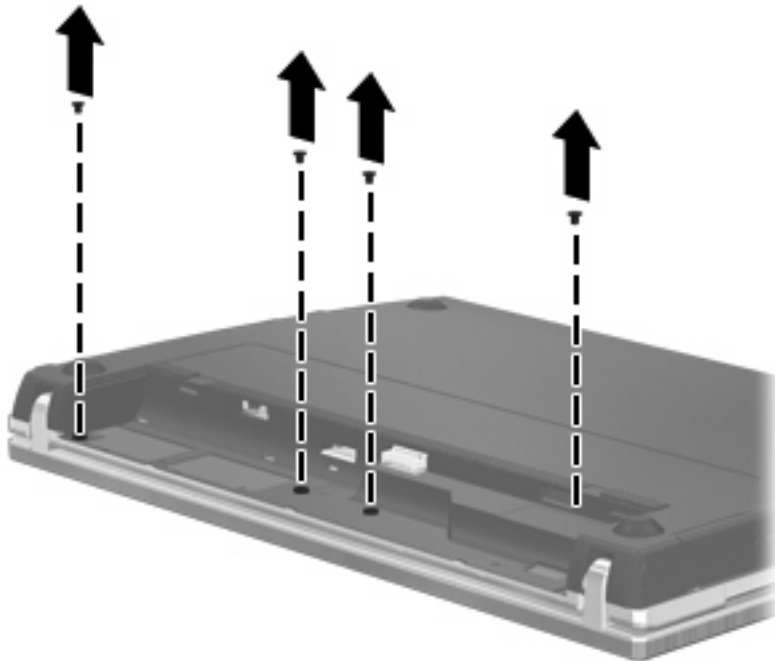
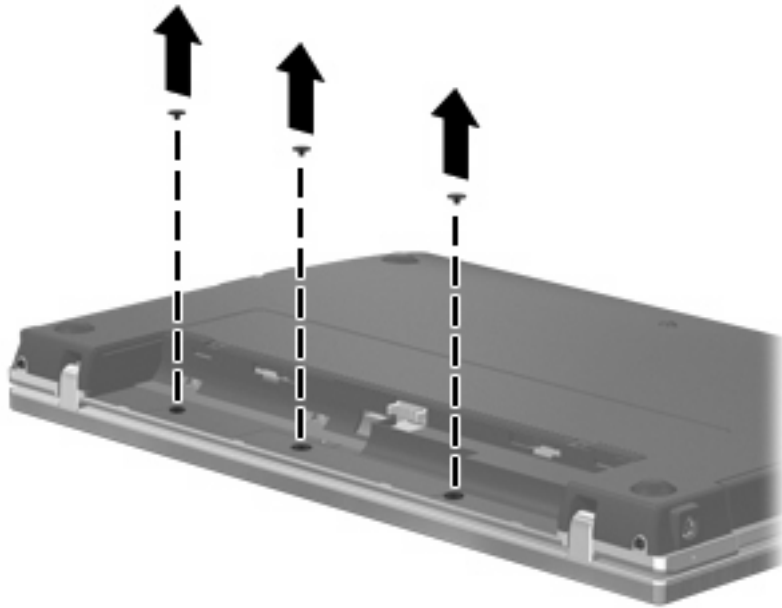

8. Remove the 2 screw covers (1) and screws (2) from the back edge of the computer.

 **NOTE:** Some models do not have any screw covers or screws to remove.

---

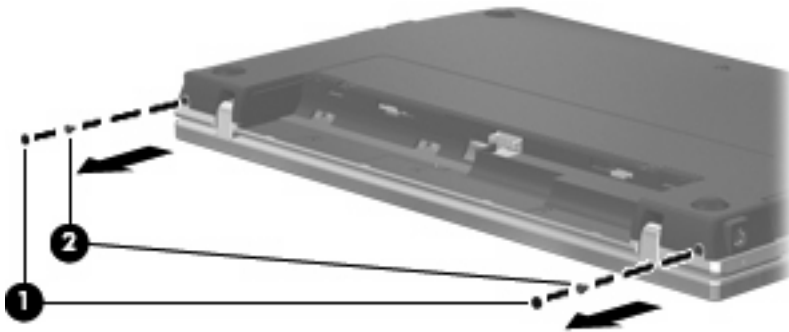

9. Turn the computer display-side up, and then open the computer as far as possible.

△ **CAUTION:** Do not use excessive force to open the computer beyond the limits of the display hinges. Forcing extension beyond these limits will cause damage to the display.

---

10. Slide the switch cover straight back toward the display (1), and then remove the switch cover (2).

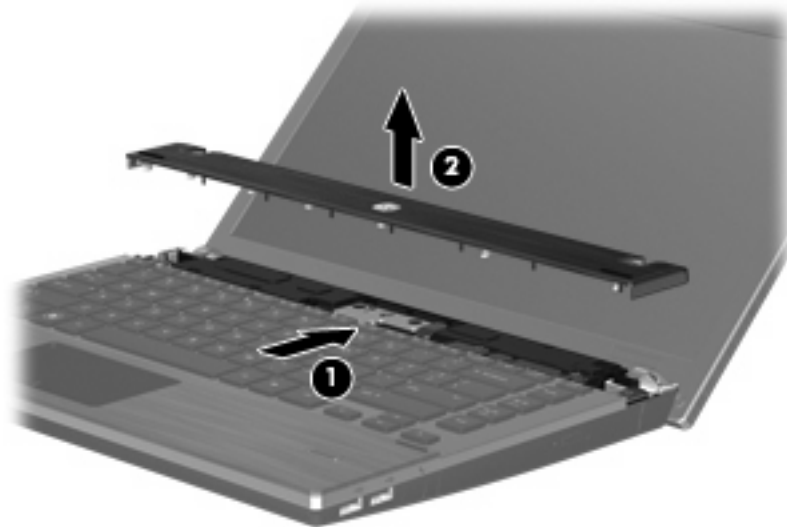

11. Remove the screws from the keyboard.

 **NOTE:** Refer to the illustration that most closely matches your computer.

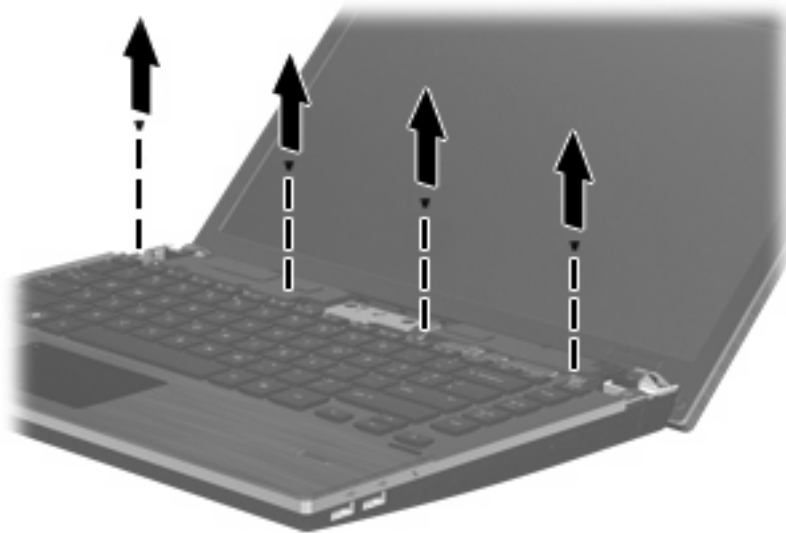
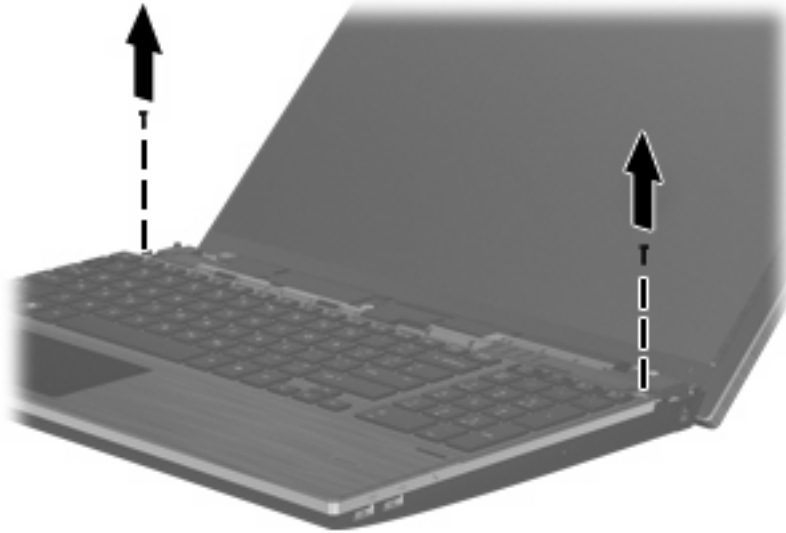

- Slide the keyboard back toward the display (1), and then rotate it forward (2) to gain access to the keyboard cable connector.

 **NOTE:** Refer to the illustration that most closely matches your computer.



△ **CAUTION:** Do not rip the keyboard cable.

– or –

Slide the keyboard back toward the display (1), and then rotate it to the right side (2) to gain access to the keyboard connector.

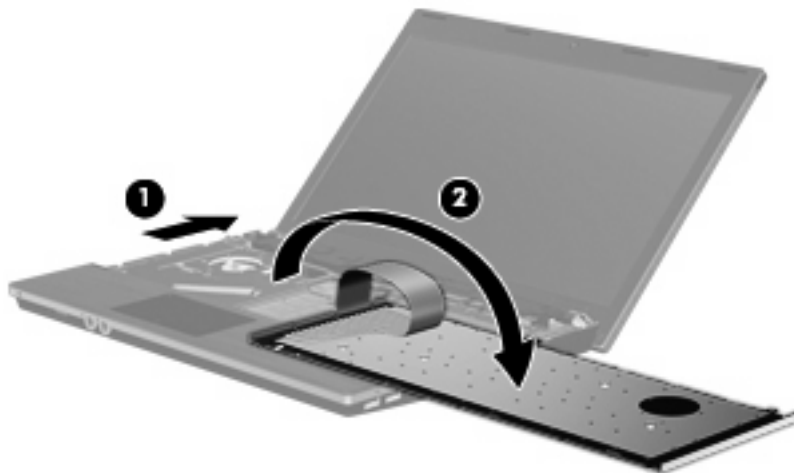

△ **CAUTION:** Do not rip the keyboard cable.

- If you are replacing a memory module, remove the existing memory module:

△ **CAUTION:** To prevent damage to the memory module, hold the memory module by the edges only. Do not touch the components on the memory module.

- Pull away the retention clips (1) on each side of the memory module.

The memory module tilts up.

- b. Grasp the edge of the memory module (2), and gently pull the module out of the memory module slot.

To protect a memory module after removal, place it in an electrostatic-safe container.

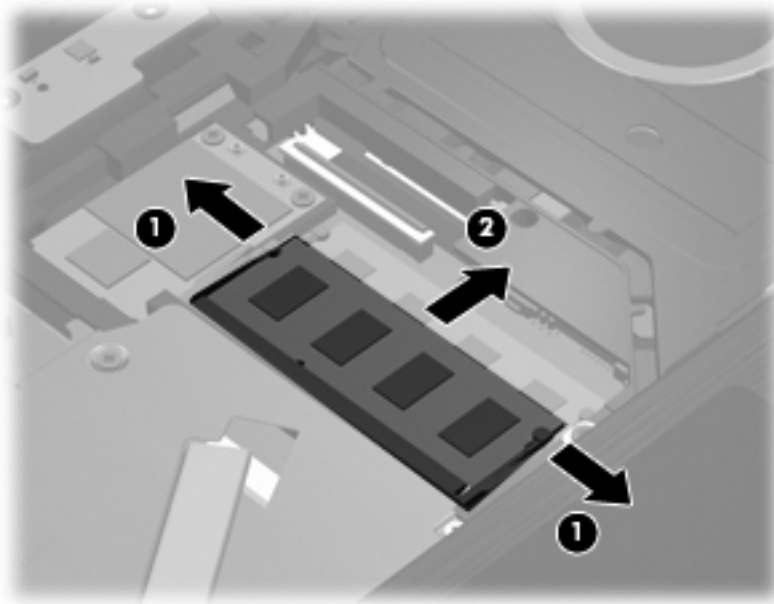

14. Insert a new memory module:

△ **CAUTION:** To prevent damage to the memory module, hold the memory module by the edges only. Do not touch the components on the memory module.

- a. Align the notched edge (1) of the memory module with the tab in the memory module slot.
- b. With the memory module at a 45-degree angle from the surface of the memory module compartment, press the module (2) into the memory module slot until it is seated.

△ **CAUTION:** To prevent damage to the memory module, do not bend the memory module.

- c. Gently press the memory module **(3)** down, applying pressure to both the left and right edges of the memory module, until the retention clips snap into place.

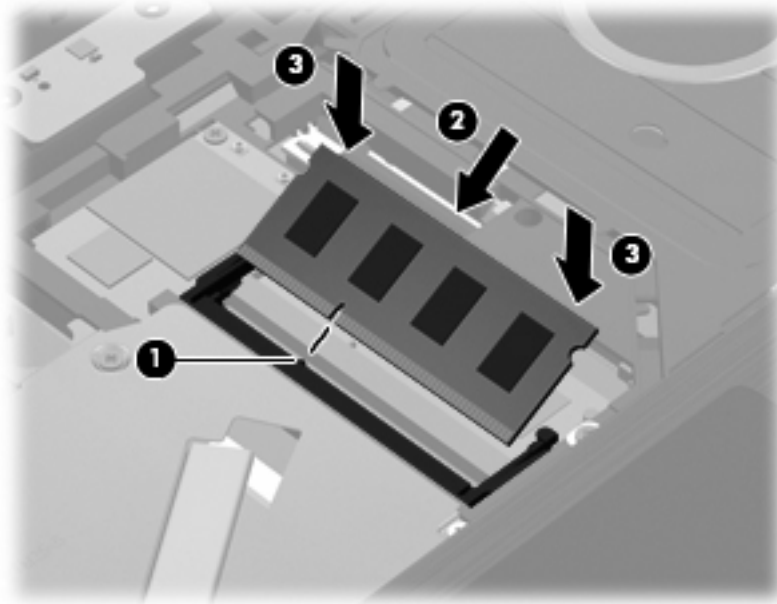

15. Turn over the keyboard (1) into the keyboard tray, and then slide the keyboard (2) into place.

 **NOTE:** Refer to the illustration that most closely matches your computer.

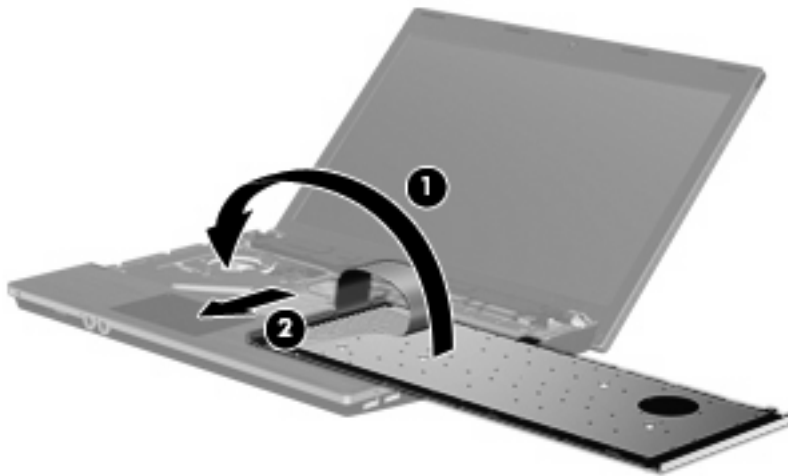
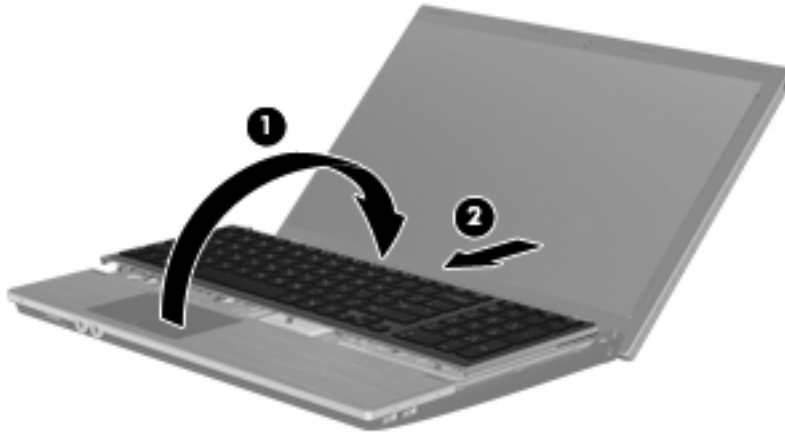

16. Replace the screws on the keyboard.

 **NOTE:** Refer to the illustration that most closely matches your computer.

---

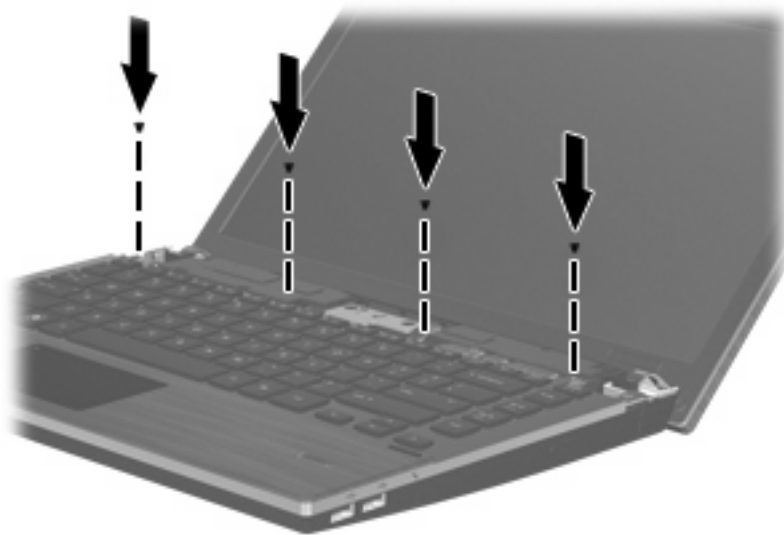
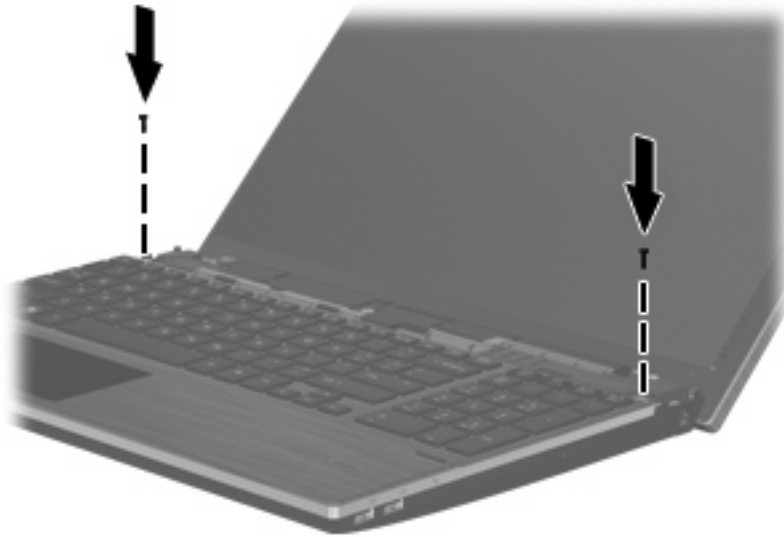



17. Place the switch cover on top of the switch cover tray (1), and then slide the switch cover into place (2).

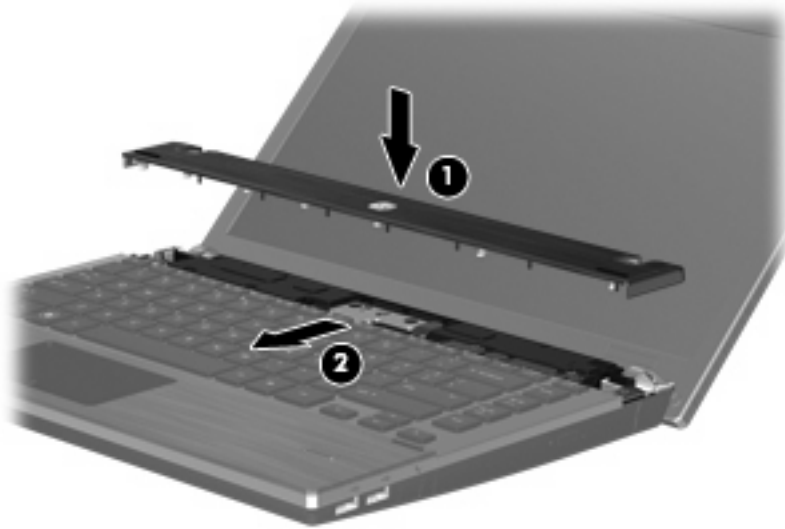

18. Close the computer display.
19. Turn the computer upside down on a flat surface, with the battery bay toward you.
20. Replace the 2 screws (1) and their covers (2) on the back edge of the computer.

 **NOTE:** Some models do not have any screws or screw covers to replace.

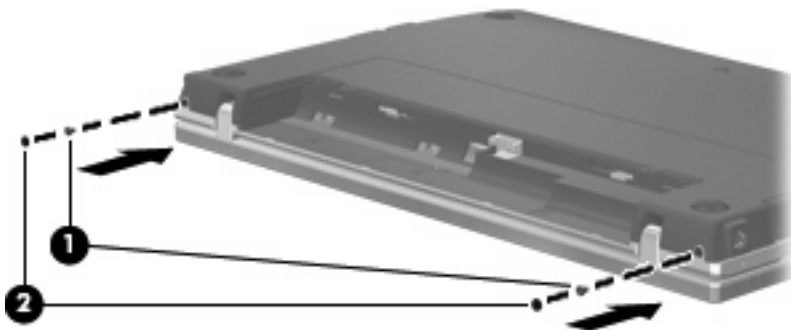

21. Replace the screws in the battery area.

 **NOTE:** Refer to the illustration that most closely matches your computer.

---

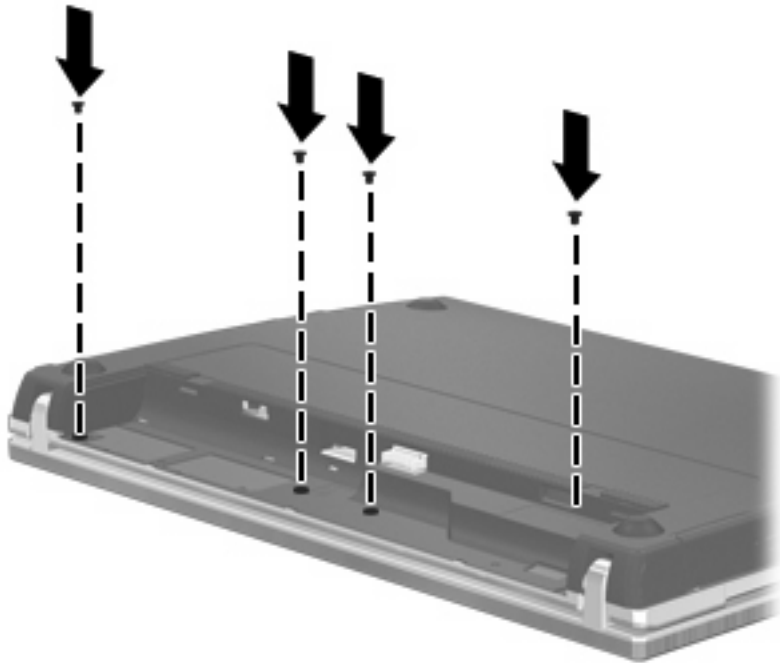
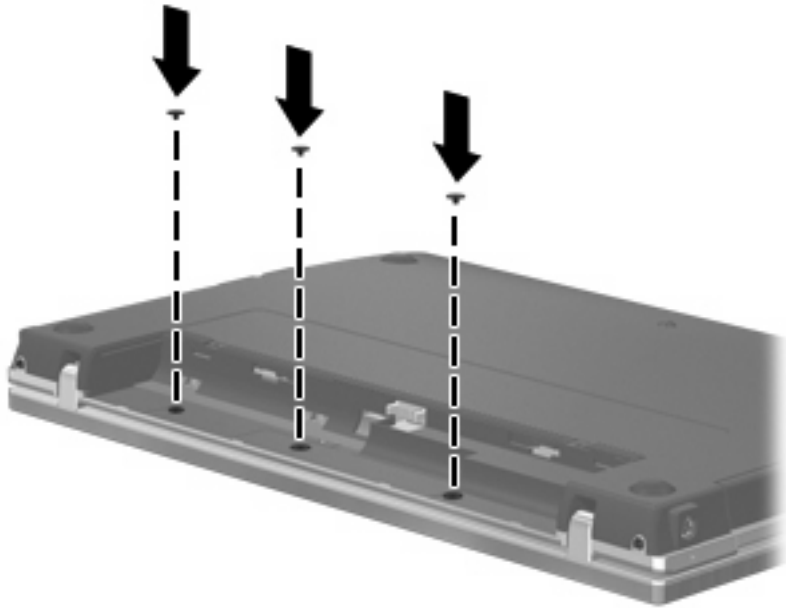

22. Replace the battery.

23. Turn the computer right-side up, and then reconnect external power and external devices.

24. Turn on the computer.

# 10 Security

## Protecting the computer

 **NOTE:** Security solutions are designed to act as deterrents. These deterrents may not prevent a product from being mishandled or stolen.

**NOTE:** Your computer supports CompuTrace, which is an online security-based tracking and recovery service available in select regions. If the computer is stolen, CompuTrace can track the computer if the unauthorized user accesses the Internet. You must purchase the software and subscribe to the service in order to use CompuTrace. For information about ordering the CompuTrace software, go to the HP Web site at <http://www.hpshopping.com>.

Security features provided with your computer can protect the computer, personal information, and data from a variety of risks. The way you use your computer will determine which security features you need to use.

The Windows operating system offers certain security features. Additional security features are listed in the following table. Most of these additional security features can be configured in the Computer Setup utility (referred to hereafter as Computer Setup).

To protect against	Use this security feature
Unauthorized use of the computer	HP ProtectTools Security Manager, in combination with a password, face recognition, smart card (select models only), and/or fingerprint reader (select models only)
Unauthorized access to Computer Setup (f10)	BIOS administrator password in Computer Setup*
Unauthorized access to the contents of a hard drive	DriveLock password in Computer Setup*
Unauthorized startup from an optical drive, diskette drive, or internal network adapter	Boot options feature in Computer Setup*
Unauthorized access to a Windows user account	HP ProtectTools Security Manager
Unauthorized access to data	<ul style="list-style-type: none"><li>• Firewall software</li><li>• Windows updates</li><li>• Drive encryption for HP ProtectTools</li></ul>
Unauthorized access to Computer Setup settings and other system identification information	BIOS administrator password in Computer Setup*
Unauthorized removal of the computer	Security cable slot (used with an optional security cable)

\*Computer Setup is a preinstalled, ROM-based utility that can be used even when the operating system is not working or will not load. You can use either a pointing device (TouchPad, pointing stick, or USB mouse) or the keyboard to navigate and make selections in Computer Setup.

## Using passwords

Most security features use passwords. Whenever you set a password, write down the password and store it in a secure location away from the computer. Note the following password considerations:

- Setup and DriveLock passwords are set in Computer Setup and are managed by the system BIOS.
- The embedded security password, which is an HP ProtectTools Security Manager password, can be enabled in Computer Setup to provide BIOS password protection in addition to their normal HP ProtectTools functions. The embedded security password is used with the optional embedded security chip.
- Windows passwords are set only in the Windows operating system.
- If you forget the BIOS administrator password set in Computer Setup, you can use HP SpareKey to access the utility.
- If you forget both the DriveLock user password and the DriveLock master password set in Computer Setup, the hard drive that is protected by the passwords is permanently locked and can no longer be used.

You can use the same password for a Computer Setup feature and for a Windows security feature. You can also use the same password for more than one Computer Setup feature.

Use the following tips for creating and saving passwords:

- When creating passwords, follow requirements set by the program.
- Write down your passwords and store them in a secure place away from the computer.
- Do not store passwords in a file on the computer.

The following tables list commonly used Windows and BIOS administrator passwords and describe their functions.

### Setting passwords in Windows

Windows passwords	Function
Administrator password*	Protects access to a Windows administrator-level account.
User password*	Protects access to a Windows user account.

\*For information about setting a Windows administrator password or a Windows user password, select **Start > Help and Support**.

### Setting passwords in Computer Setup

BIOS administrator passwords	Function
BIOS administrator password	Protects access to Computer Setup.

BIOS administrator passwords	Function
DriveLock master password	Protects access to the internal hard drive that is protected by DriveLock. It is also used to remove DriveLock protection. This password is set under DriveLock Passwords during the enable process.
DriveLock user password	Protects access to the internal hard drive that is protected by DriveLock, and is set under DriveLock Passwords during the enable process.

## BIOS administrator password

The Computer Setup BIOS administrator password protects the configuration settings and system identification information in Computer Setup. After this password is set, it must be entered to access Computer Setup and to make changes using Computer Setup.

Note the following characteristics of the BIOS administrator password:

- It is not interchangeable with a Windows administrator password, although both passwords can be identical.
- It is not displayed as it is set, entered, changed, or deleted.
- It must be set and entered with the same keys. For example, a BIOS administrator password set with keyboard number keys will not be recognized if you enter it thereafter with embedded numeric keypad number keys.
- It can include any combination of up to 32 letters and numbers and is not case sensitive unless mandated by the administrator.

## Managing a BIOS administrator password

A BIOS administrator password is set, changed, and deleted in Computer Setup.

To set or change this password in Computer Setup, follow these steps:

1. Turn on or restart the computer, and then press **esc** while the “Press the ESC key for Startup Menu” message is displayed at the bottom of the screen.
2. Press **f10** to enter BIOS Setup.
3. Use a pointing device or the arrow keys to select **Security > Change Password**, and then press **enter**.
4. When prompted, type your current password.
5. When prompted, type your new password.
6. When prompted, type your new password again to confirm.
7. To save your changes and exit Computer Setup, click the **Save** icon in the lower-left corner of the screen, and then follow the on-screen instructions.

– or –

Use the arrow keys to select **File > Save Changes and Exit**, and then press **enter**.

Your changes go into effect when the computer restarts.

To delete this password in Computer Setup, follow these steps:

1. Turn on or restart the computer, and then press **esc** while the “Press the ESC key for Startup Menu” message is displayed at the bottom of the screen.
2. Press **f10** to enter BIOS Setup.
3. Use a pointing device or the arrow keys to select **Security > Change Password**, and then press **enter**.
4. When prompted, type your current password.
5. When prompted for the new password, leave the field empty, and then press **enter**.
6. Read the warning. To continue, select **YES**.
7. When prompted to type your new password again, leave the field empty, and then press **enter**.
8. To save your changes and exit Computer Setup, click the **Save** icon in the lower-left corner of the screen, and then follow the on-screen instructions.

– or –

Use the arrow keys to select **File > Save Changes and Exit**, and then press **enter**.

Your changes go into effect when the computer restarts.

## Entering a BIOS administrator password

At the **BIOS administrator password** prompt, type your password (using the same kind of keys you used to set the password), and then press **enter**. After three unsuccessful attempts to enter the BIOS administrator password, you must restart the computer and try again.

## Using Computer Setup DriveLock

- 
- △ **CAUTION:** To prevent the DriveLock-protected hard drive from becoming permanently unusable, record the DriveLock user password and the DriveLock master password in a safe place away from your computer. If you forget both DriveLock passwords, the hard drive will be permanently locked and can no longer be used.
- 

DriveLock protection prevents unauthorized access to the contents of a hard drive. DriveLock can be applied only to the internal hard drive(s) of the computer. After DriveLock protection is applied to a drive, a password must be entered to access the drive. The drive must be inserted into the computer or an advanced port replicator in order for it to be accessed by the DriveLock passwords.

To apply DriveLock protection to an internal hard drive, a user password and a master password must be set in Computer Setup. Note the following considerations about using DriveLock protection:

- After DriveLock protection is applied to a hard drive, the hard drive can be accessed only by entering either the user password or the master password.
- The owner of the user password should be the day-to-day user of the protected hard drive. The owner of the master password may be either a system administrator or the day-to-day user.
- The user password and the master password can be identical.
- You can delete a user password or master password only by removing DriveLock protection from the drive. DriveLock protection can be removed from the drive only with the master password.

## Setting a DriveLock password

To set a DriveLock password in Computer Setup, follow these steps:

1. Turn on the computer, and then press **esc** while the “Press the ESC key for Startup Menu” message is displayed at the bottom of the screen.
2. Press **f10** to enter BIOS Setup.
3. Use a pointing device or the arrow keys to select **Security > DriveLock Password**, and then press **enter**.
4. Use a pointing device to click the hard drive you want to protect.

– or –

Use the arrow keys to select the hard drive you want to protect, and then press **enter**.

5. Read the warning. To continue, select **YES**.
6. Type your master password in the **New password** and **Verify new password** fields, and then press **enter**.
7. Type your user password in the **New password** and **Verify new password** fields, and then press **enter**.
8. To confirm DriveLock protection on the drive you have selected, type `DriveLock` in the confirmation field, and then press **enter**.



---

**NOTE:** The DriveLock confirmation is case sensitive.

---

9. To save your changes and exit Computer Setup, click the **Save** icon in the lower-left corner of the screen, and then follow the on-screen instructions.

– or –

Use the arrow keys to select **File > Save Changes and Exit**, and then press **enter**.

Your changes go into effect when the computer restarts.



## Entering a DriveLock password

Be sure that the hard drive is inserted into the computer (not into an optional docking device or external MultiBay).

At the **DriveLock Password** prompt, type your user or master password (using the same kind of keys you used to set the password), and then press [enter](#).

After two incorrect attempts to enter the password, you must shut down the computer and try again.

## Changing a DriveLock password

To change a DriveLock password in Computer Setup, follow these steps:

1. Turn on the computer, and then press **esc** while the “Press the ESC key for Startup Menu” message is displayed at the bottom of the screen.
2. Press **f10** to enter BIOS Setup.
3. Use a pointing device or the arrow keys to select **Security > DriveLock Password**, and then press **enter**.
4. Use a pointing device to select an internal hard drive.

– or –

Use the arrow keys to select an internal hard drive, and then press **enter**.

5. Use a pointing device or the arrow keys to select the password you want to change.
6. Type your current password in the **Old password** field, type a new password in the **New password** and **Verify new password** fields, and then press **enter**.
7. To save your changes and exit Computer Setup, click the **Save** icon in the lower-left corner of the screen, and then follow the on-screen instructions.

– or –

Use the arrow keys to select **File > Save Changes and Exit**, and then press **enter**.

Your changes go into effect when the computer restarts.

## Removing DriveLock protection

To remove DriveLock protection in Computer Setup, follow these steps:

1. Turn on the computer, and then press **esc** while the “Press the ESC key for Startup Menu” message is displayed at the bottom of the screen.
2. Press **f10** to enter BIOS Setup.
3. Use a pointing device or the arrow keys to select **Security > DriveLock Password**, and then press **enter**.
4. Use a pointing device or the arrow keys to select an internal hard drive, and then press **enter**.
5. Use a pointing device or the arrow keys to select **Disable protection**.
6. Type your master password, and then press **enter**.
7. To save your changes and exit Computer Setup, click the **Save** icon in the lower-left corner of the screen, and then follow the on-screen instructions.

– or –

Use the arrow keys to select **File > Save Changes and Exit**, and then press **enter**.

Your changes go into effect when the computer restarts.

## Using Computer Setup Auto DriveLock

In a multiple-user environment, you can set an Automatic DriveLock password. When the Automatic DriveLock password is enabled, a random user password and a DriveLock master password will be created for you. When any user passes the password credential, the same random user and DriveLock master password will be used to unlock the drive.



---

**NOTE:** You must have a BIOS administrator password before you can access the Automatic DriveLock features.

---

## Entering an Automatic DriveLock password

To enable an Automatic DriveLock password in Computer Setup, follow these steps:

1. Turn on or restart the computer, and then press **esc** while the “Press the ESC key for Startup Menu” message is displayed at the bottom of the screen.
2. Press **f10** to enter BIOS Setup.
3. Use a pointing device or the arrow keys to select **Security > Automatic DriveLock**, and then press **enter**.
4. Use a pointing device or the arrow keys to select an internal hard drive, and then press **enter**.
5. Read the warning. To continue, select **YES**.
6. To save your changes and exit Computer Setup, click the **Save** icon in the lower-left corner of the screen, and then follow the on-screen instructions.

– or –

Use the arrow keys to select **File > Save Changes and Exit**, and then press **enter**.

## Removing Automatic DriveLock protection

To remove DriveLock protection in Computer Setup, follow these steps:

1. Turn on or restart the computer, and then press **esc** while the “Press the ESC key for Startup Menu” message is displayed at the bottom of the screen.
2. Press **f10** to enter BIOS Setup.
3. Use a pointing device or the arrow keys to select **Security > Automatic DriveLock**, and then press **enter**.
4. Use a pointing device or the arrow keys to select an internal hard drive, and then press **enter**.
5. Use a pointing device or the arrow keys to select **Disable protection**.
6. To save your changes and exit Computer Setup, click the **Save** icon in the lower-left corner of the screen, and then follow the on-screen instructions.

– or –

Use the arrow keys to select **File > Save Changes and Exit**, and then press **enter**.

# Using Computer Setup security features

## Securing system devices

You can disable or enable system devices from the following menus in Computer Setup:

- Boot Options
- Device Configurations
- Built-In Device Options
- Port Options

To disable or reenable system devices in Computer Setup, follow these steps:

1. Turn on or restart the computer, and then press **esc** while the “Press the ESC key for Startup Menu” message is displayed at the bottom of the screen.
2. Press **f10** to enter BIOS Setup.
3. Use a pointing device or the arrow keys to select **System Configuration > Boot Options**, or **System Configuration > Device Configurations**, or **System Configuration > Built-In Device Options**, or **System Configuration > Port Options**.
4. Press **enter**.
5. To disable an option, use a pointing device to clear the checkbox next to the option.  
– or –  
Use the arrow keys to select the option, and then press **enter**.
6. To reenable an option, use a pointing device to check the box next to the option.  
– or –  
Use the arrow keys to select the option, and then press **enter**.
7. To save your changes and exit Computer Setup, click the **Save** icon in the lower-left corner of the screen, and then follow the on-screen instructions.  
– or –  
Use the arrow keys to select **File > Save Changes and Exit**, and then press **enter**.

Your changes go into effect when the computer restarts.

## Viewing Computer Setup System Information

The System Information feature in Computer Setup provides two types of system information:

- Identification information about the computer model and the batteries
- Specification information about the processor, cache, memory, ROM, video revision, and keyboard controller revision

To view this general system information in Computer Setup, follow these steps:

1. Turn on or restart the computer, and then press **esc** while the “Press the ESC key for Startup Menu” message is displayed at the bottom of the screen.
2. Press **f10** to enter BIOS Setup.
3. Use a pointing device or the arrow keys to select **File > System Information**, and then press **enter**.

---

 **NOTE:** To prevent unauthorized access to this information, you must create a BIOS administrator password in Computer Setup.

---

## Using Computer Setup System IDs

The System IDs feature in Computer Setup allows you to display or enter the computer asset tag and ownership tag.

---

 **NOTE:** To prevent unauthorized access to this information, you must create a BIOS administrator password in Computer Setup.

---

To manage this feature in Computer Setup, follow these steps:

1. Turn on or restart the computer, and then press **esc** while the “Press the ESC key for Startup Menu” message is displayed at the bottom of the screen.
2. Press **f10** to enter BIOS Setup.
3. Use a pointing device or the arrow keys to select **Security > System IDs**, and then press **enter**.
4. Use a pointing device or the arrow keys to select **Notebook Asset Tag** or **Notebook Ownership Tag**, and then enter the information.
5. Press **enter** when finished.
6. To save your changes and exit Computer Setup, click the **Save** icon in the lower-left corner of the screen, and then follow the on-screen instructions.

– or –

Use the arrow keys to select **File > Save Changes and Exit**, and then press **enter**.

Your changes go into effect when the computer restarts.

## Using antivirus software

When you use the computer to access e-mail, a network, or the Internet, you expose the computer to computer viruses. Computer viruses can disable the operating system, programs, or utilities, or cause them to function abnormally.

Antivirus software can detect most viruses, destroy them, and in most cases, repair any damage they have caused. To provide ongoing protection against newly discovered viruses, antivirus software must be kept up to date.

McAfee Total Protection antivirus software is either preinstalled or preloaded on the computer.

If the antivirus software is preinstalled, select **Start > All Programs > McAfee > Managed Services > Total Protection**.

If the software is preloaded, select **Start > All Programs > HP Software Setup**, and then follow the instructions on the screen to load the **McAfee Total Protection** software.

For more information about computer viruses, type `viruses` in the Search box in Help and Support.

## Using firewall software

When you use the computer to access e-mail, a network, or the Internet, unauthorized persons may be able to gain access to the computer, your personal files, and information about you. Use the firewall software preinstalled on the computer to protect your privacy. McAfee Total Protection antivirus software is preinstalled on the computer. To access your software, select **Start > All Programs > McAfee > Managing Services > Total Protection**.

Firewall features include logging and reporting of network activity, and automatic monitoring of all incoming and outgoing traffic. For more information, refer to the software manufacturer's instructions. These instructions may be provided with the software, on disc, or on the manufacturer's Web site.

---

 **NOTE:** Under some circumstances a firewall can block access to Internet games, interfere with printer or file sharing on a network, or block authorized e-mail attachments. To temporarily resolve the problem, disable the firewall, perform the task that you want to perform, and then reenable the firewall. To permanently resolve the problem, reconfigure the firewall as necessary, and adjust the policies and settings of other intrusion detection systems. For additional information, contact your network administrator or IT department.

---



## Installing critical updates

---

△ **CAUTION:** Microsoft sends alerts regarding critical updates. To protect the computer from security breaches and computer viruses, install all critical updates from Microsoft as soon as you receive an alert.

---

Updates to the operating system and other software may have become available *after* the computer was shipped. To be sure that all available updates are installed on the computer, observe these guidelines:

- Run Windows Update monthly to install the latest software from Microsoft.
- Obtain updates, as they are released, from the Microsoft Web site and through the updates link in Help and Support.

## Using HP ProtectTools Security Manager (select models only)

HP ProtectTools Security Manager software is preinstalled on select computer models. This software can be accessed through Windows Control Panel. It provides security features that help protect against unauthorized access to the computer, networks, and critical data. For more information, refer to the HP ProtectTools online Help.

## Installing a security cable

 **NOTE:** A security cable is designed to act as a deterrent, but it may not prevent the computer from being mishandled or stolen.

---

1. Loop the security cable around a secured object.
2. Insert the key (1) into the cable lock (2).
3. Insert the cable lock into the security cable slot on the computer (3), and then lock the cable lock with the key.

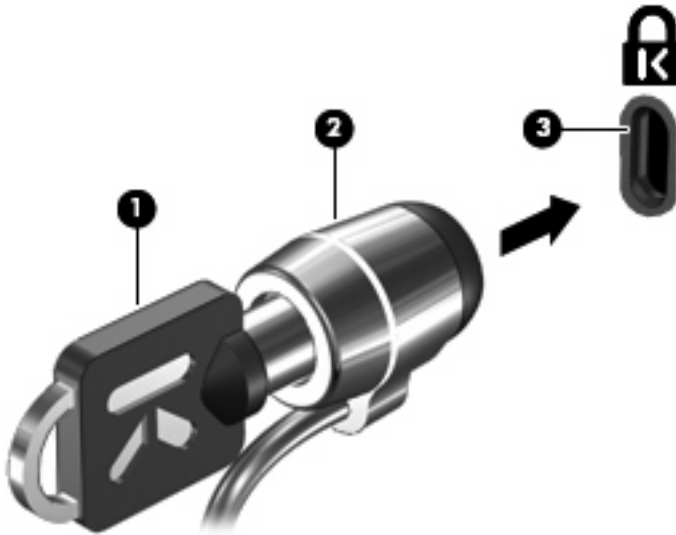

 **NOTE:** The location of the security cable slot varies by computer model.

---

---

# 11 Software updates

## Updating software

Updated versions of the software provided with your computer are available either through the HP Software Update utility or on the HP Web site.

The Software Update utility automatically checks for software updates from HP. The utility runs every 30 days and provides a list of support alerts, such as security enhancements, and optional software and driver updates.

You can manually check for updates at any time by selecting **Start > Help and Support > Software Drivers, and BIOS updates**, and then follow the on-screen instructions.

Most software on the HP Web site is packaged in compressed files called *SoftPaqs*. Some BIOS updates may be packaged in compressed files called *ROMPaqs*.

Some download packages contain a file named *Readme.txt*, which contains information regarding installing and troubleshooting the file. (*Readme.txt* files included with *ROMPaqs* are provided in English only.)

You can also access software updates by obtaining the *Support Software* disc (purchased separately). This disc includes device drivers, BIOS updates, and utilities.

To purchase the current *Support Software* disc or a subscription that provides both the current version and future versions of the disc, follow these steps:

1. Open your Internet browser, and go to <http://www.hp.com/support>.
2. Select your country or region.
3. Click the option for software and driver downloads, and then type your computer model number in the product box.
4. Press **enter**.
5. Follow the on-screen instructions.

To update the software using a *Support Software* disc, follow these steps:

1. Insert the *Support Software* disc into the optical drive.
2. Follow the on-screen instructions.

To update the software using the HP Web site, follow these steps:

1. Identify your computer model, product category, and series or family. Prepare for a system BIOS update by identifying the BIOS version currently installed on the computer. For details, refer to the "Determining the BIOS version" section.

If your computer is connected to a network, consult the network administrator before installing any software updates, especially system BIOS updates.

---

 **NOTE:** The computer system BIOS is stored on the system ROM. The BIOS initializes the operating system, determines how the computer will interact with the hardware devices, and provides for data transfer among hardware devices, including the time and date.

**NOTE:** Windows includes the User Account Control feature to improve the security of your computer. You may be prompted for your permission or password for tasks such as installing software, running utilities, or changing Windows settings. Refer to Windows Help and Support for more information.

---

2. Open your Internet browser, and go to <http://www.hp.com/support>.
3. Select your country or region.
4. Click the option for software and driver downloads, and then type your computer model number in the product box.
5. Press **enter**.
6. Follow the on-screen instructions.

# Updating the BIOS

To update the BIOS, first determine what BIOS version you currently have, and then download and install the new BIOS.

## Determining the BIOS version

BIOS version information (also known as *ROM date* and *System BIOS*) can be displayed by pressing **fn+esc** (if you are already in Windows) or by using Computer Setup.

To use Computer Setup for displaying BIOS information, follow these steps:

1. Turn on or restart the computer, and then press **esc** while the “Press the ESC key for Startup Menu” message is displayed at the bottom of the screen.
2. Press **f10** to enter BIOS Setup.
3. Use a pointing device or the arrow keys to select **File > System Information**.
4. Press **esc** to return to the **File** menu.
5. Click the **Exit** icon in the lower-left corner of the screen, and then follow the on-screen instructions.

– or –

Use the arrow keys to select **File > Ignore Changes and Exit**, and then press **enter**.

## Downloading a BIOS update

- △ **CAUTION:** To prevent damage to the computer or an unsuccessful installation, download and install a BIOS update only when the computer is connected to reliable external power using the AC adapter. Do not download or install a BIOS update while the computer is running on battery power, docked in an optional docking device, or connected to an optional power source. During the download and installation, follow these guidelines:

Do not disconnect power from the computer by unplugging the power cord from the AC outlet.

Do not shut down the computer or initiate Sleep or Hibernation.

Do not insert, remove, connect, or disconnect any device, cable, or cord.

To download a BIOS update:

- 📄 **NOTE:** BIOS updates are posted as needed. A newer BIOS update may not be available for your computer. It is recommended that you check the HP Web site periodically for BIOS updates.

1. Open your Internet browser, go to <http://www.hp.com/support>, and then select your country or region.
2. Click the option for software and driver downloads, type your computer model number in the product box, and then press **enter**.
3. Click your specific product from the models listed.
4. Click your operating system.
5. Follow the on-screen instructions to access the BIOS update you want to download. Make a note of the download date, name, or other identifier. You may need this information to locate the update later, after it has been downloaded to your hard drive.
6. At the download area, perform these steps:
  - a. Identify the BIOS update that is newer than the BIOS version currently installed on your computer.
  - b. Follow the instructions on the screen to download your selection to the hard drive.

Make a note of the path to the location on your hard drive where the BIOS update will be downloaded. You will need to access this path when you are ready to install the update.

- 📄 **NOTE:** If you connect your computer to a network, consult the network administrator before installing any software updates, especially system BIOS updates.

BIOS installation procedures vary. Follow any instructions that are displayed on the screen after the download is complete. If no instructions are displayed, follow these steps:

1. Open Windows Explorer by selecting **Start > Computer**.
2. Double-click your hard drive designation. The hard drive designation is typically Local Disk (C:).
3. Using the hard drive path you recorded earlier, open the folder on your hard drive that contains the update.
4. Double-click the file that has an .exe extension (for example, *filename.exe*).

The BIOS installation begins.

5. Complete the installation by following the on-screen instructions.

---

 **NOTE:** After a message on the screen reports a successful installation, you may delete the downloaded file from your hard drive.

---



# Updating programs and drivers

1. Open your Internet browser, go to <http://www.hp.com/support>, and then select your country or region.
2. Click the option for software and driver downloads, type your computer model number in the product box, and then press **enter**.

– or –

If you want a specific SoftPaq, type the SoftPaq number in the Search box, at the top-right corner of the screen. Then press **enter**, and follow the instructions provided. Proceed to step 6.

3. Click your specific product from the models listed.
4. Click your operating system.
5. When the list of updates is displayed, click an update to open a window containing additional information.
6. Click **Download**.
7. Click **Run** to install the updated driver without downloading the file.

– or –

Click **Save** to save the file to your computer. When prompted, select a storage location on your hard drive.

After the file is downloaded, navigate to the folder where the file was stored, and then double-click the file to install the update.

8. If prompted to do so, restart your computer after the installation is complete.

# Using SoftPaq Download Manager

HP SoftPaq Download Manager (SDM) is a tool that provides quick access to SoftPaq information for HP business computers without requiring the SoftPaq number. Using this tool, you can easily search for SoftPaqs and then download and unpack them.

SoftPaq Download Manager works by reading and downloading, from the HP FTP site, a published database file containing computer model and SoftPaq information. SoftPaq Download Manager allows you to specify one or more computer models to determine which SoftPaqs are available for download.

SoftPaq Download Manager checks the HP FTP site for updates to the database and software. If updates are found, they are downloaded and applied automatically.

---

 **NOTE:** SoftPaq Download Manager is preinstalled on select computer models only. To download SoftPaq Download Manager or obtain more information about using it, see the HP Web site at <http://www.hp.com/go/sdm>.

---

To download SoftPaqs:

1. Select **Start > All Programs > HP Software Setup > HP SoftPaq Download Manager**.
2. When the SoftPaq Download Manager opens for the first time, a window is displayed asking if you want to show only software for the computer you are using or to show the software for all supported models. Select **Show software for all supported models**. If you have used HP SoftPaq Download Manager previously, go to step 3.
  - a. Select your operating system and language filters in the Configuration Options window. The filters limit the number of options that are listed in the Product Catalog pane. For example, if only Windows Vista® Business is selected in the operating system filter, the only operating system that is displayed in the Product Catalog is Windows Vista Business.
  - b. To add other operating systems, change the filter settings in the Configuration Options window. Refer to the HP SoftPaq Download Manager software Help for more information.
3. In the left pane, click the plus sign (+) to expand the model list, and then select the model or models of the products you want to update.
4. Click **Find Available SoftPaqs** to download a list of available SoftPaqs for the selected computer.
5. Select from the list of available SoftPaqs, and then click **Download Only** if you have many SoftPaqs to download, because the SoftPaq selection and Internet connection speed determine how long the download process will take.

If you want to download only one or two SoftPaqs and have a high-speed Internet connection, click **Download & Unpack**.

6. Right-click **Install SoftPaq** in the SoftPaq Download Manager software to install the selected SoftPaqs on the computer.

---

# 12 Backup and recovery

To protect your information, use the Backup and Restore Center to back up individual files and folders, back up your entire hard drive (select models only), or create system restore points. In case of system failure, you can use the backup files to restore the contents of your computer.

The Backup and Restore Center provides the following options:

- Backing up individual files and folders
- Backing up the entire hard drive (select models only)
- Scheduling automatic backups (select models only)
- Creating system restore points
- Recovering individual files
- Restoring the computer to a previous state
- Recovering information using recovery tools

---

 **NOTE:** For detailed instructions, perform a search for these topics in Help and Support.

**NOTE:** In case of system instability, HP recommends that you print the recovery procedures and save them for later use.

---

## Backing up your information

Recovery after a system failure is as complete as your most current backup. You should create your initial backup immediately after software setup. As you add new software and data files, you should continue to back up your system on a regular basis to maintain a reasonably current backup.

You can back up your information to an optional external hard drive, a network drive, or discs.

Note the following when backing up:

- Store personal files in the Documents folder, and back it up regularly.
- Back up templates that are stored in their associated programs.
- Save customized settings that appear in a window, toolbar, or menu bar by taking a screen shot of your settings. The screen shot can be a time-saver if you have to reset your preferences.

To create a screen shot:

1. Display the screen you want to save.

2. Copy the screen image:

To copy only the active window, press **alt+fn+prt sc**.

To copy the entire screen, press **fn+prt sc**.

3. Open a word-processing document, and then select **Edit > Paste**.

The screen image is added to the document.

4. Save the document.

- When backing up to discs, use any of the following types of discs (purchased separately): CD-R, CD-RW, DVD+R, DVD+R DL, DVD-R, DVD-R DL, or DVD±RW. The discs you use will depend on the type of optical drive installed in your computer.

---

 **NOTE:** DVDs and DVDs with double-layer (DL) support store more information than CDs, so using them for backup reduces the number of recovery discs required.

---

- When backing up to discs, number each disc before inserting it into the optical drive of the computer.

To create a backup using Backup and Restore Center, follow these steps:

---

 **NOTE:** Be sure that the computer is connected to AC power before you start the backup process.

---

**NOTE:** The backup process may take over an hour, depending on file size and the speed of the computer.

---

1. Select **Start > All Programs > Maintenance > Backup and Restore Center**.

2. Follow the on-screen instructions to back up your entire computer (select models only) or your files.

---

 **NOTE:** Windows includes the User Account Control feature to improve the security of your computer. You may be prompted for your permission or password for tasks such as installing software, running utilities, or changing Windows settings. Refer to Windows Help and Support for more information.

---

# Performing a recovery

In case of system failure or instability, the computer provides the following tools to recover your files:

- Windows recovery tools: You can use the Backup and Restore Center to recover information you have previously backed up. You can also use Windows Startup Repair to fix problems that might prevent Windows from starting correctly.
- **f11** recovery tools: You can use the **f11** recovery tools to recover your original hard drive image. The image includes the Windows operating system and software programs installed at the factory.

---

 **NOTE:** If you are unable to boot (start up) your computer, you must purchase a Windows Vista® operating system DVD to reboot the computer and repair the operating system. For additional information, refer to the “Using a Windows Vista operating system DVD (purchased separately)” section in this guide.

---

## Using the Windows recovery tools

To recover information you previously backed up, follow these steps:

1. Select **Start > All Programs > Maintenance > Backup and Restore Center**.
2. Follow the on-screen instructions to recover your entire computer (select models only) or your files.

---

 **NOTE:** Windows includes the User Account Control feature to improve the security of your computer. You may be prompted for your permission or password for tasks such as installing software, running utilities, or changing Windows settings. Refer to Windows Help and Support for more information.

---

To recover your information using Startup Repair, follow these steps:

 **CAUTION:** Using Startup Repair completely erases hard drive contents and reformats the hard drive. All files you have created and any software installed on the computer are permanently removed. When reformatting is complete, the recovery process restores the operating system, as well as the drivers, software, and utilities from the backup used for recovery.

---

1. If possible, back up all personal files.
2. If possible, check for the presence of the Windows partition and the HP Recovery partition. To find the partitions, select **Start > Computer**.

---

 **NOTE:** If the Windows partition and the HP Recovery partition have been deleted, you must recover your operating system and programs using the Windows Vista operating system DVD and the *Driver Recovery* disc (both purchased separately). For additional information, refer to the “Using a Windows Vista operating system DVD (purchased separately)” section in this guide.

---

3. Restart the computer, and then press **f8** before the Windows operating system loads.
4. Select **Repair your computer**.
5. Follow the on-screen instructions.

---

 **NOTE:** For additional information on recovering information using the Windows tools, perform a search for these topics in Help and Support.

---

## Using f11

- △ **CAUTION:** Using **f11** completely erases hard drive contents and reformats the hard drive. All files you have created and any software installed on the computer are permanently removed. The **f11** recovery tool reinstalls the operating system and HP programs and drivers that were installed at the factory. Software not installed at the factory must be reinstalled.

To recover the original hard drive image using **f11**, follow these steps:

1. If possible, back up all personal files.
2. If possible, check for the presence of the HP Recovery partition. To find the partition, select **Start > Computer**.

 **NOTE:** If the HP Recovery partition has been deleted, you must recover your operating system and programs using the Windows Vista operating system DVD and the *Driver Recovery* disc (both purchased separately). For additional information, refer to the “Using a Windows Vista operating system DVD (purchased separately)” section in this guide.

3. Turn on or restart the computer, and then press **esc** while the “Press the ESC key for Startup Menu” message is displayed at the bottom of the screen.
4. Press **f11** while the “Press <F11> for recovery” message is displayed on the screen.
5. Follow the on-screen instructions.

## Using a Windows Vista operating system DVD (purchased separately)

If you are unable to boot (start up) your computer, you must purchase a Windows Vista operating system DVD to reboot the computer and repair the operating system. Make sure that your most recent backup (stored on discs or on an external drive) is easily accessible. To order a Windows Vista operating system DVD, go to <http://www.hp.com/support>, select your country or region, and then follow the on-screen instructions. You can also order the DVD by calling technical support. For contact information, refer to the *Worldwide Telephone Numbers* booklet included with the computer.

- △ **CAUTION:** Using a Windows Vista operating system DVD completely erases hard drive contents and reformats the hard drive. All files you have created and any software installed on the computer are permanently removed. When reformatting is complete, the recovery process helps you restore the operating system, as well as drivers, software, and utilities.

To initiate recovery using a Windows Vista operating system DVD, follow these steps:

 **NOTE:** This process takes several minutes.

1. If possible, back up all personal files.
2. Restart the computer, and then insert the Windows Vista operating system DVD into the optical drive before the Windows operating system loads.
3. When prompted, press any keyboard key.
4. Follow the on-screen instructions.
5. Click **Next**.
6. Select **Repair your computer**.
7. Follow the on-screen instructions.

---

# 13 Computer Setup

## Starting Computer Setup

Computer Setup is a preinstalled, ROM-based utility that can be used even when the operating system is not working or will not load.

 **NOTE:** Some of the Computer Setup menu items listed in this guide may not be supported by your computer.

**NOTE:** An external keyboard or mouse connected to a USB port can be used with Computer Setup only if USB legacy support is enabled.

To start Computer Setup, follow these steps:

1. Turn on or restart the computer, and then press **esc** while the “Press the ESC key for Startup Menu” message is displayed at the bottom of the screen.
2. Press **f10** to enter BIOS Setup.

## Using Computer Setup

### Navigating and selecting in Computer Setup

The information and settings in Computer Setup are accessed from the File, Security, Diagnostics, and System Configuration menus.

To navigate and select in Computer Setup, follow these steps:

1. Turn on or restart the computer, and then press **esc** while the “Press the ESC key for Startup Menu” message is displayed at the bottom of the screen.
  - To select a menu or a menu item, use the tab key and the keyboard arrow keys, and then press **enter**, or use a pointing device to click the item.
  - To scroll up and down, click the up arrow or the down arrow in the upper-right corner of the screen, or use the up arrow key or the down arrow key.
  - To close open dialog boxes and return to the main Computer Setup screen, press **esc**, and then follow the on-screen instructions.

 **NOTE:** You can use either a pointing device (TouchPad, pointing stick, or USB mouse) or the keyboard to navigate and make selections in Computer Setup.

2. Press **f10** to enter BIOS Setup.
3. Select the **File**, **Security**, or **System Configuration** menu.

To exit Computer Setup menus, choose one of the following methods:

- To exit Computer Setup menus without saving your changes, click the **Exit** icon in the lower-left corner of the screen, and then follow the on-screen instructions.  
  
– or –  
  
Use the tab key and the arrow keys to select **File > Ignore Changes and Exit**, and then press [enter](#).
- To save your changes and exit Computer Setup menus, click the **Save** icon in the lower-left corner of the screen, and then follow the on-screen instructions.  
  
– or –  
  
Use the tab key and the arrow keys to select **File > Save Changes and Exit**, and then press [enter](#).

Your changes go into effect when the computer restarts.

## Restoring factory settings in Computer Setup

---

 **NOTE:** Restoring defaults will not change the hard drive mode.

---

To return all settings in Computer Setup to the values that were set at the factory, follow these steps:

1. Turn on or restart the computer, and then press [esc](#) while the “Press the ESC key for Startup Menu” message is displayed at the bottom of the screen.
2. Press [f10](#) to enter BIOS Setup.
3. Use a pointing device or the arrow keys to select **File > Restore Defaults**.
4. Follow the on-screen instructions.
5. To save your changes and exit, click the **Save** icon in the lower-left corner of the screen, and then follow the on-screen instructions.

– or –

Use the arrow keys to select **File > Save Changes and Exit**, and then press [enter](#).

Your changes go into effect when the computer restarts.

---

 **NOTE:** Your password settings and security settings are not changed when you restore the factory settings.

---

## Computer Setup menus

The menu tables in this section provide an overview of Computer Setup options.

---

 **NOTE:** Some of the Computer Setup menu items listed in this chapter may not be supported by your computer.

---



## File menu

Select	To do this
System Information	<ul style="list-style-type: none"><li>• View identification information for the computer and the batteries in the system.</li><li>• View specification information for the processor, cache and memory size, system ROM, video revision, and keyboard controller version.</li></ul>
Set System Date and Time	Set or change the date and time on the computer.
System Diagnostics	Displays the following information: <ul style="list-style-type: none"><li>• System Information<ul style="list-style-type: none"><li>◦ Identification information for the computer and the batteries in the system.</li><li>◦ Specification information for the processor, cache and memory size, system ROM, video revision, and keyboard controller version.</li></ul></li><li>• Start-up Test—Verifies the system components needed for starting the computer.</li><li>• Run-In Test—Runs a comprehensive check on system memory.</li><li>• Hard Disk Test—Runs a comprehensive self-test on any hard drive in the system.</li><li>• Memory Test—Runs a comprehensive test on any memory installed in the computer.</li><li>• Battery Test—Runs a comprehensive test on any batteries installed in the computer.</li><li>• Error Log—Displays a log file if any errors have occurred.</li></ul>
Restore Defaults	Replace the configuration settings in Computer Setup with the original factory settings. (Hard drive mode, password settings, and security settings are not changed when you restore the factory settings.)
Reset BIOS security to factory default	Restore the BIOS security settings to the factory default.
Ignore Changes and Exit	Cancel any changes entered during the current session. Then exit and restart the computer.
Save Changes and Exit	Save any changes entered during the current session. Then exit and restart the computer. Your changes go into effect when the computer restarts.

## Security menu



**NOTE:** Some of the menu items listed in this section may not be supported by your computer.

Select	To do this
Setup BIOS Administrator Password	Set up a BIOS administrator password.

Select	To do this
User Management > Create a New BIOS User Account (requires a BIOS administrator password)	<ul style="list-style-type: none"> <li>Select from a list of BIOS users.</li> <li>Select from a list of ProtectTools users.</li> </ul>
Password Policy (requires a BIOS administrator password)	Revise password policy criteria.
HP SpareKey	Enable/disable HP SpareKey (enabled by default).
Always Prompt for HP SpareKey Enrollment	Enable/disable HP SpareKey enrollment (enabled by default).
Fingerprint Reset on Reboot (If Present)	Reset/clear the fingerprint reader ownership (select models only; disabled by default).
Change Password	Enter, change, or delete a BIOS administrator password.
HP SpareKey Enrollment	Enroll or reset HP SpareKey, which is a set of security questions and answers used if you forget your password.
Anti Theft > AT-p (select models only)	Enable/disable Anti-Theft Protection.
DriveLock Password	<ul style="list-style-type: none"> <li>Enable/disable DriveLock on any computer hard drive (enabled by default).</li> <li>Change a DriveLock user password or master password.</li> </ul> <p><b>NOTE:</b> DriveLock settings are accessible only when you enter Computer Setup by turning on (not restarting) the computer.</p>
Automatic DriveLock	Enable/disable Automatic DriveLock support (disabled by default).
Disk Sanitizer	<p>Run Disk Sanitizer to destroy all existing data on the primary hard drive or the drive in the upgrade bay.</p> <p><b>CAUTION:</b> If you run Disk Sanitizer, the data on the selected drive is destroyed permanently.</p>
System IDs	Enter a user-defined computer asset tracking number and ownership tag.

## System Configuration menu

 **NOTE:** Some of the listed System Configuration options may not be supported by your computer.

Select	To do this
Language	Change the Computer Setup language.

Select	To do this
Boot Options	<ul style="list-style-type: none"> <li>• Set a startup menu delay (in seconds).</li> <li>• Set the MultiBoot Express Boot Popup delay in seconds.</li> <li>• Enable/disable custom logo (disabled by default).</li> <li>• Enable/disable display diagnostic URL (enabled by default).</li> <li>• Enable/disable CD-ROM boot (enabled by default).</li> <li>• Enable/disable SD card boot (enabled by default).</li> <li>• Enable/disable floppy boot (enabled by default).</li> <li>• Enable/disable PXE internal NIC boot (enabled by default).</li> <li>• Enable/Disable Unified Extensible Firmware Interface (UEFI) Boot Mode (disabled by default).</li> <li>• Set the legacy boot order.</li> </ul>
Device Configurations	<ul style="list-style-type: none"> <li>• Enable/disable USB legacy support (enabled by default). When enabled, USB legacy support allows the following: <ul style="list-style-type: none"> <li>◦ Use of a USB keyboard in Computer Setup, even when a Windows operating system is not running.</li> <li>◦ Startup from bootable USB devices, including a hard drive, diskette drive, or optical drive connected by a USB port to the computer</li> </ul> </li> <li>• Select a parallel port mode: ECP (Enhanced Capabilities Port), standard, bidirectional, or EPP (Enhanced Parallel Port).</li> <li>• Enable/disable fan always on while connected to an AC outlet (enabled by default).</li> <li>• Enable/disable Data Execution Prevention (select models only). When enabled, the processor can disable some virus code execution, which helps to improve computer security (enabled by default).</li> <li>• Select a SATA (Serial Advanced Technology Attachment) device mode. The following options are available: <ul style="list-style-type: none"> <li>◦ AHCI (Advanced Host Controller Interface)</li> <li>◦ IDE (Integrated Drive Electronics)</li> <li>◦ RAID (Redundant Array of Independent Disks) (select models only)</li> </ul> </li> </ul>

---

Select	To do this
	<p data-bbox="893 220 1450 283"><b>NOTE:</b> Availability of these options varies by computer model.</p> <ul data-bbox="845 294 1450 987" style="list-style-type: none"><li data-bbox="845 294 1450 357">• Enable/disable secondary battery fast charge (enabled by default).</li><li data-bbox="845 367 1450 409">• Enable/disable HP QuickLook (enabled by default).</li><li data-bbox="845 420 1450 483">• Enable/disable preboot authentication on HP QuickLook boot (enabled by default).</li><li data-bbox="845 493 1450 535">• Enable/disable HP QuickWeb (enabled by default).</li><li data-bbox="845 546 1450 609">• Enable/disable HP QuickWeb write protect (disabled by default).</li><li data-bbox="845 619 1450 682">• Enable/disable virtualization technology (select models only; disabled by default).</li><li data-bbox="845 693 1450 756">• Enable/disable Intel TXT (Trusted Execution Technology) (select models only; disabled by default).</li><li data-bbox="845 766 1450 808">• Enable/disable Multi Core CPU (enabled by default).</li><li data-bbox="845 819 1450 861">• Enable/disable Intel HT technology (enabled by default).</li><li data-bbox="845 871 1450 913">• Enable/disable wake on USB (enabled by default).</li><li data-bbox="845 924 1450 987">• Enable/disable Num lock state at boot (disabled by default).</li></ul>

---

Select	To do this
Built-In Device Options	<ul style="list-style-type: none"> <li>• Enable/disable the wireless button state (enabled by default).</li> <li>• Enable/disable embedded WWAN device (select models only; enabled by default).</li> <li>• Enable/disable embedded WLAN Device (enabled by default).</li> <li>• Enable/disable the embedded Bluetooth device (enabled by default).</li> <li>• Enable/disable the network interface controller (LAN) (enabled by default).</li> <li>• Enable/disable LAN/WLAN switching (disabled by default).</li> <li>• Set the wake on LAN state. Options include the following: <ul style="list-style-type: none"> <li>◦ Disabled</li> <li>◦ Boot to Network (default setting)</li> <li>◦ Follow Boot Order</li> </ul> </li> <li>• Enable/disable the ambient light sensor (enabled by default).</li> <li>• Enable/disable the notebook upgrade bay device (enabled by default).</li> <li>• Enable/disable the fingerprint device (enabled by default).</li> <li>• Enable/disable the integrated camera (enabled by default).</li> <li>• Enable/disable the power monitor circuit (enabled by default).</li> <li>• Enable/disable the audio device (enabled by default).</li> <li>• Enable/disable a modem device (enabled by default).</li> <li>• Enable/disable the microphone (enabled by default).</li> <li>• Enable/disable the internal speakers (enabled by default).</li> </ul>

Select	To do this
Port Options	<p><b>NOTE:</b> All port options are enabled by default.</p> <ul style="list-style-type: none"> <li>• Enable/disable the serial port (select models only).</li> <li>• Enable/disable the parallel port (select models only).</li> <li>• Enable/disable the flash media reader.</li> <li>• Enable/disable the USB port.</li> </ul> <p><b>CAUTION:</b> Disabling the USB port also disables MultiBay devices and ExpressCard devices on the advanced port replicator.</p> <ul style="list-style-type: none"> <li>• Enable/disable the 1394 port (select models only).</li> <li>• Enable/disable the ExpressCard slot.</li> <li>• Enable/disable the eSATA port.</li> </ul>
AMT Options (select models only).	<p><b>NOTE:</b> All AMT options are disabled by default.</p> <ul style="list-style-type: none"> <li>• Enable/disable firmware verbosity.</li> <li>• Enable/disable AMT setup prompt (Ctrl-P).</li> <li>• Enable/disable USB key provisioning support.</li> <li>• Enable/disable unconfigure AMT on next boot.</li> <li>• Select terminal emulation mode. Options include the following: <ul style="list-style-type: none"> <li>◦ ANSI (default setting)</li> <li>◦ VT100</li> </ul> </li> <li>• Enable/disable firmware progress event support.</li> <li>• Enable/disable initiate Intel CIRA.</li> </ul>
Set Security Level	Change, view, or hide security levels for all BIOS menu items.
Restore Security Defaults	Restore the default security settings.

---

# 14 MultiBoot

## About the boot device order

As the computer starts, the system attempts to boot from enabled boot devices. The MultiBoot utility, which is enabled at the factory, controls the order in which the system selects a boot device. Boot devices can include optical drives, diskette drives, a network interface card (NIC), hard drives, and USB devices. Boot devices contain bootable media or files that the computer needs to start and operate properly.

---

 **NOTE:** Some boot devices must be enabled in Computer Setup before they can be included in the boot order.

---

The factory setting is for the computer to select the boot device by searching enabled boot devices and drive bay locations in the following order:

---

 **NOTE:** Some of the boot devices and drive bay locations listed may not be supported on your computer.

---

- Notebook upgrade bay
- Internal hard drive
- USB diskette drive
- USB CD-ROM
- USB hard drive
- Notebook Ethernet
- Secure Digital (SD) Memory Card
- Docking station upgrade bay
- External SATA drive

You can change the order in which the computer searches for a boot device by changing the boot order in Computer Setup. You can also press **esc** while the “Press the ESC key for Startup Menu” message is displayed at the bottom of the screen, and then press **f9**. Pressing **f9** displays a menu that shows the current boot devices and allows you to select a boot device. Or, you can use MultiBoot Express to set the computer to prompt you for a boot location each time the computer turns on or restarts.

If MultiBoot is disabled, the computer uses a fixed boot order that consists of first searching for a drive A boot device. If none is found, the computer looks for a drive C boot device. Drive A boot devices include optical drives and diskette drives. Drive C boot devices include optical drives and hard drives.

The NIC does not have an assigned drive letter.

---

 **NOTE:** An optical drive (such as a CD-ROM drive) can boot either as drive A or drive C, depending on the format of the boot CD.

---

The following list describes the factory setting for boot order in which drive letters A and C are assigned when MultiBoot is disabled. (The actual order varies by configuration.)

- Boot order for drive A boot devices:
  1. Optical drive in an optional docking device or in an optional external MultiBay that contains a disc formatted as drive A
  2. Optical drive in the internal MultiBay (select models only) that contains a disc formatted as drive A
  3. Diskette drive in an optional docking device or in an optional external MultiBay
- Boot order for drive C boot devices:
  1. Optical drive in an optional docking device or in an optional external MultiBay that contains a disc formatted as drive C
  2. Optical drive in the internal MultiBay (select models only) that contains a disc formatted as drive C
  3. Hard drive in the computer hard drive bay
  4. Hard drive in an optional docking device or in an optional external MultiBay

---

 **NOTE:** Because no drive letter is associated with the NIC, changing the boot order of a NIC does not affect the drive letters of the other devices.

---



# Enabling boot devices in Computer Setup

The computer will boot to a USB device or a NIC device only if the device has first been enabled in Computer Setup.

To start Computer Setup and enable a USB device or a NIC device as a boot device, follow these steps:

1. Turn on or restart the computer, and then press **esc** while the “Press the ESC key for Startup Menu” message is displayed at the bottom of the screen.
2. Press **f10** to enter BIOS Setup.
3. To enable bootable media in USB drives or in drives inserted into an optional docking device (select models only), use a pointing device or the arrow keys to select **System Configuration > Device Configurations**. Confirm that USB legacy support is selected.

---

 **NOTE:** The USB Port option must be enabled in order to use USB legacy support. It is enabled at the factory. If the port becomes disabled, reenable it by selecting **System Configuration > Port Options**, and then selecting **USB Port**.

---

– or –

To enable a NIC device, select **System Configuration > Boot Options**, and then selecting **PXE Internal NIC boot**.

4. To save your changes and exit Computer Setup, click the **Save** icon in the lower-left corner of the screen, and then follow the on-screen instructions.

– or –

Use the arrow keys to select **File > Save Changes and Exit**, and then press **enter**.

Your changes go into effect when the computer restarts.

---

 **NOTE:** To connect a NIC to a Preboot eXecution Environment (PXE) or Remote Program Load (RPL) server without using MultiBoot, press **esc** while the “Press the ESC key for Startup Menu” message is displayed at the bottom of the screen, and then quickly press **f12**.

---

## Considering boot order changes

Before changing the boot order, note the following considerations:

- When the computer restarts after the boot order has been changed, the computer attempts to start using the new boot order.
- If there is more than one type of boot device, the computer attempts to boot using the first of each type of boot device (except for optical devices). For example, if the computer is connected to an optional docking device (select models only) that contains a hard drive, this hard drive will be shown in the boot order as a USB hard drive. If the system attempts to boot from this USB hard drive and fails, it will not attempt to boot to the hard drive in the hard drive bay. Instead, it will try to boot to the next type of device in the boot order. However, if there are two optical devices, and the first optical device does not boot (either because it does not contain media or the media is not a boot disc), the system will try to boot to the second optical device.
- Changing the boot order also changes the logical drive designations. For example, if you start up from a CD-ROM drive with a disc formatted as drive C, that CD-ROM drive becomes drive C and the hard drive in the hard drive bay becomes drive D.
- The computer will boot from a NIC device only if the device has been enabled in the Built-In Device Options menu of Computer Setup and if booting from the device has been enabled in the Boot Options menu of Computer Setup. Booting from a NIC does not affect logical drive designations because no drive letter is associated with the NIC.
- Drives in an optional docking device (select models only) are treated like external USB devices in the boot order.

# Choosing MultiBoot preferences

You can use MultiBoot in the following ways:

- To set a new boot order that the computer uses each time it is turned on, by changing the boot order in Computer Setup.
- To dynamically choose the boot device, by pressing **esc** while the “Press the ESC key for Startup Menu” message is displayed at the bottom of the screen, and then pressing **f9** to enter the Boot Device Options menu.
- To use MultiBoot Express to set variable boot orders. This feature prompts you for a boot device each time the computer is turned on or restarted.

## Setting a new boot order in Computer Setup

To start Computer Setup and set a boot device order that the computer uses each time it is turned on or restarted, follow these steps:

1. Turn on or restart the computer, and then press **esc** while the “Press the ESC key for Startup Menu” message is displayed at the bottom of the screen.
2. Press **f10** to enter BIOS Setup.
3. Use a pointing device or the arrow keys to select the Legacy Boot Order list, and then press **enter**.
4. To move the device up in the boot order, use a pointing device to click the up arrow or press the **+ key**.  
  
– or –  
  
To move the device down in the boot order, click the down arrow or press the **- key**.
5. To save your changes and exit Computer Setup, click the **Save** icon in the lower-left corner of the screen, and then follow the on-screen instructions.

– or –

Use the arrow keys to select **File > Save Changes and Exit**, and then press **enter**.

Your changes go into effect when the computer restarts.

## Dynamically choosing a boot device using the F9 prompt

To dynamically choose a boot device for the current startup sequence, follow these steps:

1. Turn on or restart the computer, press **esc** while the “Press the ESC key for Startup Menu” message is displayed at the bottom of the screen.
2. Open the Boot Device Options menu, by pressing **f9**.
3. Use a pointing device or the arrow keys to select a boot device, and then press **enter**.

Your changes go into effect immediately.

## Setting a MultiBoot Express prompt

To start Computer Setup and set the computer to display the MultiBoot startup location menu each time the computer is started or restarted, follow these steps:

1. Turn on or restart the computer, and then press **esc** while the “Press the ESC key for Startup Menu” message is displayed at the bottom of the screen.
2. Press **f10** to enter BIOS Setup.
3. Use a pointing device or the arrow keys to select **System Configuration > Boot Options**, and then press **enter**.
4. In the **Express Boot Popup Delay (Sec)** field, enter the length of time in seconds that you want the computer to display the startup location menu before it defaults to the current MultiBoot setting. (When 0 is selected, the Express Boot startup location menu is not displayed.)
5. To save your changes and exit Computer Setup, click the **Save** icon in the lower-left corner of the screen, and then follow the on-screen instructions.

– or –

Use the arrow keys to select **File > Save Changes and Exit**, and then press **enter**.

Your changes go into effect when the computer restarts.

## Entering MultiBoot Express preferences

When the Express Boot menu displays during startup, you have the following choices:

- To specify a boot device from the Express Boot menu, select your preference within the allotted time, and then press **enter**.
- To prevent the computer from defaulting to the current MultiBoot setting, press any key before the allotted time expires. The computer will not start until you select a boot device and press **enter**.
- To allow the computer to start according to the current MultiBoot settings, wait for the allotted time to expire.

---

# 15 Management and printing

## Using Client Management Solutions

Client Management Solutions software provides standards-based solutions for managing client (user) desktop, workstation, notebook, and tablet computers in a networked environment.

Client management includes the following key capabilities and features:

- Initial software image deployment
- Remote system software installation
- Software management and updates
- ROM updates
- Tracking and security of computer assets (the hardware and software installed on the computer)
- Fault notification and recovery of certain system software and hardware components

---

 **NOTE:** Support for specific features described in this section may vary, depending on computer model and/or version of management software installed on the computer.

---

## Configuring and deploying a software image

The computer is shipped with a preinstalled system software image. The initial software image is configured during the first-time setup of the computer. After a brief software "unbundling" occurs, the computer is ready to be used.

A customized software image can be deployed (distributed) in one of the following ways:

- Installing additional software applications after unbundling the preinstalled software image
- Using software deployment tools, such as Altiris Deployment Solutions, to replace the preinstalled software with a customized software image
- Using a disk-cloning process to copy the contents from one hard drive to another

The deployment method you use depends on your organization's technology environment and processes.

---

 **NOTE:** The Computer Setup utility and other system features provide further assistance with configuration management and troubleshooting, power management, and the recovery of system software.

---

## Managing and updating software

HP provides several tools for managing and updating software on client computers:

- HP Client Manager for Altiris (select models only)

 **NOTE:** To download HP Client Manager for Altiris or to obtain more information about HP Client Manager for Altiris, see the HP Web site at <http://www.hp.com>.

---

- HP Client Configuration Manager (CCM) (select models only)
- HP System Software Manager (SSM)

### HP Client Manager for Altiris (select models only)

HP Client Manager for Altiris integrates Intelligent Manageability technology into Altiris software. HP Client Manager for Altiris provides superior hardware management capabilities for HP devices:

- Detailed views of hardware inventory for asset management
- System Checkup monitoring and diagnostics
- Web-accessible reporting of business-critical details, such as thermal warnings and memory alerts
- Remote updating of system software, such as device drivers and the system BIOS

 **NOTE:** Additional functionality can be added when HP Client Manager for Altiris is used with optional Altiris Solutions software (purchased separately).

---

When HP Client Manager for Altiris (installed on a client computer) is used with Altiris Solutions software (installed on an administrator computer), HP Client Manager for Altiris provides increased management functionality and centralized hardware management of client devices for the following IT life-cycle areas:

- Inventory and asset management
  - Software license compliance
  - Computer tracking and reporting
  - Computer lease contract information and fixed asset tracking
- System software deployment and migration
  - Windows migration
  - System deployment
  - Personality (personal user settings) migration

- Help desk and problem resolution
  - Management of help desk tickets
  - Remote troubleshooting
  - Remote problem resolution
  - Client disaster recovery
- Software and operations management
  - Ongoing client management
  - HP system software deployment
  - Application self-healing (the ability to identify and repair certain application problems)

Altiris Solutions software provides easy-to-use software distribution capabilities. HP Client Manager for Altiris enables communication with the Altiris Solutions software, which can be used to complete new hardware deployment or personality migration to a new operating system using easy-to-follow wizards. HP Client Manager for Altiris is available for download from the HP Web site.

When Altiris Solutions software is used in conjunction with HP System Software Manager or HP Client Manager for Altiris, administrators can also update the system BIOS and device driver software from a central console.

## HP Client Configuration Manager (CCM) (select models only)

HP CCM automates the management of software such as operating systems, programs, software updates, and content and configuration settings to ensure that each computer is maintained in the correct configuration. With these automated management solutions, you can manage software throughout the life cycle of the computer.

CCM enables you to perform the following tasks:

- Collect hardware and software inventory across multiple platforms
- Prepare a software package and conduct impact analysis prior to distribution
- Target individual computers, workgroups, or entire populations of computers for deployment and maintenance of software and content according to policies
- Provision and manage operating systems, applications, and content on distributed computers from any location
- Integrate CCM with help desks and other system management tools for seamless operations
- Leverage a common infrastructure for management of software and content on standard computing devices across any network for all enterprise users
- Scale to meet enterprise needs



## HP System Software Manager (SSM)

HP SSM lets you remotely update system-level software on multiple systems simultaneously. When executed on a client computer, SSM detects versions of both hardware and software, and then updates designated software from a central repository, known as a file store. Driver versions that are supported by SSM are denoted with a special icon on the HP driver download Web site and on the *Support Software* CD. To download the SSM utility or to obtain more information on SSM, see the HP Web site at <http://www.hp.com/go/ssm> (English only).

# Index

- A**
  - AC adapter
    - connecting 72
    - identifying 14
  - AC adapter light, identifying 9
  - administrator password 128
  - airport security devices 86
  - Altiris Deployment Solutions 169
  - AMT options
    - AMT setup prompt (Ctrl-P) 162
    - firmware progress event support 162
    - firmware verbosity 162
    - Initiate Intel CIRA 162
    - terminal emulation mode 162
    - unconfigure AMT on next boot 162
    - USB key provisioning support 162
  - antennas
    - WLAN 13
    - WWAN 13
  - Anti Theft 158
  - applications key, Windows 6, 7
  - audio devices, connecting
    - external 52
  - audio functions, checking 52
  - audio, configuring 55
  - audio-in (microphone) jack, identifying 8, 48
  - audio-out (headphone) jack, identifying 8, 48
  - Automatic DriveLock password
    - entering 135
    - removing 136
  - AutoPlay 58
- B**
  - Backup and Restore Center 151, 152
  - battery
    - calibrating 78
    - charging 75, 78
    - conserving power 81
    - disposing 82
    - inserting 74
    - low battery levels 76
    - recharging 81
    - removing 74
    - replacing 82
    - storing 81
  - battery bay 11, 15
  - battery charge, maximizing 76
  - battery light 75, 76
  - battery power 73
  - battery release latches, identifying 11, 74
  - battery temperature 81
  - battery, identifying 14
  - bays
    - battery 11, 15
  - BD
    - creating 60
    - playing 58, 63
    - removing 60, 61
  - BIOS administrator password 157
  - BIOS update
    - downloading 147
    - installing 147
  - Blu-ray Disc (BD) 56
  - Blu-ray R/RE DVD+/-RW SuperMulti DL Drive 56
  - Blu-ray ROM DVD±R SuperMulti DL Drive 56
  - Bluetooth
    - device 16
    - label 15
  - Bluetooth device 25
  - boot devices, enabling 165
  - boot options 159
  - boot order 159
  - built-in device
    - ambient light sensor 161
    - audio device 161
    - Bluetooth device 161
    - fingerprint reader 161
    - integrated camera 161
    - internal speakers 161
    - LAN/WLAN switching 161
    - microphone 161
    - modem 161
    - network interface controller (LAN) 161
    - power monitor circuit 161
    - Wake on LAN 161
    - wireless button 161
    - WLAN device 161
    - WWAN device 161
  - built-in device options 161
  - buttons
    - power 5
- C**
  - cable
    - LAN 33
    - modem 29
  - cables
    - eSATA 107
    - USB 105
  - calibrating battery 78
  - caps lock light, identifying 3
  - CD
    - copying 59
    - creating 60

- playing 58, 63
- protecting 50
- removing 60, 61
- writing to 50
- CD drive 90, 109
- Certificate of Authenticity label 15
- changing boot order 167
- charging batteries 75, 78
- checking audio functions 52
- components
  - additional hardware 14
  - bottom 11
  - display 11
  - front 7
  - left-side 9
  - right-side 8
  - top 1
- composite video 41
- computer information 146
- Computer Setup
  - BIOS administrator
    - password 129
  - device security 137
  - DriveLock password 131
  - enabling bootable
    - devices 165
  - File menu 157
  - navigating and selecting 155
  - restoring factory settings 156
  - Security menu 157
  - setting boot order 167
  - setting MultiBoot Express
    - prompt 168
  - System Configuration
    - menu 158
- Computer Setup utility 169
- configuring ExpressCards 112
- connecting to a WLAN 21
- Connection Manager icon 17
- connection, external power 72
- connector, power 9
- conservation, power 81
- copyright warning 59
- cord, power 14
- corporate WLAN connection 21
- country-specific modem cable
  - adapter 30
- critical battery level 77

**D**

- DayStart
  - identifying 42
- deployment, software 169
- device configurations 159
- device drivers
  - HP drivers 65
  - Microsoft drivers 66
  - reinstalling 65
- device security 137
- digital card
  - inserting 110
  - removing 111
  - stopping 111
- Disk Cleanup software 87
- Disk Defragmenter software 87
- disk sanitizer 158
- diskette drive 90, 109
- display
  - image, switching 40
  - screen brightness hotkeys 40
- drive light, identifying 7
- drive media 69
- DriveLock password
  - changing 134
  - description 131
  - entering 133
  - removing 135
  - setting 132
- DriveLock, automatic 158
- drives
  - Blu-ray R/RE DVD+/-RW
    - SuperMulti DL Drive 56
  - Blu-ray ROM DVD±R
    - SuperMulti DL Drive 56
  - boot order 159, 163
  - caring for 85
  - diskette 90, 109
  - DVD-ROM 56
  - DVD±R SuperMulti DL
    - LightScribe Drive 56
  - external 90, 109
  - hard 90, 91, 98, 109
  - optical 8, 9, 90, 109
  - See *also* hard drive; optical drive
- DVD
  - changing region setting 59
  - copying 59
  - creating 60
  - playing 58, 63

- protecting 50
- removing 60, 61
- writing to 50
- DVD drive 90, 109
- DVD region settings 59

**E**

- e-mail application hotkey 41
- earbuds 48
- embedded keypad keys,
  - identifying 6
- encryption 20
- eSATA cable, connecting 107
- eSATA devices
  - connecting 107
  - description 107
  - removing 107
  - stopping 107
- eSATA port, identifying 10
- esc key, identifying 6, 7
- Execution enabled 159
- ExpressCard
  - configuring 112
  - inserting 112
  - removing 113
  - removing insert 112
  - stopping 113
- ExpressCard slot,
  - identifying 10
- external audio devices,
  - connecting 52
- external drive 90, 109
- external monitor port 54
- external monitor port,
  - identifying 10

**F**

- f11 recovery 154
- File menu 157
- fingerprint reader, identifying 5
- firewall 20
- flick
  - three-finger 37
- fn key 38
- fn key, identifying 6, 7
- function keys, identifying 6, 7, 38

**G**

- gestures
  - TouchPad 36

- H**
- hard disk drive
  - external 90
  - HP 3D DriveGuard 88
  - installing 98
  - replacing 91
- hard drive
  - external 90, 109
  - HP 3D DriveGuard 88
  - installing 98
  - replacing 91
- hard drive recovery 154
- hardware, identifying 1
- HDMI port 41, 54
- headphone (audio-out) jack 8, 48
- headphones 48
- Hibernation
  - exiting 70
  - initiated during critical battery level 77
  - initiating 70
- hotkeys
  - audio CD or DVD controls 41
  - decreasing screen brightness 40
  - decreasing speaker volume 41
  - description 38
  - displaying system information 40
  - increasing screen brightness 40
  - increasing speaker volume 41
  - initiating Sleep 40
  - muting speaker sound 41
  - opening default e-mail application 41
  - opening Web browser 41
  - switching screen image 40
  - using 39
  - volume mute 48
- HP 3D DriveGuard 88
- HP Client Configuration Manager 170, 172
- HP Client Manager for Altiris 170
- HP Connection Manager software 18
- HP Mobile Broadband Module 22
- HP QuickLook 160
- HP SpareKey enrollment 158
- HP System Software Manager 170, 173
- hubs 105
- I**
- icons
  - Connection Manager 17
  - network status 17, 27
  - wireless 17
- image, computer 169
- initiating Sleep hotkey 40
- integrated keypad keys, identifying 7
- Intel HT Technology 160
- interference, minimizing 28
- internal display switch, identifying 4, 12
- internal microphone, identifying 12, 48
- Internet connection setup 19
- J**
- jacks
  - audio-in (microphone) 8, 48
  - audio-out (headphone) 8, 48
  - RJ-11 (modem) 8, 9
  - RJ-45 (network) 10
- K**
- keyboard
  - removing 95, 120
- keyboard hotkeys, identifying 38
- keypad keys, identifying 7
- keypad, embedded
  - enabling and disabling 44
  - switching key functions 44
  - using 44
- keypad, external
  - num lock 45
  - using 45
- keys
  - embedded keypad 6
  - esc 6, 7
  - fn 6, 7
  - function 6, 7
  - keypad 7
- Windows applications 6, 7
- Windows logo 6, 7
- L**
- labels
  - Bluetooth 15
  - HP Mobile Broadband Module 15
  - Microsoft Certificate of Authenticity 15
  - modem approval 15
  - regulatory 15
  - service tag 14
  - SIM 15
  - wireless certification 15
  - WLAN 15
- language, changing in Computer Setup 158
- latches, battery release 11
- legacy support, USB 155, 159
- light, drive 88
- lights
  - AC adapter 9
  - caps lock 3
  - drive 7
  - optical drive 8, 9
  - power 4
  - QuickLook 3
  - QuickWeb 3
  - TouchPad 2, 3
  - webcam 12
- local area network (LAN)
  - cable required 33
  - connecting cable 33
- logical drive designations 166
- low battery level 76
- M**
- maintenance
  - Disk Cleanup 87
  - Disk Defragmenter 87
- McAfee Total Protection 139, 140
- Media Card Reader, identifying 8
- media controls, hotkeys 41
- memory module
  - removing 120
  - replacing 116
- microphone (audio-in) jack 8
- microphone, internal 48

- Microsoft Certificate of Authenticity label 15
  - minimizing interference 28
  - modem approval label 15
  - modem cable
    - connecting 29
    - country-specific cable adapter 30
    - noise suppression circuitry 29
  - modem software
    - setting/adding location 30
    - travel connection problems 32
  - monitor port, external 10
  - monitor, connecting 54
  - mouse, external
    - connecting 38
    - setting preferences 34
  - Multi Core CPU 160
  - MultiBoot Express 163, 168
  - multimedia components, identifying 47
  - multimedia software
    - using 50
  - mute hotkey 48
- N**
- navigating
    - TouchPad 34
  - network cable
    - connecting 33
    - noise suppression circuitry 33
  - network key 27
  - network security codes
    - network key 27
    - SSID 27
  - Network Service Boot 165
  - network status icon 17, 27
  - NIC boot device 163, 165
  - noise suppression circuitry
    - modem cable 29
    - network cable 33
  - num lock, external keypad 45
  - numeric keypad 6, 7
- O**
- on and off
    - TouchPad turning 34
  - operating system
    - Microsoft Certificate of Authenticity label 15
    - Product Key 15
  - optical disc
    - removing 60
    - using 56
    - writing to 50
  - optical drive
    - playing 63
    - protecting 50
  - optical drive light, identifying 8, 9
  - optical drive, identifying 8, 9
- P**
- parallel port mode 159
  - passwords
    - administrator 128
    - BIOS administrator 129
    - DriveLock 131
    - user 128
  - pinching or zooming
    - TouchPad gestures 36
  - pointing devices
    - setting preferences 34
  - port options
    - 1394 port 162
    - eSATA port 162
    - ExpressCard slot 162
    - flash media reader 162
    - parallel port 162
    - serial port 162
    - USB port 162
  - ports
    - eSATA 10, 107
    - external monitor 10, 54
    - HDMI 10, 54
    - USB 8, 9, 10, 105
  - power
    - connecting 72
    - conserving 81
  - power button, identifying 5
  - power connector, identifying 9
  - power cord, identifying 14
  - power light, identifying 4
  - power plans 70
  - Product Key 15
  - product name and number, computer 14
  - programs
    - using multimedia 50
  - projector, connecting 54
  - protecting playback 63
  - public WLAN connection 21
  - PXE server 165
- Q**
- QuickLook
    - using 41
  - QuickLook light, identifying 3
  - QuickWeb
    - using 43
  - QuickWeb light, identifying 3
- R**
- readable media 69
  - recovery partition 154
  - region codes, DVD 59
  - regulatory information
    - modem approval label 15
    - regulatory label 15
    - wireless certification labels 15
  - release latches, battery 11, 74
  - restore
    - factory settings 157
    - security defaults 162
  - restoring
    - hard drive 154
  - RJ-11 (modem) jack, identifying 8, 9
  - RJ-45 (network) jack, identifying 10
  - rotating
    - TouchPad gestures 37
- S**
- SATA (Serial Advanced Technology Attachment) devices
    - AHCI (Advanced Host Controller Interface) 159
    - IDE (Integrated Drive Electronics) 159
  - screen brightness hotkeys 40
  - screen image, switching 40
  - scrolling
    - TouchPad gestures 36
  - Secondary Battery Fast Charge 160
  - security cable slot, identifying 9, 10

- Security menu
    - always prompt for HP SpareKey enrollment 158
    - Automatic DriveLock 158
    - change password 158
    - DriveLock 158
    - fingerprint reader reset 158
    - HP Sparekey 158
    - HP Sparekey enrollment 158
    - password policy 158
    - set up BIOS administrator password 157
    - System IDs 158
  - security, wireless 19
  - selecting
    - TouchPad 35
  - serial number, computer 14
  - service tag 14
  - set security level 162
  - setup of WLAN 19
  - setup utility
    - File menu 157
    - navigating and selecting 155
    - restoring factory settings 156
    - Security menu 157
    - System Configuration menu 158
  - setup, computer 1
  - shutting down 83
  - SIM
    - inserting 22
    - removing 23
  - SIM slot, identifying 11
  - Sleep
    - exiting 69
    - initiating 69
  - slots
    - ExpressCard 10
    - memory 115
    - security cable 9, 10
    - SIM 11
  - SoftPaqs, downloading 149
  - software
    - BIOS update 147
    - deployment 169
    - Disk Cleanup 87
    - Disk Defragmenter 87
    - HP Connection Manager 18
    - recovery 169
    - updates 170
  - updating programs and drivers 149
  - using 50
  - Wireless Assistant 18
  - speakers, identifying 4, 48
  - storing battery 81
  - switch cover
    - removing 93, 118
  - system
    - date and time 157
    - diagnostics 157
    - fan 159
    - IDs 158
    - information 157
  - System Configuration menu 158
  - system information
    - hotkey 40
- T**
- temperature 81
  - tips, webcam 67
  - TouchPad
    - gestures 36
    - identifying 2
    - navigating 34
    - pinching or zooming 36
    - rotating 37
    - scrolling 36
    - selecting 35
    - three-finger flick 37
    - turning on and off 34
    - using 34
  - TouchPad indicator, identifying 2, 3
  - traveling with the computer
    - modem approval label 15
  - troubleshooting
    - AutoPlay 64
    - device drivers 65
    - disc burning 64
    - disc does not play 63
    - external display 64
    - HP device drivers 65
    - Microsoft device drivers 66
    - modem 32
    - movie play 64
    - optical disc tray 61
    - optical drive detection 62
    - wireless network problems 26
  - turning off the computer 83
- U**
- Unified Extensible Firmware Interface (UEFI) mode 159
  - unresponsive system 83
  - updates, software 170
  - USB cable, connecting 105
  - USB devices
    - connecting 105
    - description 105
    - removing 105
    - stopping 105
  - USB hubs 105
  - USB legacy support 106, 155, 159
  - USB ports, identifying 8, 9, 10, 105
  - user password 128
  - using the webcam 67
- V**
- vents, identifying 9, 10
  - video transmission types 40
  - Virtualization Technology 160
  - volume
    - hotkeys 48
    - mute hotkey 48
  - volume, adjusting 48
- W**
- Web browser hotkey 41
  - Web sites
    - HP System Software Manager 173
  - webcam
    - identifying 12, 48
    - tips 67
    - using 67
  - webcam light, identifying 12
  - webcam properties, adjusting 67
  - Windows applications key, identifying 6, 7
  - Windows logo key, identifying 6, 7
  - Windows Vista operating system
    - DVD 154
  - wireless antennas 12
  - Wireless Assistant software 17, 18

- wireless button 17
- wireless certification label 15
- wireless controls
  - button 17
  - operating system 17
  - Wireless Assistant software 17
- wireless devices, types 16
- wireless icon 17
- wireless light 17
- wireless network (WLAN)
  - connecting 21
  - corporate WLAN connection 21
  - described 16
  - equipment needed 19
  - functional range 21
  - public WLAN connection 21
  - security 19
  - using 19
- wireless network problems, troubleshooting 26
- WLAN antennas, identifying 13
- WLAN device 15, 16, 19
- WLAN label 15
- writable media 69
- WWAN antennas, identifying 13
- WWAN device 16, 22

