

# HP EliteBook Notebook PC

## User Guide

© Copyright 2010 Hewlett-Packard  
Development Company, L.P.

Bluetooth is a trademark owned by its proprietor and used by Hewlett-Packard Company under license. Intel and Centrino are trademarks or registered trademarks of Intel Corporation or its subsidiaries in the United States and other countries. Java is a U.S. trademark of Sun Microsystems, Inc. Microsoft and Windows are U.S. registered trademarks of Microsoft Corporation. SD Logo is a trademark of its proprietor.

The information contained herein is subject to change without notice. The only warranties for HP products and services are set forth in the express warranty statements accompanying such products and services. Nothing herein should be construed as constituting an additional warranty. HP shall not be liable for technical or editorial errors or omissions contained herein.

First Edition: March 2010

Document Part Number: 592931-001

#### **Product notice**

This user guide describes features that are common to most models. Some features may not be available on your computer.

## Safety warning notice

- 
- ⚠ **WARNING!** To reduce the possibility of heat-related injuries or of overheating the computer, do not place the computer directly on your lap or obstruct the computer air vents. Use the computer only on a hard, flat surface. Do not allow another hard surface, such as an adjoining optional printer, or a soft surface, such as pillows or rugs or clothing, to block airflow. Also, do not allow the AC adapter to contact the skin or a soft surface, such as pillows or rugs or clothing, during operation. The computer and the AC adapter comply with the user-accessible surface temperature limits defined by the International Standard for Safety of Information Technology Equipment (IEC 60950).
-



---

# Table of contents

## 1 Features

Identifying hardware .....	1
Top components .....	1
Pointing devices .....	1
Lights .....	3
Buttons and fingerprint reader .....	4
Keys .....	6
Front components .....	6
Rear components .....	7
Right-side components .....	8
Left-side components .....	8
Bottom components .....	10
Display components .....	11
Additional hardware components .....	12
Identifying the labels .....	13

## 2 Networking (select models only)

Wireless connections .....	16
Creating a wireless connection .....	16
Identifying wireless and network icons .....	16
Using the wireless controls .....	16
Using the wireless button .....	17
Using Wireless Assistant software .....	17
Using HP Connection Manager (select models only) .....	17
Using operating system controls .....	17
Using a WLAN .....	18
Setting up a WLAN .....	18
Protecting your WLAN .....	18
Connecting to a WLAN .....	20
Roaming to another network .....	20
Using HP Mobile Broadband (select models only) .....	20
Inserting a SIM .....	21
Removing a SIM .....	22
Using a Bluetooth wireless device .....	23

Bluetooth and Internet Connection Sharing (ICS) .....	23
Troubleshooting wireless connection problems .....	24
Cannot create a WLAN connection .....	24
Cannot connect to a preferred network .....	25
Current network security codes are unavailable .....	25
WLAN connection is very weak .....	26
Cannot connect to the wireless router .....	26
Wired connections .....	27
Connecting to a local area network (LAN) .....	27
Using the modem (select models only) .....	27
Connecting a modem cable (select models only) .....	28
Connecting a country- or region-specific modem cable adapter (select models only) .....	28
Selecting a location setting .....	29
Viewing the current location selection .....	29
Adding new locations when traveling .....	29
Solving travel connection problems .....	31

### 3 Pointing devices and keyboard

Using pointing devices .....	33
Setting pointing device preferences .....	33
Using the TouchPad .....	33
Using the pointing stick .....	33
Connecting an external mouse .....	33
Using the keyboard .....	34
Using the keyboard light .....	34
Using hotkeys .....	34
Using HP QuickLook 3 .....	36
Using keypads .....	36
Using the embedded numeric keypad .....	37
Enabling and disabling the embedded numeric keypad .....	37
Switching key functions on the embedded numeric keypad .....	37
Using an optional external numeric keypad .....	37
Cleaning the TouchPad and keyboard .....	38

### 4 Multimedia

Multimedia features .....	39
Identifying your multimedia components .....	39
Multimedia software .....	41
Accessing your preinstalled multimedia software .....	41
Installing multimedia software from a disc .....	41
Audio .....	42
Adjusting the volume .....	42

Connecting external audio devices .....	43
Checking your audio functions .....	43
Video .....	44
Connecting an external monitor or projector .....	44
Using the external monitor port .....	44
Using the DisplayPort .....	45
Optical drives (select models only) .....	46
Identifying the installed optical drive .....	46
Playing a CD or DVD .....	46
Changing DVD region settings .....	47
Creating (burning) a CD or DVD .....	47
Removing an optical disc (CD or DVD) .....	48
Webcam .....	49
Adjusting webcam properties .....	49
Controlling the webcam focus .....	50
Capturing business card images .....	50

## 5 Power management

Setting power options .....	52
Using power-saving states .....	52
Initiating and exiting Standby .....	52
Initiating and exiting Hibernation .....	53
Using the Power Meter .....	53
Using power schemes .....	54
Viewing the current scheme .....	54
Selecting a different power scheme .....	54
Customizing power schemes .....	55
Setting password protection upon exiting Standby .....	55
Using external AC power .....	55
Connecting the AC adapter .....	56
Using battery power .....	56
Displaying the remaining battery charge .....	57
Inserting or removing the battery .....	57
Charging a battery .....	58
Maximizing battery discharge time .....	59
Managing low battery levels .....	59
Identifying low battery levels .....	60
Resolving a low battery level .....	61
Resolving a low battery level when external power is available .....	61
Resolving a low battery level when a charged battery is available .....	61
Resolving a low battery level when no power source is available .....	61

Resolving a low battery level when the computer cannot exit Hibernation .....	61
Calibrating a battery .....	61
Step 1: Fully charge the battery .....	61
Step 2: Disable Hibernation and Standby .....	62
Step 3: Discharge the battery .....	62
Step 4: Fully recharge the battery .....	63
Step 5: Reenable Hibernation and Standby .....	63
Conserving battery power .....	63
Storing a battery .....	63
Disposing of a used battery .....	64
Replacing the battery .....	64
Testing an AC adapter .....	65
Shutting down the computer .....	65

## 6 Drives

Identifying installed drives .....	67
Handling drives .....	67
Improving hard drive performance .....	69
Using Disk Defragmenter .....	69
Using Disk Cleanup .....	69
Using HP 3D DriveGuard .....	70
Identifying HP 3D DriveGuard status .....	70
Using HP 3D DriveGuard software .....	70
Using RAID (select models only) .....	72
Replacing a hard drive .....	73
Replacing a 1.8-inch hard drive .....	73
Replacing a 2.5-inch hard drive .....	78

## 7 External devices

Using a USB device .....	85
Connecting a USB device .....	85
Removing a USB device .....	86
Using USB legacy support .....	86
Using 1394 devices .....	87
Connecting a 1394 device .....	87
Removing a 1394 device .....	87
Using the docking connector .....	88
Using external drives .....	89
Using optional external devices .....	89
Using an optional external optical drive .....	90
Inserting an optical disc (CD or DVD) .....	90
Removing an optical disc (CD or DVD) .....	91



When the disc tray opens .....	91
When the disc tray does not open .....	91

## 8 External media cards

Using SD Card Reader cards .....	93
Inserting a digital card .....	93
Removing a digital card .....	93
Using ExpressCards .....	94
Configuring an ExpressCard .....	94
Inserting an ExpressCard .....	94
Removing an ExpressCard .....	95
Using smart cards .....	96
Inserting a smart card .....	97
Removing a smart card .....	97

## 9 Memory modules

Adding or replacing a memory module in the expansion memory module slot .....	99
Upgrading a memory module in the primary memory module slot .....	102

## 10 Security

Protecting the computer .....	110
Using passwords .....	111
Setting passwords in Windows .....	111
Setting passwords in Computer Setup .....	111
BIOS administrator password .....	112
Managing a BIOS administrator password .....	113
Entering a BIOS administrator password .....	115
Using Computer Setup DriveLock .....	115
Setting a DriveLock password .....	116
Entering a DriveLock password .....	117
Changing a DriveLock password .....	118
Removing DriveLock protection .....	119
Using Computer Setup Auto DriveLock .....	119
Entering an Automatic DriveLock password .....	119
Removing Automatic DriveLock protection .....	120
Using Computer Setup security features .....	121
Securing system devices .....	121
Viewing Computer Setup System Information .....	121
Using Computer Setup System IDs .....	122
Using antivirus software .....	123
Using firewall software .....	124
Installing critical security updates .....	125
Using HP ProtectTools Security Manager (select models only) .....	126

Installing a security cable .....	127
<b>11 Software updates</b>	
Updating software .....	128
Updating the BIOS .....	129
Determining the BIOS version .....	129
Downloading a BIOS update .....	130
Updating programs and drivers .....	131
Using SoftPaq Download Manager .....	131
<b>12 MultiBoot</b>	
About the boot device order .....	133
Enabling boot devices in Computer Setup .....	134
Considering boot order changes .....	135
Choosing MultiBoot preferences .....	136
Setting a new boot order in Computer Setup .....	136
Dynamically choosing a boot device using the f9 prompt .....	136
Setting a MultiBoot Express prompt .....	137
Entering MultiBoot Express preferences .....	137
<b>13 Management</b>	
Using Client Management Solutions .....	138
Configuring and deploying a software image .....	138
Managing and updating software .....	139
HP Client Manager for Altiris (select models only) .....	139
HP CCM (Client Configuration Manager) (select models only) .....	141
HP SSM (System Software Manager) .....	142
Using Intel Active Management Technology (select models only) .....	143
Enabling the iAMT solution .....	143
Using the MEBx setup utility menus .....	143
<b>14 Computer Setup</b>	
Starting Computer Setup .....	145
Using Computer Setup .....	145
Navigating and selecting in Computer Setup .....	145
Restoring factory settings in Computer Setup .....	146
Computer Setup menus .....	146
File menu .....	147
Security menu .....	147
System Configuration menu .....	148

## 15 Backing up and recovering

Backing up your information .....	154
Performing a recovery .....	155
Recovering your information .....	155
Recovering the operating system and programs .....	155

<b>Index .....</b>	<b>156</b>
--------------------	------------



# 1 Features

## Identifying hardware

Components included with the computer may vary by region and model. The illustrations in this chapter identify the standard features on most computer models.

To see a list of hardware installed in the computer, follow these steps:

1. Select **Start > My Computer**.
2. In the left pane of the System Tasks window, select **View system information**.
3. Select **Hardware** tab > **Device Manager**.

You can also add hardware or modify device configurations using Device Manager.

## Top components

### Pointing devices

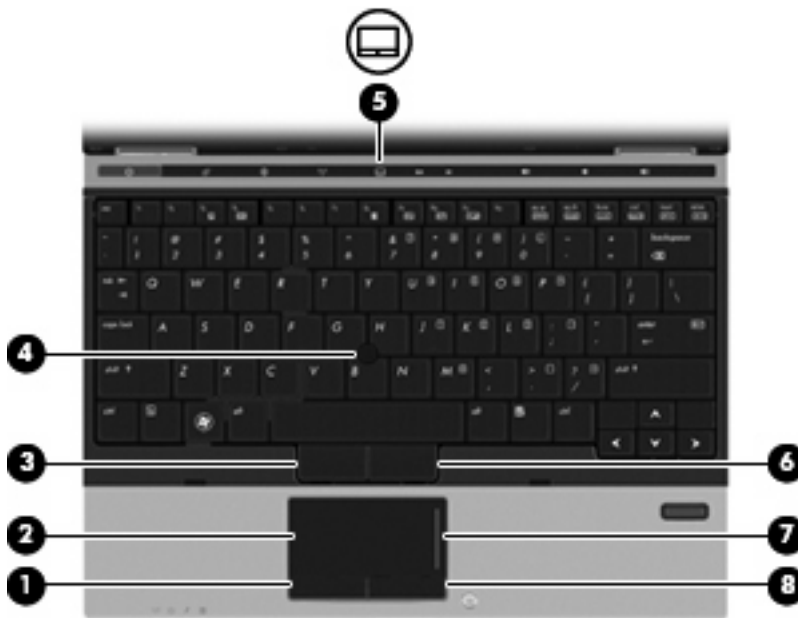

Component	Description
(1) Left TouchPad button*	Functions like the left button on an external mouse.
(2) TouchPad*	Moves the pointer and selects or activates items on the screen.

Component	Description
(3) Left pointing stick button*	Functions like the left button on an external mouse.
(4) Pointing stick*	Moves the pointer and selects or activates items on the screen.
(5) TouchPad on/off button	Turns the TouchPad on and off.
(6) Right pointing stick button*	Functions like the right button on an external mouse.
(7) TouchPad scroll zone	Scrolls up or down.
(8) Right TouchPad button*	Functions like the right button on an external mouse.

\*This table describes factory settings. To view or change pointing device preferences, select **Start > Control Panel > Printers and Other Hardware > Mouse**.

## Lights



Component	Description
(1) Power light	<ul style="list-style-type: none"> <li>On: The computer is on.</li> <li>Blinking: The computer is in Standby.</li> <li>Off: The computer is off or in Hibernation.</li> </ul>
(2) QuickLook light	<ul style="list-style-type: none"> <li>On: The computer is on.</li> <li>Off: The computer is off or in Standby or Hibernation.</li> </ul>
(3) QuickWeb light	<ul style="list-style-type: none"> <li>On: The computer is on.</li> <li>Off: The computer is off or in Standby or Hibernation.</li> </ul>
(4) Wireless light	<ul style="list-style-type: none"> <li>Blue: An integrated wireless device, such as a wireless local area network (WLAN) device, the HP Mobile Broadband Module (select models only), and/or a Bluetooth® device, is on.</li> <li>Amber: All wireless devices are off.</li> </ul>
(5) TouchPad on/off light	<ul style="list-style-type: none"> <li>White: TouchPad is on.</li> <li>Amber: TouchPad is off.</li> </ul>
(6) Caps lock light	On: Caps lock is on.
(7) Num lock light	On: Num lock is on or the embedded numeric keypad is enabled.
(8) Volume mute light	<ul style="list-style-type: none"> <li>White: Speaker sound is on.</li> <li>Amber: Speaker sound is off.</li> </ul>

Component	Description
(9) Volume down light	Blinking: The volume down button is being used to decrease the speaker volume.
(10) Volume up light	Blinking: The volume up button is being used to increase the speaker volume.

## Buttons and fingerprint reader

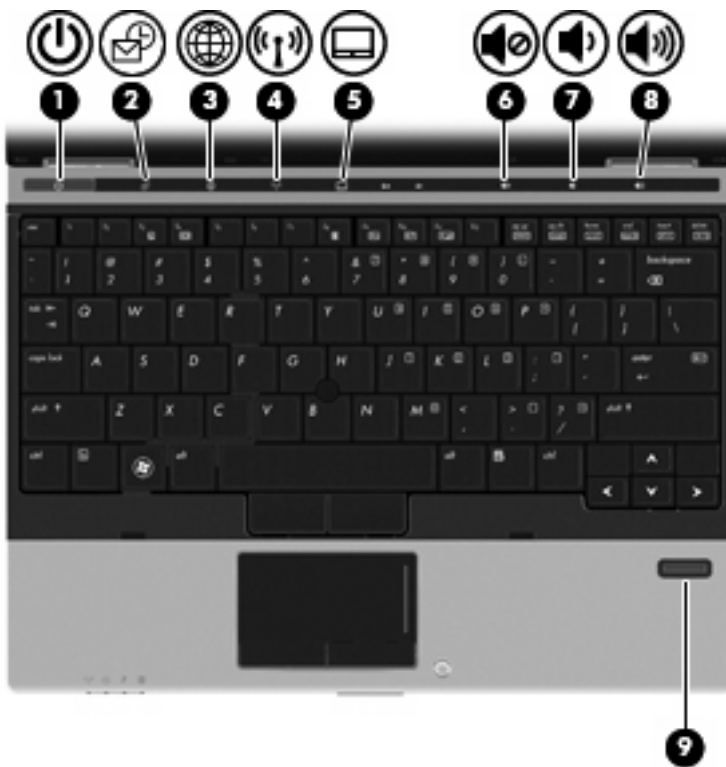



Component	Description
(1) Power button	<ul style="list-style-type: none"> <li>• When the computer is off, press the button to turn on the computer.</li> <li>• When the computer is on, press the button to shut down the computer.</li> </ul> <p><b>NOTE:</b> Although you can shut down the computer with the power button, the recommended procedure is to use the Windows Shut Down command.</p> <ul style="list-style-type: none"> <li>• When the computer is in Standby, press the button briefly to exit Standby.</li> <li>• When the computer is in Hibernation, press the button briefly to exit Hibernation.</li> </ul> <p>If the computer has stopped responding and Windows shutdown procedures are ineffective, press and hold the power button for at least 5 seconds to turn off the computer.</p> <p>To learn more about your power settings, select <b>Start &gt; Control Panel &gt; Performance and Maintenance &gt; Power Options</b>.</p>
(2) QuickLook button	<ul style="list-style-type: none"> <li>• When the computer is off, press the button to open HP QuickLook.</li> <li>• When the computer is on, press the button to open HP Software Setup.</li> </ul> <p><b>NOTE:</b> If HP Software Setup is not available, the default Web browser opens.</p>
(3) QuickWeb button	<ul style="list-style-type: none"> <li>• When the computer is off, press the button to open HP QuickWeb.</li> <li>• When the computer is on, press the button to open the default Web browser.</li> </ul>
(4) Wireless button	<p>Turns the installed wireless devices on or off but does not establish a wireless connection.</p> <p><b>NOTE:</b> A wireless network must be set up in order to establish a wireless connection.</p>
(5) TouchPad on/off button	Turns the TouchPad on or off.
(6) Volume mute button	Mutes and restores speaker sound.
(7) Volume down button	Decreases speaker volume.
(8) Volume up button	Increases speaker volume.
(9) Fingerprint reader	Allows a fingerprint logon to Windows, instead of a password logon.

## Keys

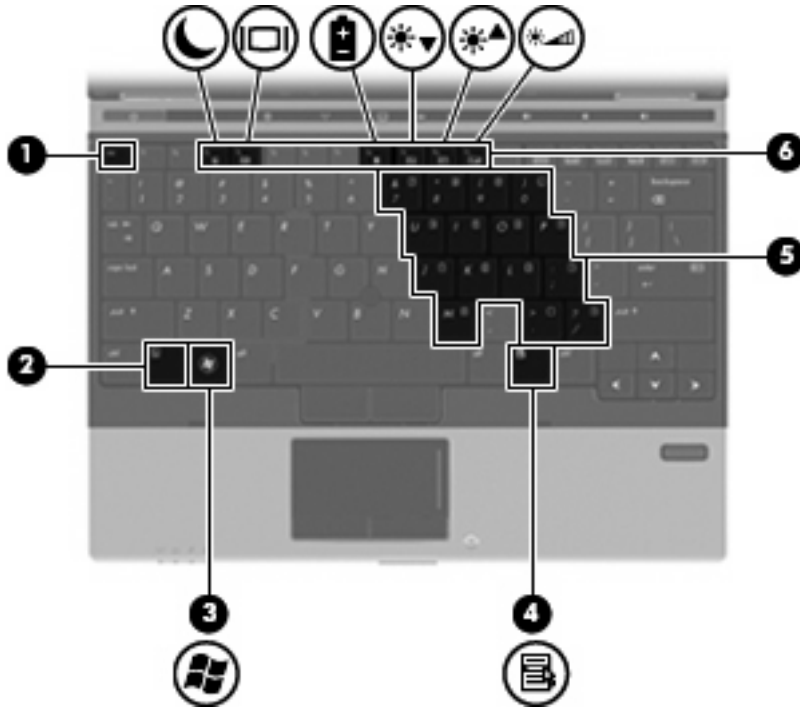

Component	Description
(1) <code>esc</code> key	Displays system information when pressed in combination with the <code>fn</code> key.
(2) <code>fn</code> key	Executes frequently used system functions when pressed in combination with a function key or the <code>esc</code> key.
(3) Windows logo key	Displays the Windows Start menu.
(4) Windows applications key	Displays a shortcut menu for items beneath the pointer.
(5) Embedded numeric keypad keys	Can be used like the keys on an external numeric keypad.
(6) Function keys	Execute frequently used system functions when pressed in combination with the <code>fn</code> key.

## Front components

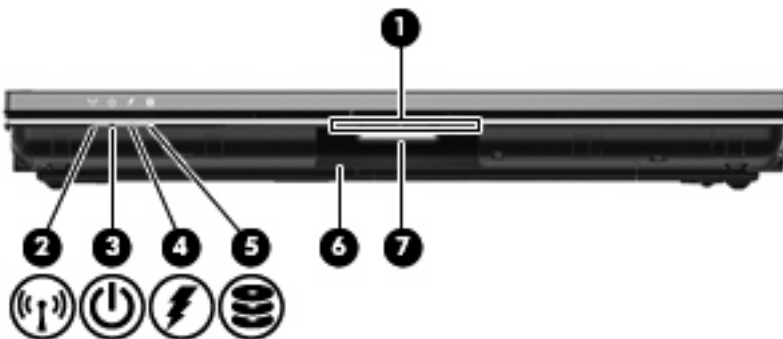

Component	Description
(1) Business card slot	Holds a business card in position so that the webcam can capture the information on the card.
(2) Wireless light	<ul style="list-style-type: none"> <li>Blue: An integrated wireless device, such as a wireless local area network (WLAN) device, the HP Mobile Broadband Module (select models only), and/or a Bluetooth device, is on.</li> <li>Amber: All wireless devices are off.</li> </ul>
(3) Power light	<ul style="list-style-type: none"> <li>On: The computer is on.</li> <li>Blinking: The computer is in Standby.</li> <li>Off: The computer is off or in Hibernation.</li> </ul>
(4) Battery light	<ul style="list-style-type: none"> <li>Amber: A battery is charging.</li> <li>White: A battery is close to full charge capacity.</li> <li>Blinking amber: A battery that is the only available power source has reached a low battery level. When the battery reaches a critical battery level, the battery light begins blinking rapidly.</li> <li>Off: If the computer is plugged into an external power source, the light turns off when all batteries in the computer are fully charged. If the computer is not plugged into an external power source, the light stays off until the battery reaches a low battery level.</li> </ul>
(5) Drive light	<ul style="list-style-type: none"> <li>White: The hard drive or optical drive is being accessed.</li> <li>Amber: HP 3D DriveGuard has temporarily parked the hard drive.</li> </ul>
(6) Speakers (2)	Produce sound.
(7) Display release button	Opens the computer.

## Rear components



Component	Description
(1) RJ-45 (network) jack	Connects a network cable.
(2) USB ports (2)	Connect optional USB devices.

## Right-side components

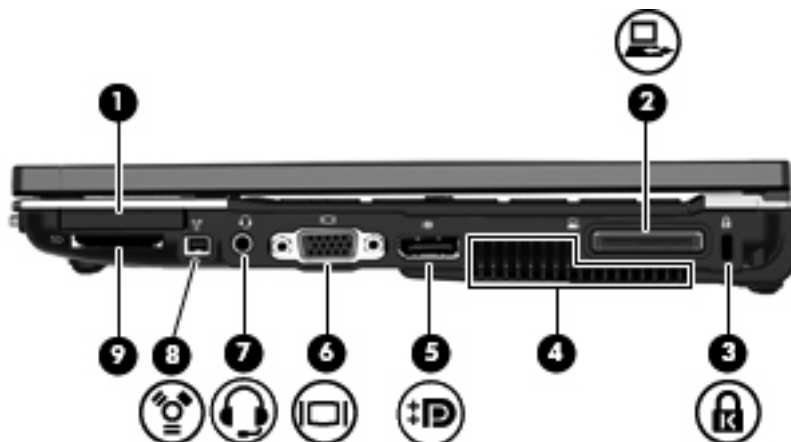

Component	Description
(1) ExpressCard slot	Supports optional ExpressCards.
(2) Docking connector	Connects an optional docking device.
(3) Security cable slot	Attaches an optional security cable to the computer. <b>NOTE:</b> The security cable is designed to act as a deterrent, but it may not prevent the computer from being mishandled or stolen.
(4) Vent	Enables airflow to cool internal components. <b>NOTE:</b> The computer fan starts up automatically to cool internal components and prevent overheating. It is normal for the internal fan to cycle on and off during routine operation.
(5) DisplayPort	Connects a digital display device, such as a high-performance monitor or projector.
(6) External monitor port	Connects an external VGA monitor or projector.
(7) Audio-out (headphone) jack/Audio-in (microphone) jack	Produces sound when connected to optional powered stereo speakers, headphones, ear buds, a headset, or television audio. Also connects an optional headset microphone. <b>NOTE:</b> When a device is connected to the headphone jack, the computer speakers are disabled.
(8) 1394 port	Connects an optional IEEE 1394 or 1394a device, such as a camcorder.
(9) SD Card Reader	Supports the MultiMediaCard (MMC) and Secure Digital (SD) Memory Card optional digital card formats.

## Left-side components

 **NOTE:** Refer to the illustration that most closely matches your computer.

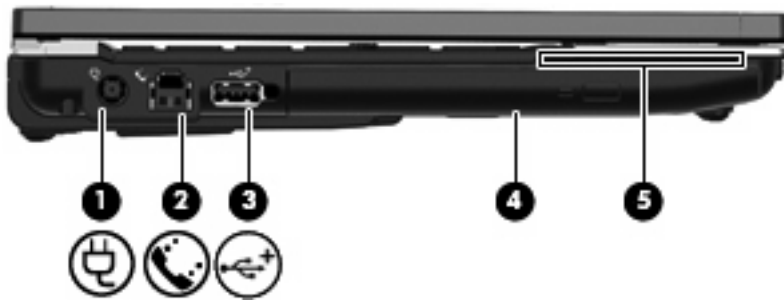

Component	Description
(1) Power connector	Connects an AC adapter.
(2) RJ-11 (modem) jack	Connects a modem cable (select models only).
(3) Powered USB port	Provides power to a USB device, such as an optional external MultiBay or an optional external optical drive, if used with a powered USB cable.
(4) Optical drive	Reads and writes to (select models only) an optical disc.
(5) Smart card reader	Supports optional smart cards and Java™ Cards.

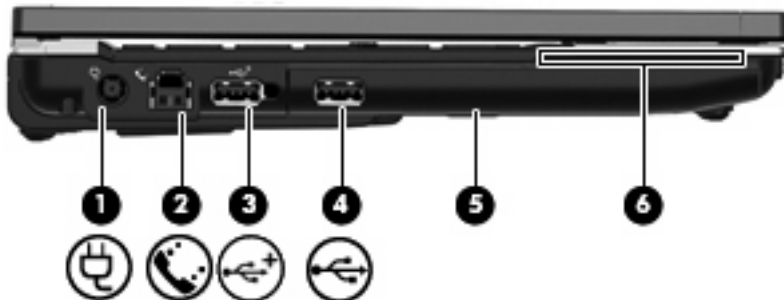

Component	Description
(1) Power connector	Connects an AC adapter.
(2) RJ-11 (modem) jack	Connects a modem cable (select models only).
(3) Powered USB port	Provides power to a USB device, such as an optional external MultiBay or an optional external optical drive, if used with a powered USB cable.
(4) USB port	Connects an optional USB device.
(5) Hard drive bay	Holds a 2.5-inch hard drive.
(6) Smart card reader	Supports optional smart cards and Java Cards.

## Bottom components

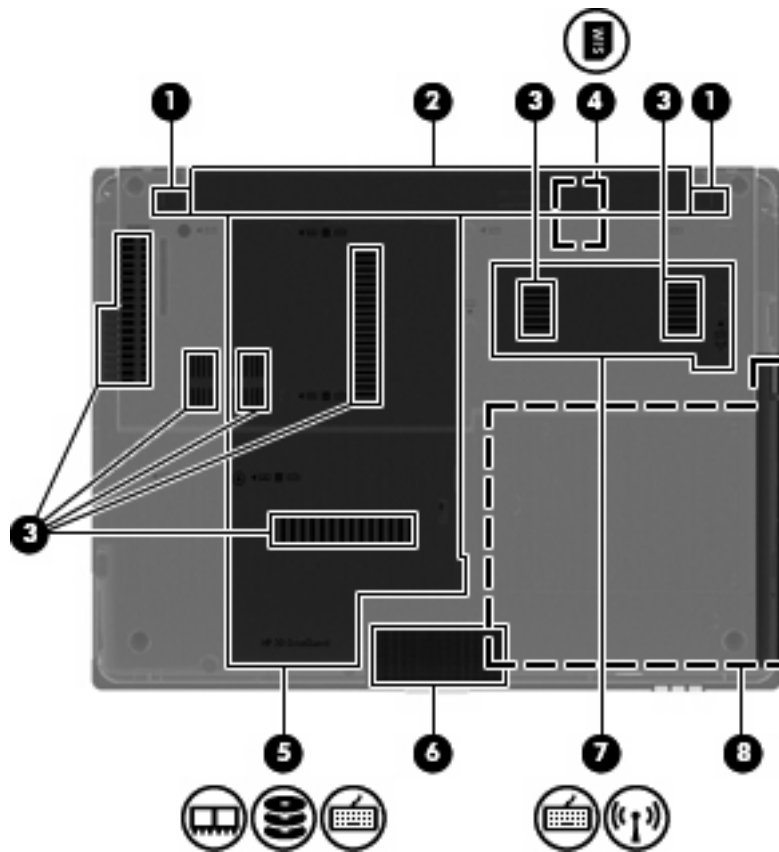

Component	Description
(1) Battery release latches (2)	Release the battery from the battery bay.
(2) Battery bay	Holds the battery.
(3) Vents (7)	Enable airflow to cool internal components.  <b>NOTE:</b> The computer fan starts up automatically to cool internal components and prevent overheating. It is normal for the internal fan to cycle on and off during routine operation.
(4) SIM slot (select models only)	Contains a wireless subscriber identity module (SIM). The SIM slot is located inside the battery bay.
(5) Hard drive bay and memory module compartment	Holds a 1.8-inch hard drive and contains an expansion memory module slot.  <b>NOTE:</b> Your computer has one hard drive, either 1.8-inch or 2.5-inch, or your computer may have two hard drives (1.8-inch and 2.5-inch). If your computer has one hard drive, the location of the hard drive varies.
(6) Speakers (2)	Produce sound.

Component	Description
(7) Wireless compartment	<p>Contains an HP Mobile Broadband Module (select models only) and a WLAN module (select models only).</p> <p><b>CAUTION:</b> To prevent an unresponsive system, replace the wireless module only with a wireless module authorized for use in the computer by the governmental agency that regulates wireless devices in your country or region. If you replace the module and then receive a warning message, remove the module to restore computer functionality, and then contact technical support through Help and Support.</p>
(8) Optical drive bay or hard drive bay	<p>Holds an optical drive or a 2.5-inch hard drive.</p> <p><b>NOTE:</b> Your computer has one hard drive, either 1.8-inch or 2.5-inch, or your computer may have two hard drives (1.8-inch and 2.5-inch). If your computer has one hard drive, the location of the hard drive varies.</p>

## Display components



Component	Description
(1) WWAN antennas (2)*	Send and receive wireless signals to communicate with wireless wide-area networks (WWANs) (select models only).
(2) WLAN antennas (2)*	Send and receive wireless signals to communicate with wireless local area networks (WLANs) (select models only).
(3) Webcam light	On: The webcam is in use.
(4) Webcam	Records audio and video and captures still photographs.
(5) Keyboard light and button	Opens and turns on the keyboard light, which illuminates the keyboard in low-light conditions.
(6) Internal microphones (2)	Record sound.  <b>NOTE:</b> If there is a microphone icon next to each microphone opening, your computer has internal microphones.
(7) Ambient light sensor	Automatically adjusts the display brightness based on the lighting conditions in your environment.

\*The antennas are not visible from the outside of the computer. For optimal transmission, keep the areas immediately around the antennas free from obstructions.

To see wireless regulatory notices, refer to the section of the *Regulatory, Safety and Environmental Notices* that applies to your country or region. These notices are located in Help and Support.

## Additional hardware components

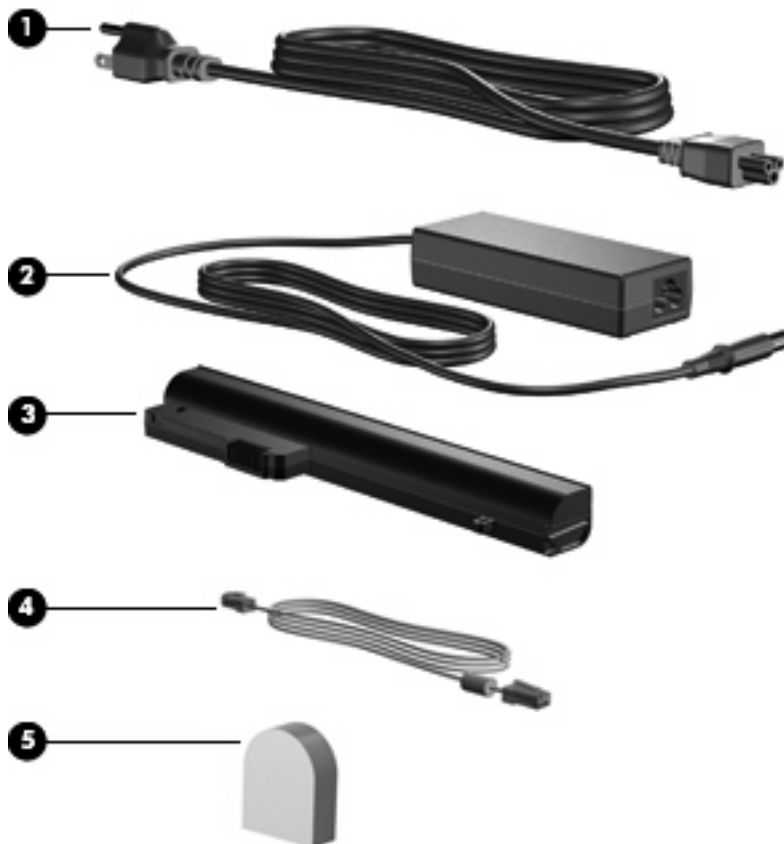



Component	Description
(1) Power cord*	Connects an AC adapter to an AC outlet.
(2) AC adapter	Converts AC power to DC power.
(3) Battery*	Powers the computer when the computer is not plugged into external power.
(4) Modem cable (select models only)*	Connects the internal modem to an RJ-11 telephone jack or to a country- or region-specific modem cable adapter.
(5) Country- or region-specific modem cable adapter (select models only)	Adapts the modem cable to a non-RJ-11 telephone jack.

\*Modem cables, batteries, and power cords vary in appearance by country or region.

## Identifying the labels

The labels affixed to the computer provide information you may need when you troubleshoot system problems or travel internationally with the computer:

- Service tag—Provides important information, including the following:

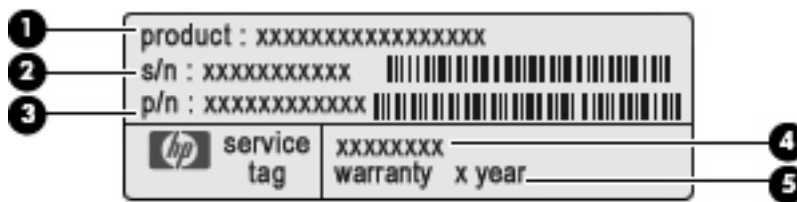

- Product name (1). This is the product name affixed to the front of the computer.
- Serial number (s/n) (2). This is an alphanumeric identifier that is unique to each product.
- Part number/Product number (p/n) (3). This number provides specific information about the product's hardware components. The part number helps a service technician to determine what components and parts are needed.
- Model description (4). This is an alphanumeric identifier used to locate documents, drivers, and support for the computer.
- Warranty period (5). This number describes the duration (in years) of the warranty period for the computer.

Have this information available when you contact technical support. The service tag label is located inside the battery bay.

- Microsoft® Certificate of Authenticity—Contains the Windows Product Key. You may need the Product Key to update or troubleshoot the operating system. This certificate is affixed to the bottom of the computer.
- Regulatory label—Provides regulatory information about the computer. The regulatory label is affixed to the bottom of the computer.
- Wireless certification label(s) (select models only)—Provide information about optional wireless devices and the approval markings of some of the countries or regions in which the devices have been approved for use. An optional device may be a wireless local area network (WLAN) device, an HP Mobile Broadband Module, or an optional Bluetooth® device. If your computer model

includes one or more wireless devices, one or more certification labels are included with your computer. You may need this information when traveling internationally. Wireless certification labels are affixed to the bottom of the computer.

- SIM label (select models only)—Provides the ICCID (Integrated Circuit Card Identifier) of your SIM. This label is located inside the battery bay.
- HP Mobile Broadband Module serial number label (select models only)—Provides the serial number of your HP Mobile Broadband Module. This label is located inside the battery bay.

---

## 2 Networking (select models only)

Your computer supports 2 types of Internet access:

- **Wireless**—For mobile Internet access, you can use a wireless connection.
- **Wired**—You can access the Internet by dialing in to a service provider or by connecting to a wired network.

# Wireless connections





## Creating a wireless connection

Wireless technology transfers data across radio waves instead of wires. Your computer may be equipped with one or more of the following wireless devices:

- Wireless local area network (WLAN) device
- HP Mobile Broadband Module
- Bluetooth® device

For more information on wireless technology, refer to the information and Web site links provided in Help and Support.

## Identifying wireless and network icons

Icon	Name	Description
	Wireless (connected)	Identifies the location of the wireless lights and the wireless button on the computer. Also identifies the Wireless Assistant software on the computer and indicates that one or more of the wireless devices are on.
	Wireless (disconnected)	Identifies the Wireless Assistant software on the computer and indicates that all of the wireless devices are off.
	HP Connection Manager	Opens HP Connection Manager, which enables you to create a connection with an HP Mobile Broadband device (select models only).
	Network status (connected)	Indicates that one or more of your network drivers are installed and one or more network devices are connected to the network.
	Network status (disconnected)	Indicates that one or more of your network drivers are installed but no network devices are connected to the network.

## Using the wireless controls

You can control the wireless devices in your computer using these features:

- Wireless button
- Wireless Assistant software
- HP Connection Manager software (select models only)
- Operating system controls

## Using the wireless button

The computer has a wireless button, one or more wireless devices, and 2 wireless lights. All of the wireless devices on your computer are enabled at the factory, so the wireless lights are on (blue) when you turn on the computer.

The wireless lights indicate the overall power state of your wireless devices, not the status of individual devices. If the wireless lights are blue, at least one wireless device is on. If the wireless lights are amber, all wireless devices are off.

Because the wireless devices are enabled at the factory, you can use the wireless button to turn on or turn off the wireless devices simultaneously. Individual wireless devices can be controlled through Wireless Assistant software or through Computer Setup.

---

 **NOTE:** If the wireless devices are disabled by Computer Setup, the wireless button will not work until you reenable your devices.

---

## Using Wireless Assistant software

A wireless device can be turned on or off using the Wireless Assistant software. If a wireless device is disabled by Computer Setup, it must be reenabled by Computer Setup before it can be turned on or off using Wireless Assistant.

---

 **NOTE:** Enabling or turning on a wireless device does not automatically connect the computer to a network or a Bluetooth-enabled device.

---

To view the state of the wireless devices, follow either of these steps:

Position the mouse pointer over the wireless icon in the notification area, at the far right of the taskbar.

– or –

Open Wireless Assistant by double-clicking the icon in the notification area.

For more information, refer to the Wireless Assistant software Help:

1. Open Wireless Assistant by double-clicking the icon in the notification area.
2. Click the **Help** button.

## Using HP Connection Manager (select models only)

You can use HP Connection Manager to connect to WWANs using the HP Mobile Broadband device in your computer (select models only).

To start Connection Manager, click the **Connection Manager** icon in the notification area, at the far right of the taskbar.

– or –

Select **Start > All Programs > HP > HP Connection Manager**.

For more details about using Connection Manager, refer to the Connection Manager software Help.

## Using operating system controls

Some operating systems also offer a way to manage integrated wireless devices and the wireless connection. For example, Windows® Network Connections allows you to set up a connection, connect to a network, manage wireless networks, and diagnose and repair connections.

To access Network Connections, select **Start > Control Panel > Network and Internet Connections > Network Connections**.

For more information, refer to Help and Support. Select **Start > Help and Support**.

## Using a WLAN

With a WLAN device, you can access a wireless local area network (WLAN), which is composed of other computers and accessories that are linked by a wireless router or a wireless access point.

 **NOTE:** The terms *wireless router* and *wireless access point* are often used interchangeably.

- A large-scale WLAN, such as a corporate or public WLAN, typically uses wireless access points that can accommodate a large number of computers and accessories and can separate critical network functions.
- A home or small office WLAN typically uses a wireless router, which allows several wireless and wired computers to share an Internet connection, a printer, and files without requiring additional pieces of hardware or software.

To use the WLAN device in your computer, you must connect to a WLAN infrastructure (provided through a service provider or a public or corporate network).

## Setting up a WLAN

To set up a WLAN and connect to the Internet, you need the following equipment:

- A broadband modem (either DSL or cable) **(1)** and high-speed Internet service purchased from an Internet service provider (ISP)
- A wireless router (purchased separately) **(2)**
- The wireless computer **(3)**

The illustration below shows an example of a wireless network installation that is connected to the Internet.

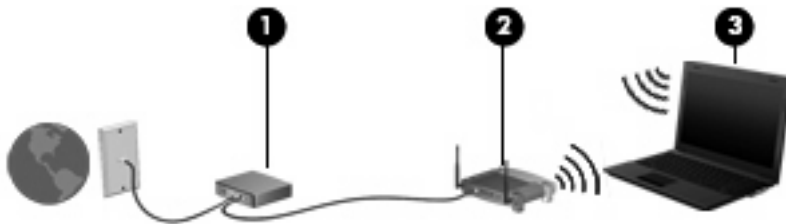

As your network grows, additional wireless and wired computers can be connected to the network to access the Internet.

For help in setting up your WLAN, refer to the information provided by your router manufacturer or your ISP.

## Protecting your WLAN

Because the WLAN standard was designed with only limited security capabilities—basically to foil casual eavesdropping rather than more powerful forms of attack—it is essential to understand that WLANs are vulnerable to well-known and well-documented security weaknesses.

WLANs in public areas, or “hotspots,” like coffee shops and airports may not provide any security. New technologies are being developed by wireless manufacturers and hotspot service providers that make the public environment more secure and anonymous. If you are concerned about the security of your computer in a hotspot, limit your network activities to noncritical e-mail and basic Internet surfing.

When you set up a WLAN or access an existing WLAN, always enable security features to protect your network from unauthorized access. The common security levels are Wi-Fi Protected Access (WPA) and Wired Equivalent Privacy (WEP). Because wireless radio signals travel outside the network, other WLAN devices can pick up unprotected signals and either connect to your network (uninvited) or capture information being sent across it. However, you can take precautions to protect your WLAN:

- **Use a wireless transmitter with built-in security**

Many wireless base stations, gateways, and routers provide built-in security features such as wireless security protocols and firewalls. With the correct wireless transmitter, you can protect your network from the most common wireless security risks.

- **Work behind a firewall**

A firewall is a barrier that checks both data and requests for data that are sent to your network and then discards any suspicious items. Firewalls are available in many varieties, both software and hardware. Some networks use a combination of both types.

- **Use wireless encryption**

A variety of sophisticated encryption protocols is available for your WLAN. Find the solution that works best for your network security:

- **Wired Equivalent Privacy (WEP)** is a wireless security protocol that uses a WEP key to encode or encrypt all network data before it is transmitted. Usually, you can allow the network to assign the WEP key. Alternatively, you can set up your own key, generate a different key, or choose other advanced options. Without the correct key, others will not be able to use the WLAN.
- **WPA (Wi-Fi Protected Access)**, like WEP, uses security settings to encrypt and decrypt data that is transmitted over the network. However, instead of using one static security key for encryptions as WEP does, WPA uses *temporal key integrity protocol* (TKIP) to dynamically generate a new key for every packet. It also generates different sets of keys for each computer on the network.

- **Close your network**

If possible, prevent your network name (SSID) from being broadcast by the wireless transmitter. Most networks initially broadcast the name, telling any computer nearby that your network is available. By closing the network, other computers are less likely to know that your network exists.

 **NOTE:** If your network is closed and the SSID is not broadcast, you will need to know or remember the SSID to connect new devices to the network. Write down the SSID and store it in a secure place before closing the network.

## Connecting to a WLAN

To connect to the WLAN, follow these steps:

1. Be sure that the WLAN device is on. If it is on, the wireless lights are blue. If the wireless lights are amber, press the wireless button.
2. Select **Start > Connect To**.
3. Select your WLAN from the list, and then type the network security key, if required.
  - If the network is unsecured, meaning that anyone can access the network, a warning is displayed. Click **Connect Anyway** to accept the warning and complete the connection.
  - If the network is a security-enabled WLAN, you are prompted to enter a network security key, which is a security code. Type the code, and then click **Connect** to complete the connection.

---

 **NOTE:** If no WLANs are listed, you are out of range of a wireless router or access point.

**NOTE:** If you do not see the network you want to connect to, click **Show all connections**. A list of options will appear that includes creating a new network connection, as well as troubleshooting connection issues.

---

After the connection is made, place the mouse pointer over the network status icon in the notification area, at the far right of the taskbar, to verify the name and status of the connection.

 **NOTE:** The functional range (how far your wireless signals travel) depends on WLAN implementation, router manufacturer, and interference from other electronic devices or structural barriers such as walls and floors.

---

More information about using a WLAN is available through the following resources:

- Information from your ISP and the manufacturer's instructions included with your wireless router and other WLAN equipment
- Information and Web site links provided in Help and Support

For a list of public WLANs near you, contact your ISP or search the Web. Web sites that list public WLANs include Cisco Internet Mobile Office Wireless Locations, Hotspotlist, and Geektools. Check with each public WLAN location for cost and connection requirements.

For additional information on connecting your computer to a corporate WLAN, contact your network administrator or IT department.

## Roaming to another network

When you move your computer within range of another WLAN, Windows attempts to connect to that network. If the attempt is successful, your computer is automatically connected to the new network. If Windows does not recognize the new network, follow the same procedure you used initially to connect to your WLAN.

## Using HP Mobile Broadband (select models only)

HP Mobile Broadband enables your computer to use wireless wide area networks (WWANs) to access the Internet from more places and over larger areas than it can by using WLANs. Using HP Mobile Broadband requires a network service provider (called a mobile network operator), which in most cases is a mobile phone network operator. Coverage for HP Mobile Broadband is similar to mobile phone voice coverage.



When used with mobile network operator service, HP Mobile Broadband gives you the freedom to stay connected to the Internet, send e-mail, or connect to your corporate network whether you are on the road or outside the range of Wi-Fi hotspots.

HP supports the following technologies:

- HSPA (High Speed Packet Access), which provides access to networks based on the Global System for Mobile Communications (GSM) telecommunications standard.
- EV-DO (Evolution Data Optimized), which provides access to networks based on the code division multiple access (CDMA) telecommunications standard.

You may need the HP Mobile Broadband Module serial number to activate mobile broadband service. The serial number is printed on a label inside the battery bay of your computer.

Some mobile network operators require the use of a subscriber identity module (SIM). A SIM contains basic information about you, such as a PIN (personal identification number), as well as network information. Some computers include a SIM that is preinstalled in the battery bay. If the SIM is not preinstalled, it may be provided in the HP Mobile Broadband information provided with your computer or the mobile network operator may provide it separately from the computer.

For information on inserting and removing the SIM, refer to the following “Inserting a SIM” and “Removing a SIM” sections.

For information on HP Mobile Broadband and how to activate service with a preferred mobile network operator, refer to the mobile broadband information included with your computer. For additional information, see the HP Web site at <http://www.hp.com/go/mobilebroadband> (US only).

## Inserting a SIM

- △ **CAUTION:** When inserting a SIM, position the card with the slanted corner as shown in the illustration. If a SIM is inserted backwards or upside down, the battery may not snap into place properly and could damage the SIM and the SIM connector.

---

To prevent damage to the connectors, use minimal force when inserting a SIM.

To insert a SIM:

1. Shut down the computer. If you are not sure whether the computer is off or in Hibernation, turn the computer on by pressing the power button. Then shut down the computer through the operating system.
2. Close the display.
3. Disconnect all external devices connected to the computer.
4. Unplug the power cord from the AC outlet.
5. Turn the computer upside down on a flat surface, with the battery bay toward you.
6. Remove the battery.

7. Insert the SIM into the SIM slot, and gently push the SIM into the slot until it is firmly seated.

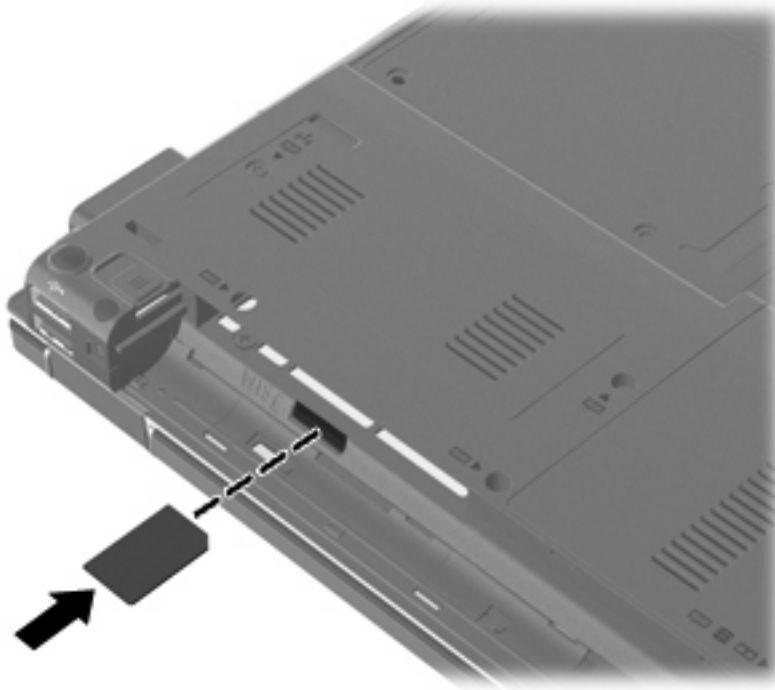

8. Replace the battery.



**NOTE:** HP Mobile Broadband will be disabled if the battery is not replaced.

9. Turn the computer right-side up, and then reconnect external power and external devices.
10. Turn on the computer.

## Removing a SIM

To remove a SIM:

1. Shut down the computer. If you are not sure whether the computer is off or in Hibernation, turn the computer on by pressing the power button. Then shut down the computer through the operating system.
2. Close the display.
3. Disconnect all external devices connected to the computer.
4. Unplug the power cord from the AC outlet.
5. Turn the computer upside down on a flat surface, with the battery bay toward you.
6. Remove the battery.

7. Press in on the SIM (1), and then remove it from the slot (2).

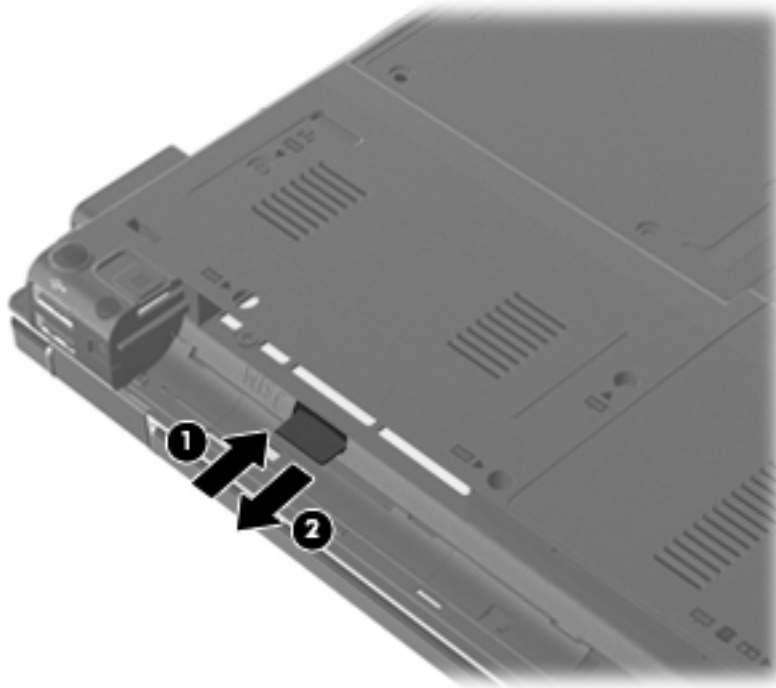

8. Replace the battery.
9. Turn the computer right-side up, and then reconnect external power and external devices.
10. Turn on the computer.

## Using a Bluetooth wireless device

A Bluetooth device provides short-range wireless communications that replace the physical cable connections that traditionally link electronic devices such as the following:

- Computers (desktop, notebook, PDA)
- Phones (cellular, cordless, smart phone)
- Imaging devices (printer, camera)
- Audio devices (headset, speakers)

Bluetooth devices provide peer-to-peer capability that allows you to set up a personal area network (PAN) of Bluetooth devices. For information on configuring and using Bluetooth devices, refer to the Bluetooth software Help.

## Bluetooth and Internet Connection Sharing (ICS)

HP does **not** recommend setting up one computer with Bluetooth as a host and using it as a gateway through which other computers may connect to the Internet. When two or more computers are connected using Bluetooth, and Internet Connection Sharing (ICS) is enabled on one of the computers, the other computers may not be able to connect to the Internet using the Bluetooth network.

The strength of Bluetooth is in synchronizing information transfers between your computer and wireless devices including cellular phones, printers, cameras, and PDAs. The inability to consistently connect

two or more computers to share the Internet through Bluetooth is a limitation of Bluetooth and the Windows operating system.

## Troubleshooting wireless connection problems

Some possible causes for wireless connection problems include the following:

- Wireless device is not installed correctly or has been disabled.
- Wireless device or router hardware has failed.
- Network configuration (SSID or security) has been changed.
- Wireless device encountered interference from other devices.

---

 **NOTE:** Wireless networking devices are included with select computer models only. If wireless networking is not listed in the feature list on the side of the original computer package, you may add wireless networking capability to the computer by purchasing a wireless networking device.

---

Before working your way through the sequence of possible solutions to your network connection problem, be sure that device drivers are installed for all wireless devices.

Use the procedures in this chapter to diagnose and repair a computer that does not connect to the network you want to use.

### Cannot create a WLAN connection

If you have a problem connecting to a WLAN, confirm that the integrated WLAN device is properly installed on your computer:

1. Select **Start > My Computer**.
2. Right-click in the My Computer window.
3. Select **Properties > Hardware > Device Manager > Network Adapters**.
4. Identify the WLAN device from the Network adapters list. The listing for a WLAN device may include the term *wireless*, *wireless LAN*, *WLAN*, or *802.11*.

If no WLAN device is listed, either your computer does not have an integrated WLAN device, or the driver for the WLAN device is not properly installed.

For more information on troubleshooting WLANs, refer to the Web site links provided in Help and Support.

## Cannot connect to a preferred network

Windows can automatically repair a corrupted WLAN connection:

- If there is a network status icon in the notification area, at the far right of the taskbar, right-click the icon, and then click **Repair** from the menu.

Windows resets your network device and attempts to reconnect to one of the preferred networks.

- If an “x” is superimposed over the network status icon, one or more of your WLAN or LAN drivers are installed but the computer is not connected.
- If there is no network status icon in the notification area, follow these steps:
  1. Select **Start > Control Panel > Network and Internet Connections > Network Connections**.
  2. Click on one of the connections.
  3. In the left pane, click **Repair this connection**.

The Network connections window is displayed, and Windows resets your network device and attempts to reconnect to one of the preferred networks.

## Current network security codes are unavailable

If you are prompted for a network key or an SSID when connecting to a WLAN, the network is protected by security. You must have the current codes to make a connection on a secure network. The SSID and network key are alphanumeric codes that you enter into your computer to identify your computer to the network.

- For a network connected to your personal wireless router, review the router user guide for instructions on setting up the same codes on both the router and the WLAN device.
- For a private network, such as a network in an office or at a public Internet chat room, contact the network administrator to obtain the codes, and then enter the codes when prompted to do so.

Some networks change the SSID or network keys used in their routers or access points on a regular basis to improve security. You must change the corresponding code in your computer accordingly.

If you are provided with new wireless network keys and SSID for a network, and if you have previously connected to that network, follow the steps below to connect to the network:

1. Select **Start > Control Panel > Network and Internet Connections > Network Connections**.

A list showing the available WLANs is displayed. If you are in a hotspot where several WLANs are active, several will be displayed.

2. Right-click the network, and then click **Properties**.
3. Click the **Wireless Networks** tab.
4. Select the network, and then click **Properties**.

 **NOTE:** If the network you want is not listed, check with the network administrator to be sure that the router or access point is operating.

5. Click the **Association** tab, and then enter the correct wireless encryption data into the **Network key** field.
6. Click **OK** to save these settings.

### WLAN connection is very weak

If the connection is very weak, or if your computer cannot make a connection to a WLAN, minimize interference from other devices, as follows:

- Move your computer closer to the wireless router or access point.
- Temporarily disconnect other wireless devices such as a microwave, cordless phone, or cellular phone to be sure that they are not interfering.

If the connection does not improve, try forcing the device to reestablish all connection values:

1. Select **Start > Control Panel > Network and Internet Connections > Network Connections**.
2. Right-click the network, and then click **Properties**.
3. Click the **Wireless Networks** tab.

A list showing the available WLANs is displayed. If you are in a hotspot where several WLANs are active, several will be displayed.

4. Select a network, and then click **Remove**.

### Cannot connect to the wireless router

If you are trying to connect to the wireless router and are unsuccessful, reset the wireless router by removing power from the router for 10 to 15 seconds.

If the computer still cannot make a connection to a WLAN, restart the wireless router. For details, refer to the router manufacturer's instructions.

# Wired connections

## Connecting to a local area network (LAN)

Connecting to a local area network (LAN) requires an 8-pin, RJ-45 network cable (purchased separately). If the network cable contains noise suppression circuitry **(1)**, which prevents interference from TV and radio reception, orient the circuitry end of the cable **(2)** toward the computer.



To connect the network cable:

1. Plug the network cable into the network jack **(1)** on the computer.
2. Plug the other end of the cable into a network wall jack **(2)**.

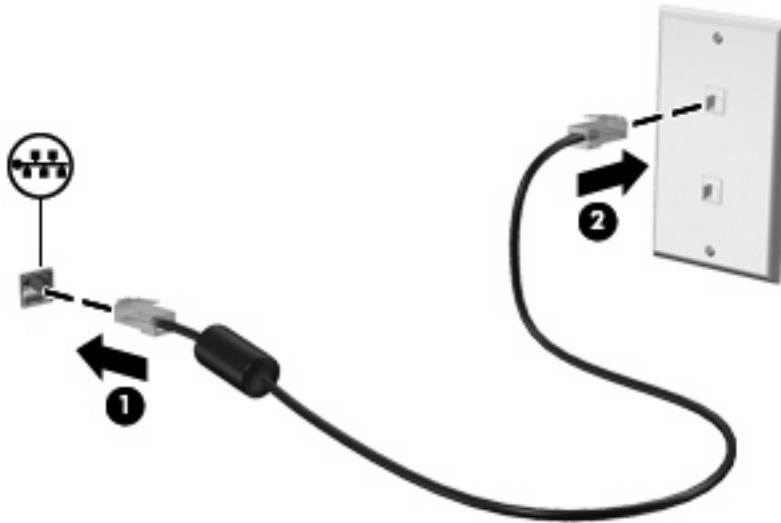

**⚠ WARNING!** To reduce the risk of electric shock, fire, or damage to the equipment, do not plug a modem or telephone cable into the RJ-45 (network) jack.

## Using the modem (select models only)

The modem must be connected to an analog telephone line using a 6-pin, RJ-11 modem cable (included with select models only). In some countries or regions, a country- or region-specific modem cable adapter (included with select models only) is also required. Jacks for digital PBX systems may resemble analog telephone jacks, but they are not compatible with the modem.

**⚠ WARNING!** Connecting the internal analog modem to a digital line can permanently damage the modem. Immediately disconnect the modem cable if you accidentally connect it to a digital line.

If the modem cable contains noise suppression circuitry **(1)**, which prevents interference from TV and radio reception, orient the circuitry end **(2)** of the cable toward the computer.



### Connecting a modem cable (select models only)

**⚠ WARNING!** To reduce the risk of electric shock, fire, or damage to the equipment, do not plug a modem or telephone cable into the RJ-45 (network) jack.

To connect a modem cable:

1. Plug the modem cable into the modem jack **(1)** on the computer.
2. Plug the modem cable into the RJ-11 telephone wall jack **(2)**.

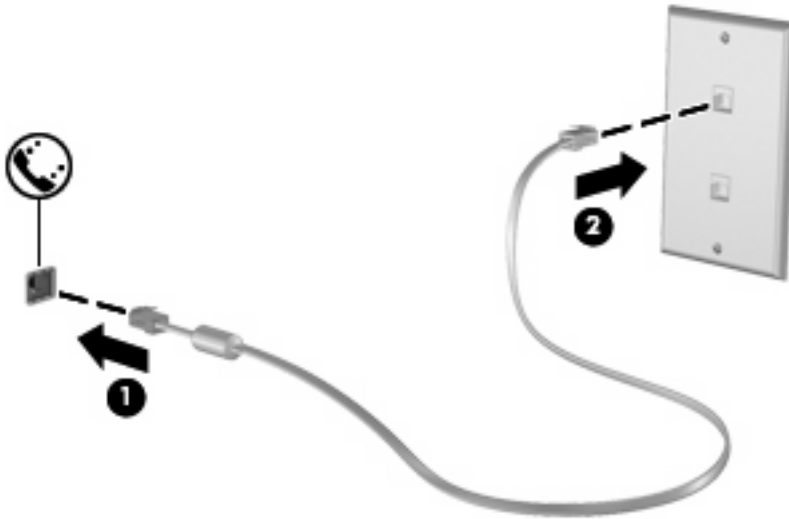

### Connecting a country- or region-specific modem cable adapter (select models only)

Telephone jacks vary by country or region. To use the modem and the modem cable (included with select models only) outside the country or region in which you purchased the computer, you must obtain a country- or region-specific modem cable adapter (included with select models only).

To connect the modem to an analog telephone line that does not have an RJ-11 telephone jack, follow these steps:

1. Plug the modem cable into the modem jack **(1)** on the computer.
2. Plug the modem cable into the modem cable adapter **(2)**.



3. Plug the modem cable adapter (3) into the telephone wall jack.

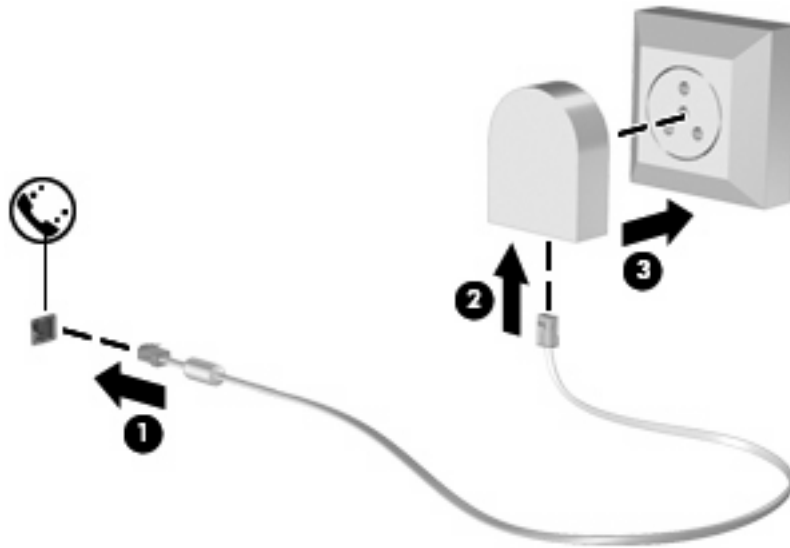

## Selecting a location setting

### Viewing the current location selection

To view the current location setting for the modem, follow these steps:

1. Select **Start > Control Panel**.
2. Click **Date, Time, Language, and Regional Options**.
3. Click **Regional and Language Options**.

Your location is displayed under Location.

### Adding new locations when traveling

By default, the only location setting available to the modem is a location setting for the country or region in which you purchased the computer. As you travel to different countries or regions, set the internal modem to a location setting that meets the operating standards of the country or region in which you are using the modem.

As you add new location settings, they are saved by the computer so that you can switch among settings at any time. You can add multiple location settings for any country or region.

△ **CAUTION:** To prevent losing your home country or region settings, do not delete your current modem country or region settings. To enable modem use in other countries or regions while preserving your home country or region configuration, add a new configuration for each location in which you will use the modem.

**CAUTION:** To prevent configuring the modem in a way that violates the telecommunications regulations and laws of the country or region you are visiting, select the country or region in which the computer is located. The modem may not function properly if the correct country or region selection is not made.

To add a location setting for the modem, follow these steps:

1. Select **Start > Control Panel > Network and Internet Connections**.
2. In the left side panel, click **Phone and Modem Options**.
3. Click the **Dialing Rules** tab.
4. Click **New**. The New Location window is displayed.
5. In the **Location name** box, type a name (such as “home” or “work”) for the new location setting.
6. Select a country or region from the **Country/region** drop-down list. (If you select a country or region that is not supported by the modem, the country/region selection for *USA* or *UK* is displayed by default.)
7. Click **OK** to save your new location setting. The Phone and Modem Options window is displayed.
8. Do one of the following:
  - To set your new location setting as the current location, click **OK**.
  - To select another location setting as the current location setting, select your preference from the settings in the **Location** list, and then click **OK**.

---

 **NOTE:** You can use the preceding procedure to add location settings for places within your own country or region as well as in other countries or regions. For example, you could add a setting named “Work” that includes dialing rules for accessing an outside line.

---

## Solving travel connection problems

If you experience modem connection problems when using the computer outside of the country or region in which you purchased it, try the following suggestions.

- **Check the telephone line type.**

The modem requires an analog, not a digital, telephone line. A line described as a PBX line is usually a digital line. A telephone line described as a data line, fax machine line, modem line, or standard telephone line is usually an analog line.

- **Check for pulse or tone dialing.**

An analog telephone line supports one of 2 dialing modes: pulse dialing or tone dialing. These dialing mode options are selected in the Phone and Modem Options settings. The dialing mode option selected must match the dialing mode supported by the telephone line in your location.

To determine the dialing mode supported by a telephone line, dial a few digits on the telephone, and then listen for clicks (pulses) or tones. Clicks indicate that the telephone line supports pulse dialing. Tones indicate that the telephone line supports tone dialing.

To change the dialing mode in your current modem location setting, follow these steps:

1. Select **Start > Control Panel > Network and Internet Connections**.
2. In the left side panel, click **Phone and Modem Options**.
3. Then click the **Dialing Rules** tab.
4. Select your modem location setting.
5. Click **Edit**.
6. Click either **Tone** or **Pulse**.
7. Click **OK** twice.

- **Check the telephone number you are dialing and the response of the remote modem.**

Dial a telephone number, make sure there is a response from the remote modem, and then hang up.

- **Set the modem to ignore dial tones.**

If the modem receives a dial tone it does not recognize, it does not dial and displays a “No Dial Tone” error message.

To set the modem to ignore all dial tones before dialing, follow these steps:

1. Select **Start > Control Panel > Network and Internet Connections**.
2. In the left side panel, click **Phone and Modem Options**.
3. Then click the **Modems** tab.
4. Click the listing for the modem.
5. Click **Properties**.
6. Click **Modem**.

7. Clear the check box for **Wait for dial tone before dialing**.
8. Click **OK** twice.

---

## 3 Pointing devices and keyboard

### Using pointing devices

#### Setting pointing device preferences

Use Mouse Properties in Windows® to customize settings for pointing devices, such as button configuration, click speed, and pointer options.

To access Mouse Properties, select **Start > Control Panel > Printers and Other Hardware > Mouse**.

#### Using the TouchPad

To move the pointer, slide your finger across the TouchPad surface in the direction you want the pointer to go. Use the TouchPad buttons like the corresponding buttons on an external mouse. To scroll up and down using the TouchPad vertical scroll zone, slide your finger up or down over the lines.

 **NOTE:** If you are using the TouchPad to move the pointer, you must lift your finger off the TouchPad before moving it to the scroll zone. Simply sliding your finger from the TouchPad to the scroll zone will not activate the scrolling function.

#### Using the pointing stick

Press the pointing stick in the direction you want to move the pointer on the screen. Use the left and right pointing stick buttons as you would the left and right buttons on an external mouse.

#### Connecting an external mouse

You can connect an external USB mouse to the computer using one of the USB ports on the computer. A USB mouse can also be connected to the system using the ports on an optional docking device.

## Using the keyboard

### Using the keyboard light

The keyboard light illuminates the computer keyboard in low-light conditions.

1. To open and turn on the keyboard light, press the keyboard light button.



2. To turn off the keyboard light, press the button again.

### Using hotkeys





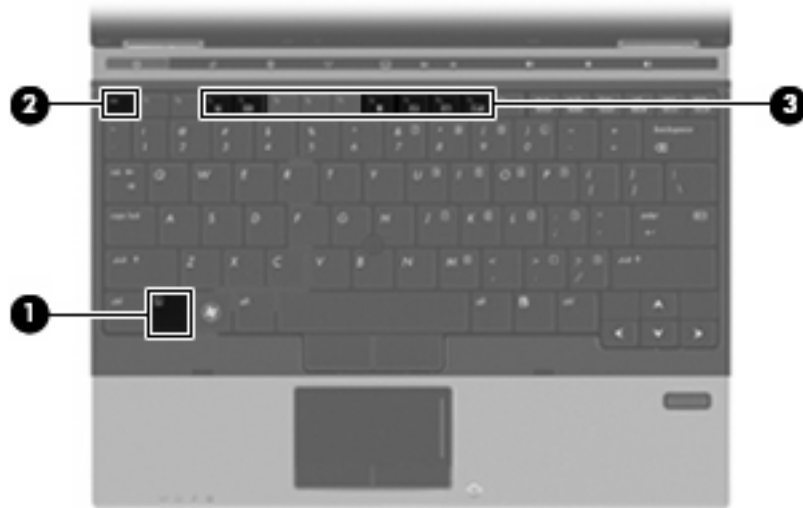

Hotkeys are combinations of the **fn** key **(1)** and either the **esc** key **(2)** or one of the function keys **(3)**.

The icons on the **f3**, **f4**, and **f8** through **f11** keys represent the hotkey functions. Hotkey functions and procedures are discussed in the following sections.



To use a hotkey command on the computer keyboard, follow either of these steps:

- Briefly press the **fn** key, and then briefly press the second key of the hotkey command.  
– or –
- Press and hold down the **fn** key, briefly press the second key of the hotkey command, and then release both keys at the same time.

Hotkey		Description
fn+esc		Displays information about system hardware components and the system BIOS version number.
fn+f3		<p>Initiates Standby, which stores your information in system memory. The screen clears, and power is conserved. The power lights blink when the computer is in Standby.</p> <p>To exit Standby, briefly press the power button.</p> <p><b>CAUTION:</b> To reduce the risk of information loss, save your work before initiating Standby.</p> <p><b>NOTE:</b> If a critical battery level occurs while the computer is in Standby, the computer initiates Hibernation and the information stored in memory is saved to the hard drive.</p> <p>The function of the <b>fn+f3</b> hotkey can be changed. For example, you can set the <b>fn+f3</b> hotkey to initiate Hibernation instead of Standby.</p> <p><b>NOTE:</b> In all Windows operating system windows, references to the <i>sleep button</i> apply to the <b>fn+f3</b> hotkey.</p>
fn+f4		<p>Switches the screen image among display devices connected to the system. For example, if a monitor is connected to the computer, <b>fn+f4</b> alternates the screen image from computer display to monitor display to simultaneous display on both the computer and the monitor.</p> <p>Most external monitors receive video information from the computer using the external VGA video standard. The <b>fn+f4</b> hotkey can also alternate images among other devices that are receiving video information from the computer.</p>
fn+f8		Displays charge information for all installed batteries. The display indicates which batteries are charging and reports the amount of charge remaining in each battery.
fn+f9		Decreases the screen brightness level incrementally.
fn+f10		Increases the screen brightness level incrementally.
fn+f11		Activates and deactivates the ambient light sensor.

## Using HP QuickLook 3

QuickLook 3 allows you to save calendar, contact, inbox, and task information from Microsoft Outlook to the hard drive of your computer. Then, when the computer is off, you can press the QuickLook button on the computer to view this information without waiting for the operating system to restart.

Use QuickLook 3 to manage contact information, calendar events, e-mail information, and tasks without restarting your computer.

 **NOTE:** QuickLook 3 does not support Standby or Hibernation in Windows.

For more information about setting up and using QuickLook 3, refer to the QuickLook 3 software Help.

## Using keypads

The computer has an embedded numeric keypad and also supports an optional external numeric keypad or an optional external keyboard that includes a numeric keypad.

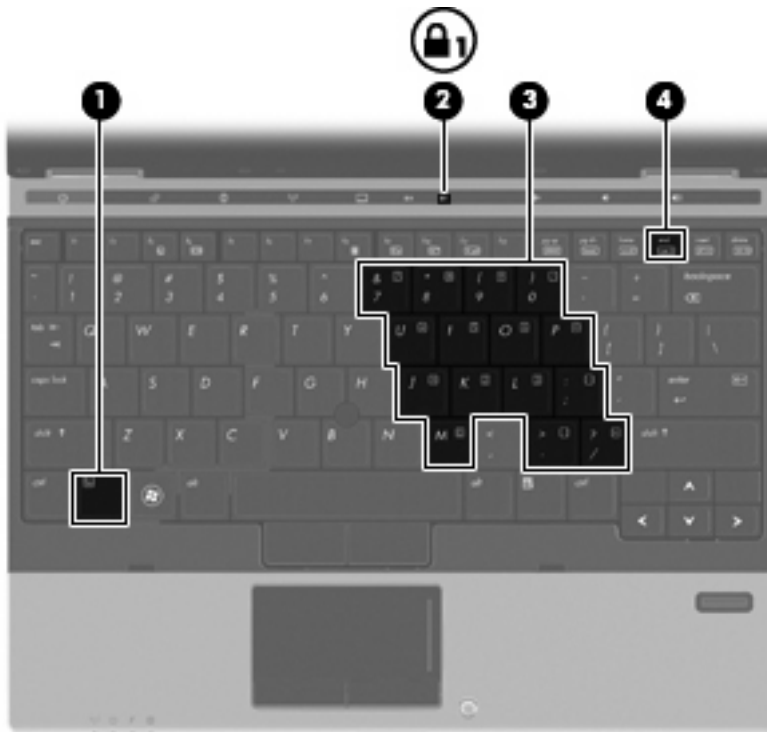

Component	Description
(1) <a href="#">fn</a> key	Enables/disables the embedded numeric keypad when pressed in combination with the <a href="#">num lk</a> key.
(2) Num lock light	On: Num lock is on.
(3) Embedded numeric keypad	When the keypad has been enabled, it can be used like the keys on an external numeric keypad.
(4) <a href="#">num lk</a> key	Enables/disables the embedded numeric keypad when pressed in combination with the <a href="#">fn</a> key.



## Using the embedded numeric keypad

The 15 keys of the embedded numeric keypad can be used like the keys on an external keypad. When the embedded numeric keypad is turned on, each key on the keypad performs the function indicated by the icon in the upper-right corner of the key.

### Enabling and disabling the embedded numeric keypad

Press **fn+num lk** to enable the embedded numeric keypad. Press **fn+num lk** again to return the keys to their standard keyboard functions.

---

 **NOTE:** The embedded numeric keypad will not function while an external keyboard or numeric keypad is connected to the computer or an optional docking device.

---

### Switching key functions on the embedded numeric keypad

You can temporarily alternate the functions of keys on the embedded numeric keypad between their standard keyboard functions and their keypad functions by using the **fn** key or the **fn+shift** key combination.

- To change the function of a keypad key to keypad functions while the keypad is off, press and hold the **fn** key while pressing the keypad key.
- To use the keypad keys temporarily as standard keys while the keypad is on:
  - Press and hold the **fn** key to type in lowercase.
  - Press and hold **fn+shift** to type in uppercase.

## Using an optional external numeric keypad

Keys on most external numeric keypads function differently according to whether num lock is on or off. (Num lock is turned off at the factory.) For example:

- When num lock is on, most keypad keys type numbers.
- When num lock is off, most keypad keys function like the arrow, page up, or page down keys.

When num lock on an external keypad is turned on, the num lock light on the computer is turned on. When num lock on an external keypad is turned off, the num lock light on the computer is turned off.

To turn num lock on or off on an external keypad as you work:

- ▲ Press the **num lk** key on the external keypad, not on the computer.

## Cleaning the TouchPad and keyboard

Dirt and grease on the TouchPad can cause the pointer to jump around on the screen. To avoid this, clean the TouchPad with a damp cloth, and wash your hands frequently when using the computer.

---

⚠ **WARNING!** To reduce the risk of electric shock or damage to internal components, do not use a vacuum cleaner attachment to clean the keyboard. A vacuum cleaner can deposit household debris on the keyboard surface.

---

Clean the keyboard regularly to prevent keys from sticking and to remove dust, lint, and particles that can become trapped beneath the keys. A can of compressed air with a straw extension can be used to blow air around and under the keys to loosen and remove debris.



---

# 4 Multimedia

## Multimedia features

Your computer includes multimedia features that allow you to listen to music, watch movies, and view pictures. Your computer may include the following multimedia components:

- Optical drive for playing audio and video discs
- Integrated speakers for listening to music
- Integrated microphones for recording your own audio
- Integrated webcam that allows you to capture and share video
- Preinstalled multimedia software that allows you to play and manage your music, movies, and pictures

---

 **NOTE:** Your computer may not include all of the components listed.

---

## Identifying your multimedia components

The following illustration and table describe the multimedia features of the computer.



Component	Description
(1) Webcam	Records audio and video and captures still photographs.
(2) Internal microphones (2)	Record sound.  <b>NOTE:</b> The internal microphones make use of dual array technology, which provides speech enhancement and suppresses surrounding noises.
(3) Volume up button	Increases speaker volume.
(4) Volume down button	Decreases speaker volume.
(5) Volume mute button	Mutes and restores speaker sound.
(6) Audio-out (headphone) jack/Audio-in (microphone) jack	Produces sound when connected to optional powered stereo speakers, headphones, ear buds, or a headset. Also connects an optional headset microphone.  <b>WARNING!</b> To reduce the risk of personal injury, adjust the volume before putting on headphones, earbuds, or a headset. For additional safety information, refer to the <i>Regulatory, Safety and Environmental Notices</i> .  <b>NOTE:</b> When a device is connected to the headphone jack, the computer speakers are disabled.
(7) Speakers (2)	Produce sound.

# Multimedia software

Your computer includes preinstalled multimedia software that allows you to play music, watch movies, and view pictures. The following sections provide details about preinstalled multimedia software and installing multimedia software from a disc.

## Accessing your preinstalled multimedia software

To access your preinstalled multimedia software:

- ▲ Select **Start > All Programs**, and then open the multimedia program you want to use.

---

 **NOTE:** Some programs may be located in subfolders.

---

 **NOTE:** For details about using software included with the computer, refer to the software manufacturer' instructions. These instructions may be provided with the software or on the manufacturer's Web site.

---

## Installing multimedia software from a disc

To install any multimedia software from a CD or DVD, follow these steps:

1. Insert the disc into the optical drive or an optional external optical drive.
2. When the installation wizard opens, follow the on-screen instructions.
3. Restart the computer if you are prompted to do so.

# Audio

Your computer enables you to use a variety of audio features:

- Play music using your computer speakers and/or connected external speakers
- Record sound using the internal microphones or an optional external microphone
- Download music from the Internet
- Create multimedia presentations using audio and images
- Transmit sound and images with instant messaging programs
- Stream radio programs (select models only) or receive FM radio signals
- Create or “burn” audio CDs using the optical drive (select models only) or an optional external optical drive

## Adjusting the volume

You can adjust the volume using the following controls:

- Computer volume buttons:
  - To mute or restore volume, press the volume mute button **(1)**.
  - To decrease volume, press the volume down button **(2)** until the desired volume level is reached.
  - To increase volume, press the volume up button **(3)** until the desired volume level is reached.

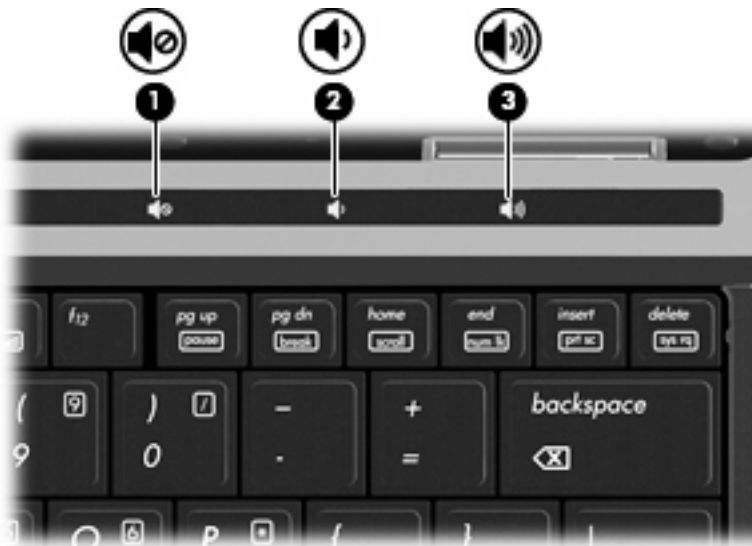

- Windows volume control:
  - a. Click the **Volume** icon in the notification area, at the far right of the taskbar.
  - b. Increase or decrease the volume by moving the slider up or down. Click the **Mute** check box to mute the volume.

– or –

- a. Double-click the **Volume** icon in the notification area.
- b. In the **Master Volume** column, you can increase or decrease the volume by moving the **Volume** slider up or down. You can also adjust the balance or mute the volume.

If the Volume icon is not displayed in the notification area, follow these steps to add it:

- a. Select **Start > Control Panel > Sounds, Speech, and Audio Devices > Sounds and Audio Devices > Volume** tab.
  - b. Select the **Place volume icon in the taskbar** check box.
  - c. Click **Apply**.
- Program volume control:

Volume can also be adjusted within some programs.

## Connecting external audio devices

---

 **WARNING!** To reduce the risk of personal injury, adjust the volume before putting on headphones, earbuds, or a headset. For additional safety information, refer to the *Regulatory, Safety and Environmental Notices*.

---

To connect external devices such as external speakers, headphones, or a microphone, refer to the information provided with the device. For best results, remember the following tips:

- Be sure that the device cable is securely connected to the correct jack on your computer. (Cable connectors are normally color-coded to match the corresponding jacks on the computer.)
- Be sure to install any drivers required by the external device.

---

 **NOTE:** A driver is a required program that acts like a translator between the device and the programs that use the device.

---

## Checking your audio functions

To check the system sound on your computer, follow these steps:

1. Select **Start > Control Panel**.
2. Select **Sounds, Speech, and Audio Devices > Sounds and Audio Devices**.
3. When the Sounds and Audio Devices Properties window opens, click the **Sounds** tab. Under **Program events**, select any sound event, such as a beep or alarm, and click the **Play** button.

You should hear sound through the computer speakers or through connected headphones.

To check the record functions of the computer, follow these steps:

1. Select **Start > All Programs > Accessories > Entertainment > Sound Recorder**.
2. Click **Record** and speak into the microphone. Save the file to the desktop.
3. Open Windows Media Player and play back the sound.

---

 **NOTE:** For best results when recording, speak directly into the microphone and record sound in a setting free of background noise.

---

- ▲ To confirm or change the audio settings on your computer, right-click the **Sound** icon on the taskbar, or select **Start > Control Panel > Sounds, Speech, and Audio Devices > Sounds and Audio Devices**.

## Video

Your computer enables you to use a variety of video features:

- Watch movies
- Play games over the Internet
- Edit pictures and video to create presentations
- Connect external video devices

### Connecting an external monitor or projector

Your computer has an external monitor port and a DisplayPort that allow you to connect external monitors and projectors.

#### Using the external monitor port

The external monitor port connects an external VGA display device such as an external VGA monitor or a VGA projector to the computer. The external monitor port is an analog display interface.

- ▲ To connect a VGA display device, connect the device cable to the external monitor port.

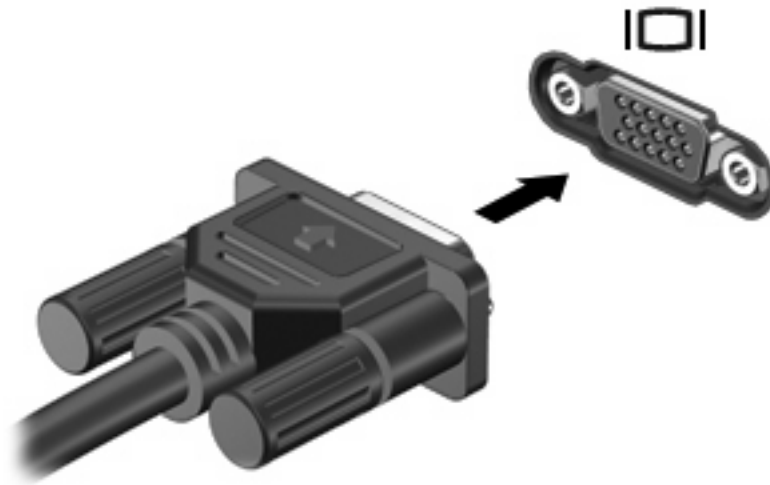

---

 **NOTE:** If a properly connected external display device does not display an image, press **fn+f4** to transfer the image to the device. Repeatedly pressing **fn+f4** alternates the screen image between the computer display and the device.

---



## Using the DisplayPort

The DisplayPort connects a digital display device such as a high-performance monitor or projector. The DisplayPort delivers higher performance than the VGA external monitor port and improves digital connectivity.

- ▲ To connect a digital display device, connect the device cable to the DisplayPort.



---

 **NOTE:** If a properly connected external display device does not display an image, press **fn+f4** to transfer the image to the device. Repeatedly pressing **fn+f4** alternates the screen image between the computer display and the device.

---

# Optical drives (select models only)

## Identifying the installed optical drive

- ▲ Select **Start > My Computer**.

You will see a list of all the devices installed on your computer, including the optical drive.

## Playing a CD or DVD

1. Turn on the computer.
2. Press the release button (1) on the optical drive bezel to release the disc tray.
3. Pull out the tray (2).
4. Hold the disc by the edges and position the disc label-side up over the tray spindle.

---

 **NOTE:** If the tray is not fully accessible, tilt the disc carefully to position it over the spindle.

---

5. Gently press the disc (3) down onto the tray spindle until the disc snaps into place.

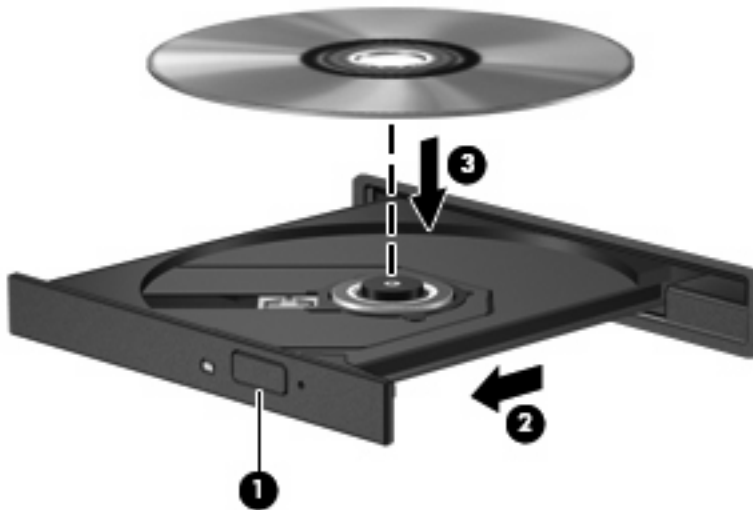

6. Close the disc tray.
7. If you have not yet configured AutoPlay, the AutoPlay dialog box opens and asks how you want to use the media content. Choose Windows Media Player, which is preinstalled on your computer.

---

 **NOTE:** After you insert a disc, a short pause is normal.

---

If Standby or Hibernation is accidentally initiated during playback of a disc:

- Your playback may be interrupted.
- You may see a warning message asking if you want to continue. If this message is displayed, click **No**.
- You may need to restart the CD or DVD to resume playback.

## Changing DVD region settings

Most DVDs that contain copyrighted files also contain region codes. The region codes help protect copyrights internationally.

You can play a DVD containing a region code only if the region code on the DVD matches the region setting on your DVD drive.

---

△ **CAUTION:** The region settings on your DVD drive can be changed only 5 times.

The region setting you select the fifth time becomes the permanent region setting on the DVD drive.

The number of region changes remaining is displayed on the DVD Region tab.

---

To change settings through the operating system:

1. Select **Start > My Computer**.
2. Right-click in the window and select **Properties > Hardware tab > Device Manager**.
3. Click the "+" sign next to **DVD/CD-ROM drives**.
4. Right-click the DVD drive for which you want to change region settings, and then click **Properties**.
5. Click the **DVD Region** tab, and change settings.
6. Click **OK**.

## Creating (burning) a CD or DVD

---

△ **CAUTION:** Observe the copyright warning. It is a criminal offense, under applicable copyright laws, to make unauthorized copies of copyright-protected material, including computer programs, films, broadcasts, and sound recordings. Do not use this computer for such purposes.

---

If your optical drive is a CD-RW, DVD-RW, or DVD±RW optical drive, you can use software such as Windows Media Player to burn data and audio files, including MP3 and WAV music files. To burn video files to a CD or DVD, use MyDVD.

Observe the following guidelines when burning a CD or DVD:

- Before burning a disc, save and close any open files and close all programs.
- A CD-R or DVD-R is usually best for burning audio files because after the information is copied, it cannot be changed.
- Because some home and car stereos will not play CD-RWs, use CD-Rs to burn music CDs.
- A CD-RW or DVD-RW is generally best for burning data files or for testing audio or video recordings before you burn them to a CD or DVD that cannot be changed.
- DVD players used in home systems usually do not support all DVD formats. Refer to the user guide that came with your DVD player for a list of supported formats.
- An MP3 file uses less space than other music file formats, and the process for creating an MP3 disc is the same as the process for creating a data file. MP3 files can be played only on MP3 players or on computers with MP3 software installed.

To burn a CD or DVD, follow these steps:

1. Download or copy the source files into a folder on your hard drive.
2. Insert a blank CD or DVD into the optical drive (select models only) or an optional external optical drive.
3. Select **Start > All Programs** and the name of the software you want to use.
4. Select the kind of CD or DVD you want to create—data, audio, or video.
5. Right-click **Start**, click **Explore**, and navigate to the folder where the source files are stored.
6. Open the folder, and then drag the files to the drive that contains the blank disc.
7. Initiate the burning process as directed by the program you have selected.

For specific instructions, refer to the software manufacturer's instructions. These instructions may be provided with the software, on disc, or on the manufacturer's Web site.

---

△ **CAUTION:** Observe the copyright warning. It is a criminal offense, under applicable copyright laws, to make unauthorized copies of copyright-protected material, including computer programs, films, broadcasts, and sound recordings. Do not use this computer for such purposes.

---

## Removing an optical disc (CD or DVD)

1. Press the release button **(1)** on the drive bezel to release the disc tray, and then gently pull out the tray **(2)** until it stops.
2. Remove the disc **(3)** from the tray by gently pressing down on the spindle while lifting the outer edges of the disc. Hold the disc by the edges and avoid touching the flat surfaces.

---

 **NOTE:** If the tray is not fully accessible, tilt the disc carefully as you remove it.

---

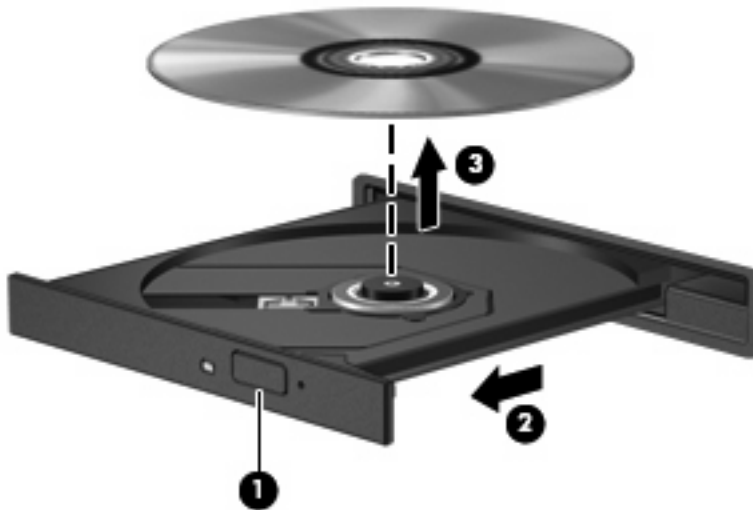

3. Close the disc tray and place the disc in a protective case.

# Webcam

 **NOTE:** This section describes features that are common to most models. Some features may not be available on your computer.

---

Your computer includes an integrated webcam, located at the top of the display. With the preinstalled software, you can use the webcam to take a photo, record a video, or make an audio recording. You can preview the photo, video recording, or audio recording, and save it on your computer hard drive.

To access the webcam and HP Webcam software, select **Start > All Programs > HP > HP Webcam**.

The webcam software enables you to experiment with the following features:

- Capture video.
- Record and play back audio.
- Stream video with instant message software.
- Take still photos.
- Use HP Business Card Reader to transform business cards into a usable database of contact information.

For optimum performance, observe the following guidelines while using the webcam:

- Be sure that you have the latest version of an instant message program before starting a video conversation.
- The webcam may not work properly across some network firewalls.

 **NOTE:** If you are having trouble viewing or sending multimedia files to someone on another LAN or outside your network firewall, temporarily disable the firewall, perform the task you want to perform, and then reenable the firewall. To permanently resolve the problem, reconfigure the firewall as necessary, and adjust the policies and settings of other intrusion detection systems. For additional information, contact your network administrator or IT department.

---

- Whenever possible, place bright light sources behind the webcam and out of the picture area.

## Adjusting webcam properties

You can adjust the following webcam properties:

- **Brightness**—Controls the amount of light that is incorporated into the image. A higher brightness setting creates a brighter image; a lower brightness setting creates a darker image.
- **Contrast**—Controls the difference between lighter and darker areas on the image. A higher contrast setting intensifies the image; a lower contrast setting maintains more of the original information's dynamic range but leads to a flatter image.
- **Hue**—Controls the aspect of color that distinguishes it from another color (what makes a color red, green, or blue). Hue is distinct from saturation, which measures the intensity of the hue.
- **Saturation**—Controls the strength of color in the final image. A higher saturation setting creates a bolder image; a lower saturation setting creates a more subtle image.
- **Sharpness**—Controls the definition of edges in an image. A higher sharpness setting creates a more defined image; a lower sharpness setting creates a softer image.

- **Gamma**—Controls the contrast affecting the mid-level grays or midtones of an image. Adjusting the gamma of an image allows you to change the brightness values of the middle range of gray tones without dramatically altering the shadows and highlights. A lower gamma setting makes grays look black, and makes dark colors even darker.
- **Backlight Compensation**—Compensates in cases where a subject with a large amount of background light would otherwise be obscured by blooming or silhouetting.
- **Night Mode**—Compensates for low-light conditions.
- **Zoom (select models only)**—Adjusts the zoom percentage for taking photos or recording videos.
- **Horizontal or vertical**—Rotates the image horizontally or vertically.
- **50Hz or 60Hz**—Adjusts the shutter speed to achieve a video recording that does not flicker.

Customizable preset profiles for multiple lighting conditions compensate for the following lighting conditions: incandescent, fluorescent, halogen, sunny, cloudy, night.

## Controlling the webcam focus

To control the webcam focus:

1. Select **Start > All Programs > HP > HP Webcam**.
2. Click the **Menu** icon, and then click **Settings**.
3. Click the **Options** tab.

The following focus options are available:

- **Normal**—The factory setting of the camera is appropriate for normal photography. This range extends from several feet in front of the lens to infinity.
- **Macro**—The close-up focus setting is for taking photos and capturing video at a very close range.

## Capturing business card images

You can use the webcam with the HP Business Card Reader program to take pictures of business cards and export the text to many types of address book software, such as Microsoft® Outlook Contacts.

To capture a business card image:

1. Select **Start > All Programs > HP > HP Business Card Reader**.
2. To capture information from one business card, select **Single Scan**.

– or –

To capture information from several business cards, select **Multi Scan**.

3. Insert a business card into the business card slot on the front of the computer (1), and slide the card to the left (2) to center it under the webcam.

 **NOTE:** If any text is obscured by the slot, rotate the card 180 degrees, with the text facing the webcam.

---

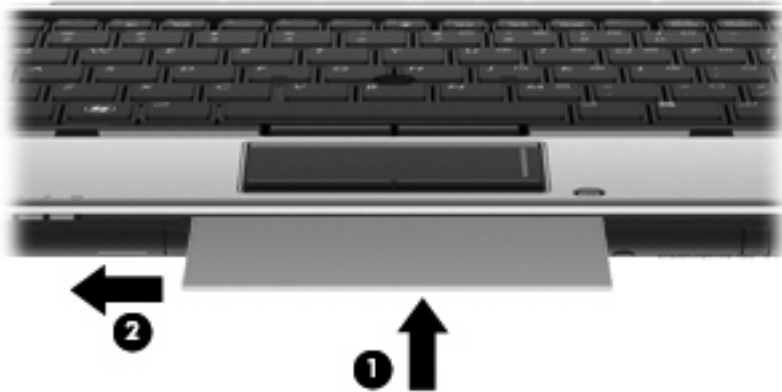

4. Slowly lower the display (1) until the webcam light (2) stops blinking and you hear a sound, which indicates that the webcam is now in focus.



5. If you are capturing several business card images, remove the first business card, and insert the next one. The webcam light turns on when the card is in focus. The webcam then takes a picture of the business card, and the webcam light turns off.

Repeat this step to capture additional business cards.

6. When you have finished capturing business card information, remove the business card from the slot and raise the display.
7. Review the information captured by HP Business Card Reader to be sure that it is complete.

---

# 5 Power management

## Setting power options

### Using power-saving states

The computer has two power-saving states enabled at the factory: Standby and Hibernation.

When Standby is initiated, the power lights blink and the screen clears. Your work is saved to memory. Exiting Standby is faster than exiting Hibernation. If the computer is in Standby for an extended period or if the battery reaches a critical battery level while in Standby, the computer initiates Hibernation.

When Hibernation is initiated, your work is saved to a hibernation file on the hard drive and the computer turns off.

---

△ **CAUTION:** To prevent possible audio and video degradation, loss of audio or video playback functionality, or loss of information, do not initiate Standby or Hibernation while reading from or writing to a disc or an external media card.

📝 **NOTE:** You cannot initiate any type of networking connection or perform any computer functions while the computer is in Standby or in Hibernation.

**NOTE:** When HP 3D DriveGuard has parked a drive, the computer will not initiate Standby or Hibernation, and the display will be turned off.

---

### Initiating and exiting Standby

The system is set at the factory to initiate Standby after 10 minutes of inactivity when running on battery power and 25 minutes of inactivity when running on external power.

Power settings and timeouts can be changed using Power Options in Windows® Control Panel.

With the computer on, you can initiate Standby in any of the following ways:

- Press **fn+f3**.
- Select **Start > Turn Off Computer > Stand By**.

📝 **NOTE:** If you have been registered to a network domain, the button you click will be called Shut Down instead of Turn Off Computer.

---

If Standby is not displayed, follow these steps:

- a. Click the down arrow.
- b. Select **Stand by** from the list.
- c. Click **OK**.



To exit Standby:

- ▲ Press the power button.

When the computer exits Standby, the power lights turn on and your work returns to the screen where you stopped working.

---

 **NOTE:** If you have set a password to be required when the computer exits Standby, you must enter your Windows password before your work will return to the screen.

---

## Initiating and exiting Hibernation

The system is set at the factory to initiate Hibernation after 30 minutes of inactivity when running on battery power or when the battery reaches a critical battery level.

---

 **NOTE:** The system will not initiate Hibernation when running on external power.

---

Power settings and timeouts can be changed using Power Options in Windows Control Panel.

To initiate Hibernation:

1. Select **Start > Turn Off Computer**.

---

 **NOTE:** If you have been registered to a network domain, the button you click will be called Shut Down instead of Turn Off Computer.

---

2. Hold down the **shift** key and select **Hibernate**.

If Hibernate is not displayed, follow these steps:

- a. Click the down arrow.
- b. Select **Hibernate** from the list.
- c. Click **OK**.

To exit Hibernation:

- ▲ Press the power button.

The power lights turn on and your work returns to the screen where you stopped working.

---

 **NOTE:** If you have set a password to be required when the computer exits Hibernation, you must enter your Windows password before your work will return to the screen.

---

## Using the Power Meter

The Power Meter is located in the notification area, at the far right of the taskbar. The Power Meter allows you to quickly access power settings and view the remaining battery charge.

- To access Power Options, right-click the **Power Meter** icon and select **Adjust Power Properties**.
- To display the percentage of remaining battery charge, double-click the **Power Meter** icon.

Different power meter icons indicate whether the computer is running on battery or external power.

To remove the Power Meter icon from the notification area, follow these steps:

1. Right-click the **Power Meter** icon in the notification area, and then click **Adjust Power Properties**.
2. Click the **Advanced** tab.
3. Clear the **Always show icon on the taskbar** check box.
4. Click **Apply**, and then click **OK**.

To show the Power Meter icon in the notification area, follow these steps:

1. Select **Start > Control Panel > Performance and Maintenance > Power Options**.
2. Click the **Advanced** tab.
3. Select the **Always show icon on the taskbar** check box.
4. Click **Apply**, and then click **OK**.

---

 **NOTE:** If you cannot see an icon you have placed in the notification area, click the **Show Hidden Icons** icon (< or <<) in the notification area.

---

## Using power schemes

A power scheme is a collection of system settings that manages how the computer uses power. Power schemes can help you conserve power and maximize computer performance.

The following power schemes are available:

- Portable/Laptop (recommended)
- Home/Office Desk
- Presentation
- Always On
- Minimal Power Management
- Max Battery

You can change the settings of these power schemes through Power Options.

## Viewing the current scheme

- ▲ Click the **Power Meter** icon in the notification area, at the far right of the taskbar.

– or –

Select **Start > Control Panel > Performance and Maintenance > Power Options**.

## Selecting a different power scheme

- ▲ Click the **Power Meter** icon in the notification area, at the far right of the taskbar, and then select a power scheme from the list.

– or –

- a. Select **Start > Control Panel > Performance and Maintenance > Power Options**.
- b. Select a power scheme from the **Power schemes** list.
- c. Click **OK**.

## Customizing power schemes

1. Select **Start > Control Panel > Performance and Maintenance > Power Options**.
2. Select a power scheme from the **Power schemes** list.
3. Modify the **Plugged in** and **Running on batteries settings** as needed.
4. Click **OK**.

## Setting password protection upon exiting Standby

To set the computer to prompt for a password when the computer exits Standby, follow these steps:

1. Right-click the **Power Meter** icon in the notification area, and then click **Adjust Power Properties**.
2. Click the **Advanced** tab.
3. Select the **Prompt for password when computer resumes from standby** check box.
4. Click **Apply**.

## Using external AC power

External AC power is supplied through one of the following devices:

**⚠ WARNING!** To reduce potential safety issues, use only the AC adapter provided with the computer, a replacement AC adapter provided by HP, or a compatible AC adapter purchased from HP.

- Approved AC adapter
- Optional docking device

Connect the computer to external AC power under any of the following conditions:

**⚠ WARNING!** Do not charge the computer battery while you are onboard aircraft.

- When you are charging or calibrating a battery
- When you are installing or modifying system software
- When you are writing information to a CD or DVD

When you connect the computer to external AC power, the following events occur:

- The battery begins to charge.
- If the computer is turned on, the power meter icon in the notification area changes appearance.

When you disconnect external AC power, the following events occur:

- The computer switches to battery power.
- The display brightness is automatically decreased to save battery life. To increase display brightness, press the **fn+f10** hotkey or reconnect the AC adapter.

## Connecting the AC adapter

**⚠ WARNING!** To reduce the risk of electric shock or damage to the equipment:

Plug the power cord into an AC outlet that is easily accessible at all times.

Disconnect power from the computer by unplugging the power cord from the AC outlet (not by unplugging the power cord from the computer).

If provided with a 3-pin attachment plug on the power cord, plug the cord into a grounded (earthed) 3-pin outlet. Do not disable the power cord grounding pin, for example, by attaching a 2-pin adapter. The grounding pin is an important safety feature.

To connect the computer to external AC power, follow these steps:

1. Plug the AC adapter into the power connector **(1)** on the computer.
2. Plug the power cord into the AC adapter **(2)**.
3. Plug the other end of the power cord into an AC outlet **(3)**.

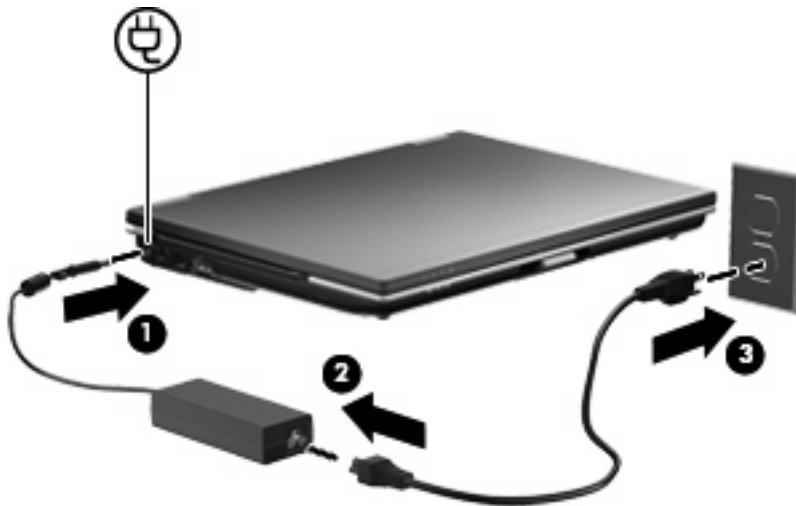

## Using battery power

When a charged battery is in the computer and the computer is not plugged into external power, the computer runs on battery power. When the computer is plugged into external AC power, the computer runs on AC power.

If the computer contains a charged battery and is running on external AC power supplied through the AC adapter, the computer switches to battery power if the AC adapter is disconnected from the computer.

---

 **NOTE:** The display brightness is decreased to save battery life when you disconnect AC power. To increase display brightness, use the **fn+f10** hotkey or reconnect the AC adapter.

---

You can keep a battery in the computer or in storage, depending on how you work. Keeping the battery in the computer whenever the computer is plugged into AC power charges the battery and also protects your work in case of a power outage. However, a battery in the computer slowly discharges when the computer is off and unplugged from external power.

---

 **WARNING!** To reduce potential safety issues, use only the battery provided with the computer, a replacement battery provided by HP, or a compatible battery purchased from HP.

---

Computer battery life varies, depending on power management settings, programs running on the computer, display brightness, external devices connected to the computer, and other factors.

## Displaying the remaining battery charge

 Double-click the **Power Meter** icon in the notification area, at the far right of the taskbar.

– or –

Select **Start > Control Panel > Performance and Maintenance > Power Options > Power Meter** tab.

Most charge indicators report battery status as both a percentage and as the number of minutes of charge remaining:

- The percentage indicates the approximate amount of charge remaining in the battery.
- The time indicates the approximate running time remaining on the battery *if the battery continues to provide power at the current level*. For example, the time remaining will decrease when a DVD is playing and will increase when a DVD stops playing.

When a battery is charging, a lightning bolt icon may be superimposed over the battery icon on the Power Meter screen.

## Inserting or removing the battery

---

 **CAUTION:** Removing a battery that is the sole power source can cause loss of information. To prevent loss of information, save your work and initiate Hibernation or shut down the computer through Windows before removing the battery.

---

To insert the battery:

1. Turn the computer upside down on a flat surface, with the battery bay toward you.

2. Insert the battery into the battery bay (1) until it is seated.

The battery release latches (2) automatically lock the battery into place.

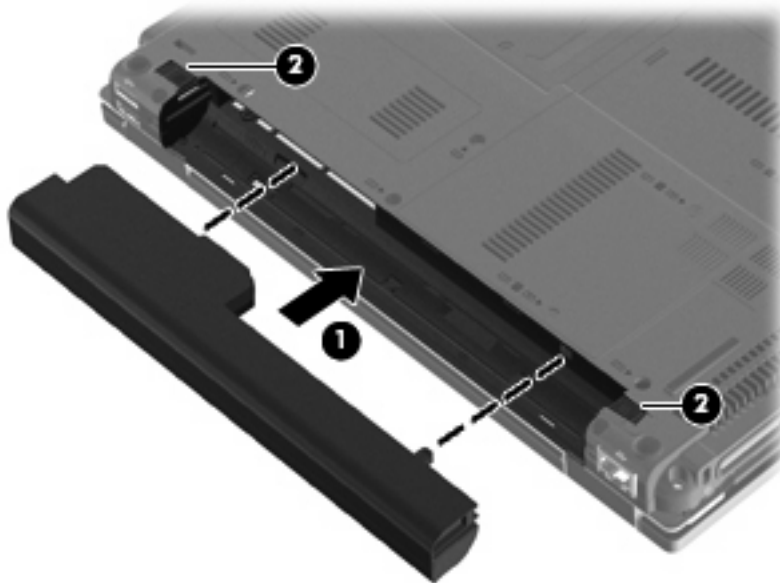

To remove the battery:

1. Turn the computer upside down on a flat surface, with the battery bay toward you.
2. Slide the left battery release latch (1) until it locks into place.
3. Slide the right battery release latch (2) to release the battery.
4. Remove the battery (3).

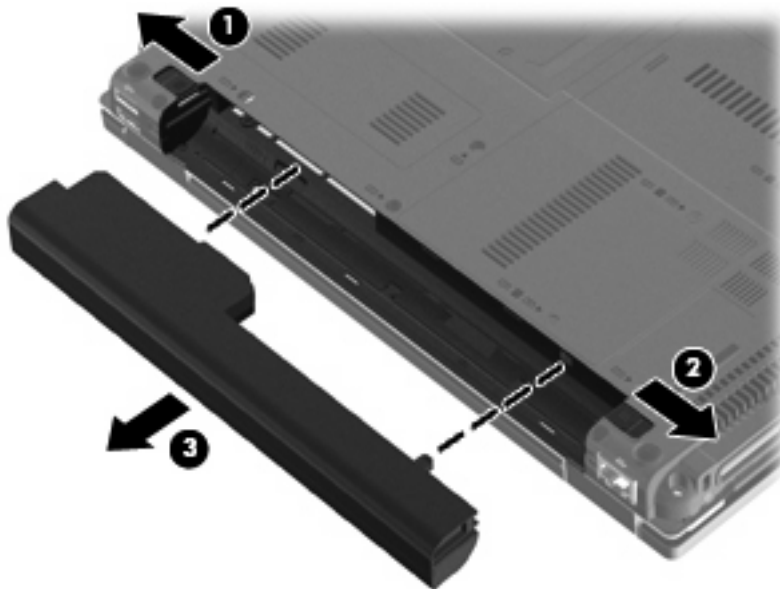

## Charging a battery

**⚠ WARNING!** Do not charge the computer battery while you are onboard aircraft.

The battery charges whenever the computer is plugged into external power through an AC adapter, an optional power adapter, or an optional docking device.

The battery charges whether the computer is off or in use, but it charges faster when the computer is off.

Charging may take longer if a battery is new, has been unused for 2 weeks or more, or is much warmer or cooler than room temperature.

To prolong battery life and optimize the accuracy of battery charge displays, follow these recommendations:

- If you are charging a new battery, charge it fully before turning on the computer.
- Charge the battery until the battery light turns off.

 **NOTE:** If the computer is on while the battery is charging, the power meter in the notification area may show 100 percent charge before the battery is fully charged.

- Allow the battery to discharge below 5 percent of a full charge through normal use before charging it.
- If the battery has been unused for one month or more, calibrate the battery instead of simply charging it.

The battery light displays charge status:

- Amber: A battery is charging.
- White: A battery is close to full charge capacity.
- Blinking amber: A battery that is the only available power source has reached a low battery level. When the battery reaches a critical battery level, the battery light begins blinking rapidly.
- Off: If the computer is plugged into an external power source, the light turns off when all batteries in the computer are fully charged. If the computer is not plugged into an external power source, the light stays off until the battery reaches a low battery level.

## Maximizing battery discharge time

Battery discharge time varies, depending on the features you use while on battery power. Maximum discharge time gradually shortens as the battery storage capacity naturally degrades.

Tips for maximizing battery discharge time:

- Lower the brightness on the display.
- Remove the battery from the computer when it is not being used or charged.
- Store the battery in a cool, dry location.

## Managing low battery levels

The information in this section describes the alerts and system responses set at the factory. Some low-battery alerts and system responses can be changed using Power Options in Windows Control Panel. Preferences set using Power Options do not affect lights.

## Identifying low battery levels

When a battery that is the sole power source for the computer reaches a low battery level, the battery light blinks.

If a low battery level is not resolved, the computer enters a critical battery level, and the battery light blinks rapidly.

The computer takes the following actions for a critical battery level:

- If Hibernation is enabled and the computer is on or in Standby, the computer initiates Hibernation.
- If Hibernation is disabled and the computer is on or in Standby, the computer remains briefly in Standby, and then shuts down and loses any unsaved information.



## Resolving a low battery level

---

△ **CAUTION:** To reduce the risk of losing information when the computer reaches a critical battery level and has initiated Hibernation, do not restore power until the power lights turn off.

---

### Resolving a low battery level when external power is available

- ▲ Connect one of the following devices:
  - AC adapter
  - Optional docking device
  - Optional power adapter

### Resolving a low battery level when a charged battery is available

1. Turn off the computer or initiate Hibernation.
2. Remove the discharged battery, and then insert a charged battery.
3. Turn on the computer.

### Resolving a low battery level when no power source is available

- ▲ Initiate Hibernation.  
– or –  
Save your work and shut down the computer.

### Resolving a low battery level when the computer cannot exit Hibernation

When the computer lacks sufficient power to exit Hibernation, follow these steps:

1. Insert a charged battery or plug the computer into external power.
2. Exit Hibernation by briefly pressing the power button.

## Calibrating a battery

Calibrate a battery under the following conditions:

- When battery charge displays seem inaccurate
- When you observe a significant change in battery run time

Even if a battery is heavily used, it should not need to be calibrated more than once a month. It is also not necessary to calibrate a new battery.

### Step 1: Fully charge the battery

---

△ **WARNING!** Do not charge the computer battery while you are onboard aircraft.

📝 **NOTE:** The battery charges whether the computer is off or in use, but it charges faster when the computer is off.

---

To fully charge the battery:

1. Insert the battery into the computer.
2. Connect the computer to an AC adapter, optional power adapter, or optional docking device, and then plug the adapter or device into external power.

The battery light on the computer turns on.

3. Leave the computer plugged into external power until the battery is fully charged.

The battery light on the computer turns off.

## Step 2: Disable Hibernation and Standby

1. Right-click the **Power Meter** icon in the notification area, at the far right of the taskbar, and then click **Adjust Power Properties**.

– or –

Select **Start > Control Panel > Performance and Maintenance > Power Options**.

2. Record the 4 settings listed in the **Running on batteries** and **Plugged in** columns so that you can reset them after the calibration.
3. Set the 4 options to **Never**.
4. Click **OK**.

## Step 3: Discharge the battery

The computer must remain on while the battery is being discharged. The battery can discharge whether or not you are using the computer, but the battery will discharge faster while you are using it.

- If you plan to leave the computer unattended during the discharge, save your information before beginning the discharge procedure.
- If you use the computer occasionally during the discharge procedure and have set energy-saving timeouts, expect the following performance from the system during the discharge process:
  - The monitor will not turn off automatically.
  - Hard drive speed will not decrease automatically when the computer is idle.
  - System-initiated Hibernation will not occur.

To discharge a battery:

1. Unplug the computer from its external power source, but do *not* turn off the computer.
2. Run the computer on battery power until the battery is discharged. The battery light begins to blink when the battery has discharged to a low battery level. When the battery is discharged, the battery light turns off and the computer shuts down.

## Step 4: Fully recharge the battery

To recharge the battery:

1. Plug the computer into external power and maintain external power until the battery is fully recharged. When the battery is recharged, the battery light on the computer turns off.

You can use the computer while the battery is recharging, but the battery will charge faster if the computer is off.

2. If the computer is off, turn it on when the battery is fully charged and the battery light has turned off.

## Step 5: Reenable Hibernation and Standby

---

△ **CAUTION:** Failure to reenable Hibernation after calibration may result in a full battery discharge and information loss if the computer reaches a critical battery level.

---

1. Select **Start > Control Panel > Performance and Maintenance > Power Options**.
2. Reenter the settings that you recorded for the items in the **Plugged in** column and the **Running on batteries** column.
3. Click **OK**.

## Conserving battery power

- Select low power-use settings through Power Options in Windows Control Panel.
- Turn off wireless and local area network (LAN) connections and exit modem applications when you are not using them.
- Disconnect external devices that are not plugged into an external power source, when you are not using them.
- Stop, disable, or remove any external media cards that you are not using.
- Use the **fn+f9** and **fn+f10** hotkeys to adjust screen brightness as needed.
- If you leave your work, initiate Standby or Hibernation, or shut down the computer.

## Storing a battery

---

△ **CAUTION:** To prevent damage to a battery, do not expose it to high temperatures for extended periods of time.

---

If a computer will be unused and unplugged from external power for more than 2 weeks, remove the battery and store it separately.

To prolong the charge of a stored battery, place it in a cool, dry place.

---

 **NOTE:** A stored battery should be checked every 6 months. If the capacity is less than 50 percent, recharge the battery before returning it to storage.

---

Calibrate a battery before using it if it has been stored for one month or more.

## Disposing of a used battery

---

 **WARNING!** To reduce the risk of fire or burns, do not disassemble, crush, or puncture; do not short external contacts; do not dispose of in fire or water.

---

Refer to the *Regulatory, Safety and Environmental Notices* for battery disposal information.

## Replacing the battery

Computer battery life varies, depending on the power management settings, programs running on the computer, display brightness, external devices connected to the computer, and other factors.

---

 **NOTE:** To ensure that you always have battery power when you need it, HP recommends purchasing a new battery when the storage capacity indicator turns green-yellow.

---

# Testing an AC adapter

Test the AC adapter if the computer exhibits any of the following symptoms:

- The computer will not turn on when it is connected to the AC adapter and external power.
- The display does not turn on when the computer is connected to the AC adapter and external power.
- The power lights are off when the computer is connected to the AC adapter and external power.

To test the AC adapter:

1. Remove the battery from the computer.
2. Connect the AC adapter to the computer and an AC outlet.
3. Turn on the computer.
  - If the power lights turn **on**, the AC adapter is functioning properly.
  - If the power lights remain **off**, the AC adapter is not functioning and should be replaced.

Contact technical support for information on obtaining a replacement AC power adapter. Select **Start > Help and Support > Contact support**.

# Shutting down the computer

 **CAUTION:** Unsaved information will be lost when the computer is shut down.

The Shut Down command closes all open programs, including the operating system, and then turns off the display and computer.

Shut down the computer under any of the following conditions:

- When you need to replace the battery or access components inside the computer
- When you are connecting an external hardware device that does not connect to a USB port
- When the computer will be unused and disconnected from external power for an extended period

To shut down the computer, follow these steps:

 **NOTE:** If the computer is in Standby or in Hibernation, you must first exit Standby or Hibernation before shutdown is possible.

1. Save your work and close all open programs.
2. Select **Start > Turn Off Computer > Turn Off**.

 **NOTE:** If you have been registered to a network domain, the button you click will be called Shut Down instead of Turn Off Computer.

If the computer is unresponsive and you are unable to use the preceding shutdown procedures, try the following emergency procedures in the sequence provided:

- Press **ctrl+alt+delete**. Then, click **Shut Down > Turn Off**.
- Press and hold the power button for at least 5 seconds.
- Disconnect the computer from external power and remove the battery.

---

# 6 Drives

## Identifying installed drives

To view the drives installed on the computer, select **Start > My Computer**.

## Handling drives

Drives are fragile computer components that must be handled with care. Refer to the following cautions before handling drives. Additional cautions are included with the procedures to which they apply.

---

△ **CAUTION:** To reduce the risk of damage to the computer, damage to a drive, or loss of information, observe these precautions:

Before you move a computer that is connected to an external hard drive, initiate Standby and allow the screen to clear, or properly disconnect the external hard drive.

Before handling a drive, discharge static electricity by touching the unpainted metal surface of the drive.

Do not touch the connector pins on a removable drive or on the computer.

Handle a drive carefully; do not drop a drive or place items on it.

Before removing or inserting a drive, shut down the computer. If you are unsure whether the computer is off, in Standby, or in Hibernation, turn the computer on and then shut it down through the operating system.

Do not use excessive force when inserting a drive into a drive bay.

Do not type on the keyboard or move the computer while an optional optical drive is writing to a disc. The write process is sensitive to vibration.

When the battery is the only source of power, be sure that the battery is sufficiently charged before writing to media.

Avoid exposing a drive to temperature or humidity extremes.

Avoid exposing a drive to liquids. Do not spray the drive with cleaning products.

Remove media from a drive before removing the drive from the drive bay, or traveling with, shipping, or storing a drive.

If a drive must be mailed, place the drive in a bubble-pack mailer or other suitable protective packaging and label the package "FRAGILE."

Avoid exposing a drive to magnetic fields. Security devices with magnetic fields include airport walk-through devices and security wands. The airport security devices that check carry-on luggage, such as conveyor belts, use X-rays instead of magnetism and will not damage a drive.

---



# Improving hard drive performance

## Using Disk Defragmenter

As you use the computer, files on the hard drive become fragmented. Disk Defragmenter consolidates the fragmented files and folders on the hard drive so that the system can run more efficiently.

After you start Disk Defragmenter, it works without supervision. Depending on the size of your hard drive and the number of fragmented files, Disk Defragmenter may take more than an hour to complete. You may want to set it to run during the night or another time when you do not need access to your computer.

HP recommends defragmenting your hard drive at least once a month. You may set Disk Defragmenter to run on a monthly schedule, but you can defragment your computer manually at any time.

To run Disk Defragmenter:

1. Select **Start > All Programs > Accessories > System Tools > Disk Defragmenter**.
2. Under **Volume**, click the listing for the hard drive, usually listed as (C:), and then click **Defragment**.

For additional information, access the Disk Defragmenter software Help.

## Using Disk Cleanup

Disk Cleanup searches the hard drive for unnecessary files that you can safely delete to free up disk space and help the computer to run more efficiently.

To run Disk Cleanup:

1. Select **Start > All Programs > Accessories > System Tools > Disk Cleanup**.
2. Follow the on-screen instructions.

## Using HP 3D DriveGuard

HP 3D DriveGuard protects the hard drive by parking the drive and halting I/O requests under either of the following conditions:

- You drop the computer.
- You move the computer with the display closed while the computer is running on battery power.

A short time after the end of one of these events, HP 3D DriveGuard returns the hard drive to normal operation.

---

 **NOTE:** Hard drives that are in an optional docking device or are connected to a USB port are not protected by HP 3D DriveGuard.

Because solid-state drives (select models only) lack rotating parts, protection by HP 3D DriveGuard is unnecessary.

---

For more information, refer to the HP 3D DriveGuard software Help.

## Identifying HP 3D DriveGuard status

The drive light on the computer changes to an amber color to show that the drive is parked. To determine whether drives are currently protected or whether a drive is parked, use the icon in the notification area, at the far right of the taskbar:

- If the software is enabled, a green check mark is superimposed over the hard drive icon.
- If the software is disabled, a red X is superimposed over the hard drive icon.
- If the drives are parked, a yellow moon is superimposed over the hard drive icon.

If HP 3D DriveGuard has parked the drive, the computer will behave in the following ways:

- The computer will not shut down.
- The computer will not initiate Standby or Hibernation, except as described in the following Note.

---

 **NOTE:** If the computer is running on battery power and reaches a critical battery level, HP 3D DriveGuard allows the computer to initiate Hibernation.

- The computer will not activate battery alarms set on the Alarms tab in Power Options Properties.

Before you move the computer, HP recommends that you either shut it down or initiate Standby or Hibernation.

## Using HP 3D DriveGuard software

The HP 3D DriveGuard software enables you to perform the following tasks:

- Enable and disable HP 3D DriveGuard.

---

 **NOTE:** Depending on your user privileges, you may not be able to enable or disable HP 3D DriveGuard.

- Determine whether a drive in the system is supported.
- Hide or show the icon in the notification area.

To open the software and change settings, follow these steps:

1. Double-click the icon in the notification area, at the far right of the taskbar.  
– or –  
Right-click the icon in the notification area, and then select **Settings**.
2. Click the appropriate button to change settings.
3. Click **OK**.

## Using RAID (select models only)

RAID (Redundant Array of Independent Disks) is a solution to recover data in the event of drive failure. Your computer includes a simple RAID solution that protects data on a Serial ATA (SATA) disk drive in case of drive failure or virus attacks. HP's RAID solution also benefits computer users who frequently work with large files and want to improve storage performance of their computer.

For additional information about RAID, refer to the *RAID* user guide in Help and Support.

## Replacing a hard drive

Your computer is equipped with either a 1.8-inch hard drive or a 2.5-inch hard drive, or your computer may have 2 hard drives (1.8-inch and 2.5-inch). The replacement procedures vary, depending on the type of hard drive(s) installed on the computer.

△ **CAUTION:** To prevent information loss or an unresponsive system:

Shut down the computer before removing the hard drive from the hard drive bay. Do not remove the hard drive while the computer is on, in Standby, or in Hibernation.

If you are not sure whether the computer is off or in Hibernation, turn the computer on by briefly pressing the power button. Then shut down the computer through the operating system.

### Replacing a 1.8-inch hard drive

To remove a 1.8-inch hard drive:

1. Save your work.
2. Shut down the computer and close the display.
3. Disconnect all external hardware devices connected to the computer.
4. Unplug the power cord from the AC outlet.
5. Turn the computer upside down on a flat surface, with the battery bay toward you.
6. Remove the battery from the computer.
7. Loosen the 3 hard drive cover screws (1).
8. Using your finger or a screwdriver, lift the edge of the hard drive cover (2) to release it, and then lift it away from the computer (3).

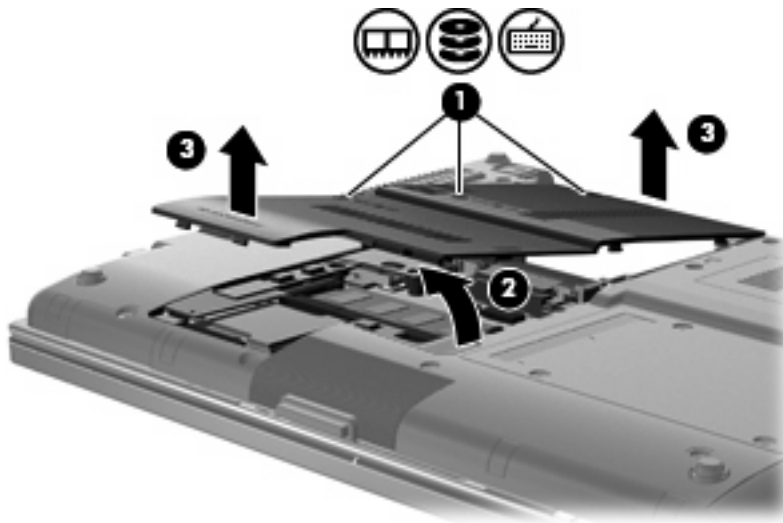

9. Remove the 2 hard drive shield screws (1).

10. Lift the right side of the hard drive shield (2), and then slide it away from the computer (3).

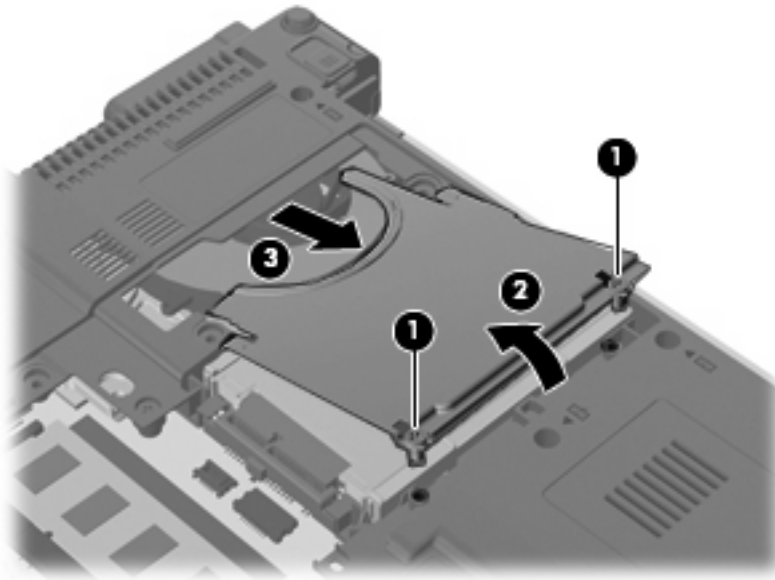

11. Lift the right side of the hard drive (1), and then remove it from the hard drive bay (2).

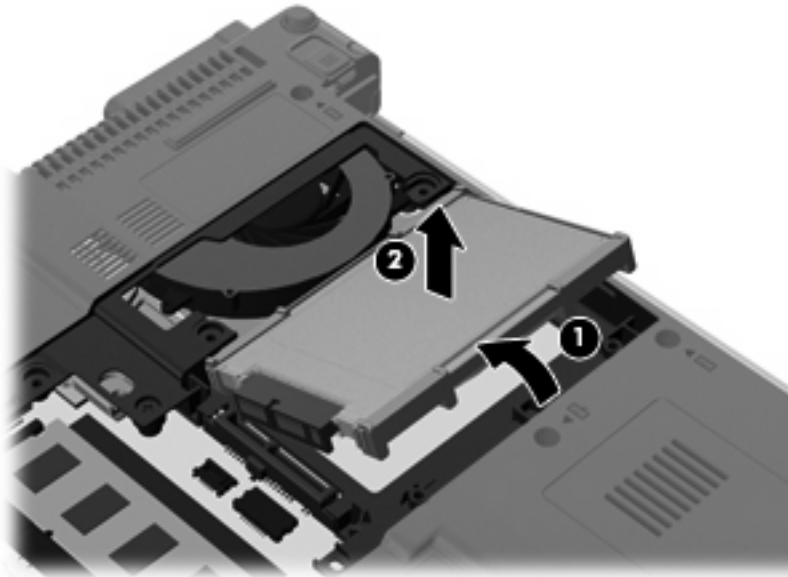

12. Remove the rubber shield from the hard drive.



13. Remove the hard drive connector from the hard drive.

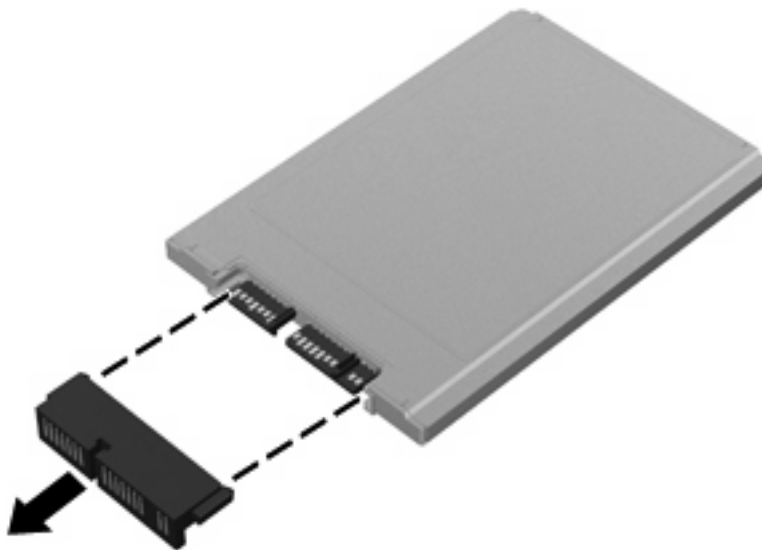

To install a 1.8-inch hard drive:

1. Replace the hard drive connector.

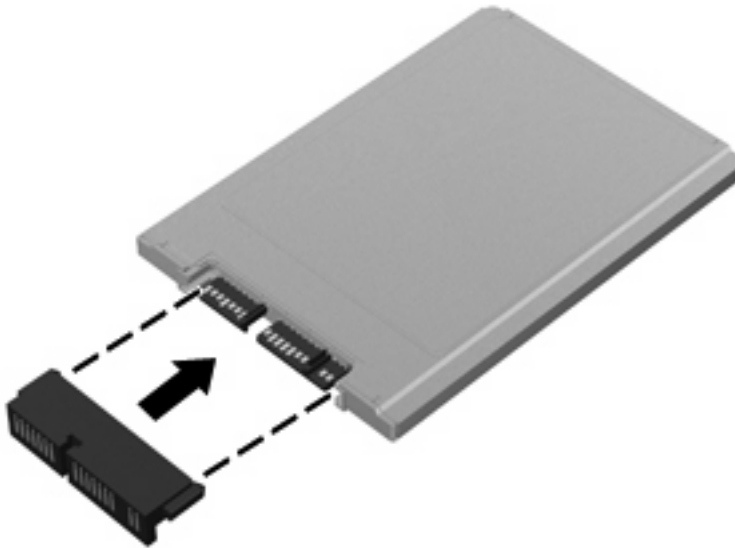

2. Replace the rubber shield.

 **NOTE:** When replacing the rubber shield, be sure to position it with the feet facing downward.



3. Insert the hard drive into the hard drive bay (1).



4. Press down on the hard drive connector (2).

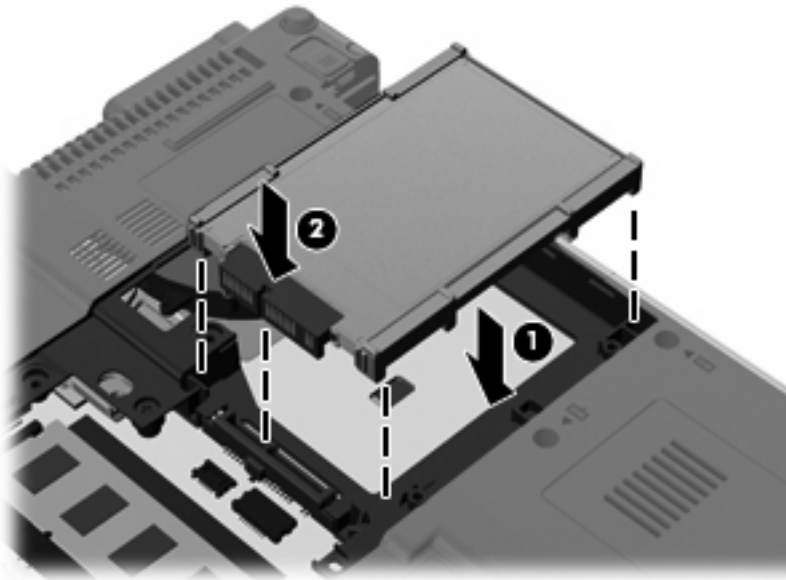

5. Insert the hard drive shield (1) at an angle, and then rotate it downward (2).
6. Replace the 2 hard drive shield screws (3).

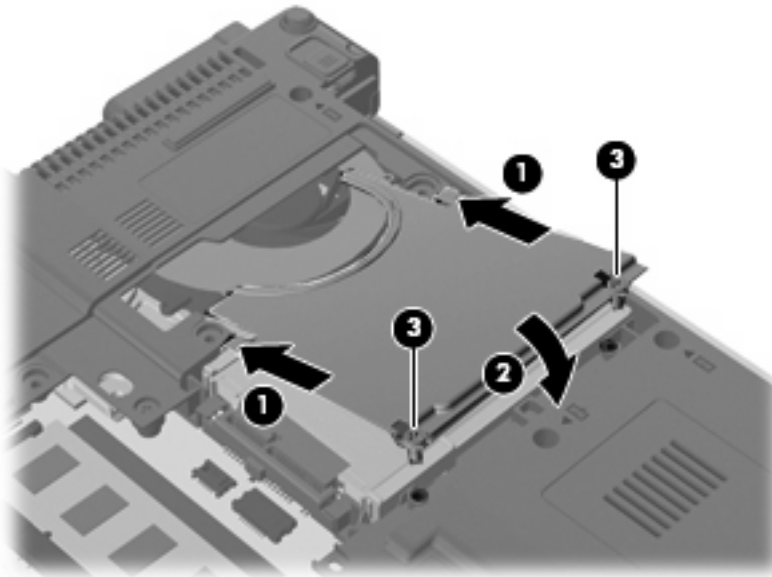

7. Align the tabs (1) on the hard drive cover with the notches on the computer.
8. Lower the cover (2), and then press down on the cover to snap it into place.

9. Tighten the 3 hard drive cover screws **(3)**.

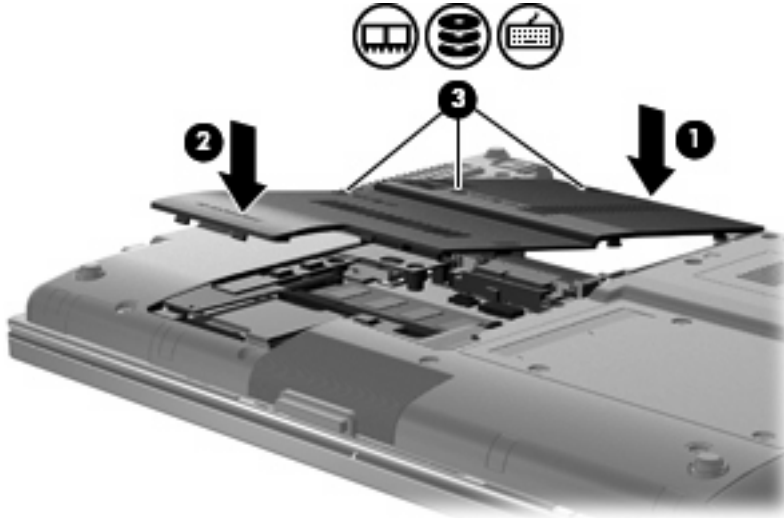

10. Reinstall the battery.
11. Turn the computer right-side up, and then reconnect external power and external devices.
12. Turn on the computer.

## Replacing a 2.5-inch hard drive

To replace a 2.5-inch hard drive:

1. Save your work.
2. Shut down the computer and close the display.
3. Disconnect all external hardware devices connected to the computer.
4. Unplug the power cord from the AC outlet.
5. Turn the computer upside down on a flat surface, with the hard drive bay toward you.
6. Remove the battery from the computer.
7. Loosen the 3 memory module compartment screws **(1)**.

- Using your finger or a screwdriver, lift the edge of the memory module compartment cover (2) to release it, and then lift it away from the computer (3).

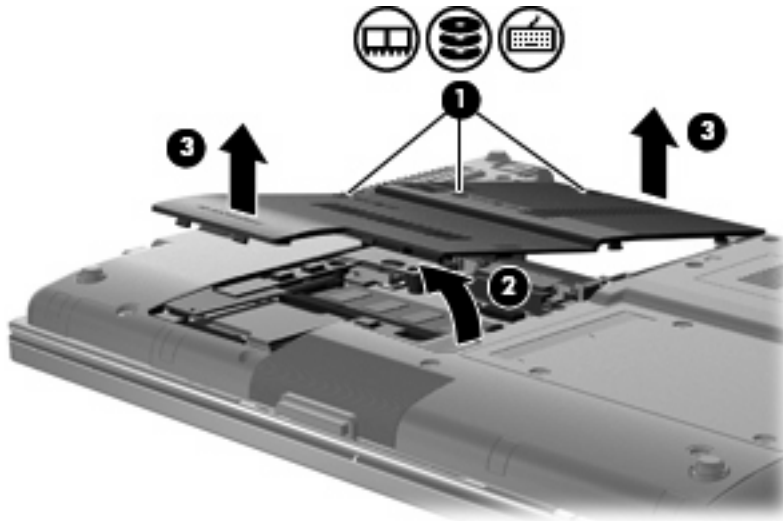

- Remove the 6 hard drive carrier screws.

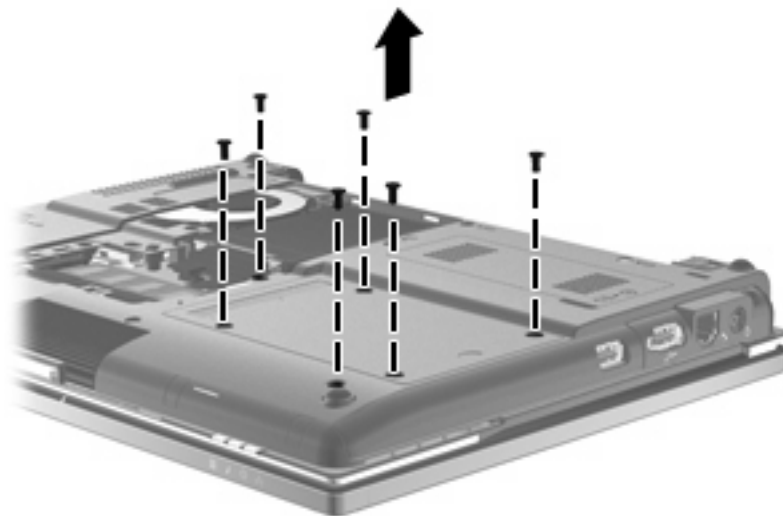

10. Gently slide the hard drive carrier out of the hard drive bay.

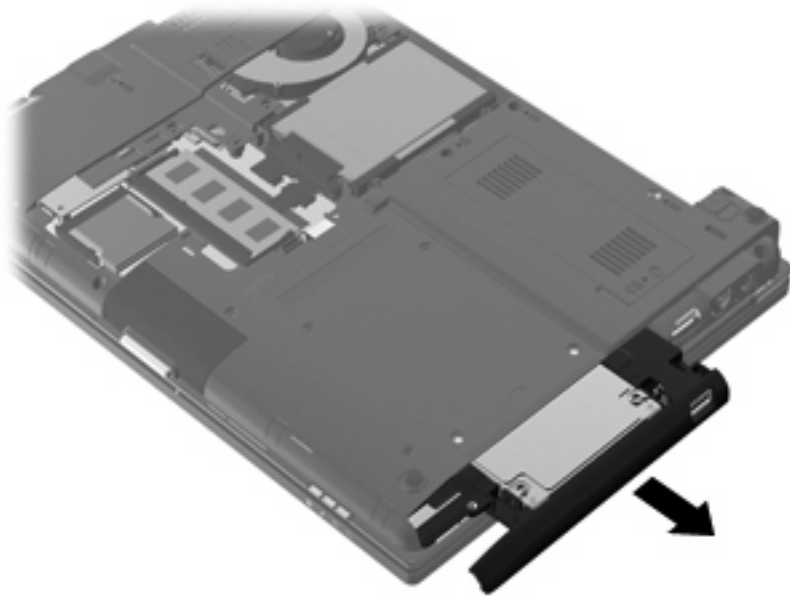

11. Remove the hard drive from the hard drive carrier:
  - a. Disconnect the ZIFF connector (1) and the ribbon cable (2).

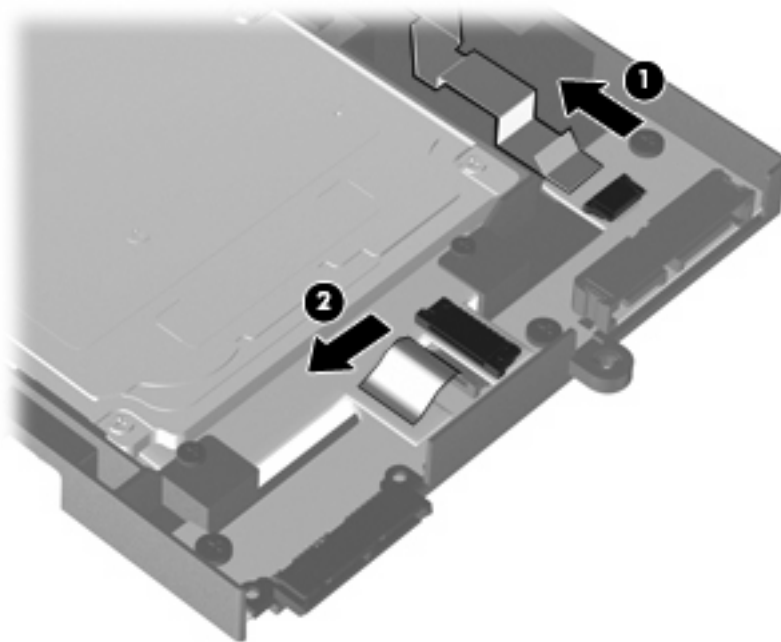

- b. Remove the 2 screws on top of the hard drive carrier (1).

- c. Remove the 2 screws on each side of the hard drive carrier (2).

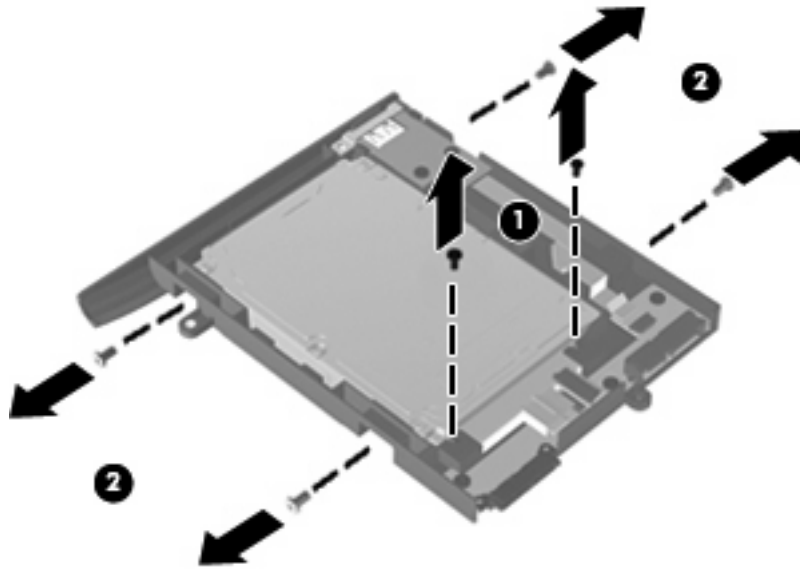

- d. Lift the rear edge of the hard drive (1) and slide it out of the hard drive carrier (2).

 **NOTE:** This action also disconnects the hard drive from the USB board.

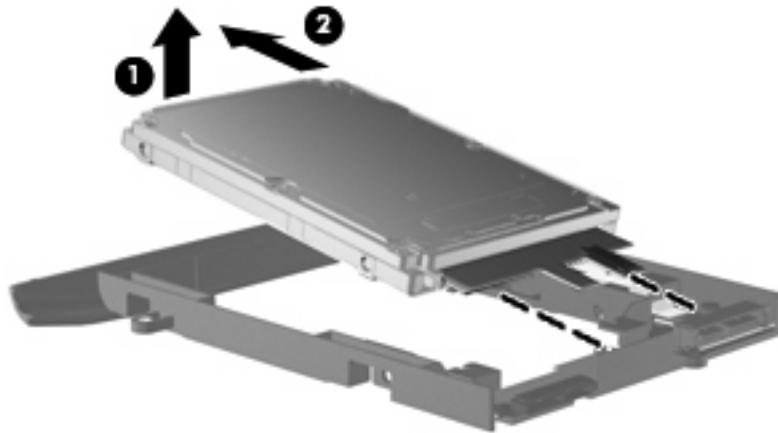

To install a 2.5-inch hard drive:

1. Insert the hard drive into the hard drive carrier:
  - a. Insert the hard drive (1) at an angle into the hard drive carrier to reconnect the USB board, and push down to seat the hard drive (2).

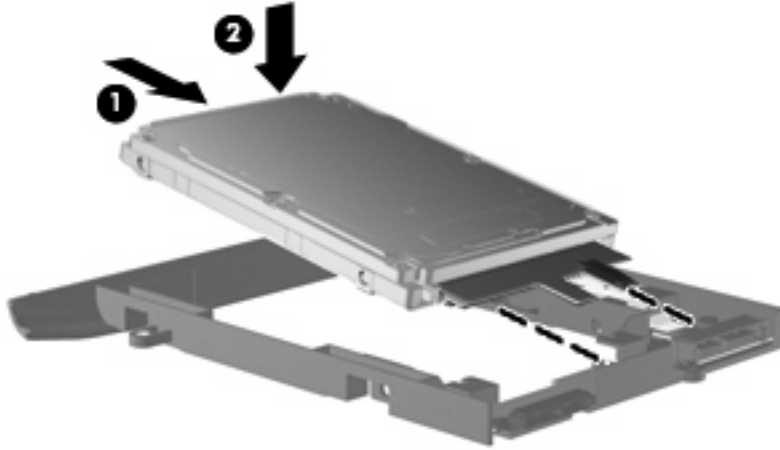

- b. Replace the 2 screws on each side of the hard drive carrier (1).
  - c. Replace the 2 screws on top of the hard drive carrier (2).

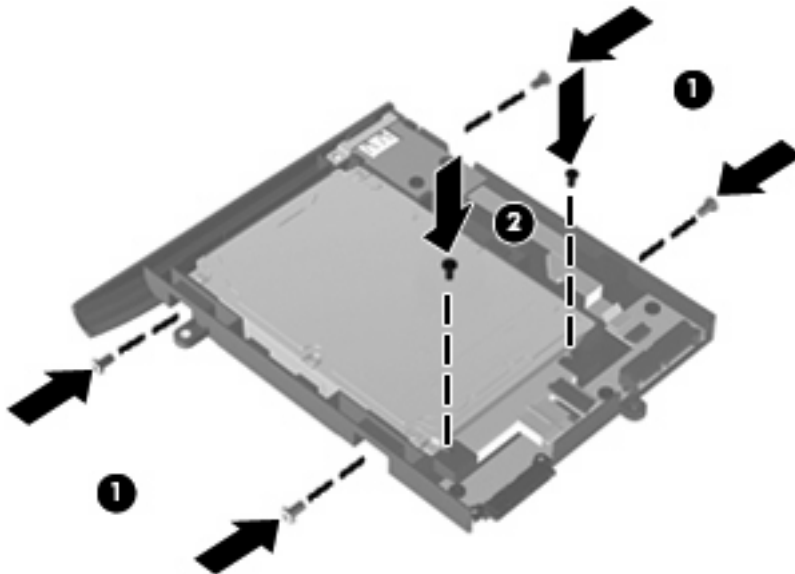

- d. Reconnect the ZIFF connector (1) and the ribbon cable (2).

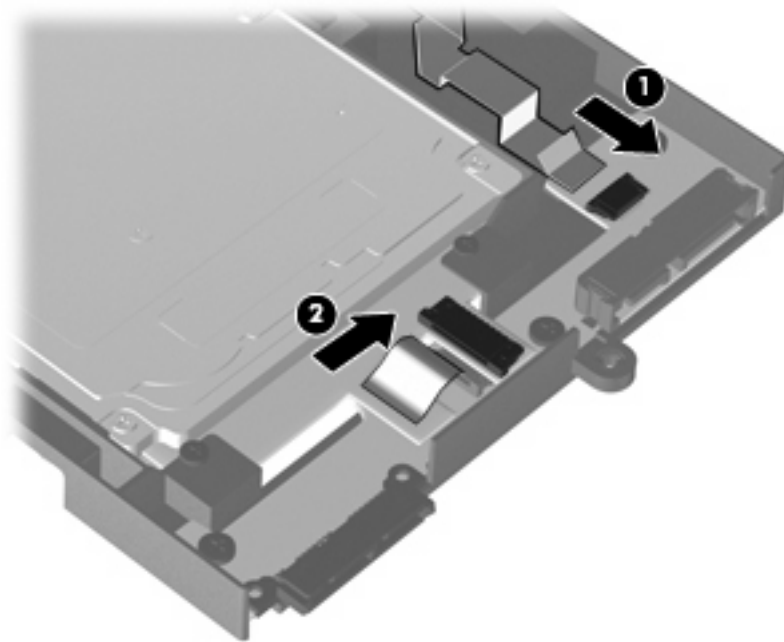

2. Insert the hard drive carrier into the hard drive bay until it is firmly seated.

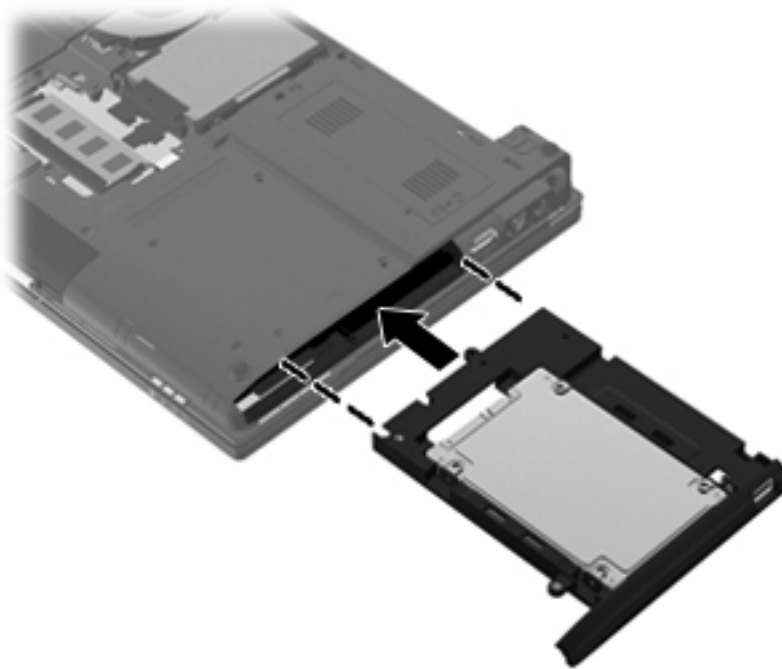

3. Replace the 6 hard drive carrier screws.

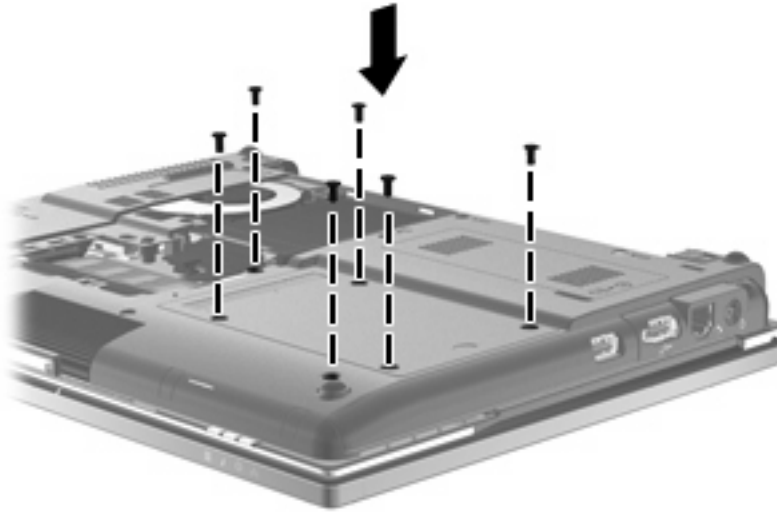

4. Align the tabs (1) on the memory module compartment cover with the notches on the computer.
5. Lower the cover (2), and then press down on the cover to snap it into place.
6. Tighten the 3 memory module compartment cover screws (3).

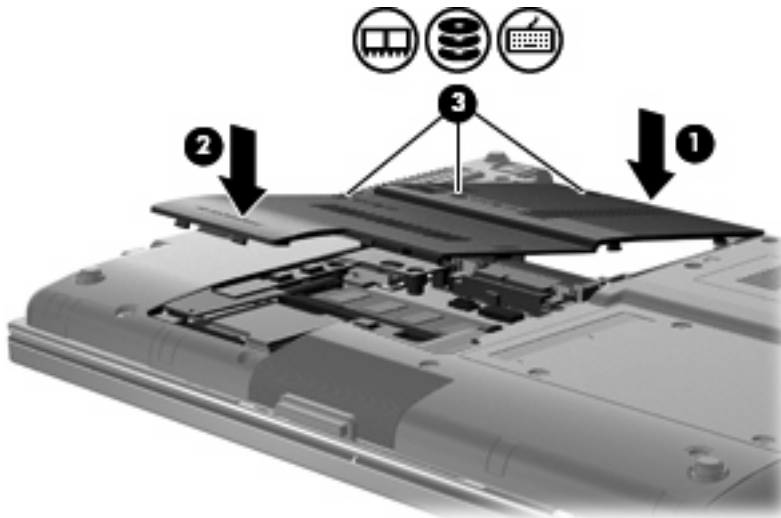

7. Replace the battery.
8. Turn the computer right-side up, and then reconnect external power and external devices.
9. Turn on the computer.



---

# 7 External devices

## Using a USB device

Universal Serial Bus (USB) is a hardware interface that can be used to connect an optional external device, such as a USB keyboard, mouse, drive, printer, scanner, or hub.

Some USB devices may require additional support software, which is usually included with the device. For more information about device-specific software, refer to the manufacturer's instructions. These instructions may be provided with the software, on disc, or on the manufacturer's Web site.

Depending on the model, the computer has up to 4 USB ports that support USB 1.0, USB 1.1, and USB 2.0 devices. The 2 USB ports on the rear of the computer are standard USB ports. On the left side of the computer, there is 1 standard USB port (select models only) and 1 powered USB port. A powered USB port provides power to an external device if used with a powered USB cable.

An optional docking device or a USB hub provides additional USB ports that can be used with the computer.

## Connecting a USB device

△ **CAUTION:** To prevent damage to a USB connector, use minimal force to connect a USB device.

▲ To connect a USB device to the computer, connect the USB cable for the device to the USB port.

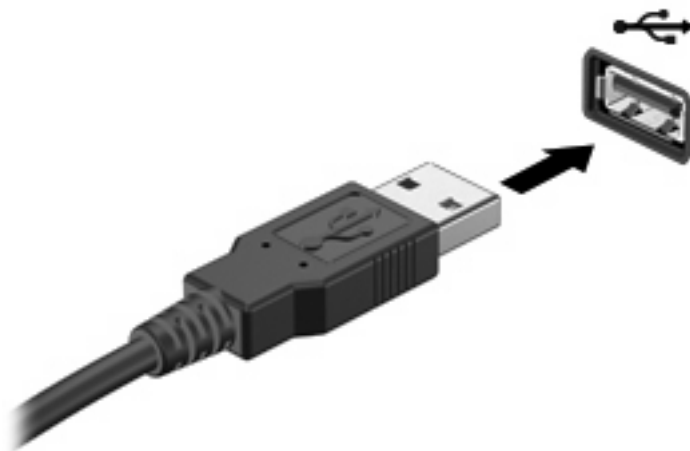

You will hear a sound when the device has been detected.

📄 **NOTE:** The first time you connect a USB device, a message is displayed in the notification area to let you know the device is recognized by the computer.

## Removing a USB device

△ **CAUTION:** To prevent loss of data or an unresponsive system, use the following procedure to safely remove a USB device.

**CAUTION:** To prevent damage to a USB connector, do not pull on the cable to remove the USB device.

To remove a USB device:

1. Double-click the **Safely Remove Hardware** icon in the notification area, at the far right of the taskbar.

 **NOTE:** To display the Safely Remove Hardware icon, click the **Show Hidden Icons** icon (< or <<) in the notification area.

2. Click the name of the device in the list.

 **NOTE:** If the USB device is not listed, you do not have to stop the device before you remove it.

3. Click **Stop**, and then click **OK**.

4. Remove the device.

## Using USB legacy support

USB legacy support (enabled by default) permits the following actions:

- Using a USB keyboard, mouse, or hub connected to a USB port on the computer during startup or in an MS-DOS-based program or utility
- Starting or restarting from an optional external MultiBay or an optional USB bootable device

USB legacy support is enabled at the factory. To disable or enable USB legacy support:

1. Open Computer Setup by turning on or restarting the computer, and then pressing **esc** while the “Press the ESC key for Startup Menu” message is displayed at the bottom of the screen.
2. Press **f10** to enter Computer Setup.
3. Use a pointing device or the arrow keys to select **System Configuration > Device Configurations**. Confirm that the box next to **USB legacy support** is checked.

 **NOTE:** If it is not checked, press **enter**.

4. To save your preferences and exit Computer Setup, select **File > Save Changes and Exit**. Then follow the instructions on the screen.

Your preferences go into effect when the computer restarts.

## Using 1394 devices

IEEE 1394 is a hardware interface that connects a high-speed multimedia or data storage device to the computer. Scanners, digital cameras, and digital camcorders often require a 1394 connection.

Some 1394 devices may require additional support software, which is usually included with the device. For more information about device-specific software, refer to the manufacturer's instructions.

The 1394 port also supports IEEE 1394a devices.

## Connecting a 1394 device

△ **CAUTION:** To prevent damage to a 1394 port connector, use minimal force to connect a 1394 device.

▲ To connect a 1394 device to the computer, connect the 1394 cable for the device to the 1394 port.

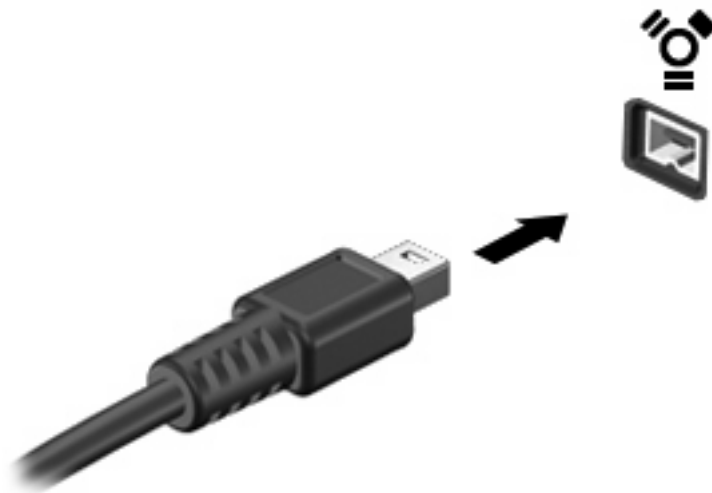

You will hear a sound when the device has been detected.

## Removing a 1394 device

△ **CAUTION:** To prevent loss of data or an unresponsive system, use the following procedure to safely remove a 1394 device.

**CAUTION:** To prevent damage to a 1394 connector, do not pull on the cable to remove the 1394 device.

To remove a 1394 device:

1. Double-click the **Safely Remove Hardware** icon in the notification area, at the far right of the taskbar.

📄 **NOTE:** To display the Safely Remove Hardware icon, click the **Show Hidden Icons** icon (< or <<) in the notification area.

2. Click the name of the device in the list.

📄 **NOTE:** If the device is not listed, you do not have to stop the device before you remove it.

3. Click **Stop**, and then click **OK**.
4. Remove the device.

## Using the docking connector

The docking connector connects the computer to an optional docking device, so that additional ports and connectors can be used with the computer.



## Using external drives

Removable external drives expand your options for storing and accessing information. A USB drive can be added by connecting the drive to a USB port on the computer.

 **NOTE:** HP external USB optical drives should be connected to the powered USB port on the left side of the computer.

---

USB drives include the following types:

- 1.44-megabyte diskette drive
- Hard drive module (a hard drive with an adapter attached)
- External optical drive
- MultiBay device

## Using optional external devices

 **NOTE:** For more information about required software and drivers, or to learn which computer port to use, refer to the manufacturer's instructions.

---

To connect an external device to the computer:

 **CAUTION:** To reduce the risk of damage to the equipment when connecting a powered device, be sure that the device is turned off and the AC power cord is unplugged.

---

1. Connect the device to the computer.
2. If you are connecting a powered device, plug the device power cord into a grounded AC outlet.
3. Turn on the device.

To disconnect an unpowered external device, turn off the device, and then disconnect it from the computer. To disconnect a powered external device, turn off the device, disconnect it from the computer, and then unplug the AC power cord.

## Using an optional external optical drive

An external optical drive connects to a USB port on the computer and enables you to use optical discs (CDs and DVDs). The computer provides one powered USB port on the left side of the computer. This port provides power to an external optical drive when used with a powered USB cable. An external optical drive connected to the other USB port on the computer must be connected to AC power.

 **NOTE:** An external optical drive must be connected to a USB port on the computer, not to a USB port on another external device, such as a hub or docking station.

If Standby or Hibernation is initiated during playback of a disc, you may experience the following behaviors:

- Your playback may be interrupted.
- You may see a warning message asking if you want to continue. If this message is displayed, click **No**.
- You may need to restart the CD or DVD to resume audio and video playback.

### Inserting an optical disc (CD or DVD)

1. Turn on the computer.
2. Press the release button (1) on the drive bezel to release the disc tray.
3. Pull out the tray (2).
4. Hold the disc by the edges to avoid touching the flat surfaces and position the disc label-side up over the tray spindle.

 **NOTE:** If the tray is not fully accessible, tilt the disc carefully to position it over the spindle.

5. Gently press the disc (3) down onto the tray spindle until the disc snaps into place.

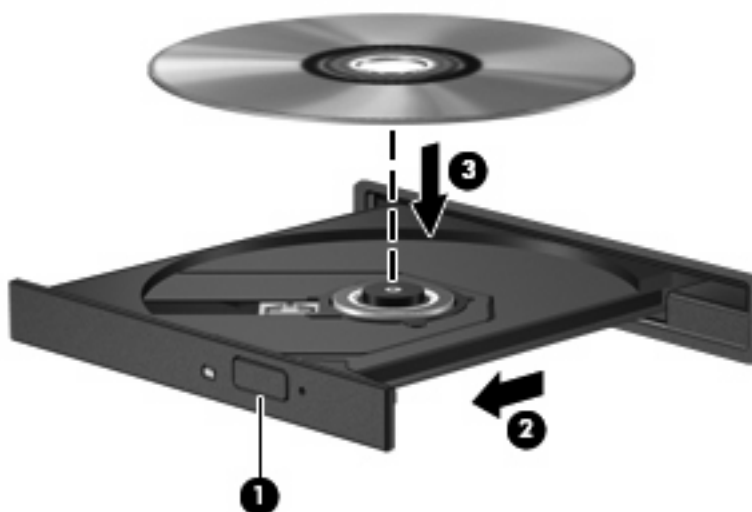

6. Close the disc tray.

## Removing an optical disc (CD or DVD)

There are 2 ways to remove a disc, depending on whether the disc tray opens normally or not.

### When the disc tray opens

1. Press the release button **(1)** on the drive bezel to release the disc tray, and then gently pull out the tray **(2)** until it stops.
2. Remove the disc **(3)** from the tray by gently pressing down on the spindle while lifting the outer edges of the disc. Hold the disc by the edges and avoid touching the flat surfaces.

 **NOTE:** If the tray is not fully accessible, tilt the disc carefully as you remove it.

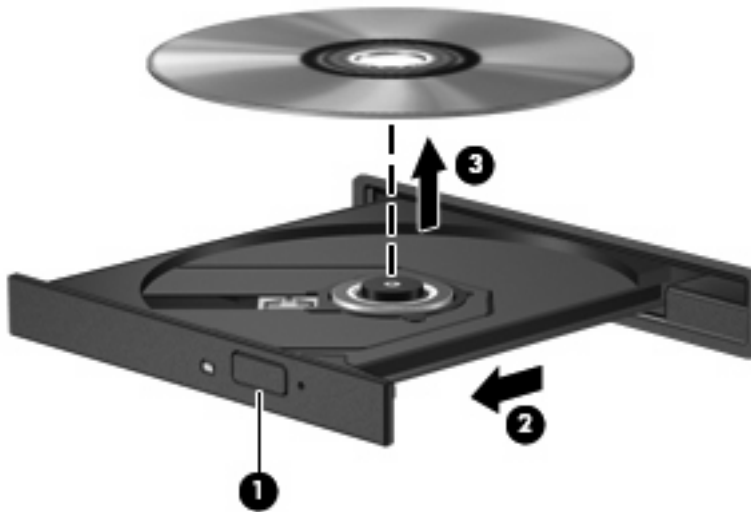

3. Close the disc tray and place the disc in a protective case.

### When the disc tray does not open

1. Insert the end of a paper clip **(1)** into the release access in the front bezel of the drive.
2. Press in gently on the paper clip until the tray is released, and then pull out the tray **(2)** until it stops.

3. Remove the disc **(3)** from the tray by gently pressing down on the spindle while lifting the outer edges of the disc. Hold the disc by the edges and avoid touching the flat surfaces.

 **NOTE:** If the tray is not fully accessible, tilt the disc carefully as you remove it.

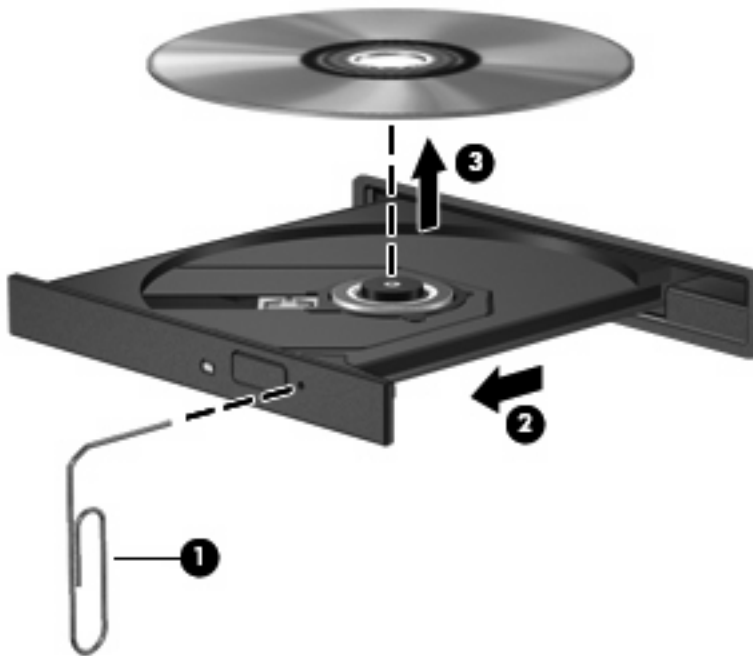

4. Close the disc tray and place the disc in a protective case.



---

## 8 External media cards

### Using SD Card Reader cards

Optional digital cards provide secure data storage and convenient data sharing. These cards are often used with digital media–equipped cameras and PDAs as well as with other computers.

The SD Card Reader supports the following formats:

- MultiMediaCard (MMC)
- Secure Digital (SD) Memory Card

### Inserting a digital card

△ **CAUTION:** To avoid damaging the digital card or the computer, do not insert any type of adapter into the SD Card Reader.

**CAUTION:** To prevent damage to the digital card connectors, use minimal force to insert a digital card.

1. Hold the digital card label-side up, with the connectors facing the computer.
2. Insert the card into the SD Card Reader, and then push in on the card until it is firmly seated.

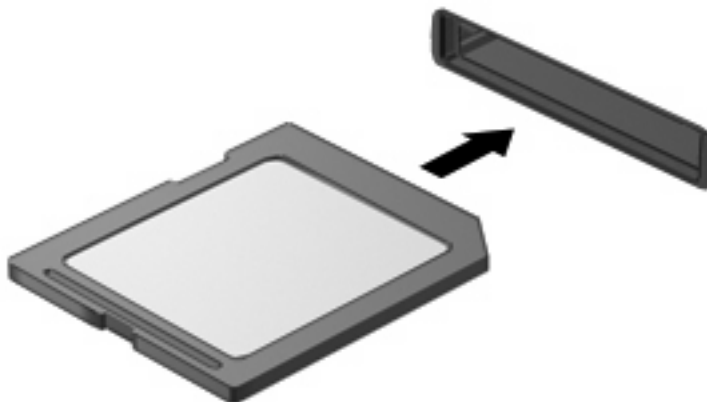

You will hear a sound when the device has been detected, and a menu of available options may be displayed.

### Removing a digital card

△ **CAUTION:** To prevent loss of data or an unresponsive system, use the following procedure to safely remove a digital card.

To remove a digital card:

1. Save your information and close all programs associated with the digital card.

---

 **NOTE:** To stop a data transfer, click **Cancel** in the operating system Copying window.

---

2. Stop the digital card:

- a. Double-click the **Safely Remove Hardware** icon in the notification area, at the far right of the taskbar.

---

 **NOTE:** To display the Safely Remove Hardware icon, click the **Show Hidden Icons** icon (< or <<) in the notification area.

---

- b. Click the name of the digital card in the list.
- c. Click **Stop**, and then click **OK**.

3. Pull the card out of the slot.

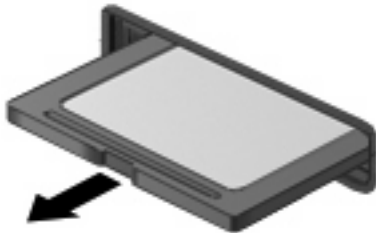

## Using ExpressCards

An ExpressCard is a high-performance PC Card that is inserted into the ExpressCard slot.

Like standard PC Cards, ExpressCards are designed to conform to the standard specifications of the Personal Computer Memory Card International Association (PCMCIA).

## Configuring an ExpressCard

Install only the software required for your device. If you are instructed by the ExpressCard manufacturer to install device drivers:

- Install only the device drivers for your operating system.
- Do not install other software, such as card services, socket services, or enablers, supplied by the ExpressCard manufacturer.

## Inserting an ExpressCard

---

△ **CAUTION:** To prevent damage to the computer and external media cards, do not insert a PC Card into an ExpressCard slot.

---

**CAUTION:** To prevent damage to the connectors:

Use minimal force when inserting an ExpressCard.

Do not move or transport the computer when an ExpressCard is in use.

The ExpressCard slot may contain a protective insert. To remove the insert:

1. Press in on the insert **(1)** to unlock it.
2. Pull the insert out of the slot **(2)**.

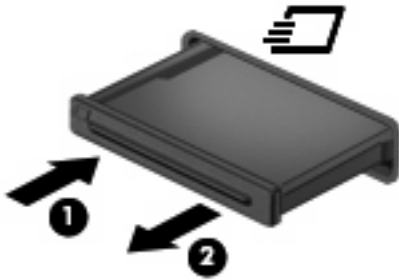

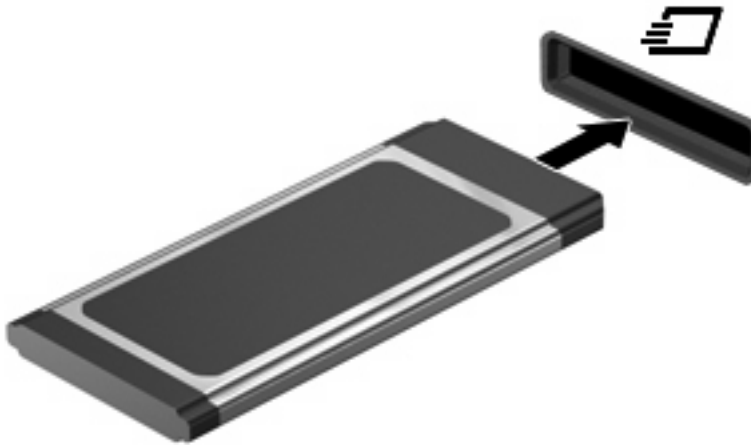

To insert an ExpressCard:

1. Hold the card label-side up, with the connectors facing the computer.
2. Insert the card into the ExpressCard slot, and then push in on the card until it is firmly seated.



You will hear a sound when the device has been detected, and a menu of options may be displayed.

 **NOTE:** The first time you insert an ExpressCard, a message is displayed in the notification area to let you know the device is recognized by the computer.

 **NOTE:** An inserted ExpressCard uses power even when idle. To conserve power, stop or remove an ExpressCard when it is not in use.

## Removing an ExpressCard

 **CAUTION:** To prevent loss of data or an unresponsive system, use the following procedure to safely remove the ExpressCard.

To remove an ExpressCard:

1. Save your information and close all programs associated with the ExpressCard.

---

 **NOTE:** To stop a data transfer, click **Cancel** in the operating system Copying window.

---

2. Stop the ExpressCard:

- a. Double-click the **Safely Remove Hardware** icon in the notification area, at the far right of the taskbar.

---

 **NOTE:** To display the Safely Remove Hardware icon, click the **Show Hidden Icons** icon (< or <<) in the notification area.

---

- b. Click the name of the ExpressCard in the list.
- c. Click **Stop**, and then click **OK**.

3. Release and remove the ExpressCard:

- a. Gently press in on the ExpressCard **(1)** to unlock it.
- b. Pull the ExpressCard out of the slot **(2)**.

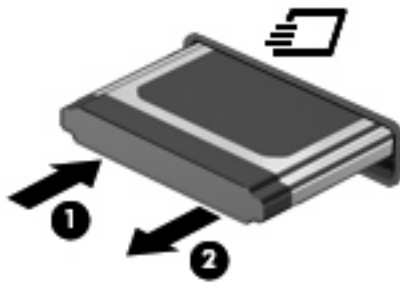

## Using smart cards

---

 **NOTE:** The term *smart card* is used throughout this chapter to refer to both smart cards and Java™ Cards.

---

A smart card is a credit card-sized accessory that carries a microchip containing memory and a microprocessor. Like personal computers, smart cards have an operating system to manage input and output, and they include security features to protect against tampering. Industry-standard smart cards are used with the smart card reader.

A personal identification number (PIN) is needed to gain access to the contents of the microchip. For more information about smart card security features, refer to Help and Support.

## Inserting a smart card

To insert a smart card:

1. Hold the card label-side up, and gently slide the card into the smart card reader until the card is seated.

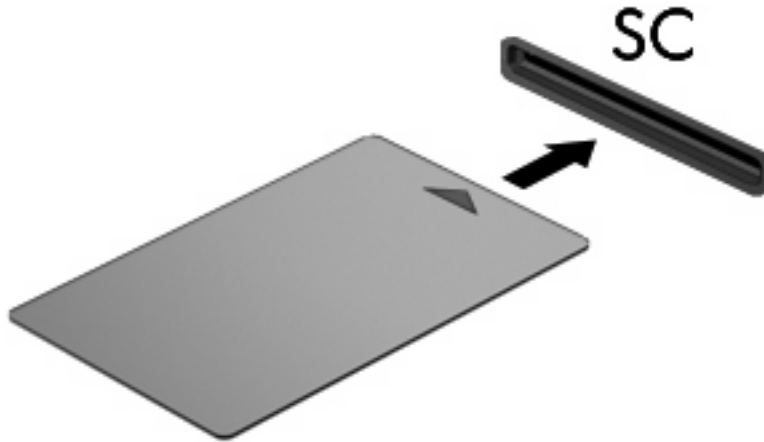

2. Follow the on-screen instructions for logging on to the computer using the smart card PIN.

## Removing a smart card

To remove a smart card:

- ▲ Grasp the edge of the smart card, and pull it out of the smart card reader.



---

## 9 Memory modules

The computer has two memory module compartments. The primary memory module compartment is located under the keyboard. The expansion memory module compartment is located on the bottom of the computer.

The memory capacity of the computer can be upgraded by adding a memory module to the vacant expansion memory module slot or by upgrading the existing memory module in the primary memory module slot.

- △ **WARNING!** To reduce the risk of electric shock and damage to the equipment, unplug the power cord and remove all batteries before installing a memory module.
- △ **CAUTION:** Electrostatic discharge (ESD) can damage electronic components. Before beginning any procedure, be sure that you are discharged of static electricity by touching a grounded metal object.

## Adding or replacing a memory module in the expansion memory module slot

To add or replace a memory module in the expansion memory module slot, follow these steps:

1. Save your work.
2. Shut down the computer and close the display.  
If you are not sure whether the computer is off or in Hibernation, turn the computer on by pressing the power button. Then shut down the computer through the operating system.
3. Disconnect all external devices connected to the computer.
4. Unplug the power cord from the AC outlet.
5. Turn the computer upside down on a flat surface.
6. Remove the battery from the computer.
7. Loosen the 3 memory module compartment cover screws (1).
8. Using your finger or a screwdriver, lift the edge of the memory module compartment cover (2) to release it, and then lift it away from the computer (3).

 **NOTE:** If the expansion memory module slot is not populated, bypass step 9 and proceed to step 10.

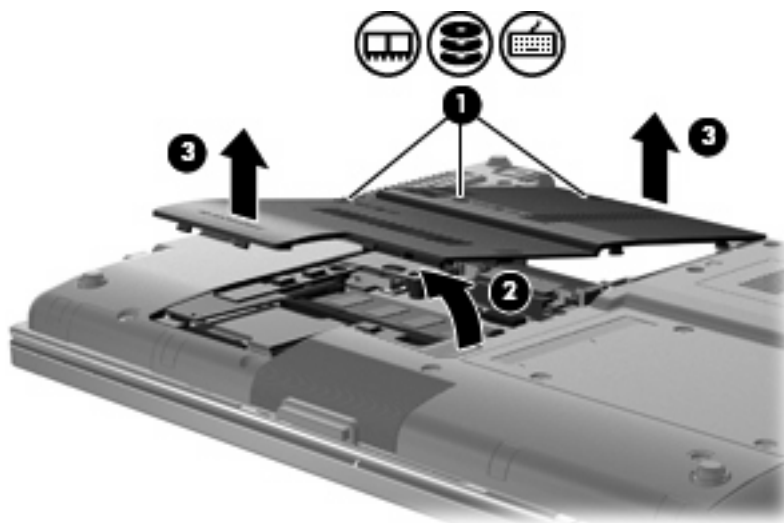

9. Remove the memory module:
  - a. Pull away the retention clips (1) on each side of the memory module.

The memory module tilts up.

 **CAUTION:** To prevent damage to the memory module, hold the memory module by the edges only. Do not touch the components on the memory module.





11. Align the tabs (1) on the memory module compartment cover with the notches on the computer.
12. Lower the cover (2), and then press down on the cover to snap it into place.
13. Tighten the 3 memory module compartment cover screws (3).

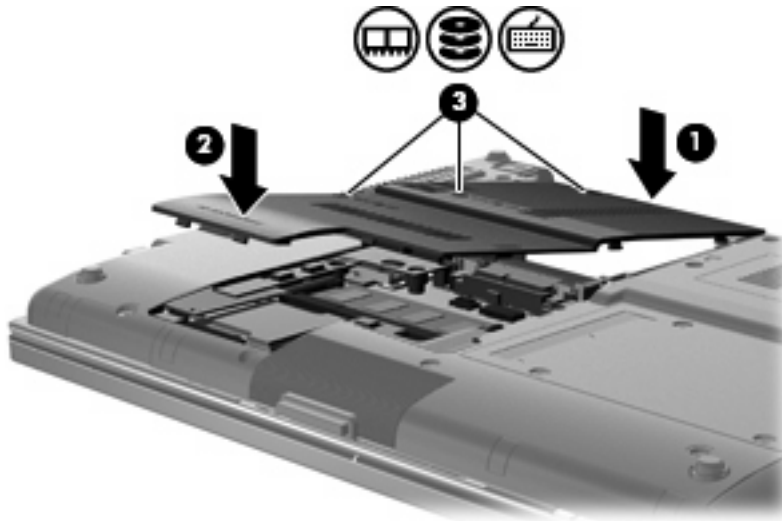

14. Replace the battery.
15. Turn the computer right-side up, and then reconnect external power and external devices.
16. Turn on the computer.

## Upgrading a memory module in the primary memory module slot

To upgrade a memory module in the primary memory module slot, follow these steps:

1. Save your work.
2. Shut down the computer and close the display.  
If you are not sure whether the computer is off or in Hibernation, turn the computer on by pressing the power button. Then shut down the computer through the operating system.
3. Disconnect all external devices connected to the computer.
4. Unplug the power cord from the AC outlet.
5. Turn the computer upside down on a flat surface.
6. Remove the battery from the computer.
7. Loosen the 3 hard drive cover screws (1).
8. Using your finger or a screwdriver, lift the edge of the hard drive cover (2) to release it, and then lift it away from the computer (3).

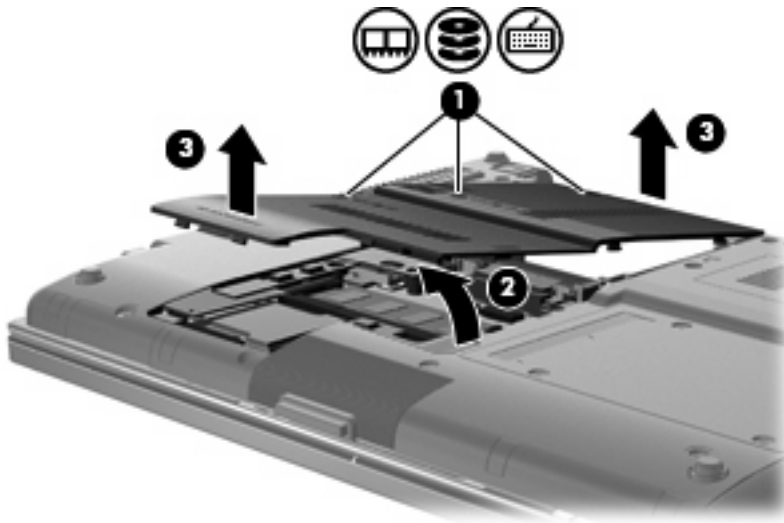

9. Remove the 3 switch cover screws (1).

10. Loosen the 4 keyboard access screws (2).

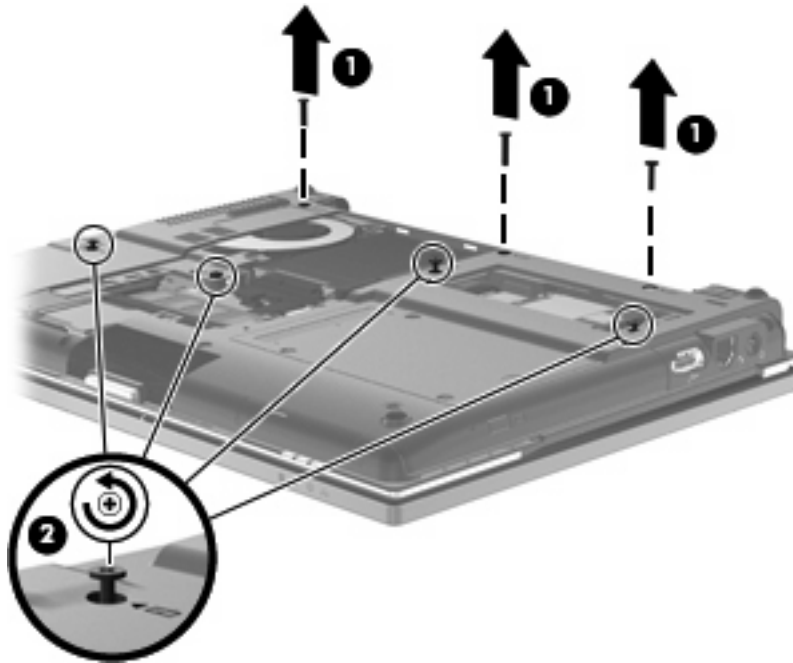

11. Turn the computer right-side up, and open it.
12. Carefully lift the switch cover away from the keyboard.



- Carefully lift the top edge of the keyboard (1), and pull the keyboard up (2).

 **NOTE:** If the left side of the keyboard releases before the right side, pull the keyboard slightly to the left to release the right side.



- Carefully lift the large cable connector (1), and then pull the cable away (2) to release it.
- Carefully lift the small cable connector (3), and then pull the cable away (4) to release it.

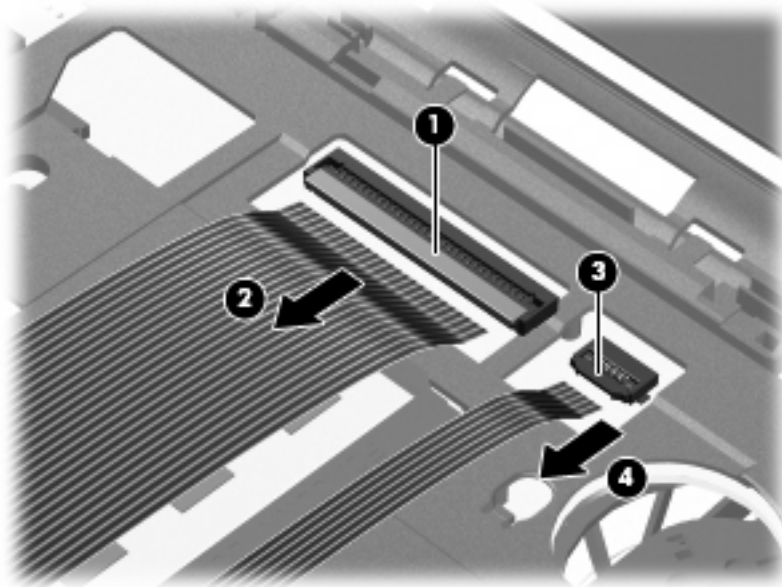

- Tilt the keyboard over until it rests on the palm rest of the computer.
- Remove the memory module compartment cover screw (1).

18. Remove the memory module compartment cover (2).

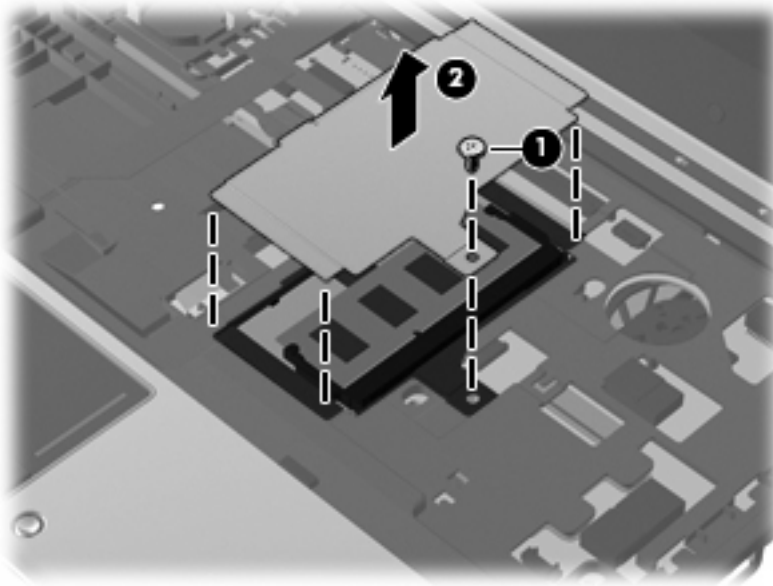

19. Remove the memory module:

- a. Pull away the retention clips (1) on each side of the memory module.

The memory module tilts up.

△ **CAUTION:** To prevent damage to the memory module, hold the memory module by the edges only. Do not touch the components on the memory module.

- b. Grasp the edge of the memory module (2), and gently pull the module out of the memory module slot.

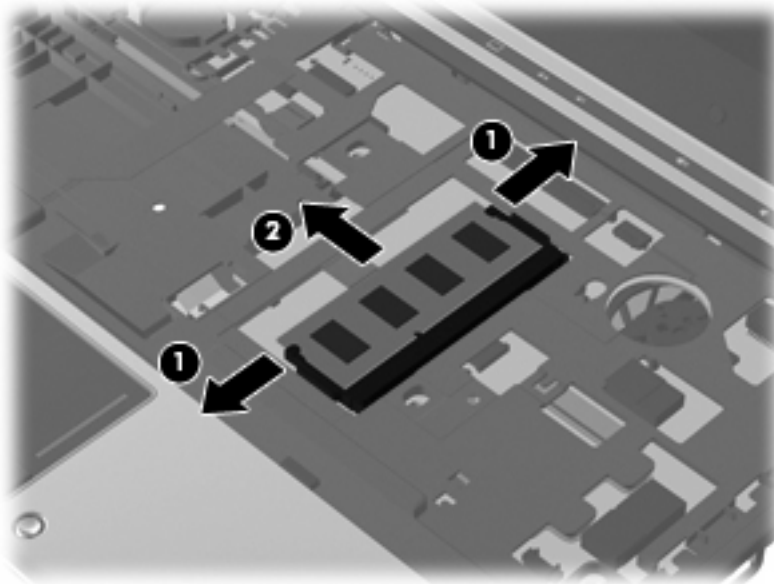

To protect a memory module after removal, place it in an electrostatic-safe container.

20. Insert a memory module:

△ **CAUTION:** To prevent damage to the memory module, hold the memory module by the edges only. Do not touch the components on the memory module, and do not bend the memory module.

- a. Align the notched edge (1) of the memory module with the tab in the memory module slot.
- b. With the memory module at a 45-degree angle from the surface of the memory module compartment, press the module (2) into the memory module slot until it is seated.
- c. Gently press the memory module (3) down, applying pressure to both the left and right edges of the memory module, until the retention clips snap into place.

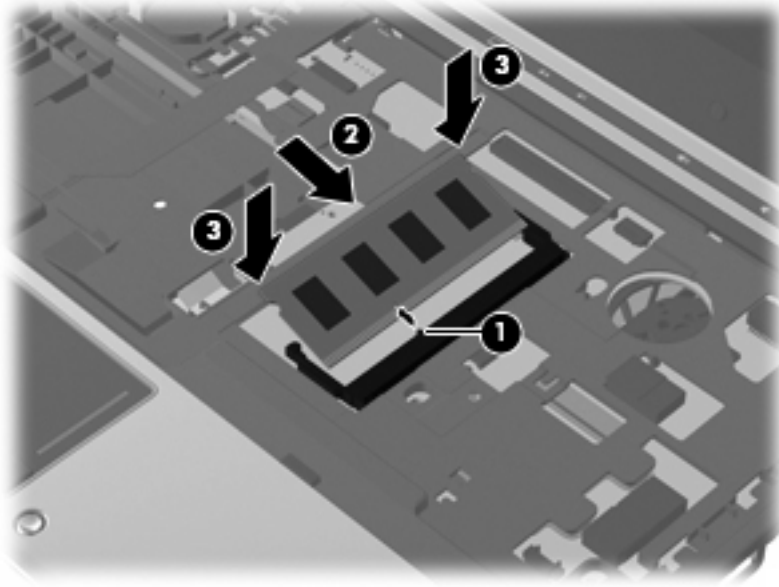

21. Replace the memory module compartment cover (1).
22. Replace the memory module compartment cover screw (2).

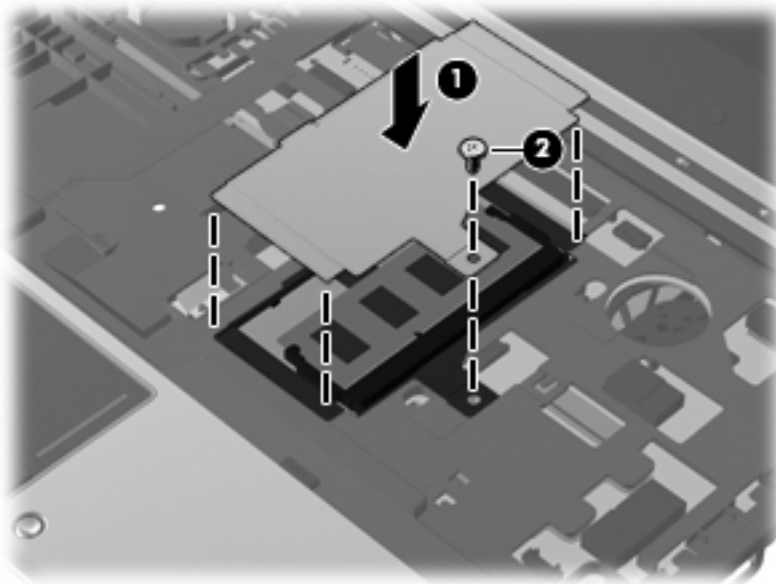

23. Reinsert the large cable (1) into the cable connector, and then push the cable connector down until it snaps into place (2).
24. Reinsert the small cable (3) into the cable connector, and then push the cable connector down until it snaps into place (4).

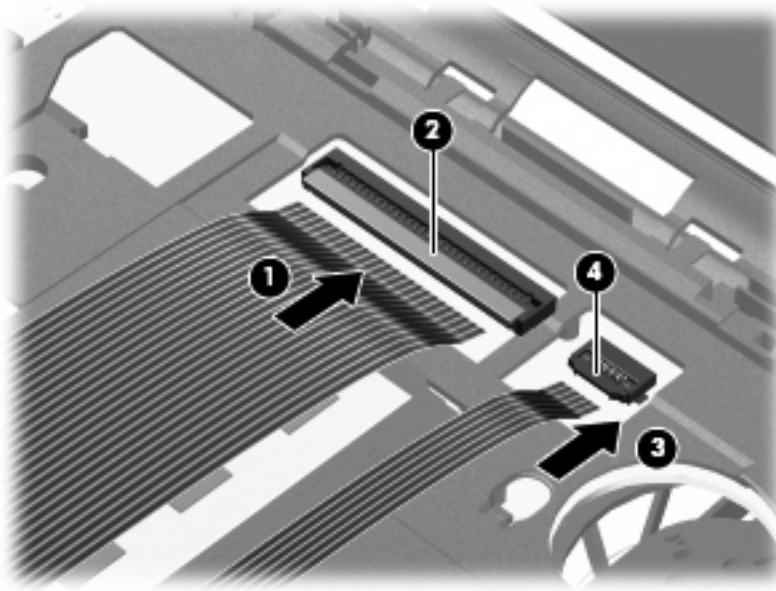

25. Align the notched edges of the keyboard with the tabs in the keyboard slot (1), and then tilt the keyboard back into the keyboard slot (2).



26. Align the switch cover, and then press down on the switch cover locations, making sure that the switch cover hooks snap into place.

 **NOTE:** If there are bumps or raised areas on the switch cover, remove the switch cover and repeat this step.



27. Close the display.
28. Turn the computer upside down on a flat surface.
29. Tighten the 4 keyboard access screws (1).
30. Replace the 3 switch cover screws (2).

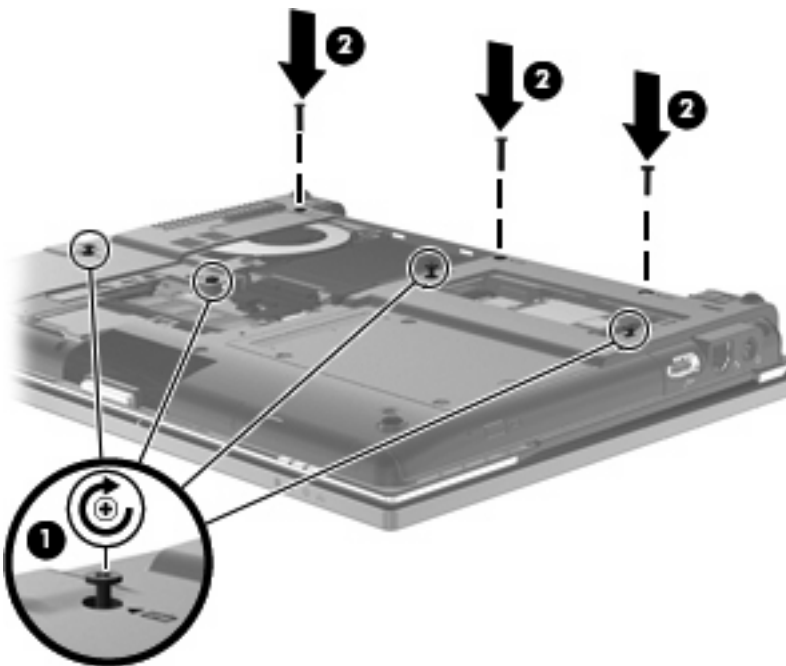

31. Align the tabs (1) on the hard drive cover with the notches on the computer.
32. Lower the cover (2), and then press down on the cover to snap it into place.



33. Tighten the 3 hard drive cover screws (3).

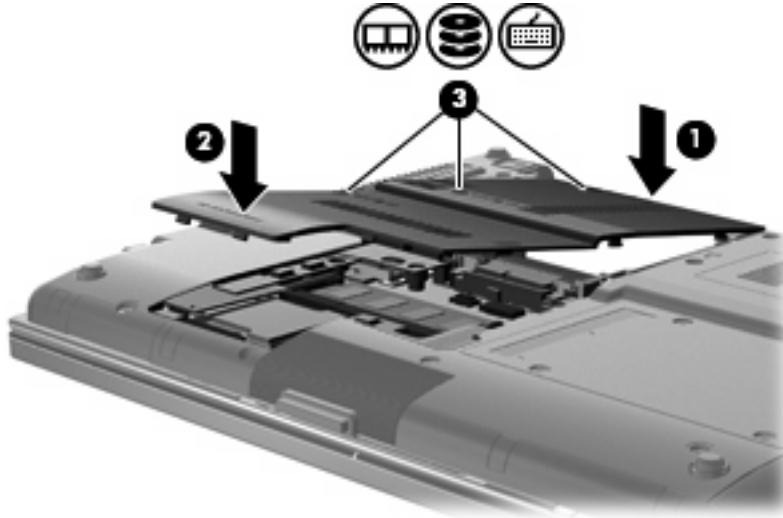

34. Replace the battery.
35. Turn the computer right-side up, and then reconnect external power and external devices.
36. Turn on the computer.

# 10 Security

## Protecting the computer

 **NOTE:** Security solutions are designed to act as deterrents. These deterrents may not prevent a product from being mishandled or stolen.

**NOTE:** In some countries or regions, the computer supports CompuTrace, which is an online security-based tracking and recovery service. If the computer is stolen, CompuTrace can track the computer if the unauthorized user accesses the Internet. You must purchase the software and subscribe to the service in order to use CompuTrace. For information about ordering the CompuTrace software, go to the HP Web site at <http://www.hpshopping.com>.

Security features provided with your computer can protect the computer, personal information, and data from a variety of risks. The way you use your computer will determine which security features you need to use.

The Windows® operating system offers certain security features. Additional security features are listed in the following table. Most of these additional security features can be configured in the Computer Setup utility (referred to hereafter as Computer Setup).

To protect against	Use this security feature
Unauthorized use of the computer	HP ProtectTools Security Manager, in combination with a password, smart card, and/or fingerprint reader
Unauthorized access to Computer Setup (f10)	BIOS administrator password in Computer Setup*
Unauthorized access to the contents of a hard drive	DriveLock password in Computer Setup*
Unauthorized startup from an optical drive, diskette drive, or internal network adapter	Boot options feature in Computer Setup*
Unauthorized access to a Windows user account	HP ProtectTools Security Manager
Unauthorized access to data	<ul style="list-style-type: none"><li>• Firewall software</li><li>• Windows updates</li><li>• Drive Encryption for HP ProtectTools</li></ul>
Unauthorized access to Computer Setup settings and other system identification information	BIOS administrator password in Computer Setup*
Unauthorized removal of the computer	Security cable slot (used with an optional security cable)

\*Computer Setup is a preinstalled, ROM-based utility that can be used even when the operating system is not working or will not load. You can use either a pointing device (TouchPad, pointing stick, or USB mouse) or the keyboard to navigate and make selections in Computer Setup.

## Using passwords

Most security features use passwords. Whenever you set a password, write down the password and store it in a secure location away from the computer. Note the following password considerations:

- Setup and DriveLock passwords are set in Computer Setup and are managed by the system BIOS.
- The embedded security password, which is an HP ProtectTools Security Manager password, can be enabled in Computer Setup to provide BIOS password protection in addition to their normal HP ProtectTools functions. The embedded security password is used with the optional embedded security chip.
- Windows passwords are set only in the Windows operating system.
- If you forget the BIOS administrator password set in Computer Setup, you can use HP SpareKey to access the utility.
- If you forget both the DriveLock user password and the DriveLock master password set in Computer Setup, the hard drive that is protected by the passwords is permanently locked and can no longer be used.

You can use the same password for a Computer Setup feature and for a Windows security feature. You can also use the same password for more than one Computer Setup feature.

Use the following tips for creating and saving passwords:

- When creating passwords, follow requirements set by the program.
- Write down your passwords and store them in a secure place away from the computer.
- Do not store passwords in a file on the computer.

The following tables list commonly used Windows and BIOS administrator passwords and describe their functions.

### Setting passwords in Windows

Windows passwords	Function
Administrator password*	Protects access to a Windows administrator-level account.
User password*	Protects access to a Windows user account.

\*For information about setting a Windows administrator password or a Windows user password, select **Start > Help and Support**.

### Setting passwords in Computer Setup

BIOS administrator passwords	Function
BIOS administrator password	Protects access to Computer Setup.
DriveLock master password	Protects access to the internal hard drive that is protected by DriveLock. It is also used to remove DriveLock protection. This password is set under DriveLock Passwords during the enable process.

BIOS administrator passwords	Function
DriveLock user password	Protects access to the internal hard drive that is protected by DriveLock, and is set under DriveLock Passwords during the enable process.
TPM embedded security password	When enabled as a BIOS administrator password, protects access to the computer contents when the computer turns on, restarts, or exits Hibernation.  This password requires the optional embedded security chip to support this security feature.

## BIOS administrator password

The Computer Setup BIOS administrator password protects the configuration settings and system identification information in Computer Setup. After this password is set, it must be entered to access Computer Setup and to make changes using Computer Setup.

Note the following characteristics of the BIOS administrator password:

- It is not interchangeable with a Windows administrator password, although both passwords can be identical.
- It is not displayed as it is set, entered, changed, or deleted.
- It must be set and entered with the same keys. For example, a BIOS administrator password set with keyboard number keys will not be recognized if you enter it thereafter with embedded numeric keypad number keys.
- It can include any combination of up to 32 letters and numbers and is not case sensitive unless mandated by the administrator.

## Managing a BIOS administrator password

A BIOS administrator password is set, changed, and deleted in Computer Setup.

To set this password in Computer Setup, follow these steps:

1. Turn on or restart the computer, and then press **esc** while the “Press the ESC key for Startup Menu” message is displayed at the bottom of the screen.
2. Press **f10** to enter Computer Setup.
3. Use a pointing device or the arrow keys to select **Security > Setup BIOS Administrator Password**, and then press **enter**.
4. When prompted, type a password.
5. When prompted, type the new password again to confirm.
6. To save your changes and exit Computer Setup, click **Save**, and then follow the on-screen instructions.

– or –

Use the arrow keys to select **File > Save Changes and Exit**, and then press **enter**.

Your changes go into effect when the computer restarts.

To change this password in Computer Setup, follow these steps:

1. Turn on or restart the computer, and then press **esc** while the “Press the ESC key for Startup Menu” message is displayed at the bottom of the screen.
2. Press **f10** to enter Computer Setup.
3. Use a pointing device or the arrow keys to select **Security > Change Password**, and then press **enter**.
4. When prompted, type your current password.
5. When prompted, type your new password again to confirm.
6. To save your changes and exit Computer Setup, click **Save**, and then follow the on-screen instructions.

– or –

Use the arrow keys to select **File > Save Changes and Exit**, and then press **enter**.

Your changes go into effect when the computer restarts.

To delete this password in Computer Setup, follow these steps:

1. Turn on or restart the computer, and then press **esc** while the “Press the ESC key for Startup Menu” message is displayed at the bottom of the screen.
2. Press **f10** to enter Computer Setup.
3. Use a pointing device or the arrow keys to select **Security > Change Password**, and then press **enter**.
4. When prompted, type your current password.

5. When prompted for the new password, leave the field empty, and then press [enter](#).
6. Read the warning. To continue, select **YES**.
7. When prompted to type your new password again, leave the field empty, and then press [enter](#).
8. To save your changes and exit Computer Setup, click **Save**, and then follow the on-screen instructions.

– or –

Use the arrow keys to select **File > Save Changes and Exit**, and then press [enter](#).

Your changes go into effect when the computer restarts.

## Entering a BIOS administrator password

At the **BIOS administrator password** prompt, type your password (using the same kind of keys you used to set the password), and then press **enter**. After 3 unsuccessful attempts to enter the BIOS administrator password, you must restart the computer and try again.

## Using Computer Setup DriveLock

- 
- △ **CAUTION:** To prevent the DriveLock-protected hard drive from becoming permanently unusable, record the DriveLock user password and the DriveLock master password in a safe place away from your computer. If you forget both DriveLock passwords, the hard drive will be permanently locked and can no longer be used.
- 

DriveLock protection prevents unauthorized access to the contents of a hard drive. DriveLock can be applied only to the internal hard drive(s) of the computer. After DriveLock protection is applied to a drive, a password must be entered to access the drive. The drive must be inserted into the computer or an advanced port replicator in order for it to be accessed by the DriveLock passwords.

To apply DriveLock protection to an internal hard drive, a user password and a master password must be set in Computer Setup. Note the following considerations about using DriveLock protection:

- After DriveLock protection is applied to a hard drive, the hard drive can be accessed only by entering either the user password or the master password.
- The owner of the user password should be the day-to-day user of the protected hard drive. The owner of the master password may be either a system administrator or the day-to-day user.
- The user password and the master password can be identical.
- You can delete a user password or master password only by removing DriveLock protection from the drive. DriveLock protection can be removed from the drive only with the master password.

## Setting a DriveLock password

To set a DriveLock password in Computer Setup, follow these steps:

1. Turn on the computer, and then press **esc** while the “Press the ESC key for Startup Menu” message is displayed at the bottom of the screen.
2. Press **f10** to enter Computer Setup.
3. Use a pointing device or the arrow keys to select **Security > DriveLock Password**, and then press **enter**.
4. Use a pointing device to click the hard drive you want to protect.

– or –

Use the arrow keys to select the hard drive you want to protect, and then press **enter**.

5. Read the warning. To continue, select **YES**.
6. When prompted, type a master password, and then press **enter**.
7. When prompted, type the master password again to confirm, and then press **enter**.
8. When prompted, type a user password, and then press **enter**.
9. When prompted, type the user password again to confirm, and then press **enter**.
10. To confirm DriveLock protection on the drive you have selected, type `DriveLock` in the confirmation field, and then press **enter**.

---

 **NOTE:** The DriveLock confirmation is case sensitive.

---

11. To save your changes and exit Computer Setup, click **Save**, and then follow the on-screen instructions.

– or –

Use the arrow keys to select **File > Save Changes and Exit**, and then press **enter**.

Your changes go into effect when the computer restarts.



## Entering a DriveLock password

Be sure that the hard drive is inserted into the computer (not into an optional docking device or external MultiBay).

At the **DriveLock Password** prompt, type your user or master password (using the same kind of keys you used to set the password), and then press [enter](#).

After 2 incorrect attempts to enter the password, you must shut down the computer and try again.

## Changing a DriveLock password

To change a DriveLock password in Computer Setup, follow these steps:

1. Turn on the computer, and then press **esc** while the “Press the ESC key for Startup Menu” message is displayed at the bottom of the screen.
2. Press **f10** to enter Computer Setup.
3. Use a pointing device or the arrow keys to select **Security > DriveLock Password**, and then press **enter**.
4. Use a pointing device to select an internal hard drive.

– or –

Use the arrow keys to select an internal hard drive, and then press **enter**.

5. Use a pointing device or the arrow keys to select the password you want to change.
6. When prompted, type your current password, and then press **enter**.
7. When prompted, type a new password, and then press **enter**.
8. When prompted, type the new password again to confirm, and then press **enter**.
9. To save your changes and exit Computer Setup, click **Save**, and then follow the on-screen instructions.

– or –

Use the arrow keys to select **File > Save Changes and Exit**, and then press **enter**.

Your changes go into effect when the computer restarts.

## Removing DriveLock protection

To remove DriveLock protection in Computer Setup, follow these steps:

1. Turn on the computer, and then press **esc** while the “Press the ESC key for Startup Menu” message is displayed at the bottom of the screen.
2. Press **f10** to enter Computer Setup.
3. Use a pointing device or the arrow keys to select **Security > DriveLock Password**, and then press **enter**.
4. Use a pointing device or the arrow keys to select an internal hard drive, and then press **enter**.
5. Use a pointing device or the arrow keys to select **Disable protection**.
6. Type your master password, and then press **enter**.
7. To save your changes and exit Computer Setup, click **Save**, and then follow the on-screen instructions.

– or –

Use the arrow keys to select **File > Save Changes and Exit**, and then press **enter**.

Your changes go into effect when the computer restarts.

## Using Computer Setup Auto DriveLock

In a multiple-user environment, you can set an Automatic DriveLock password. When the Automatic DriveLock password is enabled, a random user password and a DriveLock master password will be created for you. When any user passes the password credential, the same random user and DriveLock master password will be used to unlock the drive.

---

 **NOTE:** You must have a BIOS administrator password before you can access the Automatic DriveLock features.

---

## Entering an Automatic DriveLock password

To enable an Automatic DriveLock password in Computer Setup, follow these steps:

1. Turn on or restart the computer, and then press **esc** while the “Press the ESC key for Startup Menu” message is displayed at the bottom of the screen.
2. Press **f10** to enter Computer Setup.
3. Use a pointing device or the arrow keys to select **Security > Automatic DriveLock**, and then press **enter**.
4. Use a pointing device or the arrow keys to select an internal hard drive, and then press **enter**.
5. Read the warning. To continue, select **YES**.
6. To save your changes and exit Computer Setup, click **Save**, and then follow the on-screen instructions.

– or –

Use the arrow keys to select **File > Save Changes and Exit**, and then press **enter**.

## Removing Automatic DriveLock protection

To remove DriveLock protection in Computer Setup, follow these steps:

1. Turn on or restart the computer, and then press **esc** while the “Press the ESC key for Startup Menu” message is displayed at the bottom of the screen.
2. Press **f10** to enter Computer Setup.
3. Use a pointing device or the arrow keys to select **Security > Automatic DriveLock**, and then press **enter**.
4. Use a pointing device or the arrow keys to select an internal hard drive, and then press **enter**.
5. Use a pointing device or the arrow keys to select **Disable protection**.
6. To save your changes and exit Computer Setup, click **Save**, and then follow the on-screen instructions.

– or –

Use the arrow keys to select **File > Save Changes and Exit**, and then press **enter**.

# Using Computer Setup security features

## Securing system devices

You can disable or enable system devices from the following menus in Computer Setup:

- Boot Options
- Device Configurations
- Built-In Device Options
- Port Options

To disable or reenable system devices in Computer Setup, follow these steps:

1. Turn on or restart the computer, and then press **esc** while the “Press the ESC key for Startup Menu” message is displayed at the bottom of the screen.
2. Press **f10** to enter Computer Setup.
3. Use a pointing device or the arrow keys to select **System Configuration > Boot Options**, or **System Configuration > Device Configurations**, or **System Configuration > Built-In Device Options**, or **System Configuration > Port Options**.
4. Press **enter**.
5. To disable an option, use a pointing device to uncheck the box next to the option.  
– or –  
Using the arrow keys, highlight the option, and then press **enter**.
6. To reenable an option, use a pointing device to check the box next to the option.  
– or –  
Using the arrow keys, highlight the option, and then press **enter**.
7. To save your changes and exit Computer Setup, click **Save**, and then follow the on-screen instructions.  
– or –  
Use the arrow keys to select **File > Save Changes and Exit**, and then press **enter**.

Your changes go into effect when the computer restarts.

## Viewing Computer Setup System Information

The System Information feature in Computer Setup provides 2 types of system information:

- Identification information about the computer model and the batteries
- Specification information about the processor, memory, ROM, video revision, keyboard controller revision, and wireless identification numbers

To view this general system information in Computer Setup, follow these steps:

1. Turn on or restart the computer, and then press **esc** while the “Press the ESC key for Startup Menu” message is displayed at the bottom of the screen.
2. Press **f10** to enter Computer Setup.
3. Use a pointing device or the arrow keys to select **File > System Information**, and then press **enter**.

---

 **NOTE:** To prevent unauthorized access to this information, you must create a BIOS administrator password in Computer Setup.

---

## Using Computer Setup System IDs

The System IDs feature in Computer Setup allows you to display or enter the computer asset tag and ownership tag.

---

 **NOTE:** To prevent unauthorized access to this information, you must create a BIOS administrator password in Computer Setup.

---

To manage this feature in Computer Setup, follow these steps:

1. Turn on or restart the computer, and then press **esc** while the “Press the ESC key for Startup Menu” message is displayed at the bottom of the screen.
2. Press **f10** to enter Computer Setup.
3. Use a pointing device or the arrow keys to select **Security > System IDs**, and then press **enter**.
4. Use a pointing device or the arrow keys to select **Notebook Asset Tag** or **Notebook Ownership Tag**, and then enter the information.
5. Press **enter** when finished.
6. To save your changes and exit Computer Setup, click **Save**, and then follow the on-screen instructions.

– or –

Use the arrow keys to select **File > Save Changes and Exit**, and then press **enter**.

Your changes go into effect when the computer restarts.

## Using antivirus software

When you use the computer to access e-mail, a network, or the Internet, you expose the computer to computer viruses. Computer viruses can disable the operating system, programs, or utilities, or cause them to function abnormally.

Antivirus software can detect most viruses, destroy them, and in most cases, repair any damage they have caused. To provide ongoing protection against newly discovered viruses, antivirus software must be kept up to date.

McAfee Total Protection antivirus software is either preinstalled or preloaded on the computer.

If the antivirus software is preinstalled, select **Start > All Programs > McAfee > Managed Services > Total Protection**.

If the software is preloaded, select **Start > All Programs > HP Software Setup**, and then follow the instructions on the screen to load the **McAfee Total Protection** software.

For more information about computer viruses, type `viruses` in the Search box in Help and Support.

## Using firewall software

When you use the computer to access e-mail, a network, or the Internet, unauthorized persons may be able to gain access to the computer, your personal files, and information about you. Use the firewall software preinstalled on the computer to protect your privacy. McAfee Total Protection antivirus software is preinstalled on the computer. To access your software, select **Start > All Programs > McAfee > Managing Services > Total Protection**.

Firewall features include logging and reporting of network activity, and automatic monitoring of all incoming and outgoing traffic. For more information, refer to the software manufacturer's instructions. These instructions may be provided with the software, on disc, or on the manufacturer's Web site.

---

 **NOTE:** Under some circumstances a firewall can block access to Internet games, interfere with printer or file sharing on a network, or block authorized e-mail attachments. To temporarily resolve the problem, disable the firewall, perform the task that you want to perform, and then reenable the firewall. To permanently resolve the problem, reconfigure the firewall as necessary, and adjust the policies and settings of other intrusion detection systems. For additional information, contact your network administrator or IT department.

---



## Installing critical security updates

---

△ **CAUTION:** Microsoft sends alerts regarding critical updates. To protect the computer from security breaches and computer viruses, install all critical updates from Microsoft as soon as you receive an alert.

---

Updates to the operating system and other software may have become available *after* the computer was shipped. To be sure that all available updates are installed on the computer, observe these guidelines:

- Run Windows Update monthly to install the latest software from Microsoft.
- Obtain updates, as they are released, from the Microsoft Web site and through the updates link in Help and Support.

## Using HP ProtectTools Security Manager (select models only)

HP ProtectTools Security Manager software is preinstalled on select computer models. This software can be accessed through Windows Control Panel. It provides security features that help protect against unauthorized access to the computer, networks, and critical data. For more information, refer to the HP ProtectTools software Help.

## Installing a security cable

 **NOTE:** A security cable is designed to act as a deterrent, but it may not prevent the computer from being mishandled or stolen.

---

1. Loop the security cable around a secured object.
2. Insert the key (1) into the cable lock (2).
3. Insert the cable lock into the security cable slot on the computer (3), and then lock the cable lock with the key.

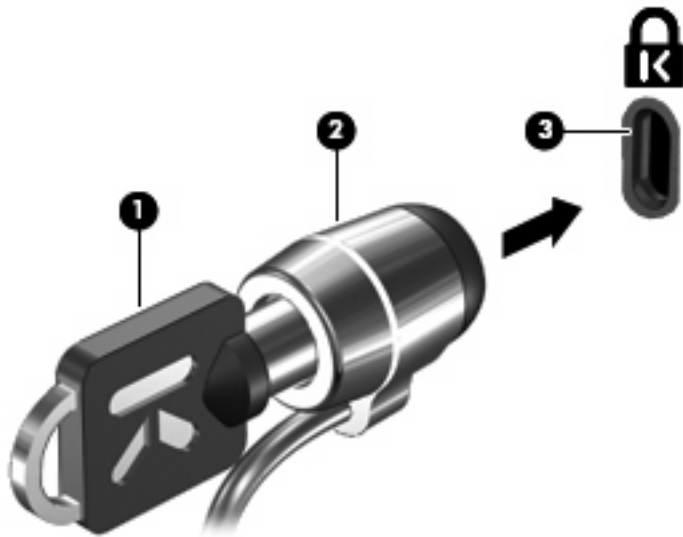

 **NOTE:** Your computer may look different from the illustration. The location of the security cable slot varies by computer model.

---

---

# 11 Software updates

## Updating software

Updated versions of the software provided with your computer are available either through the HP Update utility or on the HP Web site.

The HP Update utility automatically checks for updates from HP. The utility runs at a specified interval and provides a list of support alerts, such as security enhancements, and optional software and driver updates.

You can manually check for updates at any time by selecting **Start > Help and Support > Update Software & Drivers** and follow the on-screen instructions.

Most software on the HP Web site is packaged in compressed files called *SoftPaqs*. Some BIOS updates may be packaged in compressed files called *ROMPaqs*.

Some download packages contain a file named *Readme.txt*, which contains information regarding installing and troubleshooting the file. (*Readme.txt* files included with *ROMPaqs* are provided in English only.)

To update the software using the HP Web site, follow these steps:

1. Identify your computer model, product category, and series or family. Prepare for a system BIOS update by identifying the BIOS version currently installed on the computer. For details, refer to the "Determining the BIOS version" section.

If your computer is connected to a network, consult the network administrator before installing any software updates, especially system BIOS updates.



**NOTE:** The computer system BIOS is stored on the system ROM. The BIOS initializes the operating system, determines how the computer will interact with the hardware devices, and provides for data transfer among hardware devices, including the time and date.

2. Open your Web browser, and go to <http://www.hp.com/support>.
3. Select your country or region.
4. Click the option for software and driver downloads, and then type your computer model number in the product box.
5. Press **enter**.
6. Follow the on-screen instructions.

## Updating the BIOS

To update the BIOS, first determine what BIOS version you currently have, and then download and install the new BIOS.

### Determining the BIOS version

BIOS version information (also known as *ROM date* and *System BIOS*) can be displayed by pressing **fn+esc** (if you are already in Windows®) or by using Computer Setup.

To use Computer Setup for displaying BIOS information, follow these steps:

1. Turn on or restart the computer, and then press **esc** while the “Press the ESC key for Startup Menu” message is displayed at the bottom of the screen.
2. Press **f10** to enter Computer setup.
3. Use a pointing device or the arrow keys to select **File > System Information**.
4. Press **esc** to return to the **File** menu.
5. Click **Exit**, and follow the on-screen instructions.

– or –

Use the arrow keys to select **File > Ignore changes and exit**, and then press **enter**.

## Downloading a BIOS update

△ **CAUTION:** To prevent damage to the computer or an unsuccessful installation, download and install a BIOS update only when the computer is connected to reliable external power using the AC adapter. Do not download or install a BIOS update while the computer is running on battery power, docked in an optional docking device, or connected to an optional power source. During the download and installation, follow these instructions:

Do not disconnect power from the computer by unplugging the power cord from the AC outlet.

Do not shut down the computer or initiate Standby or Hibernation.

Do not insert, remove, connect, or disconnect any device, cable, or cord.

To download a BIOS update:

📝 **NOTE:** BIOS updates are posted as needed. A newer BIOS update may not be available for your computer. It is recommended that you check the HP Web site periodically for BIOS updates.

1. Open your Web browser, go to <http://www.hp.com/support>, and then select your country or region.
2. Click the option for software and driver downloads, type your computer model number in the product box, and then press **enter**.
3. Click your specific product from the models listed.
4. Click your operating system.
5. Follow the on-screen instructions to access the BIOS update you want to download. Make a note of the download date, name, or other identifier. You may need this information to locate the update later, after it has been downloaded to your hard drive.
6. At the download area, perform these steps:
  - a. Identify the BIOS update that is newer than the BIOS version currently installed on your computer.
  - b. Follow the instructions on the screen to download your selection to the hard drive.

Make a note of the path to the location on your hard drive where the BIOS update will be downloaded. You will need to access this path when you are ready to install the update.

📝 **NOTE:** If you connect your computer to a network, consult the network administrator before installing any software updates, especially system BIOS updates.

BIOS installation procedures vary. Follow any instructions that are displayed on the screen after the download is complete. If no instructions are displayed, follow these steps:

1. Open Windows Explorer by selecting **Start > My Computer**.
2. Double-click your hard drive designation. The hard drive designation is typically Local Disk (C:).
3. Using the hard drive path you recorded earlier, open the folder on your hard drive that contains the update.
4. Double-click the file that has an .exe extension (for example, *filename.exe*).

The BIOS installation begins.

5. Complete the installation by following the instructions on the screen.

---

 **NOTE:** After a message on the screen reports a successful installation, you may delete the downloaded file from your hard drive.

---

## Updating programs and drivers

1. Open your Web browser, go to <http://www.hp.com/support>, and then select your country or region.
2. Click the option for software and driver downloads, type your computer model number in the product box, and then press **enter**.
3. Click your specific product from the models listed.
4. Click your operating system.
5. When the list of updates is displayed, click an update to open a window containing additional information.
6. Click **Download**.
7. Click **Run** to install the updated software without downloading the file.

– or –

Click **Save** to save the file to your computer. When prompted, select a storage location on your hard drive.

After the file is downloaded, navigate to the folder where the file was stored, and double-click the file to install the update.

8. If prompted to do so, restart your computer after the installation is complete.

## Using SoftPaq Download Manager

HP SoftPaq Download Manager (SDM) is a tool that provides quick access to SoftPaq information for HP business computers without requiring the SoftPaq number. Using this tool, you can easily search for SoftPaqs and then download and unpack them.

SoftPaq Download Manager works by reading and downloading, from the HP FTP site, a published database file containing computer model and SoftPaq information. SoftPaq Download Manager allows you to specify one or more computer models to determine which SoftPaqs are available for download.

SoftPaq Download Manager checks the HP FTP site for updates to the database and software. If updates are found, they are downloaded and applied automatically.

---

 **NOTE:** SoftPaq Download Manager is preinstalled on select computer models only. To download SoftPaq Download Manager or obtain more information about using it, see the HP Web site at <http://www.hp.com/go/sdm>.

---

To download SoftPaqs:

1. Select **Start > All Programs > HP > HP SoftPaq Download Manager**.
2. When the SoftPaq Download Manager opens for the first time, a window is displayed asking if you want to show only software for the computer you are using or to show the software for all supported

models. Select **Show software for all supported models**. If you have used HP SoftPaq Download Manager previously, go to Step 3.

- a. Select your operating system and language filters in the Configuration Options window. The filters limit the number of options that are listed in the Product Catalog pane. For example, if only Windows XP Professional is selected in the operating system filter, the only operating system that is displayed in the Product Catalog is Windows XP Professional.
  - b. To add other operating systems, change the filter settings in the Configuration Options window. Refer to the HP SoftPaq Download Manager software Help for more information.
3. In the left pane, click the (+) sign to expand the model list, and then select the model or models of the products you want to update.
4. Click **Find Available SoftPaqs** to download a list of available SoftPaqs for the selected computer.
5. Select from the list of available SoftPaqs, and then click **Download Only** if you have many SoftPaqs to download, because the SoftPaq selection and Internet connection speed determine how long the download process will take.

If you want to download only one or two SoftPaqs and have a high-speed Internet connection, click **Download & Unpack**.

6. Right-click **Install SoftPaq** in the SoftPaq Download Manager software to install the selected SoftPaqs on the computer.



---

# 12 MultiBoot

## About the boot device order

As the computer starts, the system attempts to boot from enabled boot devices. The MultiBoot utility, which is enabled at the factory, controls the order in which the system selects a boot device. Boot devices can include optical drives, diskette drives, a network interface card (NIC), hard drives, and USB devices. Boot devices contain bootable media or files that the computer needs to start and operate properly.

---

 **NOTE:** Some boot devices must be enabled in Computer Setup before they can be included in the boot order.

---

The factory setting is for the computer to select the boot device by searching enabled boot devices and drive bay locations in the following order:

---

 **NOTE:** Some of the boot devices and drive bay locations listed may not be supported on your computer.

---

- Optical drive
- Notebook hard drive
- USB diskette drive
- USB CD-ROM
- USB hard drive
- Notebook Ethernet
- Secure Digital (SD) Memory Card

You can change the order in which the computer searches for a boot device by changing the boot order in Computer Setup. You can also press **esc** while the “Press the ESC key for Startup Menu” message is displayed at the bottom of the screen, and then press **f9**. Pressing **f9** displays a menu that shows the current boot devices and allows you to select a boot device. Or, you can use MultiBoot Express to set the computer to prompt you for a boot location each time the computer turns on or restarts.

## Enabling boot devices in Computer Setup

The computer will boot to a USB device or a NIC device only if the device has first been enabled in Computer Setup.

To start Computer Setup and enable a USB device or a NIC device as a boot device, follow these steps:

1. Turn on or restart the computer, and then press **esc** while the “Press the ESC key for Startup Menu” message is displayed at the bottom of the screen.
2. Press **f10** to enter Computer Setup.
3. To enable bootable media in USB drives or in drives inserted into an optional docking device, use a pointing device or the arrow keys to select **System Configuration > Device Configurations**. Confirm that the box next to **USB legacy support** is checked.

 **NOTE:** The USB Port option must be enabled in order to use USB legacy support. It is enabled at the factory. If the port becomes disabled, reenable it by selecting **System Configuration > Port Options**, and then clicking the box next to **USB Port**.

– or –

To enable a NIC device, select **System Configuration > Boot Options**, and then click the box next to **PXE Internal NIC boot**.

4. To save your changes and exit Computer Setup, click **Save**, and then follow the on-screen instructions.

– or –

Use the arrow keys to select **File > Save Changes and Exit**, and then press **enter**.

Your changes go into effect when the computer restarts.

 **NOTE:** To connect a NIC to a Preboot eXecution Environment (PXE) or Remote Program Load (RPL) server without using MultiBoot, press **esc** while the “Press the ESC key for Startup Menu” message is displayed at the bottom of the screen, and then quickly press **f12**.

## Considering boot order changes

Before changing the boot order, note the following considerations:

- When the computer restarts after the boot order has been changed, the computer attempts to start using the new boot order.
- If there is more than one type of boot device, the computer attempts to boot using the first of each type of boot device (except for optical devices). For example, if the computer is connected to an optional docking device that contains a hard drive, this hard drive will be shown in the boot order as a USB hard drive. If the system attempts to boot from this USB hard drive and fails, it will not attempt to boot to the hard drive in the hard drive bay. Instead, it will try to boot to the next type of device in the boot order. However, if there are 2 optical devices, and the first optical device does not boot (either because it does not contain media or the media is not a boot disc), the system will try to boot to the second optical device.
- Changing the boot order also changes the logical drive designations. For example, if you start up from a CD-ROM drive with a disc formatted as drive C, that CD-ROM drive becomes drive C and the hard drive in the hard drive bay becomes drive D.
- The computer will boot from a NIC device only if the device has been enabled in the Built-In Device Options menu of Computer Setup and if booting from the device has been enabled in the Boot Options menu of Computer Setup. Booting from a NIC does not affect logical drive designations because no drive letter is associated with the NIC.
- Drives in an optional docking device are treated like external USB devices in the boot order.

## Choosing MultiBoot preferences

You can use MultiBoot in the following ways:

- To set a new boot order that the computer uses each time it is turned on, by changing the boot order in Computer Setup.
- To dynamically choose the boot device, by pressing **esc** while the “Press the ESC key for Startup Menu” message is displayed at the bottom of the screen, and then pressing **f9** to enter the Boot Device Options menu.
- To use MultiBoot Express to set variable boot orders. This feature prompts you for a boot device each time the computer is turned on or restarted.

### Setting a new boot order in Computer Setup

To start Computer Setup and set a boot device order that the computer uses each time it is turned on or restarted, follow these steps:

1. Turn on or restart the computer, and then press **esc** while the “Press the ESC key for Startup Menu” message is displayed at the bottom of the screen.
2. Press **f10** to enter Computer Setup.
3. Use a pointing device or the arrow keys to select **System Configuration > Boot Options**, and then select **Legacy Boot Order**.
4. To move the device up in the boot order, use a pointing device to click the up arrow key next to the device name, or press the **+** key.

– or –

To move the device down in the boot order, use a pointing device to click the down arrow key next to the device name, or press the **-** key.

5. To save your changes and exit Computer Setup, click **Save**, and then follow the on-screen instructions.

– or –

Use the arrow keys to select **File > Save Changes and Exit**, and then press **enter**.

Your changes go into effect when the computer restarts.

### Dynamically choosing a boot device using the f9 prompt

To dynamically choose a boot device for the current startup sequence, follow these steps:

1. Open the Select Boot Device menu by turning on or restarting the computer, and then pressing **esc** while the “Press the ESC key for Startup Menu” message is displayed at the bottom of the screen.
2. Press **f9**.
3. Use a pointing device or the arrow keys to select a boot device, and then press **enter**.

Your changes go into effect immediately.

## Setting a MultiBoot Express prompt

To start Computer Setup and set the computer to display the MultiBoot startup location menu each time the computer is started or restarted, follow these steps:

1. Turn on or restart the computer, and then press **esc** while the “Press the ESC key for Startup Menu” message is displayed at the bottom of the screen.
2. Press **f10** to enter Computer Setup.
3. Use a pointing device or the arrow keys to select **System Configuration > Boot Options**, and then press **enter**.
4. In the **Express Boot Popup Delay (Sec)** field, enter the length of time in seconds that you want the computer to display the startup location menu before it defaults to the current MultiBoot setting. (When 0 is selected, the Express Boot startup location menu is not displayed.)
5. To save your changes and exit Computer Setup, click **Save**, and then follow the on-screen instructions.

– or –

Use the arrow keys to select **File > Save Changes and Exit**, and then press **enter**.

Your changes go into effect when the computer restarts.

## Entering MultiBoot Express preferences

When the Express Boot menu is displayed during startup, you have the following choices:

- To specify a boot device from the Express Boot menu, select your preference within the allotted time, and then press **enter**.
- To prevent the computer from defaulting to the current MultiBoot setting, press any key before the allotted time expires. The computer will not start until you select a boot device and press **enter**.
- To allow the computer to start according to the current MultiBoot settings, wait for the allotted time to expire.

---

# 13 Management

## Using Client Management Solutions

Client Management Solutions software provides standards-based solutions for managing client (user) desktop, workstation, notebook, and tablet computers in a networked environment.

Client management includes the following key capabilities and features:

- Initial software image deployment
- Remote system software installation
- Software management and updates
- ROM updates
- Tracking and security of computer assets (the hardware and software installed on the computer)
- Fault notification and recovery of certain system software and hardware components

---

 **NOTE:** Support for specific features described in this section may vary, depending on computer model and/or version of management software installed on the computer.

---

## Configuring and deploying a software image

The computer is shipped with a preinstalled system software image. The initial software image is configured during the first-time setup of the computer. After a brief software "unbundling" occurs, the computer is ready to be used.

A customized software image can be deployed (distributed) in one of the following ways:

- Installing additional software applications after unbundling the preinstalled software image
- Using software deployment tools, such as Altiris Deployment Solutions, to replace the preinstalled software with a customized software image
- Using a disk-cloning process to copy the contents from one hard drive to another

The deployment method you use depends on your organization's technology environment and processes.

---

 **NOTE:** The Computer Setup utility and other system features provide further assistance with configuration management and troubleshooting, power management, and the recovery of system software.

---

## Managing and updating software

HP provides several tools for managing and updating software on client computers:

- HP Client Manager for Altiris (select models only)

 **NOTE:** To download HP Client Manager for Altiris or to obtain more information about HP Client Manager for Altiris, see the HP Web site at <http://www.hp.com>.

---

- HP CCM (Client Configuration Manager) (select models only)
- HP SSM (System Software Manager)

### HP Client Manager for Altiris (select models only)

HP Client Manager for Altiris integrates Intelligent Manageability technology into Altiris software. HP Client Manager for Altiris provides superior hardware management capabilities for HP devices:

- Detailed views of hardware inventory for asset management
- System Checkup monitoring and diagnostics
- Web-accessible reporting of business-critical details such as thermal warnings and memory alerts
- Remote updating of system software such as device drivers and the system BIOS

 **NOTE:** Additional functionality can be added when HP Client Manager for Altiris is used with optional Altiris Solutions software (purchased separately).

---

When HP Client Manager for Altiris (installed on a client computer) is used with Altiris Solutions software (installed on an administrator computer), HP Client Manager for Altiris provides increased management functionality and centralized hardware management of client devices for the following IT life-cycle areas:

- Inventory and asset management
  - Software license compliance
  - Computer tracking and reporting
  - Computer lease contract information and fixed asset tracking
- System software deployment and migration
  - Windows® migration
  - System deployment
  - Personality (personal user settings) migration

- Help desk and problem resolution
  - Management of help desk tickets
  - Remote troubleshooting
  - Remote problem resolution
  - Client disaster recovery
- Software and operations management
  - Ongoing client management
  - HP system software deployment
  - Application self-healing (the ability to identify and repair certain application problems)

Altiris Solutions software provides easy-to-use software distribution capabilities. HP Client Manager for Altiris enables communication with the Altiris Solutions software, which can be used to complete new hardware deployment or personality migration to a new operating system using easy-to-follow wizards. HP Client Manager for Altiris is available for download from the HP Web site.

When Altiris Solutions software is used in conjunction with HP System Software Manager or HP Client Manager for Altiris, administrators can also update the system BIOS and device driver software from a central console.



## HP CCM (Client Configuration Manager) (select models only)

HP CCM (Client Configuration Manager) automates the management of software such as operating systems, programs, software updates, and content and configuration settings to ensure that each computer is maintained in the correct configuration. With these automated management solutions, you can manage software throughout the life cycle of the computer.

CCM enables you to perform the following tasks:

- Collect hardware and software inventory across multiple platforms
- Prepare a software package and conduct impact analysis prior to distribution
- Target individual computers, workgroups, or entire populations of computers for deployment and maintenance of software and content according to policies
- Provision and manage operating systems, applications, and content on distributed computers from any location
- Integrate CCM with help desks and other system management tools for seamless operations
- Leverage a common infrastructure for management of software and content on standard computing devices across any network for all enterprise users
- Scale to meet enterprise needs

## HP SSM (System Software Manager)

HP SSM (System Software Manager) lets you remotely update system-level software on multiple systems simultaneously. When executed on a client computer, SSM detects versions of both hardware and software, and then updates designated software from a central repository, known as a file store. Driver versions that are supported by SSM are denoted with a special icon on the HP driver download Web site and on the *Support Software* CD. To download the SSM utility or to obtain more information on SSM, see the HP Web site at <http://www.hp.com/go/ssm> (English only).

# Using Intel Active Management Technology (select models only)

Intel® Active Management Technology (iAMT) allows discovery, repair, and protection of networked computing assets. With iAMT, computers can be managed whether they are on or off. The iAMT solution is available on computers with Intel Centrino® with vPro mobile technology.

Features of iAMT include:

- Hardware inventory information
- Event notification
- Power management
- Remote diagnosis and repair
- Hardware-based isolation and recovery—limit or cut off computer network access if virus-like activity is detected

## Enabling the iAMT solution

To configure iAMT settings:

 **NOTE:** The `ctrl+p` prompt is visible only if the AMT Setup Prompt option is enabled in Computer Setup.

1. Turn on or restart the computer.
2. Before Windows starts up, press `ctrl+p`.

 **NOTE:** If you do not press `ctrl+p` at the appropriate time, you must repeat steps 1 and 2 to access the MEBx setup utility.

3. Enter the ME password. The factory setting for the password is *admin*.  
The MEBx setup utility opens. Use the arrow keys to navigate.
4. Choose to configure Intel ME, configure iAMT, or change the Intel ME password.
5. When you have made your selections, select **Exit** to close the MEBx setup utility.

## Using the MEBx setup utility menus

 **NOTE:** For more information on iAMT, go to the Intel Web site at <http://www.intel.com>, and then search for iAMT.

### Intel ME Configuration

Select	To do this
Intel ME State Control	Disable/enable the management engine.
Intel ME Firmware Local Update	Disable/enable local management of firmware updates.
LAN Controller	Disable/enable the integrated network controller.
Intel ME Features Control	Enable AMT or none.
Intel ME Power Control	Configure the management engine power policies.

## iAMT Configuration

Select	To do this
Host Name	Assign a host name to the computer.
TCP/IP	Disable/enable network interface or DHCP (assigns an IP address if DHCP has been disabled) or change the domain name.
Provision Model	Assign Enterprise or Small Business iAMT model.
Setup and Configuration	Set options to control remote configuration of AMT.
Un-Provision	Reset the AMT configuration to factory defaults.
SOL/IDE-R	Enable remote boot control to IDE diskette or CD-ROM and assign a user name and password.
Password Policy	Set options to control requirements for the network password and the MEBx password.
Secure Firmware Update	Enable or disable updating firmware remotely.
Set PRTC	Set the real-time clock.
Idle Timeout	Set a time-out value.

## Change Intel ME Password

Select	To do this
Change ME Password	Change the password.

**NOTE:** The default password is **admin**.

---

# 14 Computer Setup

## Starting Computer Setup

Computer Setup is a preinstalled, ROM-based utility that can be used even when the operating system is not working or will not load.

 **NOTE:** Some of the Computer Setup menu items listed in this guide may not be supported by your computer.

**NOTE:** An external keyboard or mouse connected to a USB port can be used with Computer Setup only if USB legacy support is enabled.

To start Computer Setup, follow these steps:

1. Turn on or restart the computer, and then press **esc** while the “Press the ESC key for Startup Menu” message is displayed at the bottom of the screen.
2. Press **f10** to enter Computer Setup.

## Using Computer Setup

### Navigating and selecting in Computer Setup

The information and settings in Computer Setup are accessed from the File, Security, and System Configuration menus.

To navigate and select in Computer Setup, follow these steps:

1. Turn on or restart the computer, and then press **esc** while the “Press the ESC key for Startup Menu” message is displayed at the bottom of the screen.
  - To select a menu or a menu item, use the **tab** key and the keyboard arrow keys and then press **enter**, or use a pointing device to click the item.
  - To scroll up and down, click the up arrow or the down arrow in the upper-right corner of the screen, or use the up arrow key or the down arrow key.
  - To close open dialog boxes and return to the main Computer Setup screen, press **esc**, and then follow the on-screen instructions.

 **NOTE:** You can use either a pointing device (TouchPad, pointing stick, or USB mouse) or the keyboard to navigate and make selections in Computer Setup.

2. Press **f10** to enter Computer Setup.
3. Select the **File**, **Security**, or **System Configuration** menu.

To exit Computer Setup menus, choose one of the following methods:

- To exit Computer Setup menus without saving your changes, click **Exit**, and then follow the on-screen instructions.  
– or –  
Use the **tab** key and the arrow keys to select **File > Ignore Changes and Exit**, and then press **enter**.
- To save your changes and exit Computer Setup menus, click **Save**, and then follow the on-screen instructions.  
– or –  
Use the **tab** key and the arrow keys to select **File > Save Changes and Exit**, and then press **enter**.

Your changes go into effect when the computer restarts.

## Restoring factory settings in Computer Setup

---

 **NOTE:** Restoring defaults will not change the hard drive mode.

---

To return all settings in Computer Setup to the values that were set at the factory, follow these steps:

1. Turn on or restart the computer, and then press **esc** while the “Press the ESC key for Startup Menu” message is displayed at the bottom of the screen.
2. Press **f10** to enter Computer Setup.
3. Use a pointing device or the arrow keys to select **File > Restore Defaults**.
4. Follow the on-screen instructions.
5. To save your changes and exit, click **Save**, and then follow the on-screen instructions.

– or –

Use the arrow keys to select **File > Save Changes and Exit**, and then press **enter**.

Your changes go into effect when the computer restarts.

---

 **NOTE:** Your password settings and security settings are not changed when you restore the factory settings.

---

## Computer Setup menus

The menu tables in this section provide an overview of Computer Setup options.

---

 **NOTE:** Some of the Computer Setup menu items listed in this chapter may not be supported by your computer.

---

## File menu

Select	To do this
System Information	<ul style="list-style-type: none"><li>• View identification information for the computer and the batteries in the system.</li><li>• View specification information for the processor, memory size, system ROM, video revision, keyboard controller version, and wireless identification numbers.</li></ul>
Set System Date and Time	<p>Change date and time.</p> <ul style="list-style-type: none"><li>• Set Date: MM:DD:YYYY</li><li>• Set Time: HH:MM</li></ul>
System Diagnostics	<ul style="list-style-type: none"><li>• System Information—Displays the following information:<ul style="list-style-type: none"><li>◦ Identification information for the computer and the batteries in the system.</li><li>◦ Specification information for the processor, memory size, system ROM, video revision, keyboard controller version, and wireless identification numbers.</li></ul></li><li>• Start-up Test—Verifies the system components needed for starting the computer.</li><li>• Run-In Test—Runs a comprehensive check on the system memory, hard drive, battery, and wireless module status.</li><li>• Hard Disk Test—Runs a comprehensive self-test on any hard drive in the system.</li><li>• Memory Test—Runs a comprehensive check on the memory module(s).</li><li>• Battery Test—Runs a comprehensive check on the battery.</li><li>• Error Log—Displays a log file if any errors have occurred.</li></ul>
Restore Defaults	<p>Replace the configuration settings in Computer Setup with the original factory settings. (Hard drive mode, password settings, and security settings are not changed when you restore the factory settings.)</p>
Reset BIOS security to factory default	<p>Resets password to the factory default in case of a forgotten password.</p>
Ignore Changes and Exit	<p>Cancel any changes entered during the current session. Then exit and restart the computer.</p>
Save Changes and Exit	<p>Save any changes entered during the current session. Then exit and restart the computer. Your changes go into effect when the computer restarts.</p>

## Security menu

 **NOTE:** Some of the menu items listed in this section may not be supported by your computer.

Select	To do this
Setup BIOS Administrator Password	Set up a BIOS administrator password.
User Management (requires a BIOS administrator password)	<ul style="list-style-type: none"> <li>• Create a new BIOS user account.</li> <li>• View a list of ProtectTools users.</li> </ul>
Password Policy (requires a BIOS administrator password)	Revise password policy criteria.
HP SpareKey	Enable/disable HP SpareKey (enabled by default).
Always Prompt for HP SpareKey Enrollment	Enable/disable HP SpareKey enrollment (enabled by default).
Fingerprint Reset on Reboot (If Present)	Reset/clear the fingerprint reader ownership (select models only; disabled by default).
Change Password	Enter, change, or delete a BIOS administrator password.
HP SpareKey Enrollment	Enroll or reset HP SpareKey, which is a set of security questions and answers used if you forget your password.
Anti Theft	Enable/disable Intel Anti-Theft support.
DriveLock Password	<ul style="list-style-type: none"> <li>• Enable/disable DriveLock on any computer hard drive (enabled by default).</li> <li>• Change a DriveLock user password or master password.</li> </ul> <p><b>NOTE:</b> DriveLock settings are accessible only when you enter Computer Setup by turning on (not restarting) the computer.</p>
Automatic DriveLock	Enable/disable Automatic DriveLock support.
TPM Embedded Security	<p>Enable/disable support for Trusted Platform Module (TPM) Embedded Security, which protects the computer from unauthorized access to owner functions available in Embedded Security for ProtectTools. For more information, refer to the ProtectTools software Help.</p> <p><b>NOTE:</b> You must have a setup password to change this setting.</p>
Disk Sanitizer	<p>Run Disk Sanitizer to destroy all existing data on the primary hard drive.</p> <p><b>CAUTION:</b> If you run Disk Sanitizer, the data on the selected drive is destroyed permanently.</p>
System IDs	Enter a user-defined computer asset tracking number and ownership tag.

## System Configuration menu

 **NOTE:** Some of the listed System Configuration options may not be supported by your computer.

Select	To do this
Language	Change the Computer Setup language.



Select	To do this
Boot Options	<ul style="list-style-type: none"> <li>• Set a Startup Menu delay (in seconds).</li> <li>• Set the MultiBoot Express Popup Delay (in seconds).</li> <li>• Enable/disable Custom Logo (disabled by default).</li> <li>• Enable/disable Display Diagnostic URL (enabled by default).</li> <li>• Enable/disable CD-ROM boot (enabled by default).</li> <li>• Enable/disable SD Card boot (enabled by default).</li> <li>• Enable/disable floppy boot (enabled by default).</li> <li>• Enable/disable PXE Internal NIC boot (enabled by default).</li> <li>• Enable/disable Unified Extensible Firmware Interface (UEFI) mode.</li> <li>• Set the boot order.</li> </ul>
Device Configurations	<ul style="list-style-type: none"> <li>• Enable/disable USB legacy support (enabled by default). When enabled, USB legacy support allows the following: <ul style="list-style-type: none"> <li>◦ Use of a USB keyboard in Computer Setup even when a Windows® operating system is not running.</li> <li>◦ Startup from bootable USB devices, including a hard drive, diskette drive, or optical drive connected by a USB port to the computer.</li> </ul> </li> <li>• Enable/disable fan always on while connected to an AC outlet (enabled by default).</li> <li>• Enable/disable Data Execution Prevention. When enabled, the processor can disable some virus code execution, which helps to improve computer security.</li> <li>• SATA (Serial Advanced Technology Attachment) device mode. The following options are available: <ul style="list-style-type: none"> <li>◦ AHCI (Advanced Host Controller Interface)</li> <li>◦ IDE (Integrated Drive Electronics)</li> <li>◦ RAID (select models only)</li> </ul> </li> </ul>

---

Select	To do this
	<p data-bbox="893 220 1388 283"><b>NOTE:</b> Availability of the options above varies by computer model.</p> <ul data-bbox="845 304 1436 756" style="list-style-type: none"><li data-bbox="845 304 1388 325">• Enable/disable HP QuickLook (enabled by default).</li><li data-bbox="845 346 1436 409">• Enable/disable preboot authentication on HP QuickLook Boot (enabled by default).</li><li data-bbox="845 430 1388 451">• Enable/disable HP QuickWeb (enabled by default).</li><li data-bbox="845 472 1324 493">• Enable/disable HP QuickWeb: Write Protect.</li><li data-bbox="845 514 1388 577">• Enable/disable Multi Core CPU (select models only; enabled by default).</li><li data-bbox="845 598 1356 661">• Enable/disable Intel HT Technology (enabled by default).</li><li data-bbox="845 682 1181 703">• Enable/disable Wake on USB.</li><li data-bbox="845 724 1276 756">• Turn the Numlock state at boot on or off.</li></ul>

---

Select	To do this
Built-In Device Options	<ul style="list-style-type: none"> <li>• Enable/disable the wireless button state (enabled by default).</li> <li>• Enable/disable the embedded WLAN device (enabled by default).</li> <li>• Enable/disable embedded WWAN device radio (select models only; enabled by default).</li> <li>• Enable/disable embedded Bluetooth® device radio (enabled by default).</li> <li>• Enable/disable the Network Interface Controller (LAN) (enabled by default).</li> <li>• Enable/disable LAN/WLAN switching (disabled by default).</li> <li>• Set the wake on LAN state. Options include the following: <ul style="list-style-type: none"> <li>◦ Disabled</li> <li>◦ Boot to Network (set by default)</li> <li>◦ Follow Boot Order</li> </ul> </li> <li>• Enable the ambient light sensor (enabled by default).</li> <li>• Enable/disable the Notebook Upgrade bay device (enabled by default).</li> <li>• Enable/disable the fingerprint device (enabled by default).</li> <li>• Enable/disable the integrated camera (select models only; enabled by default).</li> <li>• Enable/disable Power Monitor Circuit.</li> <li>• Enable/disable audio device (enabled by default).</li> <li>• Enable/disable a modem device (enabled by default).</li> <li>• Enable/disable the internal microphones (enabled by default).</li> <li>• Enable/disable internal speakers (enabled by default).</li> </ul>

Select	To do this
Port Options (all are enabled by default)	<p><b>NOTE:</b> All port options are enabled by default.</p> <ul style="list-style-type: none"> <li>• Enable/disable the flash media reader.</li> <li>• Enable/disable the USB port.</li> </ul> <p><b>CAUTION:</b> Disabling the USB port also disables MultiBay devices and ExpressCard devices on the advanced port replicator.</p> <ul style="list-style-type: none"> <li>• Enable/disable the 1394 port.</li> <li>• Enable/disable the ExpressCard slot.</li> <li>• Enable/disable the Smart Card slot.</li> <li>• Enable/disable the eSATA port.</li> </ul>
Set Security Level	Change, view, or hide security levels for all BIOS menu items.
Restore Security Defaults	Restore the default security settings.

---

# 15 Backing up and recovering

To protect your information, use the Windows® Backup utility (select models only) to back up files and folders or create recovery points. In case of system failure, you can use the backup files to restore your computer.

Windows provides the following options:

- Backing up individual files and folders
- Backing up all files and folders
- Scheduling automatic backups
- Creating recovery points
- Recovering information

---

 **NOTE:** For detailed instructions, perform a search for these topics in Help and Support.

In case of system instability, HP recommends that you print the recovery procedures and save them for later use.

---

## Backing up your information

Recovery after a system failure is as complete as your most current backup. You should create your initial backup immediately after software setup. As you add new software and data files, you should continue to back up your system on a regular basis to maintain a reasonably current backup.

You can back up individual files or folders to an optional external hard drive or to a network drive.

Note the following when backing up:

- Store personal files in the My Documents folder, and back it up periodically.
- Back up templates stored in their associated programs.
- Save customized settings that appear in a window, toolbar, or menu bar by taking a screen shot of your settings. The screen shot can be a time saver if you have to reset your preferences.

To copy the screen and paste it into a word-processing document:

- a. Display the screen you want to save.
- b. Copy the screen image:  
To copy only the active window, press **alt+fn+prt sc**.  
To copy the entire screen, press **fn+prt sc**.
- c. Open a word-processing document, click **Edit > Paste**.  
The screen image is added to the document.
- d. Save the document.

To create a backup using the Windows Backup utility (select models only), follow these steps:

---

 **NOTE:** Be sure that the computer is connected to AC power before you start the backup process.

**NOTE:** The backup process may take over an hour, depending on file size and the speed of the computer.

---

1. Select **Start > All Programs > Accessories > System Tools > Backup**.
2. Follow the on-screen instructions.

## Performing a recovery

In case of system failure or instability, the computer provides the following tools to recover your files:

- Windows recovery tools (select models only): You can use the Windows Backup utility to recover information you have previously backed up.
- *Operating System* and *Driver Recovery* discs (included with your computer): You can use the discs to recover your operating system and programs installed at the factory.

## Recovering your information

To recover information you previously backed up, follow these steps:

1. If possible, back up all personal files.
2. Select **Start > All Programs > Accessories > System Tools > Backup**.  
The Backup or Restore Wizard opens.
3. Click **Restore files and settings**, and then click **Next**.
4. Follow the on-screen instructions.

---

 **NOTE:** For additional information on initiating a recovery in Windows, perform a search for this topic in Help and Support.

---

## Recovering the operating system and programs

 **CAUTION:** The recovery process reformats and completely erases the hard drive. All files you have created and any software installed on the computer are permanently removed. The recovery process reinstalls the original operating system, software, and drivers. Software, drivers, and updates not installed by HP must be manually reinstalled.

---

To recover your operating system and programs, follow these steps:

1. If possible, back up all personal files.
2. Insert the *Operating System* disc into the optical drive.
3. Shut down the computer.
4. Turn on the computer.
5. Follow the on-screen instructions to install the operating system.
6. After the operating system is installed, remove the *Operating System* disc and insert the *Driver Recovery* disc.
7. Follow the on-screen instructions to install the drivers and programs.

---

# Index

## Symbols/Numerics

- 1394 cable, connecting 87
- 1394 devices
  - connecting 87
  - removing 87
- 1394 port 8, 87

## A

- AC adapter 13
- AC adapter, connecting 56
- administrator password 111
- airport security devices 68
- Altiris Deployment Solutions 138
- ambient light sensor 12
- applications key, Windows 6
- audio devices, connecting
  - external 43
- audio functions, checking 43
- audio-in (microphone) jack 8, 40
- audio-out (headphone) jack 8, 40
- Automatic DriveLock password
  - entering 119
  - removing 120

## B

- backing up files and folders 154
- battery
  - calibrating 61
  - charging 58, 61
  - conserving power 63
  - disposing 64
  - inserting 57
  - low battery levels 59
  - recharging 63
  - removing 57
  - replacing 64
  - storing 63
- battery bay 10, 13
- battery charge, maximizing 59

- battery light 7, 58, 60
- battery power 56
- battery release latches 10, 57
- battery temperature 63
- battery test 147
- bays
  - battery 13
  - hard drive 9, 10, 11, 73
  - optical drive 11
- BIOS administrator password 148
- BIOS update
  - downloading 130
  - installing 130
- Bluetooth label 14
- boot devices, enabling 134
- boot options 149
- boot order 149
- broadband wireless module compartment 11
- built-in device
  - ambient light sensor 151
  - audio 151
  - Bluetooth device radio 151
  - embedded WLAN 151
  - fingerprint reader 151
  - integrated camera 151
  - LAN/WLAN switching 151
  - microphones 151
  - modem 151
  - Network Interface Controller (LAN) 151
  - notebook upgrade bay 151
  - speakers 151
  - Wake on LAN 151
  - wireless button 151
  - WWAN device radio 151
- built-in device options 151
- business card slot 7

## buttons

- display release 7
- keyboard 12
- pointing stick 2
- power 5
- QuickLook 5
- QuickWeb 5
- TouchPad 1
- TouchPad on/off 2, 5
- volume down 5, 40
- volume mute 5, 40
- volume up 5, 40
- wireless 5

## C

- cables
  - 1394 87
  - modem 13
  - USB 85
- calibrating battery 61
- caps lock light 3
- CD
  - inserting 46, 90
  - removing 48, 91
- CD drive 89
- Certificate of Authenticity label 13
- changing boot order 136
- charging batteries 58, 61
- checking audio functions 43
- compartments
  - broadband wireless module 11
  - memory module 10
  - WLAN 11
- components
  - additional hardware 12
  - bottom 10
  - display 11
  - front 6
  - left-side 8



- rear 7
- right-side 8
- top 1
- computer information 129
- Computer Setup
  - BIOS administrator password 112
  - device security 121
  - DriveLock password 115
  - enabling bootable devices 134
  - File menu 147
  - navigating and selecting 145
  - restoring factory settings 146
  - Security menu 147
  - setting boot order 136
  - setting MultiBoot Express prompt 137
  - System Configuration menu 148
- Computer Setup utility 138
- configuring ExpressCards 94
- connecting to a LAN 27
- connecting to a WLAN 20
- connection, external power 56
- connector, docking 8, 88
- connector, power 9
- conservation, power 63
- cord, power 13
- corporate WLAN connection 20
- creating a wireless connection 16
- critical battery level 60

**D**

- deployment, software 138
- device configurations 149
- device security 121
- digital card
  - inserting 93
  - removing 93
- discs
  - Driver Recovery 155
  - Operating System 155
- Disk Cleanup software 69
- Disk Defragmenter software 69
- Disk Sanitizer 148
- diskette drive 89
- display components 11
- display release button 7
- DisplayPort 8, 45

- docking connector 8, 88
- drive light 7, 70
- drive media 52
- DriveLock password
  - changing 118
  - description 115
  - entering 117
  - removing 119
  - setting 116
- DriveLock, automatic 148
- Driver Recovery disc 155
- drives
  - boot order 133
  - diskette 89
  - external 89
  - hard 76, 89
  - optical 89
- drives, boot order 149
- DVD
  - changing region setting 47
  - inserting 46, 90
  - removing 48, 91
- DVD drive 89
- DVD region settings 47

**E**

- earbuds 40
- embedded numeric keypad
  - keys 6
- encryption 19
- error log 147
- esc key 6
- Execution Disable 149
- ExpressCard
  - configuring 94
  - defined 94
  - inserting 94
  - removing 95
  - removing insert 95
- ExpressCard slot 8
- external audio devices,
  - connecting 43
- external drive 89
- external monitor port 8, 44

**F**

- File menu 147
- files and folders
  - backing up 154
  - recovering 155

- fingerprint reader 5
- firewall 19
- fn key 6, 34
- function keys 6, 34

**H**

- hard disk drive
  - external 89
  - HP 3D DriveGuard 70
  - installing 76
- hard disk test 147
- hard drive
  - external 89
  - HP 3D DriveGuard 70
  - installing 76
- hard drive bay 9, 10, 11
- hardware, identifying 1
- headphones 40
- Hibernation
  - exiting 53
  - initiated during critical battery level 60
  - initiating 53
- hotkeys
  - description 34
  - using 35
- HP 3D DriveGuard 70
- HP Client Configuration Manager 139, 141
- HP Client Manager for Altiris 139
- HP Mobile Broadband 20
- HP QuickLook 3 150
- HP SpareKey enrollment 148
- HP System Software Manager 139, 142
- hubs 85

**I**

- icons
  - network status 16
  - wireless 16
- image, computer 138
- Intel Anti-Theft 148
- Intel Centrino Pro technology 143
- Intel HT Technology 150
- interference, minimizing 26
- internal microphones 12, 40
- Internet connection setup 18

- J**
- jacks
  - audio-in (microphone) 8, 40
  - audio-out (headphone) 8, 40
  - RJ-11 (modem) 9
  - RJ-45 (network) 7
- Java Card
  - defined 96
  - inserting 97
  - removing 97
- K**
- keyboard hotkeys 34
- keyboard light and button 12, 34
- keyboard screws
  - removing 102
  - replacing 108
- keypad, embedded
  - enabling and disabling 37
  - switching key functions 37
  - using 37
- keypad, external
  - num lock 37
  - using 37
- keys
  - esc 6
  - fn 6
  - function 6
  - keypad 6
  - Windows applications 6
  - Windows logo 6
- L**
- labels
  - Bluetooth 14
  - Microsoft Certificate of Authenticity 13
  - regulatory 13
  - service tag 13
  - wireless certification 14
  - WLAN 14
- LAN, connecting 27
- language, changing in Computer Setup 148
- latches, battery release 10
- legacy support, USB 145, 149
- light, drive 70
- lights
  - battery 7
  - caps lock 3
  - drive 7
  - keyboard 12
  - num lock 3, 36
  - power 3, 7
  - QuickLook 3
  - QuickWeb 3
  - TouchPad on/off 3
  - volume mute 3
  - webcam 12
  - wireless 3, 7
- local area network (LAN) 3
- logical drive designations 135
- low battery level 59
- M**
- maintenance
  - Disk Cleanup 69
  - Disk Defragmenter 69
- McAfee Total Protection 123, 124
- memory module
  - inserting 105
  - removing 99, 105
  - replacing 99, 102
  - upgrading primary 102
- memory module compartment 10
- memory module compartment cover
  - removing 99
  - replacing 101
- memory test 147
- memory, replacing memory modules 99, 102
- microphone (audio-in) jack 8, 40
- microphones, internal 12, 40
- Microsoft Certificate of Authenticity label 13
- minimizing interference 26
- modem adapter 13
- modem cable 13
- modems
  - connecting a modem cable 28
  - connecting a modem cable adapter 28
  - selecting a location setting 29
- monitor, connecting 44
- mouse, external
  - connecting 33
  - setting preferences 33
- Multi Core CPU 150
- MultiBoot Express 133, 137
- multimedia components 39
- multimedia software, installing 41
- MultiMediaCard 93
- N**
- network key 25
- network security codes
  - network key 25
  - SSID 25
- Network Service Boot 134
- network status icon 16
- NIC boot device 133, 134
- num lock light 3, 36
- num lock, external keypad 37
- O**
- operating system
  - Microsoft Certificate of Authenticity label 13
  - Product Key 13
- Operating System disc 155
- optical disc
  - inserting 46, 90
  - removing 48, 91
- optical drive 9, 89
- optical drive bay 11
- P**
- passwords
  - administrator 111
  - BIOS administrator 112
  - DriveLock 115
  - user 111
- pointing devices, setting preferences 33
- pointing stick 2, 33
- pointing stick buttons 2
- port options
  - 1394 port 152
  - eSATA port 152
  - ExpressCard slot 152
  - flash media reader 152
  - Smart Card slot 152
  - USB port 152
- ports
  - 1394 8, 87
  - DisplayPort 8
  - external monitor 8, 44
  - USB 7, 9, 85

- power
    - connecting 56
    - conserving 63
  - power button 5
  - power connector 9
  - power cord 13
  - power light 3, 7
  - Power Monitor Circuit 151
  - Product Key 13
  - product name and number, computer 13
  - projector, connecting 44
  - public WLAN connection 20
  - PXE server 134
- Q**
- QuickLook button 5
  - QuickLook light 3
  - QuickWeb button 5
  - QuickWeb light 3
- R**
- RAID (Redundant Array of Independent Disks) devices 149
  - readable media 52
  - region codes, DVD 47
  - regulatory information
    - regulatory label 13
    - wireless certification labels 14
  - release latches, battery 10
  - restore security defaults 152
  - restore the factory settings 147
  - RJ-11 (modem) jack 9
  - RJ-45 (network) jack 7
  - run-in test 147
- S**
- SATA (Serial Advanced Technology Attachment) devices
    - AHCI (Advanced Host Controller Interface) 149
    - IDE (Integrated Drive Electronics) 149
  - scrolling regions, TouchPad 2
  - SD Card 93
  - SD Card Reader 8, 93
  - security
    - protecting the computer 110
    - wireless 18
  - security cable slot 8
  - Security menu
    - always prompt for HP SpareKey enrollment 148
    - Automatic DriveLock 148
    - change password 148
    - Disk Sanitizer 148
    - DriveLock 148
    - fingerprint reader reset 148
    - HP Sparekey 148
    - HP Sparekey enrollment 148
    - password policy 148
    - set up BIOS administrator password 148
    - System IDs 148
    - user management 148
  - serial number, computer 13
  - service tag 13
  - set security level 152
  - set system date and time 147
  - setup of WLAN 18
  - setup utility
    - File menu 147
    - navigating and selecting 145
    - restoring factory settings 146
    - Security menu 147
    - System Configuration menu 148
  - setup, computer 1
  - shut down 65
  - slots
    - business card 7
    - ExpressCard 8
    - memory module 98
    - security cable 8
    - SIM 10
  - smart card
    - defined 96
    - inserting 97
    - removing 97
  - smart card reader 9
  - SoftPaqs, downloading 131
  - software
    - BIOS update 130
    - deployment 138
    - Disk Cleanup 69
    - Disk Defragmenter 69
    - recovery 138
    - updates 139
    - updating programs and drivers 131
  - speakers 7, 10, 40
  - Standby
    - exiting 52
    - initiating 52
  - start-up test 147
  - storing battery 63
  - subscriber identity module (SIM)
    - inserting 21
    - removing 22
  - subscriber identity module (SIM) slot 10
  - System Configuration menu 148
  - system diagnostics 147
  - system fan 149
  - system IDs 148
  - system information 147
- T**
- temperature 63
  - TouchPad
    - buttons 1
    - scrolling regions 2
    - using 33
  - TouchPad on/off button 2, 5
  - TouchPad on/off light 3
  - TPM Embedded Security 148
  - traveling with the computer 14, 63
  - troubleshooting wireless network problems 24
  - turning off the computer 65
- U**
- unresponsive system 65
  - updates, software 139
  - USB cable, connecting 85
  - USB devices
    - connecting 85
    - description 85
    - removing 86
    - stopping 86
  - USB hubs 85
  - USB legacy support 86, 145, 149
  - USB port, powered 89, 90
  - USB ports 7, 9, 85
  - user password 111
  - using a modem 27
- V**
- vents 8, 10

- video, recording 12
- volume down button 5, 40
- volume mute button 5, 40
- volume mute light 3
- volume up button 5, 40
- volume, adjusting 42

## W

### Web sites

- HP System Software
  - Manager 142
  - Intel Pro technology for AMT 143
- webcam 12, 40, 49
- webcam light 12
- webcam properties, adjusting 49
- Windows applications key 6
- Windows Backup utility 154, 155
- Windows logo key 6
- Windows recovery 155
- wired connections 27
- wireless button 5, 16
- wireless certification label 14
- wireless connections 16
- wireless controls
  - button 16
  - operating system 16
- wireless icon 16
- wireless light 3, 7, 16
- wireless network (WLAN)
  - connecting 20
  - corporate WLAN
    - connection 20
  - equipment needed 18
  - functional range 20
  - public WLAN connection 20
  - security 18
- wireless network problems,
  - troubleshooting 24
- WLAN antennas 12
- WLAN device 14, 18
- WLAN label 14
- writable media 52
- WWAN antennas 12

