

# HP EliteBook

## User Guide

© Copyright 2010 Hewlett-Packard  
Development Company, L.P.

Bluetooth is a trademark owned by its proprietor and used by Hewlett-Packard Company under license. Intel is a trademark of Intel Corporation in the U.S. and other countries. Java is a U.S. trademark of Sun Microsystems, Inc. Microsoft and Windows are U.S. registered trademarks of Microsoft Corporation. SD Logo is a trademark of its proprietor.

The information contained herein is subject to change without notice. The only warranties for HP products and services are set forth in the express warranty statements accompanying such products and services. Nothing herein should be construed as constituting an additional warranty. HP shall not be liable for technical or editorial errors or omissions contained herein.

First Edition: January 2010

Document Part Number: 582865-001

#### **Product notice**

This user guide describes features that are common to most models. Some features may not be available on your computer.

## Safety warning notice

- 
- ⚠ **WARNING!** To reduce the possibility of heat-related injuries or of overheating the computer, do not place the computer directly on your lap or obstruct the computer air vents. Use the computer only on a hard, flat surface. Do not allow another hard surface, such as an adjoining optional printer, or a soft surface, such as pillows or rugs or clothing, to block airflow. Also, do not allow the AC adapter to contact the skin or a soft surface, such as pillows or rugs or clothing, during operation. The computer and the AC adapter comply with the user-accessible surface temperature limits defined by the International Standard for Safety of Information Technology Equipment (IEC 60950).
-



---

# Table of contents

## 1 Features

|   |    |
|---|----|
| Identifying hardware .....                      | 1  |
| Top components .....                            | 1  |
| Pointing devices .....                          | 1  |
| Lights .....                                    | 2  |
| Buttons, switches, and fingerprint reader ..... | 4  |
| Keys .....                                      | 5  |
| Front components .....                          | 6  |
| Rear components .....                           | 7  |
| Right-side components .....                     | 7  |
| Left-side components .....                      | 8  |
| Bottom components .....                         | 9  |
| Display components .....                        | 10 |
| Wireless antennas (select models only) .....    | 11 |
| Additional hardware components .....            | 12 |
| Identifying the labels .....                    | 12 |

## 2 Wireless, modem, and local area network

|  |    |
|--|----|
| Using wireless devices (select models only) .....            | 14 |
| Identifying wireless and network icons .....                 | 15 |
| Using the wireless controls .....                            | 15 |
| Using the wireless button .....                              | 15 |
| Using Wireless Assistant software (select models only) ..... | 16 |
| Using HP Connection Manager (select models only) .....       | 16 |
| Using operating system controls .....                        | 16 |
| Using a WLAN device (select models only) .....               | 17 |
| Setting up a WLAN .....                                      | 17 |
| Protecting your WLAN .....                                   | 17 |
| Connecting to a WLAN .....                                   | 19 |
| Roaming to another network .....                             | 19 |
| Using HP Mobile Broadband (select models only) .....         | 20 |
| Inserting a SIM (select models only) .....                   | 20 |
| Removing a SIM (select models only) .....                    | 21 |
| Using a Bluetooth wireless device (select models only) ..... | 23 |

|  |    |
|--|----|
| Bluetooth and Internet Connection Sharing (ICS) .....              | 23 |
| Troubleshooting wireless connection problems .....                 | 24 |
| Cannot create a WLAN connection .....                              | 24 |
| Cannot connect to a preferred network .....                        | 25 |
| Current network security codes are unavailable .....               | 25 |
| WLAN connection is very weak .....                                 | 26 |
| Cannot connect to the wireless router .....                        | 26 |
| Using the modem (select models only) .....                         | 27 |
| Connecting a modem cable .....                                     | 27 |
| Connecting a country- or region-specific modem cable adapter ..... | 27 |
| Selecting a location setting .....                                 | 28 |
| Viewing the current location selection .....                       | 28 |
| Adding new locations when traveling .....                          | 28 |
| Solving travel connection problems .....                           | 29 |
| Connecting to a local area network (LAN) .....                     | 31 |

### 3 Pointing devices and keyboard

|  |    |
|--|----|
| Using pointing devices .....                                 | 32 |
| Setting pointing device preferences .....                    | 32 |
| Using the TouchPad .....                                     | 32 |
| Using the pointing stick .....                               | 32 |
| Connecting an external mouse .....                           | 32 |
| Using the keyboard .....                                     | 32 |
| Using hotkeys .....  | 32 |
| Displaying system information .....                          | 33 |
| Initiating Standby .....                                     | 33 |
| Switching the screen image .....                             | 34 |
| Viewing battery charge information .....                     | 34 |
| Decreasing screen brightness .....                           | 34 |
| Increasing screen brightness .....                           | 34 |
| Activating the ambient light sensor .....                    | 34 |
| Using HP QuickLook .....                                     | 35 |
| Using keypads .....  | 35 |
| Using the embedded numeric keypad .....                      | 36 |
| Enabling and disabling the embedded numeric keypad .....     | 36 |
| Switching key functions on the embedded numeric keypad ..... | 36 |
| Using an optional external numeric keypad .....              | 36 |
| Cleaning the TouchPad, keyboard, and vents .....             | 37 |

### 4 Multimedia

|                            |    |
|----------------------------|----|
| Multimedia features .....  | 38 |
| Adjusting the volume ..... | 38 |
| Multimedia software .....  | 39 |

|   |    |
|---|----|
| Accessing your preinstalled multimedia software .....                             | 39 |
| Installing multimedia software from a disc .....                                  | 40 |
| Audio .....   | 41 |
| Connecting external audio devices .....   | 41 |
| Checking your audio functions .....   | 41 |
| Video .....   | 43 |
| Connecting an external monitor or projector .....                                 | 43 |
| Using the external monitor port .....   | 43 |
| Using the DisplayPort .....   | 43 |
| Optical drive (select models only) .....  | 45 |
| Identifying the optical drive .....   | 45 |
| Using optical discs (CDs, DVDs, and BDs) .....                                    | 45 |
| Selecting the right disc (CDs, DVDs, and BDs) .....                               | 46 |
| CD-R discs .....  | 46 |
| CD-RW discs .....   | 46 |
| DVD±R discs .....   | 46 |
| DVD±RW discs .....  | 46 |
| LightScribe DVD+R discs .....   | 47 |
| Blu-ray Discs (BDs) .....   | 47 |
| Playing a CD, DVD, or BD .....  | 47 |
| Configuring AutoPlay .....  | 48 |
| Changing DVD region settings .....  | 48 |
| Observing the copyright warning .....   | 49 |
| Copying a CD, DVD, or BD .....  | 49 |
| Creating (burning) a CD, DVD, or BD .....   | 50 |
| Removing an optical disc (CD, DVD, or BD) .....                                   | 50 |
| Troubleshooting .....   | 51 |
| The optical disc tray does not open for removal of a CD, DVD, or BD .....         | 51 |
| The computer does not detect the optical drive .....                              | 52 |
| A disc does not play .....  | 52 |
| A disc does not play automatically .....  | 53 |
| A movie stops, skips, or plays erratically .....                                  | 53 |
| A movie is not visible on an external display .....                               | 54 |
| The process of burning a disc does not begin, or it stops before completion ..... | 54 |
| A device driver must be reinstalled .....   | 54 |
| Obtaining the latest HP device drivers .....                                      | 54 |
| Obtaining Microsoft device drivers .....  | 55 |
| Webcam (select models only) .....   | 56 |
| Adjusting webcam properties .....   | 56 |
| Capturing business card images .....  | 57 |

## 5 Power management

|                             |    |
|-----------------------------|----|
| Setting power options ..... | 59 |
|-----------------------------|----|

|   |    |
|---|----|
| Using power-saving states .....   | 59 |
| Initiating and exiting Standby .....  | 59 |
| Initiating and exiting Hibernation .....                                      | 60 |
| Using the Power Meter .....   | 60 |
| Using power schemes .....   | 61 |
| Viewing the current scheme .....  | 61 |
| Selecting a different power scheme .....                                      | 61 |
| Customizing power schemes .....   | 62 |
| Setting password protection upon exiting Standby .....                        | 62 |
| Using Power Assistant (select models only) .....                              | 63 |
| Starting Power Assistant .....  | 63 |
| Using external AC power .....   | 63 |
| Connecting the AC adapter .....   | 64 |
| Using battery power .....   | 64 |
| Displaying the remaining battery charge .....                                 | 65 |
| Inserting or removing the battery .....                                       | 65 |
| Charging a battery .....  | 66 |
| Maximizing battery discharge time .....                                       | 67 |
| Managing low battery levels .....   | 67 |
| Identifying low battery levels .....  | 67 |
| Resolving a low battery level .....   | 68 |
| Resolving a low battery level when external power is available .....          | 68 |
| Resolving a low battery level when a charged battery is available .....       | 68 |
| Resolving a low battery level when no power source is available .....         | 68 |
| Resolving a low battery level when the computer cannot exit Hibernation ..... | 68 |
| Calibrating a battery .....   | 68 |
| Step 1: Fully charge the battery .....  | 69 |
| Step 2: Disable Hibernation and Standby .....                                 | 69 |
| Step 3: Discharge the battery .....   | 69 |
| Step 4: Fully recharge the battery .....                                      | 70 |
| Step 5: Reenable Hibernation and Standby .....                                | 70 |
| Conserving battery power .....  | 70 |
| Storing a battery .....   | 70 |
| Disposing of a used battery .....   | 71 |
| Replacing the battery .....   | 71 |
| Testing an AC adapter .....   | 72 |
| Shutting down the computer .....  | 72 |

## 6 Drives

|                                    |    |
|------------------------------------|----|
| Identifying installed drives ..... | 74 |
| Handling drives .....              | 74 |



|  |    |
|--|----|
| Improving hard drive performance .....             | 76 |
| Using Disk Defragmenter .....                      | 76 |
| Using Disk Cleanup .....                           | 76 |
| Using HP 3D DriveGuard .....                       | 77 |
| Identifying HP 3D DriveGuard status .....          | 77 |
| Using HP 3D DriveGuard software .....              | 77 |
| Replacing a hard drive in the hard drive bay ..... | 79 |
| Replacing a drive in the upgrade bay .....         | 82 |
| Removing the protective insert .....               | 82 |
| Replacing a hard drive .....                       | 82 |
| Replacing an optical drive .....                   | 85 |

## 7 External devices

|   |    |
|---|----|
| Using a USB device .....                  | 88 |
| Connecting a USB device .....             | 88 |
| Stopping and removing a USB device .....  | 89 |
| Using USB legacy support .....            | 89 |
| Using a 1394 device .....                 | 90 |
| Connecting a 1394 device .....            | 90 |
| Stopping and removing a 1394 device ..... | 90 |
| Using external drives .....               | 92 |
| Using optional external devices .....     | 92 |
| Using a docking device .....              | 93 |

## 8 External media cards

|   |    |
|---|----|
| Using SD Card Reader cards .....              | 94 |
| Inserting a digital card .....                | 94 |
| Stopping and removing a digital card .....    | 95 |
| Using ExpressCards (select models only) ..... | 95 |
| Configuring an ExpressCard .....              | 95 |
| Inserting an ExpressCard .....                | 95 |
| Stopping and removing an ExpressCard .....    | 97 |
| Using smart cards (select models only) .....  | 97 |
| Inserting a smart card .....                  | 98 |
| Removing a smart card .....                   | 98 |

## 9 Memory modules

|   |     |
|---|-----|
| Adding or replacing a memory module in the expansion memory module slot ..... | 100 |
| Upgrading a memory module in the primary memory module slot .....             | 103 |
| Increasing the hard drive space for the Hibernation file .....                | 107 |

## 10 Security

|                               |     |
|-------------------------------|-----|
| Protecting the computer ..... | 108 |
|-------------------------------|-----|

|   |     |
|---|-----|
| Using passwords .....   | 109 |
| Setting passwords in Windows .....                                | 109 |
| Setting passwords in Computer Setup .....                         | 109 |
| BIOS administrator password .....                                 | 110 |
| Managing a BIOS administrator password .....                      | 110 |
| Entering a BIOS administrator password .....                      | 111 |
| Using Computer Setup DriveLock .....                              | 112 |
| Setting a DriveLock password .....                                | 112 |
| Entering a DriveLock password .....                               | 113 |
| Changing a DriveLock password .....                               | 113 |
| Removing DriveLock protection .....                               | 114 |
| Using Computer Setup Auto DriveLock .....                         | 114 |
| Entering an Automatic DriveLock password .....                    | 114 |
| Removing Automatic DriveLock protection .....                     | 115 |
| Using Computer Setup security features .....                      | 116 |
| Securing system devices .....                                     | 116 |
| Viewing Computer Setup System Information .....                   | 116 |
| Using Computer Setup System IDs .....                             | 117 |
| Using antivirus software .....                                    | 118 |
| Using firewall software .....                                     | 119 |
| Installing critical security updates .....                        | 120 |
| Using HP ProtectTools Security Manager (select models only) ..... | 121 |
| Installing a security cable .....                                 | 122 |

## 11 Software updates

|                                      |     |
|--------------------------------------|-----|
| Updating software .....              | 123 |
| Updating the BIOS .....              | 124 |
| Determining the BIOS version .....   | 124 |
| Downloading a BIOS update .....      | 124 |
| Updating programs and drivers .....  | 125 |
| Using SoftPaq Download Manager ..... | 126 |

## 12 Backup and recovery

|  |     |
|--|-----|
| Backing up your information .....                  | 128 |
| Performing a recovery .....                        | 129 |
| Recovering your information .....                  | 129 |
| Recovering the operating system and programs ..... | 129 |

## 13 Computer Setup

|  |     |
|--|-----|
| Starting Computer Setup .....                      | 130 |
| Using Computer Setup .....                         | 130 |
| Navigating and selecting in Computer Setup .....   | 130 |
| Restoring factory settings in Computer Setup ..... | 131 |

|  |            |
|--|------------|
| Computer Setup menus .....                       | 131        |
| File menu .....                                  | 132        |
| Security menu .....                              | 132        |
| System Configuration menu .....                  | 133        |
| <br>   |            |
| <b>14 MultiBoot</b>                              |            |
| About the boot device order .....                | 137        |
| Enabling boot devices in Computer Setup .....    | 139        |
| Considering boot order changes .....             | 140        |
| Choosing MultiBoot preferences .....             | 141        |
| Setting a new boot order in Computer Setup ..... | 141        |
| Dynamically choosing a boot device .....         | 141        |
| Setting a MultiBoot Express prompt .....         | 142        |
| Entering MultiBoot Express preferences .....     | 142        |
| <br>   |            |
| <b>15 Management and Printing</b>                |            |
| Using Client Management Solutions .....          | 143        |
| Configuring and deploying a software image ..... | 143        |
| Managing and updating software .....             | 144        |
| HP Client Automation (select models only) .....  | 144        |
| HP SSM (System Software Manager) .....           | 144        |
| <br>   |            |
| <b>Index .....</b>                               | <b>145</b> |



# 1 Features

## Identifying hardware

Components included with the computer may vary by region and model. The illustrations in this chapter identify the standard features on most computer models.

To see a list of hardware installed in the computer:

1. Select **Start > My Computer**.
2. In the left pane of the System Tasks window, click **View system information**.
3. Select **Hardware** tab > **Device Manager**.

You can also add hardware or modify device configurations using Device Manager.

## Top components

### Pointing devices



| Component          | Description   |
|--------------------|---|
| (1) Pointing stick | Moves the pointer and selects or activates items on the screen. |

| Component                       | Description   |
|---------------------------------|---|
| (2) Left pointing stick button  | Functions like the left button on an external mouse.            |
| (3) TouchPad*                   | Moves the pointer and selects or activates items on the screen. |
| (4) Left TouchPad button*       | Functions like the left button on an external mouse.            |
| (5) Right pointing stick button | Functions like the right button on an external mouse.           |
| (6) TouchPad scroll zone*       | Scrolls up or down.   |
| (7) Right TouchPad button*      | Functions like the right button on an external mouse.           |

\*This table describes factory settings. To view or change pointing device preferences, select **Start > Control Panel > Printers and Other Hardware > Mouse**.

## Lights

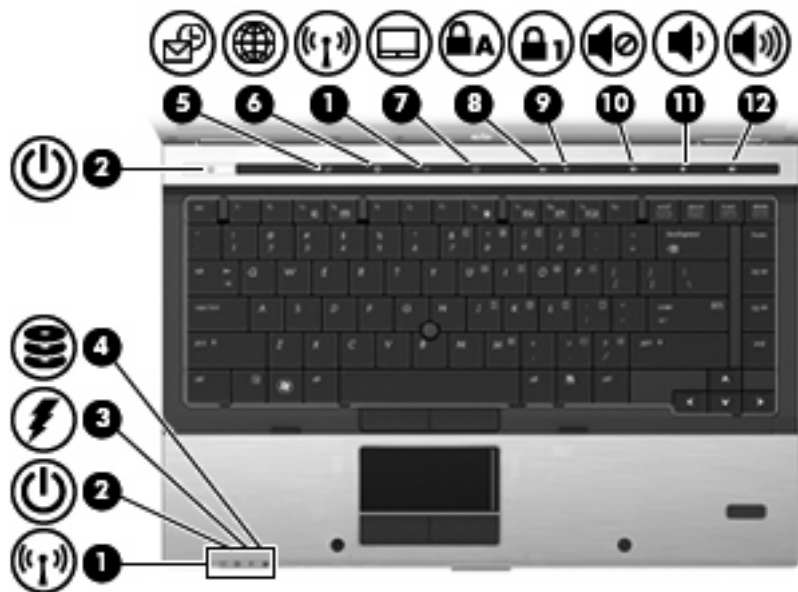

| Component                | Description  |
|--------------------------|--|
| (1) Wireless lights (2)* | <ul style="list-style-type: none"> <li>Blue: An integrated wireless device, such as a wireless local area network (WLAN) device, the HP Mobile Broadband Module, and/or a Bluetooth® device, is on.</li> <li>Amber: All wireless devices are off.</li> </ul>                     |
| (2) Power lights (2)†    | <ul style="list-style-type: none"> <li>On: The computer is on.</li> <li>Blinking: The computer is in the Standby state.</li> <li>Blinking rapidly: An AC adapter with a higher power rating should be connected.</li> <li>Off: The computer is off or in Hibernation.</li> </ul> |

| Component              | Description  |
|------------------------|--|
| (3) Battery light      | <ul style="list-style-type: none"> <li>• Amber: A battery is charging.</li> <li>• Turquoise: A battery is close to full charge capacity.</li> <li>• Blinking amber: A battery that is the only available power source has reached a low battery level. When the battery reaches a critical battery level, the battery light begins blinking rapidly.</li> <li>• Off: If the computer is plugged into an external power source, the light turns off when all batteries in the computer are fully charged. If the computer is not plugged into an external power source, the light stays off until the battery reaches a low battery level.</li> </ul> |
| (4) Drive light        | <ul style="list-style-type: none"> <li>• Blinking turquoise: The hard drive or optical drive is being accessed.</li> <li>• Amber: HP 3D DriveGuard has temporarily parked the internal hard drive, and if present, the hard drive in the upgrade bay.</li> </ul>   |
| (5) QuickLook light    | <ul style="list-style-type: none"> <li>• On: The computer is on.</li> <li>• Off: The computer is off or in the Standby or Hibernation state.</li> </ul>  |
| (6) QuickWeb light     | On: Web browser is in use.   |
| (7) TouchPad light     | <ul style="list-style-type: none"> <li>• Turquoise: The TouchPad is on.</li> <li>• Amber: The TouchPad is off.</li> </ul>  |
| (8) Caps lock light    | On: Caps lock is on.   |
| (9) Num lock light     | On: Num lock is on or the embedded numeric keypad is enabled.  |
| (10) Volume mute light | <ul style="list-style-type: none"> <li>• Turquoise: Speaker sound is on.</li> <li>• Amber: Speaker sound is off.</li> </ul>  |
| (11) Volume down light | Blinking: The volume down button is being used to decrease the speaker volume.   |
| (12) Volume up light   | Blinking: The volume up button is being used to increase the speaker volume.   |

\*The 2 wireless lights display the same information. The light on the wireless button is visible only when the computer is open. The wireless light on the front of the computer is visible whether the computer is open or closed.

†The 2 power lights display the same information. The light on the power button is visible only when the computer is open. The power light on the front of the computer is visible whether the computer is open or closed.

## Buttons, switches, and fingerprint reader



| Component                   | Description  |
|-----------------------------|--|
| (1) Power button            | <ul style="list-style-type: none"> <li>When the computer is off, press the button to turn on the computer.</li> <li>When the computer is on, press the button to shut down the computer.</li> <li>When the computer is in the Standby state, press the button briefly to exit Standby.</li> <li>When the computer is in Hibernation, press the button briefly to exit Hibernation.</li> </ul> <p>If the computer has stopped responding and Windows® shutdown procedures are ineffective, press and hold the power button for at least 5 seconds to turn off the computer.</p> <p>To learn more about your power settings, select <b>Start &gt; Control Panel &gt; Performance and Maintenance &gt; Power Options</b>.</p> |
| (2) Internal display switch | <p>Turns off the display and initiates Standby if the display is closed while the power is on.</p> <p><b>NOTE:</b> The internal display switch is not visible from the outside of the computer.</p>  |
| (3) QuickLook button        | <ul style="list-style-type: none"> <li>When the computer is off, press the button to open HP QuickLook.</li> <li>When the computer is on, press the button to open Software Setup.</li> </ul> <p><b>NOTE:</b> If Software Setup is not available, the default Web browser opens.</p>   |



| Component                                    | Description   |
|--|---|
| (4) QuickWeb button                          | <ul style="list-style-type: none"> <li>When the computer is off, press the button to open HP QuickWeb.</li> <li>When the computer is on, press the button to open the default Web browser.</li> </ul> |
| (5) Wireless button                          | <p>Turns the wireless feature on or off but does not establish a wireless connection.</p> <p><b>NOTE:</b> A wireless network must be set up in order to establish a wireless connection.</p>          |
| (6) TouchPad button                          | Turns the TouchPad on or off.   |
| (7) Caps lock button                         | Turns caps lock on or off.  |
| (8) Num lock button                          | Turns num lock on or off.   |
| (9) Volume mute button                       | Mutes and restores speaker sound.   |
| (10) Volume down button                      | Decreases speaker volume.   |
| (11) Volume up button                        | Increases speaker volume.   |
| (12) Fingerprint reader (select models only) | Allows a fingerprint logon to Windows, instead of a password logon.   |

## Keys

 **NOTE:** Your computer may look slightly different from the illustration in this section.

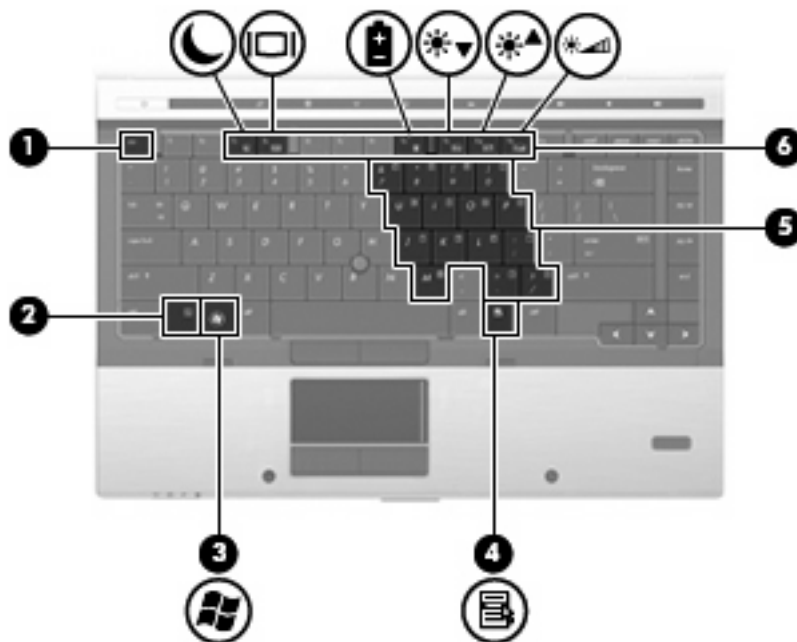

| Component                | Description   |
|--------------------------|---|
| (1) <code>esc</code> key | Displays system information when pressed in combination with the <code>fn</code> key. |

| Component                        | Description  |
|----------------------------------|--|
| (2) <b>fn</b> key                | Executes frequently used system functions when pressed in combination with a function key or the <b>esc</b> key. |
| (3) Windows logo key             | Displays the Windows Start menu.   |
| (4) Windows applications key     | Displays a shortcut menu for items beneath the pointer.  |
| (5) Embedded numeric keypad keys | Can be used like the keys on an external numeric keypad.   |
| (6) Function keys                | Execute frequently used system functions when pressed in combination with the <b>fn</b> key.                     |

## Front components

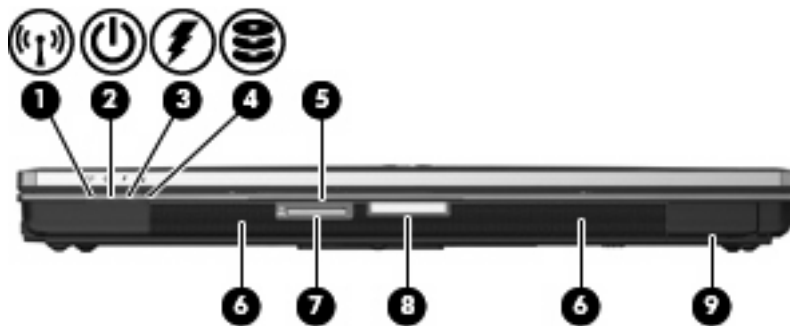

| Component          | Description  |
|--------------------|--|
| (1) Wireless light | <ul style="list-style-type: none"> <li>Blue: An integrated wireless device, such as a wireless local area network (WLAN) device, the HP Mobile Broadband Module, and/or a Bluetooth device, is on.</li> <li>Amber: All wireless devices are off.</li> </ul>  |
| (2) Power light    | <ul style="list-style-type: none"> <li>On: The computer is on.</li> <li>Blinking: The computer is in the Standby state.</li> <li>Blinking rapidly: An AC adapter with a higher power rating should be connected.</li> <li>Off: The computer is off or in Hibernation.</li> </ul>   |
| (3) Battery light  | <ul style="list-style-type: none"> <li>Amber: A battery is charging.</li> <li>Turquoise: A battery is close to full charge capacity.</li> <li>Blinking amber: A battery that is the only available power source has reached a low battery level. When the battery reaches a critical battery level, the battery light begins blinking rapidly.</li> <li>Off: If the computer is plugged into an external power source, the light turns off when all batteries in the computer are fully charged. If the computer is not plugged into an external power source, the light stays off until the battery reaches a low battery level.</li> </ul> |

| Component                                      | Description  |
|--|--|
| (4) Drive light                                | <ul style="list-style-type: none"> <li>Blinking turquoise: The hard drive or optical drive is being accessed.</li> <li>Amber: HP 3D DriveGuard has temporarily parked the internal hard drive, and if present, the hard drive in the upgrade bay.</li> </ul> |
| (5) Business card slot                         | Holds a business card in position so that the webcam (select models only) can capture an image.  |
| (6) SD Card Reader                             | Supports the Secure Digital (SD) Memory Card and MultiMediaCard (MMC) optional digital card formats.   |
| (7) Display release button                     | Opens the computer.  |
| (8) Speakers (2)                               | Produce sound.   |
| (9) Bluetooth compartment (select models only) | Contains a Bluetooth device.   |

## Rear components



| Component                 | Description   |
|---------------------------|---|
| (1) Security cable slot   | Attaches an optional security cable to the computer.<br><b>NOTE:</b> The security cable is designed to act as a deterrent, but it may not prevent the computer from being mishandled or stolen. |
| (2) Power connector       | Connects an AC adapter.   |
| (3) DisplayPort           | Connects an optional digital display device such as a high-performance monitor or projector.  |
| (4) External monitor port | Connects an external VGA monitor or projector.  |

## Right-side components

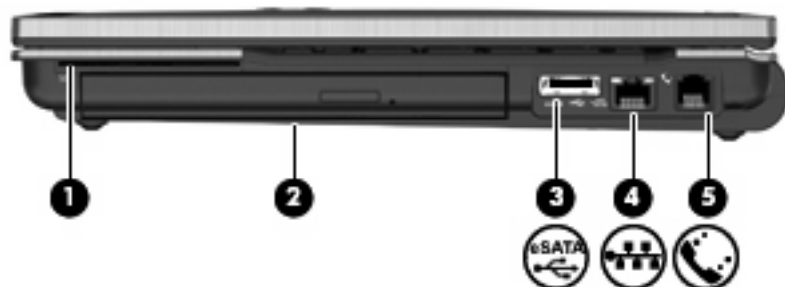

| Component                                   | Description                                    |
|---|--|
| (1) Smart card reader                       | Supports optional smart cards and Java™ cards. |
| (2) Upgrade bay                             | Supports an optical drive or a hard drive.     |
| (3) eSATA/USB port                          | Connects an eSATA device or a USB device.      |
| (4) RJ-45 (network) jack                    | Connects a network cable.                      |
| (5) RJ-11 (modem) jack (select models only) | Connects a modem cable.                        |

## Left-side components

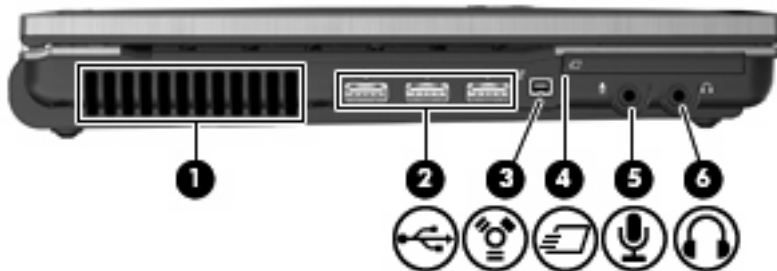

| Component                      | Description  |
|--------------------------------|--|
| (1) Vent                       | Enables airflow to cool internal components.<br><br><b>NOTE:</b> The computer fan starts up automatically to cool internal components and prevent overheating. It is normal for the internal fan to cycle on and off during routine operation. |
| (2) USB ports (3)              | Connect optional USB devices.  |
| (3) 1394 port                  | Connects an optional IEEE 1394 or 1394a device, such as a camcorder.   |
| (4) ExpressCard slot           | Supports optional ExpressCards.  |
| (5) Audio-in (microphone) jack | Connects an optional computer headset microphone, stereo array microphone, or monaural microphone.   |
| (6) Audio-out (headphone) jack | Produces sound when connected to optional powered stereo speakers, headphones, ear buds, a headset, or television audio.<br><br><b>NOTE:</b> When a device is connected to the headphone jack, the computer speakers are disabled.             |

## Bottom components

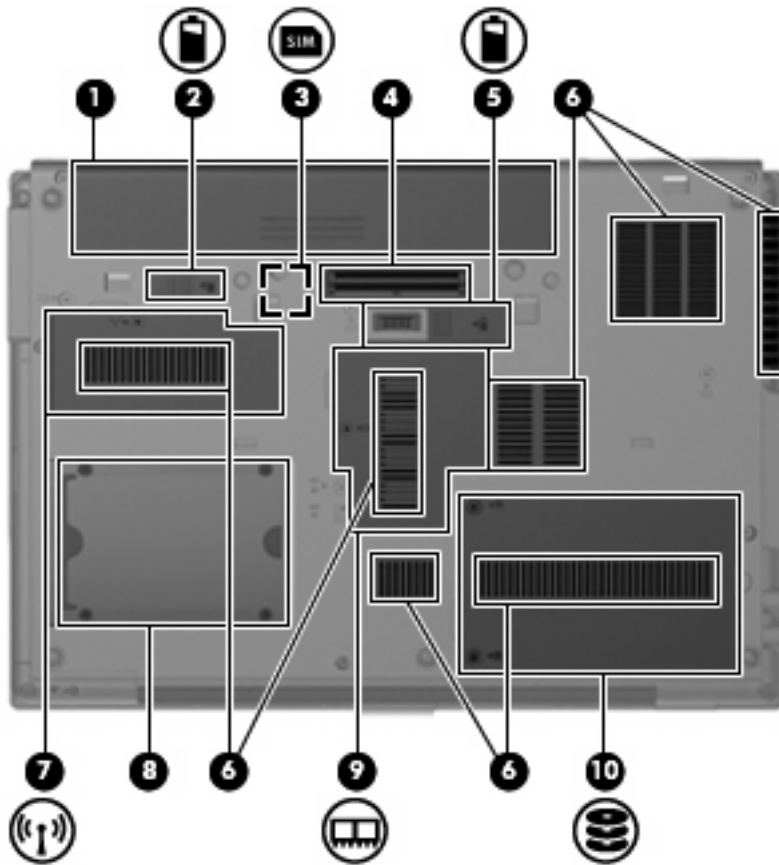

| Component                         | Description  |
|-----------------------------------|--|
| (1) Battery bay                   | Holds the battery.   |
| (2) Battery release latch         | Releases the battery from the battery bay.   |
| (3) SIM slot (select models only) | Contains a wireless subscriber identity module (SIM). The SIM slot is located inside the battery bay.  |
| (4) Docking connector             | Connects an optional docking device.   |
| (5) Accessory battery connector   | Connects an optional accessory battery.  |
| (6) Vents (7)                     | Enable airflow to cool internal components.  |
| (7) WWAN/WLAN module compartment  | Contains a WWAN module and a WLAN module (select models only).   |
|                                   | <p><b>NOTE:</b> The computer fan starts up automatically to cool internal components and prevent overheating. It is normal for the internal fan to cycle on and off during routine operation.</p> <p><b>CAUTION:</b> To prevent an unresponsive system, replace the wireless module only with a wireless module authorized for use in the computer by the governmental agency that regulates wireless devices in your country or region. If you replace the module and then receive a warning message, remove the module to restore computer functionality, and then contact technical support through Help and Support.</p> |

| Component                     | Description                                |
|-------------------------------|--|
| (8) Business card holder      | Holds a business card.                     |
| (9) Memory module compartment | Contains the expansion memory module slot. |
| (10) Hard drive bay           | Holds the hard drive.                      |

## Display components

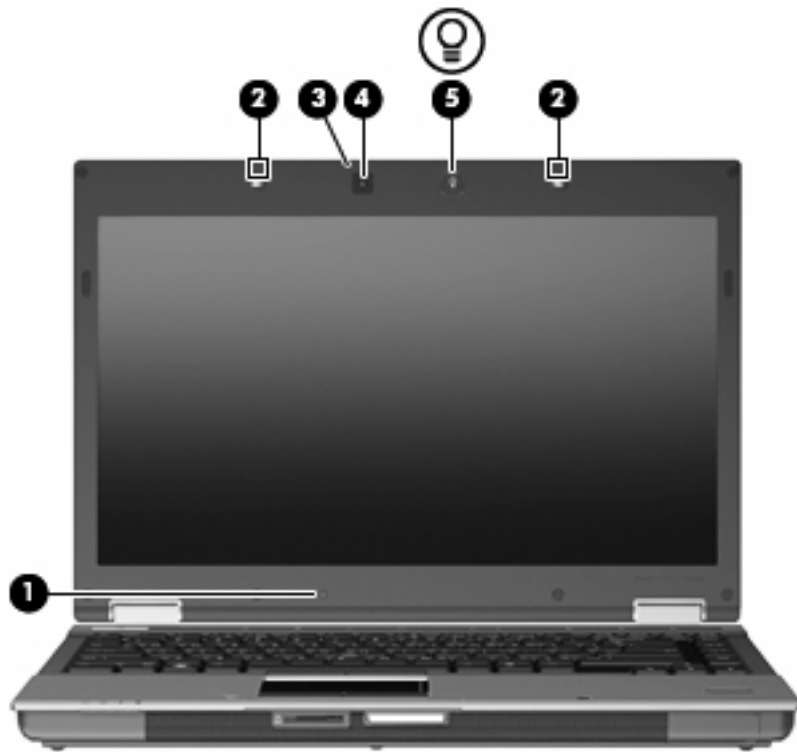

| Component                             | Description  |
|---------------------------------------|--|
| (1) Internal display switch           | Turns off the display and initiates Standby if the display is closed while the power is on.<br><b>NOTE:</b> The internal display switch is not visible from the outside of the computer. |
| (2) Internal microphones (2)          | Record sound.<br><b>NOTE:</b> If there is a microphone icon next to each microphone opening, your computer has internal microphones.   |
| (3) Webcam light (select models only) | On: The webcam is in use.  |
| (4) Webcam (select models only)       | Records audio and video and captures still photographs.  |
| (5) Keyboard light button             | Opens and turns the keyboard light on or off.  |

## Wireless antennas (select models only)

On select computer models, at least 2 antennas send and receive signals from one or more wireless devices. These antennas are not visible from the outside of the computer.

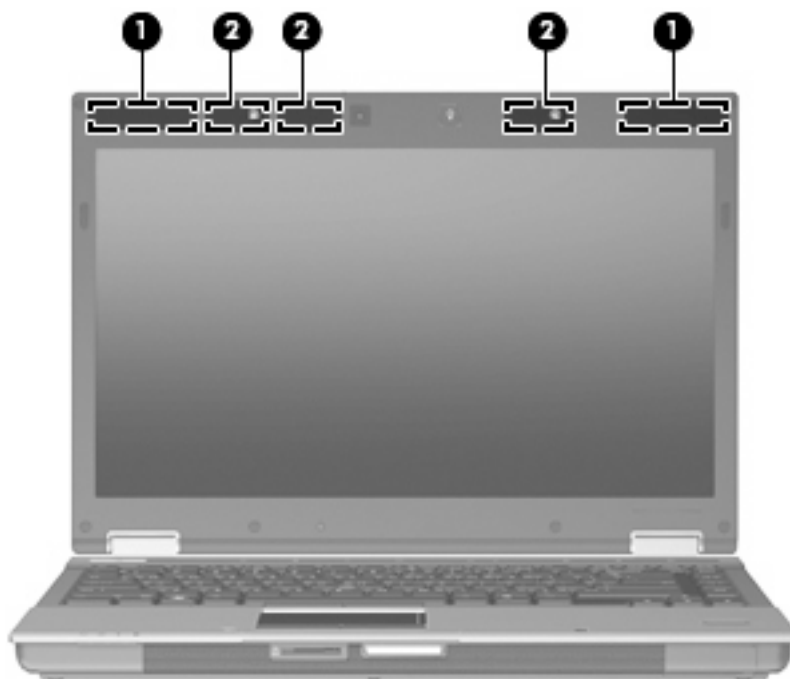

| Component                                   | Description   |
|---|---|
| (1) WWAN antennas (2)* (select models only) | Send and receive wireless signals to communicate with wireless wide-area networks (WWANs).  |
| (2) WLAN antennas (3)* (select models only) | Send and receive wireless signals to communicate with wireless local area networks (WLANs). |

\*The antennas are not visible from the outside of the computer. For optimal transmission, keep the areas immediately around the antennas free from obstructions.

To see wireless regulatory notices, refer to the section of the *Regulatory, Safety and Environmental Notices* that applies to your country or region. These notices are located in Help and Support.

## Additional hardware components



| Component       | Description   |
|-----------------|---|
| (1) Power cord* | Connects an AC adapter to an AC outlet.                                   |
| (2) AC adapter  | Converts AC power to DC power.  |
| (3) Battery*    | Powers the computer when the computer is not plugged into external power. |

\*Batteries and power cords vary in appearance by country or region.

## Identifying the labels

The labels affixed to the computer provide information you may need when you troubleshoot system problems or travel internationally with the computer.

- Service tag—Provides important information, including the following:



- Product name (1). This is the product name affixed to the front of the computer.
- Serial number (s/n) (2). This is an alphanumeric identifier that is unique to each product.
- Part number/Product number (p/n) (3). This number provides specific information about the product's hardware components. The part number helps a service technician to determine what components and parts are needed.
- Model description (4). This is an alphanumeric identifier used to locate documents, drivers, and support for the computer.
- Warranty period (5). This number describes the duration (in years) of the warranty period for the computer.



Have this information available when you contact technical support. The service tag label is located inside the battery bay.

- Microsoft® Certificate of Authenticity—Contains the Windows Product Key. You may need the Product Key to update or troubleshoot the operating system. This certificate is affixed to the bottom of the computer.
- Regulatory label—Provides regulatory information about the computer. The regulatory label is affixed inside the battery bay.
- Modem approval label—Provides regulatory information about the modem and lists the agency approval markings required by some of the countries or regions in which the modem has been approved for use. You may need this information when traveling internationally. The modem approval label is affixed inside the battery bay.
- Wireless certification label(s) (select models only)—Provide information about optional wireless devices and the approval markings of some of the countries or regions in which the devices have been approved for use. An optional device may be a wireless local area network (WLAN) device, an HP Mobile Broadband Module, or an optional Bluetooth® device. If your computer model includes one or more wireless devices, one or more certification labels are included with your computer. You may need this information when traveling internationally. Wireless certification labels are affixed to the bottom of the computer and/or inside the battery bay.
- SIM (subscriber identity module) label (select models only)—Provides the ICCID (Integrated Circuit Card Identifier) of your SIM. This label is affixed to the outside packaging of the SIM (select models only) included in the box with the computer.
- HP Mobile Broadband Module serial number label (select models only)—Provides the serial number of your HP Mobile Broadband Module. This label is affixed to the bottom of the computer.

---

## 2 Wireless, modem, and local area network

### Using wireless devices (select models only)

Wireless technology transfers data across radio waves instead of wires. Your computer may be equipped with one or more of the following wireless devices:

- Wireless local area network (WLAN) device—Connects the computer to wireless local area networks (commonly referred to as Wi-Fi networks, wireless LANs, or WLANs) in corporate offices, your home, and public places such as airports, restaurants, coffee shops, hotels, and universities. In a WLAN, each mobile wireless device communicates with a wireless router or a wireless access point.
- HP Mobile Broadband Module—A wireless wide area network (WWAN) device that provides access to information wherever mobile network operator service is available. In a WWAN, each mobile device communicates to a mobile network operator's base station. Mobile network operators install networks of base stations (similar to cell phone towers) throughout large geographic areas, effectively providing coverage across entire states, regions, or even countries.
- Bluetooth® device (select models only)—Creates a personal area network (PAN) to connect to other Bluetooth-enabled devices such as computers, phones, printers, headsets, speakers, and cameras. In a PAN, each device communicates directly with other devices, and devices must be relatively close together—typically within 10 meters (approximately 33 feet) of each other.

Computers with WLAN devices support one or more of the following IEEE industry standards:

- 802.11b, the first popular standard, supports data rates of up to 11 Mbps and operates at a frequency of 2.4 GHz.
- 802.11g supports data rates of up to 54 Mbps and operates at a frequency of 2.4 GHz. An 802.11g WLAN device is backward compatible with 802.11b devices, so they can operate on the same network.
- 802.11a supports data rates of up to 54 Mbps and operates at a frequency of 5 GHz.



---





**NOTE:** 802.11a is not compatible with 802.11b and 802.11g.

---

- 802.11n supports data rates of up to 450 Mbps and may operate at 2.4 GHz or 5 GHz, making it backward compatible with 802.11a, b, and g (depending on your network configuration).

For more information on wireless technology, refer to the information and Web site links provided in Help and Support.

## Identifying wireless and network icons

| Icon  | Name                    | Description   |
|---|-------------------------|---|
|  | Wireless (connected)    | Identifies the location of the wireless lights and the wireless buttons on the computer. Also identifies the Wireless Assistant software on the computer and indicates that one or more of the wireless devices are on.                                     |
|  | Wireless (disconnected) | Indicates that all of the wireless devices are off.   |
|  | HP Connection Manager   | Opens HP Connection Manager, which enables you to create a connection with an HP Mobile Broadband device (select models only).  |
|  | Network (connected)     | Indicates that one or more of your network drivers are installed, one or more network devices are connected to a wireless network, and one or more network devices may be connected to a wired network.   |
|  | Network (disconnected)  | Indicates that one or more of your network drivers are installed, no wireless connections are available or all wireless network devices are disabled by the wireless button or Wireless Assistant, and no network devices are connected to a wired network. |

## Using the wireless controls

You can control the wireless devices in your computer using these features:

- Wireless button
- Wireless Assistant software (select models only)
- HP Connection Manager software (select models only)
- Operating system controls

## Using the wireless button

The computer has a wireless button, one or more wireless devices, and two wireless lights. All of the wireless devices on your computer are enabled at the factory, so the wireless light is on (blue) when you turn on the computer.

The wireless light indicates the overall power state of your wireless devices, not the status of individual devices. If the wireless light is blue, at least one wireless device is on. If the wireless light is amber, all wireless devices are off.

Because the wireless devices are enabled at the factory, you can use the wireless button to turn on or turn off the wireless devices simultaneously. Individual wireless devices can be controlled through Wireless Assistant software (select models only) or through Computer Setup.

 **NOTE:** If the wireless devices are disabled by Computer Setup, the wireless button will not work until you reenable your devices.

## Using Wireless Assistant software (select models only)

A wireless device can be turned on or off using the Wireless Assistant software. If a wireless device is disabled by Computer Setup, it must be reenabled by Computer Setup before it can be turned on or off using Wireless Assistant.

---

 **NOTE:** Enabling or turning on a wireless device does not automatically connect the computer to a network or a Bluetooth-enabled device.

---

To view the state of the wireless devices, follow either of these steps:

Position the cursor over the wireless icon in the notification area, at the far right of the taskbar.

– or –

Open Wireless Assistant by double-clicking the icon in the notification area.

For more information, refer to the Wireless Assistant software Help:

1. Open Wireless Assistant by double-clicking the icon in the notification area.
2. Click the **Help** button.

## Using HP Connection Manager (select models only)

You can use HP Connection Manager to connect to WWANs using the HP Mobile Broadband device in your computer (select models only).

- ▲ To start Connection Manager, click the **Connection Manager** icon in the notification area, at the far right of the taskbar.

– or –

Select **Start > All Programs > HP > HP Connection Manager**.

For more details about using Connection Manager, refer to the Connection Manager software Help.

## Using operating system controls

Some operating systems also offer a way to manage integrated wireless devices and the wireless connection. For example, Windows® Network Connections allows you to set up a connection, connect to a network, manage wireless networks, and diagnose and repair connections.

- ▲ To access Network Connections, select **Start > Control Panel > Network and Internet Connections > Network Connections**.

For more information, refer to Help and Support. Select **Start > Help and Support**.

## Using a WLAN device (select models only)

With a WLAN device, you can access a wireless local area network (WLAN), which is composed of other computers and accessories that are linked by a wireless router or a wireless access point.

 **NOTE:** The terms *wireless router* and *wireless access point* are often used interchangeably.

- A large-scale WLAN, such as a corporate or public WLAN, typically uses wireless access points that can accommodate a large number of computers and accessories and can separate critical network functions.
- A home or small office WLAN typically uses a wireless router, which allows several wireless and wired computers to share an Internet connection, a printer, and files without requiring additional pieces of hardware or software.

 **NOTE:** To use the WLAN device in your computer, you must connect to a WLAN infrastructure (provided through a service provider or a public or corporate network).

## Setting up a WLAN

To set up a WLAN and connect to the Internet, you need the following equipment:

- A broadband modem (either DSL or cable) **(1)** and high-speed Internet service purchased from an Internet service provider (ISP)
- A wireless router (purchased separately) **(2)**
- The wireless computer **(3)**

The following illustration shows an example of a wireless network installation that is connected to the Internet.



As your network grows, additional wireless and wired computers can be connected to the network to access the Internet.

For help in setting up your WLAN, refer to the information provided by your router manufacturer or your ISP.

## Protecting your WLAN

Because the WLAN standard was designed with only limited security capabilities—basically to foil casual eavesdropping rather than more powerful forms of attack—it is essential to understand that WLANs are vulnerable to well-known and well-documented security weaknesses.

WLANs in public areas, or “hotspots,” like coffee shops and airports may not provide any security. New technologies are being developed by wireless manufacturers and hotspot service providers that make the public environment more secure and anonymous. If you are concerned about the security of your computer in a hotspot, limit your network activities to noncritical e-mail and basic Internet surfing.

When you set up a WLAN or access an existing WLAN, always enable security features to protect your network from unauthorized access. The common security levels are Wi-Fi Protected Access (WPA) and Wired Equivalent Privacy (WEP). Because wireless radio signals travel outside the network, other WLAN devices can pick up unprotected signals and either connect to your network (uninvited) or capture information being sent across it. However, you can take precautions to protect your WLAN:

- **Use a wireless transmitter with built-in security.**

Many wireless base stations, gateways, and routers provide built-in security features such as wireless security protocols and firewalls. With the correct wireless transmitter, you can protect your network from the most common wireless security risks.

- **Work behind a firewall.**

A firewall is a barrier that checks both data and requests for data that are sent to your network and then discards any suspicious items. Firewalls are available in many varieties, both software and hardware. Some networks use a combination of both types.

- **Use wireless encryption.**

A variety of sophisticated encryption protocols is available for your WLAN. Find the solution that works best for your network security:

- **Wired Equivalent Privacy (WEP)** is a wireless security protocol that uses a WEP key to encode or encrypt all network data before it is transmitted. Usually, you can allow the network to assign the WEP key. Alternatively, you can set up your own key, generate a different key, or choose other advanced options. Without the correct key, others will not be able to use the WLAN.
- **WPA (Wi-Fi Protected Access)**, like WEP, uses security settings to encrypt and decrypt data that is transmitted over the network. However, instead of using one static security key for encryptions as WEP does, WPA uses *temporal key integrity protocol* (TKIP) to dynamically generate a new key for every packet. It also generates different sets of keys for each computer on the network.

- **Close your network.**

If possible, prevent your network name (SSID) from being broadcast by the wireless transmitter. Most networks initially broadcast the name, telling any computer nearby that your network is available. By closing the network, other computers are less likely to know that your network exists.

 **NOTE:** If your network is closed and the SSID is not broadcast, you will need to know or remember the SSID to connect new devices to the network. Write down the SSID and store it in a secure place before closing the network.

## Connecting to a WLAN

To connect to the WLAN, follow these steps:

1. Be sure that the WLAN device is on. If it is on, the wireless light is blue. If the wireless light is amber, press the wireless button.
2. Select **Start > Connect To**.
3. Select your WLAN from the list, and then type the network security key, if required.
  - If the network is unsecured, meaning that anyone can access the network, a warning is displayed. Click **Connect Anyway** to accept the warning and complete the connection.
  - If the network is a security-enabled WLAN, you are prompted to enter a network security key, which is a security code. Type the code, and then click **Connect** to complete the connection.

---

 **NOTE:** If no WLANs are listed, you are out of range of a wireless router or access point.

**NOTE:** If you do not see the network you want to connect to, click **Show all connections**. A list of options will appear that includes creating a new network connection, as well as troubleshooting connection issues.

---

After the connection is made, place the mouse pointer over the network status icon in the notification area, at the far right of the taskbar, to verify the name and status of the connection.

---

 **NOTE:** The functional range (how far your wireless signals travel) depends on WLAN implementation, router manufacturer, and interference from other electronic devices or structural barriers such as walls and floors.

---

More information about using a WLAN is available through the following resources:

- Information from your ISP and the manufacturer's instructions included with your wireless router and other WLAN equipment
- Information and Web site links provided in Help and Support

For a list of public WLANs near you, contact your ISP or search the Web. Web sites that list public WLANs include Cisco Internet Mobile Office Wireless Locations, Hotspotlist, and Geektools. Check with each public WLAN location for cost and connection requirements.

For additional information on connecting your computer to a corporate WLAN, contact your network administrator or IT department.

## Roaming to another network

When you move your computer within range of another WLAN, Windows attempts to connect to that network. If the attempt is successful, your computer is automatically connected to the new network. If Windows does not recognize the new network, follow the same procedure you used initially to connect to your WLAN.

## Using HP Mobile Broadband (select models only)

HP Mobile Broadband enables your computer to use wireless wide area networks (WWANs) to access the Internet from more places and over larger areas than it can by using WLANs. Using HP Mobile Broadband requires a network service provider (called a mobile network operator), which in most cases is a mobile phone network operator. Coverage for HP Mobile Broadband is similar to mobile phone voice coverage.

When used with mobile network operator service, HP Mobile Broadband gives you the freedom to stay connected to the Internet, send e-mail, or connect to your corporate network whether you are on the road or outside the range of Wi-Fi hotspots.

HP supports the following technologies:

- HSPA (High Speed Packet Access), which provides access to networks based on the Global System for Mobile Communications (GSM) telecommunications standard.
- EV-DO (Evolution Data Optimized), which provides access to networks based on the code division multiple access (CDMA) telecommunications standard.

You may need the HP Mobile Broadband Module serial number to activate mobile broadband service. The serial number is printed on a label affixed to the bottom of the computer.

Some mobile network operators require the use of a subscriber identity module (SIM). A SIM contains basic information about you, such as a PIN (personal identification number), as well as network information. Some computers include a SIM that is preinstalled in the battery bay. If the SIM is not preinstalled, it may be provided in the HP Mobile Broadband information provided with your computer or the mobile network operator may provide it separately from the computer.

For information on inserting and removing the SIM, refer to the following “Inserting a SIM” and “Removing a SIM” sections.

For information on HP Mobile Broadband and how to activate service with a preferred mobile network operator, refer to the HP Mobile Broadband information included with your computer. For additional information, see the HP Web site at <http://www.hp.com/go/mobilebroadband> (US only).

## Inserting a SIM (select models only)

- △ **CAUTION:** When inserting a SIM, position the card with the slanted corner as shown in the illustration. If a SIM is inserted backwards or upside down, the battery may not snap into place properly and could damage the SIM and the SIM connector.

---

To prevent damage to the connectors, use minimal force when inserting a SIM.

---

To insert a SIM:

1. Shut down the computer. If you are not sure whether the computer is off or in Hibernation, turn the computer on by pressing the power button. Then shut down the computer through the operating system.
2. Close the display.
3. Disconnect all external devices connected to the computer.
4. Unplug the power cord from the AC outlet.
5. Turn the computer upside down on a flat surface.



6. Remove the battery.
7. Insert the SIM into the SIM slot, and gently push the SIM into the slot until it is firmly seated.

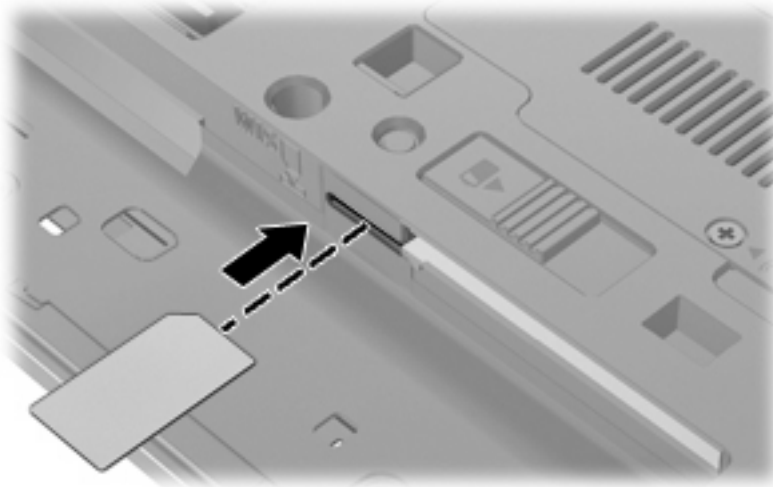

8. Replace the battery.

 **NOTE:** HP Mobile Broadband will be disabled if the battery is not replaced.

---

9. Reconnect external power.
10. Reconnect external devices.
11. Turn on the computer.

## Removing a SIM (select models only)

To remove a SIM:

1. Shut down the computer. If you are not sure whether the computer is off or in Hibernation, turn the computer on by pressing the power button. Then shut down the computer through the operating system.
2. Close the display.
3. Disconnect all external devices connected to the computer.
4. Unplug the power cord from the AC outlet.
5. Turn the computer upside down on a flat surface.
6. Remove the battery.

7. Press in on the SIM (1), and then remove it from the slot (2).

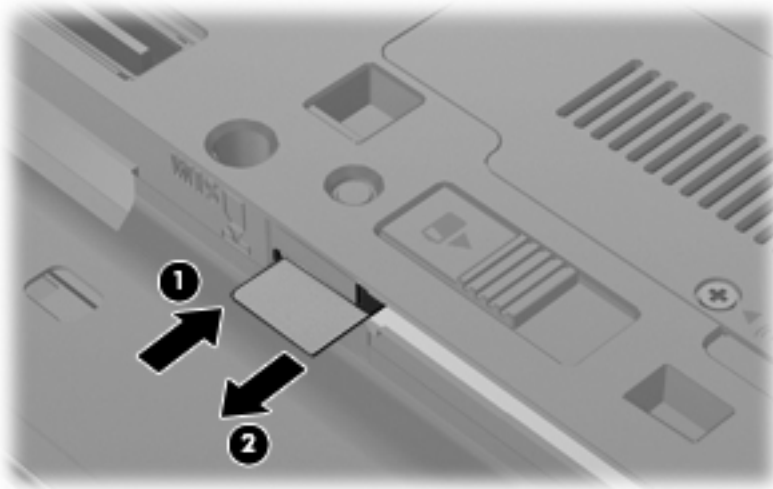

8. Replace the battery.
9. Reconnect external power.
10. Reconnect external devices.
11. Turn on the computer.

## Using a Bluetooth wireless device (select models only)

A Bluetooth device provides short-range wireless communications that replace the physical cable connections that traditionally link electronic devices such as the following:

- Computers (desktop, notebook, PDA)
- Phones (cellular, cordless, smart phone)
- Imaging devices (printer, camera)
- Audio devices (headset, speakers)

Bluetooth devices provide peer-to-peer capability that allows you to set up a personal area network (PAN) of Bluetooth devices. For information on configuring and using Bluetooth devices, refer to the Bluetooth software Help.

## Bluetooth and Internet Connection Sharing (ICS)

HP does **not** recommend setting up one computer with Bluetooth as a host and using it as a gateway through which other computers may connect to the Internet. When two or more computers are connected using Bluetooth, and Internet Connection Sharing (ICS) is enabled on one of the computers, the other computers may not be able to connect to the Internet using the Bluetooth network.

The strength of Bluetooth is in synchronizing information transfers between your computer and wireless devices including cellular phones, printers, cameras, and PDAs. The inability to consistently connect two or more computers to share the Internet through Bluetooth is a limitation of Bluetooth and the Windows® operating system.

# Troubleshooting wireless connection problems

Some possible causes for wireless connection problems include the following:

- Wireless device is not installed correctly or has been disabled.
- Wireless device or router hardware has failed.
- Network configuration (SSID or security) has been changed.
- Wireless device encountered interference from other devices.

---

 **NOTE:** Wireless networking devices are included with select computer models only. If wireless networking is not listed in the feature list on the side of the original computer package, you may add wireless networking capability to the computer by purchasing a wireless networking device.

---

Before working your way through the sequence of possible solutions to your network connection problem, be sure that device drivers are installed for all wireless devices.

Use the procedures in this chapter to diagnose and repair a computer that does not connect to the network you want to use.

## Cannot create a WLAN connection

If you have a problem connecting to a WLAN, confirm that the integrated WLAN device is properly installed on your computer:

1. Select **Start > My Computer**.
2. Right-click in the My Computer window.
3. Select **Properties > Hardware > Device Manager > Network Adapters**.
4. Identify the WLAN device from the Network adapters list. The listing for a WLAN device may include the term *wireless*, *wireless LAN*, *WLAN*, or *802.11*.

If no WLAN device is listed, either your computer does not have an integrated WLAN device, or the driver for the WLAN device is not properly installed.

For more information on troubleshooting WLANs, refer to the Web site links provided in Help and Support.

## Cannot connect to a preferred network

Windows can automatically repair a corrupted WLAN connection:

- If there is a network status icon in the notification area, at the far right of the taskbar, right-click the icon, and then click **Repair** from the menu.

Windows resets your network device and attempts to reconnect to one of the preferred networks.

- If an “x” is superimposed over the network status icon, one or more of your WLAN or LAN drivers are installed but the computer is not connected.
- If there is no network status icon in the notification area, follow these steps:
  1. Select **Start > Control Panel > Network and Internet Connections > Network Connections**.
  2. Click on one of the connections.
  3. In the left pane, click **Repair this connection**.

The Network connections window is displayed, and Windows resets your network device and attempts to reconnect to one of the preferred networks.

## Current network security codes are unavailable

If you are prompted for a network key or an SSID when connecting to a WLAN, the network is protected by security. You must have the current codes to make a connection on a secure network. The SSID and network key are alphanumeric codes that you enter into your computer to identify your computer to the network.

- For a network connected to your personal wireless router, review the router user guide for instructions on setting up the same codes on both the router and the WLAN device.
- For a private network, such as a network in an office or at a public Internet chat room, contact the network administrator to obtain the codes, and then enter the codes when prompted to do so.

Some networks change the SSID or network keys used in their routers or access points on a regular basis to improve security. You must change the corresponding code in your computer accordingly.

If you are provided with new wireless network keys and SSID for a network, and if you have previously connected to that network, follow these steps to connect to the network:

1. Select **Start > Control Panel > Network and Internet Connections > Network Connections**.

A list showing the available WLANs is displayed. If you are in a hotspot where several WLANs are active, several will be displayed.

2. Right-click the network, and then click **Properties**.
3. Click the **Wireless Networks** tab.
4. Select the network, and then click **Properties**.

 **NOTE:** If the network you want is not listed, check with the network administrator to be sure that the router or access point is operating.

5. Click the **Association** tab, and then enter the correct wireless encryption data into the **Network key** field.
6. Click **OK** to save these settings.

## WLAN connection is very weak

If the connection is very weak, or if your computer cannot make a connection to a WLAN, minimize interference from other devices, as follows:

- Move your computer closer to the wireless router or access point.
- Temporarily disconnect other wireless devices such as a microwave, cordless phone, or cellular phone to be sure that they are not interfering.

If the connection does not improve, try forcing the device to reestablish all connection values:

1. Select **Start > Control Panel > Network and Internet Connections > Network Connections**.
2. Right-click the network, and then click **Properties**.
3. Click the **Wireless Networks** tab.

A list showing the available WLANs is displayed. If you are in a hotspot where several WLANs are active, several will be displayed.

4. Select a network, and then click **Remove**.

## Cannot connect to the wireless router

If you are trying to connect to the wireless router and are unsuccessful, reset the wireless router by removing power from the router for 10 to 15 seconds.

If the computer still cannot make a connection to a WLAN, restart the wireless router. For details, refer to the router manufacturer's instructions.

## Using the modem (select models only)

The modem must be connected to an analog telephone line using a 6-pin, RJ-11 modem cable (purchased separately). In some countries or regions, a country- or region-specific modem cable adapter (purchased separately) is also required. Jacks for digital PBX systems may resemble analog telephone jacks, but they are not compatible with the modem.

⚠ **WARNING!** Connecting the internal analog modem to a digital line can permanently damage the modem. Immediately disconnect the modem cable if you accidentally connect it to a digital line.

If the modem cable contains noise suppression circuitry **(1)**, which prevents interference from TV and radio reception, orient the circuitry end **(2)** of the cable toward the computer.



## Connecting a modem cable

⚠ **WARNING!** To reduce the risk of electric shock, fire, or damage to the equipment, do not plug a modem cable (purchased separately) or telephone cable into the RJ-45 (network) jack.

To connect a modem cable:

1. Plug the modem cable into the modem jack **(1)** on the computer.
2. Plug the modem cable into the RJ-11 telephone wall jack **(2)**.



## Connecting a country- or region-specific modem cable adapter

Telephone jacks vary by country or region. To use the modem and the modem cable (purchased separately) outside the country or region in which you purchased the computer, you must obtain a country- or region-specific modem cable adapter (purchased separately).

To connect the modem to an analog telephone line that does not have an RJ-11 telephone jack, follow these steps:

1. Plug the modem cable into the modem jack (1) on the computer.
2. Plug the modem cable into the country- or region-specific modem cable adapter (2).
3. Plug the country- or region-specific modem cable adapter (3) into the telephone wall jack.

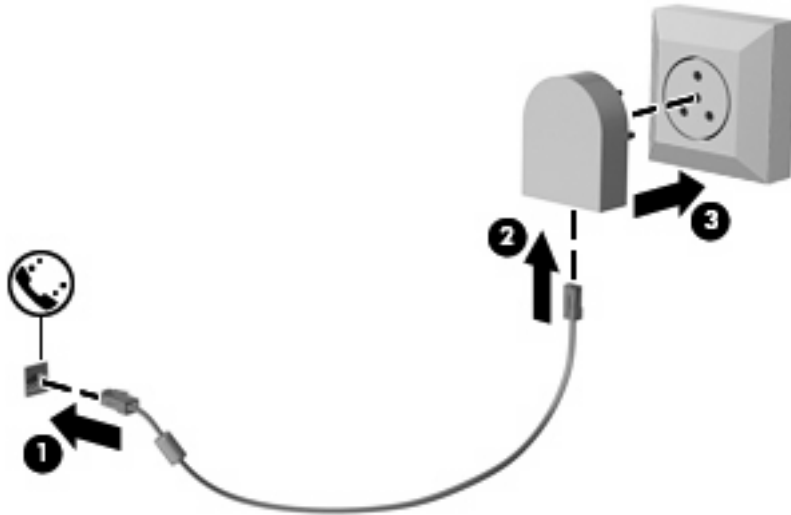

## Selecting a location setting

### Viewing the current location selection

To view the current location setting for the modem, follow these steps:

1. Select **Start > Control Panel**.
2. Click **Date, Time, Language, and Regional Options**.
3. Click **Regional and Language Options**.
4. Your location is displayed under **Location**.

### Adding new locations when traveling

By default, the only location setting available to the modem is a location setting for the country or region in which you purchased the computer. As you travel to different countries or regions, set the internal modem to a location setting that meets the operating standards of the country or region in which you are using the modem.

As you add new location settings, they are saved by the computer so that you can switch among settings at any time. You can add multiple location settings for any country or region.

- △ **CAUTION:** To prevent losing your home country or region settings, do not delete your current modem country or region settings. To enable modem use in other countries or regions while preserving your home country or region configuration, add a new configuration for each location in which you will use the modem.



**CAUTION:** To prevent configuring the modem in a way that violates the telecommunications regulations and laws of the country or region you are visiting, select the country or region in which the computer is located. The modem may not function properly if the correct country or region selection is not made.

---

To add a location setting for the modem, follow these steps:

1. Select **Start > Control Panel > Printers and Other Hardware > Phone and Modem Options**.
2. Then click the **Dialing Rules** tab.
3. Click **New**. (The New Location window is displayed.)
4. In the **Location name** box, type a name (such as “home” or “work”) for the new location setting.
5. Select a country or region from the **Country/region** drop-down list. (If you select a country or region that is not supported by the modem, the Country/region selection for *USA* or *UK* is displayed by default.)
6. Enter the area code, a carrier code (if necessary), and the number to access an outside line (if necessary).
7. Next to **Dial using**, click **Tone** or **Pulse**.
8. Click **OK** to save your new location setting. (The Phone and Modem Options window is displayed.)
9. Do one of the following:
  - To set your new location setting as the current location, click **OK**.
  - To select another location setting as the current location setting, select your preference from the settings in the **Location** list, and then click **OK**.

---

 **NOTE:** You can use the preceding procedure to add location settings for places within your own country or region as well as in other countries or regions. For example, you could add a setting named “Work” that includes dialing rules for accessing an outside line.

---

## Solving travel connection problems

If you experience modem connection problems when using the computer outside of the country or region in which you purchased it, try the following suggestions.

- **Check the telephone line type.**

The modem requires an analog, not a digital, telephone line. A line described as a PBX line is usually a digital line. A telephone line described as a data line, fax machine line, modem line, or standard telephone line is usually an analog line.

- **Check for pulse or tone dialing.**

An analog telephone line supports one of 2 dialing modes: pulse dialing or tone dialing. These dialing mode options are selected in the Phone and Modem Options settings. The dialing mode option selected must match the dialing mode supported by the telephone line in your location.

To determine the dialing mode supported by a telephone line, dial a few digits on the telephone, and then listen for clicks (pulses) or tones. Clicks indicate that the telephone line supports pulse dialing. Tones indicate that the telephone line supports tone dialing.

To change the dialing mode in your current modem location setting, follow these steps:

1. Select **Start > Control Panel > Printers and Other Hardware > Phone and Modem Options**.
  2. Then click the **Dialing Rules** tab.
  3. Select your modem location setting.
  4. Click **Edit**.
  5. Click either **Tone** or **Pulse**.
  6. Click **OK** twice.
- **Check the telephone number you are dialing and the response of the remote modem.**

Dial a telephone number, be sure that there is a response from the remote modem, and then hang up.

- **Set the modem to ignore dial tones.**

If the modem receives a dial tone it does not recognize, it does not dial and displays a “No Dial Tone” error message.

To set the modem to ignore all dial tones before dialing, follow these steps:

1. Select **Start > Control Panel > Printers and Other Hardware > Phone and Modem Options**.
2. Then click the **Modems** tab.
3. Click the listing for the modem.
4. Click **Properties**.
5. Click **Modem**.
6. Clear the check box for **Wait for dial tone before dialing**.
7. Click **OK** twice.

## Connecting to a local area network (LAN)

Connecting to a local area network (LAN) requires an 8-pin, RJ-45 network cable (purchased separately). If the network cable contains noise suppression circuitry (1), which prevents interference from TV and radio reception, orient the circuitry end of the cable (2) toward the computer.



To connect the network cable:

1. Plug the network cable into the network jack (1) on the computer.
2. Plug the other end of the cable into a network wall jack (2).

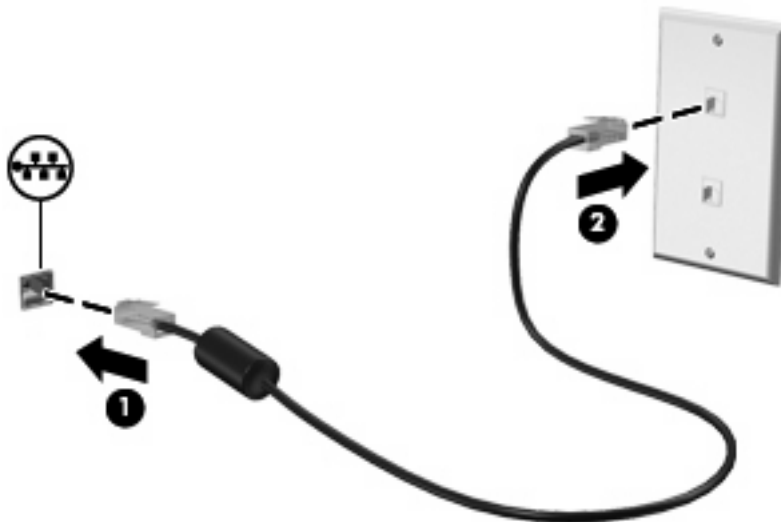

**⚠ WARNING!** To reduce the risk of electric shock, fire, or damage to the equipment, do not plug a modem or telephone cable into the RJ-45 (network) jack.

---

# 3 Pointing devices and keyboard

## Using pointing devices

### Setting pointing device preferences

Use Mouse Properties in Windows® to customize settings for pointing devices, such as button configuration, click speed, and pointer options.

To access Mouse Properties, select **Start > Control Panel > Printers and Other Hardware > Mouse**.

### Using the TouchPad

To move the pointer, slide your finger across the TouchPad surface in the direction you want the pointer to go. Use the TouchPad buttons like the corresponding buttons on an external mouse. To scroll up and down using the TouchPad vertical scroll zone, slide your finger up or down over the lines.

 **NOTE:** If you are using the TouchPad to move the pointer, you must lift your finger off the TouchPad before moving it to the scroll zone. Simply sliding your finger from the TouchPad to the scroll zone will not activate the scrolling function.

### Using the pointing stick

Press the pointing stick in the direction you want to move the pointer on the screen. Use the left and right pointing stick buttons as you would the left and right buttons on an external mouse.

### Connecting an external mouse

You can connect an external USB mouse to the computer using one of the USB ports on the computer. A USB mouse can also be connected to the system using the ports on an optional docking device or expansion product.

## Using the keyboard

### Using hotkeys

Hotkeys are combinations of the **fn** key **(1)** and either the **esc** key **(2)** or one of the function keys **(3)**.

The icons on the **f3**, **f4**, and **f8** through **f11** keys represent the hotkey functions. Hotkey functions and procedures are discussed in the following sections.

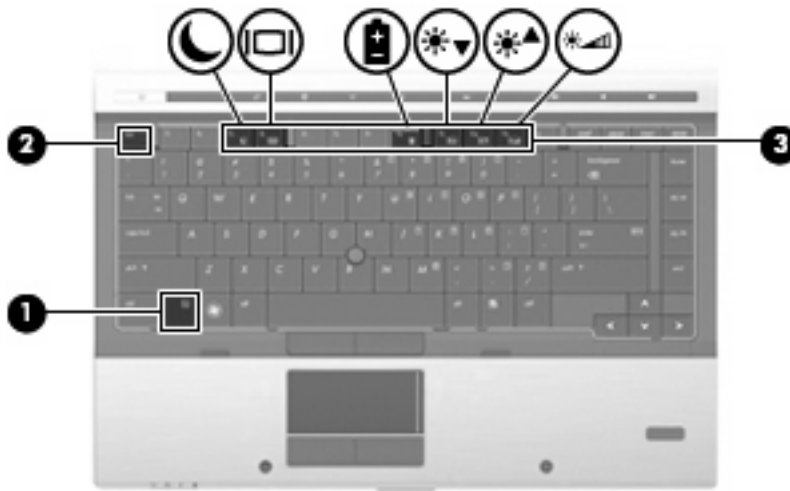

| Function                           | Hotkey |
|------------------------------------|--------|
| Display system information.        | fn+esc |
| Initiate Standby.                  | fn+f3  |
| Switch the screen image.           | fn+f4  |
| Display battery information.       | fn+f8  |
| Decrease screen brightness.        | fn+f9  |
| Increase screen brightness.        | fn+f10 |
| Activate the ambient light sensor. | fn+f11 |

To use a hotkey command on the computer keyboard, follow either of these steps:

- Briefly press the **fn** key, and then briefly press the second key of the hotkey command.
- or –
- Press and hold down the **fn** key, briefly press the second key of the hotkey command, and then release both keys at the same time.

## Displaying system information

Press **fn+esc** to display information about system hardware components and the system BIOS version number.

In the Windows **fn+esc** display, the version of the system BIOS (basic input-output system) is displayed as the BIOS date. On some computer models, the BIOS date is displayed in decimal format. The BIOS date is sometimes called the system ROM version number.

## Initiating Standby

Press **fn+f3** to initiate Standby.

When Standby is initiated, your information is stored in memory, the screen is cleared, and power is conserved. While the computer is in Standby, the power lights blink.

---

△ **CAUTION:** To reduce the risk of information loss, save your work before initiating Standby.

---

The computer must be on before you can initiate Standby.

📝 **NOTE:** If a critical battery level occurs while the computer is in Standby, the computer initiates Hibernation and the information stored in memory is saved to the hard drive. The factory setting for critical battery action is Hibernate, but this setting can be changed in advanced power settings.

---

To exit Standby, briefly press the power button or press any key on the keyboard.

The function of the **fn+f3** hotkey can be changed. For example, you can set the **fn+f3** hotkey to initiate Hibernation instead of Standby.

📝 **NOTE:** In all Windows operating system windows, references to the *sleep button* apply to the **fn+f3** hotkey.

---

## Switching the screen image

Press **fn+f4** to switch the screen image among display devices connected to the system. For example, if a monitor is connected to the computer, pressing **fn+f4** alternates the screen image from computer display to monitor display to simultaneous display on both the computer and the monitor.

Most external monitors receive video information from the computer using the external VGA video standard. The **fn+f4** hotkey can also alternate images among other devices receiving video information from the computer.

The following video transmission types, with examples of devices that use them, are supported by the **fn+f4** hotkey:

- LCD (computer display)
- External VGA (most external monitors)
- DisplayPort

## Viewing battery charge information

Press **fn+f8** to display charge information for all installed batteries. The display indicates which batteries are charging and reports the amount of charge remaining in each battery.

## Decreasing screen brightness

Press **fn+f9** to decrease screen brightness. Hold down the hotkey to decrease the brightness level incrementally.

## Increasing screen brightness

Press **fn+f10** to increase screen brightness. Hold down the hotkey to increase the brightness level incrementally.

## Activating the ambient light sensor

Press **fn+f11** to activate and deactivate the ambient light sensor.

## Using HP QuickLook

QuickLook allows you to save calendar, contact, inbox, and task information from Microsoft Outlook to the hard drive of your computer. Then, when the computer is off or in Hibernation, you can press the QuickLook button on the computer to view this information without waiting for the operating system to restart.

Use QuickLook to manage contact information, calendar events, e-mail information, and tasks without restarting your computer.

 **NOTE:** QuickLook does not support the Standby state in Windows.

**NOTE:** After removing the battery, you must restart the computer to reenable the HP QuickLook feature.

For more information about setting up and using QuickLook, refer to the QuickLook software Help.

## Using keypads

The computer has an embedded numeric keypad and also supports an optional external numeric keypad or an optional external keyboard that includes a numeric keypad.

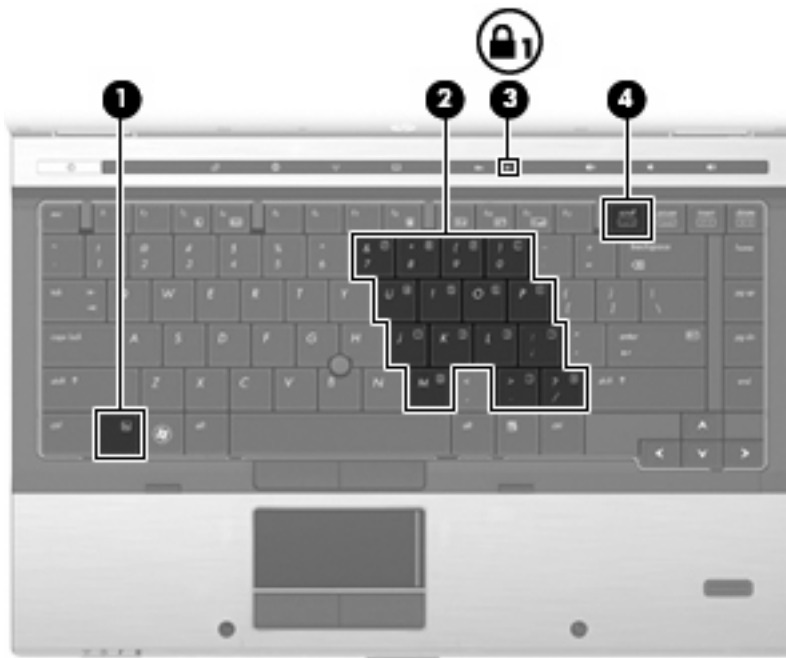

| Component                      | Description  |
|--------------------------------|--|
| (1) <a href="#">fn</a> key     | Enables/disables the embedded numeric keypad when pressed in combination with the <a href="#">num lk</a> key.                                    |
| (2) Embedded numeric keypad    | Can be used like the keys on an external numeric keypad when pressed in combination with the <a href="#">fn</a> and <a href="#">num lk</a> keys. |
| (3) num lock light             | On: Num lock is on.  |
| (4) <a href="#">num lk</a> key | Alternates between the navigation and numeric functions on the embedded numeric keypad.  |

| Component | Description   |
|-----------|---|
|           | <b>NOTE:</b> The keypad function that is active when the computer is turned off will be reinstated when the computer is turned back on. |

## Using the embedded numeric keypad

The 15 keys of the embedded numeric keypad can be used like the keys on an external keypad. When the embedded numeric keypad is turned on, each key on the keypad performs the function indicated by the icon in the upper-right corner of the key.

## Enabling and disabling the embedded numeric keypad

Press **fn+num lk** to enable the embedded numeric keypad. Press **fn+num lk** again to return the keys to their standard keyboard functions.

 **NOTE:** The embedded numeric keypad will not function while an external keyboard or numeric keypad is connected to the computer.

## Switching key functions on the embedded numeric keypad

You can temporarily alternate the functions of keys on the embedded numeric keypad between their standard keyboard functions and their keypad functions by using the **fn** key or the **fn+shift** key combination.

- To change the function of a keypad key to keypad functions while the keypad is off, press and hold the **fn** key while pressing the keypad key.
- To use the keypad keys temporarily as standard keys while the keypad is on:
  - Press and hold the **fn** key to type in lowercase.
  - Press and hold **fn+shift** to type in uppercase.

## Using an optional external numeric keypad

Keys on most external numeric keypads function differently according to whether num lock is on or off. (Num lock is turned off at the factory.) For example:

- When num lock is on, most keypad keys type numbers.
- When num lock is off, most keypad keys function like the arrow, page up, or page down keys.

When num lock on an external keypad is turned on, the num lock light on the computer is turned on. When num lock on an external keypad is turned off, the num lock light on the computer is turned off.

To turn num lock on or off on an external keypad as you work:

- ▲ Press the **num lk** key on the external keypad, not on the computer.



## Cleaning the TouchPad, keyboard, and vents

Dirt and grease on the TouchPad can cause the pointer to jump around on the screen. To avoid this, clean the TouchPad with a damp cloth, and wash your hands frequently when using the computer.

- 
- ⚠ **WARNING!** To reduce the risk of electric shock or damage to internal components, do not use a vacuum cleaner attachment to clean the keyboard. A vacuum cleaner can deposit household debris on the keyboard surface.
- 

Clean the keyboard regularly to prevent keys from sticking and to remove dust, lint, and particles that can become trapped beneath the keys. A can of compressed air with a straw extension can be used to blow air around and under the keys to loosen and remove debris.



- 
- ⚠ **CAUTION:** To prevent dust or lint from blocking airflow through the vents, periodically inspect them. Use a soft brush or cloth to remove any dust or lint.
-

---

# 4 Multimedia

## Multimedia features

Your computer includes multimedia features that allow you to listen to music and view pictures. Your computer may include the following multimedia components:

- Optical drive for playing audio and video discs
- Integrated speakers for listening to music
- Integrated microphones for recording your own audio
- Integrated webcam (select models only) that allows you to capture and share video
- Preinstalled multimedia software that allows you to play and manage your music, movies, and pictures

---

 **NOTE:** Your computer may not include all of the components listed.

---

The following sections explain how to use the multimedia components included with your computer.

## Adjusting the volume

You can adjust the volume using the following controls:

- Computer volume buttons:
  - To mute or restore volume, press the volume mute button **(1)**.
  - To decrease volume, press the volume down button **(2)**.

- To increase volume, press the volume up button (3).

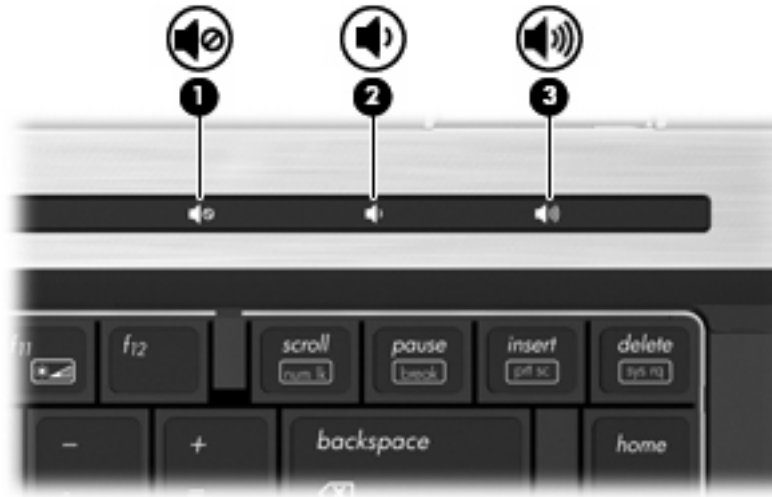

- Windows volume control:
  - a. Click the **Volume** icon in the notification area, at the far right of the taskbar.
  - b. Increase or decrease the volume by moving the slider up or down. Click the **Mute** check box to mute the volume.

– or –

- a. Double-click the **Volume** icon in the notification area.
- b. In the **Master Volume** column, you can increase or decrease the volume by moving the **Volume** slider up or down. You can also adjust the balance or mute the volume.

If the Speakers icon is not displayed in the notification area, follow these steps to add it:

- a. Select **Start > Control Panel > Sounds, Speech, and Audio Devices > Sounds and Audio Devices > Volume** tab.
- b. Select the **Place volume icon in the taskbar** check box.
- c. Click **Apply**.

- Program volume control:

Volume can also be adjusted within some programs.

## Multimedia software

Your computer includes preinstalled multimedia software that allows you to play music and view pictures. The following sections provide details about preinstalled multimedia software and installing multimedia software from a disc.

### Accessing your preinstalled multimedia software

To access preinstalled multimedia software:

- ▲ Select **Start > All Programs**, and then open the multimedia program you want to use.

---

 **NOTE:** Some programs may be located in subfolders.

**NOTE:** For details about using software included with the computer, refer to the software manufacturer's instructions. These instructions may be provided with the software, on disc, or on the manufacturer's Web site.

---

## Installing multimedia software from a disc

To install any multimedia software from a CD or DVD, follow these steps:

1. Insert the disc into the optical drive (select models only) or an optional external optical drive.
2. When the installation wizard opens, follow the on-screen instructions.
3. Restart the computer if you are prompted to do so.

---

 **NOTE:** If your computer does not have an optical drive, you can connect an external optical drive (purchased separately) to one of the USB ports on the computer.

---

# Audio

Your computer enables you to use a variety of audio features:

- Play music using your computer speakers and/or connected external speakers
- Record sound using the internal microphones or connect an external microphone
- Download music from the Internet
- Create multimedia presentations using audio and images
- Transmit sound and images with instant messaging programs
- Stream radio programs (select models only) or receive FM radio signals
- Create or “burn” audio CDs

## Connecting external audio devices

---

 **WARNING!** To reduce the risk of personal injury, adjust the volume before putting on headphones, earbuds, or a headset. For additional safety information, refer to the *Regulatory, Safety and Environmental Notices*.

---

To connect external devices such as external speakers, headphone, or a microphone, refer to the information provided with the device. For best results, remember the following tips:

- Be sure that the device cable is securely connected to the correct jack on your computer. (Cable connectors are normally color-coded to match the corresponding jacks on the computer.)
- Be sure to install any drivers required by the external device.

---

 **NOTE:** A driver is a required program that acts like a translator between the device and the programs that use the device.

---

## Checking your audio functions

To check the system sound on your computer, follow these steps:

1. Select **Start > Control Panel**.
2. Click **Sounds, Speech, and Audio Devices > Sounds and Audio Devices**.
3. When the Sounds and Audio Devices Properties window opens, click the **Sounds** tab. Under **Program events**, select any sound event, such as a beep or alarm, and click the **Play** button.

You should hear sound through the speakers or through connected headphones.

To check the record functions of the computer, follow these steps:

1. Select **Start > All Programs > Accessories > Entertainment > Sound Recorder**.
2. Click **Record** and speak into the microphone. Save the file to the desktop.
3. Open Windows Media Player and play back the sound.

---

 **NOTE:** For best results when recording, speak directly into the microphone and record sound in a setting free of background noise.

---

- ▲ To confirm or change the audio settings on your computer, right-click the **Sound** icon on the taskbar, or select **Start > Control Panel > Sounds, Speech, and Audio Devices > Sounds and Audio Devices**.

# Video

Your computer enables you to use a variety of video features:

- Watch movies
- Play games over the Internet
- Edit pictures and video to create presentations
- Connect external video devices

## Connecting an external monitor or projector

Your computer has both an external monitor port and a DisplayPort that allow you to connect external monitors and projectors.

### Using the external monitor port

The external monitor port connects an external VGA display device such as an external VGA monitor or a VGA projector to the computer. The external monitor port is an analog display interface.

- ▲ To connect a VGA display device, connect the device cable to the external monitor port.

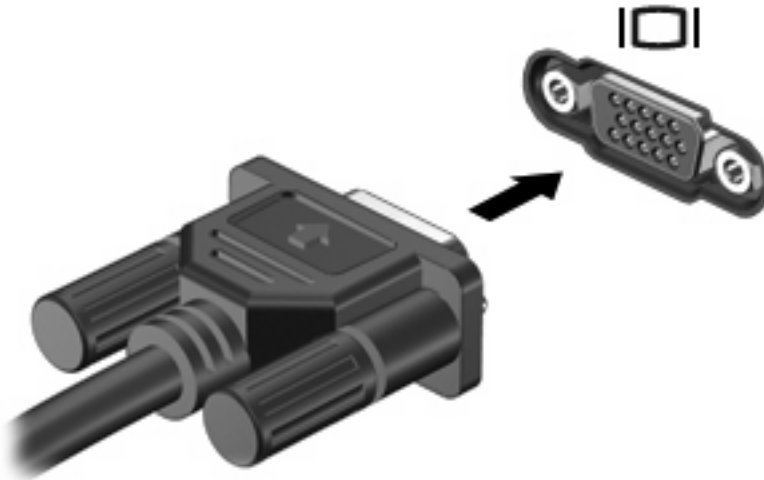

---

 **NOTE:** If a properly connected external display device does not display an image, press **fn+f4** to transfer the image to the device. Repeatedly pressing **fn+f4** alternates the screen image between the computer display and the device.

---

### Using the DisplayPort

The DisplayPort connects a digital display device such as a high-performance monitor or projector. The DisplayPort delivers higher performance over the VGA external monitor port and improves digital connectivity.

- ▲ To connect a digital display device, connect the device cable to the DisplayPort.



---

 **NOTE:** If a properly connected external display device does not display an image, press **fn+f4** to transfer the image to the device. Repeatedly pressing **fn+f4** alternates the screen image between the computer display and the device.

---



# Optical drive (select models only)

Your computer may include an optical drive that expands the functionality of the computer. The optical drive allows you to read data discs, play music, and watch movies.

## Identifying the optical drive

▲ Select **Start > My Computer**.

You will see a list of all the devices installed on your computer. You may have one of the following types of drives:

- DVD-ROM Drive
- DVD±RW SuperMulti Double-Layer (DL) with LightScribe Drive

 **NOTE:** Double-layer discs can store more data than single-layer discs. However, double-layer discs burned with this drive may not be compatible with many existing single-layer DVD drives and players.

- Blu-ray ROM DVD±RW SuperMulti DL Drive

 **NOTE:** Some of these drives may not be supported by your computer.

## Using optical discs (CDs, DVDs, and BDs)

An optical drive, such as a DVD-ROM drive, supports optical discs (CDs and DVDs). These discs store information, such as music, photos, and movies. DVDs have a higher storage capacity than CDs.

Your optical drive can read standard CD and DVD discs. If your optical drive is a Blu-ray Disc (BD) drive, it can also read BDs.

 **NOTE:** Some of the optical drives listed may not be supported by your computer. The listed drives are not necessarily all of the supported optical drives.

Some optical drives can also write to optical discs as described in the following table.

| Optical drive type                       | Read CD and DVD-ROM media | Write to CD-RW | Write to DVD* | Write label to LightScribe CD or DVD | Read BD | Write to BD R/RE |
|--|---------------------------|----------------|---------------|--------------------------------------|---------|------------------|
| DVD-ROM Drive                            | Yes                       | No             | No            | No                                   | No      | No               |
| DVD±RW SuperMulti DL‡ LightScribe† Drive | Yes                       | Yes            | Yes           | Yes                                  | No      | No               |
| Blu-ray RW Drive                         | Yes                       | Yes            | Yes           | No                                   | Yes     | Yes              |
| Blu-ray ROM with LightScribe† Drive      | Yes                       | No             | No            | Yes                                  | Yes     | No               |

\*Includes DVD+R DL, DVD+RW/R, and DVD-RAM.

†LightScribe discs must be purchased separately. LightScribe creates a grayscale image similar to black-and-white photography.

‡Double-layer discs can store more data than single-layer discs. However, double-layer discs burned with this drive may not be compatible with many single-layer DVD drivers and players.

△ **CAUTION:** To prevent possible audio and video degradation, loss of information, or loss of audio or video playback functionality, do not initiate Standby or Hibernation while reading a CD, DVD, or BD, or writing to a CD or DVD.

---

## Selecting the right disc (CDs, DVDs, and BDs)

An optical drive supports optical discs (CDs, DVDs, and BDs). CDs, used to store digital data, are also used for commercial audio recordings and are convenient for your personal storage needs. DVDs and BDs are used primarily for movies, software, and data backup purposes. DVDs and BDs are the same form factor as CDs but have a much higher storage capacity.

 **NOTE:** The optical drive on your computer may not support all the types of optical discs discussed in this section.

---

### CD-R discs

Use CD-R (write-once) discs to create permanent archives and to share files with virtually anyone. Typical uses include the following:

- Distributing large presentations
- Sharing scanned and digital photos, video clips, and written data
- Making your own music CDs
- Keeping permanent archives of computer files and scanned home records
- Offloading files from your hard drive to free up disk space

After data is recorded, it cannot be erased or written over.

### CD-RW discs

Use a CD-RW disc (a rewritable version of a CD) to store large projects that must be updated frequently. Typical uses include the following:

- Developing and maintaining large documents and project files
- Transporting work files
- Making weekly backups of hard drive files
- Updating photos, video, audio, and data continuously

### DVD±R discs

Use blank DVD±R discs to permanently store large amounts of information. After data is recorded, it cannot be erased or written over.

### DVD±RW discs

Use DVD±RW discs if you want to be able to erase or write over data that you saved earlier. This type of disc is ideal for testing audio or video recordings before you burn them to a CD or DVD that cannot be changed.

## LightScribe DVD+R discs

Use LightScribe DVD+R discs for sharing and storing data, home videos, and photos. These discs are read-compatible with most DVD-ROM drives and DVD video players. With a LightScribe-enabled drive and LightScribe software, you can write data to the disc and then add a designer label to the outside of the disc.

## Blu-ray Discs (BDs)

BD is a high-density optical disc format for the storage of digital information, including high-definition video. A single-layer Blu-ray Disc can store 25 GB, over 5 times the storage capacity of a single-layer DVD at 4.7 GB. A dual-layer Blu-ray Disc can store 50 GB, almost 6 times the storage capacity of a dual-layer DVD at 8.5 GB.

Typical uses include the following:

- Storage of large amounts of data
- High-definition video playback and storage
- Video games

---

 **NOTE:** As Blu-ray is a new format containing new technologies, certain disc, digital connection, compatibility and/or performance issues may arise, and do not constitute defects in the product. Flawless playback on all systems is not guaranteed.

---

## Playing a CD, DVD, or BD

1. Turn on the computer.
2. Press the release button **(1)** on the drive bezel to release the disc tray.
3. Pull out the tray **(2)**.
4. Hold the disc by the edges to avoid touching the flat surfaces and position the disc label-side up over the tray spindle.

---

 **NOTE:** If the tray is not fully accessible, tilt the disc carefully to position it over the spindle.

---

5. Gently press the disc (3) down onto the tray spindle until the disc snaps into place.

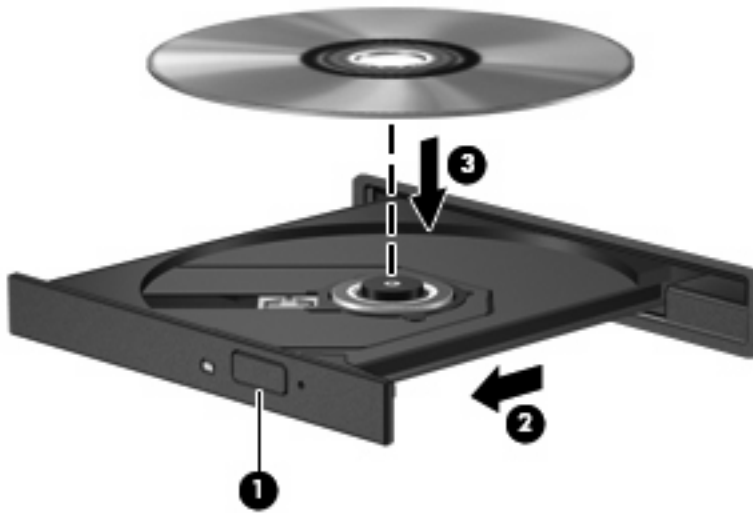

6. Close the disc tray.

If you have not yet configured AutoPlay, as described in the following section, an AutoPlay dialog box opens. It prompts you to select how you want to use the media content.

 **NOTE:** For best results, be sure that your AC adapter is plugged into an external power source while playing a BD.

## Configuring AutoPlay

1. Select **Start > My Computer**.
2. Right-click the device (such as CD-ROM drive), and then click **Properties**.
3. Click the **AutoPlay** tab, and then select one of the available actions.

 **NOTE:** Choose WinDVD (select models only) or the default DVD player to play DVDs.

4. Click **OK**.

 **NOTE:** For more information about AutoPlay, select **Start > Help and Support**.

## Changing DVD region settings

Most DVDs that contain copyrighted files also contain region codes. The region codes help protect copyrights internationally.

You can play a DVD containing a region code only if the region code on the DVD matches the region setting on your DVD drive.

 **CAUTION:** The region settings on your DVD drive can be changed only 5 times.

The region setting you select the fifth time becomes the permanent region setting on the DVD drive.

The number of region changes remaining is displayed on the DVD Region tab.

To change settings through the operating system:

1. Select **Start > My Computer**.
2. Right-click in the window and select **Properties > Hardware tab > Device Manager**.
3. Click the plus sign (+) next to **DVD/CD-ROM drives**.
4. Right-click the DVD drive for which you want to change region settings, and then click **Properties**.
5. Click the **DVD Region** tab and change settings.
6. Click **OK**.

## Observing the copyright warning

It is a criminal offense, under applicable copyright laws, to make unauthorized copies of copyright-protected material, including computer programs, films, broadcasts, and sound recordings. Do not use this computer for such purposes.

---

△ **CAUTION:** To prevent loss of information or damage to a disc, observe the following guidelines:

Before writing to a disc, connect the computer to a reliable external power source. Do not write to a disc while the computer is running on battery power.

Before writing to a disc, close all open programs except the disc software you are using.

Do not copy directly from a source disc to a destination disc or from a network drive to a destination disc. Save the information to your hard drive, and then burn from your hard drive to the destination disc.

Do not use the computer keyboard or move the computer while the computer is writing to a disc. The write process is sensitive to vibration.

 **NOTE:** For details about using software included with the computer, refer to the software manufacturer's instructions, which may be provided on disc, in the software Help, or on the manufacturer's Web site.

---

## Copying a CD, DVD, or BD

1. Select **Start > All Programs > Roxio > Creator Business**.
2. In the right pane, click **Copy Disc**.
3. Insert the disc you want to copy into the optical drive.
4. Click **Copy** at the bottom right of the screen.

Creator Business reads the source disc and copies the data to a temporary folder on your hard drive.

5. When prompted, remove the source disc from the optical drive and insert a blank disc into the drive.

After the information is copied, the disc you created is ejected automatically.

## Creating (burning) a CD, DVD, or BD

If your optical drive is a CD-RW, DVD-RW, or DVD±RW optical drive, you can use software such as Windows Media Player to burn data and audio files, including MP3 and WAV music files. To burn video files to a CD or DVD, use MyDVD.

Observe the following guidelines when burning a CD or DVD:

- Before burning a disc, save and close any open files and close all programs.
- A CD-R or DVD-R is usually best for burning audio files because after the information is copied, it cannot be changed.
- Because some home and car stereos will not play CD-RWs, use CD-Rs to burn music CDs.
- A CD-RW or DVD-RW is generally best for burning data files or for testing audio or video recordings before you burn them to a CD or DVD that cannot be changed.
- DVD players used in home systems usually do not support all DVD formats. Refer to the user guide that came with your DVD player for a list of supported formats.
- An MP3 file uses less space than other music file formats, and the process for creating an MP3 disc is the same as the process for creating a data file. MP3 files can be played only on MP3 players or on computers with MP3 software installed.

To burn a CD or DVD, follow these steps:

1. Download or copy the source files into a folder on your hard drive.
2. Insert a blank disc into the optical drive (select models only) or an optional external optical drive.
3. Select **Start > All Programs** and the name of the software you want to use.
4. Select the kind of disc you want to create—data, audio, or video.
5. Right-click **Start**, click **Explore**, and navigate to the folder where the source files are stored.
6. Open the folder, and then drag the files to the drive that contains the blank optical disc.
7. Initiate the burning process as directed by the program you have selected.

For specific instructions, refer to the software manufacturer's instructions. These instructions may be provided with the software, on disc, or on the manufacturer's Web site.

---

△ **CAUTION:** Observe the copyright warning. It is a criminal offense, under applicable copyright laws, to make unauthorized copies of copyright-protected material, including computer programs, films, broadcasts, and sound recordings. Do not use this computer for such purposes.

---

## Removing an optical disc (CD, DVD, or BD)

1. Press the release button **(1)** on the drive bezel to release the disc tray, and then gently pull out the tray **(2)** until it stops.

2. Remove the disc **(3)** from the tray by gently pressing down on the spindle while lifting the outer edges of the disc. Hold the disc by the edges and avoid touching the flat surfaces.

 **NOTE:** If the tray is not fully accessible, tilt the disc carefully as you remove it.

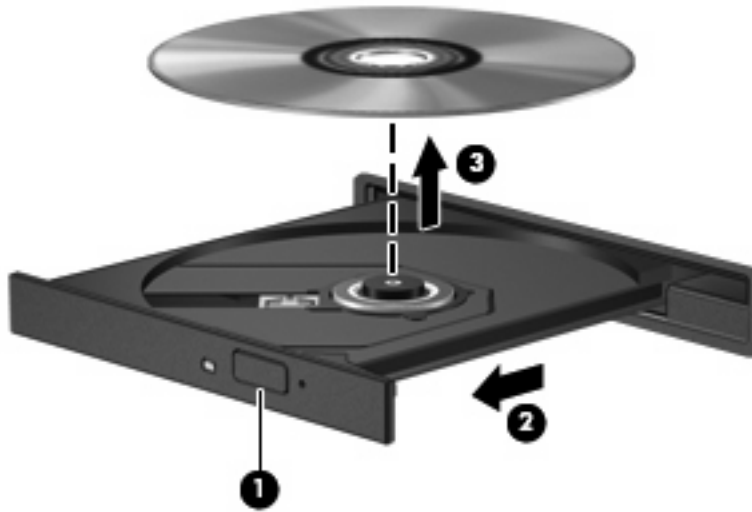

3. Close the disc tray and place the disc in a protective case.

## Troubleshooting

The following sections describe several common issues and resolutions.

### The optical disc tray does not open for removal of a CD, DVD, or BD

1. Insert the end of a paper clip **(1)** into the release access in the front bezel of the drive.
2. Press in gently on the paper clip until the disc tray is released, and then pull out the tray **(2)** until it stops.

3. Remove the disc (3) from the tray by gently pressing down on the spindle while lifting the outer edges of the disc. Hold the disc by the edges and avoid touching the flat surfaces.

 **NOTE:** If the tray is not fully accessible, tilt the disc carefully as you remove it.

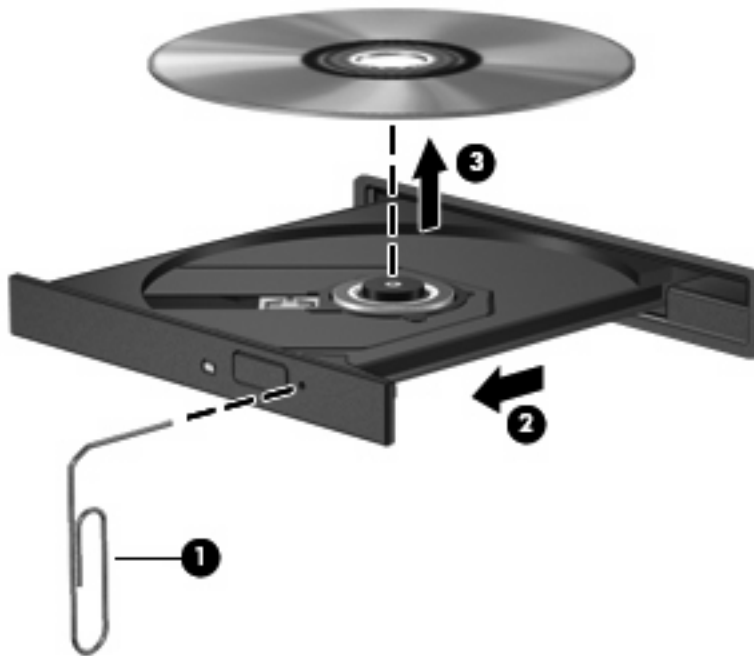

4. Close the disc tray and place the disc in a protective case.

### The computer does not detect the optical drive

If Windows® does not detect an attached device, the device driver software may be missing or corrupted. If you suspect that the DVD/CD-ROM drive is not being detected, verify that the optical drive is listed in the Device Manager utility.

1. Remove any discs from the optical drive.
2. Select **Start > My Computer**.
3. Right-click in the window and select **Properties > Hardware** tab, and then click **Device Manager**.
4. In the Device Manager window, click the plus sign (+) next to **DVD/CD-ROM drives**, unless a minus sign (-) is already showing. Look for an optical drive listing.

If the drive is not listed, install (or reinstall) the device driver as instructed in the section "A device driver must be reinstalled."

### A disc does not play

- Save your work and close all open programs before playing a CD, DVD, or BD.
- Log off the Internet before playing a CD, DVD, or BD.
- Be sure that you insert the disc properly.



- Be sure that the disc is clean. If necessary, clean the disc with filtered water and a lint-free cloth. Wipe from the center of the disc to the outer edge.
- Check the disc for scratches. If you find scratches, treat the disc with an optical disc repair kit available at many electronics stores.
- Disable Standby before playing a disc.

Do not initiate Hibernation or Standby while playing a disc. Otherwise, you may see a warning message asking if you want to continue. If this message is displayed, click **No**. After you click **No**, the computer may behave in either of the following ways:

- Playback may resume.
- or –
- The playback window in the multimedia program may close. To return to playing the disc, click the **Play** button in your multimedia program to restart the disc. In rare cases, you may need to exit the program and then restart it.
- Increase system resources:
 

Turn off external devices such as printers and scanners. Disconnecting these devices frees up valuable system resources and results in better playback performance.

Change desktop color properties. Because the human eye cannot easily tell the difference between colors beyond 16 bits, you should not notice any loss of color while watching a movie if you lower system color properties to 16-bit color, as follows:

1. Right-click anywhere on the desktop except on an icon, and then select **Properties > Settings**.
2. Set **Color quality** to **Medium (16 bit)**.

### A disc does not play automatically

1. Select **Start > My Computer**.
2. Right-click the device (such as CD-ROM drive), and then click **Properties**.
3. Click the **AutoPlay** tab, and then select one of the available actions.
4. Click **OK**.

A CD, DVD, or BD should now start automatically when it is inserted into the optical drive.

---

 **NOTE:** For more information about AutoPlay, refer to Help and Support.

---

### A movie stops, skips, or plays erratically

- Check to be sure the disc is not scratched or damaged.
- Clean the disc.
- Conserve system resources by trying the following suggestions:
  - Log off the Internet.
  - Change the color properties of the desktop:
    1. Right-click on a blank area of the computer desktop, and select **Properties > Settings**.

2. Set **Color quality** to **Medium (16 bit)**, if this setting is not already selected.
- Disconnect external devices, such as a printer, scanner, camera, or handheld device.

## A movie is not visible on an external display

1. If both the computer display and an external display are turned on, press **fn+f4** one or more times to switch between the 2 displays.
2. Configure the monitor settings to make the external display primary:
  - a. Right-click on a blank area of the computer desktop, and select **Properties > Settings**.
  - b. Specify a primary display and a secondary display.

---

 **NOTE:** When using both displays, the DVD image will not appear on any display designated as the secondary display.

---

To get information about a multimedia question not covered in this guide, select **Start > Help and Support**.

## The process of burning a disc does not begin, or it stops before completion

- Be sure that all other programs are closed.
- Turn off Standby and Hibernation.
- Be sure that you are using the right kind of disc for your drive. See your user guides for more information about disc types.
- Be sure that the disc is inserted properly.
- Select a slower write speed and try again.
- If you are copying a disc, save the information on the source disc to your hard drive before trying to burn the contents to a new disc, and then burn from your hard drive.
- Reinstall the disc-burning device driver located in the DVD/CD-ROM drives category in Device Manager.

## A device driver must be reinstalled

### Obtaining the latest HP device drivers

Follow either of the following procedures to obtain HP device drivers.

To use the HP Update Utility:

1. Select **Start > All Programs > HP > HP Update**.
2. On the HP Welcome screen, click **Settings**, and then select a time when the utility should check for software updates on the Web.
3. Click **Next** to immediately check for HP software updates.

To use the HP Web site:

1. Open your Web browser, go to <http://www.hp.com/support>, and select your country or region.
2. Click the option for software and driver downloads, and then type your computer model number in the product box.
3. Press **enter**, and then follow the on-screen instructions.

### Obtaining Microsoft device drivers

You can obtain the latest Windows device drivers by using Microsoft® Update. This Windows feature can be set to automatically check for and install updates for your hardware drivers, as well as for the Windows operating system and other Microsoft products.

To use Microsoft Update:

1. Open your Web browser and go to <http://www.microsoft.com>, and click **Security & Updates**.
2. Click **Microsoft Update** to get the latest updates for your computer operating system, programs, and hardware.
3. Follow the on-screen instructions to install Microsoft Update.
4. Click **Change settings** and select a time for Microsoft Update to check for updates to the Windows operating system and other Microsoft products.
5. If prompted to do so, restart your computer.

## Webcam (select models only)

Your computer may include an integrated webcam, located at the top of the display. With the preinstalled software, you can use the webcam to record audio and video and capture still photographs. You can preview the photo, video recording, or audio recording, and save it on your computer hard drive.

To access the webcam and HP Webcam software, select **Start > All Programs > HP > HP Webcam**.

The webcam software enables you to experiment with the following features:

- Video—Record and play back webcam video.
- Audio—Record and play back audio.
- Streaming video—Use with instant message software solutions that support UVC (Universal Video Class) cameras.
- Snapshots—Take still photos.
- HP Business Card Reader—Use to transform business cards into a usable database of contact information.

---

 **NOTE:** For information about using software designed for use with the integrated webcam, refer to the webcam software Help.

---

For optimum performance, observe the following guidelines while using the integrated webcam:

- Be sure that you have the latest version of an instant message program before attempting a video conversation.
- The webcam may not work properly across some network firewalls.

 **NOTE:** If you are having trouble viewing or sending multimedia files to someone on another LAN or outside your network firewall, temporarily disable the firewall, perform the task you want to perform, and then reenable the firewall. To permanently resolve the problem, reconfigure the firewall as necessary, and adjust the policies and settings of other intrusion detection systems. For additional information, contact your network administrator or IT department.

---

- Whenever possible, place bright light sources behind the webcam and out of the picture area.

## Adjusting webcam properties

You can adjust webcam properties using the Properties dialog box, which is accessible from various programs that use the integrated webcam, usually from a configuration, settings, or properties menu:

- **Brightness**—Controls the amount of light that is incorporated into the image. A higher brightness setting creates a brighter image; a lower brightness setting creates a darker image.
- **Contrast**—Controls the difference between lighter and darker areas on the image. A higher contrast setting intensifies the image; a lower contrast setting maintains more of the original information's dynamic range but leads to a flatter image.
- **Gamma**—Controls the contrast affecting the mid-level grays or midtones of an image. Adjusting the gamma of an image allows you to change the brightness values of the middle range of gray tones without dramatically altering the shadows and highlights. A lower gamma setting makes grays look black, and makes dark colors even darker.

- **Hue**—Controls the aspect of color that distinguishes it from another color (what makes a color red, green, or blue). Hue is distinct from saturation, which measures the intensity of the hue.
- **Saturation**—Controls the strength of color in the final image. A higher saturation setting creates a bolder image; a lower saturation setting creates a more subtle image.
- **Sharpness**—Controls the definition of edges in an image. A higher sharpness setting creates a more defined image; a lower sharpness setting creates a softer image.

For information about using the webcam, select **Start > Help and Support**.

## Capturing business card images

You can use the webcam with the HP Business Card Reader program to capture business card images and export the text to many types of address book software, such as Microsoft® Outlook Contacts.

To capture a business card image:

1. Open HP Business Card Reader by selecting **Start > All Programs > HP > HP Business Card Reader**.
2. To capture one business card, click **Single Scan**.

– or –

To capture multiple business cards, click **Multi Scan**.

3. Insert a business card into the business card slot on the front of the computer (**1**), and slide the card to the left (**2**) to center it under the webcam.

---

 **NOTE:** If any text is obscured by the slot, rotate the card 180 degrees, with the text facing the webcam.

---

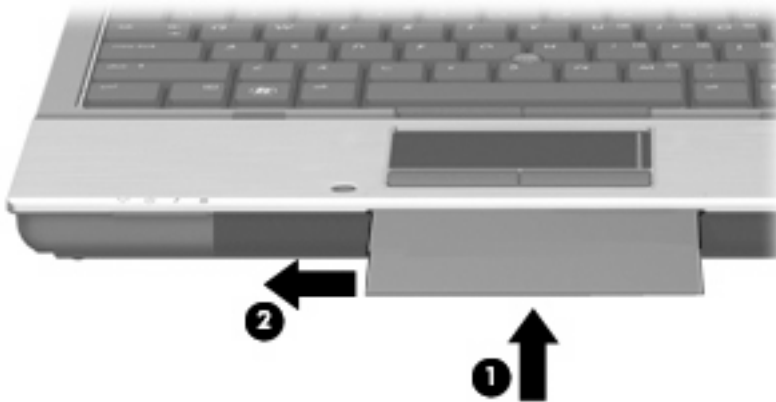

4. Slowly lower the display (1) until the webcam light (2) blinks and you hear a sound, which indicates that the webcam is now in focus.

The webcam turns on, and the scanning process starts immediately. You will hear a camera shutter sound when the image is captured, and the information from the card is filled in the fields automatically.



5. If you are capturing multiple business card images, remove the business card and insert another one. The webcam light turns on when the card is in focus. The webcam then captures the business card image and the webcam light turns off.

Repeat this step for additional business cards.

---

 **NOTE:** Do not move or raise the display until you have finished capturing all of the business cards.

---

6. When you have finished capturing one or more business card images, remove the business card from the slot and raise the display.
7. Review the information captured by Business Card Reader to be sure that it is complete.

For more information on using Business Card Reader, refer to the software Help.

---

# 5 Power management

## Setting power options

### Using power-saving states

The computer has two power-saving states enabled at the factory: Standby and Hibernation.

When Standby is initiated, the power light blinks and the screen clears. Your work is saved to memory. Exiting Standby is faster than exiting Hibernation. If the computer is in Standby for an extended period or if the battery reaches a critical battery level while in Standby, the computer initiates Hibernation.

When Hibernation is initiated, your work is saved to a hibernation file on the hard drive and the computer turns off.

---

△ **CAUTION:** To prevent possible audio and video degradation, loss of audio or video playback functionality, or loss of information, do not initiate Standby or Hibernation while reading from or writing to a disc or an external media card.

📝 **NOTE:** You cannot initiate any type of networking connection or perform any computer functions while the computer is in Standby or in Hibernation.

**NOTE:** When HP 3D DriveGuard has parked a drive, the computer will not initiate Standby or Hibernation, and the display will be turned off.

---

### Initiating and exiting Standby

The system is set at the factory to initiate Standby after 10 minutes of inactivity when running on battery power and 25 minutes of inactivity when running on external power.

Power settings and timeouts can be changed using Power Options in Windows® Control Panel.

With the computer on, you can initiate Standby in any of the following ways:

- Close the display.
- Press **fn+f3**.
- Click **Start > Turn Off Computer > Stand By**.

If Stand by is not displayed, follow these steps:

- a. Click the down arrow.
- b. Select **Stand by** from the list.
- c. Click **OK**.

To exit Standby:

- ▲ Press the power button

When the computer exits Standby, the power light turns on and your work returns to the screen where you stopped working.

---

 **NOTE:** If you have set a password to be required when the computer exits Standby, you must enter your Windows password before your work will return to the screen.

---

## Initiating and exiting Hibernation

The system is set at the factory to initiate Hibernation after 30 minutes of inactivity when running on battery power or when the battery reaches a critical battery level.

---

 **NOTE:** The system will not initiate Hibernation when running on external power.

---

Power settings and timeouts can be changed using Power Options in Windows Control Panel.

To initiate Hibernation:

1. Select **Start > Turn Off Computer**.
2. Hold down the **shift** key and select **Hibernate**.

If Hibernate is not displayed, follow these steps:

- a. Click the down arrow.
- b. Select **Hibernate** from the list.
- c. Click **OK**.

To exit Hibernation:

- ▲ Press the power button.

The power lights turn on and your work returns to the screen where you stopped working.

---

 **NOTE:** If you have set a password to be required when the computer exits Hibernation, you must enter your Windows password before your work will return to the screen.

---

## Using the Power Meter

The Power Meter is located in the notification area, at the far right of the taskbar. The Power Meter allows you to quickly access power settings and view the remaining battery charge.

- To access Power Options, right-click the **Power Meter** icon and select **Adjust Power Properties**.
- To display the percentage of remaining battery charge, double-click the **Power Meter** icon.

Different battery meter icons indicate whether the computer is running on battery or external power.

To remove the Power Meter icon from the notification area, follow these steps:

1. Right-click the **Power Meter** icon in the notification area, and then click **Adjust Power Properties**.
2. Click the **Advanced** tab.



3. Clear the **Always show icon on the taskbar** check box.
4. Click **Apply**, and then click **OK**.

To show the Power Meter icon in the notification area, follow these steps:

1. Select **Start > Control Panel > Performance and Maintenance > Power Options**.
2. Click the **Advanced** tab.
3. Select the **Always show icon on the taskbar** check box.
4. Click **Apply**, and then click **OK**.

---

 **NOTE:** If you cannot see an icon you have placed in the notification area, click the **Show Hidden Icons** icon (< or <<) in the notification area.

---

## Using power schemes

A power scheme is a collection of system settings that manages how the computer uses power. Power schemes can help you conserve power and maximize computer performance.

The following power schemes are available:

- Portable/Laptop (recommended)
- Home/Office Desk
- Presentation
- Always On
- Minimal Power Management
- Max Battery

You can change the settings of these power plans through Power Options.

## Viewing the current scheme

- ▲ Click the **Power Meter** icon in the notification area, at the far right of the taskbar.

– or –

Select **Start > Control Panel > Performance and Maintenance > Power Options**.

## Selecting a different power scheme

- ▲ Click the **Power Meter** icon in the notification area, at the far right of the taskbar, and then select a power scheme from the list.

– or –

- a. Select **Start > Control Panel > Performance and Maintenance > Power Options**.
- b. Select a power scheme from the **Power schemes** list.
- c. Click **OK**.

## Customizing power schemes

1. Select **Start > Control Panel > Performance and Maintenance > Power Options**.
2. Select a power scheme from the **Power schemes** list.
3. Modify the **Plugged in** and **Running on batteries settings** as needed.
4. Click **OK**.

## Setting password protection upon exiting Standby

To set the computer to prompt for a password when the computer exits Standby, follow these steps:

1. Right-click the **Power Meter** icon in the notification area, and then click **Adjust Power Properties**.
2. Click the **Advanced** tab.
3. Select the **Prompt for password when computer resumes from standby** check box.
4. Click **Apply**.

## Using Power Assistant (select models only)

Power Assistant allows you to configure system settings to optimize your computer's power consumption and battery charge. Power Assistant provides tools and information to help you make informed decisions on power management:

- Power consumption predictions in hypothetical system configurations
- Predefined power profiles
- Usage details and graphs showing power consumption trends over time

### Starting Power Assistant

To start Power Assistant when Windows is running, select **Start > All Programs > HP > HP Power Assistant**.

Power Assistant opens, and the following tabs are displayed:

- **Settings**—Displays the opening page, which shows battery charge and power consumption information.
- **Preferences**—Enables you to set device preferences.
- **Usage Details**—Enables you to enter information about computer use.
- **Charts**—Displays charts and graphs of power consumption.
- **About**—Displays Power Assistant Help and version information.

For more information about using, configuring, and managing Power Assistant, refer to the Power Assistant software Help.

## Using external AC power

External AC power is supplied through one of the following devices:

**⚠ WARNING!** To reduce potential safety issues, use only the AC adapter provided with the computer, a replacement AC adapter provided by HP, or a compatible AC adapter purchased from HP.

- Approved AC adapter
- Optional docking device

Connect the computer to external AC power under any of the following conditions:

**⚠ WARNING!** Do not charge the computer battery while you are onboard aircraft.

- When you are charging or calibrating a battery
- When you are installing or modifying system software
- When you are writing information to a CD or DVD

When you connect the computer to external AC power, the following events occur:

- The battery begins to charge.
- If the computer is turned on, the power meter icon in the notification area changes appearance.

When you disconnect external AC power, the following events occur:

- The computer switches to battery power.
- The display brightness is automatically decreased to save battery life. To increase display brightness, press the **fn+f10** hotkey or reconnect the AC adapter.

## Connecting the AC adapter

**⚠ WARNING!** To reduce the risk of electric shock or damage to the equipment:

Plug the power cord into an AC outlet that is easily accessible at all times.

Disconnect power from the computer by unplugging the power cord from the AC outlet (not by unplugging the power cord from the computer).

If provided with a 3-pin attachment plug on the power cord, plug the cord into a grounded (earthed) 3-pin outlet. Do not disable the power cord grounding pin, for example, by attaching a 2-pin adapter. The grounding pin is an important safety feature.

To connect the computer to external AC power, follow these steps:

1. Plug the AC adapter into the power connector **(1)** on the computer.
2. Plug the power cord into the AC adapter **(2)**.
3. Plug the other end of the power cord into an AC outlet **(3)**.

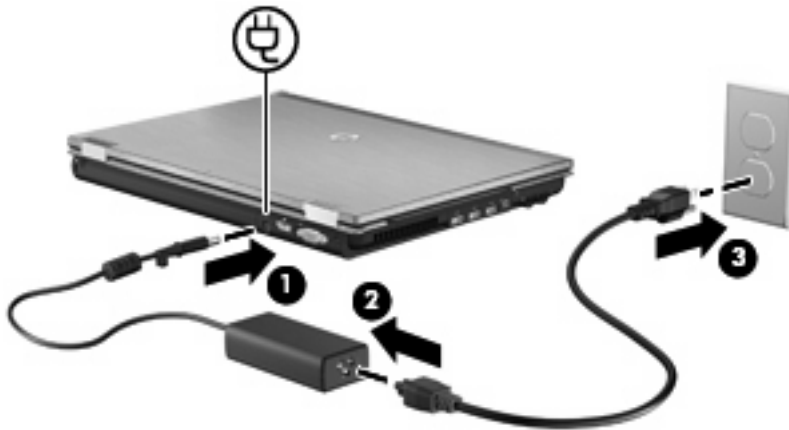

## Using battery power

When a charged battery is in the computer and the computer is not plugged into external power, the computer runs on battery power. When the computer is plugged into external AC power, the computer runs on AC power.

If the computer contains a charged battery and is running on external AC power supplied through the AC adapter, the computer switches to battery power if the AC adapter is disconnected from the computer.

**📖 NOTE:** The display brightness is decreased to save battery life when you disconnect AC power. To increase display brightness, use the **fn+f10** hotkey or reconnect the AC adapter.

You can keep a battery in the computer or in storage, depending on how you work. Keeping the battery in the computer whenever the computer is plugged into AC power charges the battery and also protects your work in case of a power outage. However, a battery in the computer slowly discharges when the computer is off and unplugged from external power.

---

⚠ **WARNING!** To reduce potential safety issues, use only the battery provided with the computer, a replacement battery provided by HP, or a compatible battery purchased from HP.

---

Computer battery life varies, depending on power management settings, programs running on the computer, display brightness, external devices connected to the computer, and other factors.

## Displaying the remaining battery charge

▲ Double-click the **Power Meter** icon in the notification area, at the far right of the taskbar.

– or –

Select **Start > Control Panel > Performance and Maintenance > Power Options > Power Meter** tab.

Most charge indicators report battery status as both a percentage and as the number of minutes of charge remaining:

- The percentage indicates the approximate amount of charge remaining in the battery.
- The time indicates the approximate running time remaining on the battery *if the battery continues to provide power at the current level*. For example, the time remaining will decrease when a DVD is playing and will increase when a DVD stops playing.

When a battery is charging, a lightning bolt icon may be superimposed over the battery icon on the Power Meter screen.

## Inserting or removing the battery

---

⚠ **CAUTION:** Removing a battery that is the sole power source can cause loss of information. To prevent loss of information, save your work and initiate Hibernation or shut down the computer through Windows before removing the battery.

---

To insert the battery:

1. Turn the computer upside down on a flat surface.

2. Insert the battery (1) into the battery bay until it is seated.

The battery release latch (2) automatically locks the battery into place.

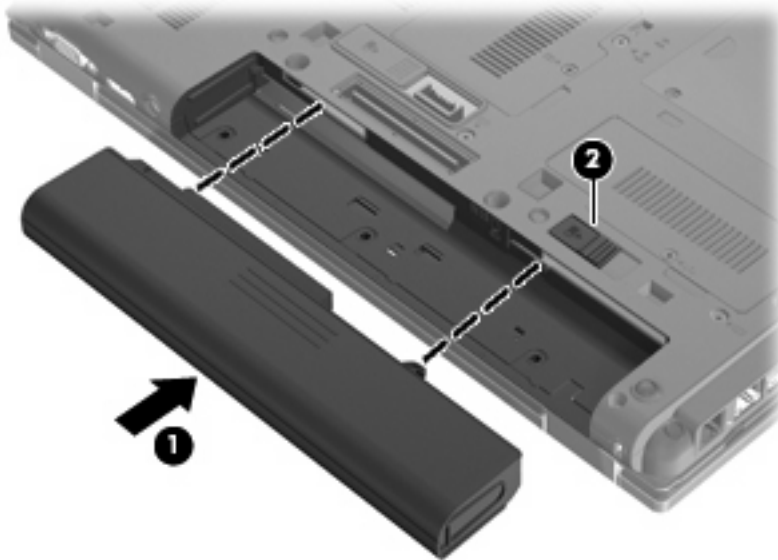

To remove the battery:

1. Turn the computer upside down on a flat surface.
2. Slide the battery release latch (1) to release the battery.
3. Remove the battery from the computer (2).

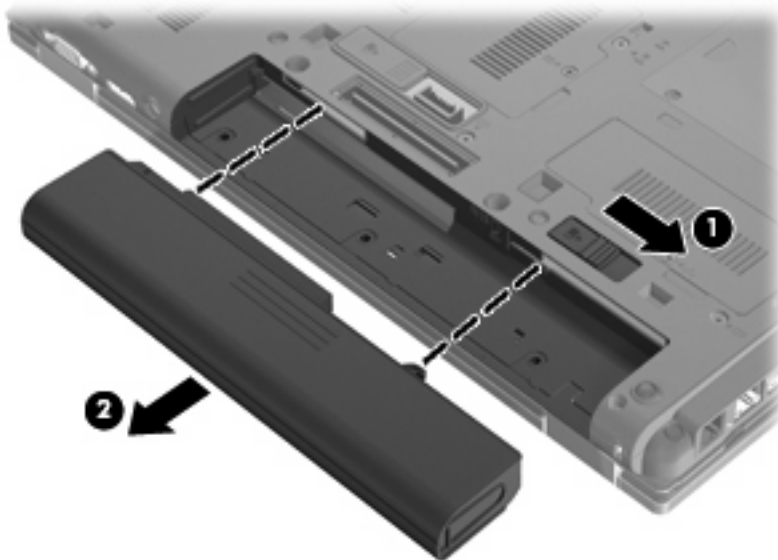

## Charging a battery

**⚠ WARNING!** Do not charge the computer battery while you are onboard aircraft.

The battery charges whenever the computer is plugged into external power through an AC adapter, an optional power adapter, or an optional docking device.

The battery charges whether the computer is off or in use, but it charges faster when the computer is off.

Charging may take longer if a battery is new, has been unused for 2 weeks or more, or is much warmer or cooler than room temperature.

To prolong battery life and optimize the accuracy of battery charge displays, follow these recommendations:

- If you are charging a new battery, charge it fully before turning on the computer.
- Charge the battery until the battery light turns off.

---

 **NOTE:** If the computer is on while the battery is charging, the battery meter in the notification area may show 100 percent charge before the battery is fully charged.

---

- Allow the battery to discharge below 5 percent of a full charge through normal use before charging it.
- If the battery has been unused for one month or more, calibrate the battery instead of simply charging it.

The battery light displays charge status:

- Amber: The battery is charging.
- Turquoise: A battery is close to full charge capacity.
- Blinking amber: A battery that is the only available power source has reached a low battery level. When the battery reaches a critical battery level, the battery light begins blinking rapidly.
- Off: If the computer is plugged into an external power source, the light turns off when all batteries in the computer are fully charged. If the computer is not plugged into an external power source, the light stays off until the battery reaches a low battery level.

## Maximizing battery discharge time

Battery discharge time varies, depending on the features you use while on battery power. Maximum discharge time gradually shortens as the battery storage capacity naturally degrades.

Tips for maximizing battery discharge time:

- Lower the brightness on the display.
- Remove the battery from the computer when it is not being used or charged.
- Store the battery in a cool, dry location.

## Managing low battery levels

The information in this section describes the alerts and system responses set at the factory. Some low-battery alerts and system responses can be changed using Power Options in Windows Control Panel. Preferences set using Power Options do not affect lights.

## Identifying low battery levels

When a battery that is the sole power source for the computer reaches a low battery level, the battery light blinks.

If a low battery level is not resolved, the computer enters a critical battery level, and the battery light blinks rapidly.

The computer takes the following actions for a critical battery level:

- If Hibernation is enabled and the computer is on or in Standby, the computer initiates Hibernation.
- If Hibernation is disabled and the computer is on or in Standby, the computer remains briefly in Standby, and then shuts down and loses any unsaved information.

## Resolving a low battery level

△ **CAUTION:** To reduce the risk of losing information when the computer reaches a critical battery level and has initiated Hibernation, do not restore power until the power lights turn off.

### Resolving a low battery level when external power is available

- ▲ Connect one of the following devices:
  - AC adapter
  - Optional expansion product or docking device
  - Optional power adapter

### Resolving a low battery level when a charged battery is available

1. Turn off the computer or initiate Hibernation.
2. Remove the discharged battery, and then insert a charged battery.
3. Turn on the computer.

### Resolving a low battery level when no power source is available

- ▲ Initiate Hibernation.  
– or –  
Save your work and shut down the computer.

### Resolving a low battery level when the computer cannot exit Hibernation

When the computer lacks sufficient power to exit Hibernation, follow these steps:

1. Insert a charged battery or plug the computer into external power.
2. Exit Hibernation by briefly pressing the power button.

## Calibrating a battery

Calibrate a battery under the following conditions:

- When battery charge displays seem inaccurate
- When you observe a significant change in battery run time

Even if a battery is heavily used, it should not need to be calibrated more than once a month. It is also not necessary to calibrate a new battery.



## Step 1: Fully charge the battery

 **WARNING!** Do not charge the computer battery while you are onboard aircraft.

 **NOTE:** The battery charges whether the computer is off or in use, but it charges faster when the computer is off.

To fully charge the battery:

1. Insert the battery into the computer.
2. Connect the computer to an AC adapter, optional power adapter, optional expansion product, or optional docking device, and then plug the adapter or device into external power.

The battery light on the computer turns on.

3. Leave the computer plugged into external power until the battery is fully charged.

The battery light on the computer turns off.

## Step 2: Disable Hibernation and Standby

1. Right-click the **Power Meter** icon in the notification area, at the far right of the taskbar, and then click **Adjust Power Properties**.

– or –

Select **Start > Control Panel > Performance and Maintenance > Power Options**.

2. Record the 4 settings listed in the **Running on batteries** and **Plugged in** columns so that you can reset them after the calibration.
3. Set the 4 options to **Never**.
4. Click **OK**.

## Step 3: Discharge the battery

The computer must remain on while the battery is being discharged. The battery can discharge whether or not you are using the computer, but the battery will discharge faster while you are using it.

- If you plan to leave the computer unattended during the discharge, save your information before beginning the discharge procedure.
- If you use the computer occasionally during the discharge procedure and have set energy-saving timeouts, expect the following performance from the system during the discharge process:
  - The monitor will not turn off automatically.
  - Hard drive speed will not decrease automatically when the computer is idle.
  - System-initiated Hibernation will not occur.

To discharge a battery:

1. Unplug the computer from its external power source, but do *not* turn off the computer.
2. Run the computer on battery power until the battery is discharged. The battery light begins to blink when the battery has discharged to a low battery level. When the battery is discharged, the battery light turns off and the computer shuts down.

## Step 4: Fully recharge the battery

To recharge the battery:

1. Plug the computer into external power and maintain external power until the battery is fully recharged. When the battery is recharged, the battery light on the computer turns off.

You can use the computer while the battery is recharging, but the battery will charge faster if the computer is off.

2. If the computer is off, turn it on when the battery is fully charged and the battery light has turned off.

## Step 5: Reenable Hibernation and Standby

---

△ **CAUTION:** Failure to reenable Hibernation after calibration may result in a full battery discharge and information loss if the computer reaches a critical battery level.

---

1. Select **Start > Control Panel > Performance and Maintenance > Power Options**.
2. Reenter the settings that you recorded for the items in the **Plugged in** column and the **Running on batteries** column.
3. Click **OK**.

## Conserving battery power

- Select low power-use settings through Power Options in Windows Control Panel.
- Turn off wireless and local area network (LAN) connections and exit modem applications when you are not using them.
- Disconnect external devices that are not plugged into an external power source, when you are not using them.
- Stop, disable, or remove any external media cards that you are not using.
- Use the **fn+f9** and **fn+f10** hotkeys to adjust screen brightness as needed.
- If you leave your work, initiate Standby or Hibernation, or shut down the computer.

## Storing a battery

---

△ **CAUTION:** To prevent damage to a battery, do not expose it to high temperatures for extended periods of time.

---

If a computer will be unused and unplugged from external power for more than 2 weeks, remove the battery and store it separately.

To prolong the charge of a stored battery, place it in a cool, dry place.

---

 **NOTE:** A stored battery should be checked every 6 months. If the capacity is less than 50 percent, recharge the battery before returning it to storage.

---

Calibrate a battery before using it if it has been stored for one month or more.

## Disposing of a used battery

 **WARNING!** To reduce the risk of fire or burns, do not disassemble, crush, or puncture; do not short external contacts; do not dispose of in fire or water.

---

Refer to the *Regulatory, Safety and Environmental Notices* for battery disposal information.

## Replacing the battery

Computer battery life varies, depending on the power management settings, programs running on the computer, display brightness, external devices connected to the computer, and other factors.

Battery Check notifies you to replace the battery when an internal cell is not charging properly, or when the battery storage capacity has reached a “weak” condition. A message refers you to the HP Web site for more information about ordering a replacement battery. If the battery is possibly covered by an HP warranty, instructions include a warranty ID.

 **NOTE:** To ensure that you always have battery power when you need it, HP recommends purchasing a new battery when the storage capacity indicator turns green-yellow.

---

## Testing an AC adapter

Test the AC adapter if the computer exhibits any of the following symptoms:

- The computer will not turn on when connected to the AC adapter.
- The display does not turn on when the computer is connected to the AC adapter and external power.
- The power light is off when the computer is connected to the AC adapter.

To test the AC adapter:

1. Remove the battery from the computer.
2. Connect the AC adapter to the computer and to an AC outlet.
3. Turn on the computer.
  - If the power light turns **on**, the AC adapter is functioning properly.
  - If the power light remains **off**, the AC adapter is not functioning and should be replaced.

Contact technical support for information on obtaining a replacement AC power adapter. Select **Start > Help and Support > Contact support**.

## Shutting down the computer

---

△ **CAUTION:** Unsaved information will be lost when the computer is shut down.

---

The Shut Down command closes all open programs, including the operating system, and then turns off the display and computer.

Shut down the computer under any of the following conditions:

- When you need to replace the battery or access components inside the computer
- When you are connecting an external hardware device that does not connect to a USB port
- When the computer will be unused and disconnected from external power for an extended period

Although you can shut down the computer with the power button, the recommended procedure is to use the Windows Shut Down command.

To shut down the computer, follow these steps:

---

📝 **NOTE:** If the computer is in Standby or in Hibernation, you must first exit Standby or Hibernation before shutdown is possible.

---

1. Save your work and close all open programs.
2. Select **Start > Turn Off Computer > Turn Off**.

---

📝 **NOTE:** If you have been registered to a network domain, the button you click will be called Shut Down instead of Turn Off Computer.

---

If the computer is unresponsive and you are unable to use the preceding shutdown procedures, try the following emergency procedures in the sequence provided:

- Press [ctrl+alt+delete](#). Then, click **Shut Down > Turn Off**.
- Press and hold the power button for at least 5 seconds.
- Disconnect the computer from external power and remove the battery.

---

# 6 Drives

## Identifying installed drives

Your computer includes a hard drive (with a rotating disc) or a solid-state drive (SSD) with solid-state memory. Because it has no moving parts, an SSD does not generate as much heat as a hard drive.

To view the drives installed on the computer, select **Start > My Computer**.

## Handling drives

Drives are fragile computer components that must be handled with care. Refer to the following cautions before handling drives. Additional cautions are included with the procedures to which they apply.

△ **CAUTION:** To reduce the risk of damage to the computer, damage to a drive, or loss of information, observe these precautions:

Before you move a computer that is connected to an external hard drive, initiate Standby and allow the screen to clear, or properly disconnect the external hard drive.

Before handling a drive, discharge static electricity by touching the unpainted metal surface of the drive.

Do not touch the connector pins on a removable drive or on the computer.

Handle a drive carefully; do not drop a drive or place items on it.

Before removing or inserting a drive, shut down the computer. If you are unsure whether the computer is off, in Standby, or in Hibernation, turn the computer on and then shut it down through the operating system.

Do not use excessive force when inserting a drive into a drive bay.

Do not type on the keyboard or move the computer while an optional optical drive is writing to a disc. The write process is sensitive to vibration.

When the battery is the only source of power, be sure that the battery is sufficiently charged before writing to media.

Avoid exposing a drive to temperature or humidity extremes.

Avoid exposing a drive to liquids. Do not spray the drive with cleaning products.

Remove media from a drive before removing the drive from the drive bay, or traveling with, shipping, or storing a drive.

If a drive must be mailed, place the drive in a bubble-pack mailer or other suitable protective packaging and label the package "FRAGILE."

Avoid exposing a drive to magnetic fields. Security devices with magnetic fields include airport walk-through devices and security wands. The airport security devices that check carry-on luggage, such as conveyor belts, use X-rays instead of magnetism and will not damage a drive.

# Improving hard drive performance

## Using Disk Defragmenter

As you use the computer, files on the hard drive become fragmented. Disk Defragmenter consolidates the fragmented files and folders on the hard drive so that the system can run more efficiently.

After you start Disk Defragmenter, it works without supervision. Depending on the size of your hard drive and the number of fragmented files, Disk Defragmenter may take more than an hour to complete. You may want to set it to run during the night or another time when you do not need access to your computer.

HP recommends defragmenting your hard drive at least once a month. You may set Disk Defragmenter to run on a monthly schedule, but you can defragment your computer manually at any time.

---

 **NOTE:** It is not necessary to run Disk Defragmenter on solid-state drives.

---

To run Disk Defragmenter:

1. Select **Start > All Programs > Accessories > System Tools > Disk Defragmenter**.
2. Under **Volume**, click the listing for the hard drive, usually listed as (C:), and then click **Defragment**.

For additional information, access the Disk Defragmenter software Help.

## Using Disk Cleanup

Disk Cleanup searches the hard drive for unnecessary files that you can safely delete to free up disk space and help the computer to run more efficiently.

To run Disk Cleanup:

1. Select **Start > All Programs > Accessories > System Tools > Disk Cleanup**.
2. Follow the on-screen instructions.



# Using HP 3D DriveGuard

HP 3D DriveGuard protects the hard drive by parking the drive and halting I/O requests under either of the following conditions:

- You drop the computer.
- You move the computer with the display closed while the computer is running on battery power.

A short time after the end of one of these events, HP 3D DriveGuard returns the hard drive to normal operation.

---

 **NOTE:** Solid-state drives lack rotating parts, so protection by HP 3D DriveGuard is unnecessary.

**NOTE:** If the upgrade bay contains a hard drive, the hard drive is protected by HP 3D DriveGuard. Hard drives that are in an optional docking device or are connected to a USB port are not protected by HP 3D DriveGuard.

---

For more information, refer to the HP 3D DriveGuard software Help.

## Identifying HP 3D DriveGuard status

The drive light on the computer changes to an amber color to show that the drive is parked. To determine whether drives are currently protected or whether a drive is parked, use the icon in the notification area, at the far right of the taskbar:

- If the software is enabled, a green check mark is superimposed over the hard drive icon.
- If the software is disabled, a red X is superimposed over the hard drive icon.
- If the drives are parked, a yellow moon is superimposed over the hard drive icon.

If HP 3D DriveGuard has parked the drive, the computer will behave in the following ways:

- The computer will not shut down.
- The computer will not initiate Standby or Hibernation, except as described in the following Note.

---

 **NOTE:** If the computer is running on battery power and reaches a critical battery level, HP 3D DriveGuard allows the computer to initiate Hibernation.

---

- The computer will not activate battery alarms set on the Alarms tab in Power Options Properties.

Before you move the computer, HP recommends that you either shut it down or initiate Standby or Hibernation.

## Using HP 3D DriveGuard software

The HP 3D DriveGuard software enables you to perform the following tasks:

- Enable and disable HP 3D DriveGuard.

---

 **NOTE:** Depending on your user privileges, you may not be able to enable or disable HP 3D DriveGuard.

---

- Determine whether a drive in the system is supported.
- Hide or show the icon in the notification area.

To open the software and change settings, follow these steps:

1. Double-click the icon in the notification area, at the far right of the taskbar.

– or –

Right-click the icon in the notification area, and then select **Settings**.

2. Click the appropriate button to change settings.
3. Click **OK**.

## Replacing a hard drive in the hard drive bay

△ **CAUTION:** To prevent information loss or an unresponsive system:

Shut down the computer before removing the hard drive from the hard drive bay. Do not remove the hard drive while the computer is on, in Standby, or in Hibernation.

If you are not sure whether the computer is off or in Hibernation, turn the computer on by briefly pressing the power button. Then shut down the computer through the operating system.

To remove a hard drive:

1. Save your work.
2. Shut down the computer and close the display.
3. Disconnect all external hardware devices connected to the computer.
4. Unplug the power cord from the AC outlet.
5. Turn the computer upside down on a flat surface.
6. Remove the battery from the computer.
7. Loosen the 2 hard drive cover screws (1).
8. Remove the hard drive cover (2).

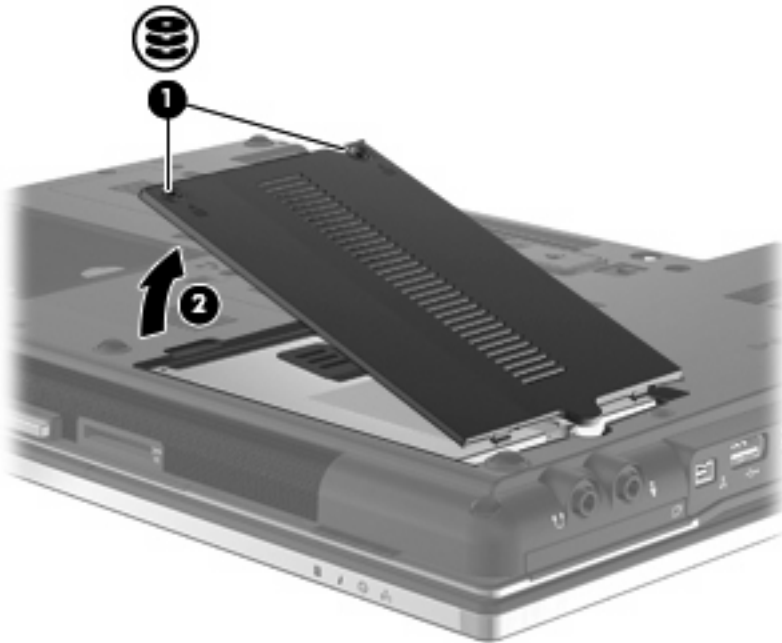

9. Loosen the hard drive screw (1).
10. Pull the hard drive tab to the right (2) to disconnect the hard drive.

11. Lift the hard drive (3) out of the hard drive bay.

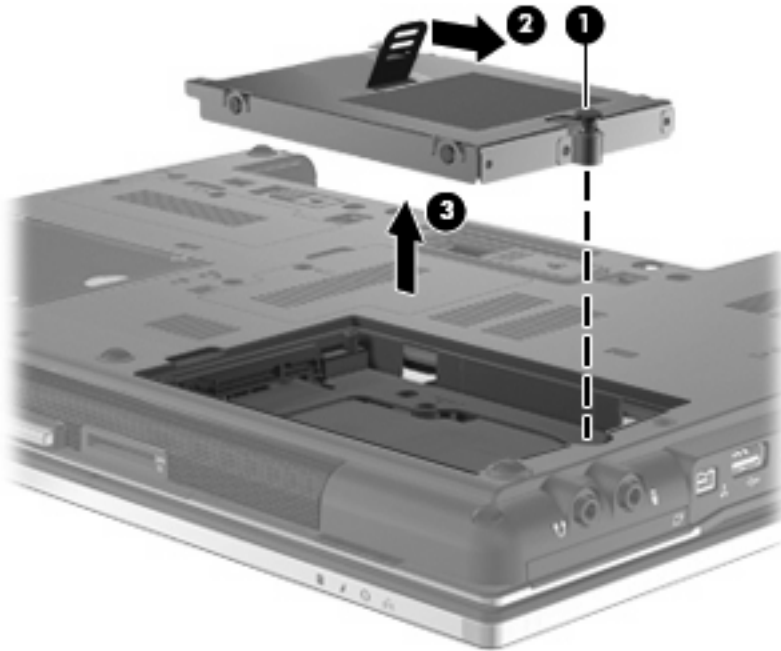

To install a hard drive:

1. Insert the hard drive into the hard drive bay (1).
2. Pull the hard drive tab (2) to the left to connect the hard drive.
3. Tighten the hard drive screw (3).

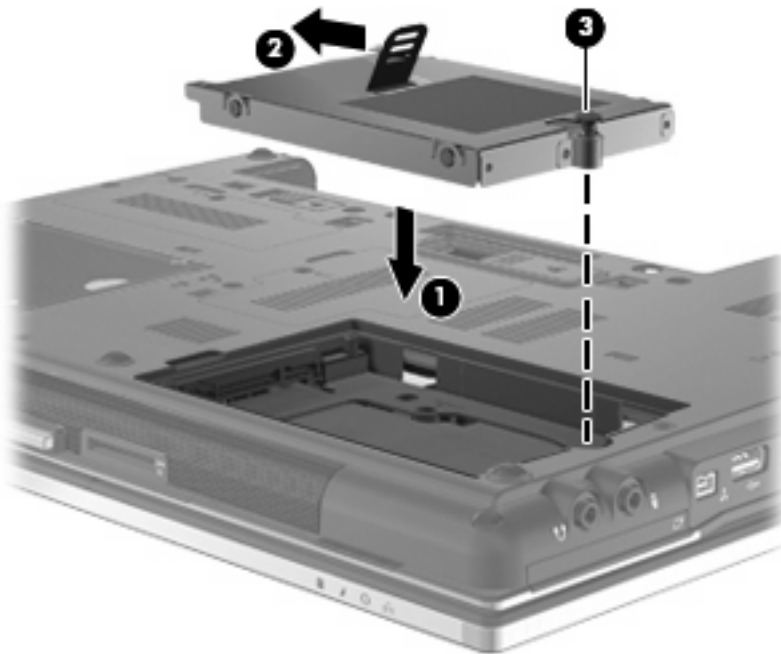

4. Align the tabs (1) on the hard drive cover with the notches on the computer.
5. Replace the cover (2).

6. Tighten the hard drive cover screws (3).

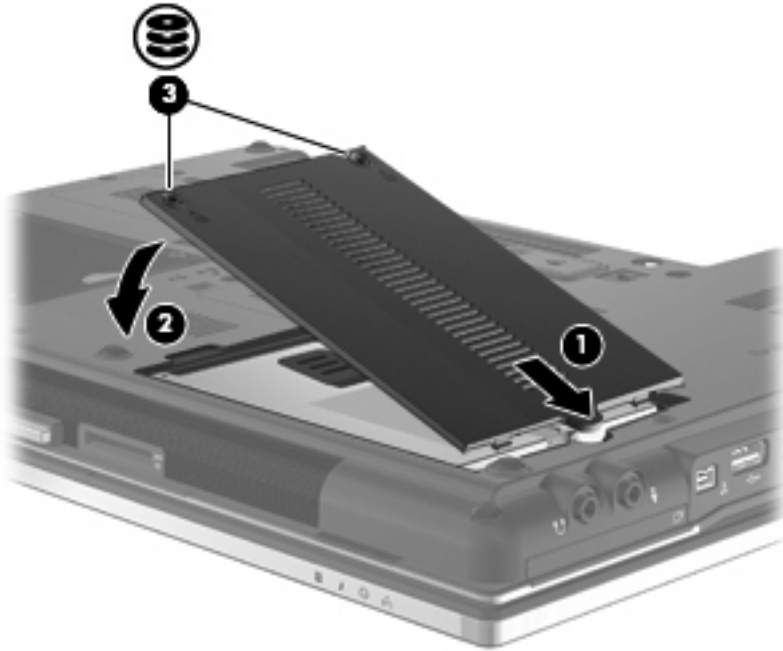

7. Replace the battery.
8. Turn the computer right-side up, and then reconnect external power and external devices.
9. Turn on the computer.

## Replacing a drive in the upgrade bay

The upgrade bay can hold either a hard drive or an optical drive.

### Removing the protective insert

The upgrade bay may contain a protective insert. You must remove the insert before inserting a drive into the upgrade bay. To remove the insert:

1. Save your work.
2. Shut down the computer and close the display.
3. Disconnect all external hardware devices connected to the computer.
4. Unplug the power cord from the AC outlet.
5. Turn the computer upside down on a flat surface.
6. Loosen the upgrade bay screw (1).
7. Using a flat-bladed screwdriver, gently push the tab to release the optical drive (2).
8. Remove the protective insert (3) from the upgrade bay.

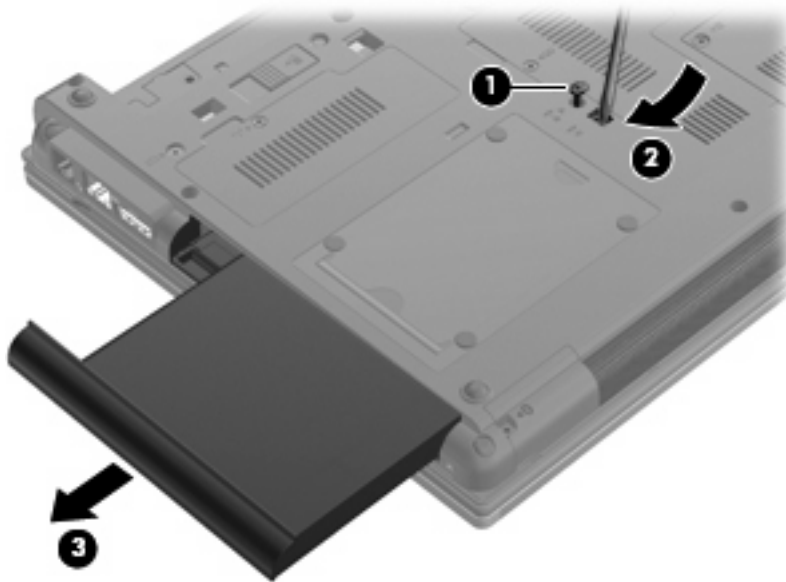

### Replacing a hard drive

△ **CAUTION:** To prevent information loss or an unresponsive system:

Shut down the computer before removing the hard drive from the upgrade bay. Do not remove the hard drive while the computer is on, in Standby, or in Hibernation.

If you are not sure whether the computer is off or in Hibernation, turn the computer on by pressing the power button. Then shut down the computer through the operating system.

To remove a hard drive from the upgrade bay:

1. Save your work.
2. Shut down the computer and close the display.
3. Disconnect all external hardware devices connected to the computer.
4. Unplug the power cord from the AC outlet.
5. Turn the computer upside down on a flat surface.
6. Remove the battery from the computer.
7. Remove the protective screw caps (1), and then remove the 4 hard drive screws (2).

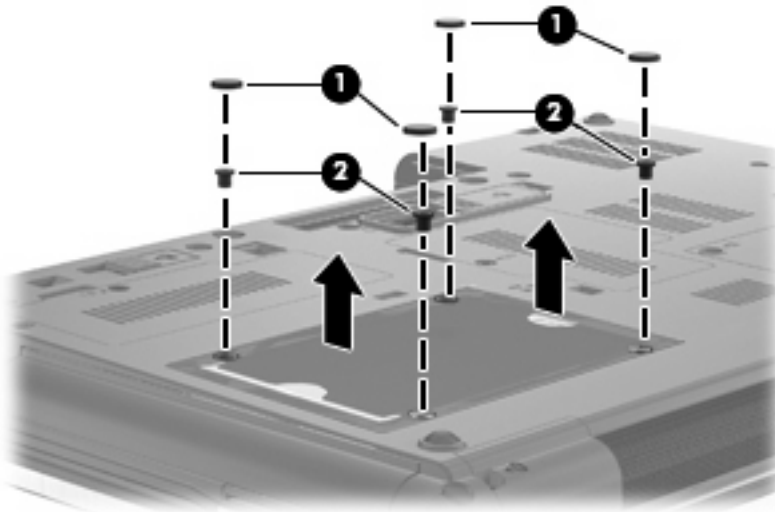

8. Loosen the upgrade bay screw (1).
9. Using a flat-bladed screwdriver, gently push the tab to release the hard drive (2).

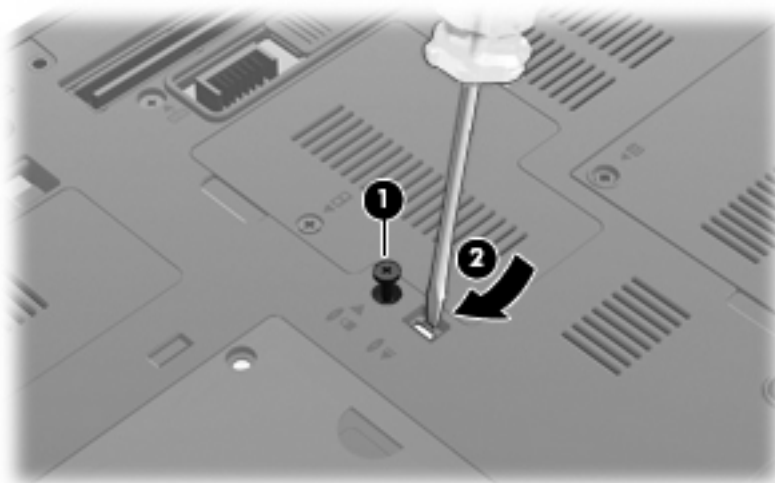

10. Remove the hard drive from the upgrade bay.

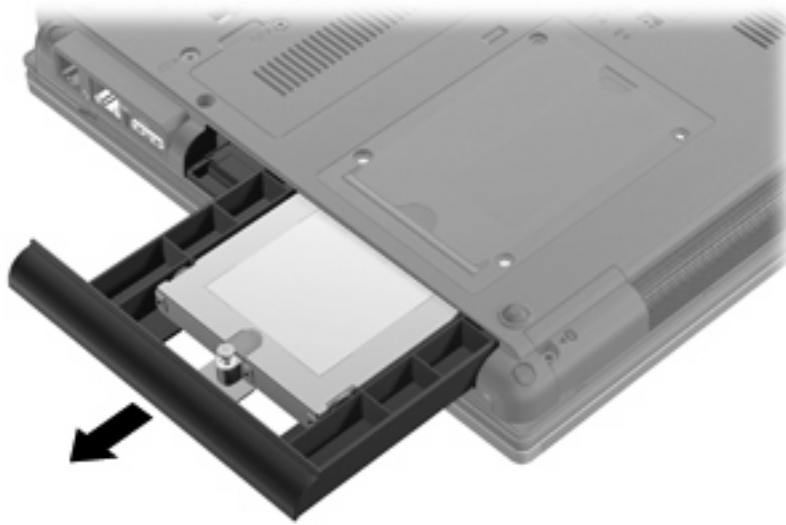

To install a hard drive in the upgrade bay:

1. Insert the hard drive into the upgrade bay.





2. Tighten the upgrade bay screw.

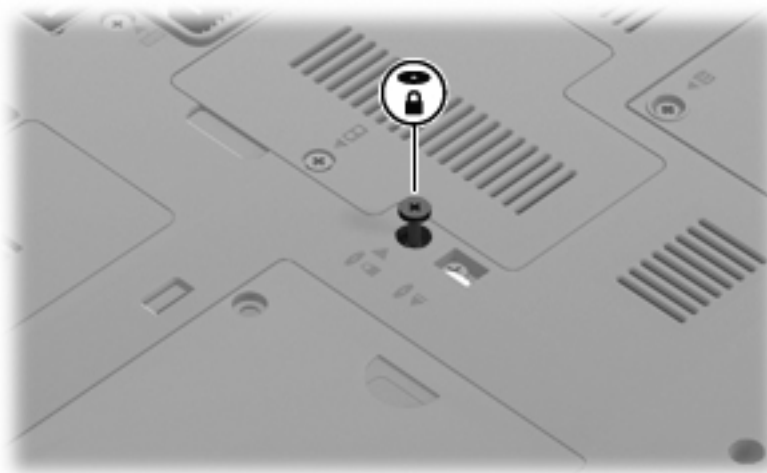

3. Replace the 4 hard drive screws (1), and then replace the protective screw caps (2).

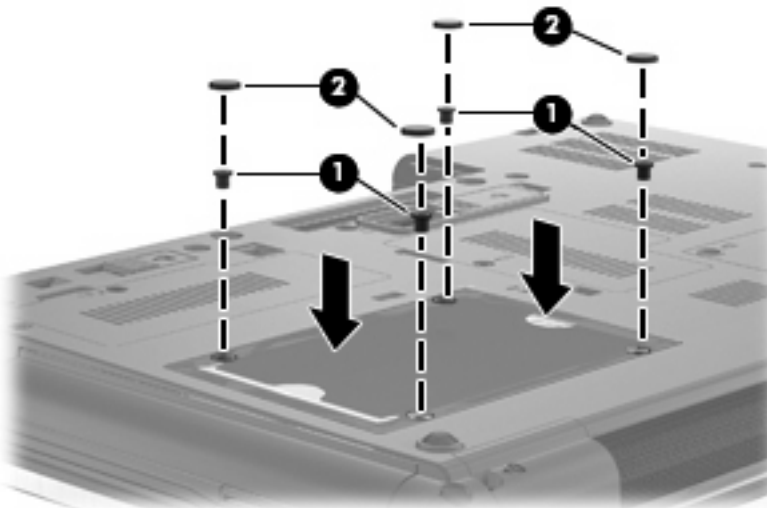

4. Replace the battery.
5. Turn the computer right-side up, and then reconnect external power and external devices.
6. Turn on the computer.

## Replacing an optical drive

△ **CAUTION:** To prevent information loss or an unresponsive system:

Shut down the computer before removing the optical drive from the upgrade bay. Do not remove the optical drive while the computer is on, in Standby, or in Hibernation.

If you are not sure whether the computer is off or in Hibernation, turn the computer on by pressing the power button. Then shut down the computer through the operating system.

To remove an optical drive from the upgrade bay:

1. Save your work.
2. Shut down the computer and close the display.
3. Disconnect all external hardware devices connected to the computer.
4. Unplug the power cord from the AC outlet.
5. Turn the computer upside down on a flat surface.
6. Remove the battery from the computer.
7. Loosen the upgrade bay screw (1).
8. Using a flat-bladed screwdriver, gently push the tab to release the optical drive (2).

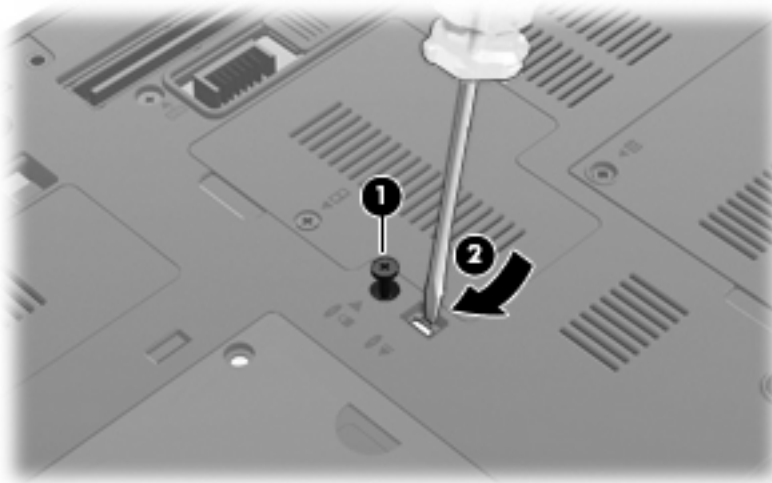

9. Remove the optical drive from the upgrade bay.

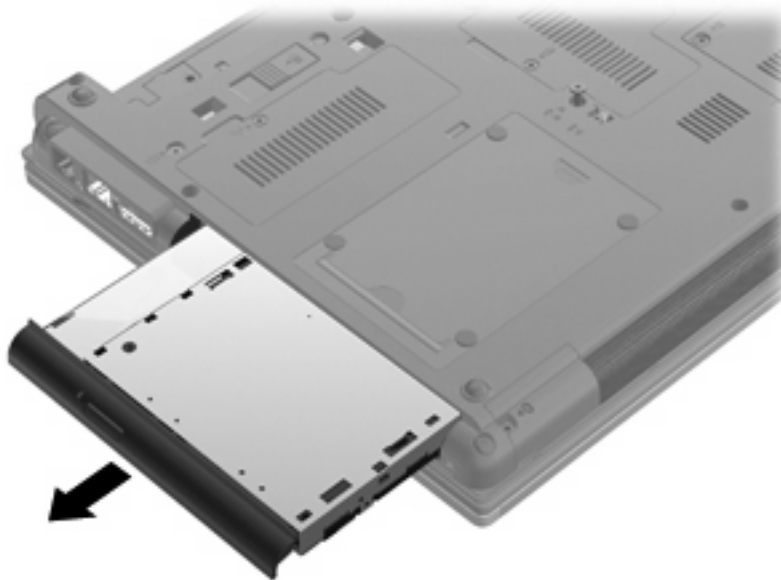

To install an optical drive in the upgrade bay:

1. Insert the optical drive into the upgrade bay.

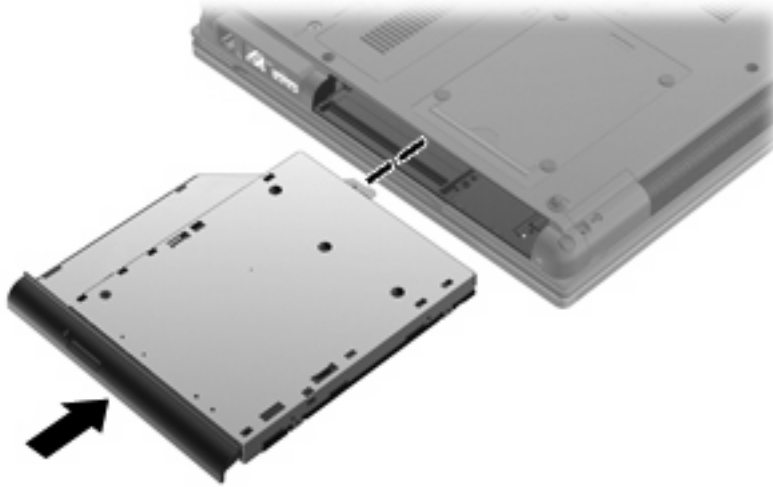

2. Tighten the upgrade bay screw.



3. Replace the battery.
4. Turn the computer right-side up, and then reconnect external power and external devices.
5. Turn on the computer.

---

# 7 External devices

## Using a USB device

Universal Serial Bus (USB) is a hardware interface that can be used to connect an optional external device, such as a USB keyboard, mouse, drive, printer, scanner, or hub.

Some USB devices may require additional support software, which is usually included with the device. For more information about device-specific software, refer to the manufacturer's instructions.

Your computer model has 4 USB ports, which support USB 1.0, USB 1.1, and USB 2.0 devices.

An optional docking device or a USB hub provide additional USB ports that can be used with the computer.

## Connecting a USB device

---

△ **CAUTION:** To prevent damage to a USB connector, use minimal force to connect a USB device.

▲ To connect a USB device to the computer, connect the USB cable for the device to the USB port.



You will hear a sound when the device has been detected.

---

📄 **NOTE:** The first time you connect a USB device, a message is displayed in the notification area to let you know the device is recognized by the computer.

---

## Stopping and removing a USB device

△ **CAUTION:** To prevent loss of information or an unresponsive system, stop a USB device before removing it.

**CAUTION:** To prevent damage to a USB connector, do not pull on the cable to remove the USB device.

To stop and remove a USB device:

1. Double-click the **Safely Remove Hardware** icon in the notification area, at the far right of the taskbar.

 **NOTE:** To display the Safely Remove Hardware icon, click the **Show Hidden Icons** icon (< or <<) in the notification area.

2. Click the name of the device in the list.

 **NOTE:** If the USB device is not listed, you do not have to stop the device before you remove it.

3. Click **Stop**, and then click **OK**.
4. Remove the device.

## Using USB legacy support

USB legacy support (enabled at the factory) permits the following actions:

- Using a USB keyboard, mouse, or hub connected to a USB port on the computer during startup or in an MS-DOS-based program or utility
- Starting or restarting from an optional external MultiBay or an optional USB bootable device

To disable or reenab le USB legacy support in Computer Setup, follow these steps:

1. Turn on or restart the computer, and then press **esc** while the “Press the ESC key for Startup Menu” message is displayed at the bottom of the screen.
2. Press **f10** to enter BIOS Setup.
3. Use a pointing device or the arrow keys to select **System Configuration**, and then select **Device Configurations**.
4. To disable USB legacy support, click **Disabled** next to **USB legacy support**. To reenab le USB legacy support, click **Enabled** next to **USB legacy support**.
5. To save your changes and exit Computer Setup, click **Save** in the lower-left corner of the screen, and then follow the on-screen instructions.

– or –

Use the arrow keys to select **File > Save changes and exit**, and then follow the on-screen instructions.

Your changes go into effect when the computer restarts.

## Using a 1394 device

IEEE 1394 is a hardware interface that connects a high-speed multimedia or data storage device to the computer. Scanners, digital cameras, and digital camcorders often require a 1394 connection.

Some 1394 devices may require additional support software, which is usually included with the device. For more information about device-specific software, refer to the manufacturer's instructions.

The 1394 port also supports IEEE 1394a devices.

## Connecting a 1394 device

---

△ **CAUTION:** To prevent damage to a 1394 port connector, use minimal force when connecting a 1394 device.

---

▲ To connect a 1394 device to the computer, connect the 1394 cable for the device to the 1394 port.

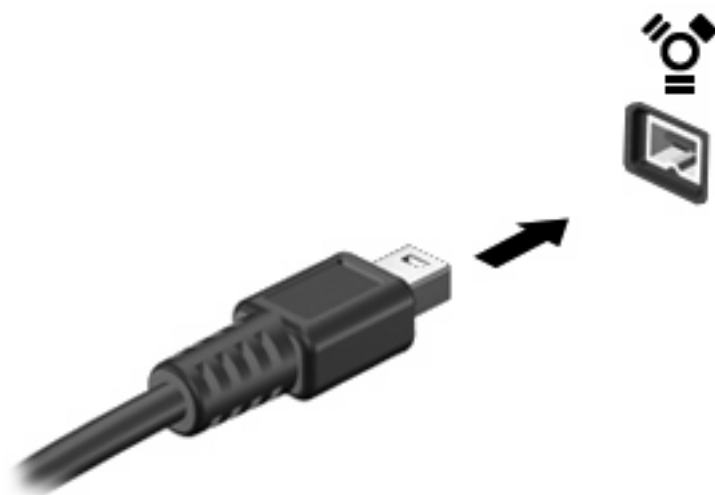

You will hear a sound when the device has been detected.

## Stopping and removing a 1394 device

---

△ **CAUTION:** To prevent loss of information or an unresponsive system, stop the 1394 device before removing it.

---

**CAUTION:** To prevent damage to a 1394 connector, do not pull on the cable to remove the 1394 device.

---

1. Double-click the **Safely Remove Hardware** icon in the notification area, at the far right of the taskbar.

📄 **NOTE:** To display the Safely Remove Hardware icon, click the **Show Hidden Icons** icon (< or <<) in the notification area.

---

2. Click the name of the device in the list.

📄 **NOTE:** If the device is not listed, you do not have to stop the device before you remove it.

---

3. Click **Stop**, and then click **OK**.
4. Remove the device.

## Using external drives

Removable external drives expand your options for storing and accessing information. A USB drive can be added by connecting the drive to a USB port on the computer.

USB drives include the following types:

- 1.44-megabyte diskette drive
- Hard drive module (a hard drive with an adapter attached)
- DVD-ROM Drive
- DVD/CD-RW Combo Drive
- DVD±RW/CD-RW Combo Drive

## Using optional external devices

---

 **NOTE:** For more information about required software and drivers, or to learn which computer port to use, refer to the manufacturer's instructions.

---

To connect an external device to the computer:

 **CAUTION:** To reduce the risk of damage to the equipment when connecting a powered device, be sure that the device is turned off and the AC power cord is unplugged.

---

1. Connect the device to the computer.
2. If you are connecting a powered device, plug the device power cord into a grounded AC outlet.
3. Turn on the device.

To disconnect an unpowered external device, turn off the device, and then disconnect it from the computer. To disconnect a powered external device, turn off the device, disconnect it from the computer, and then unplug the AC power cord.



## Using a docking device

The docking connector connects the computer to an optional docking device. An optional docking device provides additional ports and connectors that can be used with the computer.

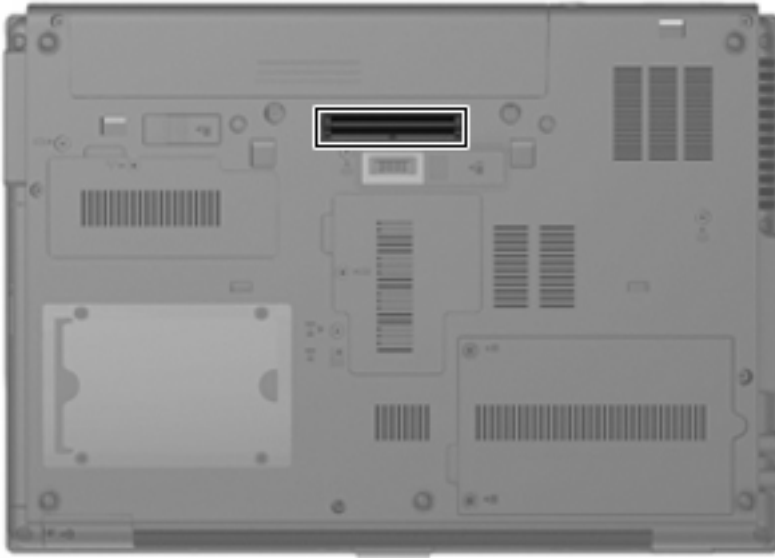

---

## 8 External media cards

### Using SD Card Reader cards

Optional digital cards provide secure data storage and convenient data sharing. These cards are often used with digital media–equipped cameras and PDAs as well as with other computers.

The SD Card Reader supports the following formats:

- MultiMediaCard (MMC)
- Secure Digital (SD) Memory Card

### Inserting a digital card

△ **CAUTION:** To avoid damaging the digital card or the computer, do not insert any type of adapter into the SD Card Reader.

**CAUTION:** To prevent damage to the digital card connectors, use minimal force to insert a digital card.

1. Hold the digital card label-side up, with the connectors facing the computer.
2. Insert the card into the SD Card Reader, and then push in on the card until it is firmly seated.

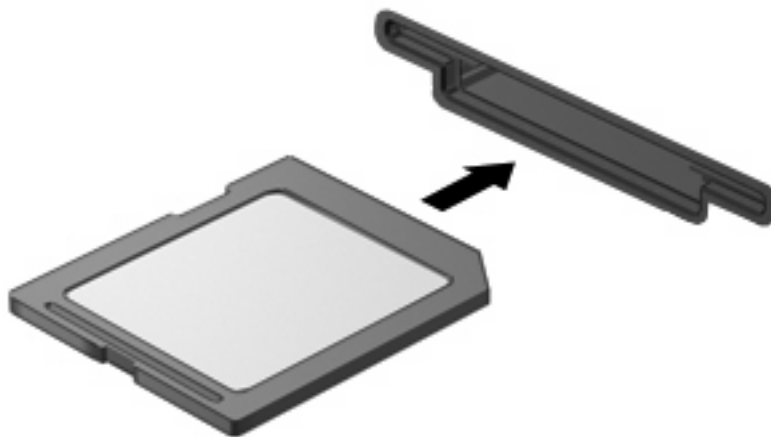

You will hear a sound when the device has been detected, and a menu of available options may be displayed.

## Stopping and removing a digital card

△ **CAUTION:** To prevent loss of information or an unresponsive system, stop a digital card before removing it.

1. Save your information and close all programs associated with the digital card.

 **NOTE:** To stop a data transfer, click **Cancel** in the operating system Copying window.

2. Stop the digital card:

- a. Double-click the **Safely Remove Hardware** icon in the notification area, at the far right of the taskbar.

 **NOTE:** To display the Safely Remove Hardware icon, click the **Show Hidden Icons** icon (< or <<) in the notification area.

- b. Click the name of the digital card in the list.
- c. Click **Stop**, and then click **OK**.

3. Press in on the digital card (1), and then remove the card from the slot (2).

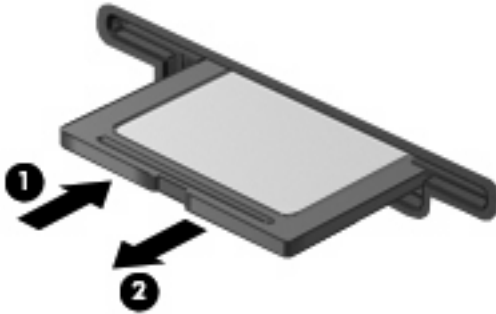

## Using ExpressCards (select models only)

An ExpressCard is a high-performance PC Card that is inserted into the ExpressCard slot.

Like standard PC Cards, ExpressCards are designed to conform to the standard specifications of the Personal Computer Memory Card International Association (PCMCIA).

### Configuring an ExpressCard

Install only the software required for your device. If you are instructed by the ExpressCard manufacturer to install device drivers:

- Install only the device drivers for your operating system.
- Do not install other software, such as card services, socket services, or enablers, supplied by the ExpressCard manufacturer.

### Inserting an ExpressCard

△ **CAUTION:** To prevent damage to the computer and external media cards, do not insert a PC Card into an ExpressCard slot.

**CAUTION:** To prevent damage to the connectors:

Use minimal force when inserting an ExpressCard.

Do not move or transport the computer when an ExpressCard is in use.

---

The ExpressCard slot may contain a protective insert. To remove the insert:

1. Press in on the insert **(1)** to unlock it.
2. Pull the insert out of the slot **(2)**.



To insert an ExpressCard:

1. Hold the card label-side up, with the connectors facing the computer.
2. Insert the card into the ExpressCard slot, and then push in on the card until it is firmly seated.

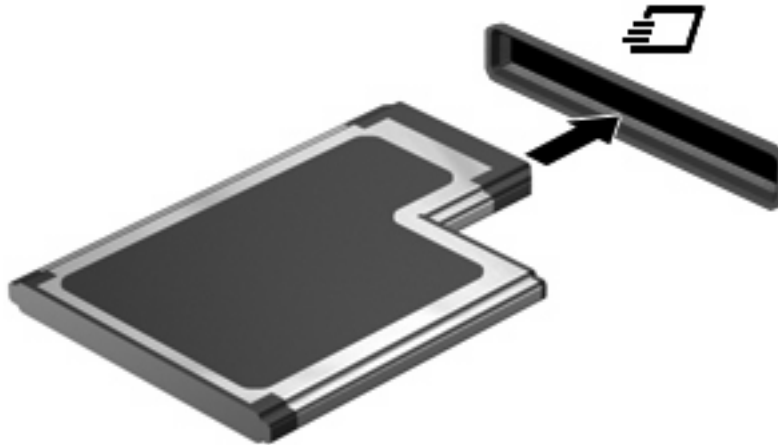

You will hear a sound when the device has been detected, and a menu of options may be displayed.

 **NOTE:** The first time you insert an ExpressCard, a message is displayed in the notification area to let you know the device is recognized by the computer.

---

 **NOTE:** An inserted ExpressCard uses power even when idle. To conserve power, stop or remove an ExpressCard when it is not in use.

---

## Stopping and removing an ExpressCard

△ **CAUTION:** To prevent loss of data or an unresponsive system, stop an ExpressCard before removing it.

1. Save your information and close all programs associated with the ExpressCard.

📝 **NOTE:** To stop a data transfer, click **Cancel** in the operating system Copying window.

2. Stop the ExpressCard:

- a. Double-click the **Safely Remove Hardware** icon in the notification area, at the far right of the taskbar.

📝 **NOTE:** To display the Safely Remove Hardware icon, click the **Show Hidden Icons** icon (< or <<) in the notification area.

- b. Click the name of the ExpressCard in the list.
- c. Click **Stop**, and then click **OK**.

3. Release and remove the ExpressCard:

- a. Gently press in on the ExpressCard **(1)** to unlock it.
- b. Pull the ExpressCard out of the slot **(2)**.

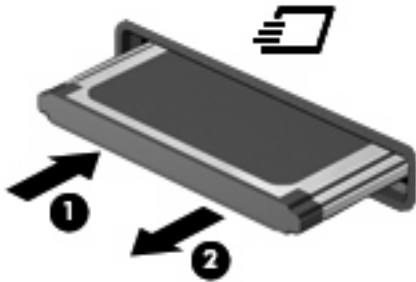

## Using smart cards (select models only)

📝 **NOTE:** The term *smart card* is used throughout this chapter to refer to both smart cards and Java™ Cards.

A smart card is a credit card–sized accessory that carries a microchip containing memory and a microprocessor. Like personal computers, smart cards have an operating system to manage input and output, and they include security features to protect against tampering. Industry-standard smart cards are used with the smart card reader (select models only).

A personal identification number (PIN) is needed to gain access to the contents of the microchip. For more information about smart card security features, refer to Help and Support.

📝 **NOTE:** Your computer may look slightly different from the illustrations in this chapter.

## Inserting a smart card

To insert a smart card:

1. Holding the smart card label-side up, gently slide the card into the smart card reader until the card is seated.

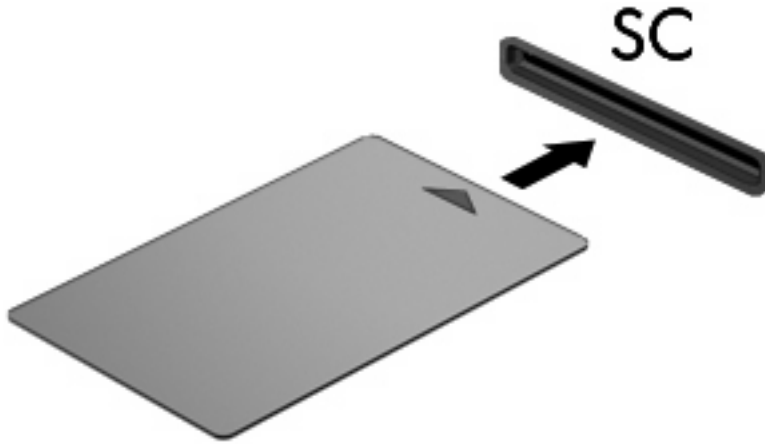

2. Follow the on-screen instructions for logging on to the computer using the smart card PIN.

## Removing a smart card

To remove a smart card:

- ▲ Grasp the edge of the smart card, and pull it out of the smart card reader.



---

## 9 Memory modules

The computer has two memory module compartments. The primary memory module compartment is located under the keyboard. The expansion memory module compartment is located on the bottom of the computer.

The memory capacity of the computer can be upgraded by adding a memory module to the vacant expansion memory module slot or by upgrading the existing memory module in the primary memory module slot.

- △ **WARNING!** To reduce the risk of electric shock and damage to the equipment, unplug the power cord and remove all batteries before installing a memory module.
- △ **CAUTION:** Electrostatic discharge (ESD) can damage electronic components. Before beginning any procedure, touch a grounded metal object to be sure that you are discharged of static electricity.

# Adding or replacing a memory module in the expansion memory module slot

To add or replace a memory module in the expansion memory module slot, follow these steps:

1. Save your work.
2. Shut down the computer and close the display.  
If you are not sure whether the computer is off or in Hibernation, turn the computer on by pressing the power button. Then shut down the computer through the operating system.
3. Disconnect all external devices connected to the computer.
4. Unplug the power cord from the AC outlet.
5. Turn the computer upside down on a flat surface.
6. Remove all batteries from the computer.
7. Loosen the memory module compartment cover screw **(1)**.
8. Lift the memory module compartment cover **(2)** away from the computer.

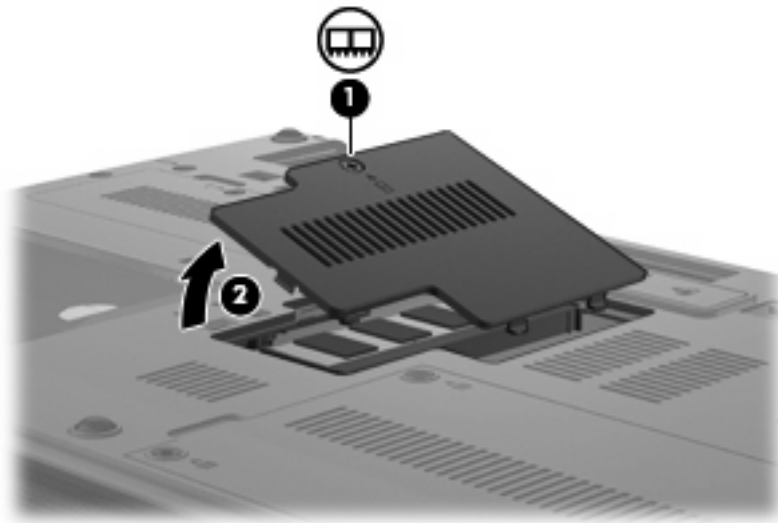

9. Remove the memory module:

 **NOTE:** If the expansion memory module slot is not populated, bypass step 9 and proceed to step 10.

- a. Pull away the retention clips **(1)** on each side of the memory module.

The memory module tilts up.

 **CAUTION:** To prevent damage to the memory module, hold the memory module by the edges only. Do not touch the components on the memory module.



- b. Grasp the edge of the memory module (2), and gently pull the module out of the memory module slot.

To protect a memory module after removal, place it in an electrostatic-safe container.

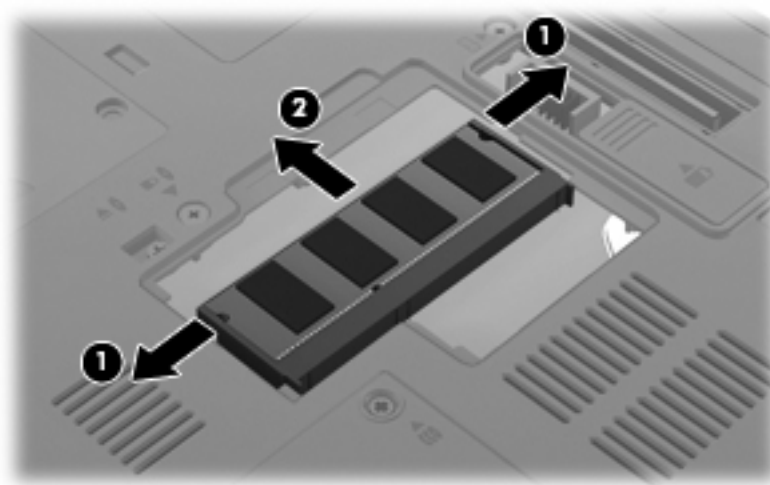

**10.** Insert a memory module:

- a. Align the notched edge (1) of the memory module with the tab in the memory module slot.

△ **CAUTION:** To prevent damage to the memory module, hold the memory module by the edges only. Do not touch the components on the memory module and do not bend the memory module.

- b. With the memory module at a 45-degree angle from the surface of the memory module compartment, press the module (2) into the memory module slot until it is seated.
- c. Gently press the memory module (3) down, applying pressure to both the left and right edges of the memory module, until the retention clips snap into place.

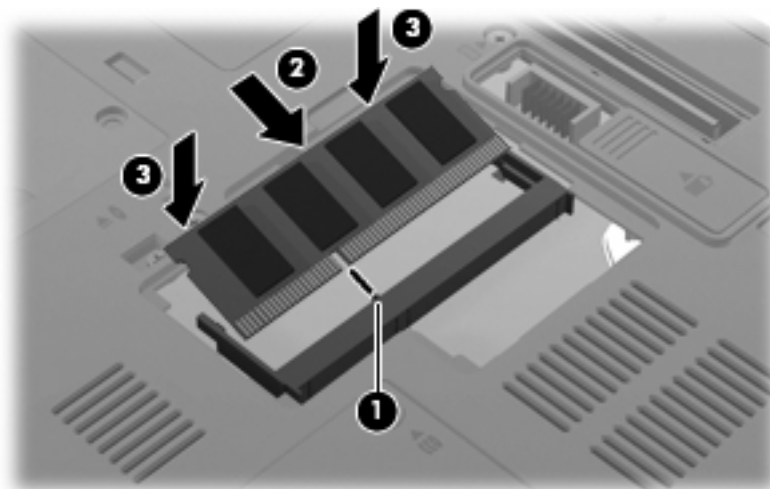

11. Align the tabs (1) on the memory module compartment cover with the notches on the computer.
12. Close the cover (2).

13. Tighten the memory module compartment cover screw (3).

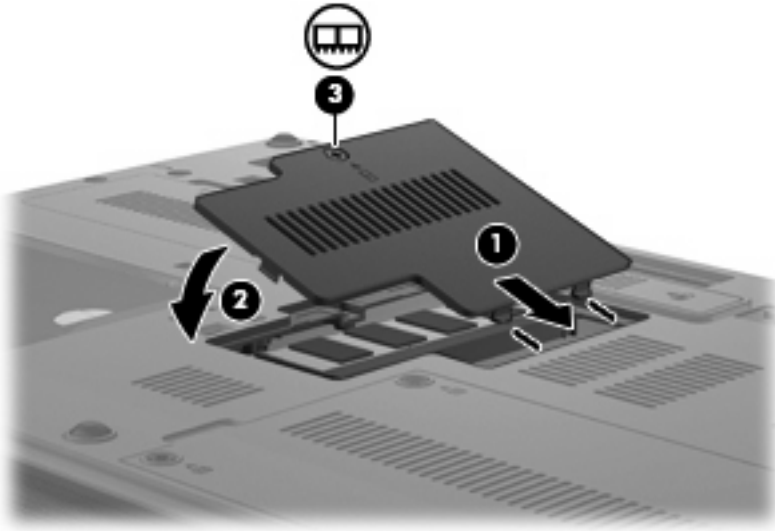

14. Replace the battery.
15. Turn the computer right-side up, and then reconnect external power and external devices.
16. Turn on the computer.

## Upgrading a memory module in the primary memory module slot

To upgrade a memory module in the primary memory module slot, follow these steps:

1. Save your work.

2. Shut down the computer.

If you are not sure whether the computer is off or in Hibernation, turn the computer on by pressing the power button. Then shut down the computer through the operating system.

3. Disconnect all external devices connected to the computer.

4. Unplug the power cord from the AC outlet.

5. Turn the computer upside down on a flat surface.

6. Remove all batteries from the computer.

7. Remove the 3 keyboard access screws.

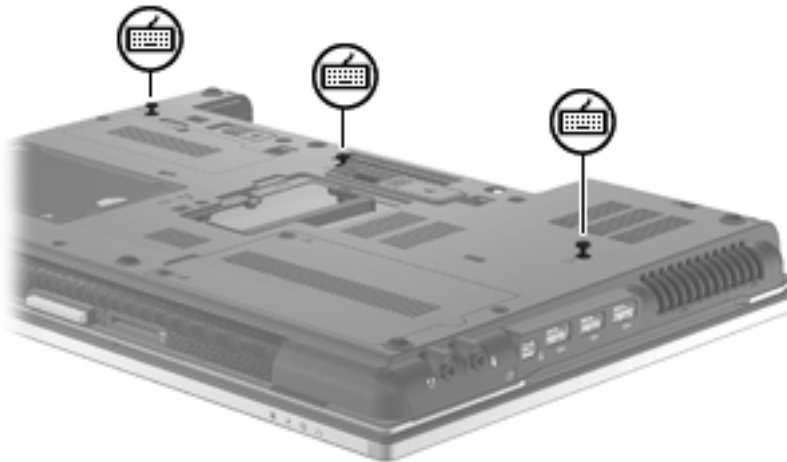

8. Turn the computer over and open it.

9. Slide the 4 keyboard release latches to release the keyboard.



10. Gently lift the top edge of the keyboard and tilt the keyboard over until it rests on the palm rest of the computer.



11. Remove the memory module:
  - a. Pull away the retention clips (1) on each side of the memory module.

The memory module tilts up.

- △ **CAUTION:** To prevent damage to the memory module, hold the memory module by the edges only. Do not touch the components on the memory module.
-

- b. Grasp the edge of the memory module (2), and gently pull the module out of the memory module slot.

To protect a memory module after removal, place it in an electrostatic-safe container.

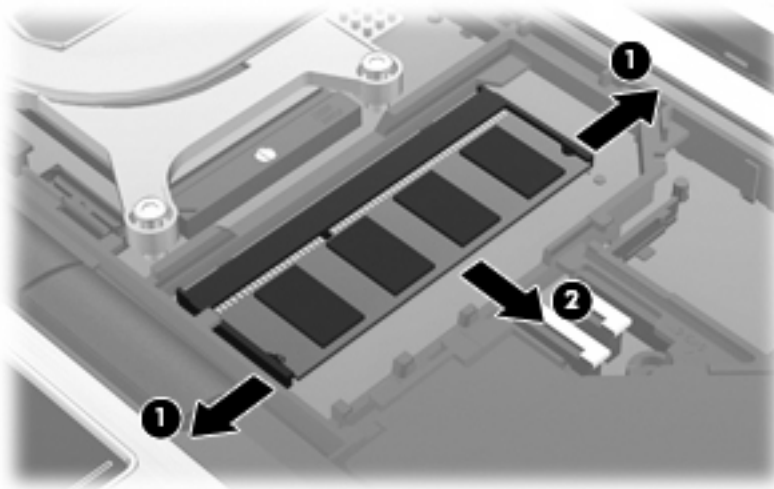

**12.** Insert a memory module:

- a. Align the notched edge (1) of the memory module with the tab in the memory module slot.

△ **CAUTION:** To prevent damage to the memory module, hold the memory module by the edges only. Do not touch the components on the memory module and do not bend the memory module.

- b. With the memory module at a 45-degree angle from the surface of the memory module compartment, press the module (2) into the memory module slot until it is seated.
- c. Gently press the memory module (3) down, applying pressure to both the left and right edges of the memory module, until the retention clips snap into place.

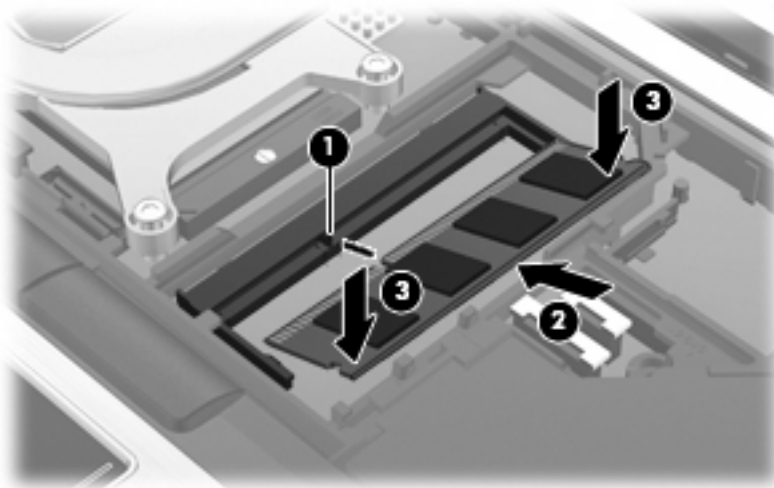

**13.** Replace the keyboard (1).

- Slide the 4 keyboard release latches to lock the keyboard (2).



- Close the cover.
- Turn the computer upside down on a flat surface.
- Replace the 3 keyboard access screws.

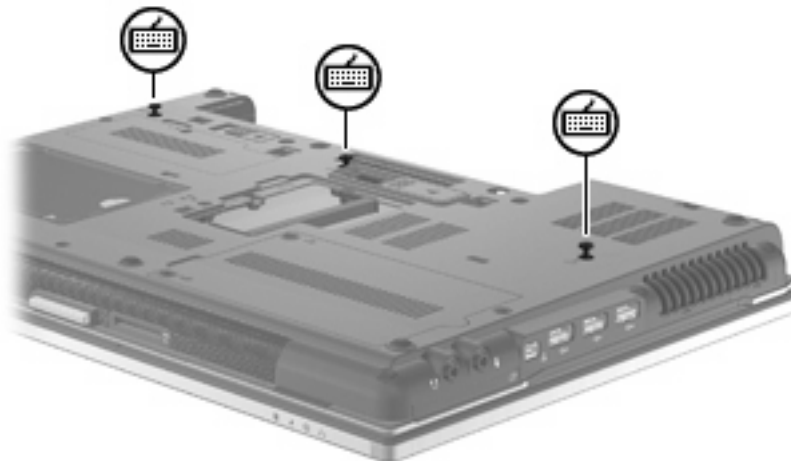

- Replace the battery.
- Turn the computer right-side up, and then reconnect external power and external devices.
- Turn on the computer.

# Increasing the hard drive space for the Hibernation file

When Hibernation is initiated, the operating system stores your information to a Hibernation file on the hard drive and then turns off the computer. The operating system reserves space on the hard drive to store the Hibernation file based on the amount of system memory. When you increase the memory, the operating system increases the hard drive space reserved for the Hibernation file.

If you experience problems with Hibernation after increasing memory, be sure that the amount of free space on the hard drive is larger than the space required by the Hibernation file.

To display the amount of free space on the primary hard drive:

1. Select **Start > My Computer**.
  2. Right-click the primary hard drive listing, and then click **Properties**.
- ▲ To display the amount of hard drive space required by the Hibernation file, select **Start > Control Panel > Performance and Maintenance > Power Options > Hibernate** tab.

If the free space on the hard drive is less than the space required by the Hibernation file, increase the amount of free space on the hard drive:

- ▲ Select **Start > Help and Support > Performance and Maintenance > Freeing up disk space** and follow the on-screen instructions.

# 10 Security

## Protecting the computer

 **NOTE:** Security solutions are designed to act as deterrents. These deterrents may not prevent a product from being mishandled or stolen.

**NOTE:** In some countries or regions, the computer supports CompuTrace, which is an online security-based tracking and recovery service available in select regions. If the computer is stolen, CompuTrace can track the computer if the unauthorized user accesses the Internet. You must purchase the software and subscribe to the service in order to use CompuTrace. For information about ordering the CompuTrace software, go to the HP Web site at <http://www.hpshopping.com>.

Security features provided with your computer can protect the computer, personal information, and data from a variety of risks. The way you use your computer will determine which security features you need to use.

The Windows® operating system offers certain security features. Additional security features are listed in the following table. Most of these additional security features can be configured in the Computer Setup utility (referred to hereafter as Computer Setup).

| To protect against   | Use this security feature  |
|--|--|
| Unauthorized use of the computer   | HP ProtectTools Security Manager, in combination with a password, smart card, and/or fingerprint reader                                      |
| Unauthorized access to Computer Setup (f10)  | BIOS administrator password in Computer Setup*   |
| Unauthorized access to the contents of a hard drive  | DriveLock password in Computer Setup*  |
| Unauthorized startup from an optical drive, diskette drive, or internal network adapter    | Boot options feature in Computer Setup*  |
| Unauthorized access to a Windows user account  | HP ProtectTools Security Manager   |
| Unauthorized access to data  | <ul style="list-style-type: none"><li>• Firewall software</li><li>• Windows updates</li><li>• Drive Encryption for HP ProtectTools</li></ul> |
| Unauthorized access to Computer Setup settings and other system identification information | BIOS administrator password in Computer Setup*   |
| Unauthorized removal of the computer   | Security cable slot (used with an optional security cable)   |

\*Computer Setup is a preinstalled, ROM-based utility that can be used even when the operating system is not working or will not load. You can use either a pointing device (TouchPad, pointing stick, or USB mouse) or the keyboard to navigate and make selections in Computer Setup.



## Using passwords

Most security features use passwords. Whenever you set a password, write down the password and store it in a secure location away from the computer. Note the following password considerations:

- Setup and DriveLock passwords are set in Computer Setup and are managed by the system BIOS.
- The embedded security password, which is an HP ProtectTools Security Manager password, can be enabled in Computer Setup to provide BIOS password protection in addition to their normal HP ProtectTools functions. The embedded security password is used with the optional embedded security chip.
- Windows passwords are set only in the Windows operating system.
- If you forget the BIOS administrator password set in Computer Setup, you can use HP SpareKey to access the utility.
- If you forget both the DriveLock user password and the DriveLock master password set in Computer Setup, the hard drive that is protected by the passwords is permanently locked and can no longer be used.

You can use the same password for a Computer Setup feature and for a Windows security feature. You can also use the same password for more than one Computer Setup feature.

Use the following tips for creating and saving passwords:

- When creating passwords, follow requirements set by the program.
- Write down your passwords and store them in a secure place away from the computer.
- Do not store passwords in a file on the computer.

The following tables list commonly used Windows and BIOS administrator passwords and describe their functions.

### Setting passwords in Windows

| Windows passwords       | Function  |
|-------------------------|---|
| Administrator password* | Protects access to a Windows administrator-level account. |
| User password*          | Protects access to a Windows user account.                |

\*For information about setting a Windows administrator password or a Windows user password, select **Start > Help and Support**.

### Setting passwords in Computer Setup

| BIOS administrator passwords | Function   |
|------------------------------|--|
| BIOS administrator password  | Protects access to Computer Setup.   |
| DriveLock master password    | Protects access to the internal hard drive that is protected by DriveLock. It is also used to remove DriveLock protection. This password is set under DriveLock Passwords during the enable process. |

| BIOS administrator passwords   | Function  |
|--------------------------------|---|
| DriveLock user password        | Protects access to the internal hard drive that is protected by DriveLock, and is set under DriveLock Passwords during the enable process.  |
| TPM embedded security password | When enabled as a BIOS administrator password, protects access to the computer contents when the computer turns on, restarts, or exits Hibernation.<br><br>This password requires the optional embedded security chip to support this security feature. |

## BIOS administrator password

The Computer Setup BIOS administrator password protects the configuration settings and system identification information in Computer Setup. After this password is set, it must be entered to access Computer Setup and to make changes using Computer Setup.

Note the following characteristics of the BIOS administrator password:

- It is not interchangeable with a Windows administrator password, although both passwords can be identical.
- It is not displayed as it is set, entered, changed, or deleted.
- It must be set and entered with the same keys. For example, a BIOS administrator password set with keyboard number keys will not be recognized if you enter it thereafter with embedded numeric keypad number keys.
- It can include any combination of up to 32 letters and numbers and it is not case sensitive unless mandated by the administrator.

## Managing a BIOS administrator password

A BIOS administrator password is set, changed, and deleted in Computer Setup.

To set this password in Computer Setup, follow these steps:

1. Turn on or restart the computer, and then press **esc** while the “Press the ESC key for Startup Menu” message is displayed at the bottom of the screen.
2. Press **f10** to enter BIOS Setup.
3. Use a pointing device or the arrow keys to select **Security > Setup BIOS Administrator Password**, and then press **enter**.
4. When prompted, type a password.
5. When prompted, type the new password again to confirm.
6. To save your changes and exit Computer Setup, click **Save** in the lower-left corner of the screen, and then follow the on-screen instructions.

– or –

Use the arrow keys to select **File > Save Changes and Exit**, and then press **enter**.

Your changes go into effect when the computer restarts.

To change this password in Computer Setup, follow these steps:

1. Turn on or restart the computer, and then press **esc** while the “Press the ESC key for Startup Menu” message is displayed at the bottom of the screen.
2. Press **f10** to enter BIOS Setup.
3. Use a pointing device or the arrow keys to select **Security > Change Password**, and then press **enter**.
4. When prompted, type your current password.
5. When prompted, type your new password again to confirm.
6. To save your changes and exit Computer Setup, click **Save** in the lower-left corner of the screen, and then follow the on-screen instructions.

– or –

Use the arrow keys to select **File > Save Changes and Exit**, and then press **enter**.

Your changes go into effect when the computer restarts.

To delete this password in Computer Setup, follow these steps:

1. Turn on or restart the computer, and then press **esc** while the “Press the ESC key for Startup Menu” message is displayed at the bottom of the screen.
2. Press **f10** to enter BIOS Setup.
3. Use a pointing device or the arrow keys to select **Security > Change Password**, and then press **enter**.
4. When prompted, type your current password.
5. When prompted for the new password, leave the field empty, and then press **enter**.
6. Read the warning. To continue, select **YES**.
7. When prompted to type your new password again, leave the field empty, and then press **enter**.
8. To save your changes and exit Computer Setup, click **Save** in the lower-left corner of the screen, and then follow the on-screen instructions.

– or –

Use the arrow keys to select **File > Save changes and exit**, and then press **enter**.

Your changes go into effect when the computer restarts.

## Entering a BIOS administrator password

At the **BIOS administrator password** prompt, type your password (using the same kind of keys you used to set the password), and then press **enter**. After 3 unsuccessful attempts to enter the BIOS administrator password, you must restart the computer and try again.

## Using Computer Setup DriveLock

- △ **CAUTION:** To prevent the DriveLock-protected hard drive from becoming permanently unusable, record the DriveLock user password and the DriveLock master password in a safe place away from your computer. If you forget both DriveLock passwords, the hard drive will be permanently locked and can no longer be used.

DriveLock protection prevents unauthorized access to the contents of a hard drive. DriveLock can be applied only to the internal hard drive(s) of the computer. After DriveLock protection is applied to a drive, a password must be entered to access the drive. The drive must be inserted into the computer or an advanced port replicator in order for it to be accessed by the DriveLock passwords.

To apply DriveLock protection to an internal hard drive, a user password and a master password must be set in Computer Setup. Note the following considerations about using DriveLock protection:

- After DriveLock protection is applied to a hard drive, the hard drive can be accessed only by entering either the user password or the master password.
- The owner of the user password should be the day-to-day user of the protected hard drive. The owner of the master password may be either a system administrator or the day-to-day user.
- The user password and the master password can be identical.
- You can delete a user password or master password only by removing DriveLock protection from the drive. DriveLock protection can be removed from the drive only with the master password.

### Setting a DriveLock password

To set a DriveLock password in Computer Setup, follow these steps:

1. Turn on the computer, and then press **esc** while the “Press the ESC key for Startup Menu” message is displayed at the bottom of the screen.
2. Press **f10** to enter BIOS Setup.
3. Use a pointing device or the arrow keys to select **Security > DriveLock Passwords**, and then press **enter**.
4. Use a pointing device to click the hard drive you want to protect.  
– or –  
Use the arrow keys to select the hard drive you want to protect, and then press **enter**.
5. Read the warning. To continue, select **YES**.
6. When prompted, type a master password, and then press **enter**.
7. When prompted, type the master password again to confirm, and then press **enter**.
8. When prompted, type a user password, and then press **enter**.
9. When prompted, type the user password again to confirm, and then press **enter**.
10. To confirm DriveLock protection on the drive you have selected, type `DriveLock` in the confirmation field, and then press **enter**.

---

 **NOTE:** The DriveLock confirmation is case sensitive.

---

11. To save your changes and exit Computer Setup, click **Save** in the lower-left corner of the screen, and then follow the on-screen instructions.

– or –

Use the arrow keys to select **File > Save Changes and Exit**, and then press [enter](#).

Your changes go into effect when the computer restarts.

## Entering a DriveLock password

Be sure that the hard drive is inserted into the computer (not into an optional docking device or external MultiBay).

At the **DriveLock Password** prompt, type your user or master password (using the same kind of keys you used to set the password), and then press [enter](#).

After 2 incorrect attempts to enter the password, you must shut down the computer and try again.

## Changing a DriveLock password

To change a DriveLock password in Computer Setup, follow these steps:

1. Turn on the computer, and then press [esc](#) while the “Press the ESC key for Startup Menu” message is displayed at the bottom of the screen.
2. Press [f10](#) to enter BIOS Setup.
3. Use a pointing device or the arrow keys to select **Security > DriveLock Passwords**, and then press [enter](#).
4. Use a pointing device to select an internal hard drive.

– or –

Use the arrow keys to select an internal hard drive, and then press [enter](#).

5. Use a pointing device or the arrow keys to select the password you want to change.
6. When prompted, type your current password, and then press [enter](#).
7. When prompted, type a new password, and then press [enter](#).
8. When prompted, type the new password again to confirm, and then press [enter](#).
9. To save your changes and exit Computer Setup, click **Save** in the lower-left corner of the screen, and then follow the on-screen instructions.

– or –

Use the arrow keys to select **File > Save Changes and Exit**, and then press [enter](#).

Your changes go into effect when the computer restarts.

## Removing DriveLock protection

To remove DriveLock protection in Computer Setup, follow these steps:

1. Turn on the computer, and then press **esc** while the “Press the ESC key for Startup Menu” message is displayed at the bottom of the screen.
2. Press **f10** to enter BIOS Setup.
3. Use a pointing device or the arrow keys to select **Security > DriveLock password**, and then press **enter**.
4. Use a pointing device or the arrow keys to select an internal hard drive, and then press **enter**.
5. Use a pointing device or the arrow keys to select **Disable protection**.
6. Type your master password, and then press **enter**.
7. To save your changes and exit Computer Setup, click **Save** in the lower-left corner of the screen, and then follow the on-screen instructions.

– or –

Use the arrow keys to select **File > Save changes and exit**, and then press **enter**.

Your changes go into effect when the computer restarts.

## Using Computer Setup Auto DriveLock

In a multiple-user environment, you can set an Automatic DriveLock password. When the Automatic DriveLock password is enabled, a random user password and a DriveLock master password will be created for you. When any user passes the password credential, the same random user and DriveLock master password will be used to unlock the drive.



---

**NOTE:** You must have a BIOS administrator password before you can access the Automatic DriveLock features.

---

## Entering an Automatic DriveLock password

To enable an Automatic DriveLock password in Computer Setup, follow these steps:

1. Turn on or restart the computer, and then press **esc** while the “Press the ESC key for Startup Menu” message is displayed at the bottom of the screen.
2. Press **f10** to enter BIOS Setup.
3. Use a pointing device or the arrow keys to select **Security > Automatic DriveLock**, and then press **enter**.
4. Use a pointing device or the arrow keys to select an internal hard drive, and then press **enter**.
5. Read the warning. To continue, select **YES**.
6. To save your changes and exit Computer Setup, click **Save** in the lower-left corner of the screen, and then follow the on-screen instructions.

– or –

Use the arrow keys to select **File > Save changes and exit**, and then press **enter**.

## Removing Automatic DriveLock protection

To remove DriveLock protection in Computer Setup, follow these steps:

1. Turn on or restart the computer, and then press **esc** while the “Press the ESC key for Startup Menu” message is displayed at the bottom of the screen.
2. Press **f10** to enter BIOS Setup.
3. Use a pointing device or the arrow keys to select **Security > Automatic DriveLock**, and then press **enter**.
4. Use a pointing device or the arrow keys to select an internal hard drive, and then press **enter**.
5. Use a pointing device or the arrow keys to select **Disable protection**.
6. To save your changes and exit Computer Setup, click **Save** in the lower-left corner of the screen, and then follow the on-screen instructions.

– or –

Use the arrow keys to select **File > Save changes and exit**, and then press **enter**.

# Using Computer Setup security features

## Securing system devices

You can disable or enable system devices from the following menus in Computer Setup:

- Boot Options
- Device Configurations
- Built-In Device Options
- Port Options

To disable or reenable system devices in Computer Setup, follow these steps:

1. Turn on or restart the computer, and then press **esc** while the “Press the ESC key for Startup Menu” message is displayed at the bottom of the screen.
2. Press **f10** to enter BIOS Setup.
3. Use a pointing device or the arrow keys to select **System Configuration > Boot Options**, or **System Configuration > Device Configurations**, or **System Configuration > Built-In Device Options** or **System Configuration > Port Options**.
4. Press **enter**.
5. To disable an option, use a pointing device to click **Disabled** next to the option.  
– or –  
Use the arrow keys to select **Disabled** next to the option, and then press **enter**.
6. To reenable an option, use a pointing device to click **Enabled** next to the option.  
– or –  
Use the arrow keys to select **Enabled** next to the option, and then press **enter**.
7. To save your changes and exit Computer Setup, click **Save** in the lower-left corner of the screen, and then follow the on-screen instructions.  
– or –  
Use the arrow keys to select **File > Save changes and exit**, and then press **enter**.

Your changes go into effect when the computer restarts.

## Viewing Computer Setup System Information

The System Information feature in Computer Setup provides 2 types of system information:

- Identification information about the computer model and the batteries
- Specification information about the processor, memory, ROM, video revision, keyboard controller revision, and wireless identification numbers



To view this general system information in Computer Setup, follow these steps:

1. Turn on or restart the computer, and then press **esc** while the “Press the ESC key for Startup Menu” message is displayed at the bottom of the screen.
2. Press **f10** to enter BIOS Setup.
3. Use a pointing device or the arrow keys to select **File > System Information**, and then press **enter**.

---

 **NOTE:** To prevent unauthorized access to this information, you must create a BIOS administrator password in Computer Setup.

---

## Using Computer Setup System IDs

The System IDs feature in Computer Setup allows you to display or enter the computer asset tag and ownership tag.

---

 **NOTE:** To prevent unauthorized access to this information, you must create a BIOS administrator password in Computer Setup.

---

To manage this feature in Computer Setup, follow these steps:

1. Turn on or restart the computer, and then press **esc** while the “Press the ESC key for Startup Menu” message is displayed at the bottom of the screen.
2. Press **f10** to enter BIOS Setup.
3. Use a pointing device or the arrow keys to select **Security > System IDs**, and then press **enter**.
4. Use a pointing device or the arrow keys to select **Notebook Asset Tag** or **Notebook Ownership Tag**, and then enter the information.
5. Press **enter** when finished.
6. To save your changes and exit Computer Setup, click **Save** in the lower-left corner of the screen, and then follow the on-screen instructions.

– or –

Use the arrow keys to select **File > Save changes and exit**, and then press **enter**.

Your changes go into effect when the computer restarts.

## Using antivirus software

When you use the computer to access e-mail, a network, or the Internet, you expose the computer to computer viruses. Computer viruses can disable the operating system, programs, or utilities, or cause them to function abnormally.

Antivirus software can detect most viruses, destroy them, and in most cases, repair any damage they have caused. To provide ongoing protection against newly discovered viruses, antivirus software must be kept up to date.

McAfee Total Protection antivirus software is either preinstalled or preloaded on the computer.

If the antivirus software is preinstalled, select **Start > All Programs > McAfee > Managed Services > Total Protection**.

If the software is preloaded, select **Start > All Programs > HP Software Setup**, and then follow the on-screen instructions to load the **McAfee Total Protection** software.

For more information about computer viruses, type `viruses` in the Search box in Help and Support.

## Using firewall software

When you use the computer to access e-mail, a network, or the Internet, unauthorized persons may be able to gain access to the computer, your personal files, and information about you. Use the firewall software preinstalled on the computer to protect your privacy. McAfee Total Protection antivirus software is preinstalled on the computer. To access your software, select **Start > All Programs > McAfee > Managed Services > Total Protection**.

Firewall features include logging and reporting of network activity, and automatic monitoring of all incoming and outgoing traffic. For more information, refer to the software manufacturer's instructions. These instructions may be provided with the software, on disc, or on the manufacturer's Web site.

---

 **NOTE:** Under some circumstances a firewall can block access to Internet games, interfere with printer or file sharing on a network, or block authorized e-mail attachments. To temporarily resolve the problem, disable the firewall, perform the task that you want to perform, and then reenables the firewall. To permanently resolve the problem, reconfigure the firewall as necessary, and adjust the policies and settings of other intrusion detection systems. For additional information, contact your network administrator or IT department.

---

## Installing critical security updates

---

△ **CAUTION:** Microsoft sends alerts regarding critical updates. To protect the computer from security breaches and computer viruses, install all critical updates from Microsoft as soon as you receive an alert.

---

Updates to the operating system and other software may have become available *after* the computer was shipped. To be sure that all available updates are installed on the computer, observe these guidelines:

- Run Windows Update monthly to install the latest software from Microsoft.
- Obtain updates, as they are released, from the Microsoft Web site and through the updates link in Help and Support.

## Using HP ProtectTools Security Manager (select models only)

HP ProtectTools Security Manager software is preinstalled on select computer models. This software can be accessed through Windows Control Panel. It provides security features that help protect against unauthorized access to the computer, networks, and critical data. For more information, refer to the HP ProtectTools Security Manager software Help. Click **Start > HP > HP ProtectTools Security Manager**.

## Installing a security cable

 **NOTE:** A security cable is designed to act as a deterrent, but it may not prevent the computer from being mishandled or stolen.

---

1. Loop the security cable around a secured object.
2. Insert the key (1) into the cable lock (2).
3. Insert the cable lock into the security cable slot on the computer (3), and then lock the cable lock with the key.

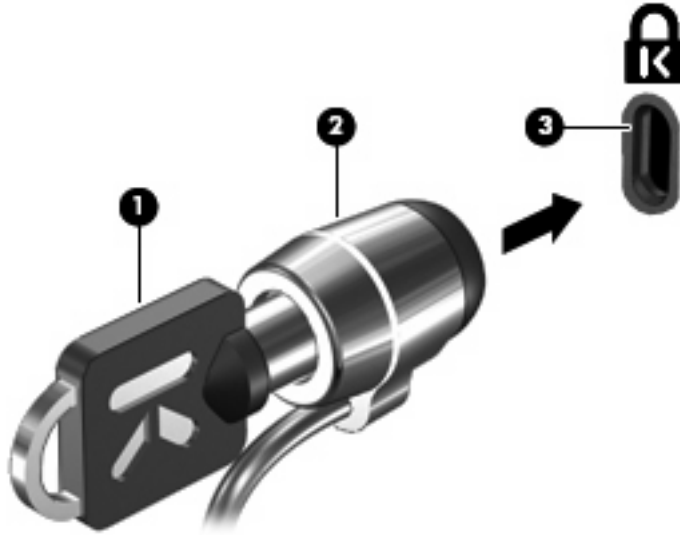

 **NOTE:** Your computer may look different from the illustration. The location of the security cable slot varies by computer model.

---

---

# 11 Software updates

## Updating software

Updated versions of the software provided with your computer are available either through the HP Update utility or on the HP Web site.

The HP Update utility automatically checks for updates from HP. The utility runs a specified interval and provides a list of support alerts, such as security enhancements, and optional software and driver updates.

You can manually check for updates at any time by selecting **Start > Help and Support Update Software & Drivers** and follow the on-screen instructions.

Most software on the HP Web site is packaged in compressed files called SoftPaqs. Some BIOS updates may be packaged in compressed files called *ROMPaqs*.

Some download packages contain a file named Readme.txt, which contains information regarding installing and troubleshooting the file. (Readme.txt files included with ROMPaqs are provided in English only.)

To update the software using the HP Web site, follow these steps:

1. Identify your computer model, product category, and series or family. Prepare for a system BIOS update by identifying the BIOS version currently installed on the computer. For details, refer to the "Determining the BIOS version" section.

If your computer is connected to a network, consult the network administrator before installing any software updates, especially system BIOS updates.

---

 **NOTE:** The computer system BIOS is stored on the system ROM. The BIOS initializes the operating system, determines how the computer will interact with the hardware devices, and provides for data transfer among hardware devices, including the time and date.

---

2. Open your Web browser, and go to <http://www.hp.com/support>.
3. Select your country or region.
4. Click the option for software and driver downloads, and then type your computer model number in the product box.
5. Press **enter**.
6. Follow the on-screen instructions.

## Updating the BIOS

To update the BIOS, first determine what BIOS version you currently have, and then download and install the new BIOS.

### Determining the BIOS version

BIOS version information (also known as *ROM date* and *System BIOS*) can be displayed by pressing **fn+esc** (if you are already in Windows®) or by using Computer Setup.

To use Computer Setup for displaying BIOS information, follow these steps:

1. Turn on or restart the computer, and then press **esc** while the “Press the ESC key for Startup Menu” message is displayed at the bottom of the screen.
2. Press **f10** to enter BIOS setup.
3. Use a pointing device or the arrow keys to select **File > System Information**.
4. Press **esc** to return to the **File** menu.
5. Click **Exit** in the lower-left corner of the screen, and follow the on-screen instructions.

– or –

Use the arrow keys to select **File > Ignore changes and exit**, and then press **enter**.

### Downloading a BIOS update

 **CAUTION:** To prevent damage to the computer or an unsuccessful installation, download and install a BIOS update only when the computer is connected to reliable external power using the AC adapter. Do not download or install a BIOS update while the computer is running on battery power, docked in an optional docking device, or connected to an optional power source. During the download and installation, follow these instructions:

Do not disconnect power from the computer by unplugging the power cord from the AC outlet.

Do not shut down the computer or initiate Standby or Hibernation.

Do not insert, remove, connect, or disconnect any device, cable, or cord.

To download a BIOS update:

 **NOTE:** BIOS updates are posted as needed. A newer BIOS update may not be available for your computer. It is recommended that you check the HP Web site periodically for BIOS updates.

1. Open your Web browser, go to <http://www.hp.com/support>, and then select your country or region.
2. Click the option for software and driver downloads, type your computer model number in the product box, and then press **enter**.
3. Click your specific product from the models listed.
4. Click your operating system.



5. Follow the on-screen instructions to access the BIOS update you want to download. Make a note of the download date, name, or other identifier. You may need this information to locate the update later, after it has been downloaded to your hard drive.
6. At the download area, perform these steps:
  - a. Identify the BIOS update that is newer than the BIOS version currently installed on your computer.
  - b. Follow the on-screen instructions to download your selection to the hard drive.

Make a note of the path to the location on your hard drive where the BIOS update will be downloaded. You will need to access this path when you are ready to install the update.

---

 **NOTE:** If you connect your computer to a network, consult the network administrator before installing any software updates, especially system BIOS updates.

---

BIOS installation procedures vary. Follow any on-screen instructions that are displayed after the download is complete. If no instructions are displayed, follow these steps:

1. Open Windows Explorer by selecting **Start > My Computer**.
2. Double-click your hard drive designation. The hard drive designation is typically Local Disk (C:).
3. Using the hard drive path you recorded earlier, open the folder on your hard drive that contains the update.
4. Double-click the file that has an .exe extension (for example, *filename.exe*).

The BIOS installation begins.

5. Complete the installation by following the on-screen instructions.

---

 **NOTE:** After an on-screen message reports a successful installation, you may delete the downloaded file from your hard drive.

---

## Updating programs and drivers

1. Open your Web browser, go to <http://www.hp.com/support>, and then select your country or region.
2. Click the option for software and driver downloads, type your computer model number in the product box, and then press **enter**.

– or –

If you want a specific SoftPaq, type the SoftPaq number in the Search box, at the top-right corner of the screen. Then press **enter**, and follow the instructions provided. Proceed to step 6.

3. Click your specific product from the models listed.
4. Click your operating system.
5. When the list of updates is displayed, click an update to open a window containing additional information.
6. Click **Download**.
7. Click **Run** to install the updated software without downloading the file.

– or –

Click **Save** to save the file to your computer. When prompted, select a storage location on your hard drive.

After the file is downloaded, navigate to the folder where the file was stored, and double-click the file to install the update.

8. If prompted to do so, restart your computer after the installation is complete.

## Using SoftPaq Download Manager

HP SoftPaq Download Manager (SDM) provides quick access to SoftPaq information for HP computers, without the need to specify a SoftPaq number. The software works by reading and downloading a published database file containing computer model and SoftPaq information.

Using this tool, you can easily search for SoftPaqs by computer model, and then download, unpack, and install the SoftPaqs. The program allows you to perform the following tasks:

- Search for, download, and install SoftPaq updates for your computer.
- View available and downloaded SoftPaqs for your computer.
- Create configuration files and specify search parameters for multiple configurations, to help you manage SoftPaqs for multiple computers with various configurations.

SoftPaq Download Manager is available on the HP Web site. To use SoftPaq Download Manager to download SoftPaqs, you must first download and install the program. Go to the HP Web site at <http://www.hp.com/go/sdm>, and follow the instructions to download and install SoftPaq Download Manager.

---

 **NOTE:** To download SoftPaq Download Manager or obtain more information about using it, see the HP Web site: <http://www.hp.com/go/sdm>.

---

To start SoftPaq Download Manager, select **Start > All Programs > HP > HP SoftPaq Download Manager**.

For more information, refer to the HP SoftPaq Download Manager software Help.

---

# 12 Backup and recovery

To protect your information, use the Windows® Backup utility (select models only) to back up files and folders or create recovery points. In case of system failure, you can use the backup files to restore your computer.

Windows provides the following options:

- Backing up individual files and folders
- Backing up all files and folders
- Scheduling automatic backups
- Creating recovery points
- Recovering information

---

 **NOTE:** For detailed instructions, perform a search for these topics in Help and Support.

**NOTE:** In case of system instability, HP recommends that you print the recovery procedures and save them for later use.

---

## Backing up your information

Recovery after a system failure is as complete as your most current backup. You should create your initial backup immediately after software setup. As you add new software and data files, you should continue to back up your system on a regular basis to maintain a reasonably current backup.

You can back up individual files or folders to an optional external hard drive or to a network drive.

Note the following when backing up:

- Store personal files in the My Documents folder, and back it up periodically.
- Back up templates stored in their associated programs.
- Save customized settings that appear in a window, toolbar, or menu bar by taking a screen shot of your settings. The screen shot can be a time saver if you have to reset your preferences.

To copy the screen and paste it into a word-processing document:

- a. Display the screen you want to save.
- b. Copy the screen image:  
To copy only the active window, press **alt+fn+prt sc**.  
To copy the entire screen, press **fn+prt sc**.
- c. Open a word-processing document, click **Edit > Paste**.  
The screen image is added to the document.
- d. Save the document.

To create a backup using the Windows Backup utility (select models only), follow these steps:

---

 **NOTE:** Be sure that the computer is connected to AC power before you start the backup process.

**NOTE:** The backup process may take over an hour, depending on file size and the speed of the computer.

---

1. Click **Start > All Programs > Accessories > System Tools > Backup**.
2. Follow the on-screen instructions.

# Performing a recovery

In case of system failure or instability, the computer provides the following tools to recover your files:

- Windows recovery tools (select models only): You can use the Windows Backup utility to recover information you have previously backed up.
- *Operating System* and *Driver Recovery* discs (included with your computer): You can use the discs to recover your operating system and programs installed at the factory.

## Recovering your information

To recover information you previously backed up, follow these steps:

1. If possible, back up all personal files.
2. Click **Start > All Programs > Accessories > System Tools > Backup**.  
The Backup or Restore Wizard opens.
3. Click **Restore files and settings**, and then click **Next**.
4. Follow the on-screen instructions.

---

 **NOTE:** For additional information on initiating a recovery in Windows, perform a search for this topic in Help and Support.

---

## Recovering the operating system and programs

 **CAUTION:** The recovery process reformats and completely erases the hard drive. All files you have created and any software installed on the computer are permanently removed. The recovery process reinstalls the original operating system as well as software and drivers. Software, drivers, and updates not installed by HP must be manually reinstalled. Personal files must be restored from a backup.

---

To recover your operating system and programs, follow these steps:

1. If possible, back up all personal files.
2. Insert the *Operating System* disc into the optical drive.
3. Shut down the computer.
4. Turn on the computer.
5. Follow the on-screen instructions to install the operating system.
6. After the operating system is installed, remove the *Operating System* disc and insert the *Driver Recovery* disc.
7. Follow the on-screen instructions to install the drivers and programs.

---

# 13 Computer Setup

## Starting Computer Setup

Computer Setup is a preinstalled, ROM-based utility that can be used even when the operating system is not working or will not load.

 **NOTE:** Some of the Computer Setup menu items listed in this guide may not be supported by your computer.

**NOTE:** An external keyboard or mouse connected to a USB port can be used with Computer Setup only if USB legacy support is enabled.

To start Computer Setup, follow these steps:

1. Turn on or restart the computer, and then press **esc** while the “Press the ESC key for Startup Menu” message is displayed at the bottom of the screen.
2. Press **f10** to enter BIOS Setup.

## Using Computer Setup

### Navigating and selecting in Computer Setup

The information and settings in Computer Setup are accessed from the File, Security, Diagnostics, and System Configuration menus.

To navigate and select in Computer Setup, follow these steps:

1. Turn on or restart the computer, and then press **esc** while the “Press the ESC key for Startup Menu” message is displayed at the bottom of the screen.
  - To select a menu or a menu item, use the tab key and the keyboard arrow keys and then press **enter**, or use a pointing device to click the item.
  - To scroll up and down, click the up arrow or the down arrow in the upper-right corner of the screen, or use the up arrow key or the down arrow key.
  - To close open dialog boxes and return to the main Computer Setup screen, press **esc**, and then follow the on-screen instructions.

 **NOTE:** You can use either a pointing device (TouchPad, pointing stick, or USB mouse) or the keyboard to navigate and make selections in Computer Setup.

2. Press **f10** to enter BIOS Setup.
3. Select the **File**, **Security**, **Diagnostics**, or **System Configuration** menu.

To exit Computer Setup menus, choose one of the following methods:

- To exit Computer Setup menus without saving your changes, click the **Exit** icon in the lower-left corner of the screen, and then follow the on-screen instructions.  
– or –  
Use the tab key and the arrow keys to select **File > Ignore changes and exit**, and then press [enter](#).  
– or –
- To save your changes and exit Computer Setup menus, click the **Save** icon in the lower-left corner of the screen, and then follow the on-screen instructions.  
– or –  
Use the tab key and the arrow keys to select **File > Save changes and exit**, and then press [enter](#).

Your changes go into effect when the computer restarts.

## Restoring factory settings in Computer Setup

---

 **NOTE:** Restoring defaults will not change the hard drive mode.

---

To return all settings in Computer Setup to the values that were set at the factory, follow these steps:

1. Turn on or restart the computer, and then press [esc](#) while the “Press the ESC key for Startup Menu” message is displayed at the bottom of the screen.
2. Press [f10](#) to enter BIOS Setup.
3. Use a pointing device or the arrow keys to select **File > Restore defaults**.
4. Follow the on-screen instructions.
5. To save your changes and exit, click the **Save** icon in the lower-left corner of the screen, and then follow the on-screen instructions.

– or –

Use the arrow keys to select **File > Save changes and exit**, and then press [enter](#).

Your changes go into effect when the computer restarts.

---

 **NOTE:** Your password settings and security settings are not changed when you restore the factory settings.

---

## Computer Setup menus

The menu tables in this section provide an overview of Computer Setup options.

---

 **NOTE:** Some of the Computer Setup menu items listed in this chapter may not be supported by your computer.

---

## File menu

| Select                                 | To do this  |
|--|---|
| System Information                     | <ul style="list-style-type: none"><li>• View identification information for the computer and the batteries in the system.</li><li>• View specification information for the processor, cache and memory size, system ROM, video revision, and keyboard controller version.</li></ul>   |
| Set System Date and Time               | Set or change the date and time on the computer.  |
| System Diagnostics                     | Displays the following information: <ul style="list-style-type: none"><li>• System Information<ul style="list-style-type: none"><li>◦ Identification information for the computer and the batteries in the system</li><li>◦ Specification information for the processor, cache and memory size, system ROM, video revision, and keyboard controller version</li></ul></li><li>• Start-up Test—Verifies the system components needed for starting the computer.</li><li>• Run-In Test—Runs a comprehensive check on system memory.</li><li>• Hard Disk Test—Runs a comprehensive self-test on any hard drive in the system.</li><li>• Memory Test—Runs a comprehensive test on any memory installed in the computer.</li><li>• Battery Test—Runs a comprehensive test on any batteries installed in the computer.</li><li>• Error Log—Displays a log file if any errors have occurred.</li></ul> |
| Restore defaults                       | Replace the configuration settings in Computer Setup with the original factory settings. (Hard drive mode, password settings, and security settings are not changed when you restore the factory settings.)   |
| Reset BIOS security to factory default | Restore the BIOS security settings to the factory default.  |
| Ignore changes and exit                | Cancel any changes entered during the current session. Then exit and restart the computer.  |
| Save changes and exit                  | Save any changes entered during the current session. Then exit and restart the computer. Your changes go into effect when the computer restarts.  |

## Security menu

 **NOTE:** Some of the menu items listed in this section may not be supported by your computer.

| Select                     | To do this |
|----------------------------|------------|
| <b>Administrator Tools</b> |            |



| Select  | To do this  |
|---|---|
| Setup BIOS Administrator Password                               | Set up a BIOS administrator password.   |
| <b>User Management (requires a BIOS administrator password)</b> |   |
| Create New BIOS User Account                                    | <ul style="list-style-type: none"> <li>Select from a list of BIOS users.</li> <li>Select from a list of ProtectTools users.</li> </ul>  |
| Password Policy (requires a BIOS administrator password)        | Revise password policy criteria.  |
| HP SpareKey   | Enable/disable HP SpareKey (enabled by default).  |
| Always Prompt for HP SpareKey Enrollment                        | Enable/disable HP SpareKey enrollment (enabled by default).   |
| Fingerprint Reset on Reboot (If Present)                        | Reset/clear the fingerprint reader ownership (select models only; disabled by default).   |
| <b>User Tools</b>   |   |
| Change Password   | Enter, change, or delete a BIOS administrator password.   |
| HP SpareKey Enrollment  | Enroll or reset HP SpareKey, which is a set of security questions and answers used if you forget your password.   |
| <b>Anti Theft</b>   |   |
| AT-P  | Enable/disable Anti-Theft Protection.   |
| DriveLock Passwords   | <ul style="list-style-type: none"> <li>Enable/disable DriveLock on any computer hard drive (enabled by default).</li> <li>Change a DriveLock user password or master password.</li> </ul> <p><b>NOTE:</b> DriveLock settings are accessible only when you enter Computer Setup by turning on (not restarting) the computer.</p>                       |
| Automatic DriveLock   | Enable/disable Automatic DriveLock support.   |
| TPM Embedded Security   | <p>Enable/disable support for Trusted Platform Module (TPM) Embedded Security, which protects the computer from unauthorized access to owner functions available in Embedded Security for ProtectTools. For more information, refer to the ProtectTools software Help.</p> <p><b>NOTE:</b> You must have a setup password to change this setting.</p> |
| Disk Sanitizer  | <p>Run Disk Sanitizer to destroy all existing data on the primary hard drive or the drive in the upgrade bay.</p> <p><b>CAUTION:</b> If you run Disk Sanitizer, the data on the selected drive is destroyed permanently.</p>  |
| System IDs  | Enter a user-defined computer asset tracking number and ownership tag.  |

## System Configuration menu

 **NOTE:** Some of the listed System Configuration options may not be supported by your computer.

| Select                | To do this  |
|-----------------------|---|
| Language              | Change the Computer Setup language.   |
| Boot Options          | <ul style="list-style-type: none"> <li>• Set a Startup Menu delay (in seconds).</li> <li>• Set the Multiboot Express Boot Popup delay in seconds.</li> <li>• Enable/disable Custom Logo (disabled by default).</li> <li>• Enable/disable Display Diagnostic URL (enabled by default).</li> <li>• Enable/disable CD-ROM boot (enabled by default).</li> <li>• Enable/disable SD Card boot (enabled by default).</li> <li>• Enable/disable floppy boot (enabled by default).</li> <li>• Enable/disable PXE Internal NIC boot (enabled by default).</li> <li>• Enable/Disable Unified Extensible Firmware Interface (UEFI) Boot Mode (disabled by default).</li> <li>• Set the Legacy Boot Order.</li> </ul>   |
| Device Configurations | <ul style="list-style-type: none"> <li>• Enable/disable USB legacy support (enabled by default). When enabled, USB legacy support allows the following: <ul style="list-style-type: none"> <li>◦ Use of a USB keyboard in Computer Setup even when a Windows® operating system is not running.</li> <li>◦ Startup from bootable USB devices, including a hard drive, diskette drive, or optical drive connected by a USB port to the computer.</li> </ul> </li> <li>• Select a parallel port mode: ECP (Enhanced Capabilities Port), standard, bidirectional, or EPP (Enhanced Parallel Port).</li> <li>• Enable/disable fan always on while connected to an AC outlet (enabled by default).</li> <li>• Enable/disable Data Execution Prevention (select models only). When enabled, the processor can disable some virus code execution, which helps to improve computer security (disabled by default).</li> <li>• Set the SATA (Serial Advanced Technology Attachment) device mode. The following options are available: <ul style="list-style-type: none"> <li>◦ AHCI (Advanced Host Controller Interface)</li> <li>◦ IDE (Integrated Drive Electronics)</li> <li>◦ RAID (select models only)</li> </ul> <p><b>NOTE:</b> Availability of the options above varies by computer model.</p> </li> <li>• Enable/disable secondary battery fast charge (enabled by default).</li> <li>• Enable/disable HP QuickLook (enabled by default).</li> </ul> |

| Select                  | To do this  |
|-------------------------|---|
|                         | <ul style="list-style-type: none"> <li>• Enable/disable Preboot Authentication on HP QuickLook Boot (disabled by default).</li> <li>• Enable/disable HP QuickWeb (enabled by default).</li> <li>• Enable/disable HP QuickWeb: Write Protect (disabled by default).</li> <li>• Enable/disable Virtualization Technology (select models only; disabled by default).</li> <li>• Enable/disable TXT (Intel Trusted Execution Technology) (select models only; disabled by default).</li> <li>• Enable/disable Multi Core CPU (enabled by default).</li> <li>• Enable/disable Intel HT Technology (enabled by default).</li> <li>• Enable/disable Wake on USB (enabled by default).</li> <li>• Enable/disable Num lock state at boot (disabled by default).</li> </ul>   |
| Built-In Device Options | <ul style="list-style-type: none"> <li>• Enable/disable the wireless button state (enabled by default).</li> <li>• Enable/disable embedded WLAN device radio (select models only; enabled by default).</li> <li>• Enable/disable the embedded Bluetooth® device radio (enabled by default).</li> <li>• Enable/disable the Network Interface Controller (LAN) (enabled by default).</li> <li>• Enable/disable LAN/WLAN switching (disabled by default).</li> <li>• Set the wake on LAN state. Options include the following: <ul style="list-style-type: none"> <li>◦ Disabled</li> <li>◦ Boot to Network</li> <li>◦ Follow Boot Order</li> </ul> </li> <li>• Enable/disable the Ambient Light Sensor.</li> <li>• Enable/disable the Notebook Upgrade Bay device (enabled by default).</li> <li>• Enable/disable the fingerprint device (enabled by default).</li> <li>• Enable/disable the integrated camera (enabled by default).</li> <li>• Enable/disable the Power Monitor Circuit (enabled by default).</li> <li>• Enable/disable the audio device (enabled by default).</li> <li>• Enable/disable a modem device (enabled by default).</li> </ul> |

| Select                                    | To do this   |
|---|--|
|   | <ul style="list-style-type: none"> <li>• Enable/disable the microphone (enabled by default).</li> <li>• Enable/disable the internal speakers (enabled by default).</li> </ul>  |
| Port Options (all are enabled by default) | <p><b>NOTE:</b> All port options are enabled by default.</p> <ul style="list-style-type: none"> <li>• Enable/disable the serial port.</li> <li>• Enable/disable the parallel port.</li> <li>• Enable/disable the flash media reader.</li> <li>• Enable/disable the USB port.</li> </ul> <p><b>CAUTION:</b> Disabling the USB port also disables MultiBay devices and ExpressCard devices on the advanced port replicator.</p> <ul style="list-style-type: none"> <li>• Enable/disable the 1394 port.</li> <li>• Enable/disable the ExpressCard slot.</li> <li>• Enable/disable the Smart Card slot.</li> <li>• Enable/disable the eSATA port.</li> </ul> |
| AMT Options                               | <ul style="list-style-type: none"> <li>• Enable/disable Firmware Verbosity.</li> <li>• Enable/disable AMT Setup Prompt (Ctrl-P).</li> <li>• Enable/disable USB Key Provisioning Support.</li> <li>• Enable/disable Unconfigure AMT on next boot.</li> <li>• Select Terminal Emulation Mode. <ul style="list-style-type: none"> <li>◦ ANSI</li> <li>◦ VT100</li> </ul> </li> <li>• Enable/disable Firmware Progress Event Support.</li> <li>• Enable/disable Initiate Intel CIRA.</li> </ul>  |
| Set Security Level                        | Change, view, or hide security levels for all BIOS menu items.   |
| Restore Security Defaults                 | Restore the default security settings.   |

---

# 14 MultiBoot

## About the boot device order

As the computer starts, the system attempts to boot from enabled boot devices. The MultiBoot utility, which is enabled at the factory, controls the order in which the system selects a boot device. Boot devices can include optical drives, diskette drives, a network interface card (NIC), hard drives, and USB devices. Boot devices contain bootable media or files that the computer needs to start and operate properly.

---

 **NOTE:** Some boot devices must be enabled in Computer Setup before they can be included in the boot order.

---

The factory setting is for the computer to select the boot device by searching enabled boot devices and drive bay locations in the following order:

---

 **NOTE:** Some of the boot devices and drive bay locations listed may not be supported on your computer.

---

- Notebook upgrade bay
- Notebook hard drive
- USB diskette drive
- USB CD-ROM drive
- USB hard drive
- Notebook Ethernet
- Secure Digital (SD) Memory Card
- Docking station upgrade bay
- External SATA drive

You can change the order in which the computer searches for a boot device by changing the boot order in Computer Setup. You can also press **esc** while the “Press the ESC key for Startup Menu” message is displayed at the bottom of the screen, and then press **f9**. Pressing **f9** displays a menu that shows the current boot devices and allows you to select a boot device. Or, you can use MultiBoot Express to set the computer to prompt you for a boot location each time the computer turns on or restarts.

If MultiBoot is disabled, the computer uses a fixed boot order that consists of first searching for a drive A boot device. If none is found, the computer looks for a drive C boot device. Drive A boot devices include optical drives and diskette drives. Drive C boot devices include optical drives and hard drives.

The NIC does not have an assigned drive letter.

---

 **NOTE:** An optical drive (such as a CD-ROM drive) can boot either as drive A or drive C, depending on the format of the boot CD.

---

# Enabling boot devices in Computer Setup

The computer will boot to a USB device or a NIC device only if the device has first been enabled in Computer Setup.

To start Computer Setup and enable a USB device or a NIC device as a boot device, follow these steps:

1. Turn on or restart the computer, and then press **esc** while the “Press the ESC key for Startup Menu” message is displayed at the bottom of the screen.
2. Press **f10** to enter BIOS Setup.
3. To enable bootable media in USB drives or in drives inserted into an optional docking device (select models only), use a pointing device or the arrow keys to select **System Configuration > Device Configurations**. Confirm that **Enabled** is selected next to **USB legacy support**.

---

 **NOTE:** The USB Port option must be enabled in order to use USB legacy support. It is enabled at the factory. If the port becomes disabled, reenable it by selecting **System Configuration > Port Options**, and then clicking **Enabled** next to **USB Port**.

---

– or –

To enable a NIC device, select **System Configuration > Boot Options**, and then click **Enabled** next to **PXE Internal NIC boot**.

4. To save your changes and exit Computer Setup, click **Save** in the lower-left corner of the screen, and then follow the on-screen instructions.

– or –

Use the arrow keys to select **File > Save Changes and Exit**, and then press **enter**.

Your changes go into effect when the computer restarts.

---

 **NOTE:** To connect a NIC to a Preboot eXecution Environment (PXE) or Remote Program Load (RPL) server without using MultiBoot, press **esc** while the “Press the ESC key for Startup Menu” message is displayed at the bottom of the screen, and then quickly press **f12**.

---

## Considering boot order changes

Before changing the boot order, note the following considerations:

- When the computer restarts after the boot order has been changed, the computer attempts to start using the new boot order.
- If there is more than one type of boot device, the computer attempts to boot using the first of each type of boot device (except for optical devices). For example, if the computer is connected to an optional docking device (select models only) that contains a hard drive, this hard drive will be shown in the boot order as a USB hard drive. If the system attempts to boot from this USB hard drive and fails, it will not attempt to boot to the hard drive in the hard drive bay. Instead, it will try to boot to the next type of device in the boot order. However, if there are 2 optical devices, and the first optical device does not boot (either because it does not contain media or the media is not a boot disc), the system will try to boot to the second optical device.
- Changing the boot order also changes the logical drive designations. For example, if you start up from a CD-ROM drive with a disc formatted as drive C, that CD-ROM drive becomes drive C and the hard drive in the hard drive bay becomes drive D.
- The computer will boot from a NIC device only if the device has been enabled in the Built-In Device Options menu of Computer Setup and if booting from the device has been enabled in the Boot Options menu of Computer Setup. Booting from a NIC does not affect logical drive designations because no drive letter is associated with the NIC.
- Drives in an optional docking device (select models only) are treated like external USB devices in the boot order.



# Choosing MultiBoot preferences

You can use MultiBoot in the following ways:

- To set a new boot order that the computer uses each time it is turned on, by changing the boot order in Computer Setup.
- To dynamically choose the boot device, by pressing [esc](#) while the “Press the ESC key for Startup Menu” message is displayed at the bottom of the screen, and then pressing [f9](#) to enter the Boot Device Options menu.
- To use MultiBoot Express to set variable boot orders. This feature prompts you for a boot device each time the computer is turned on or restarted.

## Setting a new boot order in Computer Setup

To start Computer Setup and set a boot device order that the computer uses each time it is turned on or restarted, follow these steps:

1. Turn on or restart the computer, and then press [esc](#) while the “Press the ESC key for Startup Menu” message is displayed at the bottom of the screen.
2. Press [f10](#) to enter BIOS Setup.
3. Use a pointing device or the arrow keys to select a device in the list.
4. To move the device up in the boot order, use a pointing device to click the up arrow key next to the device name, or press the [+](#) key.

– or –

To move the device down in the boot order, use a pointing device to click the down arrow key next to the device name, or press the [-](#) key.

5. To save your changes and exit Computer Setup, click **Save** in the lower-left corner of the screen, and then follow the on-screen instructions.

– or –

Use the arrow keys to select **File > Save Changes and Exit**, and then press [enter](#).

Your changes go into effect when the computer restarts.

## Dynamically choosing a boot device

To dynamically choose a boot device for the current startup sequence, follow these steps:

1. Open the Select Boot Device menu by turning on or restarting the computer, and then pressing [esc](#) while the “Press the ESC key for Startup Menu” message is displayed at the bottom of the screen.
2. Press [f9](#).
3. Use a pointing device or the arrow keys to select a boot device, and then press [enter](#).

Your changes go into effect immediately.

## Setting a MultiBoot Express prompt

To start Computer Setup and set the computer to display the MultiBoot startup location menu each time the computer is started or restarted, follow these steps:

1. Turn on or restart the computer, and then press **esc** while the “Press the ESC key for Startup Menu” message is displayed at the bottom of the screen.
2. Press **f10** to enter BIOS Setup.
3. Use a pointing device or the arrow keys to select **System Configuration > Boot Options**, and then press **enter**.
4. In the **Express Boot Popup Delay (Sec)** field, enter the length of time in seconds that you want the computer to display the startup location menu before it defaults to the current MultiBoot setting. (When 0 is selected, the Express Boot startup location menu is not displayed.)
5. To save your changes and exit Computer Setup, click **Save** in the lower-left corner of the screen, and then follow the on-screen instructions.

– or –

Use the arrow keys to select **File > Save Changes and Exit**, and then press **enter**.

Your changes go into effect when the computer restarts.

## Entering MultiBoot Express preferences

When the Express Boot menu is displayed during startup, you have the following choices:

- To specify a boot device from the Express Boot menu, select your preference within the allotted time, and then press **enter**.
- To prevent the computer from defaulting to the current MultiBoot setting, press any key before the allotted time expires. The computer will not start until you select a boot device and press **enter**.
- To allow the computer to start according to the current MultiBoot settings, wait for the allotted time to expire.

---

# 15 Management and Printing

## Using Client Management Solutions

Client Management Solutions software provides standards-based solutions for managing client (user) desktop, workstation, notebook, and tablet computers in a networked environment.

Client management includes the following key capabilities and features:

- Initial software image deployment
- Remote system software installation
- Software management and updates
- ROM updates
- Tracking and security of computer assets (the hardware and software installed on the computer)
- Fault notification and recovery of certain system software and hardware components

---

 **NOTE:** Support for specific features described in this section may vary, depending on computer model and/or version of management software installed on the computer.

---

## Configuring and deploying a software image

The computer is shipped with a preinstalled system software image. The initial software image is configured during the first-time setup of the computer. After a brief software "unbundling" occurs, the computer is ready to be used.

A customized software image can be deployed (distributed) in one of the following ways:

- Installing additional software applications after unbundling the preinstalled software image
- Using a disk-cloning process to copy the contents from one hard drive to another

The deployment method you use depends on your organization's technology environment and processes.

---

 **NOTE:** The Computer Setup utility and other system features provide further assistance with configuration management and troubleshooting, power management, and the recovery of system software.

---

## Managing and updating software

HP provides several tools for managing and updating software on client computers:

- HP Client Automation (select models only)
- HP SSM (System Software Manager)

### HP Client Automation (select models only)

HP Client Automation automates the management of software such as operating systems, programs, software updates, and content and configuration settings to ensure that each computer is maintained in the correct configuration. With these automated management solutions, you can manage software throughout the life cycle of the computer.

HP Client Automation enables you to perform the following tasks:

- Collecting hardware and software inventory across multiple platforms
- Preparing a software package and conducting impact analysis prior to distribution
- Targeting individual computers, workgroups, or entire populations of computers for deployment and maintenance of software and content according to policies
- Provisioning and managing operating systems, applications, and content on distributed computers from any location
- Integrating HP Client Automation with help desks and other system management tools for seamless operations
- Leveraging a common infrastructure for management of software and content on standard computing devices across any network for all enterprise users
- Scaling to meet enterprise needs

### HP SSM (System Software Manager)

HP SSM (System Software Manager) lets you remotely update system-level software on multiple systems simultaneously. When executed on a client computer, SSM detects versions of both hardware and software, and then updates designated software from a central repository, known as a file store. Driver versions that are supported by SSM are denoted with a special icon on the HP driver download Web site and on the *Support Software* CD. To download the SSM utility or to obtain more information on SSM, see the HP Web site at <http://www.hp.com/go/ssm> (English only).

# Index

## Symbols/Numerics

- 1394 cable, connecting 90
- 1394 devices
  - connecting 90
  - stopping 90
- 1394 port 90
- 1394 port, identifying 8

## A

- AC adapter
  - connecting 64
  - identifying 12
- accessory battery connector, identifying 9
- administrator password 109
- airport security devices 75
- ambient light sensor
  - hotkey 34
- AMT options
  - AMT Setup Prompt (Ctrl-P) 136
  - Firmware Progress Event Support 136
  - Firmware Verbosity 136
  - Initiate Intel CIRA 136
  - Terminal Emulation Mode 136
  - Unconfigure AMT on next boot 136
  - USB Key Provisioning Support 136
- antennas 11
- Anti Theft 133
- applications key, Windows 6
- audio devices, connecting external 41
- audio functions, checking 41
- audio-in (microphone) jack, identifying 8
- audio-out (headphone) jack, identifying 8

- Automatic DriveLock password
  - entering 114
  - removing 115
- AutoPlay 48

## B

- battery
  - calibrating 68
  - charging 66, 69
  - conserving power 70
  - disposing 71
  - identifying 12
  - inserting 65
  - low battery levels 67
  - recharging 70
  - removing 65
  - replacing 71
  - storing 70
- battery bay 9, 13
- battery charge information 34
- battery charge, maximizing 67
- battery light 66, 67
- battery light, identifying 3, 6
- battery power 64
- battery release latch 9, 65
- battery temperature 70
- bays
  - battery 9, 13
  - hard drive 10
- BD
  - copying 49
  - playing 47
  - removing 50
- BIOS administrator password 133
- BIOS update
  - downloading 124
  - installing 125
- Blu-ray Disc (BD) 45

- Blu-ray ROM with LightScribe Drive 45
- Bluetooth
  - label 13
- Bluetooth compartment, identifying 7
- Bluetooth device 14
- boot devices, enabling 139
- boot options 134
- boot order 134
- built-in device
  - Ambient Light Sensor 135
  - audio device 135
  - Bluetooth device radio 135
  - fingerprint reader 135
  - integrated camera 135
  - internal speakers 136
  - LAN/WLAN switching 135
  - microphone 136
  - modem 135
  - Network Interface Controller (LAN) 135
  - Notebook Upgrade Bay 135
  - Power Monitor Circuit 135
  - Wake on LAN 135
  - wireless button 135
  - WLAN device radio 135
- built-in device options 135
- business card holder, identifying 10
- business card reader software 57
- business card slot, identifying 7
- buttons
  - caps lock 5
  - display release 7
  - keyboard light 10
  - num lock 5
  - pointing stick 2
  - power 4

- QuickLook 4
  - QuickWeb 5
  - TouchPad 2, 5
  - volume mute 5
  - wireless 5
- C**
- cables
    - 1394 90
    - modem 27
    - USB 88
  - calibrating battery 68
  - caps lock button, identifying 5
  - caps lock light, identifying 3
  - CD
    - copying 49
    - playing 47
    - removing 50
  - CD drive 92
  - Certificate of Authenticity label 13
  - changing boot order 141
  - charging batteries 66, 69
  - checking audio functions 41
  - compartments
    - Bluetooth 7
    - expansion memory module 10
  - components
    - additional hardware 12
    - bottom 9
    - display 10
    - front 6
    - left-side 8
    - rear 7
    - right-side 7
    - top 1
  - computer information 124
  - Computer Setup
    - BIOS administrator
      - password 110
    - device security 116
    - DriveLock password 112
    - enabling bootable
      - devices 139
    - File menu 132
    - navigating and selecting 130
    - restoring factory settings 131
    - Security menu 132
    - setting boot order 141
    - setting MultiBoot Express
      - prompt 142
    - System Configuration
      - menu 133
    - Computer Setup utility 143
    - configuring ExpressCards 95
    - connecting to a LAN 31
    - connecting to a WLAN 19
    - connection, external power 64
    - connector, power 7
    - conservation, power 70
    - copyright warning 49
    - cord, power 12
    - corporate WLAN connection 19
    - country- or region-specific modem
      - cable adapter 27
    - critical battery level 68
  - D**
    - deployment, software 143
    - device configurations 134
    - device drivers
      - HP drivers 54
      - Microsoft drivers 55
      - reinstalling 54
    - device security 116
    - digital card
      - inserting 94
      - removing 95
      - stopping 95
    - discs
      - Driver Recovery 129
      - Operating System 129
    - Disk Cleanup software 76
    - Disk Defragmenter software 76
    - disk sanitizer 133
    - diskette drive 92
    - display
      - image, switching 34
      - screen brightness hotkeys 34
    - display components 10
    - display release button,
      - identifying 7
    - DisplayPort 34
    - DisplayPort, identifying 7
    - docking connector, identifying 9
    - drive light 7, 77
    - drive light, identifying 3
    - drive media 59
    - DriveLock password
      - changing 113
      - description 112
      - entering 113
      - removing 114
      - setting 112
    - DriveLock, automatic 133
    - Driver Recovery disc 129
    - drives
      - diskette 92
      - DVD-ROM 45
      - DVD±RW SuperMulti DL
        - LightScribe Drive 45
      - external 92
      - hard 80, 92
      - optical 92
    - drives, boot order 134, 137
    - DVD
      - changing region setting 48
      - copying 49
      - playing 47
      - removing 50
    - DVD drive 92
    - DVD region settings 48
  - E**
    - encryption 18
    - esc key, identifying 5
    - Execution Disable 134
    - expansion memory module
      - inserting 101
      - removing 100
      - replacing 100
    - expansion memory module
      - compartment, identifying 10
    - ExpressCard
      - configuring 95
      - inserting 95
      - removing 97
      - removing insert 96
      - stopping 97
    - ExpressCard slot, identifying 8
    - external audio devices,
      - connecting 41
    - external drive 92
    - external monitor port 7, 43
  - F**
    - File menu 132
    - fingerprint reader, identifying 5

- firewall 18
- fn key 32
- fn key, identifying 6
- function keys 32
- function keys, identifying 6

## H

- hard drive
  - external 92
  - HP 3D DriveGuard 77
  - installing 80
- hard drive bay, identifying 10
- hard drive space 107
- hardware, identifying 1
- headphone (audio-out) jack 8
- Hibernation
  - exiting 60
  - initiated during critical battery level 68
  - initiating 60
- Hibernation file 107
- hotkeys
  - ambient light sensor 34
  - battery charge information 34
  - decreasing screen brightness 34
  - description 32
  - displaying system information 33
  - increasing screen brightness 34
  - initiating Standby 33
  - switching screen image 34
  - using 33
- HP 3D DriveGuard 77
- HP Client Automation 144
- HP Connection Manager software 16
- HP Mobile Broadband Module serial number label 13
- HP QuickLook 134
- HP SpareKey enrollment 133
- HP System Software Manager 144
- hubs 88

## I

- icons
  - network status 15
  - wireless 15

- IEEE 1394 port, identifying 8
- image, computer 143
- inserting a memory module
  - expansion 101
  - primary 105
- Intel HT Technology 135
- interference, minimizing 26
- internal display switch 4, 10
- internal microphones, identifying 10
- Internet connection setup 17

## J

- jacks
  - audio-in (microphone) 8
  - audio-out (headphone) 8
  - RJ-11 (modem) 8
  - RJ-45 (network) 8
- Java Card
  - defined 97
  - inserting 98
  - removing 98

## K

- keyboard hotkeys, identifying 32
- keyboard light button, identifying 10
- keyboard screws
  - removing 103
  - replacing 106
- keypad keys, identifying 6
- keypad, embedded
  - enabling and disabling 36
  - identifying 35
  - switching key functions 36
  - using 36
- keypad, external
  - num lock 36
  - using 36
- keys
  - esc 5
  - fn 6
  - function 6
  - keypad 6
  - Windows applications 6
  - Windows logo 6

## L

- labels
  - Bluetooth 13
  - HP Broadband 13

- Microsoft Certificate of Authenticity 13
- modem approval 13
- regulatory 13
- service tag 12
- SIM 13
- wireless certification 13
- WLAN 13
- LAN, connecting 31
- language, changing in Computer Setup 134
- latch, battery release 9
- legacy support, USB 130, 134
- light, drive 77
- lights
  - battery 3, 6
  - caps lock 3
  - drive 3, 7
  - mute 3
  - num lock 3
  - power 2, 6
  - QuickLook 3
  - QuickWeb 3
  - TouchPad 3
  - volume down 3
  - volume mute 3
  - volume up 3
  - webcam 10
  - wireless 2, 6
- logical drive designations 140
- low battery level 67

## M

- maintenance
  - Disk Cleanup 76
  - Disk Defragmenter 76
- McAfee Total Protection 118, 119
- memory module compartment cover
  - removing 100
  - replacing 101
- memory module compartment, identifying 10
- microphone (audio-in) jack 8
- microphones, internal 10
- Microsoft Certificate of Authenticity label 13
- minimizing interference 26
- modem approval label 13

- modem cable
  - connecting 27
  - country- or region-specific cable adapter 27
  - noise suppression circuitry 27
- modem software
  - setting/adding location 28
  - travel connection problems 29
- monitor port, external 7
- monitor, connecting 43
- mouse, external
  - connecting 32
  - setting preferences 32
- Multi Core CPU 135
- MultiBoot Express 137, 142
- multimedia software, installing 40
- MultiMediaCard 94
- mute button, identifying 5
- mute light, identifying 3

## N

- network key 25
- network security codes
  - network key 25
  - SSID 25
- Network Service Boot 139
- network status icon 15
- NIC boot device 137, 139
- noise suppression circuitry
  - modem cable 27
- num lock button, identifying 5
- num lock light, identifying 3
- num lock, external keypad 36

## O

- operating system
  - Microsoft Certificate of Authenticity label 13
  - Product Key 13
- Operating System disc 129
- optical disc
  - removing 50
  - using 46
- optical drive 92

## P

- parallel port mode 134
- passwords
  - administrator 109
  - BIOS administrator 110

- DriveLock 112
  - user 109
- pointing devices
  - setting preferences 32
  - using 32
- pointing stick
  - using 32
- pointing stick buttons, identifying 2
- pointing stick, identifying 1
- port options
  - 1394 port 136
  - eSATA port 136
  - ExpressCard slot 136
  - flash media reader 136
  - parallel port 136
  - serial port 136
  - Smart Card slot 136
  - USB port 136

## ports

- 1394 8, 90
- DisplayPort 7
- eSATA/USB 8
- external monitor 7, 43
- USB 8, 88

## power

- connecting 64
- conserving 70
- Power Assistant 63
- power button, identifying 4
- power connector, identifying 7
- power cord, identifying 12
- power light, identifying 6
- power lights, identifying 2
- primary memory module
  - inserting 105
  - removing 104
  - replacing 103
  - upgrading 103
- Product Key 13
- product name and number, computer 12
- projector, connecting 43
- public WLAN connection 19
- PXE server 139

## Q

- QuickLook button, identifying 4
- QuickLook light, identifying 3
- QuickWeb button, identifying 5

- QuickWeb light, identifying 3

## R

- readable media 59
- region codes, DVD 48
- regulatory information
  - modem approval label 13
  - regulatory label 13
  - wireless certification labels 13
- release latch, battery 9
- replacing a primary memory module 103
- replacing an expansion memory module 100
- restore security defaults 136
- restore the factory settings 132
- RJ-11 (modem) jack, identifying 8
- RJ-45 (network) jack, identifying 8

## S

- SATA (Serial Advanced Technology Attachment) devices
  - AHCI (Advanced Host Controller Interface) 134
  - IDE (Integrated Drive Electronics) 134
- screen brightness hotkeys 34
- screen image, switching 34
- scroll zone, TouchPad 2
- SD Card 94
- SD Card Reader 94
- SD Card Reader, identifying 7
- Secondary Battery Fast Charge 134
- security cable slot, identifying 7
- Security menu
  - always prompt for HP SpareKey enrollment 133
  - Automatic DriveLock 133
  - change password 133
  - Disk Sanitizer 133
  - DriveLock 133
  - fingerprint reader reset 133
  - HP Sparekey 133
  - HP Sparekey enrollment 133
  - password policy 133



- set up BIOS administrator password 133
  - System IDs 133
- security, protecting the computer 108
- security, wireless 17
- serial number, computer 12
- service tag 12
- set security level 136
- setup of WLAN 17
- setup utility
  - File menu 132
  - navigating and selecting 130
  - restoring factory settings 131
  - Security menu 132
  - System Configuration menu 133
- setup, computer 1
- shut down 72
- SIM label 13
- SIM slot, identifying 9
- slots
  - business card 7
  - memory 99
  - memory module 10
  - SIM 9
  - smart card reader 8
- smart card
  - defined 97
  - inserting 98
  - removing 98
- smart card reader, identifying 8
- SoftPaqs, downloading 125, 126
- software
  - BIOS update 124
  - business card reader 57
  - deployment 143
  - Disk Cleanup 76
  - Disk Defragmenter 76
  - HP Connection Manager 16
  - recovery 143
  - updates 144
  - updating programs and drivers 125
  - Wireless Assistant 16
- speaker, identifying 7
- Standby
  - exiting 59
  - initiating 59
- Standby hotkey 33
- storing battery 70
- System Configuration menu 133
- system date and time 132
- system diagnostics 132
- system fan 134
- system IDs 133
- system information 132
- system information hotkey 33

**T**

- temperature 70
- TouchPad
  - buttons 2
  - identifying 2
  - scroll zone 2
  - using 32
- TouchPad button, identifying 5
- TouchPad light, identifying 3
- TPM Embedded Security 133
- traveling with the computer
  - modem approval label 13
- troubleshooting
  - AutoPlay 53
  - device drivers 54
  - disc burning 54
  - disc play 52
  - external display 54
  - HP device drivers 54
  - Microsoft device drivers 55
  - movie play 53
  - optical disc tray 51
  - optical drive detection 52
- troubleshooting modem 29
- troubleshooting wireless network problems 24
- turning off the computer 72
- TXT (Intel Trusted Execution Technology) 135

**U**

- Unified Extensible Firmware Interface (UEFI) mode 134
- unresponsive system 72
- updates, software 144
- upgrade bay
  - replacing a hard drive 82
  - replacing an optical drive 85
- upgrade bay, identifying 8
- USB cable, connecting 88

**USB devices**

- connecting 88
- description 88
- removing 89
- stopping 89

USB hubs 88

USB legacy support 89, 130, 134

USB ports, identifying 8, 88

User management 133

user password 109

**V**

- vent 8
- vents, identifying 9
- video transmission types 34
- video, recording 10
- Virtualization Technology 135
- volume down button, identifying 5
- volume down light, identifying 3
- volume hotkeys 38
- volume mute button, identifying 5
- volume mute light, identifying 3
- volume up button, identifying 5
- volume up light, identifying 3
- volume, adjusting 38

**W**

Web sites

- HP System Software Manager 144

webcam 10

webcam business card capture 57

webcam light, identifying 10

webcam properties, adjusting 56

Windows applications key, identifying 6

Windows Backup utility 127, 128, 129

Windows logo key, identifying 6

Windows recovery 129

wireless antennas 11

Wireless Assistant software 16

wireless button 5, 15

wireless certification label 13

wireless controls
 

- button 15
- operating system 15

- wireless icon 15
- wireless light 6, 15
- wireless light, identifying 2
- wireless network (WLAN)
  - connecting 19
  - corporate WLAN
    - connection 19
  - equipment needed 17
  - functional range 19
  - public WLAN connection 19
  - security 17
- wireless network problems,
  - troubleshooting 24
- WLAN device 13, 14, 17
- WLAN label 13
- WLAN module compartment,
  - identifying 9
- writable media 59
- WWAN device 14
- WWAN module compartment,
  - identifying 9

