



LASERJET PRO 100 COLOR MFP M175

User Guide





LaserJet Pro 100 color MFP M175

User Guide

Copyright and License

© 2012 Copyright Hewlett-Packard Development Company, L.P.

Reproduction, adaptation, or translation without prior written permission is prohibited, except as allowed under the copyright laws.

The information contained herein is subject to change without notice.

The only warranties for HP products and services are set forth in the express warranty statements accompanying such products and services. Nothing herein should be construed as constituting an additional warranty. HP shall not be liable for technical or editorial errors or omissions contained herein.

Edition 1, 7/2012

Part number: CE866-90908

Trademark Credits

Adobe®, Acrobat®, and PostScript® are trademarks of Adobe Systems Incorporated.

Intel® Core™ is a trademark of Intel Corporation in the U.S. and other countries.

Java™ is a US trademark of Sun Microsystems, Inc.

Microsoft®, Windows®, Windows® XP, and Windows Vista® are U.S. registered trademarks of Microsoft Corporation.

UNIX® is a registered trademark of The Open Group.

ENERGY STAR® and the ENERGY STAR® mark are registered U.S. marks.

Conventions used in this guide

 **TIP:** Tips provide helpful hints or shortcuts.

 **NOTE:** Notes provide important information to explain a concept or to complete a task.

 **CAUTION:** Cautions indicate procedures that you should follow to avoid losing data or damaging the product.

 **WARNING!** Warnings alert you to specific procedures that you should follow to avoid personal injury, catastrophic loss of data, or extensive damage to the product.

Table of contents

1 Product basics	1
Product comparison	2
Environmental features	3
Accessibility features	3
Product views	4
Product front view	4
Product back view	5
Serial number and model number location	5
Control panel layout	6
2 Control panel menus	7
Setup menu	8
Reports menu	8
System Setup menu	8
Service menu	10
Network Setup menu (network models only)	11
Function specific menus	12
Copy Menu	12
3 Software for Windows	15
Supported operating systems for Windows	16
Supported printer drivers for Windows	16
Select the correct printer driver for Windows	16
Change print job settings	18
Change printer-driver settings for Windows	19
Change the settings for all print jobs until the software program is closed	19
Change the default settings for all print jobs	19
Change the product configuration settings	19
Remove software for Windows	20
Supported utilities for Windows	20
Other Windows components and utilities	20
Software for other operating systems	21

4 Use the product with Mac	23
Software for Mac	24
Supported operating systems for Mac	24
Supported printer drivers for Mac	24
Install software for Mac operating systems	24
Remove software from Mac operating systems	26
Priority for print settings for Mac	26
Change printer-driver settings for Mac	27
Software for Mac computers	28
Print with Mac	29
Cancel a print job with Mac	29
Change the paper size and type with Mac	29
Resize documents or print on a custom paper size with Mac	29
Create and use printing presets with Mac	29
Print a cover page with Mac	30
Use watermarks with Mac	30
Print multiple pages on one sheet of paper with Mac	31
Print on both sides of the page (duplex printing) with Mac	31
Set the color options with Mac	31
Use the Services menu with Mac	32
Scan with Mac	33
Solve problems with Mac	34
5 Connect the product	35
Supported network operating systems (network models only)	36
Printer sharing disclaimer	36
Use HP Smart Install to connect to a computer, a wired network, or a wireless network	37
Connect with USB by using the software CD-ROM	38
Connect to a network by using the software CD-ROM (network models only)	39
Supported network protocols	39
Install the product on a wired network	39
Install the product on a wireless network	40
Configure the network product	45
6 Paper and print media	47
Understand paper use	48
Special paper guidelines	48
Change the printer driver to match the paper type and size	50
Supported paper sizes	51
Supported paper types	53
Load paper trays	55
Load the input tray	55
Tray capacity	56

Paper orientation for loading trays	56
7 Print cartridges and imaging drum	57
Print cartridge and imaging drum features	58
Supplies views	59
Print cartridge views	59
Imaging drum views	59
Manage print cartridges and the imaging drum	60
Change settings for print cartridges or the imaging drum	60
Replacement instructions	61
Recycle supplies	67
Print-cartridge and imaging drum storage	67
HP policy on non-HP supplies	68
HP fraud hotline and Web site	68
Solve problems with print cartridges or the imaging drum	69
Check the print cartridges and imaging drum	69
Interpret control panel messages for print cartridges or the imaging drum	73
8 Print tasks	77
Cancel a print job	78
Basic print tasks with Windows	79
Open the printer driver with Windows	79
Get help for any printing option with Windows	79
Change the number of print copies with Windows	80
Save custom print settings for reuse with Windows	80
Improve print quality with Windows	83
Print on both sides (duplex) with Windows	84
Print multiple pages per sheet with Windows	86
Select page orientation with Windows	88
Set color options with Windows	90
Additional print tasks with Windows	91
Print colored text as black with Windows	91
Print on preprinted letterhead or forms with Windows	92
Print on special paper, labels, or transparencies	94
Print the first or last page on different paper with Windows	96
Scale a document to fit page size	97
Add a watermark to a document with Windows	99
Create a booklet with Windows	99
9 Color	101
Adjust color	102
Change the color theme for a print job	102
Change the color options	102

Manual color options	103
Use the HP EasyColor option for Windows	105
Match colors	106
10 Copy	107
Use copy functions	108
One-touch copy	108
Multiple copies	108
Copy a multiple-page original	109
Copy identification cards	110
Cancel a copy job	111
Reduce or enlarge a copy	111
Collate a copy job	112
Make color or black and white copies	113
Copy settings	113
Change copy quality	113
Check the scanner glass for dirt and smudges	114
Adjust the lightness or darkness for copies	115
Define custom copy settings	115
Set the paper size and type for copying on special paper	116
Restore copy default settings	116
Copy photos	117
Copy mixed size originals	118
Copy on both sides manually (duplex)	119
11 Scan	121
Use scan functions	122
Scan methods	122
Cancel a scan	123
Scan settings	124
Scanner resolution and color	124
Scan quality	126
12 Manage and maintain the product	127
Print information pages	128
Change the product settings from a computer	130
Use HP Web Jetadmin software	131
Product security features	132
Lock the product	132
Assign a system password (network models only)	132
Economy settings	133
Sleep mode	133
Low power settings	133

Archive print	134
Clean the product	135
Clean the document feeder pickup rollers and separation pad	135
Clean the paper path	136
Clean the exterior	136
Product updates	136
13 Solve problems	137
Self help	138
Solve problems checklist	139
Step 1: Make sure that the product is set up correctly	139
Step 2: Check the cabling or wireless connection (network models only)	139
Step 3: Check the control panel for error messages	139
Step 4: Check the paper	139
Step 5: Check the software	140
Step 6: Test print functionality	140
Step 7: Test copy functionality	140
Step 8: Check the supplies	140
Step 9: Try sending a print job from a computer	140
Factors that affect product performance	141
Restore factory settings	141
Interpret control panel messages	142
Control panel message types	142
Control panel messages	142
Paper feeds incorrectly or becomes jammed	148
The product does not pick up paper	148
The product picks up multiple sheets of paper	148
Prevent paper jams	148
Clear jams	149
Improve print quality	154
Use the correct paper type setting in the printer driver	154
Adjust color settings in the printer driver	155
Use paper that meets HP specifications	156
Print a cleaning page	157
Calibrate the product to align the colors	157
Use the printer driver that best meets your printing needs	157
The product does not print or it prints slowly	159
The product does not print	159
The product prints slowly	159
Solve connectivity problems	160
Solve direct-connect problems	160
Solve network problems	160
Solve wireless network problems	162

Wireless connectivity checklist	162
The product does not print after the wireless configuration completes	162
The product does not print, and the computer has a third-party firewall installed	163
The wireless connection does not work after moving the wireless router or product	163
Cannot connect more computers to the wireless product	163
The wireless product loses communication when connected to a VPN	163
The network does not appear in the wireless networks list	163
The wireless network is not functioning	163
Product software problems with Windows	165
Solve common Mac problems	166
The printer driver is not listed in the Print & Fax list	166
The product name does not appear in the product list in the Print & Fax list	166
The printer driver does not automatically set up the selected product in the Print & Fax list	166
A print job was not sent to the product that you wanted	166
When connected with a USB cable, the product does not appear in the Print & Fax list after the driver is selected.	167
You are using a generic printer driver when using a USB connection	167

Appendix A Supplies and accessories 169

Order parts, accessories, and supplies	170
Part numbers	170
Print cartridges	170
Imaging drums	170
Cables and interfaces	170

Appendix B Service and support 171

Hewlett-Packard limited warranty statement	172
HP's Premium Protection Warranty: LaserJet print cartridge limited warranty statement	174
HP's LaserJet imaging drum limited warranty statement for replacement imaging drums	175
Data stored on the print cartridge and imaging drum	176
End User License Agreement	177
OpenSSL	179
Customer support	179
Repack the product	180

Appendix C Specifications 181

Physical specifications	182
Power consumption, electrical specifications, and acoustic emissions	182
Environmental specifications	182

Appendix D Regulatory information 183

FCC regulations	184
-----------------------	-----

Environmental product stewardship program	185
Protecting the environment	185
Ozone production	185
Power consumption	185
Paper use	185
Plastics	185
HP LaserJet print supplies	185
Return and recycling instructions	186
Paper	187
Material restrictions	187
Disposal of waste equipment by users in private households in the European Union	187
Chemical substances	187
Material Safety Data Sheet (MSDS)	187
For more information	187
Declaration of conformity (base models)	189
Declaration of conformity (wireless models)	191
Safety statements	193
Laser safety	193
Canadian DOC regulations	193
VCCI statement (Japan)	193
Power cord instructions	193
Power cord statement (Japan)	193
EMC statement (Korea)	193
Laser statement for Finland	194
GS statement (Germany)	194
Substances Table (China)	195
Restriction on Hazardous Substances statement (Turkey)	195
Additional statements for wireless products	196
FCC compliance statement—United States	196
Australia statement	196
Brazil ANATEL statement	196
Canadian statements	196
European Union regulatory notice	196
Notice for use in France	197
Notice for use in Russia	197
Korean statement	197
Taiwan statement	197
Index	199

1 Product basics

- [Product comparison](#)
- [Environmental features](#)
- [Accessibility features](#)
- [Product views](#)

Product comparison

Base model



- **Speed:** Prints up to 16 A4-size pages per minute (ppm) or 17 letter-size ppm monochrome and 4 ppm color
- **Tray:** 150 sheets of 75 g/m² (20 lb)
- **Output bin:** 50 sheets of 75 g/m² (20 lb)
- **Connectivity:** Hi-Speed USB 2.0 port
- **Two-sided printing (duplexing):** Manual duplexing (using the printer driver)
- **Introductory print cartridges:** Supplied with product

Network model



HP LaserJet Pro 100 color MFP M175 plus:

- **Connectivity:** 802.11b/g/n wireless networking and built-in networking to connect to 10Base-T/100Base-TX networks

Environmental features

Recycling	Reduce waste by using recycled paper. Recycle print cartridges by using the HP return process.
Energy savings	Save energy with sleep mode and low power mode. HP Instant-on Technology produces the first page faster when the product is coming out sleep mode or low power mode so that the print job is done sooner.
Manual duplex printing	Save paper by using the manual duplex printing setting.
Print multiple pages per sheet	Save paper by printing two or more pages of a document side-by-side on one sheet of paper. Access this feature through the printer driver.

Accessibility features

The product includes several features that aid users with accessibility issues.

- Online user guide that is compatible with text screen-readers.
- All doors and covers can be opened by using one hand.

Product views

Product front view

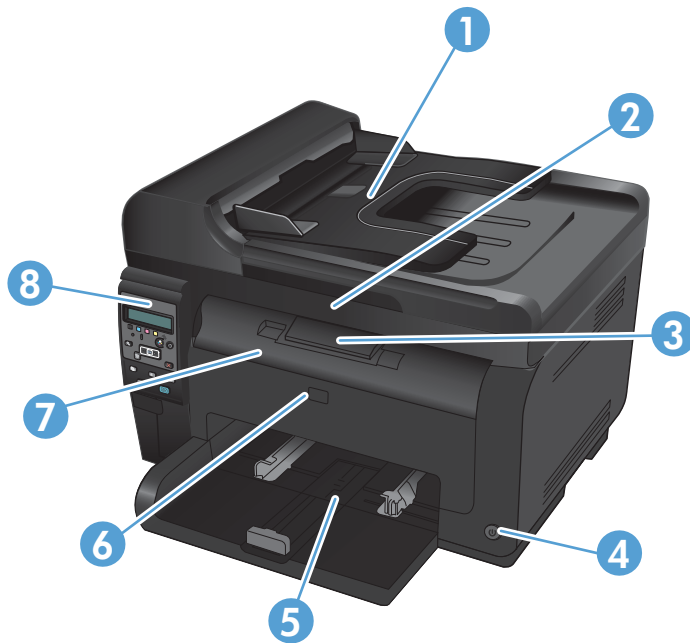

1	Document feeder
2	Scanner
3	Output bin
4	Power button
5	Main-input tray
6	Front cover (provides access to the imaging drum)
7	Print cartridge door (provides access to the print cartridges)
8	Control panel

Product back view

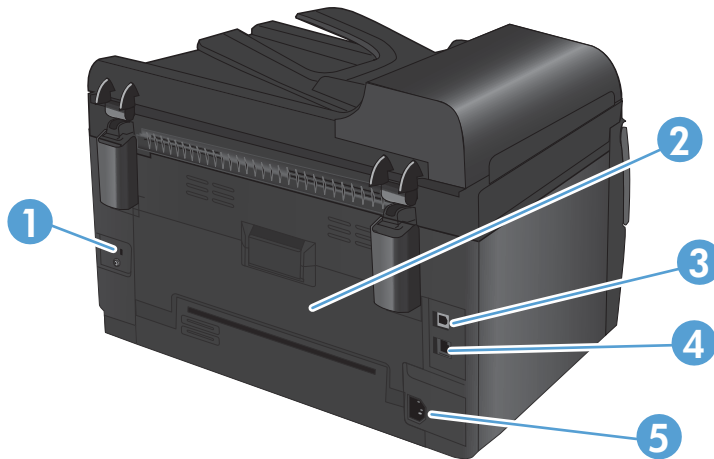

1	Security slot
2	Rear jam-access door
3	USB port
4	HP internal network port (network models only)
5	Power receptacle



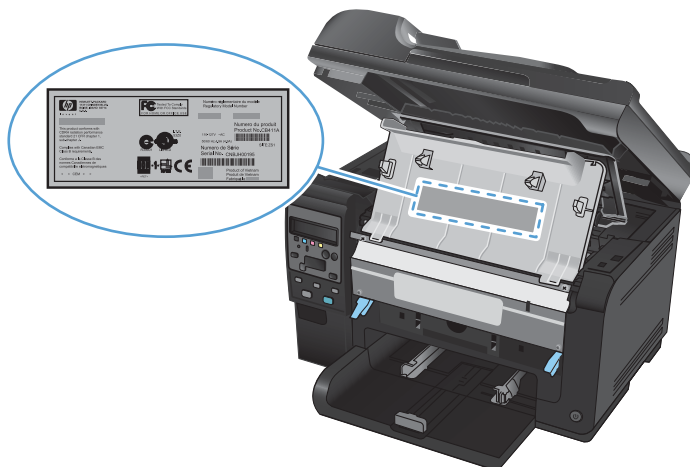

Serial number and model number location

The label that contains the product and serial numbers is on the inside of the front cover.

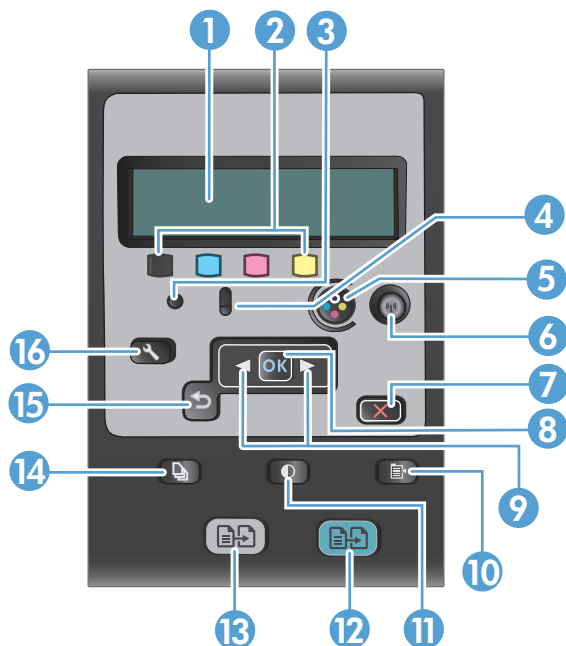

Control panel layout



1	Control panel display: The display provides information about the product. Use the menus on the display to establish product settings.
2	Toner level gauges. These gauges indicate the estimated amount of toner left in each cartridge.
3	Ready light. This light indicates that the product is ready or is processing a job.
4	Attention light. This light indicates a problem with the product. View the display for a message.
5	Cartridge button. When the print cartridge door is closed, press this button to rotate the print cartridge carousel.
6	Wireless button (network models only). Press the button to open the Wireless Menu . Press and hold the button to enable Wi-Fi Protected Setup (WPS) . The light indicates the state of the wireless connection.
7	Cancel button. Use the Cancel X button to cancel the current job.
8	OK button. Use the OK button to acknowledge a setting or to confirm an action to proceed.
9	Arrow buttons. Use the arrow buttons to navigate the menus and adjust certain settings.
10	Copy Menu button. Use the Copy Menu  button to open a copy settings menu.
11	Lighter/Darker button. Use the Lighter/Darker  button to control the brightness or darkness of a copy.
12	Color copy button. Use the Color button to start a color copy job.
13	Black and white copy button. Use the Black button to start a monochrome copy job.
14	# Copies button. Use the # Copies  button to set the number of copies that you want for the current copy job.
15	Back button. Use the Back  button to return to a previous menu, or to exit the menus and return to the Ready state.
16	Setup button. Use the Setup  button to open the main menu options.

2 Control panel menus

- [Setup menu](#)
- [Function specific menus](#)

Setup menu

To open this menu, press the Setup  button. The following sub menus are available:

- **Reports**
- **System Setup**
- **Service**
- **Network Setup**

Reports menu

First level
Demo Page
Menu Structure
Config Report
Supplies Status
Network Summary (network models only)
Usage Page
PCL Font List
PS Font List
PCL6 Font List
Color Usage Log
Service Page
Diagnostics Page
Print Quality

System Setup menu

In the following table, items that have an asterisk (*) indicate the factory default setting.

First level	Second level	Third level	Values
Language			Lists available control-panel display languages.

First level	Second level	Third level	Values	
Paper Setup	Def. Paper Size		Letter	
			A4	
			Legal	
	Def. Paper Type		Lists available media types.	
	Tray 1	Paper Type	Lists available media types.	
		Paper Size	Lists available media sizes.	
Paper Out Action		Wait Forever*		
		Cancel		
		Override		
Print Quality	Calibrate Color		Calibrate Now	
			After Power On	
Energy Settings	Sleep Delay		Off	
			1 Minute	
			15 Minutes*	
			30 Minutes	
			1 Hour	
		2 Hours		
		Auto Power Down	Auto-Off Delay	Never
				30 Minutes*
				1 Hour
				2 Hours
			4 Hours	
			8 Hours	
			24 Hours	
		Wake Events	USB Job	
			LAN Job	
			Wireless Job	
			Button Press	

First level	Second level	Third level	Values	
Supply Settings	Black Cartridge	Very Low Setting	Stop Prompt Continue*	
		Low Threshold	(Range of 1-100)	
	Color Cartridges	Very Low Setting	Stop Prompt Continue Print Black*	
			Low Threshold	Cyan (Range of 1-100) Magenta (Range of 1-100) Yellow (Range of 1-100)
		Imaging Drum	Very Low Setting	Stop* Prompt Continue
			Low Threshold	(Range of 1-100)
		Store Usage Data	On Supply* Not On Supply	
	Courier Font		Regular* Dark	
	Color Copy		On* Off	

Service menu

In the following table, items that have an asterisk (*) indicate the factory default setting.

First level	Second level	Values
Cleaning Page		
Cleaning Mode		

First level	Second level	Values
USB Speed		High*
		Full
Less Paper Curl		On
		Off*
Archive Print		On
		Off*
Firmware Date		
Restore Defaults		

Network Setup menu (network models only)

In the following table, items that have an asterisk (*) indicate the factory default setting.

First level	Second level	Values
Wireless Menu	Wi-Fi Protected Setup	
	Run Network Test	
	Turn Wireless On/Off	On*
		Off
TCP/IP Config		Automatic*
		Manual
Auto Crossover		On*
		Off
Network Services	IPv4	On*
	IPv6	Off
Show IP Address		Yes
		No*
Link Speed		Automatic*
		10T Full
		10T Half
		100TX Full
		100TX Half
Restore Defaults		

Function specific menus

The product features a function-specific menu for copying. To open this menu, press the **Copy Menu**  button on the control panel.

Copy Menu

In the following table, items that have an asterisk (*) indicate the factory default setting.

First level	Second level	Values
# of copies		(Range of 1*-99)
ID Copy		
Reduce/Enlarge		Original=100%* Legal to Letter=78% Legal to A4=83% A4 to Letter=94% Letter to A4=97% Full Page=91% Fit to Page 2 pages per sheet 4 pages per sheet Custom: 25 to 400%
Light/Dark		(Slider with a range of 11 settings.)
Optimize		Auto* Mixed Picture Text
Paper	Paper Size Paper Type	Lists available media sizes. Lists available media types.
Multi-Page Copy		On Off*
Collation		On* Off
Tray Select		Auto Select* Tray 1
Two-Sided		1 to 1 sided* 1 to 2 sided

First level	Second level	Values	
Draft Mode		On	
		Off*	
Image Adjustment	Lightness	(Slider with a range of 11 settings.)	
	Contrast	(Slider with a range of 11 settings.)	
	Sharpen	(Slider with a range of 11 settings.)	
	Background	(Slider with a range of 11 settings.)	
	Color Balance	Red	(Slider with a range of 11 settings.)
		Green	(Slider with a range of 11 settings.)
		Blue	(Slider with a range of 11 settings.)
		Grayness	(Slider with a range of 11 settings.)
Set as New Defaults			
Restore Defaults			

3 Software for Windows

- [Supported operating systems for Windows](#)
- [Supported printer drivers for Windows](#)
- [Select the correct printer driver for Windows](#)
- [Change print job settings](#)
- [Change printer-driver settings for Windows](#)
- [Remove software for Windows](#)
- [Supported utilities for Windows](#)
- [Software for other operating systems](#)

Supported operating systems for Windows

The product comes with software for the following Windows® operating systems:

- Windows 7 (32-bit and 64-bit)
- Windows Vista (32-bit and 64-bit)
- Windows XP (32-bit, Service Pack 2)
- Windows Server 2003 (32-bit, Service Pack 3)
- Windows Server 2008 (32-bit and 64-bit)

Supported printer drivers for Windows

The product comes with software for Windows that allows the computer to communicate with the product. This software is called a printer driver. Printer drivers provide access to product features, such as printing on custom-sized paper, resizing documents, and inserting watermarks.

 **NOTE:** The most recent drivers are available at www.hp.com/support/LJColorMFP175.

Select the correct printer driver for Windows

Printer drivers provide access to the product features and allow the computer to communicate with the product (using a printer language). Check the installation notes and readme files on the product CD for additional software and languages.

HP PCL 6 driver description

- Installs from the Add Printer wizard
- Provided as the default driver
- Recommended for printing in all supported Windows environments
- Provides the overall best speed, print quality, and product-feature support for most users
- Developed to align with the Windows Graphic Device Interface (GDI) for the best speed in Windows environments
- Might not be fully compatible with third-party and custom software programs that are based on PCL 5

HP UPD PS driver description

- Available for download from the Web at www.hp.com/support/LJColorMFP175
- Recommended for printing with Adobe® software programs or with other highly graphics-intensive software programs
- Provides support for printing from postscript emulation needs, or for postscript flash font support

HP UPD PCL 5 driver description

- Available for download from the Web at www.hp.com/support/LJColorMFPM175
- Compatible with previous PCL versions and older HP LaserJet products
- The best choice for printing from third-party or custom software programs
- Designed for use in corporate Windows environments to provide a single driver for use with multiple printer models
- Preferred when printing to multiple printer models from a mobile Windows computer

Change print job settings

Tool for changing the settings	Method for changing the settings	Duration of changes	Hierarchy of changes
Software program settings	On the File menu in the software program, click Page Setup or a similar command.	These settings are in effect for the current print job only.	Settings changed here override settings changed anywhere else.
Printer Properties in the software program	<p>The steps vary for each software program. This procedure is most common.</p> <ol style="list-style-type: none">1. On the File menu in the software program, click Print.2. Select the product, and then click Properties or Preferences.3. Change the settings on any of the tabs.	These settings are in effect for the current session of the software program.	Settings changed here override default printer driver settings and default product settings.
Default printer driver settings	<ol style="list-style-type: none">1. Open the list of printers on your computer, and select this product. NOTE: This step varies for each operating system.2. Click Printer, and then click Printing Preferences.3. Change the settings on any of the tabs.	<p>These settings remain in effect until you change them again.</p> <p>NOTE: This method changes the default settings for the printer driver for all software programs.</p>	You can override these settings by changing settings in the software program.
Default product settings	Change product settings on the control panel, or in the product management software that came with your product.	These settings remain in effect until you change them again.	You can override these settings by making changes with any other tool.

Change printer-driver settings for Windows

Change the settings for all print jobs until the software program is closed

1. On the **File** menu in the software program, click **Print**.
2. Select the driver, and then click **Properties** or **Preferences**.

The steps can vary; this procedure is most common.

Change the default settings for all print jobs

1. **Windows XP, Windows Server 2003, and Windows Server 2008 (using the default Start menu view):** Click **Start**, and then click **Printers and Faxes**.
Windows XP, Windows Server 2003, and Windows Server 2008 (using the Classic Start menu view): Click **Start**, click **Settings**, and then click **Printers**.
Windows Vista: Click **Start**, click **Control Panel**, and then in the category for **Hardware and Sound** click **Printer**.
Windows 7: Click **Start**, and then click **Devices and Printers**.
2. Right-click the driver icon, and then select **Printing Preferences**.

Change the product configuration settings

1. **Windows XP, Windows Server 2003, and Windows Server 2008 (using the default Start menu view):** Click **Start**, and then click **Printers and Faxes**.
Windows XP, Windows Server 2003, and Windows Server 2008 (using the Classic Start menu view): Click **Start**, click **Settings**, and then click **Printers**.
Windows Vista: Click **Start**, click **Control Panel**, and then in the category for **Hardware and Sound** click **Printer**.
Windows 7: Click **Start**, and then click **Devices and Printers**.
2. Right-click the driver icon, and then select **Properties** or **Printer properties**.
3. Click the **Device Settings** tab.

Remove software for Windows

Windows XP

1. Click **Start**, and then click **Programs**.
2. Click **HP**, and then click the product name.
3. Click **Uninstall**, and then follow the onscreen instructions to remove the software.

Windows Vista and Windows 7

1. Click **Start**, and then click **All Programs**.
2. Click **HP**, and then click the product name.
3. Click **Uninstall**, and then follow the onscreen instructions to remove the software.

Supported utilities for Windows

- HP Web Jetadmin

Other Windows components and utilities

- Software installer — automates the printing system installation
- Online Web registration
- HP LaserJet Scan

Software for other operating systems

OS	Software
UNIX	For HP-UX and Solaris networks, go to www.hp.com/support/net_printing to download the HP Jetdirect printer installer for UNIX.
Linux	For information, go to www.hp.com/go/linuxprinting .

4 Use the product with Mac

- [Software for Mac](#)
- [Print with Mac](#)
- [Scan with Mac](#)
- [Solve problems with Mac](#)

Software for Mac

Supported operating systems for Mac

The product supports the following Mac operating systems:

- Mac OS X 10.5 and 10.6

 **NOTE:** For Mac OS X 10.5 and later, PPC and Intel® Core™ Processor Macs are supported. For Mac OS X 10.6, Intel Core Processor Macs are supported.

Supported printer drivers for Mac

The HP LaserJet software installer provides PostScript® Printer Description (PPD) files, and Printer Dialog Extensions (PDEs) for use with Mac OS X computers. The HP printer PPD and PDE files, in combination with the built-in Apple PostScript printer drivers, provide full printing functionality and access to specific HP printer features.

Install software for Mac operating systems

Install software for Mac computers connected directly to the product

This product supports a USB 2.0 connection. Use an A-to-B type USB cable. HP recommends using a cable that is no longer than 2 m (6.5 ft).

1. Connect the USB cable to the product and the computer.

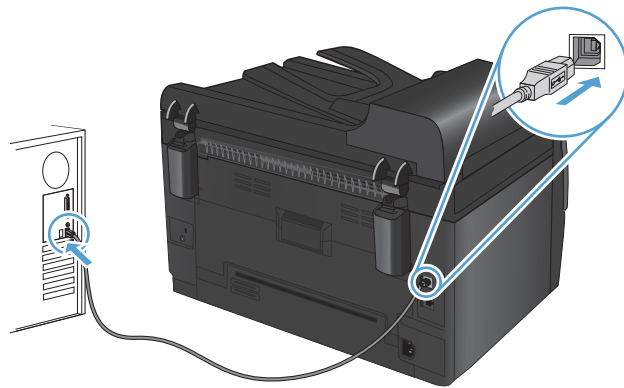

2. Install the software from the CD.
3. Click HP Installer icon, and follow the onscreen instructions.
4. On the Congratulations screen, click the **OK** button.
5. Print a page from any program to make sure that the printing software is correctly installed.

Install software for Mac computers on a wired network

Configure the IP address

The product IP address can be set manually, or it can be configured automatically via DHCP, BootP, or AutoIP.

Manual configuration

Only the IPv4 protocol can be configured manually.

1. On the control panel, press the Setup  button.
2. Use the arrow buttons to select **Network Setup**, and then press the **OK** button.
3. Use the arrow buttons to select **TCP/IP Config**, and then press the **OK** button.
4. Use the arrow buttons to select **Manual**, and then press the **OK** button.
5. Use the arrow buttons to set the IP address, and then press the **OK** button.
6. If the IP address is incorrect, use the arrow buttons to select **No**, and then press the **OK** button. Repeat step 5 with the correct IP address, and then repeat step 5 for the subnet mask and default gateway settings.

Automatic configuration

1. On the control panel, press the Setup  button.
2. Use the arrow buttons to select **Network Setup**, and then press the **OK** button.
3. Use the arrow buttons to select **TCP/IP Config**, and then press the **OK** button.
4. Use the arrow buttons to select **Automatic**, and then press the **OK** button.

It may take several minutes before the automatic IP address is ready for use.

 **NOTE:** If you want to disable or enable specific automatic IP modes (such as BOOTP, DHCP, or AutoIP), these settings can be changed by using the HP Utility.

Install the software

1. Quit all programs on the computer.
2. Install the software from the CD.
3. Click the HP Installer icon, and follow the onscreen instructions.
4. On the Congratulations screen, click the **OK** button.
5. Print a page from any program to make sure that the printing software is correctly installed.

Install software for Mac computers on a wireless network

Before installing the product software and setting the product to connect to a wireless network, make sure that the product is not connected to the network using a network cable.

Connect the product to a wireless network using WPS

If your wireless router supports Wi-Fi Protected Setup (WPS), this is the simplest way to set up the product on a wireless network.

1. Press the WPS button on your wireless router.
2. Press and hold the Wireless  button on the product control panel for two seconds. Release the button when the wireless light starts blinking.
3. Wait up to two minutes while the product establishes a network connection with the wireless router.

 **NOTE:** If this method is not successful, try using the wireless network using USB cable method.

Connect the product to a wireless network using a USB cable

If your wireless router does not support WiFi-Protected Setup (WPS), use this method to set up the product on a wireless network. Using a USB cable to transfer settings makes setting up a wireless connection easier. After the setup is complete, you can disconnect the USB cable and use the wireless connection.

1. Insert the software CD into the computer CD tray.
2. Follow the on-screen instructions. When prompted, select the **Connect through a wireless network** option. Connect the USB cable to the product when prompted.

△ **CAUTION:** Do not connect the USB cable until the installation program prompts you.

3. When the installation is complete, print a configuration page to make sure that the product has a SSID name.
4. When installation is complete, disconnect the USB cable.

Remove software from Mac operating systems

You must have administrator rights to remove the software.

1. Disconnect the product from the computer.
2. Open **Applications**.
3. Select **Hewlett Packard**.
4. Select **HP Uninstaller**.
5. Select the product from the list of devices, and then click the **Uninstall** button.
6. After the software is uninstalled, restart the computer and empty the Trash.

Priority for print settings for Mac

Changes to print settings are prioritized depending on where the changes are made:



NOTE: The names of commands and dialog boxes might vary depending on your software program.

- **Page Setup dialog box:** Click **Page Setup** or a similar command on the **File** menu of the program you are working in to open this dialog box. Settings changed here might override settings changed anywhere else.
- **Print dialog box:** Click **Print**, **Print Setup**, or a similar command on the **File** menu of the program you are working in to open this dialog box. Settings changed in the **Print** dialog box have a lower priority and do *not* override changes made in the **Page Setup** dialog box.
- **Default printer driver settings:** The default printer driver settings determine the settings used in all print jobs, *unless* settings are changed in the **Page Setup**, **Print**, or **Printer Properties** dialog boxes.
- **Printer control panel settings:** Settings changed at the printer control panel have a lower priority than changes made anywhere else.

Change printer-driver settings for Mac

Change the settings for all print jobs until the software program is closed	Change the default settings for all print jobs	Change the product configuration settings
<ol style="list-style-type: none"> 1. On the File menu, click the Print button. 2. Change the settings that you want on the various menus. 	<ol style="list-style-type: none"> 1. On the File menu, click the Print button. 2. Change the settings that you want on the various menus. 3. On the Presets menu, click the Save As... option and type a name for the preset. <p>These settings are saved in the Presets menu. To use the new settings, you must select the saved preset option every time you open a program and print.</p>	<p>Mac OS X 10.5 and 10.6</p> <ol style="list-style-type: none"> 1. From the Apple menu , click the System Preferences menu and then click the Print & Fax icon. 2. Select the product in the left side of the window. 3. Click the Options & Supplies button. 4. Click the Driver tab. 5. Configure the installed options.

Software for Mac computers

Supported utilities for Mac (network models only)

HP Utility for Mac

Use the HP Utility to set up product features that are not available in the printer driver.

You can use the HP Utility when the product uses a universal serial bus (USB) cable or is connected to a TCP/IP-based network.

Open the HP Utility

▲ From the dock, click **HP Utility**.

-or-

From **Applications**, click **Hewlett Packard**, and then click **HP Utility**.

HP Utility features

Use the HP Utility software to perform the following tasks:

- Obtain information about supplies status.
- Obtain information about the product, such as the firmware version and the serial number.
- Print a configuration page.
- Configure the paper type and size for the tray.
- Transfer files and fonts from the computer to the product.
- Update the product firmware.
- Display the color usage page.

Print with Mac

Cancel a print job with Mac

1. If the print job is currently printing, cancel it by pressing the Cancel **X** button on the product control panel.

 **NOTE:** Pressing the Cancel **X** button clears the job that the product is currently processing. If more than one print job is waiting, pressing the Cancel **X** button clears the print job that currently appears on the product control panel.

2. You can also cancel a print job from a software program or a print queue.
 - **Software program:** Typically, a dialog box appears briefly on the computer screen, allowing you to cancel the print job.
 - **Mac print queue:** Open the print queue by double-clicking the product icon in the dock. Highlight the print job, and then click **Delete**.

Change the paper size and type with Mac

1. On the **File** menu in the software program, click the **Print** option.
2. In the **Copies & Pages** menu, click the **Page Setup** button.
3. Select a size from the **Paper Size** drop-down list, and then click the **OK** button.
4. Open the **Finishing** menu.
5. Select a type from the **Media-type** drop-down list.
6. Click the **Print** button.

Resize documents or print on a custom paper size with Mac

Mac OS X 10.5 and 10.6	<ol style="list-style-type: none">1. On the File menu, click the Print option.
Use one of these methods.	<ol style="list-style-type: none">2. Click the Page Setup button.3. Select the product, and then select the correct settings for the Paper Size and Orientation options.
	<ol style="list-style-type: none">1. On the File menu, click the Print option.2. Open the Paper Handling menu.3. In the Destination Paper Size area, click the Scale to fit paper size box, and then select the size from the drop-down list.

Create and use printing presets with Mac

Use printing presets to save the current printer driver settings for reuse.

Create a printing preset

1. On the **File** menu, click the **Print** option.
2. Select the driver.
3. Select the print settings that you want to save for reuse.
4. In the **Presets** menu, click the **Save As...** option, and type a name for the preset.
5. Click the **OK** button.

Use printing presets

1. On the **File** menu, click the **Print** option.
2. Select the driver.
3. In the **Presets** menu, select the printing preset.

 **NOTE:** To use printer-driver default settings, select the **standard** option.

Print a cover page with Mac

1. On the **File** menu, click the **Print** option.
2. Select the driver.
3. Open the **Cover Page** menu, and then select where to print the cover page. Click either the **Before Document** button or the **After Document** button.
4. In the **Cover Page Type** menu, select the message that you want to print on the cover page.

 **NOTE:** To print a blank cover page, select the **standard** option from the **Cover Page Type** menu.

Use watermarks with Mac

1. On the **File** menu, click the **Print** option.
2. Open the **Watermarks** menu.
3. From the **Mode** menu, select the type of watermark to use. Select the **Watermark** option to print a semi-transparent message. Select the **Overlay** option to print a message that is not transparent.
4. From the **Pages** menu, select whether to print the watermark on all pages or on the first page only.
5. From the **Text** menu, select one of the standard messages, or select the **Custom** option and type a new message in the box.
6. Select options for the remaining settings.

Print multiple pages on one sheet of paper with Mac

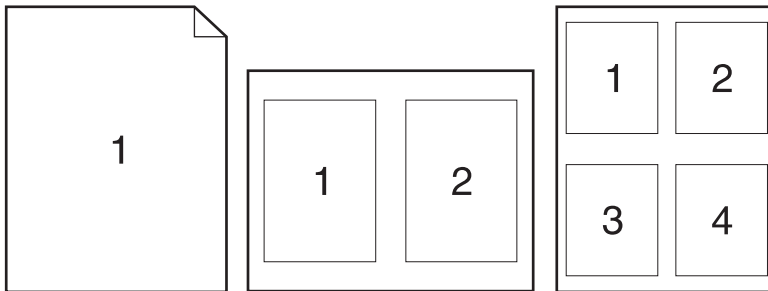

1. On the **File** menu, click the **Print** option.
2. Select the driver.
3. Open the **Layout** menu.
4. From the **Pages per Sheet** menu, select the number of pages that you want to print on each sheet (1, 2, 4, 6, 9, or 16).
5. In the **Layout Direction** area, select the order and placement of the pages on the sheet.
6. From the **Borders** menu, select the type of border to print around each page on the sheet.

Print on both sides of the page (duplex printing) with Mac

1. Insert enough paper into one of the trays to accommodate the print job.
2. On the **File** menu, click the **Print** option.
3. Open the **Copies & Pages** menu, and click the **Manual Duplex** tab or open the **Manual Duplex** menu.
4. Click the **Manual Duplex** box, and select a binding option.
5. Click the **Print** button.
6. Go to the product, and remove any blank paper that is in Tray 1.
7. Retrieve the printed stack from the output bin, rotate the stack 180 degrees, and then place it with the printed-side facing down in the input tray.
8. At the control panel, press the **OK** button.

Set the color options with Mac

Use the **Color Options** menu or the **Color/Quality Options** menu to control how colors are interpreted and printed from software programs.

1. On the **File** menu, click the **Print** option.
2. Select the driver.

3. Open the **Color Options** menu or the **Color/Quality Options** menu.
4. Open the **Advanced** menu, or select the appropriate tab.
5. Adjust the individual settings for text, graphics, and photographs.

Use the Services menu with Mac

If the product is connected to a network, use the **Services** menu to obtain product and supply-status information.

1. On the **File** menu, click the **Print** option.
2. Open the **Services** menu.
3. To perform a maintenance task, do the following:
 - a. Select the **Device Maintenance** tab.
 - b. Select a task from the drop-down list.
 - c. Click the **Launch** button.
4. To go to various support Web sites for this product, do the following:
 - a. Select the **Services on the Web** tab.
 - b. Select an option from the menu.
 - c. Click the **Go!** button.

Scan with Mac

Use the HP Scan software to scan images to a Mac computer.

1. Load the document onto the scanner glass or into the document feeder.
2. Open the **Applications** folder, and then click **Hewlett-Packard**. Double-click **HP Scan**.
3. Open the **HP Scan** menu and click **Preferences**. From the **Scanner** pop-up menu, select this product from the list, and click **Continue**.
4. To use the standard preset settings, which produce acceptable results for images and text, click the **Scan** button.

To use presets optimized for pictures or text documents, select a preset from the **Scanning Presets** pop-up menu. To adjust the settings, click the **Edit** button. When you are ready to scan, click the **Scan** button.

5. To scan more pages, load the next page and click **Scan**. Click **Append to List** to add the new pages to the current list. Repeat until you have scanned all the pages.
6. Click the **Save** button, and then browse to the folder on your computer where you want to save the file.

 **NOTE:** To print the scanned images now, click the **Print** button.

Solve problems with Mac

For information about solving problems with a Mac, see [Solve common Mac problems on page 166](#).

5 Connect the product

- [Supported network operating systems \(network models only\)](#)
- [Use HP Smart Install to connect to a computer, a wired network, or a wireless network](#)
- [Connect with USB by using the software CD-ROM](#)
- [Connect to a network by using the software CD-ROM \(network models only\)](#)

Supported network operating systems (network models only)

The product supports the following operating systems for wireless printing:

- Windows 7 (32-bit and 64-bit)
- Windows Vista (32-bit and 64-bit)
- Windows XP (32-bit, Service Pack 2)
- Windows Server 2003 (32-bit, Service Pack 3)
- Windows Server 2008 (32-bit and 64-bit)
- Mac OS X v10.5 and v10.6

Printer sharing disclaimer

HP does not support peer-to-peer networking, as the feature is a function of Microsoft operating systems and not of the HP printer drivers. Go to Microsoft at www.microsoft.com.

Use HP Smart Install to connect to a computer, a wired network, or a wireless network

 **NOTE:** This installation type is supported for Windows only.

The HP Smart Install allows you to install the product driver and software by connecting the product to a computer through a USB cable.

 **NOTE:** The installation CD is not required during an HP Smart Install. Do not insert the software installation CD into the computer CD drive.

1. Turn the product on.
2. Connect the USB cable.
3. The HP Smart Install program should start automatically. Follow the onscreen instructions to install the software.
 - If the HP Smart Install program does not start automatically, AutoPlay might be disabled on the computer. Browse the computer and double-click the HP Smart Install drive to run the program.
 - When the program prompts you to select a connections type, select the correct option.

Connect with USB by using the software CD-ROM

△ **CAUTION:** Do not connect the USB cable until the installation software prompts you to connect it.

This product supports a USB 2.0 connection. Use an A-to-B type USB cable. HP recommends using a cable that is no longer than 2 m (6.5 ft).

1. Quit all open programs on the computer.
2. Install the software from the CD, and follow the onscreen instructions.
3. When prompted, select the **Directly connect to this computer using a USB cable** option, and then click the **Next** button.
4. When the software prompts you, connect the USB cable to the product and the computer.

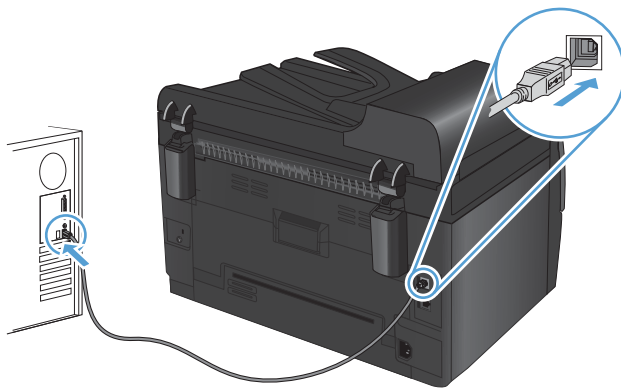

5. At the end of the installation, click the **Finish** button.
6. On the **More Options** screen, you can install more software, or click the **Finish** button.
7. Print a page from any program to make sure that the printing software is correctly installed.

Connect to a network by using the software CD-ROM (network models only)

The product can connect to wired or wireless networks.

 **NOTE:** You cannot connect to a wired and wireless network simultaneously. Wired connections take precedence.

Supported network protocols

Network models support the TCP/IP protocol, which is the most widely used and accepted networking protocol. Many networking services utilize this protocol. This product also supports IPv4 and IPv6. The following lists shows the networking services/protocols that are supported on the product.

- TCP/IP (IPv4 or IPv6)
- Port 9100
- LPR
- DHCP
- AutoIP
- SNMP
- Bonjour
- SLP
- WSD
- NBNS

Install the product on a wired network

Configure the IP address

The product IP address can be set manually, or it can be configured automatically via DHCP, BootP, or AutoIP.

Manual configuration

Only the IPv4 protocol can be configured manually.

1. On the control panel, press the Setup  button.
2. Use the arrow buttons to select **Network Setup**, and then press the **OK** button.
3. Use the arrow buttons to select **TCP/IP Config**, and then press the **OK** button.
4. Use the arrow buttons to select **Manual**, and then press the **OK** button.
5. Use the arrow buttons to set the IP address, and then press the **OK** button.
6. If the IP address is incorrect, use the arrow buttons to select **No**, and then press the **OK** button. Repeat step 5 with the correct IP address, and then repeat step 5 for the subnet mask and default gateway settings.

Automatic configuration

1. On the control panel, press the Setup  button.
2. Use the arrow buttons to select **Network Setup**, and then press the **OK** button.
3. Use the arrow buttons to select **TCP/IP Config**, and then press the **OK** button.
4. Use the arrow buttons to select **Automatic**, and then press the **OK** button.

It may take several minutes before the automatic IP address is ready for use.

 **NOTE:** If you want to disable or enable specific automatic IP modes (such as BOOTP, DHCP, or AutoIP), these settings can be changed by using the HP Device Toolbox.

Install the software

1. Quit all programs on the computer.
2. Install the software from the CD.
3. Follow the onscreen instructions.
4. When prompted, select the **Connect through a wired network** option, and then click the **Next** button.
5. From the list of available printers, select the printer that has the correct IP address.
6. Click the **Finish** button.
7. On the **More Options** screen, you can install more software, or click the **Finish** button.
8. Print a page from any program to make sure that the printing software is correctly installed.

Install the product on a wireless network

Before installing the product software, make sure the product is not connected to the network using a network cable.

If your wireless router does not support Wi-Fi Protected Setup (WPS), obtain the wireless router network settings from your system administrator, or complete the following tasks:

- Obtain the wireless network name or service set identifier (SSID).
- Determine the security password or encryption key for the wireless network.

Connect the product to a wireless network using WPS

If your wireless router supports Wi-Fi Protected Setup (WPS), this is the simplest way to set up the product on a wireless network.

1. Press the WPS button on your wireless router.
2. Press and hold the Wireless  button on the product control panel for two seconds. Release the button when the wireless light starts blinking.
3. Wait up to two minutes while the product establishes a network connection with the wireless router.



NOTE: If this method is not successful, try using the wireless network setup using the USB cable method.

Connect the product to a wireless network using a USB cable

If your wireless router does not support WiFi-Protected Setup (WPS), use this method to set up the product on a wireless network. Using a USB cable to transfer settings makes setting up a wireless connection easier. After the setup is complete, you can disconnect the USB cable and use the wireless connection.

1. Insert the software CD into the computer CD tray.
2. Follow the on-screen instructions. When prompted, select the **Connect through a wireless network** option. Connect the USB cable to the product when prompted.

△ **CAUTION:** Do not connect the USB cable until the installation program prompts you.

3. When the installation is complete, print a configuration page to make sure that the product has a SSID name.
4. When installation is complete, disconnect the USB cable.

Install the software for a wireless product currently on the network

If the product already has an IP address on a wireless network and you want to install product software on a computer, complete the following steps.

1. From the product control panel, print a configuration page to obtain the product IP address.
2. Install the software from the CD.
3. Follow the on-screen instructions.
4. When prompted, select the **Connect through a wireless network** option, and then click the **Next** button.
5. From the list of available printers, select the printer that has the correct IP address.

Disconnect from the wireless network

If you want to disconnect the product from a wireless network, you can turn off the wireless unit in the product.

1. At the product control panel, press and release the Wireless  button.
2. To confirm that the wireless unit is turned off, print a configuration page and then verify that the status is specified as disabled on the configuration page.

Reduce interference on a wireless network

The following tips can reduce interference in a wireless network:

- Keep the wireless devices away from large metal objects, such as filing cabinets, and other electromagnetic devices, such as microwaves and cordless telephones. These objects can disrupt radio signals.
- Keep the wireless devices away from large masonry structures and other building structures. These objects can absorb radio waves and lower signal strength.
- Position the wireless router in a central location in line of sight with the wireless products on the network.

Advanced wireless setup

Wireless communication modes

You can use one of two wireless communication modes: infrastructure or ad-hoc.

Infrastructure wireless network (recommended)

The product communicates with other devices on the network through a wireless router.

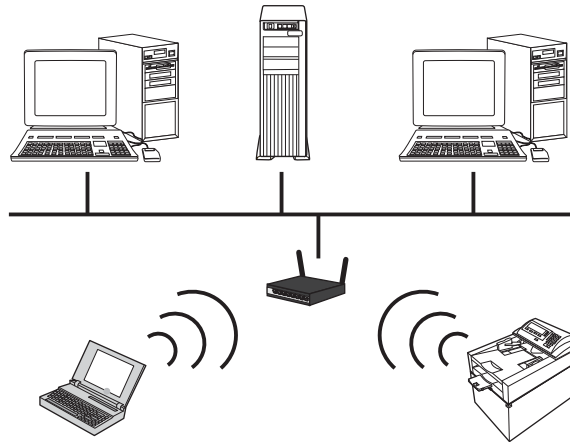

Ad-hoc wireless network

The product communicates directly with other wireless devices without using a wireless router.

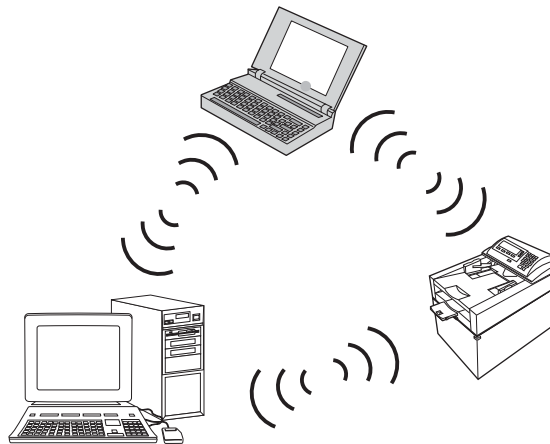

All devices on the ad hoc network must have the following:

- 802.11b/g compatibility
 - The same SSID
 - The same subnet and channel
 - The same 802.11b/g security settings
-

Wireless security

To make your wireless network easy to distinguish from other wireless networks, use a unique network name (SSID) for your wireless router. Your wireless router might have a default network

name, which is typically the manufacturer's name. For information on how to change the network name, see the documentation that came with the wireless router.

To prevent other users from accessing your network, turn on WPA or WEP data encryption.

- **Wired Equivalent Privacy (WEP):** WEP is the original native security mechanism in the 802.11 standard. You create a unique key containing hexadecimal or alphanumeric characters, which other users must provide before they can access your network.
- **Wi-Fi Protected Access (WPA):** WPA uses the temporal key integrity protocol (TKIP) for encryption and employs 802.1X authentication. It addresses all known weaknesses of WEP. You create a unique passphrase containing a combination of letters and numbers, which other users must provide before they can access your network.
- **WPA2** provides the advanced encryption standard (AES), and is an improvement over WPA.

Install the product on an ad-hoc wireless network

You can connect the product wirelessly to a computer through a peer-to-peer (ad-hoc) installation.

 **NOTE:** To accomplish this task, you must *temporarily* connect the product to the network by using a network cable.

1. Connect the network cable to the product and to the network.
2. Wait for 60 seconds before continuing. During this time, the network recognizes the product and assigns an IP address or host name for the product.
3. Print a configuration page and a supplies status page.
4. Find the IP address on the configuration page.
5. Open a Web browser, and type the IP address into the address line. The HP Device Toolbox opens.
6. Click the **Networking** tab, and select the **Wireless Configuration** link from the left pane.
7. Select the option to enable wireless networking, and then disconnect the network cable.
8. In the **Configuration Method** area, select the **Create a new Ad hoc wireless network (peer-to-peer)** option.
9. Provide a unique network name, select a channel, and select the type of security to use.
10. Click the **Apply** button.

Configure the network product

View or change network settings

Use the HP Device Toolbox to view or change IP configuration settings.

1. Print a configuration page, and locate the IP address.
 - If you are using IPv4, the IP address contains only digits. It has this format:
xxx . xxx . xxx . xxx
 - If you are using IPv6, the IP address is a hexadecimal combination of characters and digits. It has a format similar to this:
xxxx : : xxxx : xxxx : xxxx : xxxx
2. Open the HP Device Toolbox by clicking the **Start** button, clicking the **Programs** or **All Programs** group, clicking **HP**, clicking the product group, and then clicking **HP Product Settings**.
3. Click the **Networking** tab to obtain network information. You can change settings as needed.

6 Paper and print media

- [Understand paper use](#)
- [Change the printer driver to match the paper type and size](#)
- [Supported paper sizes](#)
- [Supported paper types](#)
- [Load paper trays](#)

Understand paper use

This product supports a variety of paper and other print media in accordance with the guidelines in this user guide. Paper or print media that does not meet these guidelines might cause poor print quality, increased jams, and premature wear on the product.

For best results, use only HP-brand paper and print media designed for laser printers or multiuse. Do not use paper or print media made for inkjet printers. Hewlett-Packard Company cannot recommend the use of other brands of media because HP cannot control their quality.

It is possible for paper to meet all of the guidelines in this user guide and still not produce satisfactory results. This might be the result of improper handling, unacceptable temperature and/or humidity levels, or other variables over which Hewlett-Packard has no control.

- △ **CAUTION:** Using paper or print media that does not meet Hewlett-Packard's specifications might cause problems for the product, requiring repair. This repair is not covered by the Hewlett-Packard warranty or service agreements.

Special paper guidelines

This product supports printing on special media. Use the following guidelines to obtain satisfactory results. When using special paper or print media, be sure to set the type and size in the printer driver to obtain the best results.

- △ **CAUTION:** HP LaserJet products use fusers to bond dry toner particles to the paper in very precise dots. HP laser paper is designed to withstand this extreme heat. Using inkjet paper could damage the product.

Media type	Do	Do not
Envelopes	<ul style="list-style-type: none">• Store envelopes flat.• Use envelopes where the seam extends all the way to the corner of the envelope.• Use peel-off adhesive strips that are approved for use in laser printers.	<ul style="list-style-type: none">• Do not use envelopes that are wrinkled, nicked, stuck together, or otherwise damaged.• Do not use envelopes that have clasps, snaps, windows, or coated linings.• Do not use self-stick adhesives or other synthetic materials.
Labels	<ul style="list-style-type: none">• Use only labels that have no exposed backing between them.• Use labels that lie flat.• Use only full sheets of labels.	<ul style="list-style-type: none">• Do not use labels that have wrinkles or bubbles, or are damaged.• Do not print partial sheets of labels.
Transparencies	<ul style="list-style-type: none">• Use only transparencies that are approved for use in color laser printers.• Place transparencies on a flat surface after removing them from the product.	<ul style="list-style-type: none">• Do not use transparent print media not approved for laser printers.
Letterhead or preprinted forms	<ul style="list-style-type: none">• Use only letterhead or forms approved for use in laser printers.	<ul style="list-style-type: none">• Do not use raised or metallic letterhead.

Media type	Do	Do not
Heavy paper	<ul style="list-style-type: none">• Use only heavy paper that is approved for use in laser printers and meets the weight specifications for this product.	<ul style="list-style-type: none">• Do not use paper that is heavier than the recommended media specification for this product unless it is HP paper that has been approved for use in this product.
Glossy or coated paper	<ul style="list-style-type: none">• Use only glossy or coated paper that is approved for use in laser printers.	<ul style="list-style-type: none">• Do not use glossy or coated paper designed for use in inkjet products.

Change the printer driver to match the paper type and size

 **NOTE:** If you change the page settings in the software program, those settings override any settings in the printer driver.

1. On the **File** menu in the software program, click **Print**.
2. Select the product, and then click the **Properties** or **Preferences** button.
3. Click the **Paper/Quality** tab.
4. Select a size from the **Size is** drop-down list.
5. Select a paper type from the **Type is** drop-down list.
6. Click the **OK** button.

Supported paper sizes

This product supports various paper sizes, and it adapts to various media.



NOTE: To obtain best print results, select the appropriate paper size and type in your print driver before printing.

Table 6-1 Supported paper and print media sizes

Size	Dimensions
Letter	216 x 279 mm (8.5 x 11 in)
Legal	216 x 356 mm (8.5 x 14 in)
A4	210 x 297 mm (8.27 x 11.69 in)
Executive	184 x 267 mm (7.25 x 10.5 in)
8.5 x 13	216 x 330 mm (8.5 x 13 in)
4 x 6	101.6 x 152.4 mm (4 x 6 in)
10 x 15 cm	101.6 x 152.4 mm (4 x 6 in)
5 x 8	127 x 203 mm (5 x 8 in)
RA4	215 x 305 mm (8.46 x 12.01 in)
A5	148 x 210 mm (5.83 x 8.27 in)
A6	105 x 148 mm (4.13 x 5.83 in)
B5 (JIS)	182 x 257 mm (7.17 x 10.12 in)
16k	184 x 260 mm (7.24 x 10.23 in) 195 x 270 mm (7.68 x 10.62 in) 197 x 273 mm (7.75 x 10.75 in)
Custom	Minimum: 76 x 127 mm (3 x 5 in) Maximum: 216 x 356 mm (8.5 x 14.0 in) NOTE: When defining custom sizes using the printer driver, always specify the short edge of the page as the width and the long edge as the length.

Table 6-2 Supported envelopes and postcards

Size	Dimensions
Envelope #10	105 x 241 mm (4.13 x 9.49 in)
Envelope DL	110 x 220 mm (4.33 x 8.66 in)
Envelope C5	162 x 229 mm (6.93 x 9.84 in)
Envelope B5	176 x 250 mm (6.7 x 9.8 in)
Envelope Monarch	98 x 191 mm (3.9 x 7.5 in)
Japanese Postcard	100 x 148 mm (3.93 x 5.82 in)
Postcard (JIS)	

Table 6-2 Supported envelopes and postcards (continued)

Size	Dimensions
Double Japan Postcard Rotated	148 x 200 mm (5.83 x 7.87 in)
Double Postcard (JIS)	
Custom	Minimum: 76 x 127 mm (3 x 5 in) Maximum: 216 x 356 mm (8.5 x 14.0 in)

NOTE: When defining custom sizes using the printer driver, always specify the short edge of the page as the width and the long edge as the length.

Supported paper types

For a complete list of specific HP-brand paper that this product supports, go to www.hp.com/support/LJColorMFPM175.

- Everyday
 - Plain
 - Light
 - Bond
 - Recycled
- Presentation
 - Matte paper
 - Glossy paper
 - Heavy paper
 - Heavy glossy paper
- Brochure
 - Matte paper
 - Glossy paper
 - Tri-fold paper
 - Extra heavy paper
 - Extra heavy glossy paper
- Photo/Cover
 - Matte cover paper
 - Matte photo paper
 - Photo glossy paper
 - Glossy cards
- Other
 - Color laser transparency
 - Labels
 - Letterhead
 - Envelope
 - Heavy envelope
 - Preprinted
 - Prepunched

- Colored
- Rough
- Heavy rough
- HP Tough paper

Load paper trays

Load the input tray

 **NOTE:** When you add new paper make sure that you remove all of the paper from the input tray and straighten the stack of new paper. Do not fan the paper. This reduces jams by preventing multiple sheets of paper from feeding through the product at one time.

NOTE: When printing on small sizes or custom paper, load the short edge (width) into the product first.

1. Load the paper face-up, top forward in the input tray.



2. Adjust the guides until they are snug against the paper.



Tray capacity

Tray or bin	Paper type	Specifications	Capacity
Input tray	Paper	60-220 g/m ² (16-59 lb) Print quality is assured for HP media.	150 sheets of 75 g/m ² (20 lb)
	Envelopes	60-90 g/m ² (16-24 lb)	Up to 10 envelopes
	Transparencies	0.12-0.13 mm (0.0047-.0051 in)	Up to 50 transparencies
	Postcards	135-176 g/m ² (36-47 lb)	
	Glossy	130-220 g/m ² ()	

Paper orientation for loading trays

If you are using paper that requires a specific orientation, load it according to the information in the following table.

Paper type	How to load paper
Preprinted or letterhead	<ul style="list-style-type: none">• Face up• Top edge leading into the product
Prepunched	<ul style="list-style-type: none">• Face up• Holes toward the left side of the product
Envelope	<ul style="list-style-type: none">• Face up• Right short edge leading into the product

7 Print cartridges and imaging drum

- [Print cartridge and imaging drum features](#)
- [Supplies views](#)
- [Manage print cartridges and the imaging drum](#)
- [Solve problems with print cartridges or the imaging drum](#)

Print cartridge and imaging drum features

Feature	Description
Part numbers	<ul style="list-style-type: none">• Black print cartridge: CE310A• Cyan print cartridge: CE311A• Yellow print cartridge: CE312A• Magenta print cartridge: CE313A• Imaging drum: CE314A <p>NOTE: The selectibility number for all print cartridges and the imaging drum is 126A.</p>
Accessibility	<ul style="list-style-type: none">• Print cartridges and the imaging drum can be installed and removed by using one hand.
Environmental features	<ul style="list-style-type: none">• Recycle print cartridges by using the HP Planet Partners return and recycling program.

For more information about supplies, go to www.hp.com/go/learnaboutsupplies.

Supplies views

Print cartridge views

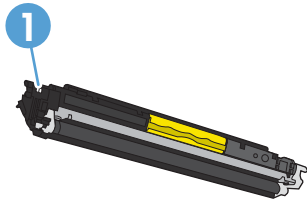

1 | Print cartridge memory tag

Imaging drum views

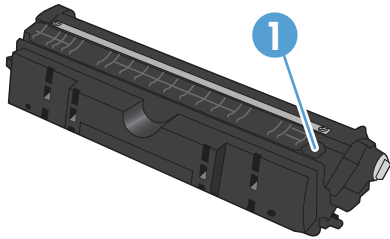

1 | Imaging drum memory tag

Manage print cartridges and the imaging drum

Correctly using, storing, and monitoring the print cartridge and imaging drum can help ensure high-quality print output.

Change settings for print cartridges or the imaging drum

Print when a print cartridge or imaging drum is at estimated end of life

<Supply> Low message—where <Supply> is the color print cartridge or the imaging drum: The product indicates when a supply level is low. Actual life remaining may vary. Consider having a replacement available to install when print quality is no longer acceptable. The supply does not need to be replaced now.

<Supply> Very Low message—where <Supply> is either the color print cartridge or imaging drum or a combination of multiple print cartridges and/or the imaging drum: The product indicates when a supply level is very low. Actual supply life remaining may vary. Consider having a replacement available to install when print quality is no longer acceptable. The supply does not need to be replaced now unless the print quality is no longer acceptable.

Once an HP print cartridge has reached “very low”, HP’s Premium Protection Warranty on that supply has ended.

The imaging drum installed in this product is covered by the product warranty. Replacement imaging drums have a one-year limited warranty from the date of installation. The imaging drum installation date displays on the supplies status page.

Change the Very Low settings from the control panel

You can change the setting at any time, and you do not have to reset it when you install a new print cartridge or imaging drum.

1. On the control panel, press the Setup  button.
2. Use the arrow buttons to select the **System Setup** menu, and then press the **OK** button.
3. Use the arrow buttons to select the **Supply Settings** menu, and then press the **OK** button.
4. Use the arrow buttons to select the **Black Cartridge** menu, the **Color Cartridges** menu, or the **Imaging Drum** menu, and then press the **OK** button.
5. Use the arrow buttons to select the **Very Low Setting** menu, and then press the **OK** button.
6. Select one of the following options.
 - Select the **Continue** option to set the product to alert you that the print cartridge or imaging drum is very low, but to continue printing.
 - Select the **Stop** option to set the product to stop printing until you replace the print cartridge or imaging drum.
 - Select the **Prompt** option to set the product to stop printing and prompt you to replace the print cartridge or imaging drum. You can acknowledge the prompt and continue printing.
 - On the **Color Cartridges** menu only, select **Print Black** to alert you when the print cartridge is very low, but to continue printing in black only.



Replacement instructions

Replace the print cartridges

When a print cartridge approaches the estimated end of its useful life, you can continue printing with the current print cartridge until it no longer yields acceptable print quality.

Once an HP print cartridge has reached “very low”, the HP Premium Protection Warranty on that supply has ended. All print defects or print cartridge failures incurred when an HP supply is used in continue at very low mode will not be considered to be defects in materials or workmanship in the supply under the HP Print Cartridge Warranty Statement.

1. Some error messages or status messages cause the product to rotate the print cartridge carousel to the affected cartridge automatically. If the print cartridge that needs to be replaced is not in the correct position, press the Cartridge  button to rotate the print cartridge carousel to the cartridge color that you want to replace.

NOTE: All doors must be closed when pressing the Cartridge  button. Also, the imaging drum must be installed for the Cartridge  button to work.

NOTE: Wait until the **Rotating** message and the rotation sounds stop before opening the print cartridge door.

2. Open the print cartridge door.



3. Grasp the old print cartridge by the center handle and remove it.



4. Remove the new print cartridge from the packaging. Place the used print cartridge in the bag and box for recycling.

CAUTION: To prevent damage to the print cartridge, hold the print cartridge at each end. Do not touch the roller on the print cartridge.

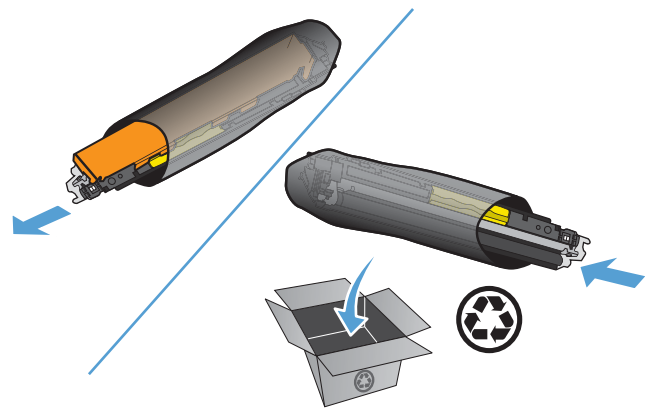

5. Grasp both sides of the print cartridge and gently rock the print cartridge to distribute the toner evenly inside the print cartridge.

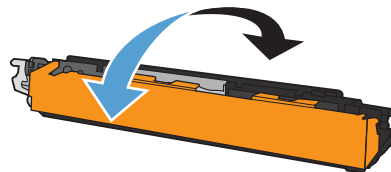

6. Grasp the print cartridge by the center handle and remove the protective plastic shield.

NOTE: Do not touch the print cartridge roller. Fingerprints on the roller can cause print-quality problems.

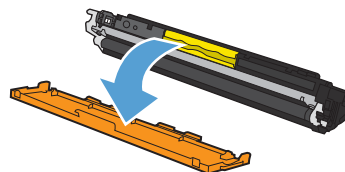

7. Remove the sealing tape from the print cartridge. Place the tape in the print-cartridge box to return for recycling.

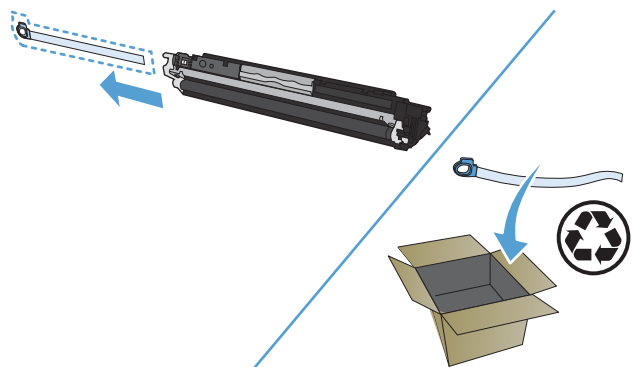

8. Grasp the print cartridge by the center handle and insert into the product.

NOTE: Compare the color label on the print cartridge to the color label in the carousel slot to make sure the print cartridge color matches the carousel position.

CAUTION: If toner gets on your clothing, wipe it off with a dry cloth and wash the clothing in cold water. *Hot water sets toner into the fabric.*

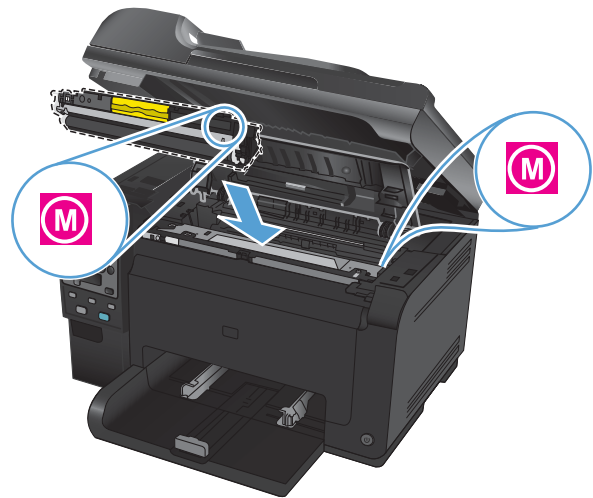

9. Close the print cartridge door.

NOTE: After closing the print cartridge door, the control panel shows the **Calibrating...** message. Allow a few minutes for the product to calibrate.

NOTE: If replacing another print cartridge, you must close the print cartridge door before pressing the Cartridge button of the next print cartridge.

You do not need to wait for the product to calibrate when replacing the second print cartridge. Instead, press the Cartridge button to rotate the carousel into position. After you have replaced the print cartridges, the product calibrates.



 **NOTE:** When printing, if you receive the status alert message **Wrong Cartridge in <Color> Slot**, remove the print cartridge from the specified slot and compare the color label on the print cartridge to the color label in the slot to determine the correct print cartridge for the slot.

Replace the imaging drum

 **NOTE:** The imaging drum installed in this product is covered by the product warranty. Replacement imaging drums have a one-year limited warranty from the date of installation. The imaging drum installation date displays on the supplies status page. The HP Premium Protection Warranty applies only to the print cartridges for the product.

1. Open the print cartridge door.



2. Open the front cover.



3. Lift the two levers that hold the imaging drum.



4. Remove the old imaging drum.



5. Remove the new imaging drum from the packaging. Place the used imaging drum in the bag and box for recycling.

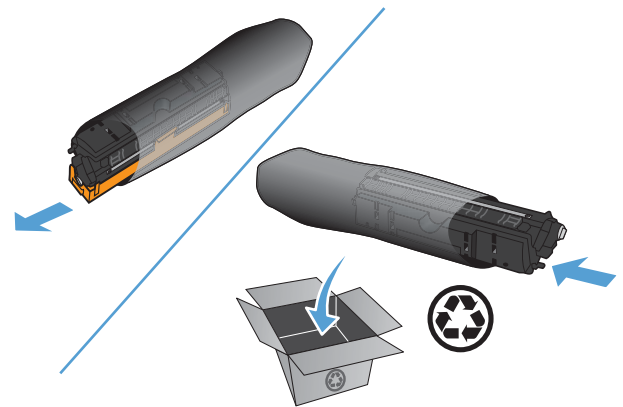

6. Remove the protective shielding from the new imaging drum.

CAUTION: To prevent damage, do not expose the imaging drum to light. Cover it with a piece of paper.

CAUTION: Do not touch the green roller. Fingerprints on the imaging drum can cause print-quality problems.

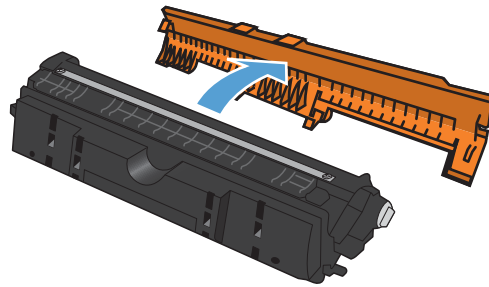

7. Insert the new imaging drum in the product.



8. Lower the two levers that hold the imaging drum.



9. Close the front cover.



10. Close the print cartridge door.

NOTE: After closing the print cartridge door, the control panel shows the **Calibrating...** message. Allow a few minutes for the product to calibrate.



Recycle supplies

For US and Puerto Rico HP LaserJet print cartridge recycling returns, use the pre-paid, pre-addressed shipping label contained in the box. To use the UPS label, give the package to the UPS driver during your next delivery or pickup, or take it to an authorized UPS drop-off center. (Requested UPS Ground pickup will be charged normal pick up rates.) For the location of a local UPS drop-off center, call 1-800-PICKUPS or visit www.ups.com. If you are returning the package via the FedEx label, give the package to either the U.S. Postal Service carrier or FedEx driver during your next pickup or delivery. (Requested FedEx Ground pickup will be charged normal pick up rates). Or, you can drop off your packaged print cartridge(s) at any U.S. Post Office or any FedEx shipping center or store. For the location of the nearest U.S. Post Office, please call 1-800-ASK-USPS or visit www.usps.com. For the location of the nearest FedEx shipping center/store, please call 1-800-GOFEDEX or visit www.fedex.com. For more information, or to order additional labels or boxes for bulk returns, visit www.hp.com/recycle or call 1-800-340-2445. Information is subject to change without notice.

Print-cartridge and imaging drum storage

Do not remove the print cartridge or imaging drum from their packages until you are ready to use them.

HP policy on non-HP supplies

Hewlett-Packard Company cannot recommend the use of non-HP print cartridges and imaging drums, either new or remanufactured.

 **NOTE:** For HP printer products, the use of a non-HP print cartridge or a refilled print cartridge does not affect either the warranty to the customer or any HP support contract with the customer. However, if product failure or damage is attributable to the use of a non-HP print cartridge or refilled print cartridge, HP will charge its standard time and materials charges to service the product for the particular failure or damage.

HP fraud hotline and Web site

Call the HP fraud hotline (1-877-219-3183, toll-free in North America) or go to www.hp.com/go/anticounterfeit when you install an HP print cartridge and the control-panel message says the cartridge is non-HP or used. HP will help determine if the cartridge is genuine and take steps to resolve the problem.

Your print cartridge might not be a genuine HP print cartridge if you notice the following:

- The supplies status page indicates that a non-HP or used supply is installed.
- You are experiencing a high number of problems with the print cartridge.
- The cartridge does not look like it usually does (for example, the packaging differs from HP packaging).

Solve problems with print cartridges or the imaging drum

Check the print cartridges and imaging drum

Check each print cartridge, and replace it if necessary, if you are having any of the following problems:

- The printing is too light or seems faded in areas.
- Printed pages have small unprinted areas.
- Printed pages have streaks or bands.

If you determine that you need to replace a print cartridge, print the supplies status page to find the part number for the correct genuine HP print cartridge.

Type of print cartridge	Steps to resolve the problem
Refilled or remanufactured print cartridge	Hewlett-Packard Company cannot recommend the use of non-HP supplies, either new or remanufactured. Because they are not HP products, HP cannot influence their design or control their quality. If you are using a refilled or remanufactured print cartridge and are not satisfied with the print quality, replace the cartridge with a genuine HP cartridge that has the words "HP" or "Hewlett-Packard" on it, or has the HP logo on it.
Genuine HP print cartridge or imaging drum	<ol style="list-style-type: none">1. The product control panel or the supplies status page indicates "Very Low" status when the cartridge has reached the end of its estimated life. Replace the print cartridge if print quality is no longer acceptable.2. Print a print quality page from the Reports menu on the control panel. If streaks or marks are in one color on the page, you might have a defect in that color cartridge. See the instructions in this document for interpreting the page. Replace the print cartridge if necessary.3. Visually inspect the print cartridge for damage. See the instructions that follow. Replace the print cartridge if necessary.4. If printed pages have marks that repeat several times at the same distance apart, print a cleaning page. If this does not solve the problem, use the repetitive defects section in this document to identify the cause of the problem.

Inspect the print cartridges and imaging drum for damage

1. Remove the print cartridge from the product, and examine for damage.

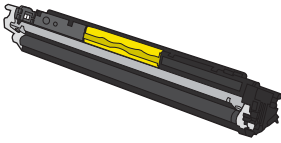

2. If the print cartridge does not appear to be damaged, rock the print cartridge gently several times and reinstall it. Print a few pages to see if the problem is resolved.
3. If the problem is not resolved, remove the imaging drum from the product, and examine the surface.

△ **CAUTION:** Do not touch the green roller. Fingerprints on the imaging drum can cause print-quality problems.

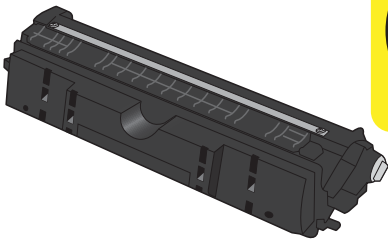

4. If you see any scratches, fingerprints, or other damage on the imaging drum, replace the imaging drum.

Repeating defects

If defects repeat at any of the following intervals on the page, a print cartridge or the imaging drum might be damaged.

- 22 mm (print cartridge)
- 26 mm (imaging drum)
- 29 mm (print cartridge)
- 94 mm (imaging drum)

Print the supplies status page

Use the control panel to print configuration and supplies status pages that give details about the product and its current settings.

1. On the product control panel, press the Setup  button.
2. Use the arrow buttons to select the **Reports** menu, and then press the **OK** button.
3. Use the arrow buttons to select the **Supplies Status** item, and then press the **OK** button.

Page	Description
Configuration page	Prints a list of the product settings
Supplies status page	The supplies status page includes the following information: <ul style="list-style-type: none">• Approximate percentage of print cartridge life remaining• Warranty for print cartridges and imaging drum (if those supplies are at a "very low" level)• Part numbers for HP print cartridges and the imaging drum• Number of pages printed on each print cartridge• Information about ordering new HP print cartridges and recycling used HP print cartridges• The imaging drum's estimated life remaining and installation date appear on the supplies status page.

Interpret the print quality page

1. On the product control panel, press the Setup  button.
2. Use the arrow buttons to select the **Reports** menu, and then press the **OK** button.
3. Use the arrow buttons to select the **Print Quality** item, and then press the **OK** button.

This page contains five bands of color, which are divided into four groups as indicated in the following illustration. By examining each group, you can isolate the problem to a particular print cartridge.

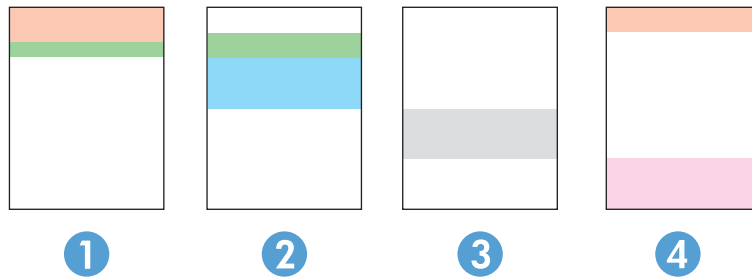

Section	Print-cartridge
1	Yellow
2	Cyan
3	Black
4	Magenta

- If dots or streaks appear in only one of the groups, replace the print cartridge that correlates with that group.
- If dots appear in more than one group, print a cleaning page. If this does not solve the problem, determine if the dots are always the same color; for example, if magenta dots appear in all five color bands. If the dots are all the same color, replace that print cartridge.
- If streaks appear in multiple color bands, contact HP. A component other than the print cartridge is probably causing the problem.

Interpret control panel messages for print cartridges or the imaging drum

Control panel message	Description	Recommended action
<p>10.0004 Supply Error</p> <p>10.1004 Supply memory error</p>	There is a communication failure with the imaging drum.	<ul style="list-style-type: none"> • Turn the product off and then on. • If the error persists, replace the imaging drum. • If the error persists, contact HP. See www.hp.com/support/LJColorMFPM175 or the support flyer that came in the product box.
<p>10.000X Supply memory error</p> <p>10.100X Supply memory error</p>	There is a communication failure with one of the print cartridges. "X" indicates which cartridge: 0=black, 1=cyan, 2=magenta, 3=yellow.	<ul style="list-style-type: none"> • Turn the product off and then on. • Verify that the print cartridge is installed correctly. Remove and reinstall the print cartridges. • If the error persists, replace the print cartridges. • If the error persists, contact HP. See www.hp.com/support/LJColorMFPM175 or the support flyer that came in the product box.
Black cartridge is low	The print cartridge is nearing the estimated end of its useful life.	Printing can continue, but consider having a replacement supply on hand.
Black cartridge is very low	The print cartridge is at the estimated end of its useful life.	<p>To ensure optimal print quality, HP recommends replacing the print cartridge at this point. You can continue printing until you notice a decrease in print quality. Actual cartridge life may vary.</p> <p>Once an HP supply has reached "very low", HP's premium Protection Warranty on that supply has ended. All print defects or cartridge failures incurred when an HP supply is used in continue at very low mode will not be considered to be defects in materials or workmanship in the supply under the HP Print Cartridge Warranty Statement.</p>
Cyan cartridge is low	The print cartridge is nearing the estimated end of its useful life.	Printing can continue, but consider having a replacement supply on hand.
Cyan cartridge is very low	The print cartridge is at the estimated end of its useful life.	<p>To ensure optimal print quality, HP recommends replacing the print cartridge at this point. You can continue printing until you notice a decrease in print quality. Actual cartridge life may vary.</p> <p>Once an HP supply has reached "very low", HP's premium Protection Warranty on that supply has ended. All print defects or cartridge failures incurred when an HP supply is used in continue at very low mode will not be considered to be defects in materials or workmanship in the supply under the HP Print Cartridge Warranty Statement.</p>

Control panel message	Description	Recommended action
Door open	The print cartridge door is open.	Close the print cartridge door.
Jam in cartridge area	The product has detected a paper jam in the print cartridge area.	Clear the jam from the area indicated in the message, and then follow the control panel instructions.
Magenta cartridge is low	The print cartridge is nearing the estimated end of its useful life.	Printing can continue, but consider having a replacement supply on hand.
Magenta cartridge is very low	The print cartridge is at the estimated end of its useful life.	<p>To ensure optimal print quality, HP recommends replacing the print cartridge at this point. You can continue printing until you notice a decrease in print quality. Actual cartridge life may vary.</p> <p>Once an HP supply has reached “very low”, HP’s premium Protection Warranty on that supply has ended. All print defects or cartridge failures incurred when an HP supply is used in continue at very low mode will not be considered to be defects in materials or workmanship in the supply under the HP Print Cartridge Warranty Statement.</p>
Replace <Color> Cartridge	The indicated print cartridge is at the estimated end of its useful life. The product is customer-configured to stop when the print cartridge level is very low.	Replace the print cartridge, or reconfigure the product to continue printing after the print cartridge reaches the “very low” level.
Replace <Color>. Printing Black.	The indicated print cartridge is at the estimated end of its useful life. The product is customer-configured to print with the black cartridge only, until the very low print cartridge is replaced.	<p>To ensure optimal print quality, HP recommends replacing the print cartridge at this point. You can continue printing until you notice a decrease in print quality. Actual cartridge life may vary.</p> <p>Once an HP supply has reached “very low”, HP’s premium Protection Warranty on that supply has ended. All print defects or cartridge failures incurred when an HP supply is used in continue at very low mode will not be considered to be defects in materials or workmanship in the supply under the HP Print Cartridge Warranty Statement.</p>
Replace Supplies	Multiple supplies are at the estimated end of their useful life, and the product is customer-configured to stop when the supply level is very low.	Replace the supplies, or reconfigure the product to continue printing after the supplies reach the “very low” level.

Control panel message	Description	Recommended action
Replace Supplies. Printing Black.	One or more of the print cartridges is at the estimated end of its useful life. The product is customer-configured to print with the black cartridge only, until the very low print cartridges are replaced.	<p>To ensure optimal print quality, HP recommends replacing the print cartridge at this point. You can continue printing until you notice a decrease in print quality. Actual cartridge life may vary.</p> <p>Once an HP supply has reached “very low”, HP’s premium Protection Warranty on that supply has ended. All print defects or cartridge failures incurred when an HP supply is used in continue at very low mode will not be considered to be defects in materials or workmanship in the supply under the HP Print Cartridge Warranty Statement.</p>
Supplies are low	One or more of the print cartridges, or a combination of print cartridge(s) and the imaging drum, are nearing the estimated end of their useful life.	Printing can continue, but consider having a replacement supply on hand.
Supplies are very low	One or more of the print cartridges, or a combination of print cartridge(s) and the imaging drum, have reached the estimated end of their useful life.	<p>To ensure optimal print quality, HP recommends replacing the print cartridge or imaging drum at this point. You can continue printing until you notice a decrease in print quality. Actual cartridge life may vary.</p> <p>Once an HP print cartridge has reached “very low”, HP’s premium Protection Warranty on that supply has ended. All print defects or cartridge failures incurred when an HP supply is used in continue at very low mode will not be considered to be defects in materials or workmanship in the supply under the HP Print Cartridge Warranty Statement.</p> <p>The imaging drum installed in this product is covered by the product warranty. Replacement imaging drums have a one-year limited warranty from the date of installation. The imaging drum installation date displays on the supplies status page.</p>
Supplies in wrong positions	The print cartridges are installed in the incorrect slots.	Make sure that each print cartridge is installed in the correct slot.
Used <color> cartridge is installed	A used supply has been installed. The print cartridge is most likely a refilled cartridge.	<p>If you believe you purchased a genuine HP supply, visit this HP Web address: www.hp.com/go/anticounterfeit.</p> <p>If product failure or damage is attributable to the use of a non-HP print cartridge or refilled print cartridge, HP will charge its standard time and materials charges to service the product for the particular failure or damage. Supply status and features that depend on it are unavailable with used cartridges.</p>

Control panel message	Description	Recommended action
Used cartridges installed	Used supplies have been installed. The print cartridges are most likely refilled cartridges.	<p>If you believe you purchased a genuine HP supply, visit this HP Web address: www.hp.com/go/anticounterfeit.</p> <p>If product failure or damage is attributable to the use of a non-HP print cartridge or refilled print cartridge, HP will charge its standard time and materials charges to service the product for the particular failure or damage. Supply status and features that depend on it are unavailable with used cartridges.</p>
Used supplies in use	Used supplies have been installed. The print cartridges are most likely refilled cartridges.	<p>If you believe you purchased a genuine HP supply, visit this HP Web address: www.hp.com/go/anticounterfeit.</p> <p>If product failure or damage is attributable to the use of a non-HP print cartridge or refilled print cartridge, HP will charge its standard time and materials charges to service the product for the particular failure or damage. Supply status and features that depend on it are unavailable with used cartridges.</p>
Wrong Cartridge in <Color> Slot	A print cartridge is installed incorrectly in the indicated slot.	Make sure that each print cartridge is installed in the correct slot.
Yellow cartridge is low	The print cartridge is nearing the estimated end of its useful life.	Printing can continue, but consider having a replacement supply on hand.
Yellow cartridge is very low	The print cartridge is at the estimated end of its useful life.	<p>To ensure optimal print quality, HP recommends replacing the print cartridge at this point. You can continue printing until you notice a decrease in print quality. Actual cartridge life may vary.</p> <p>Once an HP supply has reached “very low”, HP’s premium Protection Warranty on that supply has ended. All print defects or cartridge failures incurred when an HP supply is used in continue at very low mode will not be considered to be defects in materials or workmanship in the supply under the HP Print Cartridge Warranty Statement.</p>

8 Print tasks

- [Cancel a print job](#)
- [Basic print tasks with Windows](#)
- [Additional print tasks with Windows](#)

Cancel a print job

1. If the print job is currently printing, cancel it by pressing the Cancel **X** button on the product control panel.



NOTE: Pressing the Cancel **X** button clears the job that the product is currently processing. If more than one process is running, pressing the Cancel **X** button clears the process that currently appears on the product control panel.

2. You can also cancel a print job from a software program or a print queue.
 - **Software program:** Typically, a dialog box appears briefly on the computer screen, allowing you to cancel the print job.
 - **Windows print queue:** If a print job is waiting in a print queue (computer memory) or print spooler, delete the job there.
 - **Windows XP, Server 2003, or Server 2008:** Click **Start**, click **Settings**, and then click **Printers and Faxes**. Double-click the product icon to open the window, right-click the print job that you want to cancel, and then click **Cancel**.
 - **Windows Vista:** Click **Start**, click **Control Panel**, and then, under **Hardware and Sound**, click **Printer**. Double-click the product icon to open the window, right-click the print job that you want to cancel, and then click **Cancel**.
 - **Windows 7:** Click **Start**, and then click **Devices and Printers**. Double-click the product icon to open the window, right-click the print job that you want to cancel, and then click **Cancel**.

Basic print tasks with Windows

The methods to open the print dialog from software programs can vary. The procedures that follow include a typical method. Some software programs do not have a **File** menu. See the documentation for your software program to learn how to open the print dialog.

Open the printer driver with Windows

1. On the **File** menu in the software program, click **Print**.
2. Select the product, and then click the **Properties** or **Preferences** button.

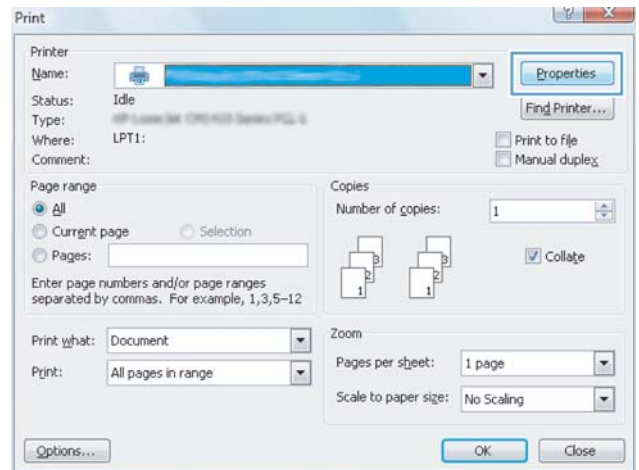
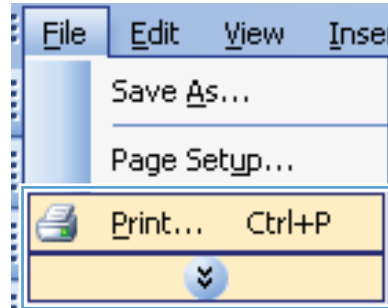

Get help for any printing option with Windows

1. Click the **Help** button to open the online Help.

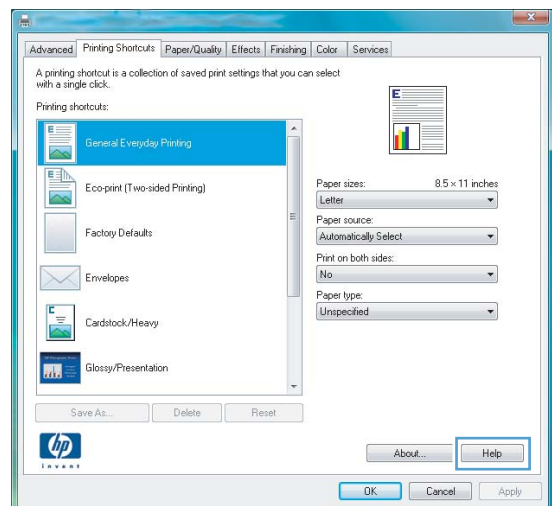

Change the number of print copies with Windows

1. On the **File** menu in the software program, click **Print**.
2. Select the product, and then select the number of copies.

Save custom print settings for reuse with Windows

Use a printing shortcut with Windows

1. On the **File** menu in the software program, click **Print**.
2. Select the product, and then click the **Properties** or **Preferences** button.

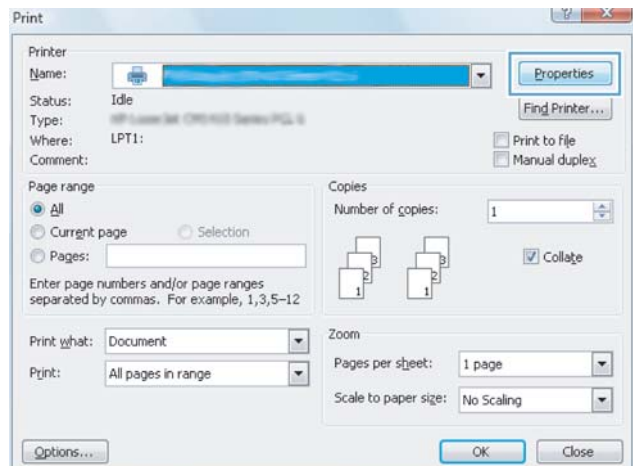
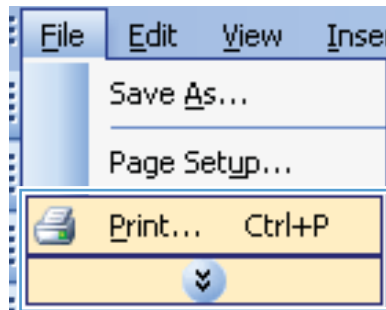

3. Click the **Printing Shortcuts** tab.

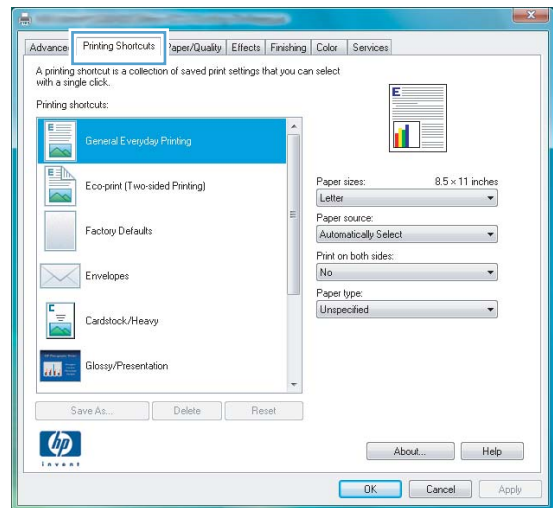

4. Select one of the shortcuts, and then click the **OK** button.

NOTE: When you select a shortcut, the corresponding settings change on the other tabs in the printer driver.

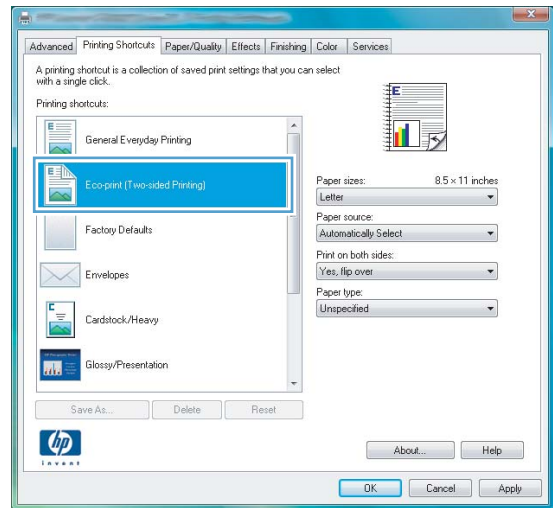

Create printing shortcuts

1. On the **File** menu in the software program, click **Print**.

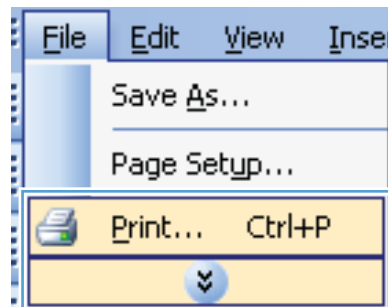

2. Select the product, and then click the **Properties** or **Preferences** button.

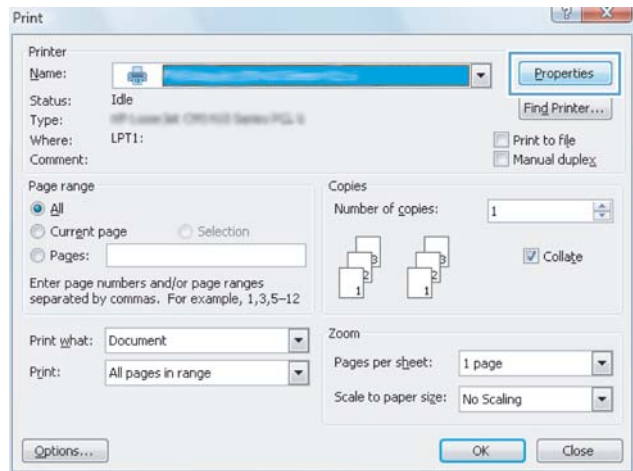

3. Click the **Printing Shortcuts** tab.

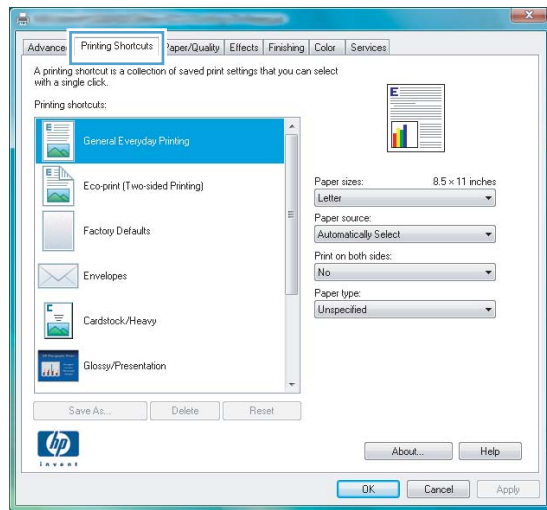

4. Select an existing shortcut as a base.

NOTE: Always select a shortcut before adjusting any of the settings on the right side of the screen. If you adjust the settings and then select a shortcut, or if you select a different shortcut, all your adjustments are lost.

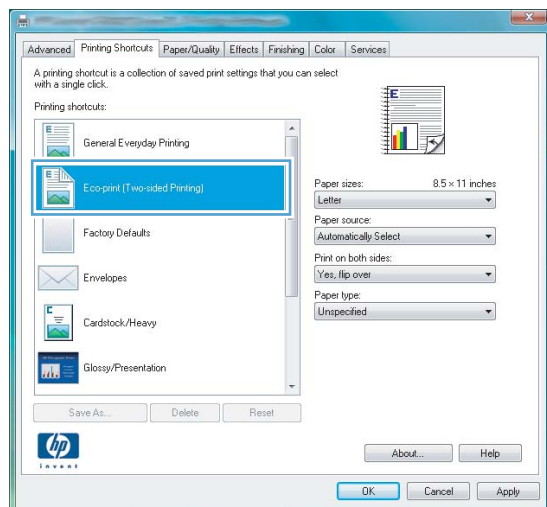

5. Select the print options for the new shortcut.

NOTE: You can select the print options on this tab or on any other tab in the printer driver. After selecting options on other tabs, return to the **Printing Shortcuts** tab before continuing with the next step.

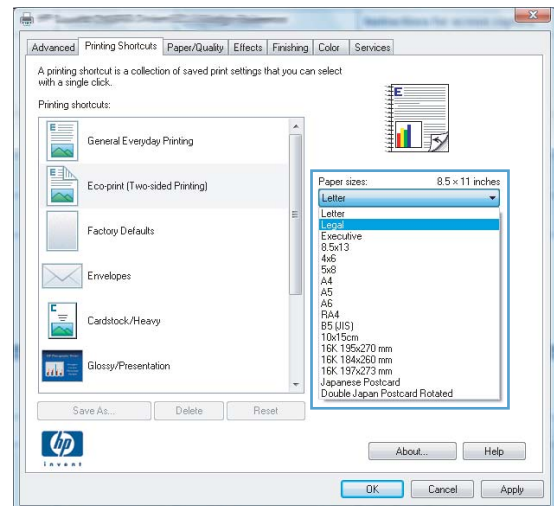

6. Click the **Save As** button.

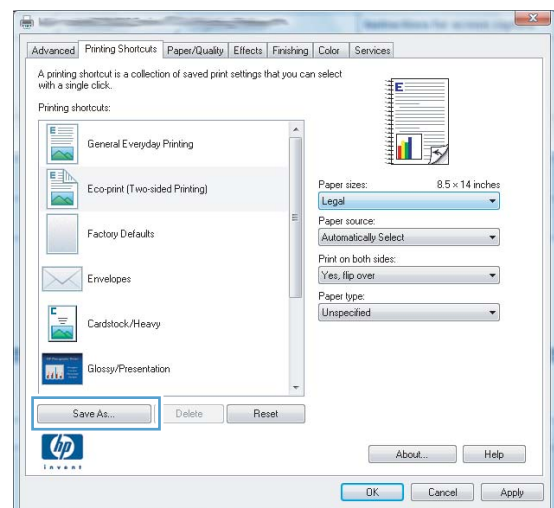

7. Type a name for the shortcut, and click the **OK** button.

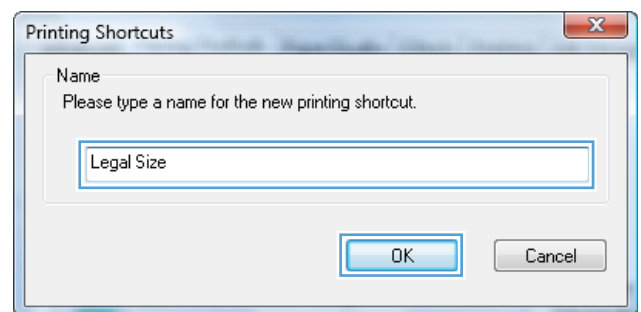

Improve print quality with Windows

Select the page size with Windows

1. On the **File** menu in the software program, click **Print**.
2. Select the product, and then click the **Properties** or **Preferences** button.

3. Click the **Paper/Quality** tab.
4. Select a size from the **Size is** drop-down list.

Select a custom page size with Windows

1. On the **File** menu in the software program, click **Print**.
2. Select the product, and then click the **Properties** or **Preferences** button.
3. Click the **Paper/Quality** tab.
4. Click the **Custom** button.
5. Type a name for the custom size and specify the dimensions.
 - The width is the short edge of the paper.
 - The length is the long edge of the paper.



NOTE: Always load paper into the trays short edge first.

6. Click the **Save** button, and then click the **Close** button.

Select the paper type with Windows

1. On the **File** menu in the software program, click **Print**.
2. Select the product, and then click the **Properties** or **Preferences** button.
3. Click the **Paper/Quality** tab.
4. From the **Type is** drop-down list, click the **More...** option.
5. Select the category of paper types that best describes your paper, and then click the paper type that you are using.

Print on both sides (duplex) with Windows

Manually print on both sides (duplex) with Windows

1. Load paper face-up in the input tray.



2. On the **File** menu in the software program, click **Print**.

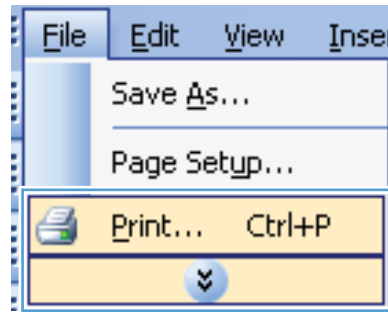

3. Select the product, and then click the **Properties** or **Preferences** button.

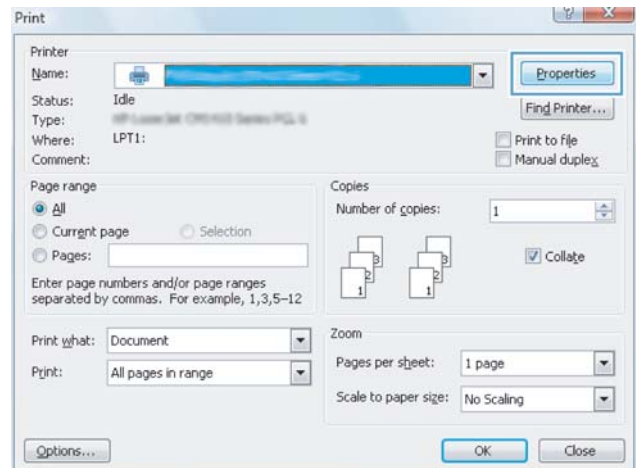

4. Click the **Finishing** tab.

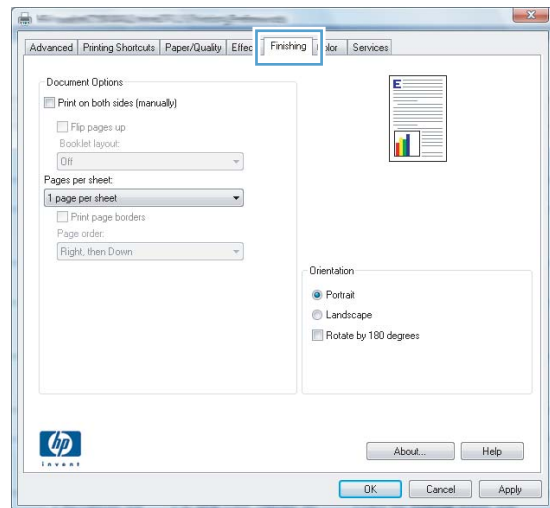

5. Select the **Print on Both Sides (Manually)** check box. Click the **OK** button to print the first side of the job.

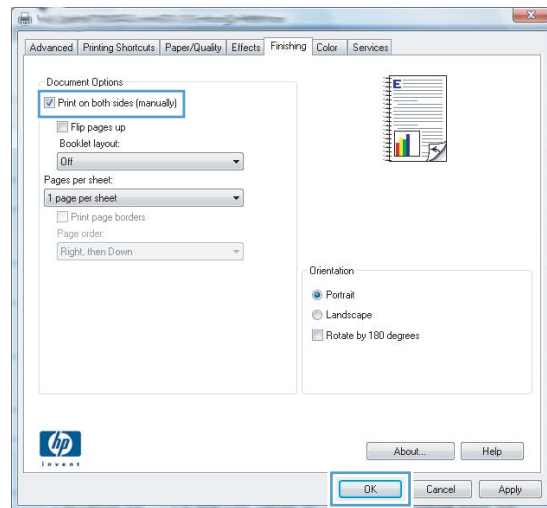

6. Retrieve the printed stack from the output bin, and, maintaining the paper orientation, place it with the printed-side facing down in the input tray.



7. At the computer, click the **Continue** button to print the second side of the job. If at the product, press the **OK** button.

Print multiple pages per sheet with Windows

1. On the **File** menu in the software program, click **Print**.

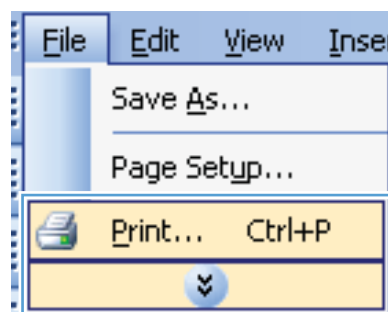

2. Select the product, and then click the **Properties** or **Preferences** button.

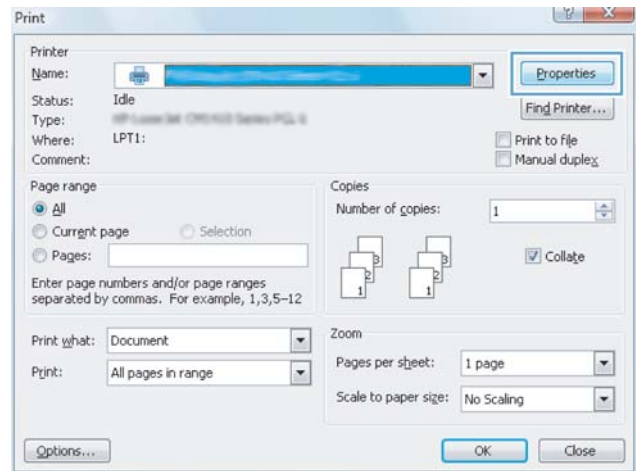

3. Click the **Finishing** tab.

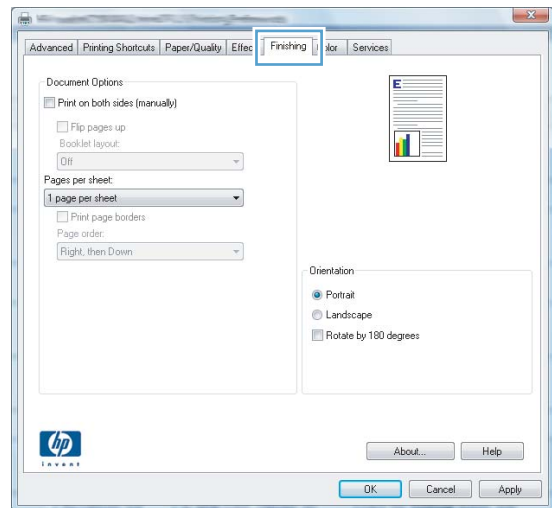

- 4. Select the number of pages per sheet from the **Pages Per Sheet** drop-down list.

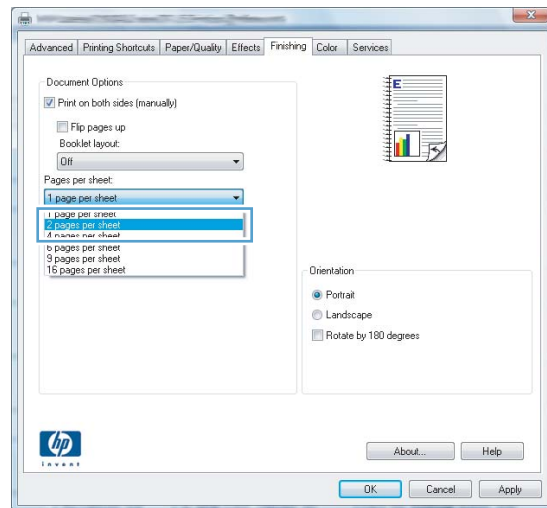

- 5. Select the correct **Print Page Borders**, **Page Order**, and **Orientation** options.

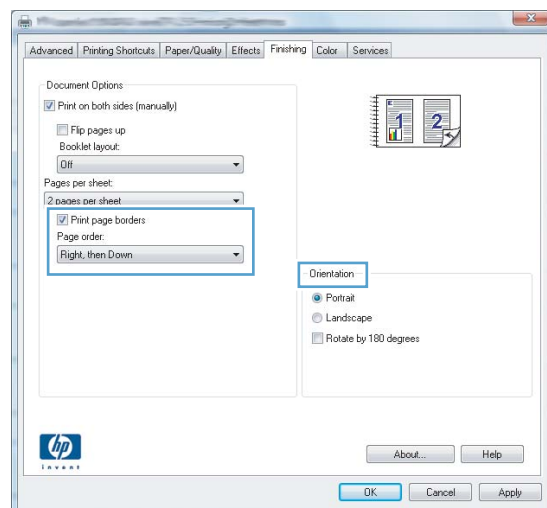

Select page orientation with Windows

- 1. On the **File** menu in the software program, click **Print**.

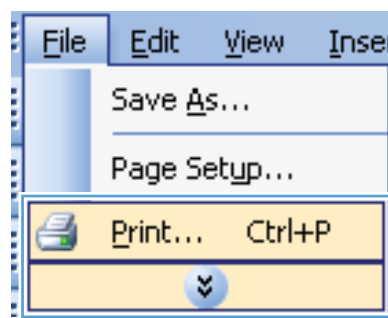

2. Select the product, and then click the **Properties** or **Preferences** button.

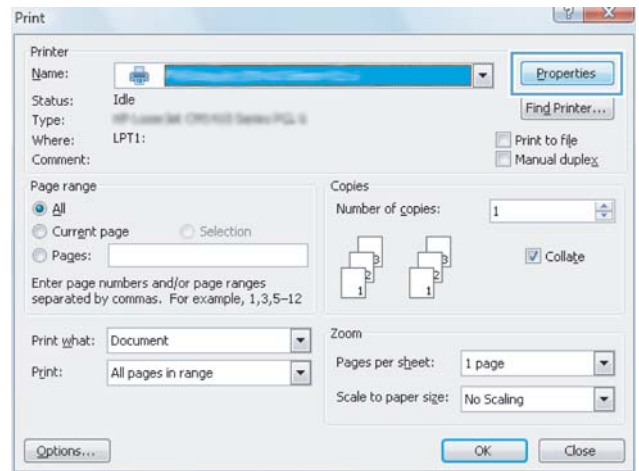

3. Click the **Finishing** tab.

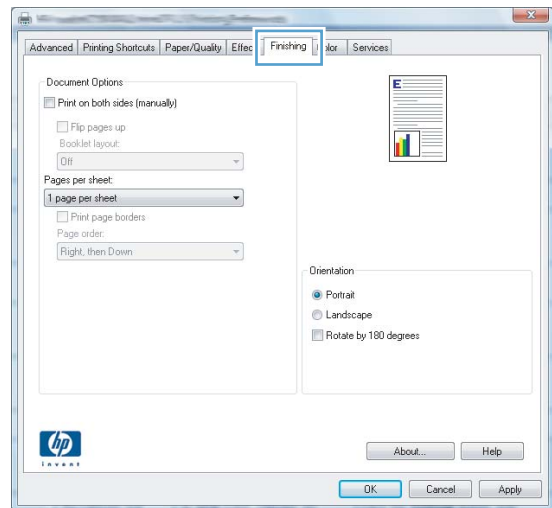

4. In the **Orientation** area, select the **Portrait** or **Landscape** option.

To print the page image upside down, select the **Rotated** option.

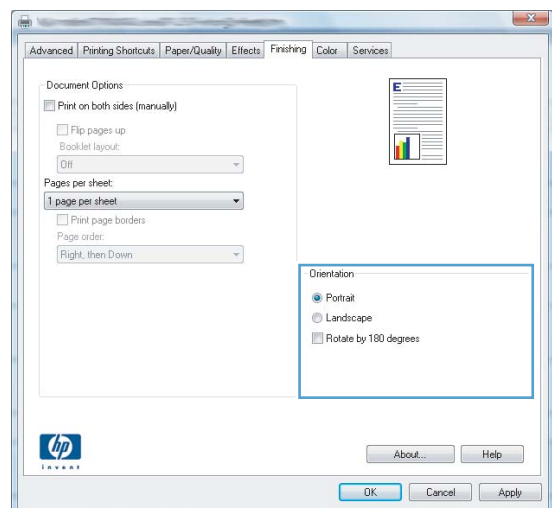

Set color options with Windows

1. On the **File** menu in the software program, click **Print**.
2. Select the product, and then click the **Properties** or **Preferences** button.
3. Click the **Color** tab.
4. In the **Color Options** area, click the **Manual** option, and then click the **Settings** button.
5. Adjust the general settings for Edge Control, and settings for text, graphics, and photographs.

Additional print tasks with Windows

Print colored text as black with Windows

1. On the **File** menu in the software program, click **Print**.
2. Select the product, and then click the **Properties** or **Preferences** button.
3. Click the **Paper/Quality** tab.
4. Click the **Print all Text as Black** check box. Click the **OK** button.

Print on preprinted letterhead or forms with Windows

1. On the **File** menu in the software program, click **Print**.

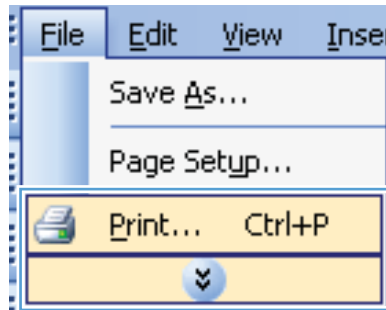

2. Select the product, and then click the **Properties** or **Preferences** button.

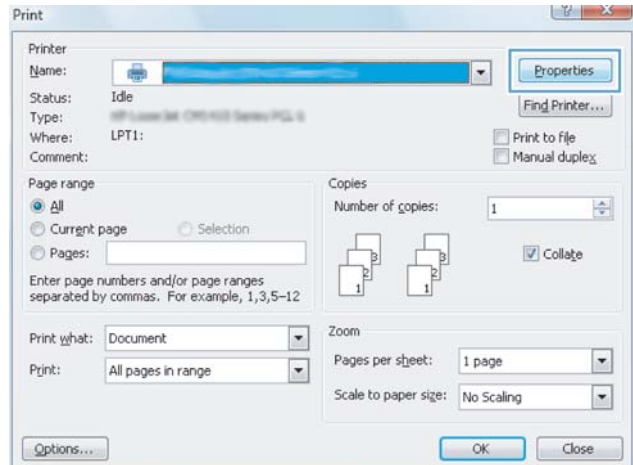

3. Click the **Paper/Quality** tab.

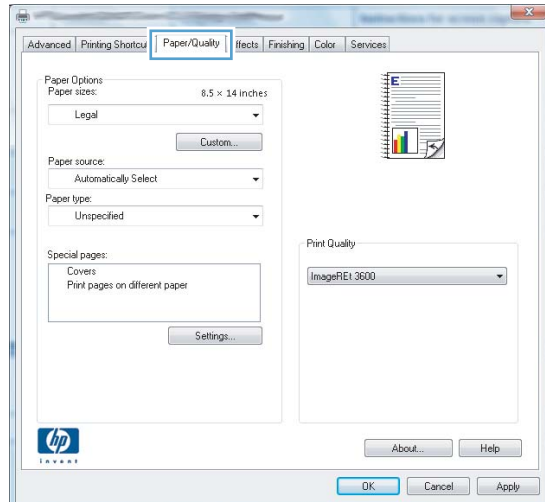

4. From the **Type is** drop-down list, click the **More...** option.

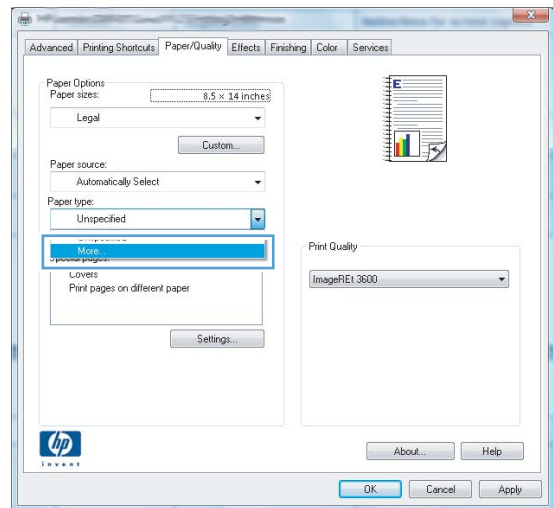

5. Select the **Other** option.

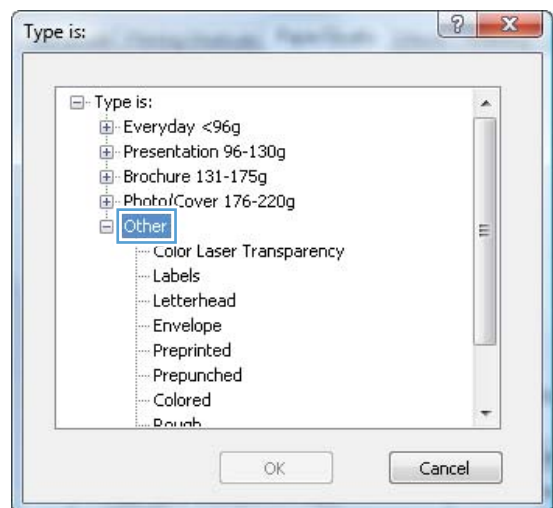

6. Select the option for the type of paper you are using, and click the **OK** button.

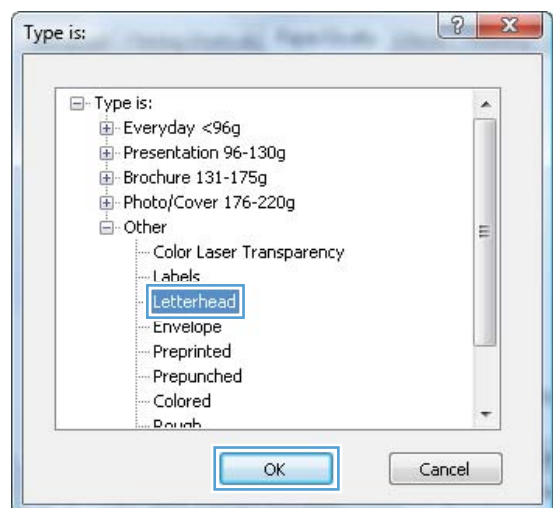

Print on special paper, labels, or transparencies

1. On the **File** menu in the software program, click **Print**.

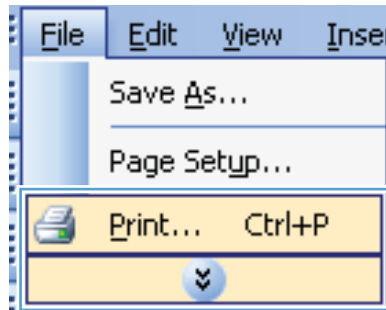

2. Select the product, and then click the **Properties** or **Preferences** button.

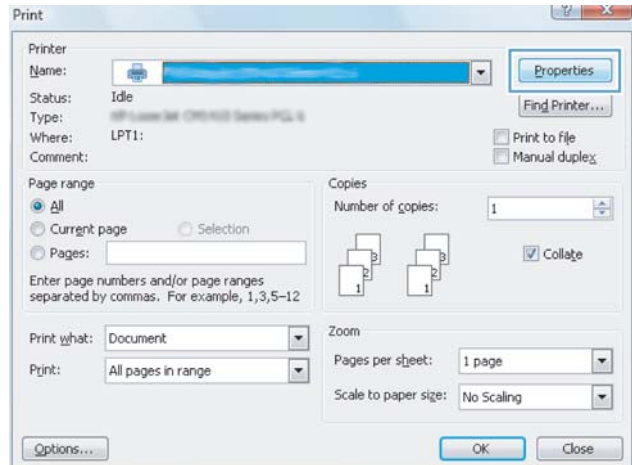

3. Click the **Paper/Quality** tab.

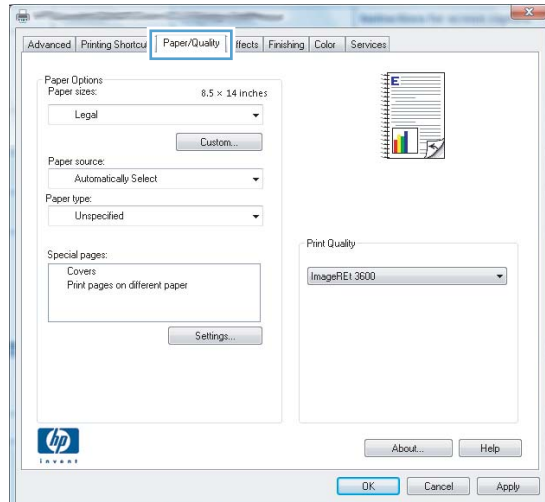

4. From the **Type is** drop-down list, click the **More...** option.

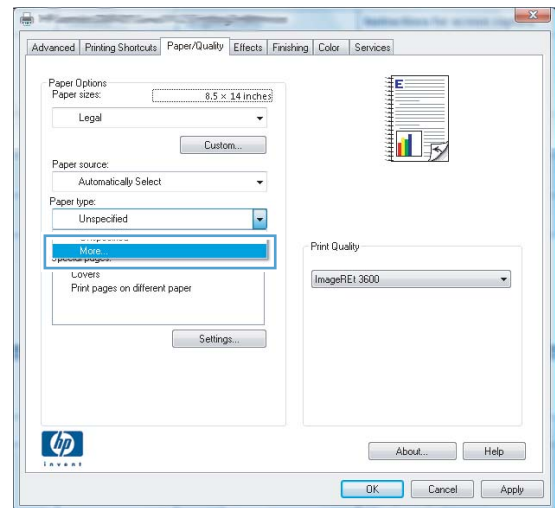

5. Select the category of paper types that best describes your paper.

NOTE: Labels and transparencies are in the list of **Other** options.

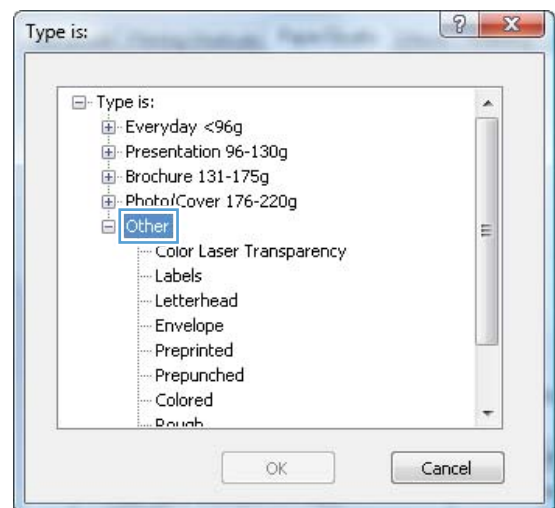

6. Select the option for the type of paper you are using, and click the **OK** button.

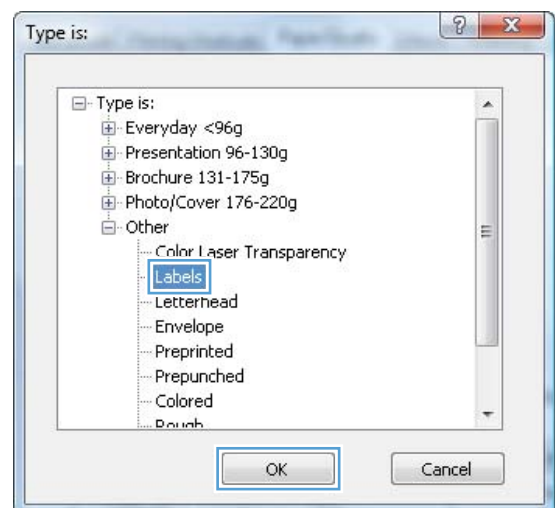

Print the first or last page on different paper with Windows

1. On the **File** menu in the software program, click **Print**.

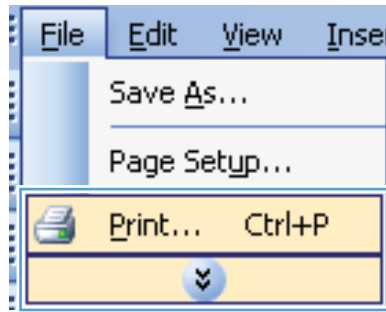

2. Select the product, and then click the **Properties** or **Preferences** button.

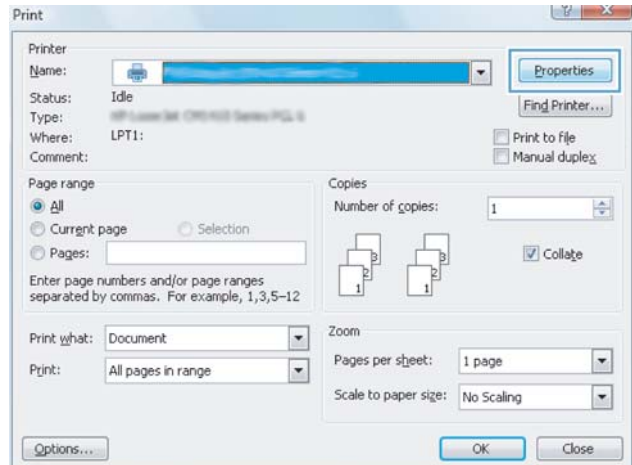

3. Click the **Paper/Quality** tab.

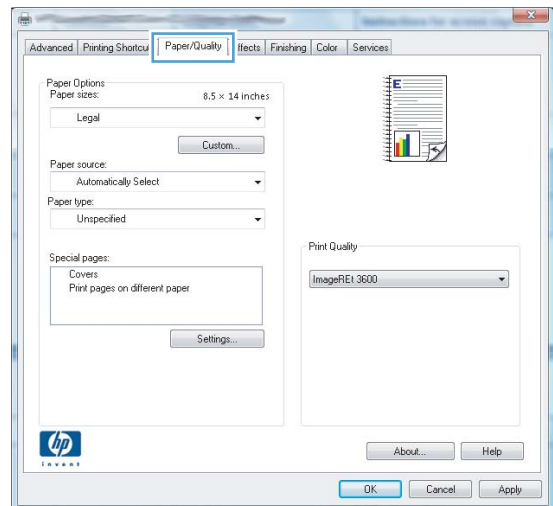

4. Click the **Use different paper** check box, and then select the necessary settings for the front cover, other pages, and back cover.

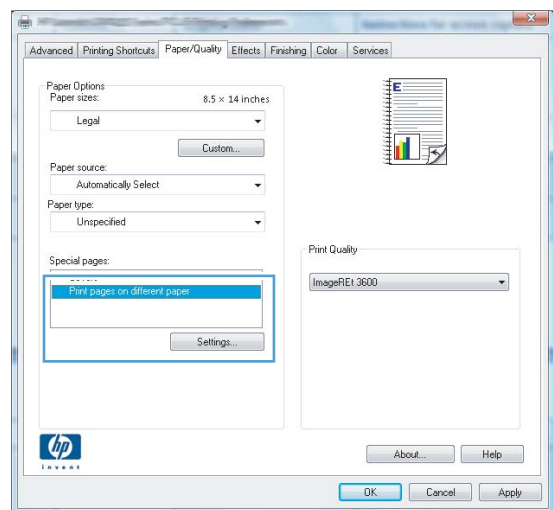

Scale a document to fit page size

1. On the **File** menu in the software program, click **Print**.

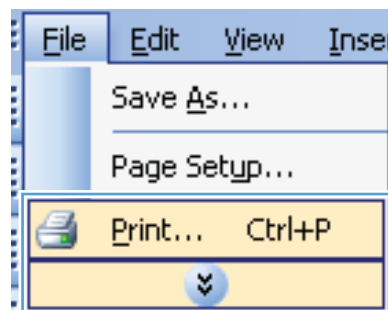

2. Select the product, and then click the **Properties** or **Preferences** button.

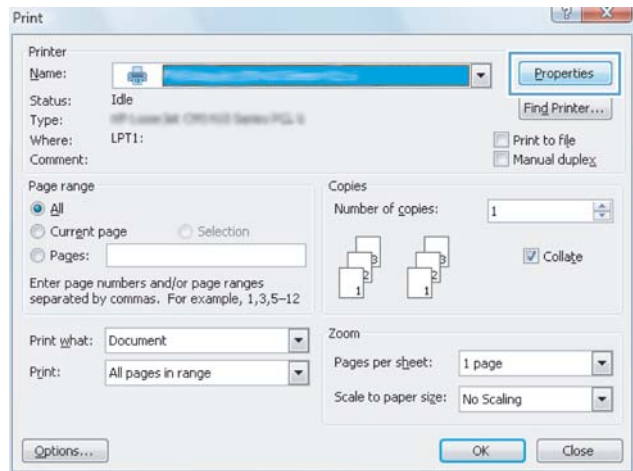

3. Click the **Effects** tab.

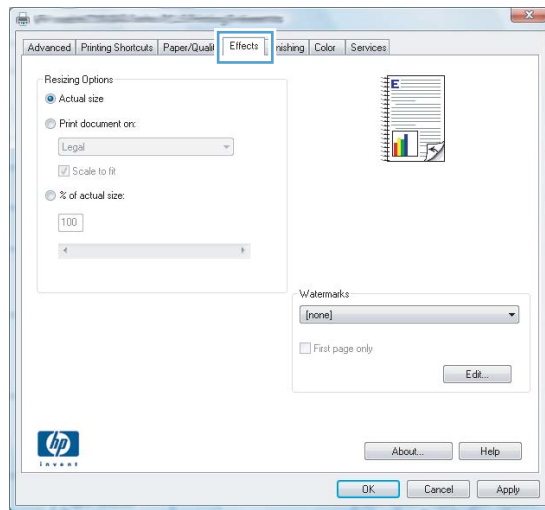

4. Select the **Print Document On** option, and then select a size from the drop-down list.

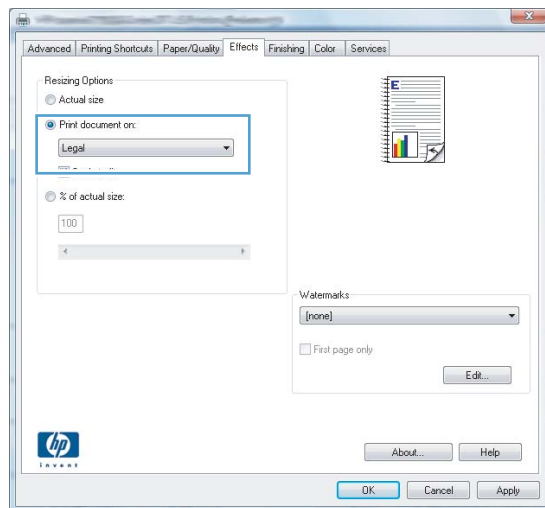

Add a watermark to a document with Windows

1. On the **File** menu in the software program, click **Print**.
2. Select the product, and then click the **Properties** or **Preferences** button.
3. Click the **Effects** tab.
4. Select a watermark from the **Watermarks** drop-down list.

Or, to add a new watermark to the list, click the **Edit** button. Specify the settings for the watermark, and then click the **OK** button.
5. To print the watermark on the first page only, select the **First Page Only** check box. Otherwise, the watermark is printed on each page.

Create a booklet with Windows

1. On the **File** menu in the software program, click **Print**.
2. Select the product, and then click the **Properties** or **Preferences** button.

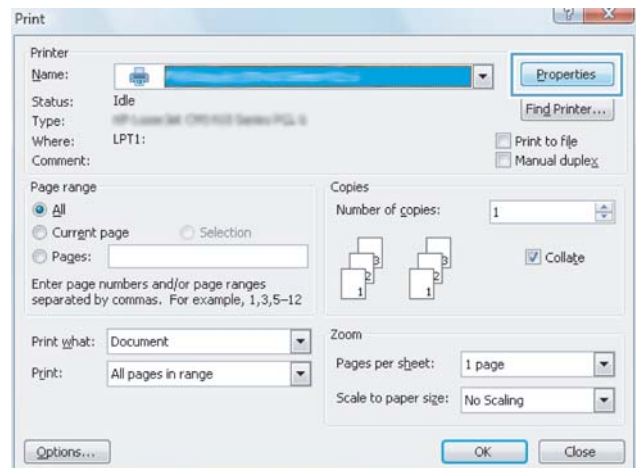
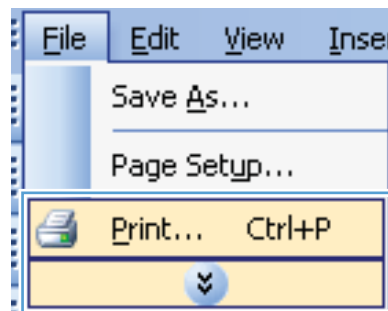

3. Click the **Finishing** tab.

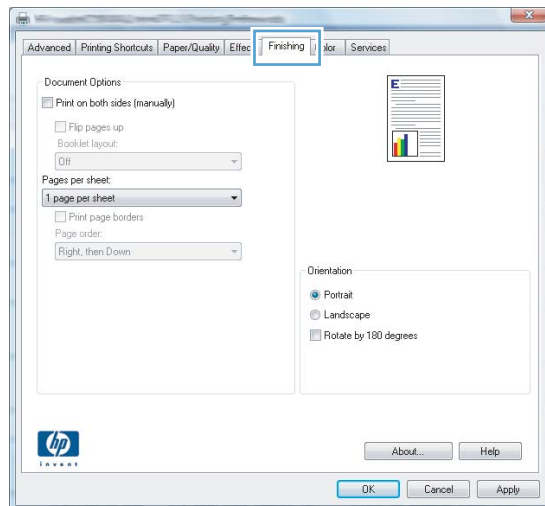

4. Click the **Print on Both Sides (Manually)** check box.

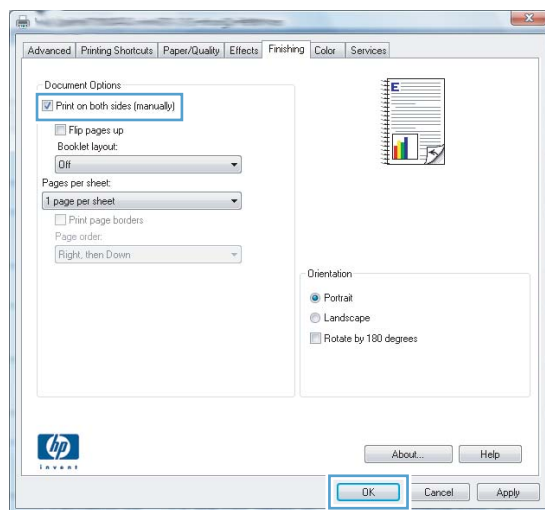

5. In the **Booklet Printing** drop-down list, select a binding option. The **Pages Per Sheet** option automatically changes to **2 Pages Per Sheet**.

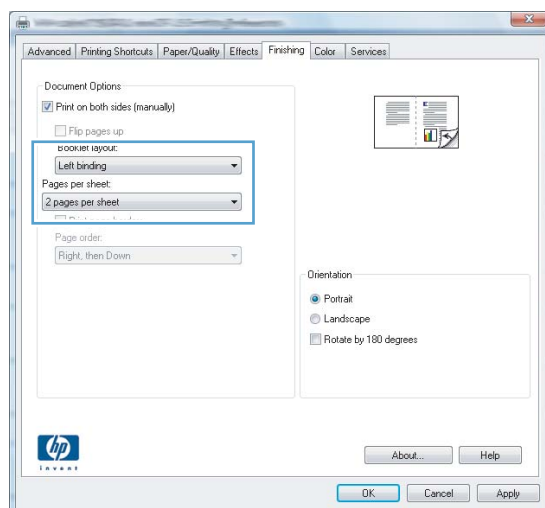

9 Color

- [Adjust color](#)
- [Use the HP EasyColor option for Windows](#)
- [Match colors](#)

Adjust color

Manage color by changing the settings on the **Color** tab in the printer driver.

Change the color theme for a print job

1. On the **File** menu in the software program, click **Print**.
2. Click **Properties** or **Preferences**.
3. Click the **Color** tab.
4. Select a color theme from the **Color Themes** drop-down list.

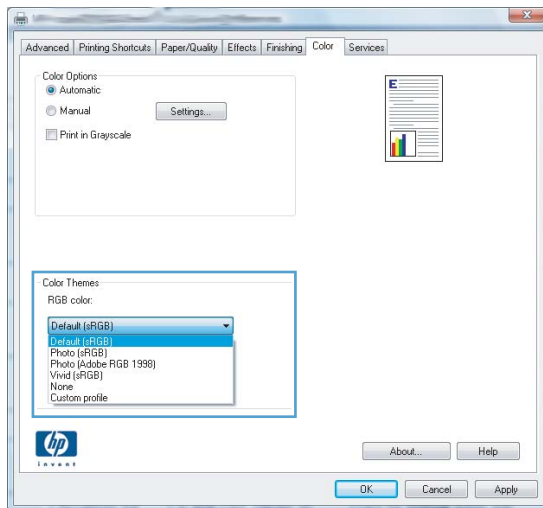

- **Default (sRGB)**: This theme sets the product to print RGB data in raw device mode. When using this theme, manage color in the software program or in the operating system for correct rendering.
- **Vivid**: The product increases the color saturation in the midtones. Use this theme when printing business graphics.
- **Photo**: The product interprets RGB color as if it were printed as a photograph using a digital mini lab. The product renders deeper, more saturated colors differently than with the Default (sRGB) theme. Use this theme when printing photos.
- **Photo (Adobe RGB 1998)**: Use this theme with printing digital photos that use the AdobeRGB color space rather than sRGB. Turn off color management in the software program when using this theme.
- **None**: No color theme is used.

Change the color options

Change the color options settings for the current print job from the color tab of the printer driver.

1. On the **File** menu in the software program, click **Print**.
2. Click **Properties** or **Preferences**.
3. Click the **Color** tab.

4. Click the **Automatic** or **Manual** setting.
 - **Automatic** setting: Select this setting for most color print jobs
 - **Manual** setting: Select this setting to adjust the color settings independent from other settings.

 **NOTE:** Changing color settings manually can impact output. HP recommends that only color graphics experts change these settings.

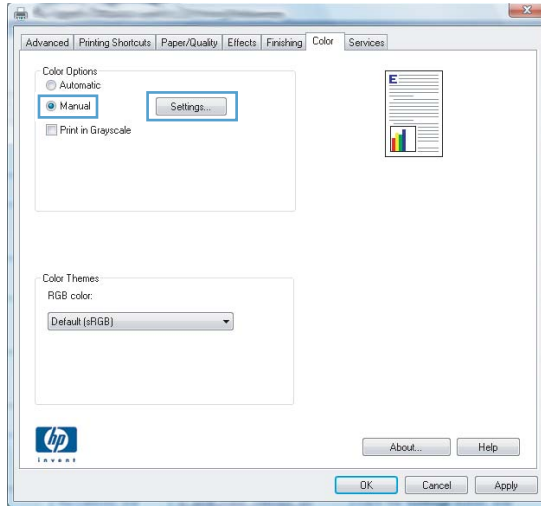

5. Click the **Print in Grayscale** option to print a color document in black and shades of gray. Use this option to print color documents for photocopying or faxing. You can also use this option to print draft copies or to save color toner.
6. Click the **OK** button.

Manual color options

Use manual color options to adjust the **Neutral Grays**, **Halftone**, and **Edge Control** options for text, graphics, and photographs.

Table 9-1 Manual color options

Setting description	Setting options
<p>Edge Control</p> <p>The Edge Control setting determines the rendering of edges. Edge control has two components: adaptive halftoning and trapping. Adaptive halftoning increases edge sharpness. Trapping reduces the effect of color-plane misregistration by overlapping the edges of adjacent objects slightly.</p>	<ul style="list-style-type: none"> • Off turns off both trapping and adaptive halftoning. • Light sets trapping at a minimal level. Adaptive halftoning is on. • Normal sets trapping at a medium level. Adaptive halftoning is on. • Maximum is the most aggressive trapping setting. Adaptive halftoning is on.

Table 9-1 Manual color options (continued)

Setting description	Setting options
<p>Halftone</p> <p>Halftone options affect color output clarity and resolution.</p>	<ul style="list-style-type: none">• Smooth provides better results for large, solid-filled print areas and enhances photographs by smoothing color gradations. Select this option when uniform and smooth area fills are important.• Detail is useful for text and graphics that require sharp distinctions among lines or colors, or images that contain a pattern or a high level of detail. Select this option when sharp edges and small details are important.
<p>Neutral Grays</p> <p>The Neutral Grays setting determines the method for creating gray colors used in text, graphics, and photographs.</p>	<ul style="list-style-type: none">• Black Only generates neutral colors (grays and black) by using only black toner. This guarantees neutral colors without a color cast. This setting is best for documents and grayscale viewgraphs.• 4-Color generates neutral colors (grays and black) by combining all four toner colors. This method produces smoother gradients and transitions to other colors, and it produces the darkest black.

Use the HP EasyColor option for Windows

If you are using the HP PCL 6 printer driver for Windows, the **HP EasyColor** technology automatically improves mixed-content documents that are printed from Microsoft Office programs. This technology scans documents and automatically adjusts photographic images in .JPEG or .PNG format.

HP EasyColor technology enhances the entire image at one time, rather than dividing it into several pieces, which results in improved color consistency, sharper details, and faster printing.

In the following example, the images on the left were created without using the **HP EasyColor** option. The images on the right show the enhancements that result from using the **HP EasyColor** option.



The **HP EasyColor** option is enabled by default in the HP PCL 6 printer driver, so you do not need to make manual color adjustments. To disable the option so you can manually adjust the color settings, open the **Color** tab, and click the **HP EasyColor** check box to clear it.

Match colors

For most users, the best method for matching colors is to print sRGB colors.

The process of matching printer output color to your computer screen is complex, because printers and computer monitors use different methods of producing color. Monitors *display* colors by using light pixels that use an RGB (red, green, blue) color process, but printers *print* colors by using a CMYK (cyan, magenta, yellow, and black) process.

Several factors can influence your ability to match printed colors to those on your monitor:

- Print media
- Printer colorants (inks or toners, for example)
- Printing process (inkjet, press, or laser technology, for example)
- Overhead lighting
- Personal differences in perception of color
- Software programs
- Printer drivers
- Computer operating systems
- Monitors
- Video cards and drivers
- Operating environment (humidity, for example)

Keep these factors in mind when colors on your screen do not perfectly match your printed colors.

10 Copy

- [Use copy functions](#)
- [Copy settings](#)
- [Copy photos](#)
- [Copy mixed size originals](#)
- [Copy on both sides manually \(duplex\)](#)

Use copy functions

One-touch copy

1. Load the document onto the scanner glass or into the document feeder.



2. Press the **Black** or **Color** button to start copying.

Multiple copies

1. Load the document onto the scanner glass or into the document feeder.



2. On the control panel, touch the **# Copies**  button.
3. Use the arrow buttons to change the number of copies.
4. Press the **Black** or **Color** button to start copying.

Copy a multiple-page original

1. Insert the originals into the document feeder face-up, and then adjust the guides until they are snug against the paper.



2. Press the **Black** or **Color** button to start copying.

Copy identification cards

Use the **ID Copy** feature to copy both sides of identification cards, or other small-size documents, onto the same side of one sheet of paper. The product prompts you to copy the first side and then to place the second side on a different area of the scanner glass and copy again. The product prints both images at the same time.

1. Load the document onto the scanner glass.



2. On the control panel, press the **Copy Menu**  button.
3. Use the arrow buttons to select the **ID Copy** menu, and then press the **OK** button.
4. When prompted by the control panel display, turn the document over, place it on a different portion of the scanner glass, and then press the **OK** button.



5. When prompted by the control panel display, press the **Black** or **Color** button to start copying.

The product copies all pages onto one side of a sheet of paper.

Cancel a copy job

1. Press the Cancel **X** button on the product control panel.

 **NOTE:** If more than one process is running, pressing the Cancel **X** button clears the current process and all pending processes.

2. Remove the remaining pages from the document feeder.

Reduce or enlarge a copy

1. Load the document onto the scanner glass or into the document feeder.



2. On the control panel, press the **Copy Menu**  button.
3. Use the arrow buttons to select the **Reduce/Enlarge** menu item, and then press the **OK** button. Use the arrow buttons to scroll through the options, and then press the **OK** button select the option.
4. Press the **Black** or **Color** button to start copying.

Collate a copy job

1. Load the document onto the scanner glass or into the document feeder.



2. On the control panel, press the **Copy Menu**  button.
3. Use the arrow buttons to select the **Copy Collation** menu item, and then press the **OK** button. Use the arrow buttons to scroll through the options, and then press the **OK** button to select an option.
4. Press the **Black** or **Color** button to start copying.

Make color or black and white copies

1. Load the document onto the scanner glass or into the document feeder.



2. On the control panel, press the **Black** or **Color** button to start copying.

Copy settings

Change copy quality

The following copy-quality settings are available:

- **Auto Select:** Use this setting when you are not concerned about the quality of the copy. This is the default setting.
- **Mixed:** Use this setting for documents that contain a mixture of text and graphics.
- **Text:** Use this setting for documents that contain mostly text.
- **Picture:** Use this setting for documents that contain mostly graphics.

1. Load the document onto the scanner glass or into the document feeder.



2. On the control panel, press the **Copy Menu**  button.
3. Use the arrow buttons to select the **Optimize** menu, and then press the **OK** button.
4. Use the arrow buttons to select the correct option, and then press the **OK** button.
5. Press the **Black** or **Color** button to start copying.

Check the scanner glass for dirt and smudges

Over time, specks of debris might collect on the scanner glass and white plastic backing, which can affect performance. Use the following procedure to clean the scanner glass and white plastic backing.

1. Use the power switch to turn off the product, and then unplug the power cord from the electrical socket.

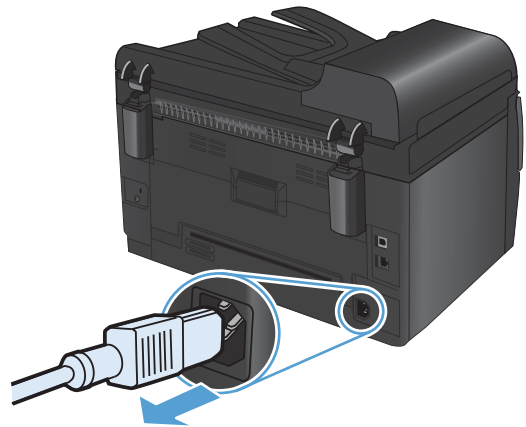

2. Open the scanner lid.
3. Clean the scanner glass, the document feeder scanning strip, and the white plastic backing with a soft cloth or sponge that has been moistened with nonabrasive glass cleaner.

CAUTION: Do not use abrasives, acetone, benzene, ammonia, ethyl alcohol, or carbon tetrachloride on any part of the product; these can damage the product. Do not place liquids directly on the glass or platen. They might seep and damage the product.



4. Dry the glass and white plastic with a chamois or a cellulose sponge to prevent spotting.
5. Plug in the product, and then use the power switch to turn on the product.

Adjust the lightness or darkness for copies

1. Load the document onto the scanner glass or into the document feeder.



2. On the control panel, press the **Lighter/Darker** button.
3. Use the arrow buttons to adjust the setting.
4. Press the **Black** or **Color** button to start copying.

Define custom copy settings

When you change the copy settings at the control panel, the custom settings remain in effect for approximately 2 minutes after the job completes, and then the product returns to the default settings. To immediately return to the defaults, press the Cancel **X** button.

Print or copy edge-to-edge

The product cannot print fully edge-to-edge. The maximum printing area is 203.2 x 347 mm (8 x 13.7 in), leaving a 4 mm (1/6 in) unprintable border around the page.

Considerations for printing or scanning documents with cropped edges:

- When the original is smaller than the output size, move the original 4 mm (1/6 in) away from the corner indicated by the icon on the scanner. Recopy or scan in this position.
- When the original is the size of the desired output, use the **Reduce/Enlarge** feature to reduce the image so the copy is not cropped.

Set the paper size and type for copying on special paper

1. On the control panel, press the **Copy Menu**  button.



2. Use the arrow buttons to select the **Paper** menu item, and then press the **OK** button.
3. From the list of paper sizes, select the name of the paper size that is in Tray 1, and then press the **OK** button..
4. From the list of paper types, select the name of the paper type that is in Tray 1, and then press the **OK** button..
5. Press the **Black** or **Color** button to start copying.

Restore copy default settings

1. On the control panel, press the **Copy Menu**  button.



2. Use the arrow buttons to select the **Restore Defaults** menu item, and then press the **OK** button.

Copy photos

 **NOTE:** Copy photos from the scanner glass, not from the document feeder.

1. Place the photo on the scanner glass, picture-side down at the upper left corner of the glass, and close the scanner lid.



2. On the control panel, press the **Copy Menu**  button.
3. Use the arrow buttons to select the **Optimize** menu item, and then press the **OK** button.
4. Use the arrow buttons to select the **Picture** option, and then press the **OK** button.
5. Press the **Black** or **Color** button to start copying.

Copy mixed size originals

Use the scanner glass to make copies of mixed size originals.

 **NOTE:** You can use the document feeder to copy mixed size originals only if the pages share a common dimension. For example, you can combine Letter and Legal size pages because they have the same width. Stack the pages so the top edges are even with each other and so the pages have the same width but varying lengths.

1. In Tray 1, load paper that is large enough for the largest page in the original document.
2. Place one page of the original document face down in the upper left corner of the scanner glass.



3. On the control panel, press the **Copy Menu**  button.
4. Use the arrow buttons to select the **Paper** menu item, and then press the **OK** button..
5. From the list of paper sizes, touch the name of the paper size that is loaded in Tray 1, and then press the **OK** button..
6. From the list of paper types, touch the name of the paper type that is loaded in Tray 1, and then press the **OK** button..
7. Press the **Black** or **Color** button to start copying.
8. Repeat these steps for each page.

Copy on both sides manually (duplex)

1. Load the first page of the document onto the scanner glass or into the document feeder.



2. On the control panel, press the **Black** or **Color** button to start copying.
3. Remove the printed copy from the output bin, rotate the stack 180 degrees, and then load the page with the printed side down into Tray 1.



4. Load the next page of the document onto the scanner glass or into the document feeder.

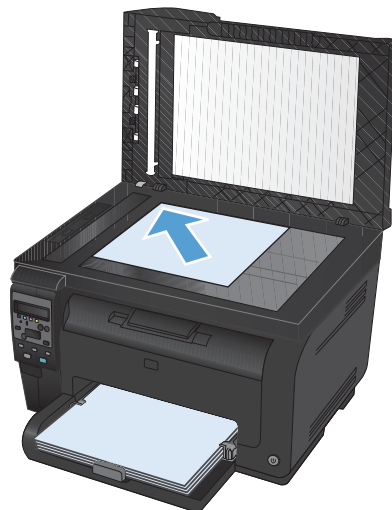

5. Press the **Black** or **Color** button to start copying.
6. Repeat these steps until the copy is complete.

11 Scan

- [Use scan functions](#)
- [Scan settings](#)

Use scan functions

Scan methods

Perform scan jobs in the following ways.

- Scan from the computer by using HP Scan software
- Scan from TWAIN-compliant or Windows Imaging Application (WIA)-compliant software

 **NOTE:** To learn about and use text-recognition software, install the Readiris program from the software CD. Text-recognition software is also known as optical character recognition (OCR) software.

Scan by using HP Scan software (Windows)

1. Double-click the **HP Scan** icon on the computer desktop.
2. Select a scanning shortcut, and adjust the settings if necessary.
3. Click **Scan**.

 **NOTE:** Click **Advanced Settings** to gain access to more options.

Click **Create New Shortcut** to create a customized set of settings and save it in the list of shortcuts.

Scan by using other software

The product is TWAIN-compliant and Windows Imaging Application (WIA)-compliant. The product works with Windows-based programs that support TWAIN-compliant or WIA-compliant scanning devices and with Macintosh-based programs that support TWAIN-compliant scanning devices.

While you are in a TWAIN-compliant or WIA-compliant program, you can gain access to the scanning feature and scan an image directly into the open program. For more information, see the Help file or the documentation that came with your TWAIN-compliant or WIA-compliant software program.

Scan from a TWAIN-compliant program

Generally, a software program is TWAIN-compliant if it has a command such as **Acquire**, **File Acquire**, **Scan**, **Import New Object**, **Insert from**, or **Scanner**. If you are unsure whether the program is compliant or you do not know what the command is called, see the software program Help or documentation.

When scanning from a TWAIN-compliant program, the HP Scan software program might start automatically. If the HP Scan program starts, you can make changes while previewing the image. If the program does not start automatically, the image goes to the TWAIN-compliant program immediately.

Start the scan from within the TWAIN-compliant program. See the software program Help or documentation for information about the commands and steps to use.

Scan from a WIA-compliant program

WIA is another way to scan an image directly into a software program. WIA uses Microsoft software to scan, instead of the HP Scan software.

Generally, a software program is WIA-compliant if it has a command such as **Picture/From Scanner or Camera** in the Insert or File menu. If you are unsure whether the program is WIA-compliant, see the software program Help or documentation.

Start the scan from within the WIA-compliant program. See the software program Help or documentation for information about the commands and steps to use.

-Or-

From the Windows control panel, in the **Cameras and Scanner** folder (located inside the **Hardware and Sound** folder for Windows Vista and Windows 7), double-click the product icon. This opens the standard Microsoft WIA Wizard, which enables you to scan to a file.

Scan by using optical character recognition (OCR) software

The Readiris OCR program is included on a separate CD that shipped with the product. To use the Readiris program, install it from the appropriate software CD, and then follow the instructions in the online Help.

Cancel a scan

To cancel a scan job, use one of the following procedures.

- On the product control panel, press the Cancel **X** button.
- Click the **Cancel** button in the on-screen dialog box.

Scan settings

Scanner resolution and color

If you are printing a scanned image, and the quality is not what you expected, you might have selected a resolution or color setting in the scanner software that does not match your needs. Resolution and color affect the following features of scanned images:

- Image clarity
- Texture of gradations (smooth or rough)
- Scan time
- File size

Scanning resolution is measured in pixels per inch (ppi).

 **NOTE:** Scanning ppi levels are not interchangeable with printing dpi (dots per inch) levels.

Color, grayscale, and black and white define the number of colors possible. You can adjust the scanner hardware resolution to up to 1200 ppi.

The resolution and color guidelines table lists simple tips that you can follow to meet your scanning needs.

 **NOTE:** Setting the resolution and color to a high value can create large files that take up disk space and slow the scanning process. Before setting the resolution and color, determine how you are going to use the scanned image.

Resolution and color guidelines

The following table describes the recommended resolution and color settings for different types of scan jobs.

 **NOTE:** The default resolution is 200 ppi.

Intended use	Recommended resolution	Recommended color settings
Fax	150 ppi	<ul style="list-style-type: none">• Black and White
E-mail	150 ppi	<ul style="list-style-type: none">• Black and White, if the image does not require smooth gradation• Grayscale, if the image requires smooth gradation• Color, if the image is in color
Edit text	300 ppi	<ul style="list-style-type: none">• Black and White
Print (graphics or text)	600 ppi for complex graphics, or if you want to significantly enlarge the document 300 ppi for normal graphics and text 150 ppi for photos	<ul style="list-style-type: none">• Black and White for text and line art• Grayscale for shaded or colored graphics and photos• Color, if the image is in color
Display on screen	75 ppi	<ul style="list-style-type: none">• Black and White for text• Grayscale for graphics and photos• Color, if the image is in color

Color

You can set the color values to the following settings when scanning.

Setting	Recommended use
Color	Use this setting for high-quality color photos or documents in which the color is important.
Black and White	Use this setting for text documents.
Grayscale	Use this setting when file size is an issue or when you want to scan a document or photograph quickly.

Scan quality

Over time, specks of debris might collect on the scanner glass and white plastic backing, which can affect performance. Use the following procedure to clean the scanner glass and white plastic backing.

1. Use the power switch to turn off the product, and then unplug the power cord from the electrical socket.

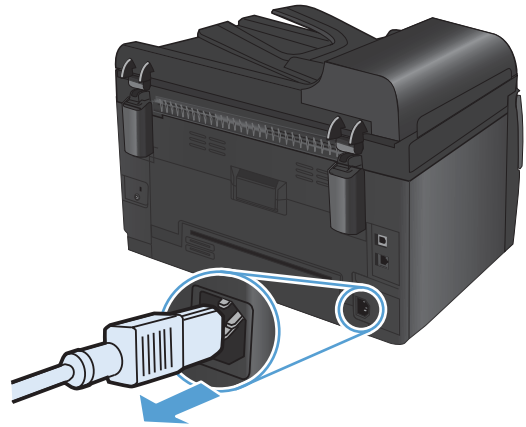

2. Open the scanner lid.
3. Clean the scanner glass, the document feeder scanning strip, and the white plastic backing with a soft cloth or sponge that has been moistened with nonabrasive glass cleaner.

CAUTION: Do not use abrasives, acetone, benzene, ammonia, ethyl alcohol, or carbon tetrachloride on any part of the product; these can damage the product. Do not place liquids directly on the glass or platen. They might seep and damage the product.



4. Dry the glass and white plastic with a chamois or a cellulose sponge to prevent spotting.
5. Plug in the product, and then use the power switch to turn on the product.

12 Manage and maintain the product

- [Print information pages](#)
- [Change the product settings from a computer](#)
- [Use HP Web Jetadmin software](#)
- [Product security features](#)
- [Economy settings](#)
- [Clean the product](#)
- [Product updates](#)

Print information pages

Information pages reside within the product memory. These pages help diagnose and solve problems with the product.

 **NOTE:** If the product language was not correctly set during installation, you can set the language manually so the information pages print in one of the supported languages. Change the language by using the **System Setup** menu on the control panel.

Menu item	Description
Demo Page	Prints a color page that demonstrates print quality.
Menu Structure	Prints a map of the control panel-menu layout. The active settings for each menu are listed.
Config Report	Prints a list of all the product settings. Includes network information when the product is connected to a network.
Supplies Status	Prints the status for each print cartridge, including the following information: <ul style="list-style-type: none">• Estimated percentage of cartridge life remaining• Approximate pages remaining• Part number• Number of pages printed• Information about ordering new HP print cartridges and recycling used HP print cartridges
Network Summary	Prints a list of all product network settings
Usage Page	Prints a page that lists PCL pages, PCL 6 pages, PS pages, pages that were jammed or mispicked in the product, monochrome (black and white) or color pages; and reports the page count HP LaserJet Pro 100 color MFP M175nw only: prints a page that lists the information above, and the monochrome (black and white) or color pages printed, number of memory cards inserted, number of PictBridge connections, and the PictBridge page count
PCL Font List	Prints a list of all the PCL fonts that are installed.
PS Font List	Prints a list of all the PostScript (PS) fonts that are installed
PCL6 Font List	Prints a list of all the PCL6 fonts that are installed
Color Usage Log	Prints a report that shows the user name, application name, and color usage information on a job-by-job basis
Service Page	Prints the service report
Diagnostics Page	Prints the calibration and color diagnostics pages
Print Quality	Prints a color test page which can be useful for diagnosing print quality defects.

1. Press Setup  button to open the menus.
2. Use the arrow buttons to select the **Reports** menu, and then press the **OK** button.

3. Use the arrow buttons to select the report you want to print, and then press the **OK** button to print the report.
4. Press the Cancel **X** button to exit the menus.

Change the product settings from a computer

 **NOTE:** This tool is available only if you performed a full installation when you installed the product.

To change the product settings from a computer, open the HP Device Toolbox.

1. Click the **Start** button, and then click the **Programs** item.
2. Click your HP product group, and then click the HP Device Toolbox item.

The table below describes the basic product settings.

Tab or section	Description
Status tab Provides product, status, and configuration information.	<ul style="list-style-type: none">• Device Status: Shows the product status and shows the life remaining of HP supplies, with 0% indicating that a supply is empty.• Supplies Status: Shows the approximate percent life remaining of HP supplies. Actual supply life remaining can vary. Consider having a replacement supply available to install when print quality is no longer acceptable. The supply does not need to be replaced unless the print quality is no longer acceptable.• Device Configuration: Shows the information found on the product configuration page.• Network Summary: Shows the information found on the product network configuration page.• Reports: Allows you to print the configuration and supplies status pages that the product generates.• Color Usage Log: Shows a log that shows the user name, application name, and color usage information on a job-by-job basis.• Event Log: Shows a list of all product events and errors.• Support button: Provides a link to the product support page. The Support button can be password-protected.• Shop for Supplies button: Provides a link to a page where you can order supplies for the product. The Shop for Supplies button can be password-protected.

Tab or section	Description
<p>System tab</p> <p>Provides the ability to configure the product from your computer.</p>	<ul style="list-style-type: none"> • Device Information: Provides basic product and company information. • Paper Setup: Allows you to change the paper-handling defaults for the product. • Print Quality: Allows you to change the print quality defaults for the product, including calibration settings. • Print Density: Allows you to change the contrasts, highlights, midtones, and shadows values for each supply. • Paper Types: Allows you to configure print modes that correspond to the media types that the product accepts. • System Setup: Allows you to change the system defaults for the product. • Service: Allows you to start the cleaning procedure on the product. • Product Security: Allows you to set or change the Administrator password. • Support button: Provides a link to the product support page. The Support button can be password-protected. • Shop for Supplies button: Provides a link to a page where you can order supplies for the product. The Shop for Supplies button can be password-protected. <p>NOTE: The System tab can be password-protected. If this product is on a network, always consult with the administrator before changing settings on this tab.</p>
<p>Print tab</p> <p>Provides the ability to change default print settings from your computer.</p>	<ul style="list-style-type: none"> • Printing: Change the default product print settings, such as number of copies and paper orientation. These are the same options that are available on the control panel. • PCL5c: View and change the PCL5c settings. • PostScript: View and change the PS settings.
<p>Networking tab</p> <p>Provides the ability to change network settings from your computer.</p>	<p>Network administrators can use this tab to control network-related settings for the product when it is connected to an IP-based network. This tab does not appear if the product is directly connected to a computer.</p>
<p>HP Web Services tab</p>	<p>Use this tab to set up and use various Web tools with the product.</p>

Use HP Web Jetadmin software

HP Web Jetadmin is a Web-based software solution for remotely installing, monitoring, and troubleshooting network-connected peripherals. Management is proactive, allowing network administrators the ability to resolve issues before users are affected. Download this free, enhanced-management software at www.hp.com/go/webjetadmin.

Device plug-ins can be installed into HP Web Jetadmin to provide support for specific product features. The HP Web Jetadmin software can automatically notify you when new plug-ins are available. On the **Product Update** page, follow the directions to automatically connect to the HP Web site and install the latest device plug-ins for your product.

 **NOTE:** Browsers must be Java™-enabled. Browsing from a Mac OS is not supported.

Product security features

The product supports security standards and recommended protocols that help you keep the product secure, protect critical information on your network, and simplify the way you monitor and maintain the product.

For in-depth information about HP's secure imaging and printing solutions, visit www.hp.com/go/secureprinting. The site provides links to white papers and FAQ documents about security features.

Lock the product

1. You can attach a security cable to the slot on the back of the product.

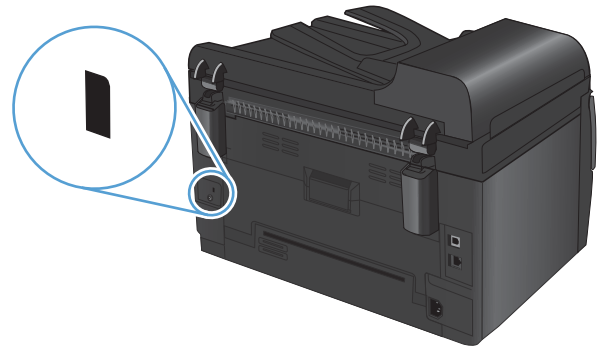

Assign a system password (network models only)

Assign a password for the product so that unauthorized users cannot change the product settings.

1. Open the HP Device Toolbox.
2. Click the **System** tab.
3. On the left side of the window, click the **Product Security** menu.
4. Type the password in the **Password** box, and type it again in the **Confirm Password** box.
5. Click the **Apply** button. Make note of the password and store it in a safe place.

Economy settings

Sleep mode

The adjustable sleep mode feature reduces power consumption when the product has been inactive for an extended period. You can set the length of time before the product enters sleep mode.

 **NOTE:** This mode does not affect product warm-up time.

1. On the control panel, press the Setup  button.
2. Use the arrow buttons to select the **System Setup** menu, and then press the **OK** button.
3. Use the arrow buttons to select the **Energy Settings** menu, and then press the **OK** button.
4. Use the arrow buttons to select the **Sleep Delay** menu, and then press the **OK** button.
5. Use the arrow buttons to select a sleep delay time period, and then press the **OK** button.

Low power settings

Low power mode is an energy-saving feature of this product. After a user-specified time period (the low power delay period), the product automatically reduces its power consumption. The product returns to the Ready state when it receives a wake event.

Set the low power delay period

You can change how long the product remains idle before it enters low power mode.

1. On the control panel, press the Setup  button.
2. Use the arrow buttons to select the **System Setup** menu, and then press the **OK** button.
3. Use the arrow buttons to select the **Energy Settings** menu, and then press the **OK** button.
4. Use the arrow buttons to select the **Auto Power Down** menu, and then press the **OK** button.
5. Use the arrow buttons to select the **Auto-Off Delay** menu, and then press the **OK** button.
6. Use the arrow buttons to select a low power delay time period, and then press the **OK** button.

Set the wake events

You can select which events cause the product to return to the Ready state after being in low power mode.

1. On the control panel, press the Setup  button.
2. Use the arrow buttons to select the **System Setup** menu, and then press the **OK** button.
3. Use the arrow buttons to select the **Energy Settings** menu, and then press the **OK** button.
4. Use the arrow buttons to select the **Auto Power Down** menu, and then press the **OK** button.
5. Use the arrow buttons to select the **Wake Events** menu, and then press the **OK** button.
6. Use the arrow buttons to select the events that you want to return the product to the Ready state, and then press the **OK** button.

Archive print

Archive print produces output that is less susceptible to toner smearing and dusting. Use archive print to create documents that you want to preserve or archive.

1. On the control panel, press the Setup  button.
2. Use the arrow buttons to select the **Service** menu, and then press the **OK** button.
3. Use the arrow buttons to select the **Archive Print** item, select **On** or **Off**, and then press the **OK** button.

Clean the product

Clean the document feeder pickup rollers and separation pad

If the product document feeder experiences paper-handling problems, such as jams or multiple-page feeds, clean the document feeder rollers and separation pad.

1. Open the document feeder cover.

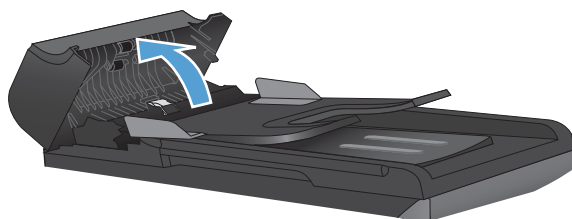

2. Use a moist, lint-free cloth to wipe both pickup rollers and the separation pad to remove dirt.

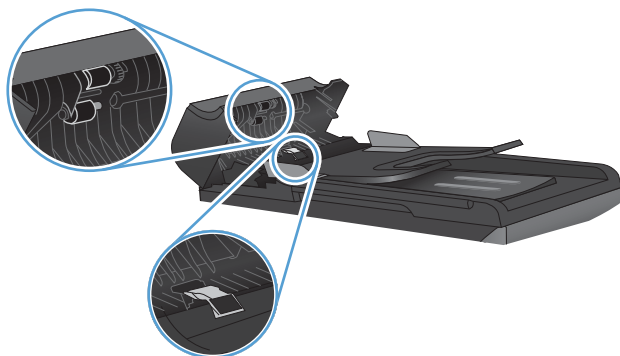

3. Close the document feeder cover.

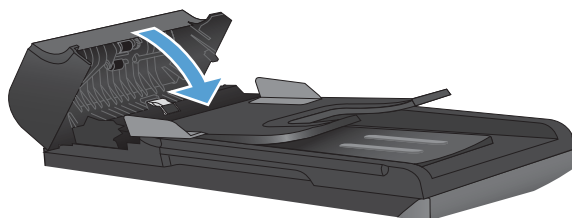

Clean the paper path

During the printing process, paper, toner, and dust particles can accumulate inside the product. Over time, this buildup can cause print-quality problems such as toner specks or smearing. This product has a cleaning mode that can correct and prevent these types of problems.

Specks

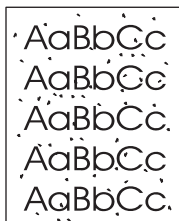

Smearing

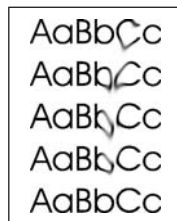

Clean the paper path from the product control panel

1. Press the Setup  button.
2. Use the arrow buttons to select the **Service** menu, and then press the **OK** button.
3. Use the arrow buttons to select the **Cleaning Page** item, and then press the **OK** button.
4. Load plain letter or A4 paper when you are prompted.
5. Press the **OK** button again to confirm and begin the cleaning process.

A page feeds through the product slowly. Discard the page when the process is completed.

Clean the exterior

Use a soft, damp, lint-free cloth to wipe dust, smudges, and stains off of the exterior of the device.

Product updates

Software and firmware updates and installation instructions for this product are available at www.hp.com/support/LJColorMFPM175. Click **Downloads and drivers**, click the operating system, and then select the download for the product.

13 Solve problems

- [Self help](#)
- [Solve problems checklist](#)
- [Factors that affect product performance](#)
- [Restore factory settings](#)
- [Interpret control panel messages](#)
- [Paper feeds incorrectly or becomes jammed](#)
- [Improve print quality](#)
- [The product does not print or it prints slowly](#)
- [Solve connectivity problems](#)
- [Solve wireless network problems](#)
- [Product software problems with Windows](#)
- [Solve common Mac problems](#)

Self help

In addition to the information in this guide, other sources are available that provide helpful information.

HP Help and Learn Center

The HP Help and Learn Center and other documentation are on the CD that came with the product or in the HP Program folder on your computer. The HP Help and Learn Center is a product help tool that provides easy access to product information, HP product Web support, troubleshooting, and regulatory and safety information.

Quick Reference Topics

Several Quick Reference Topics for this product are available at this Web site: www.hp.com/support/LJColorMFPM175

You can print these topics and keep them near the product. They are a handy reference for procedures that you perform frequently.

Solve problems checklist

Follow these steps when trying to solve a problem with the product.

- [Step 1: Make sure that the product is set up correctly](#)
- [Step 2: Check the cabling or wireless connection \(network models only\)](#)
- [Step 3: Check the control panel for error messages](#)
- [Step 4: Check the paper](#)
- [Step 5: Check the software](#)
- [Step 6: Test print functionality](#)
- [Step 7: Test copy functionality](#)
- [Step 8: Check the supplies](#)
- [Step 9: Try sending a print job from a computer](#)

Step 1: Make sure that the product is set up correctly

Make sure that the product is set up correctly.

1. Press the power button to turn on the product or to deactivate the Auto-Off mode.
2. Check the power-cable connections.
3. Make sure that the line voltage is correct for the product power configuration. (See the label that is inside the product front cover for voltage requirements.) If you are using a power strip and its voltage is not within specifications, plug the product directly into the wall. If it is already plugged into the wall, try a different outlet.
4. Make sure that the print cartridge is installed correctly.
5. If none of these measures restores power, contact HP Customer Care.

Step 2: Check the cabling or wireless connection (network models only)

1. Check the cable connection between the product and the computer. Make sure that the connection is secure.
2. Make sure that the cable itself is not faulty by using a different cable, if possible.

Step 3: Check the control panel for error messages

The control panel should indicate ready status. If an error message appears, resolve the error.

Step 4: Check the paper

1. Make sure that the paper that you are using meets specifications.
2. Make sure that the paper is loaded correctly in the input tray.

Step 5: Check the software

1. Make sure that the product software is installed correctly.
2. Verify that you have installed the printer driver for this product. Check the program to make sure that you are using the printer driver for this product.

Step 6: Test print functionality

1. Print a configuration page.
2. If the page does not print, verify that the input tray contains paper.
3. If the page jams in the product, clear the jam.

Step 7: Test copy functionality

1. Place the configuration page into the document feeder and make a copy. If paper does not feed smoothly through the document feeder, you might need to clean the document feeder. Also, verify that the paper meets HP specifications.
2. Place the configuration page onto the scanner glass and make a copy.
3. If the print quality on the copied pages is not acceptable, clean the scanner glass.

Step 8: Check the supplies

Print a supplies status page and check remaining life of the print cartridges and imaging drum.

Step 9: Try sending a print job from a computer

1. Try printing the job from another computer that has the product software installed.
2. Check the USB or network cable connection. Direct the product to the correct port, or reinstall the software, selecting the connection type that you are using.
3. If the print quality is unacceptable, verify that the print settings are correct for the media that you are using.

Factors that affect product performance

Several factors affect the time it takes to print a job:

- The use of special paper (such as transparencies, heavy paper, and custom-size paper)
- Print quality settings in the printer driver.
- Product processing and download time
- The complexity and size of graphics
- The speed of the computer you are using
- The USB or network connection
- The product I/O configuration

Restore factory settings

Restoring the factory-set defaults returns most of the settings to the factory defaults. It will not reset the page count or tray size, but it might reset the language. To restore the product to the factory-default settings, follow these steps.

1. On the product control panel, press the Setup  button.
2. Use the arrows buttons to select the **Service** menu, and then press the **OK** button.
3. Use the arrows buttons to select the **Restore Defaults** item, and then press the **OK** button.

The product automatically restarts.

Interpret control panel messages

The majority of the control-panel messages are intended to guide the user through typical operation. The control-panel messages indicate the status of the current operation, and include a page count on the second line of the display, if appropriate. When the product is receiving print data or scanning commands, control-panel messages indicate this status. In addition, alert messages, warning messages, and critical error messages indicate situations that might require some action.

Control panel message types

Alert and warning messages appear temporarily and might require you to acknowledge the message by pressing the **OK** button to resume or by pressing the **Cancel** **X** button to cancel the job. With certain warnings, the job might not complete or the print quality might be affected. If the alert or warning message is related to printing and the auto-continue feature is on, the product will attempt to resume the printing job after the warning has appeared for 10 seconds without acknowledgement.

Critical error messages can indicate some kind of failure. Turning off and then turning on the power might fix the problem. If a critical error persists, the product might require service.

 **NOTE:** Supplies status messages are listed and described in the “Print cartridges and imaging drum” chapter of this document.

Control panel messages

Control panel message	Description	Recommended action
49 Error Turn off then on	The product has experienced a firmware error.	<ol style="list-style-type: none">1. Turn off the power by using the power switch.2. If a surge protector is being used, remove it. Plug the product directly into the wall socket.3. Wait at least 30 seconds, and then turn on the power and wait for the product to initialize.4. If the error persists, contact HP. See www.hp.com/support/LJColorMFPM175 or the support flyer that came in the product box.
50.X Fuser Error Turn off then on	The product has experienced an internal hardware error.	<ol style="list-style-type: none">1. Turn off the power by using the power switch.2. If a surge protector is being used, remove it. Plug the product directly into the wall socket.3. Wait at least 10 minutes, and then turn on the power and wait for the product to initialize.4. If the error persists, contact HP. See www.hp.com/support/LJColorMFPM175 or the support flyer that came in the product box.

Control panel message	Description	Recommended action
52 Scanner Error Turn off then on	The product has experienced a scanner error.	<ol style="list-style-type: none"> 1. Turn off the power by using the power switch. 2. If a surge protector is being used, remove it. Plug the product directly into the wall socket. 3. Wait at least 30 seconds, and then turn on the power and wait for the product to initialize. 4. If the error persists, contact HP. See www.hp.com/support/LJColorMFPM175 or the support flyer that came in the product box.
79 Error Turn off then on	The product has experienced a firmware error	<ol style="list-style-type: none"> 1. Turn off the power by using the power switch. 2. If a surge protector is being used, remove it. Plug the product directly into the wall socket. 3. Wait at least 30 seconds, and then turn on the power and wait for the product to initialize. 4. If the error persists, contact HP. See www.hp.com/support/LJColorMFPM175 or the support flyer that came in the product box.
ADF door is open	The document feeder door is open.	Close the document feeder door.
Device error Press [OK] to continue	The product experienced an internal communication error.	<ol style="list-style-type: none"> 1. Turn off the power by using the power switch. 2. If a surge protector is being used, remove it. Plug the product directly into the wall socket. 3. Wait at least 30 seconds, and then turn on the power and wait for the product to initialize. 4. If the error persists, contact HP. See www.hp.com/support/LJColorMFPM175 or the support flyer that came in the product box.
Doc. feeder jam	The product has experienced a document feeder jam.	Clear the document feeder jam.

Control panel message	Description	Recommended action
Engine comm. Error	The product has experienced an internal hardware error.	<ol style="list-style-type: none"> 1. Turn off the power by using the power switch. 2. If a surge protector is being used, remove it. Plug the product directly into the wall socket. 3. Wait at least 30 seconds, and then turn on the power and wait for the product to initialize. 4. If the error persists, contact HP. See www.hp.com/support/LJColorMFPM175 or the support flyer that came in the product box.
Jam in <location> alternates with Open door and clear jam	The product has detected a jam in the location indicated in the message.	Clear the jam from the area indicated in the message, and then follow the control-panel instructions. Clearing some jams requires you to open the print cartridge door and remove the print cartridges.
Jam in output bin	The product has detected a paper jam in the output bin area.	Clear the jam from the area indicated in the message, and then follow the control panel instructions.
Jam in print paper path	The product has detected a paper path jam.	Clear the jam from the area indicated in the message, and then follow the control panel instructions.
Jam in Tray 1	The product has detected a jam in the input tray.	Clear the jam from the area indicated in the message, and then follow the control panel instructions.
Load tray 1 <TYPE>, <SIZE>	The tray is empty.	Load the tray with the correct type and size of paper.
Load tray 1 PLAIN <SIZE> alternates with Cleaning Page [OK] to start	The product is performing a cleaning cycle.	Load the tray with plain paper of the size indicated. Press the OK button to start the cleaning cycle.
Manual duplex alternates with Load tray 1 Press [OK]	The product is processing a manual duplex job.	To print the second side, place the pages face down in the tray with the top edge first.
Manual feed <SIZE>, <TYPE> alternates with Press [OK] for available media	The product is set for the manual feed mode.	Load the tray with the correct size and type of paper, or press the OK button to use the paper that is in the tray.

Control panel message	Description	Recommended action
Memory is low Press [OK]	The product does not have enough memory to process the job.	<p>If the product is processing other jobs, send the job again after those jobs have finished.</p> <p>If the problem continues, turn off the power by using the power switch, and then wait at least 30 seconds. Turn on the power and wait for the product to initialize.</p> <p>Break the job into smaller jobs that contain fewer pages.</p> <p>Resend the print job in raster mode.</p> <p>Set the "Print Data Optimization" setting in the print driver to "Optimize for Raster".</p>
Memory is low. Only 1 copy made. Press [OK] to continue	Product memory is too low to complete this job.	<p>Either copy fewer pages at a time or turn off collation.</p> <p>If the error persists, turn the product off, and then on.</p>
Misprint Press [OK]	The product has experienced an internal hardware error.	<ol style="list-style-type: none"> 1. Reprint the pages. 2. If the error persists, turn the product off, and then on. 3. Print the pages again. 4. If the error persists, contact HP. See www.hp.com/support/LJColorMFPM175 or the support flyer that came in the product box.
No paper pickup Press [OK]	The product has experienced an internal hardware error.	<ol style="list-style-type: none"> 1. Verify that the media was inserted far enough into the input tray. 2. Load the tray with the correct size of paper for your job. 3. Make sure the paper guides in the tray are adjusted correctly for the size of paper. Adjust the guides so they are touching the paper stack without bending it. 4. Check the product control panel to see if the product is waiting for you to acknowledge a prompt to feed the paper manually. Load paper, and continue. 5. If the error persists, contact HP. See www.hp.com/support/LJColorMFPM175 or the support flyer that came in the product box.

Control panel message	Description	Recommended action
Print failure	The product experienced an internal communication error.	<ol style="list-style-type: none"> 1. Turn off the power by using the power switch. 2. If a surge protector is being used, remove it. Plug the product directly into the wall socket. 3. Wait at least 30 seconds, and then turn on the power and wait for the product to initialize. 4. If the error persists, contact HP. See www.hp.com/support/LJColorMFPM175 or the support flyer that came in the product box.
Printing... Cool-down mode	The product is too hot to continue printing at normal speed.	<p>The product will pause longer between printed pages until it cools down.</p> <p>Overheating occurs when the product lacks air ventilation or when it prints continuously for a long period of time. To prevent overheating, place the product in a well-ventilated area, and divide very large print jobs into smaller print jobs.</p>
Remove shipping material from rear door	Shipping material remains on the back of the product.	Open the rear door and remove all shipping material.
Resend Upgrade	A firmware upgrade was interrupted.	Resend the upgrade file to the product.
Scanner Error X	The product experienced a general scanner error.	<ol style="list-style-type: none"> 1. Turn off the power by using the power switch. 2. If a surge protector is being used, remove it. Plug the product directly into the wall socket. 3. Wait at least 30 seconds, and then turn on the power and wait for the product to initialize. 4. If the error persists, contact HP. See www.hp.com/support/LJColorMFPM175 or the support flyer that came in the product box.
Sensor Error	The product experienced a paper sensor error.	<ol style="list-style-type: none"> 1. Turn off the power by using the power switch. 2. If a surge protector is being used, remove it. Plug the product directly into the wall socket. 3. Wait at least 30 seconds, and then turn on the power and wait for the product to initialize. 4. If the error persists, contact HP. See www.hp.com/support/LJColorMFPM175 or the support flyer that came in the product box.
Settings cleared	The product has cleared job settings.	Re-enter any appropriate job settings.

Control panel message	Description	Recommended action
Turn off. Reinstall fuser	The fuser needs to be replaced.	<p>Turn off the power by using the power switch.</p> <p>Wait at least 30 seconds, and then turn on the power and wait for the product to initialize.</p> <p>If the error persists, contact HP. See www.hp.com/support/LJColorMFPM175 or the support flyer that came in the product box.</p>
Unexpected Size in Tray 1	The paper in the tray does not match the size needed for the current print job.	Load paper that is the correct size, and verify that the tray is set to the correct size.

Paper feeds incorrectly or becomes jammed

The product does not pick up paper

If the product does not pick up paper from the tray, try these solutions.

1. Open the product and remove any jammed sheets of paper.
2. Load the tray with the correct size of paper for your job.
3. Make sure the paper guides in the tray are adjusted correctly for the size of paper. Adjust the guides so they are touching the paper stack without bending it.
4. Check the product control panel to see if the product is waiting for you to acknowledge a prompt to feed the paper manually. Load paper, and continue.

The product picks up multiple sheets of paper

If the product picks up multiple sheets of paper from the tray, try these solutions.

1. Remove the stack of paper from the tray and flex it, rotate it 180 degrees, and flip it over. *Do not fan the paper.* Return the stack of paper to the tray.
2. Use only paper that meets HP specifications for this product.
3. Use paper that is not wrinkled, folded, or damaged. If necessary, use paper from a different package.
4. Make sure the tray is not overfilled. If it is, remove the entire stack of paper from the tray, straighten the stack, and then return some of the paper to the tray.
5. Make sure the paper guides in the tray are adjusted correctly for the size of paper. Adjust the guides so they are touching the paper stack without bending it.

Prevent paper jams

To reduce the number of paper jams, try these solutions.

1. Use only paper that meets HP specifications for this product.
2. Use paper that is not wrinkled, folded, or damaged. If necessary, use paper from a different package.
3. Use paper that has not previously been printed or copied on.
4. Make sure the tray is not overfilled. If it is, remove the entire stack of paper from the tray, straighten the stack, and then return some of the paper to the tray.
5. Make sure the paper guides in the tray are adjusted correctly for the size of paper. Adjust the guides so they are touching the paper stack without bending it.
6. If you are printing on heavy, embossed, or perforated paper, use the manual feed feature and feed sheets one at a time.

Clear jams

When clearing jams, be very careful not to tear jammed paper. If a small piece of paper remains in the product, it could cause additional jams.

 **NOTE:** After removing the jammed paper, open and close a product door to clear the control panel jam message.

Jam locations

Jams can occur in these locations:

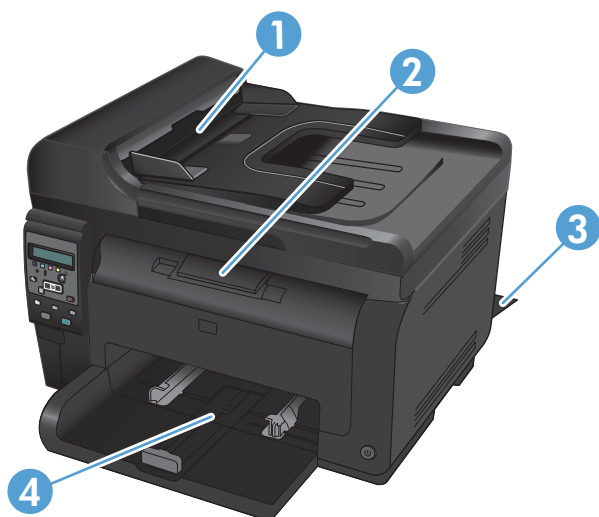

1	Document feeder
2	Output bin
3	Rear door
4	Input tray

Loose toner might remain in the product after a jam. This problem typically resolves itself after a few sheets have been printed.

Clear jams from the document feeder

1. Open the document feeder cover.



2. Lift the document feeder mechanism, and gently pull the jammed paper out.



3. Close the document feeder cover.



Clear jams from the input tray

1. Remove the paper from the input tray.



2. With both hands, grasp the paper, and carefully pull it free from the product.



3. Open and close the print cartridge door to reset the product.

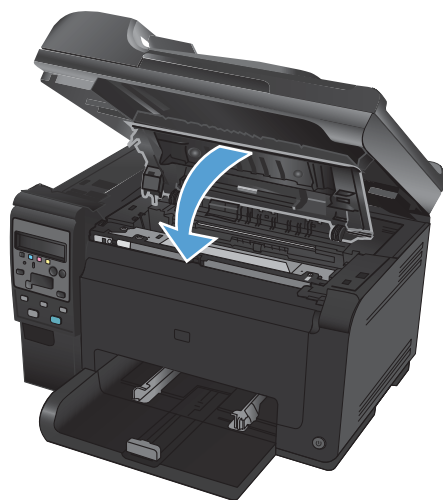

Clear jams from the output bin

△ **CAUTION:** Do not use sharp objects, such as tweezers or needle-nose pliers, to remove jams. Damage caused by sharp objects will not be covered by the warranty.

1. With both hands, grasp the paper, and carefully pull it free from the product.



Clear jams from the rear door

1. Open the rear door.

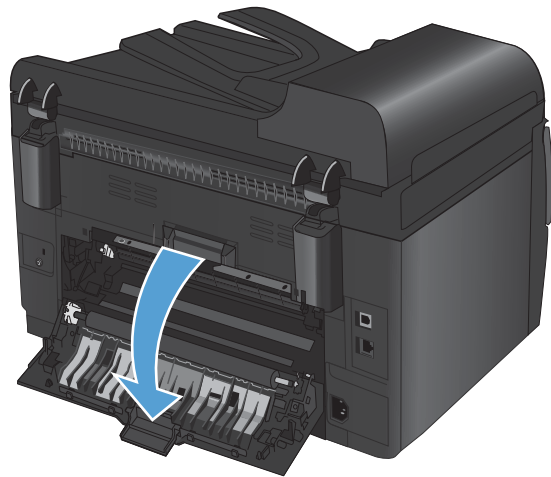

2. With both hands, grasp the paper, and carefully pull it free from the product.

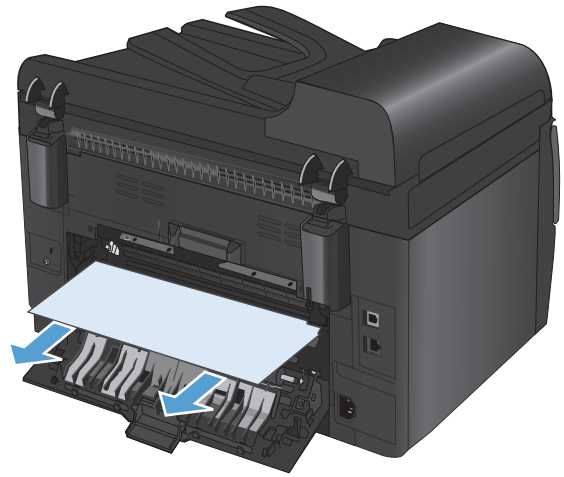

3. Close the rear door.

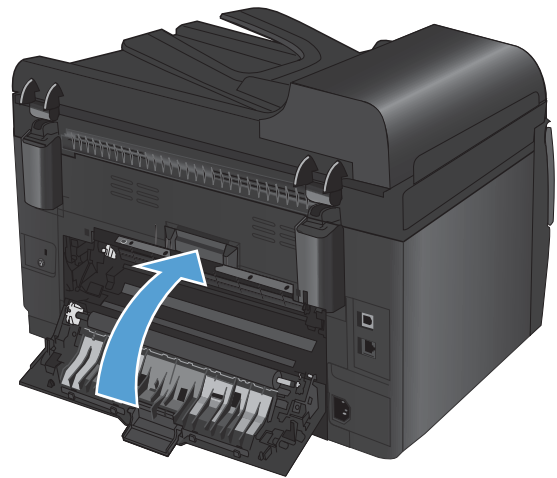

Improve print quality

You can prevent most print-quality problems by following these guidelines.

- [Use the correct paper type setting in the printer driver](#)
- [Adjust color settings in the printer driver](#)
- [Use paper that meets HP specifications](#)
- [Print a cleaning page](#)
- [Calibrate the product to align the colors](#)
- [Use the printer driver that best meets your printing needs](#)

Use the correct paper type setting in the printer driver

Check the paper type setting if you are having any of the following problems:

- Toner is smearing on the printed pages.
- Repeated marks occur on the printed pages.
- Printed pages are curled.
- Toner flakes off the printed pages.
- Printed pages have small unprinted areas.

Change the paper type setting for Windows

1. On the **File** menu in the software program, click **Print**.
2. Select the product, and then click the **Properties** or **Preferences** button.
3. Click the **Paper/Quality** tab.
4. From the **Type is** drop-down list, click the **More...** option.
5. Expand the list of **Type is** options.
6. Expand each category of paper types until you find the paper type that you are using.
7. Select the option for the type of paper you are using, and click the **OK** button.

Change the paper type setting for Mac

1. On the **File** menu in the software program, click the **Print** option.
2. In the **Copies & Pages** menu, click the **Page Setup** button.
3. Select a size from the **Paper Size** drop-down list, and then click the **OK** button.
4. Open the **Finishing** menu.
5. Select a type from the **Media-type** drop-down list.
6. Click the **Print** button.

Adjust color settings in the printer driver

Change the color theme for a print job

1. On the **File** menu in the software program, click **Print**.
2. Click **Properties** or **Preferences**.
3. Click the **Color** tab.
4. Select a color theme from the **Color Themes** drop-down list.

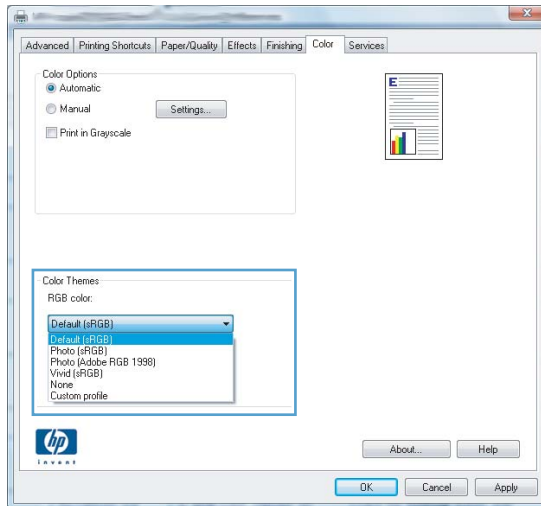

- **Default (sRGB)**: This theme sets the product to print RGB data in raw device mode. When using this theme, manage color in the software program or in the operating system for correct rendering.
- **Vivid**: The product increases the color saturation in the midtones. Use this theme when printing business graphics.
- **Photo**: The product interprets RGB color as if it were printed as a photograph using a digital mini lab. The product renders deeper, more saturated colors differently than with the Default (sRGB) theme. Use this theme when printing photos.
- **Photo (Adobe RGB 1998)**: Use this theme with printing digital photos that use the AdobeRGB color space rather than sRGB. Turn off color management in the software program when using this theme.
- **None**

Change the color options

Change the color options settings for the current print job from the color tab of the printer driver.

1. On the **File** menu in the software program, click **Print**.
2. Click **Properties** or **Preferences**.
3. Click the **Color** tab.

4. Click the **Automatic** or **Manual** setting.

- **Automatic** setting: Select this setting for most color print jobs
- **Manual** setting: Select this setting to adjust the color settings independent from other settings.

 **NOTE:** Changing color settings manually can impact output. HP recommends that only color graphics experts change these settings.

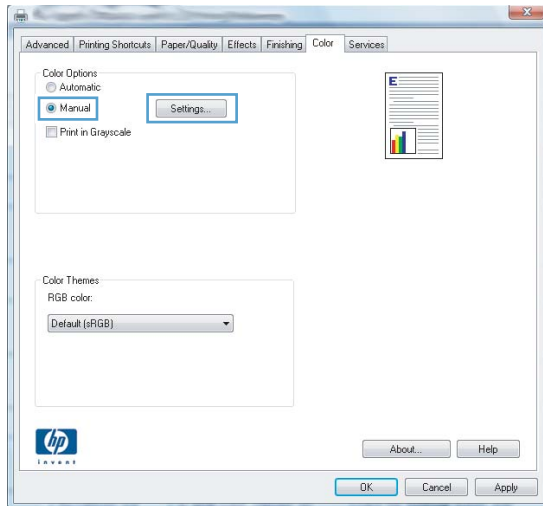

5. Click the **Print in Grayscale** option to print a color document in black and white. Use this option to print color documents for photocopying or faxing.
6. Click the **OK** button.

Use paper that meets HP specifications

Use different paper if you are having any of the following problems:

- The printing is too light or seems faded in areas.
- Specks of toner are on the printed pages.
- Toner is smearing on the printed pages.
- Printed characters seem misformed.
- Printed pages are curled.

Always use a paper type and weight that this product supports. In addition, follow these guidelines when selecting paper:

- Use paper that is of good quality and free of cuts, nicks, tears, spots, loose particles, dust, wrinkles, voids, staples, and curled or bent edges.
- Use paper that has not been previously printed on.
- Use paper that is designed for use in laser printers. Do not use paper that is designed only for use in Inkjet printers.
- Use paper that is not too rough. Using smoother paper generally results in better print quality.

Print a cleaning page

Print a cleaning page to remove dust and excess toner from the paper path if you are having any of the following problems:

- Specks of toner are on the printed pages.
- Toner is smearing on the printed pages.
- Repeated marks occur on the printed pages.

Use the following procedure to print a cleaning page.

1. On the product control panel, press the Setup  button.
2. Use the arrow buttons to select the **Service** menu, and then press the **OK** button.
3. Use the arrow buttons to select the **Cleaning Page** item, and then press the **OK** button.
4. Load plain letter or A4 paper when you are prompted.
5. Press the **OK** button to begin the cleaning process.

A page feeds through the product slowly. Discard the page when the process is completed.

Calibrate the product to align the colors

If the printed output has colored shadows, blurry graphics, or areas that have poor color, you might need to calibrate the product to align the colors. Print the Diagnostics Page from the Reports menu on the control panel to check the color alignment. If the blocks of color on that page are not aligned with each other, you need to calibrate the product.

1. On the product control panel, open the **System Setup** menu.
2. Open the **Print Quality** menu, and select the **Calibrate Color** item.
3. Select the **Calibrate Now** option.

Use the printer driver that best meets your printing needs

You might need to use a different printer driver if the printed page has unexpected lines in graphics, missing text, missing graphics, incorrect formatting, or substituted fonts.

HP PCL 6 driver	<ul style="list-style-type: none">• Provided as the default driver. This driver is automatically installed unless you select a different one.• Recommended for all Windows environments• Provides the overall best speed, print quality, and product-feature support for most users• Developed to align with the Windows Graphic Device Interface (GDI) for the best speed in Windows environments• Might not be fully compatible with third-party and custom software programs that are based on PCL 5
------------------------	---

HP UPD PS driver

- Recommended for printing with Adobe® software programs or with other highly graphics-intensive software programs
- Provides support for printing from postscript emulation needs, or for postscript flash font support

HP UPD PCL 5

- Recommended for general office printing in Windows environments
 - Compatible with previous PCL versions and older HP LaserJet products
 - The best choice for printing from third-party or custom software programs
 - The best choice when operating with mixed environments, which require the product to be set to PCL 5 (UNIX, Linux, mainframe)
 - Designed for use in corporate Windows environments to provide a single driver for use with multiple printer models
 - Preferred when printing to multiple printer models from a mobile Windows computer
-

Download additional printer drivers from this Web site: www.hp.com/support/LJColorMFPM175.

The product does not print or it prints slowly

The product does not print

If the product does not print at all, try the following solutions.

1. Make sure the product is turned on and that the control panel indicates it is ready.
 - If the control panel does not indicate the product is ready, turn off the product and disconnect the power cable from the product. Wait 30 seconds, and then reconnect the power cord and turn on the product. Wait for the product to initialize.
 - If the control panel indicates the product is ready, print a configuration page. If successful, try sending the job again.
2. If the control panel indicates the product has an error, resolve the error and then try sending the job again.
3. Make sure the cables are all connected correctly. If the product is connected to a network, check the following items:
 - Check the light next to the network connection on the product. If the network is active, the light is green.
 - Make sure that you are using a network cable and not a phone cord to connect to the network.
 - Make sure the network router, hub, or switch is turned on and that it is working correctly.
4. Install the HP software from the CD that came with the product. Using generic printer drivers can cause delays clearing jobs from the print queue.
5. If you are using a personal firewall system on the computer, it might be blocking communication with the product. Try temporarily disabling the firewall to see if it is the source of the problem.
6. If your computer or the product is connected to a wireless network, low signal quality or interference might be delaying print jobs.

The product prints slowly

If the product prints, but it seems slow, try the following solutions.

1. Make sure the computer meets the minimum specifications for this product. For a list of specifications, go to this Web site: www.hp.com/support/LJColorMFPM175.
2. When you configure the product to print on some paper types, such as heavy paper, the product prints more slowly so it can correctly fuse the toner to the paper. If the paper type setting is not correct for the type of paper you are using, change the setting to the correct paper type.
3. When you configure the product to print at a high level of print quality, the product prints more slowly. Change the print quality settings to change the print speed.
4. If your computer or the product is connected to a wireless network, low signal quality or interference might be delaying print jobs.
5. The product might be in cool-down mode. Wait for the product to cool.

Solve connectivity problems

Solve direct-connect problems

If you have connected the product directly to a computer, check the cable.

- Verify that the cable is connected to the computer and to the product.
- Verify that the cable is not longer than 5 m (16.4 ft). Try using a shorter cable.
- Verify that the cable is working correctly by connecting it to another product. Replace the cable if necessary.

Solve network problems

Check the following items to verify that the product is communicating with the network. Before beginning, print a configuration page from the product control panel and locate the product IP address that is listed on this page.

- [Poor physical connection](#)
- [The computer is using the incorrect IP address for the product](#)
- [The computer is unable to communicate with the product](#)
- [The product is using incorrect link and duplex settings for the network](#)
- [New software programs might be causing compatibility problems](#)
- [The computer or workstation might be set up incorrectly](#)
- [The product is disabled, or other network settings are incorrect](#)

Poor physical connection

1. Verify that the product is attached to the correct network port using a cable of the correct length.
2. Verify that cable connections are secure.
3. Look at the network port connection on the back of the product, and verify that the amber activity light and the green link-status light are lit.
4. If the problem continues, try a different cable or port on the hub.

The computer is using the incorrect IP address for the product

1. Open the printer properties and click the **Ports** tab. Verify that the current IP address for the product is selected. The product IP address is listed on the product configuration page.
2. If you installed the product using the HP standard TCP/IP port, select the box labeled **Always print to this printer, even if its IP address changes**.
3. If you installed the product using a Microsoft standard TCP/IP port, use the hostname instead of the IP address.
4. If the IP address is correct, delete the product and then add it again.

The computer is unable to communicate with the product

1. Test network communication by pinging the network.
 - a. Open a command-line prompt on your computer. For Windows, click **Start**, click **Run**, and then type `cmd`.
 - b. Type `ping` followed by the IP address for your product.
 - c. If the window displays round-trip times, the network is working.
2. If the ping command failed, verify that the network hubs are on, and then verify that the network settings, the product, and the computer are all configured for the same network.

The product is using incorrect link and duplex settings for the network

Hewlett-Packard recommends leaving this setting in automatic mode (the default setting). If you change these settings, you must also change them for your network.

New software programs might be causing compatibility problems

Verify that any new software programs are correctly installed and that they use the correct printer driver.

The computer or workstation might be set up incorrectly

1. Check the network drivers, printer drivers, and the network redirection.
2. Verify that the operating system is configured correctly.

The product is disabled, or other network settings are incorrect

1. Review the configuration page to check the status of the network protocol. Enable it if necessary.
2. Reconfigure the network settings if necessary.

Solve wireless network problems

Wireless connectivity checklist

- Verify that the network cable is not connected.
- Verify that the product and the wireless router are turned on and have power. Also make sure that the wireless radio in the product is turned on.
- Verify that the service set identifier (SSID) is correct. Print a configuration page to determine the SSID. If you are not sure the SSID is correct, run the wireless setup again.
- With secured networks, verify that the security information is correct. If the security information is incorrect, run the wireless setup again.
- If the wireless network is working correctly, try accessing other computers on the wireless network. If the network has Internet access, try connecting to the Internet over a wireless connection.
- Verify that the encryption method (AES or TKIP) is the same for the product as it is for the wireless access point (on networks using WPA security).
- Verify that the product is within the range of the wireless network. For most networks, the product must be within 30 m (100 ft) of the wireless access point (wireless router).
- Verify that obstacles do not block the wireless signal. Remove any large metal objects between the access point and the product. Make sure poles, walls, or support columns containing metal or concrete do not separate the product and wireless access point.
- Verify that the product is located away from electronic devices that might interfere with the wireless signal. Many devices can interfere with the wireless signal including motors, cordless phones, security system cameras, other wireless networks, and some Bluetooth devices.
- Verify that the printer driver is installed on the computer.
- Verify that you have selected the correct printer port.
- Verify that the computer and product connect to the same wireless network.

The product does not print after the wireless configuration completes

1. Make sure that the product is turned on and in the ready state.
2. Turn off any third-party firewalls on your computer.
3. Make sure that the wireless network is working correctly.
4. Make sure that your computer is working correctly. If necessary, restart the computer.

The product does not print, and the computer has a third-party firewall installed

1. Update the firewall with the most recent update available from the manufacturer.
2. If programs request firewall access when you install the product or try to print, make sure you allow the programs to run.
3. Temporarily turn off the firewall, and then install the wireless product on the computer. Enable the firewall when you have completed the wireless installation.

The wireless connection does not work after moving the wireless router or product

Make sure that the router or product connects to the same network that your computer connects to.

1. Print a configuration page.
2. Compare the service set identifier (SSID) on the configuration page to the SSID in the printer configuration for the computer.
3. If the numbers are not the same, the devices are not connecting to the same network. Reconfigure the wireless setup for the product.

Cannot connect more computers to the wireless product

1. Make sure that the other computers are within the wireless range and that no obstacles block the signal. For most networks, the wireless range is within 30 m (100 ft) of the wireless access point.
2. Make sure that the product is turned on and in the ready state.
3. Turn off any third-party firewalls on your computer.
4. Make sure that the wireless network is working correctly.
5. Make sure that your computer is working correctly. If necessary, restart the computer.

The wireless product loses communication when connected to a VPN

- Typically, you cannot connect to a VPN and other networks at the same time.

The network does not appear in the wireless networks list

- Make sure the wireless router is turned on and has power.
- The network might be hidden. However, you can still connect to a hidden network.

The wireless network is not functioning

1. Make sure that the network cable is not connected.
2. To verify if the network has lost communication, try connecting other devices to the network.

3. Test network communication by pinging the network.
 - a. Open a command-line prompt on your computer. For Windows, click **Start**, click **Run**, and then type `cmd`.
 - b. Type `ping` followed by the router IP address.

For Mac, open the Network Utility, and then supply the IP address in the correct field in the **Ping** pane.
 - c. If the window displays round-trip times, the network is working.
4. Make sure that the router or product connects to the same network that the computer connects to.
 - a. Print a configuration page.
 - b. Compare the service set identifier (SSID) on the configuration report to the SSID in the printer configuration for the computer.
 - c. If the numbers are not the same, the devices are not connecting to the same network. Reconfigure the wireless setup for the product.

Product software problems with Windows

Problem	Solution
A printer driver for the product is not visible in the Printer folder	<ul style="list-style-type: none">• Restart the computer to restart the spooler process. If the spooler has crashed, no printer drivers will appear in the Printers folder.• Reinstall the product software. NOTE: Close any software programs that are running. To close a software program that has an icon in the system tray, right-click the icon, and then select the Close or Disable option.• Try plugging the USB cable into a different USB port on the computer.
An error message was displayed during the software installation	<ul style="list-style-type: none">• Reinstall the product software. NOTE: Close any software programs that are running. To close a software program that has an icon in the task bar, right-click the icon, and then select the Close or Disable option.• Check the amount of free space on the drive where you are installing the product software. If necessary, free up as much space as you can, and reinstall the product software.• If necessary, run the Disk Defragmenter, and then reinstall the product software.
The product is in Ready mode, but nothing prints	<ul style="list-style-type: none">• Print a configuration page, and verify the product functionality.• Restart the computer from which you are trying to print.• Verify that all of the cables are correctly seated and within specifications. This includes the USB and power cables. Try a new cable.• If trying to connect through a wireless connection, make sure that the network cable is not connected.

Solve common Mac problems

- [The printer driver is not listed in the Print & Fax list](#)
- [The product name does not appear in the product list in the Print & Fax list](#)
- [The printer driver does not automatically set up the selected product in the Print & Fax list](#)
- [A print job was not sent to the product that you wanted](#)
- [When connected with a USB cable, the product does not appear in the Print & Fax list after the driver is selected.](#)
- [You are using a generic printer driver when using a USB connection](#)

The printer driver is not listed in the Print & Fax list

1. Make sure that the product .GZ file is in the following hard-drive folder: `Library/Printers/PPDs/Contents/Resources`. If necessary, reinstall the software.
2. If the GZ file is in the folder, the PPD file might be corrupt. Delete the file and then reinstall the software.

The product name does not appear in the product list in the Print & Fax list

1. Make sure that the cables are connected correctly and the product is on.
2. Print a configuration page to check the product name. Verify that the name on the configuration page matches the product name in the Print & Fax list.
3. Replace the USB or network cable with a high-quality cable.

The printer driver does not automatically set up the selected product in the Print & Fax list

1. Make sure that the cables are connected correctly and the product is on.
2. Make sure that the product .GZ file is in the following hard-drive folder: `Library/Printers/PPDs/Contents/Resources`. If necessary, reinstall the software.
3. If the GZ file is in the folder, the PPD file might be corrupt. Delete the file and then reinstall the software.
4. Replace the USB or network cable with a high-quality cable.

A print job was not sent to the product that you wanted

1. Open the print queue and restart the print job.
2. Another product with the same or similar name might have received your print job. Print a configuration page to check the product name. Verify that the name on the configuration page matches the product name in the Print & Fax list.

When connected with a USB cable, the product does not appear in the Print & Fax list after the driver is selected.

Software troubleshooting

- ▲ Make sure that your Mac operating system is Mac OS X 10.5 or later.

Hardware troubleshooting

1. Make sure that the product is turned on.
2. Make sure that the USB cable is connected correctly.
3. Make sure that you are using the appropriate high-speed USB cable.
4. Make sure that you do not have too many USB devices drawing power from the chain. Disconnect all of the devices from the chain, and connect the cable directly to the USB port on the computer
5. Check to see if more than two non-powered USB hubs are connected in a row on the chain. Disconnect all of the devices from the chain, and then connect the cable directly to the USB port on the computer.

 **NOTE:** The iMac keyboard is a non-powered USB hub.

You are using a generic printer driver when using a USB connection

If you connected the USB cable before you installed the software, you might be using a generic printer driver instead of the driver for this product.

1. Delete the generic printer driver.
2. Reinstall the software from the product CD. Do not connect the USB cable until the software installation program prompts you.
3. If multiple printers are installed, make sure that you have selected the correct printer in the **Format For** drop-down menu in the **Print** dialog box.

A Supplies and accessories

- [Order parts, accessories, and supplies](#)
- [Part numbers](#)

Order parts, accessories, and supplies

HP original print cartridge, imaging drum, and paper	www.hp.com/go/suresupply
Order genuine HP parts or accessories	www.hp.com/buy/parts
Order through service or support providers	Contact an HP-authorized service or support provider.

Part numbers

The following list of accessories was current at the time of printing. Ordering information and availability of the accessories might change during the life of the product.

Print cartridges

Item	Cartridge number	Color	Part number
HP LaserJet print cartridge	126A	Black	CE310A
		Cyan	CE311A
		Yellow	CE312A
		Magenta	CE313A

Imaging drums

Item	Description	Part number
Imaging drum	Imaging drum	CE314A

 **NOTE:** The imaging drum installed in this product is covered by the product warranty. Replacement imaging drums have a one-year limited warranty from the date of installation. The imaging drum installation date displays on the supplies status page. HP's Premium Protection Warranty applies only to the print cartridges for the product.

Cables and interfaces

Item	Description	Part number
USB 2.0 printer cable	(2-meter standard) A-to-B cable	C6518A

B Service and support

- [Hewlett-Packard limited warranty statement](#)
- [HP's Premium Protection Warranty: LaserJet print cartridge limited warranty statement](#)
- [HP's LaserJet imaging drum limited warranty statement for replacement imaging drums](#)
- [Data stored on the print cartridge and imaging drum](#)
- [End User License Agreement](#)
- [OpenSSL](#)
- [Customer support](#)
- [Repack the product](#)

Hewlett-Packard limited warranty statement

HP PRODUCT	DURATION OF LIMITED WARRANTY
HP LaserJet Pro 100 color MFP M175a, M175nw	One-year product exchange
Imaging drum, CE314A, ships with product	One-year product exchange

HP warrants to you, the end-user customer, that HP hardware and accessories will be free from defects in materials and workmanship after the date of purchase, for the period specified above. If HP receives notice of such defects during the warranty period, HP will, at its option, either repair or replace products which prove to be defective. Replacement products may be either new or equivalent in performance to new.

HP warrants to you that HP software will not fail to execute its programming instructions after the date of purchase, for the period specified above, due to defects in material and workmanship when properly installed and used. If HP receives notice of such defects during the warranty period, HP will replace software which does not execute its programming instructions due to such defects.

HP does not warrant that the operation of HP products will be uninterrupted or error free. If HP is unable, within a reasonable time, to repair or replace any product to a condition as warranted, you will be entitled to a refund of the purchase price upon prompt return of the product.

HP products may contain remanufactured parts equivalent to new in performance or may have been subject to incidental use.

Warranty does not apply to defects resulting from (a) improper or inadequate maintenance or calibration, (b) software, interfacing, parts or supplies not supplied by HP, (c) unauthorized modification or misuse, (d) operation outside of the published environmental specifications for the product, or (e) improper site preparation or maintenance.

TO THE EXTENT ALLOWED BY LOCAL LAW, THE ABOVE WARRANTIES ARE EXCLUSIVE AND NO OTHER WARRANTY OR CONDITION, WHETHER WRITTEN OR ORAL, IS EXPRESSED OR IMPLIED AND HP SPECIFICALLY DISCLAIMS ANY IMPLIED WARRANTIES OR CONDITIONS OF MERCHANTABILITY, SATISFACTORY QUALITY, AND FITNESS FOR A PARTICULAR PURPOSE. Some countries/regions, states or provinces do not allow limitations on the duration of an implied warranty, so the above limitation or exclusion might not apply to you. This warranty gives you specific legal rights and you might also have other rights that vary from country/region to country/region, state to state, or province to province.

HP's limited warranty is valid in any country/region or locality where HP has a support presence for this product and where HP has marketed this product. The level of warranty service you receive may vary according to local standards. HP will not alter form, fit or function of the product to make it operate in a country/region for which it was never intended to function for legal or regulatory reasons.

TO THE EXTENT ALLOWED BY LOCAL LAW, THE REMEDIES IN THIS WARRANTY STATEMENT ARE YOUR SOLE AND EXCLUSIVE REMEDIES. EXCEPT AS INDICATED ABOVE, IN NO EVENT WILL HP OR ITS SUPPLIERS BE LIABLE FOR LOSS OF DATA OR FOR DIRECT, SPECIAL, INCIDENTAL, CONSEQUENTIAL (INCLUDING LOST PROFIT OR DATA), OR OTHER DAMAGE, WHETHER BASED IN CONTRACT, TORT, OR OTHERWISE. Some countries/regions, states or provinces do not allow the exclusion or limitation of incidental or consequential damages, so the above limitation or exclusion may not apply to you.

THE WARRANTY TERMS CONTAINED IN THIS STATEMENT, EXCEPT TO THE EXTENT LAWFULLY PERMITTED, DO NOT EXCLUDE, RESTRICT OR MODIFY AND ARE IN ADDITION

TO THE MANDATORY STATUTORY RIGHTS APPLICABLE TO THE SALE OF THIS PRODUCT
TO YOU.

HP's Premium Protection Warranty: LaserJet print cartridge limited warranty statement

This HP product is warranted to be free from defects in materials and workmanship.

This warranty does not apply to products that (a) have been refilled, refurbished, remanufactured or tampered with in any way, (b) experience problems resulting from misuse, improper storage, or operation outside of the published environmental specifications for the printer product or (c) exhibit wear from ordinary use.

To obtain warranty service, please return the product to place of purchase (with a written description of the problem and print samples) or contact HP customer support. At HP's option, HP will either replace products that prove to be defective or refund your purchase price.

TO THE EXTENT ALLOWED BY LOCAL LAW, THE ABOVE WARRANTY IS EXCLUSIVE AND NO OTHER WARRANTY OR CONDITION, WHETHER WRITTEN OR ORAL, IS EXPRESSED OR IMPLIED AND HP SPECIFICALLY DISCLAIMS ANY IMPLIED WARRANTIES OR CONDITIONS OF MERCHANTABILITY, SATISFACTORY QUALITY, AND FITNESS FOR A PARTICULAR PURPOSE.

TO THE EXTENT ALLOWED BY LOCAL LAW, IN NO EVENT WILL HP OR ITS SUPPLIERS BE LIABLE FOR DIRECT, SPECIAL, INCIDENTAL, CONSEQUENTIAL (INCLUDING LOST PROFIT OR DATA), OR OTHER DAMAGE, WHETHER BASED IN CONTRACT, TORT, OR OTHERWISE.

THE WARRANTY TERMS CONTAINED IN THIS STATEMENT, EXCEPT TO THE EXTENT LAWFULLY PERMITTED, DO NOT EXCLUDE, RESTRICT OR MODIFY AND ARE IN ADDITION TO THE MANDATORY STATUTORY RIGHTS APPLICABLE TO THE SALE OF THIS PRODUCT TO YOU.

HP's LaserJet imaging drum limited warranty statement for replacement imaging drums

This HP Product is warranted to be free from defects in materials and workmanship for one-year from installation. This warranty does not apply to imaging drums that (a) have been refurbished, remanufactured or tampered with in any way, (b) experience problems resulting from misuse, improper storage, or operation outside of the published environmental specifications for the printer product or (c) exhibit wear from ordinary use.

To obtain warranty service, please return the product to place of purchase (with a written description of the problem, print samples, and a copy of the configuration and supplies status page) or contact HP customer support. At HP's option, HP will either replace products that prove to be defective or refund your purchase price.

TO THE EXTENT ALLOWED BY LOCAL LAW, THE ABOVE WARRANTY IS EXCLUSIVE AND NO OTHER WARRANTY OR CONDITION, WHETHER WRITTEN OR ORAL, IS EXPRESSED OR IMPLIED AND HP SPECIFICALLY DISCLAIMS ANY IMPLIED WARRANTIES OR CONDITIONS OF MERCHANTABILITY, SATISFACTORY QUALITY, AND FITNESS FOR A PARTICULAR PURPOSE.

TO THE EXTENT ALLOWED BY LOCAL LAW, IN NO EVENT WILL HP OR ITS SUPPLIERS BE LIABLE FOR DIRECT, SPECIAL, INCIDENTAL, CONSEQUENTIAL (INCLUDING LOST PROFIT OR DATA), OR OTHER DAMAGE, WHETHER BASED IN CONTRACT, TORT, OR OTHERWISE.

THE WARRANTY TERMS CONTAINED IN THIS STATEMENT, EXCEPT TO THE EXTENT LAWFULLY PERMITTED, DO NOT EXCLUDE, RESTRICT OR MODIFY AND ARE IN ADDITION TO THE MANDATORY STATUTORY RIGHTS APPLICABLE TO THE SALE OF THIS PRODUCT TO YOU.

Data stored on the print cartridge and imaging drum

The HP print cartridges and imaging drum used with this product contain a memory chip that assists in the operation of the product.

In addition, this memory chip collects a limited set of information about the usage of the product, which might include the following: the date when the print cartridge and imaging drum was first installed, the date when the print cartridge and imaging drum was last used, the number of pages printed using the print cartridge and imaging drum, the page coverage, the printing modes used, any printing errors that might have occurred, and the product model. This information helps HP design future products to meet our customers' printing needs.

The data collected from the print cartridge and imaging drum memory chip does not contain information that can be used to identify a customer or user of the print cartridge and imaging drum or their product.

HP collects a sampling of the memory chips from print cartridges and imaging drums returned to HP's free return and recycling program (HP Planet Partners: www.hp.com/recycle). The memory chips from this sampling are read and studied in order to improve future HP products. HP partners who assist in recycling this print cartridge and imaging drum might have access to this data, as well.

Any third party possessing the print cartridge and imaging drum might have access to the anonymous information on the memory chip. If you prefer to not allow access to this information, you can render the chip inoperable. However, after you render the memory chip inoperable, the memory chip cannot be used in an HP product.

End User License Agreement

PLEASE READ CAREFULLY BEFORE USING THIS SOFTWARE PRODUCT: This End-User License Agreement (“EULA”) is a contract between (a) you (either an individual or the entity you represent) and (b) Hewlett-Packard Company (“HP”) that governs your use of the software product (“Software”). This EULA does not apply if there is a separate license agreement between you and HP or its suppliers for the Software, including a license agreement in online documentation. The term “Software” may include (i) associated media, (ii) a user guide and other printed materials, and (iii) “online” or electronic documentation (collectively “User Documentation”).

RIGHTS IN THE SOFTWARE ARE OFFERED ONLY ON THE CONDITION THAT YOU AGREE TO ALL TERMS AND CONDITIONS OF THIS EULA. BY INSTALLING, COPYING, DOWNLOADING, OR OTHERWISE USING THE SOFTWARE, YOU AGREE TO BE BOUND BY THIS EULA. IF YOU DO NOT ACCEPT THIS EULA, DO NOT INSTALL, DOWNLOAD, OR OTHERWISE USE THE SOFTWARE. IF YOU PURCHASED THE SOFTWARE BUT DO NOT AGREE TO THIS EULA, PLEASE RETURN THE SOFTWARE TO YOUR PLACE OF PURCHASE WITHIN FOURTEEN DAYS FOR A REFUND OF THE PURCHASE PRICE; IF THE SOFTWARE IS INSTALLED ON OR MADE AVAILABLE WITH ANOTHER HP PRODUCT, YOU MAY RETURN THE ENTIRE UNUSED PRODUCT.

1. **THIRD PARTY SOFTWARE.** The Software may include, in addition to HP proprietary software (“HP Software”), software under licenses from third parties (“Third Party Software” and “Third Party License”). Any Third Party Software is licensed to you subject to the terms and conditions of the corresponding Third Party License. Generally, the Third Party License is located in a file such as license.txt; you should contact HP support if you cannot find any Third Party License. If the Third Party Licenses include licenses that provide for the availability of source code (such as the GNU General Public License) and the corresponding source code is not included with the Software, then check the product support pages of HP’s website (hp.com) to learn how to obtain such source code.

2. **LICENSE RIGHTS.** You will have the following rights provided you comply with all terms and conditions of this EULA:

a. **Use.** HP grants you a license to Use one copy of the HP Software. “Use” means installing, copying, storing, loading, executing, displaying, or otherwise using the HP Software. You may not modify the HP Software or disable any licensing or control feature of the HP Software. If this Software is provided by HP for Use with an imaging or printing product (for example, if the Software is a printer driver, firmware, or add-on), the HP Software may only be used with such product (“HP Product”). Additional restrictions on Use may appear in the User Documentation. You may not separate component parts of the HP Software for Use. You do not have the right to distribute the HP Software.

b. **Copying.** Your right to copy means you may make archival or back-up copies of the HP Software, provided each copy contains all the original HP Software’s proprietary notices and is used only for back-up purposes.

3. **UPGRADES.** To Use HP Software provided by HP as an upgrade, update, or supplement (collectively “Upgrade”), you must first be licensed for the original HP Software identified by HP as eligible for the Upgrade. To the extent the Upgrade supersedes the original HP Software, you may no longer use such HP Software. This EULA applies to each Upgrade unless HP provides other terms with the Upgrade. In case of a conflict between this EULA and such other terms, the other terms will prevail.

4. **TRANSFER.**

a. **Third Party Transfer.** The initial end user of the HP Software may make a one-time transfer of the HP Software to another end user. Any transfer will include all component parts, media, User Documentation, this EULA, and if applicable, the Certificate of Authenticity. The transfer may not be

an indirect transfer, such as a consignment. Prior to the transfer, the end user receiving the transferred Software will agree to this EULA. Upon transfer of the HP Software, your license is automatically terminated.

b. Restrictions. You may not rent, lease or lend the HP Software or Use the HP Software for commercial timesharing or bureau use. You may not sublicense, assign or otherwise transfer the HP Software except as expressly provided in this EULA.

5. PROPRIETARY RIGHTS. All intellectual property rights in the Software and User Documentation are owned by HP or its suppliers and are protected by law, including applicable copyright, trade secret, patent, and trademark laws. You will not remove any product identification, copyright notice, or proprietary restriction from the Software.

6. LIMITATION ON REVERSE ENGINEERING. You may not reverse engineer, decompile, or disassemble the HP Software, except and only to the extent that the right to do so is allowed under applicable law.

7. CONSENT TO USE OF DATA. HP and its affiliates may collect and use technical information you provide in relation to (i) your Use of the Software or the HP Product, or (ii) the provision of support services related to the Software or the HP Product. All such information will be subject to HP's privacy policy. HP will not use such information in a form that personally identifies you except to the extent necessary to enhance your Use or provide support services.

8. LIMITATION OF LIABILITY. Notwithstanding any damages that you might incur, the entire liability of HP and its suppliers under this EULA and your exclusive remedy under this EULA will be limited to the greater of the amount actually paid by you for the Product or U.S. \$5.00. TO THE MAXIMUM EXTENT PERMITTED BY APPLICABLE LAW, IN NO EVENT WILL HP OR ITS SUPPLIERS BE LIABLE FOR ANY SPECIAL, INCIDENTAL, INDIRECT, OR CONSEQUENTIAL DAMAGES (INCLUDING DAMAGES FOR LOST PROFITS, LOST DATA, BUSINESS INTERRUPTION, PERSONAL INJURY, OR LOSS OF PRIVACY) RELATED IN ANY WAY TO THE USE OF OR INABILITY TO USE THE SOFTWARE, EVEN IF HP OR ANY SUPPLIER HAS BEEN ADVISED OF THE POSSIBILITY OF SUCH DAMAGES AND EVEN IF THE ABOVE REMEDY FAILS OF ITS ESSENTIAL PURPOSE. Some states or other jurisdictions do not allow the exclusion or limitation of incidental or consequential damages, so the above limitation or exclusion may not apply to you.

9. U.S. GOVERNMENT CUSTOMERS. If you are a U.S. Government entity, then consistent with FAR 12.211 and FAR 12.212, Commercial Computer Software, Computer Software Documentation, and Technical Data for Commercial Items are licensed under the applicable HP commercial license agreement.

10. COMPLIANCE WITH EXPORT LAWS. You will comply with all laws, rules, and regulations (i) applicable to the export or import of the Software, or (ii) restricting the Use of the Software, including any restrictions on nuclear, chemical, or biological weapons proliferation.

11. RESERVATION OF RIGHTS. HP and its suppliers reserve all rights not expressly granted to you in this EULA.

(c) 2007 Hewlett-Packard Development Company, L.P.

Rev. 11/06

OpenSSL

This product includes software developed by the OpenSSL Project for use in the OpenSSL Toolkit (<http://www.openssl.org/>)

THIS SOFTWARE IS PROVIDED BY THE OpenSSL PROJECT "AS IS" AND ANY EXPRESSED OR IMPLIED WARRANTIES, INCLUDING, BUT NOT LIMITED TO, THE IMPLIED WARRANTIES OF MERCHANTABILITY AND FITNESS FOR A PARTICULAR PURPOSE ARE DISCLAIMED. IN NO EVENT SHALL THE OpenSSL PROJECT OR ITS CONTRIBUTORS BE LIABLE FOR ANY DIRECT, INDIRECT, INCIDENTAL, SPECIAL, EXEMPLARY, OR CONSEQUENTIAL DAMAGES (INCLUDING, BUT NOT LIMITED TO, PROCUREMENT OF SUBSTITUTE GOODS OR SERVICES;

LOSS OF USE, DATA, OR PROFITS; OR BUSINESS INTERRUPTION) HOWEVER CAUSED AND ON ANY THEORY OF LIABILITY, WHETHER IN CONTRACT, STRICT LIABILITY, OR TORT (INCLUDING NEGLIGENCE OR OTHERWISE) ARISING IN ANY WAY OUT OF THE USE OF THIS SOFTWARE, EVEN IF ADVISED OF THE POSSIBILITY OF SUCH DAMAGE.

This product includes cryptographic software written by Eric Young (ey@cryptsoft.com). This product includes software written by Tim Hudson (tjh@cryptsoft.com).

Customer support

Get telephone support for your country/region	Country/region phone numbers are on the flyer that was in the box with your product or at www.hp.com/support/ .
Have the product name, serial number, date of purchase, and problem description ready.	
Get 24-hour Internet support	www.hp.com/support/LJColorMFPM175
Get support for products used with a Macintosh computer	www.hp.com/go/macosex
Download software utilities, drivers, and electronic information	www.hp.com/support/LJColorMFPM175
Order additional HP service or maintenance agreements	www.hp.com/go/carepack
Register your product	www.register.hp.com

Repack the product

If HP Customer Care determines that your product needs to be returned to HP for repair, follow these steps to repack the product before shipping it.

△ **CAUTION:** Shipping damage as a result of inadequate packing is the customer's responsibility.

1. Remove and retain the print cartridges.

△ **CAUTION:** It is *extremely important* to remove the print cartridges before shipping the product. A print cartridge that remains in the product during shipping can leak and cover the product engine and other parts with toner.

To prevent damage to the print cartridges, avoid touching the rollers on them, and store the print cartridges so that they are not exposed to light.

2. Remove and retain the power cable, interface cable, and any optional accessories.
3. If possible, include print samples and 50 to 100 sheets of paper that did not print correctly.
4. In the U.S., call HP Customer Care to request new packing material. In other areas, use the original packing material, if possible.

C Specifications

- [Physical specifications](#)
- [Power consumption, electrical specifications, and acoustic emissions](#)
- [Environmental specifications](#)

Physical specifications

Table C-1 Physical specifications¹

Specification	HP LaserJet Pro 100 color MFP M175
Product weight	15.8 kg (34.8 lb)
Product height	337 mm (13.3 in)
Product depth	323 mm (12.7 in)
Product width	442 mm (17.4 in)

¹ Values are based on preliminary data. See www.hp.com/support/LJColorMFPM175.

Power consumption, electrical specifications, and acoustic emissions

See www.hp.com/support/LJColorMFPM175 for current information.

- △ **CAUTION:** Power requirements are based on the country/region where the product is sold. Do not convert operating voltages. This will damage the product and void the product warranty.

Environmental specifications

Table C-2 Environmental specifications

	Operating ¹	Storage ¹
Temperature	10° to 32.5°C (50° to 91°F)	0° to 35°C (32° to 95°F)
Relative Humidity	10% to 80%	10% to 80%

¹ Values are based on preliminary data. See www.hp.com/support/LJColorMFPM175.

D Regulatory information

- [FCC regulations](#)
- [Environmental product stewardship program](#)
- [Declaration of conformity \(base models\)](#)
- [Declaration of conformity \(wireless models\)](#)
- [Safety statements](#)
- [Additional statements for wireless products](#)

FCC regulations

This equipment has been tested and found to comply with the limits for a Class B digital device, pursuant to Part 15 of the FCC rules. These limits are designed to provide reasonable protection against harmful interference in a residential installation. This equipment generates, uses, and can radiate radio frequency energy. If this equipment is not installed and used in accordance with the instructions, it may cause harmful interference to radio communications. However, there is no guarantee that interference will not occur in a particular installation. If this equipment does cause harmful interference to radio or television reception, which can be determined by turning the equipment off and on, the user is encouraged to try to correct the interference by one or more of the following measures:

- Reorient or relocate the receiving antenna.
- Increase separation between equipment and receiver.
- Connect equipment to an outlet on a circuit different from that to which the receiver is located.
- Consult your dealer or an experienced radio/TV technician.

 **NOTE:** Any changes or modifications to the printer that are not expressly approved by HP could void the user's authority to operate this equipment.

Use of a shielded interface cable is required to comply with the Class B limits of Part 15 of FCC rules.

Environmental product stewardship program

Protecting the environment

Hewlett-Packard Company is committed to providing quality products in an environmentally sound manner. This product has been designed with several attributes to minimize impacts on our environment.

Ozone production

This product generates no appreciable ozone gas (O₃).

Power consumption

Power usage drops significantly while in Ready or Sleep mode, which saves natural resources and saves money without affecting the high performance of this product. Hewlett-Packard printing and imaging equipment marked with the ENERGY STAR® logo is qualified to the U.S. Environmental Protection Agency's ENERGY STAR specifications for imaging equipment. The following mark will appear on ENERGY STAR qualified imaging products:



Additional ENERGY STAR qualified imaging product model information is listed at:

www.hp.com/go/energystar

Paper use

This product's manual duplex feature (two-sided printing) and N-up printing (multiple pages printed on one page) capability can reduce paper usage and the resulting demands on natural resources.

Plastics

Plastic parts over 25 grams are marked according to international standards that enhance the ability to identify plastics for recycling purposes at the end of the product's life.

HP LaserJet print supplies

It's easy to return and recycle your HP LaserJet print cartridges after use—free of charge—with HP Planet Partners. Multilingual program information and instructions are included in every new HP LaserJet print cartridge and supplies package. You help reduce the toll on the environment further when you return multiple cartridges together rather than separately.

HP is committed to providing inventive, high-quality products and services that are environmentally sound, from product design and manufacturing to distribution, customer use and recycling. When you participate in the HP Planet Partners program, we ensure your HP LaserJet print cartridges are recycled properly, processing them to recover plastics and metals for new products and diverting millions of tons of waste from landfills. Since this cartridge is being recycled and used in new materials, it will not be returned to you. Thank you for being environmentally responsible!

 **NOTE:** Use the return label to return original HP LaserJet print cartridges only. Please do not use this label for HP inkjet cartridges, non-HP cartridges, refilled or remanufactured cartridges or warranty returns. For information about recycling your HP inkjet cartridges please go to <http://www.hp.com/recycle>.

Return and recycling instructions

United States and Puerto Rico

The enclosed label in the HP LaserJet toner cartridge box is for the return and recycling of one or more HP LaserJet print cartridges after use. Please follow the applicable instructions below.

Multiple returns (more than one cartridge)

1. Package each HP LaserJet print cartridge in its original box and bag.
2. Tape the boxes together using strapping or packaging tape. The package can weigh up to 31 kg (70 lb).
3. Use a single pre-paid shipping label.

OR

1. Use your own suitable box, or request a free bulk collection box from www.hp.com/recycle or 1-800-340-2445 (holds up to 31 kg (70 lb) of HP LaserJet print cartridges).
2. Use a single pre-paid shipping label.

Single returns

1. Package the HP LaserJet print cartridge in its original bag and box.
2. Place the shipping label on the front of the box.

Shipping

For US and Puerto Rico HP LaserJet print cartridge recycling returns, use the pre-paid, pre-addressed shipping label contained in the box. To use the UPS label, give the package to the UPS driver during your next delivery or pick-up, or take it to an authorized UPS drop-off center. (Requested UPS Ground pickup will be charged normal pick-up rates) For the location of your local UPS drop-off center, call 1-800-PICKUPS or visit www.ups.com.

If you are returning the package with the FedEx label, give the package to either the U.S. Postal Service carrier or FedEx driver during your next pick-up or delivery. (Requested FedEx Ground pickup will be charged normal pick-up rates). Or, you can drop off your packaged print cartridge(s) at any U.S. Post Office or any FedEx shipping center or store. For the location of your nearest U.S. Post Office, please call 1-800-ASK-USPS or visit www.usps.com. For the location of your nearest FedEx shipping center/store, please call 1-800-GOFEDEX or visit www.fedex.com.

For more information, or to order additional labels or boxes for bulk returns, visit www.hp.com/recycle or call 1-800-340-2445. Information subject to change without notice.

Residents of Alaska and Hawaii

Do not use the UPS label. Call 1-800-340-2445 for information and instructions. The U.S. Postal Service provides no-cost cartridge return transportation services under an arrangement with HP for Alaska and Hawaii.

Non-U.S. returns

To participate in HP Planet Partners return and recycling program, just follow the simple directions in the recycling guide (found inside the packaging of your new product supply item) or visit www.hp.com/recycle. Select your country/region for information on how to return your HP LaserJet printing supplies.

Paper

This product is capable of using recycled papers when the paper meets the guidelines outlined in the *HP LaserJet Printer Family Print Media Guide*. This product is suitable for the use of recycled paper according to EN12281:2002.

Material restrictions

This HP product does not contain added mercury.

This HP product does not contain a battery.

Disposal of waste equipment by users in private households in the European Union

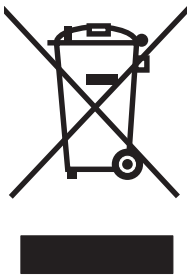

This symbol on the product or on its packaging indicates that this product must not be disposed of with your other household waste. Instead, it is your responsibility to dispose of your waste equipment by handing it over to a designated collection point for the recycling of waste electrical and electronic equipment. The separate collection and recycling of your waste equipment at the time of disposal will help to conserve natural resources and ensure that it is recycled in a manner that protects human health and the environment. For more information about where you can drop off your waste equipment for recycling, please contact your local city office, your household waste disposal service or the shop where you purchased the product.

Chemical substances

HP is committed to providing our customers with information about the chemical substances in our products as needed to comply with legal requirements such as REACH (Regulation EC No 1907/2006 of the European Parliament and the Council). A chemical information report for this product can be found at: www.hp.com/go/reach.

Material Safety Data Sheet (MSDS)

Material Safety Data Sheets (MSDS) for supplies containing chemical substances (for example, toner) can be obtained by accessing the HP Web site at www.hp.com/go/msds or www.hp.com/hpinfo/community/environment/productinfo/safety.

For more information

To obtain information about these environmental topics:

- Product environmental profile sheet for this and many related HP products
- HP's commitment to the environment
- HP's environmental management system

- HP's end-of-life product return and recycling program
- Material Safety Data Sheets

Visit www.hp.com/go/environment or www.hp.com/hpinfo/globalcitizenship/environment.

Declaration of conformity (base models)

Declaration of Conformity

according to ISO/IEC 17050-1 and EN 17050-1

Manufacturer's Name: Hewlett-Packard Company DoC#: BOISB-1001-02-rel.1.0

Manufacturer's Address: 11311 Chinden Boulevard
Boise, Idaho 83714-1021, USA

declares, that the product

Product Name: HP LaserJet Pro 100 color MFP M175a

Regulatory Model Number²⁾ BOISB-1001-02

Product Options: ALL

Print Cartridges: CE310A, CE311A, CE312A, CE313A

conforms to the following Product Specifications:

SAFETY: IEC 60950-1:2005 / EN60950-1: 2006 +A11
IEC 60825-1:2006 / EN 60825-1:2007 Class 1 Laser/LED Product)
IEC 62311:2007 / EN 62311:2008
GB4943-2001

EMC: CISPR22:2005 +A1 / EN55022:2006 +A1 - Class B¹⁾
EN 61000-3-2:2006
EN 61000-3-3:1995 +A1 +A2
EN 55024:1998 +A1 +A2
FCC Title 47 CFR, Part 15 Class B¹⁾ / ICES-003, Issue 4
GB9254-2008, GB17625.1-2003

ENERGY USE: Regulation (EC) No. 1275/2008
ENERGY STAR® Qualified Imaging Equipment Typical Electricity Consumption (TEC) Test Procedure

Supplementary Information:

The product herewith complies with the requirements of the EMC Directive 2004/108/EC and the Low Voltage Directive 2006/95/EC, the EuP Directive 2005/32/EC and carries the CE-Marking  accordingly.

This Device complies with Part 15 of the FCC Rules. Operation is subject to the following two Conditions: (1) this device may not cause harmful interference, and (2) this device must accept any interference received, including interference that may cause undesired operation.

1. The product was tested in a typical configuration with Hewlett-Packard Personal Computer Systems.
2. For regulatory purposes, this product is assigned a Regulatory model number. This number should not be confused with the product name or the product number(s).

Boise, Idaho USA

October 2010

For regulatory topics only:

European Contact: Your Local Hewlett-Packard Sales and Service Office or Hewlett-Packard GmbH, Department HQ-TRE / Standards Europe, Herrenberger Strasse 140, D-71034, Böblingen (FAX: +49-7031-14-3143) www.hp.com/go/certificates

USA Contact: Product Regulations Manager, Hewlett-Packard Company, PO Box 15, Mail Stop 160, Boise, Idaho 83707-0015 (Phone: 208-396-6000)

Declaration of conformity (wireless models)

Declaration of Conformity

according to ISO/IEC 17050-1 and EN 17050-1

Manufacturer's Name: Hewlett-Packard Company DoC#:BOISB-1001-03-rel.1.0
Manufacturer's Address: 11311 Chinden Boulevard
Boise, Idaho 83714-1021, USA

declares, that the product

Product Name: HP LaserJet Pro 100 color MFP M175nw
Regulatory Model Number²⁾ BOISB-1001-03
Product Options: ALL
Radio Module³⁾ SDGOB – 0892
Print Cartridges: CE310A, CE311A, CE312A, CE313A

conforms to the following Product Specifications:

SAFETY: IEC 60950-1:2005 / EN60950-1: 2006 +A11
IEC 60825-1:2006 / EN 60825-1:2007 Class 1 Laser/LED Product)
IEC 62311:2007 / EN 62311:2008
GB4943-2001

EMC: CISPR22:2005 +A1 / EN55022:2006 +A1 - Class B¹⁾
EN 61000-3-2:2006
EN 61000-3-3:1995 +A1 +A2
EN 55024:1998 +A1 +A2
FCC Title 47 CFR, Part 15 Class B¹⁾ / ICES-003, Issue 4
GB9254-2008, GB17625.1-2003

Radio⁵⁾ EN 301 489-1:V1.8.1 / EN 301 489-17:V1.3.2
EN 300 328: V1.7.1
FCC Title 47 CFR, Part 15 Subpart C (Section 15.247) / IC: RSS-210

ENERGY USE: Regulation (EC) No. 1275/2008
ENERGY STAR® Qualified Imaging Equipment Typical Electricity Consumption (TEC) Test Procedure

Supplementary Information:

The product herewith complies with the requirements of the R&TTE Directive 1999/5/EC Annex IV, EMC Directive 2004/108/EC and the Low Voltage Directive 2006/95/EC, the EuP Directive 2005/32/EC and carries the CE-Marking  accordingly.

This Device complies with Part 15 of the FCC Rules. Operation is subject to the following two Conditions: (1) this device may not cause harmful interference, and (2) this device must accept any interference received, including interference that may cause undesired operation.

1. The product was tested in a typical configuration with Hewlett-Packard Personal Computer Systems.
2. For regulatory purposes, this product is assigned a Regulatory model number. This number should not be confused with the product name or the product number(s).
3. This product uses a radio module device which Regulatory Model number is SDGOB-0892 as needed to meet technical regulatory requirements for the countries/regions this product will be sold.

Boise, Idaho USA

October 2010

For regulatory topics only:

European Contact: Your Local Hewlett-Packard Sales and Service Office or Hewlett-Packard GmbH, Department HQ-TRE / Standards Europe, Herrenberger Strasse 140, D-71034, Böblingen (FAX: +49-7031-14-3143) www.hp.com/go/certificates

USA Contact: Product Regulations Manager, Hewlett-Packard Company, PO Box 15, Mail Stop 160, Boise, Idaho 83707-0015 (Phone: 208-396-6000)

Safety statements

Laser safety

The Center for Devices and Radiological Health (CDRH) of the U.S. Food and Drug Administration has implemented regulations for laser products manufactured since August 1, 1976. Compliance is mandatory for products marketed in the United States. The device is certified as a “Class 1” laser product under the U.S. Department of Health and Human Services (DHHS) Radiation Performance Standard according to the Radiation Control for Health and Safety Act of 1968. Since radiation emitted inside the device is completely confined within protective housings and external covers, the laser beam cannot escape during any phase of normal user operation.

- △ **WARNING!** Using controls, making adjustments, or performing procedures other than those specified in this user guide may result in exposure to hazardous radiation.

Canadian DOC regulations

Complies with Canadian EMC Class B requirements.

« Conforme à la classe B des normes canadiennes de compatibilité électromagnétiques. « CEM ». »

VCCI statement (Japan)

この装置は、情報処理装置等電波障害自主規制協議会（VCCI）の基準に基づくクラスB情報技術装置です。この装置は、家庭環境で使用することを目的としていますが、この装置がラジオやテレビジョン受信機に近接して使用されると、受信障害を引き起こすことがあります。
取扱説明書に従って正しい取り扱いをして下さい。

Power cord instructions

Make sure your power source is adequate for the product voltage rating. The voltage rating is on the product label. The product uses either 110-127 Vac or 220-240 Vac and 50/60 Hz.

Connect the power cord between the product and a grounded AC outlet.

- △ **CAUTION:** To prevent damage to the product, use only the power cord that is provided with the product.

Power cord statement (Japan)

製品には、同梱された電源コードをお使い下さい。
同梱された電源コードは、他の製品では使用出来ません。

EMC statement (Korea)

B급 기기 (가정용 방송통신기기)	이 기기는 가정용(B급)으로 전자파적합등록을 한 기기로서 주로 가정에서 사용하는 것을 목적으로 하며, 모든 지역에서 사용할 수 있습니다.
-----------------------	--

Laser statement for Finland

Luokan 1 laserlaite

Klass 1 Laser Apparat

HP LaserJet Pro 100 color M175a, M175nw, laserkirjoitin on käyttäjän kannalta turvallinen luokan 1 laserlaite. Normaalisissa käytöissä kirjoittimen suojakoteloointi estää lasersäteen pääsyn laitteen ulkopuolelle. Laitteen turvallisuusluokka on määritetty standardin EN 60825-1 (2007) mukaisesti.

VAROITUS !

Laitteen käyttäminen muulla kuin käyttöohjeessa mainitulla tavalla saattaa altistaa käyttäjän turvallisuusluokan 1 ylittävälle näkymättömälle lasersäteilylle.

WARNING !

Om apparaten används på annat sätt än i bruksanvisning specificerats, kan användaren utsättas för osynlig laserstrålning, som överskrider gränsen för laserklass 1.

HUOLTO

HP LaserJet Pro 100 color M175a, M175nw - kirjoittimen sisällä ei ole käyttäjän huollettavissa olevia kohteita. Laitteen saa avata ja huoltaa ainoastaan sen huoltamiseen koulutettu henkilö. Tällaiseksi huoltotoimenpiteeksi ei katsota väriainekasetin vaihtamista, paperiradan puhdistusta tai muita käyttäjän käsikirjassa lueteltuja, käyttäjän tehtäväksi tarkoitettuja ylläpitotoimia, jotka voidaan suorittaa ilman erikoistyökaluja.

VARO !

Mikäli kirjoittimen suojakotelo avataan, olet alttiina näkymättömälle lasersäteilylle laitteen ollessa toiminnassa. Älä katso säteeseen.

WARNING !

Om laserprinterns skyddshölje öppnas då apparaten är i funktion, utsättas användaren för osynlig laserstrålning. Betrakta ej strålen.

Tiedot laitteessa käytettävän laserdiodin säteilyominaisuuksista: Aallonpituus 775-795 nm Teho 5 mW Luokan 3B laser.

GS statement (Germany)

Das Gerät ist nicht für die Benutzung im unmittelbaren Gesichtsfeld am Bildschirmarbeitsplatz vorgesehen. Um störende Reflexionen am Bildschirmarbeitsplatz zu vermeiden, darf dieses Produkt nicht im unmittelbaren Gesichtsfeld platziert werden.

Substances Table (China)

有毒有害物质表

根据中国电子信息产品污染控制管理办法的要求而出台

部件名称	有毒有害物质和元素					
	铅 (Pb)	汞 (Hg)	镉 (Cd)	六价铬 (Cr(VI))	多溴联苯 (PBB)	多溴二苯醚 (PBDE)
打印引擎	X	0	X	0	0	0
控制面板	0	0	0	0	0	0
塑料外壳	0	0	0	0	0	0
格式化板组件	X	0	0	0	0	0
碳粉盒	X	0	0	0	0	0

3685

0：表示在此部件所用的所有同类材料中，所含的此有毒或有害物质均低于 SJ/T11363-2006 的限制要求。

X：表示在此部件所用的所有同类材料中，至少一种所含的此有毒或有害物质高于 SJ/T11363-2006 的限制要求。

注：引用的“环保使用期限”是根据在正常温度和湿度条件下操作使用产品而确定的。

Restriction on Hazardous Substances statement (Turkey)

Türkiye Cumhuriyeti: EEE Yönetmeliğine Uygundur

Additional statements for wireless products

FCC compliance statement—United States

Exposure to radio frequency radiation

- △ **CAUTION:** The radiated output power of this device is far below the FCC radio frequency exposure limits. Nevertheless, the device shall be used in such a manner that the potential for human contact during normal operation is minimized.

In order to avoid the possibility of exceeding the FCC radio frequency exposure limits, human proximity to the antenna shall not be less than 20 cm (8 in)) during normal operation.

This device complies with Part 15 of FCC Rules. Operation is subject to the following two conditions: (1) this device may not cause interference, and (2) this device must accept any interference, including interference that may cause undesired operation of the device.

- △ **CAUTION:** Based on Section 15.21 of the FCC rules, changes of modifications to the operation of this product without the express approval by Hewlett-Packard Company may invalidate its authorized use.

Australia statement

This device incorporates a radio-transmitting (wireless) device. For protection against radio transmission exposure, it is recommended that this device be operated no less than 20 cm from the head, neck, or body.

Brazil ANATEL statement

Este equipamento opera em caráter secundário, isto é, não tem direito à proteção contra interferência prejudicial, mesmo de estações do mesmo tipo, e não pode causar interferência a sistemas operando em caráter primário.

Canadian statements

For Indoor Use. This digital apparatus does not exceed the Class B limits for radio noise emissions from digital apparatus as set out in the radio interference regulations of the Canadian Department of Communications. The internal wireless radio complies with RSS 210 of Industry Canada.

Pour l'usage d'intérieur. Le présent appareil numérique n'émet pas de bruits radioélectriques dépassant les limites applicables aux appareils numériques de Classe B prescrites dans le règlement sur le brouillage radioélectrique édicté par le Ministère des Communications du Canada. Le composant RF interne est conforme à la norme CNR-210 d'Industrie Canada.

European Union regulatory notice

The telecommunications functionality of this product may be used in the following EU and EFTA countries/regions:

Austria, Belgium, Bulgaria, Cyprus, Czech Republic, Denmark, Estonia, Finland, France, Germany, Greece, Hungary, Iceland, Ireland, Italy, Latvia, Liechtenstein, Lithuania, Luxembourg, Malta, Netherlands, Norway, Poland, Portugal, Romania, Slovak Republic, Slovenia, Spain, Sweden, Switzerland, and United Kingdom.

Notice for use in France

For 2.4 GHz Wireless LAN operation of this product certain restrictions apply: This equipment may be used indoor for the entire 2400-2483.5 MHz frequency band (channels 1-13). For outdoor use, only 2400-2454 MHz frequency band (channels 1-9) may be used. For the latest requirements, see www.arcep.fr.

L'utilisation de cet équipement (2.4 GHz Wireless LAN) est soumise à certaines restrictions : Cet équipement peut être utilisé à l'intérieur d'un bâtiment en utilisant toutes les fréquences de 2400-2483.5 MHz (Chaîne 1-13). Pour une utilisation en environnement extérieur, vous devez utiliser les fréquences comprises entre 2400-2454 MHz (Chaîne 1-9). Pour les dernières restrictions, voir, www.arcep.fr.

Notice for use in Russia

Существуют определенные ограничения по использованию беспроводных сетей (стандарта 802.11 b/g) с рабочей частотой 2,4 ГГц: Данное оборудование может использоваться внутри помещений с использованием диапазона частот 2400-2483,5 МГц (каналы 1-13). При использовании внутри помещений максимальная эффективная изотропно-излучаемая мощность (ЭИИМ) должна составлять не более 100мВт.

Korean statement

당해 무선설비는 운용 중 전파혼선 가능성이 있음

Taiwan statement

低功率電波輻射性電機管理辦法

第十二條 經型式認證合格之低功率射頻電機，非經許可，公司、商號或使用者均不得擅自變更頻率、加大功率或變更原設計之特性及功能。

第十四條 低功率射頻電機之使用不得影響飛航安全及干擾合法通信；經發現有干擾現象時，應立即停用，並改善至無干擾時方得繼續使用。前項合法通信，指依電信法規定作業之無線電通信。低功率射頻電機須忍受合法通信或工業、科學及醫療用電波輻射性電機設備之干擾。

Index

Symbols/Numerics

2-sided printing
Windows 84

A

accessories
 ordering 169, 170
 part numbers 170
acoustic specifications 182
ad-hoc wireless network
 configuring 44
 description 43
altitude specifications 182
anticounterfeit supplies 68

B

batteries included 187
bins, output
 jams, clearing 152
black and white scanning 125
booklets
 printing (Windows) 99

C

Canadian DOC regulations 193
canceling
 copy jobs 111
 print job 29, 78
 scan jobs 123
cartridges
 non-HP 68
 part numbers 170
 recycling 67, 185
 storage 67
 supplies status page 128
 warranty 174
cartridges, print
 Macintosh status 32
cautions iii

cleaning
 exterior 136
 glass 114, 126
 paper path 136, 157
 printer 135
collating copies 112
color
 adjusting 102
 Edge Control 103
 halftone options 104
 manage 101
 matching 106
 Neutral Grays 104
 printed vs. monitor 106
 using 101
color alignment, calibrating 157
color options
 HP EasyColor (Windows) 105
 setting (Windows) 90
color settings
 adjusting 155
Color tab settings 31
color usage log 128
color, scanning settings 124, 125
configuration page 128
connecting to a wireless
 network 40
connecting to the network 39
connectivity
 solving problems 160
 USB 38
contrast settings
 copy 115
control panel
 cleaning page, printing 136
 menu map, printing 128
 menus 8
 message types 142
 messages,
 troubleshooting 142
 settings 26
conventions, document iii
copies
 changing number of
 (Windows) 80
copying
 canceling 111
 collation 112
 contrast, adjusting 115
 Copy Menu 12
 double-sided 119
 edge-to-edge 115
 enlarging 111
 light/dark settings 115
 multiple copies 108
 one-touch 108
 paper settings 116
 photos 117
 quality, adjusting 113
 reducing 111
 restore default settings 116
counterfeit supplies 68
cover pages
 printing (Mac) 30
custom print settings
 (Windows) 80
custom-size copies 111
custom-size paper settings
 Macintosh 29
customer support
 online 179
 repacking product 180

D

darkness, contrast settings
 copy 115
declaration of
 conformity 189, 191

- default settings, restore 141
- defects, repeating 71
- demo page 128
- device status
 - Macintosh Services tab 32
- disposal, end-of-life 187
- document conventions iii
- document feeder
 - jams 150
- double-sided printing
 - paper loading orientation 56
- dpi (dots per inch)
 - scanning 124
- drivers
 - changing paper types and sizes 50
 - changing settings (Mac) 27
 - changing settings (Windows) 19
 - presets (Mac) 29
 - settings (Mac) 29
 - settings (Windows) 79
 - usage page 128
- drum
 - warranty 175
- duplex printing
 - paper loading orientation 56
 - Windows 84

E

- e-mail, scanning to
 - resolution settings 125
- Edge Control 103
- edge-to-edge printing 115
- electrical specifications 182
- end-of-life disposal 187
- enlarging documents
 - copying 111
- envelopes
 - loading orientation 56
- environment specifications 182
- environmental features 3
- environmental stewardship program 185
- error messages
 - control panel 142
- errors
 - software 165
- European Union, waste disposal 187

F

- Finnish laser safety statement 194
- firewall 40
- first page
 - use different paper 30
- fonts
 - lists, printing 128
- forms
 - printing (Windows) 92
- fraud hotline 68

G

- glass, cleaning 114, 126
- grayscale printing, Windows 91
- grayscale scanning 125

H

- help
 - printing options (Windows) 79
- HP Customer Care 179
- HP Easy Color
 - disabling 105
 - using 105
- HP fraud hotline 68
- HP Scan (Windows) 122
- HP Utility 28
- HP Utility, Mac 28
- HP Web Jetadmin 20, 131
- HP-UX software 21
- humidity specifications 182

I

- identification cards
 - copying 110
- imaging drum
 - checking for damage 70
 - memory chips 176
 - storage 67
 - warranty 175
- imaging drum, part number 170
- infrastructure wireless network
 - description 43
- input tray
 - capacity 56
 - loading 55
- installing
 - software, USB connections 38
 - software, wired networks 25, 40

IP address

- automatic configuration 25, 40
- manual configuration 25, 39

J

jams

- causes of 148
- document feeder, clearing 150
- locating 149
- output bin, clearing 152
- rear door, clearing 152
- tracking number of 128
- trays, clearing 151

Japanese VCCI statement 193

Jetadmin, HP Web 20, 131

K

Korean EMC statement 193

L

labels

- printing (Windows) 94

landscape orientation

- changing (Windows) 88

laser safety statements 193, 194

letterhead

- printing (Windows) 92

license, software 177

lightness

- copy contrast 115

Linux 21

Linux software 21

loading media

- input tray 55

lock

- product 132

low power settings

- disabling 133
- enabling 133

M

Mac

- changing paper types and sizes 29
- driver settings 27, 29
- HP Utility 28
- installing software 24
- problems, troubleshooting 34
- removing software 26

- scanning from TWAIN-compliant software 122
- supported operating systems 24
- Macintosh
 - resize documents 29
 - support 179
- Macintosh driver settings
 - custom-size paper 29
 - Services tab 32
 - watermarks 30
- managing network 45
- matching colors 106
- material restrictions 187
- Material Safety Data Sheet (MSDS) 187
- media
 - custom-size, Macintosh settings 29
 - first page 30
 - pages per sheet 31
 - supported sizes 51
- media jams. *See* jams
- memory chip, imaging drum description 176
- memory chip, print cartridge description 176
- menu
 - Copy Menu 12
 - Network Setup 11
 - Reports 8
 - Service 10
 - System Setup 8
- menus, control panel
 - map, printing 128
- mercury-free product 187
- messages
 - control panel 142
- model number 5
- multiple pages per sheet
 - printing (Windows) 86

N

- n-up printing
 - selecting (Windows) 86
- network
 - configuring 11
 - disabling wireless 41
 - IP address
 - configuration 25, 39

- operating systems
 - supported 36
 - settings, changing 45
 - settings, viewing 45
- network connections 39
- Network Setup menu 11
- networks
 - configuration page 128
 - HP Web Jetadmin 131
 - settings report 128
- Neutral Grays 104
- non-HP supplies 68
- notes iii
- number of copies, changing 108

O

- OCR software 123
- online support 179
- opening printer drivers (Windows) 79
- operating environment specifications 182
- operating systems supported 24
- operating systems Windows, supported 16
- operating systems, networks 36
- optical character recognition software 123
- ordering
 - part numbers for 170
 - supplies and accessories 170
- ordering supplies
 - Web sites 169
- orientation
 - changing (Windows) 88
 - paper, while loading 56

P

- packaging product 180
- page count 128
- page orientation
 - changing (Windows) 88
- page sizes
 - scaling documents to fit (Windows) 97
- pages per sheet
 - selecting (Windows) 86
- paper
 - copy settings 116

- custom-size, Macintosh settings 29
- first page 30
- jams 148
- loading orientation 56
- pages per sheet 31
- printing on preprinted letterhead or forms (Windows) 92
- selecting 156
- supported sizes 51
- paper jams. *See* jams
- paper pickup problems
 - solving 148
- paper size
 - changing 50
- paper sizes
 - selecting 83
 - selecting custom 84
- paper type
 - changing 154
- paper types
 - changing 50
 - selecting 84
- paper, covers
 - printing (Windows) 96
- paper, ordering 170
- paper, special
 - printing (Windows) 94
- part numbers
 - print cartridges 170
- PCL font list 128
- photos
 - copying 117
- physical specifications 182
- pixels per inch (ppi), scanning resolution 124
- portrait orientation
 - changing (Windows) 88
- power
 - consumption 182
- ppi (pixels per inch), scanning resolution 124
- preprinted paper
 - printing (Windows) 92
- presets (Mac) 29
- print cartridges
 - Macintosh status 32
 - memory chips 176
 - non-HP 68

- part numbers 170
- recycling 67, 185
- storage 67
- supplies status page 128
- warranty 174
- print job
 - canceling 29, 78
 - changing settings 18
- print media
 - supported 51
- print quality
 - improving 154
 - improving (Windows) 83
- print tasks 77
- printer
 - cleaning 135
- printer driver
 - configuring wireless network 41
- printer drivers
 - choosing 157
- printer drivers (Mac)
 - changing settings 27
 - settings 29
- printer drivers (Windows)
 - changing settings 18, 19
 - settings 79
- printing
 - edge-to-edge 115
 - Macintosh 29
 - settings (Mac) 29
 - settings (Windows) 79
- priority, settings 26
- problem-solving
 - control-panel messages 142
 - no response 159
 - slow response 159
- product
 - software for Windows 15
 - view 4
- PS font list 128
- Q**
- quality
 - copy settings 113
 - print settings (Macintosh) 29
- R**
- Readiris OCR software 123
- rear door
 - jams 152
- recycling
 - HP printing supplies returns and environmental program 186
 - recycling supplies 67
 - reducing documents copying 111
 - removing Mac software 26
 - repacking product 180
 - repeating defects, troubleshooting 71
 - repetitive defects, troubleshooting 71
- reports
 - color usage log 8
 - configuration page 8
 - demo page 8
 - diagnostics page 8
 - menu map 8
 - network summary 8
 - PCL 6 font list 8
 - PCL font list 8
 - print quality page 8
 - PS font list 8
 - service page 8
 - supplies status page 8
 - usage page 8
- resize documents
 - Macintosh 29
 - Windows 97
- resizing documents
 - copying 111
- resolution
 - scanning 124
- S**
- safety statements 193, 194
- scale documents
 - Macintosh 29
 - Windows 97
- scaling documents
 - copying 111
- scanner
 - glass cleaning 114, 126
- scanning
 - black and white 125
 - canceling 123
 - color 124
 - from HP Scan (Windows) 122
 - from Mac software 33
 - grayscale 125
 - methods 122
 - OCR software 123
 - resolution 124
 - TWAIN-compliant software 122
 - WIA-compliant software 122
- serial number 5
- service
 - repacking product 180
- Service menu 10
- service page 128
- Services tab
 - Macintosh 32
- settings
 - driver presets (Mac) 29
 - drivers 19
 - drivers (Mac) 27
 - network report 128
 - priority 26
- shipping product 180
- shortcuts (Windows)
 - creating 81
 - using 80
- size specifications, product 182
- size, copy
 - reducing or enlarging 111
- sleep delay
 - disabling 133
 - enabling 133
- small documents
 - copying 110
- software
 - HP Utility 28
 - HP Web Jetadmin 20
 - installing, USB connections 38
 - installing, wired networks 25, 40
 - Linux 21
 - problems 165
 - Readiris OCR 123
 - scanning from TWAIN or WIA 122
 - settings 26
 - software license agreement 177
 - Solaris 21

- supported operating systems 24
 - supported Windows operating systems 16
 - uninstalling for Windows 20
 - uninstalling Mac 26
 - UNIX 21
 - Windows 20
 - Solaris software 21
 - solving
 - direct-connect problems 160
 - network problems 160
 - special media
 - guidelines 48
 - special paper
 - guidelines 48
 - printing (Windows) 94
 - special paper for covers
 - printing (Windows) 96
 - specifications
 - electrical and acoustic 182
 - environment 182
 - physical 182
 - status
 - HP Utility, Mac 28
 - Macintosh services tab 32
 - supplies, printing report 128
 - storing
 - print cartridges 67
 - product 182
 - supplies
 - counterfeit 68
 - non-HP 68
 - ordering 169, 170
 - part numbers 170
 - recycling 67, 185
 - status, viewing with HP Utility 28
 - supplies status page
 - printing 71
 - supply-status, Services tab
 - Macintosh 32
 - support
 - online 179
 - repacking product 180
 - supported media 51
 - System Setup menu 8
- T**
- TCP/IP
 - operating systems supported 36
 - technical support
 - online 179
 - repacking product 180
 - temperature specifications 182
 - tips iii
 - toner cartridges. *See* print cartridges
 - transparencies
 - printing (Windows) 94
 - trapping 103
 - trays
 - capacity 56
 - jams, clearing 151
 - paper orientation 56
 - troubleshooting
 - checklist 139
 - control panel messages 142
 - direct-connect problems 160
 - jams 148
 - Mac problems 34
 - network problems 160
 - paper feed problems 148
 - repeating defects 71
 - TWAIN-compliant software, scanning from 122
 - two-sided printing
 - Windows 84
- U**
- uninstalling Mac software 26
 - uninstalling Windows software 20
 - UNIX 21
 - UNIX software 21
 - usage page 128
 - USB
 - configuring wireless network 26, 41
 - USB cable, part number 170
 - USB configuration 38
- V**
- view, product 4
- W**
- warnings iii
 - warranty
 - imaging drum 175
 - license 177
 - print cartridges 174
 - product 172
 - watermarks
 - adding (Windows) 99
 - Web sites
 - customer support 179
 - fraud reports 68
 - HP Web Jetadmin, downloading 131
 - Macintosh customer support 179
 - Material Safety Data Sheet (MSDS) 187
 - ordering supplies 169
 - WIA-compliant software, scanning from 122
 - Windows
 - driver settings 19
 - scanning from TWAIN or WIA software 122
 - software components 20
 - wireless
 - disabling 41
 - wireless network
 - ad-hoc 43
 - communication modes 43
 - configuring ad-hoc 44
 - configuring with USB 26, 41
 - configuring with WPS 26, 40
 - infrastructure 43
 - installing the driver 41
 - security 43
 - wireless network connection 40
 - wireless network interference 42
 - WPS
 - configuring wireless network 26, 40

© 2012 Hewlett-Packard Development Company, L.P.

www.hp.com



CE866-90908

