

HP Deskjet 3000 J310 series



Contents

1	How Do I?	3
2	Get to know the HP Printer	
	Printer parts	5
	Control panel features	6
	Status Lights	7
	Wireless Status Light	8
3	Print	
	Print documents	9
	Print photos	10
	Print envelopes	11
	Quick Forms	12
	Tips for print success	12
5	Work with cartridges	
	Check the estimated ink levels	23
	Order ink supplies	24
	Replace the cartridges	25
	Use single-cartridge mode	27
	Cartridge warranty information	27
6	Connectivity	
	Add the HP Printer to a network	29
	Tips for setting up and using a networked printer	31
7	Solve a problem	
	Improve print quality	33
	Clear a paper jam	35
	Unable to print	37
	Networking	40
	HP support	41
8	Technical information	
	Notice	43
	Specifications	43
	Environmental product stewardship program	45
	Regulatory notices	48
	Index	55

1 How Do I?

Learn how to use your HP Printer

- [Printer parts](#)
- [Load media](#)
- [Replace the cartridges](#)
- [Clear a paper jam](#)
- [WiFi Protected Setup \(WPS\)](#)

2 Get to know the HP Printer

- [Printer parts](#)
- [Control panel features](#)
- [Status Lights](#)
- [Wireless Status Light](#)

Printer parts

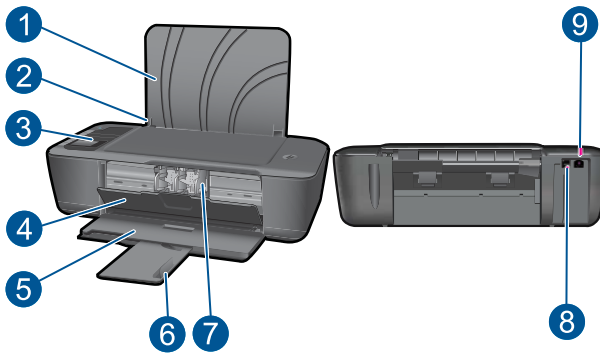

1	Input tray
2	Paper-width guide for the input tray
3	Control panel
4	Cartridge door
5	Output tray
6	Output tray extender (also referred to as the tray extender)
7	Cartridges
8	USB port
9	Power connection: Use only with the power adapter supplied by HP



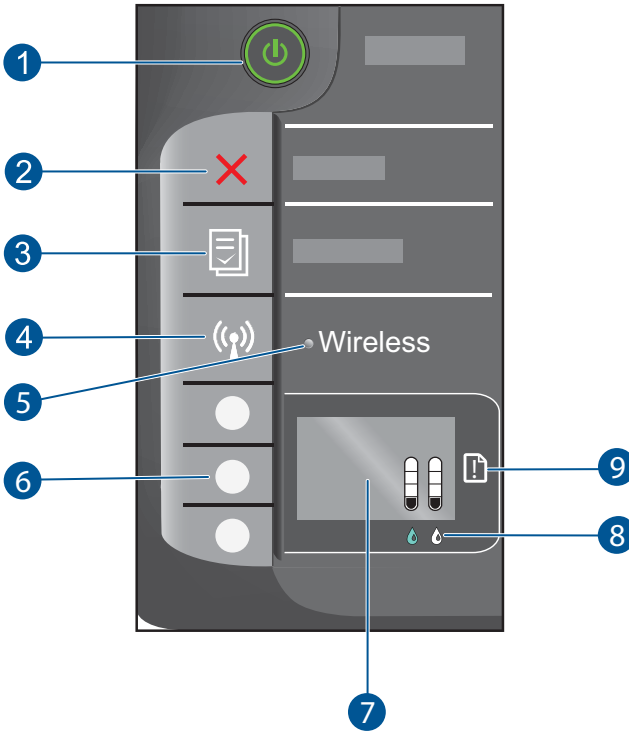

Control panel features

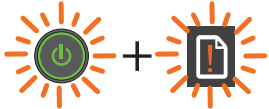

1	On button and light: Turns the product on or off. When the product is off, a minimal amount of power is still used. To completely remove power, turn off the product, then unplug the power cord.
2	Cancel: Stops the current operation. Returns you to previous screen of printer display.
3	Quick Forms: Shows Quick Forms menu on printer display. Use Selection buttons to select the form that you want to print.
4	Wireless button: Shows wireless menu on printer display.
5	Wireless light: Signals if there is a wireless connection.
6	Selection buttons: Use buttons to select menu items on the printer display.
7	Printer display: Displays estimated ink levels for the cartridges. Press the Quick Forms button or the Wireless button to view menus for these options on the printer display.
8	Cartridge light: Indicates low ink or a print cartridge problem.
9	Attention light: Indicates that there is a paper jam, the printer is out of paper, or some event that requires your attention.

Status Lights

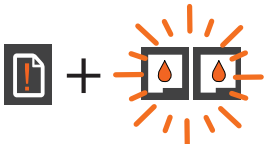
When the product is turned on, the on button light will be lit. When the product is processing a job, the on light will be blinking. Additional blinking lights signal errors that you can resolve. See below to learn about blinking lights and what to do.

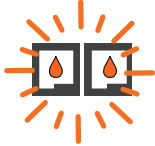
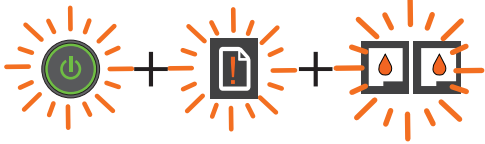
Behavior	Solution
<p>On light is blinking fast + Attention light is blinking fast</p> 	<p>The output tray is closed, there is no paper, or there is a paper jam.</p> <p>Prepare the trays, correctly Load media, or Clear a paper jam. Then select OK on the printer display to continue.</p>
<p>On light is blinking fast + both cartridge lights are blinking fast + Attention light is on</p> 	<p>The cartridge door is open.</p> <p>Close cartridge door. See Prepare the trays for more information.</p>
<p>Both cartridges lights are blinking fast + Attention light is on</p> 	<p>The carriage is obstructed.</p> <p>Open cartridge door and move the carriage to the right to clear the obstruction. Then select OK on the printer display to continue. See Clear the print carriage for more information.</p>
<p>One or both cartridge lights are on</p> 	<p>The indicated cartridge is low on ink.</p> <p>Replace the cartridge when print quality is no longer acceptable.</p>
<p>One or both cartridge lights are blinking</p> 	<p>Cartridges still have the tape on, are not installed, incompatible or defective.</p> <p>Remove the pink tape if still on the cartridges. Insert cartridges if missing or insert compatible cartridges. See Identify a defective cartridge to identify if only one cartridge is a defective</p>
<p>All lights are fast blinking</p> 	<p>The printer is in an error state.</p> <p>To exit the error state, reset the product.</p> <ol style="list-style-type: none"> 1. Turn off the product. 2. Unplug the power cord. 3. Wait a minute, then plug the power cord back in. 4. Turn on the product.

(continued)

Behavior	Solution
	If the problem persists, contact HP support .

Wireless Status Light

Light behavior	Solution
Off	Wireless signal off. Press wireless button to enable wireless printing and access wireless menu on the printer display.
Blinking	Indicates printer is searching for a wireless connection. Wait for connection to be established. If connection cannot be established, make sure printer is within range of wireless signal.
Fast blinking	Wireless error has occurred. Refer to messages on printer display.
On	Wireless connection has been established and you can print.

3 Print

Choose a print job to continue.



[Print documents](#)



[Print photos](#)



[Print envelopes](#)

Print documents

To print from a software application

1. Make sure the output tray is open.
2. Make sure you have paper loaded in the input tray.



See [Load media](#) for more information.

3. From your software application, click the **Print** button.
4. Make sure the product is the selected printer.
5. Click the button that opens the **Properties** dialog box. Depending on your software application, this button might be called **Properties**, **Options**, **Printer Setup**, **Printer**, or **Preferences**.

6. Select the appropriate options.
 - On **Layout** tab select **Portrait** or **Landscape** orientation.
 - On **Paper/Quality** tab select the appropriate paper size and paper type from the **Paper Size** and **Media** drop-down lists.
 - Click **Advanced** to select the appropriate output quality from the **Printer Features** list.
7. Click **OK** to close the **Properties** dialog box.
8. Click **Print** or **OK** to begin printing.

 **NOTE:** You can print your document on both sides of the paper, instead of just one side. Click on the **Advanced** button on the **Paper/Quality** or **Layout** tab. From the **Pages to Print** drop-down menu select **Print Odd Pages Only**. Click **OK** to print. After the odd numbered pages of the document have been printed, remove the document from the output tray. Reload the paper in the input tray with the blank side facing up. Return to the **Pages to Print** drop-down menu and then select **Print Even Pages Only**. Click **OK** to print.

Print photos

To print a photo on photo paper

1. Make sure the output tray is open.
2. Remove all paper from the input tray, and then load the photo paper with side to be printed on facing up.

 **NOTE:** If the photo paper you are using has perforated tabs, load photo paper so that tabs are on top.

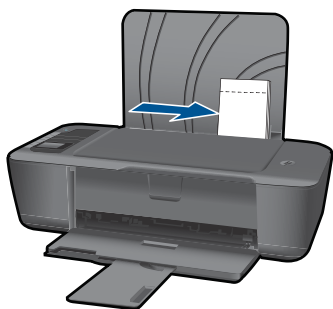

See [Load media](#) for more information.

3. On the **File** menu in your software application, click **Print**.
4. Make sure the product is the selected printer.
5. Click the button that opens the **Properties** dialog box. Depending on your software application, this button might be called **Properties**, **Options**, **Printer Setup**, **Printer**, or **Preferences**.

6. Select the appropriate options.
 - On **Layout** tab select **Portrait** or **Landscape** orientation.
 - On **Paper/Quality** tab select the appropriate paper size and paper type from the **Paper Size** and **Media** drop-down lists.
 - Click **Advanced** to select the appropriate output quality from the **Printer Features** list.

 **NOTE:** For maximum dpi resolution, go to the **Paper/Quality** tab and select **Photo Paper, Best Quality** from the **Media** drop-down list. Make sure you are printing in color. Then go to the **Advanced** tab and select **Yes** from the **Print in Max DPI** drop-down list. For more information, see [Print using the maximum dpi](#).

7. Click **OK** to return to the **Properties** dialog box.
8. Click **OK**, and then click **Print** or **OK** in the **Print** dialog box.

 **NOTE:** Do not leave unused photo paper in the input tray. The paper might start to curl, which could reduce the quality of your printout. Photo paper should be flat before printing.

 **NOTE:** Printed photos will have a border on all four edges of the image.

Print envelopes

You can load one or more envelopes into the input tray of the HP Printer. Do not use shiny or embossed envelopes or envelopes that have clasps or windows.

 **NOTE:** For specific details on how to format text for printing on envelopes, consult the help files in your word processing software. For best results, consider using a label for the return address on envelopes.

To print envelopes

1. Make sure the output tray is open.
2. Slide the paper guide all the way to the left.
3. Place the envelopes in the right side of the tray. The side to be printed on should face up. The flap should be on the left side.
4. Push the envelopes into the printer until they stop.
5. Slide the paper guide firmly against the edge of the envelopes.

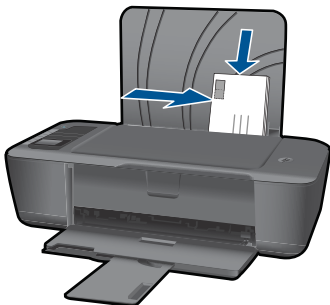

See [Load media](#) for more information.

6. Click the button that opens the **Properties** dialog box. Depending on your software application, this button might be called **Properties**, **Options**, **Printer Setup**, **Printer**, or **Preferences**.
7. Select the appropriate options.
 - On **Paper/Quality** tab select a **Plain paper** type.
 - Click the **Advanced** button, and select the appropriate envelope size from the **Paper Size** drop down menu.
8. Click **OK**, and then click **Print** or **OK** in the **Print** dialog box.

Quick Forms

Use Quick Forms to print Office Forms, Paper Types, and Games.

- Press the Quick Forms button on the printer.
- On the printer display you will see the Quick Forms menu options.
- Press a Selection to select an option.

 **TIP:** Increase the number of copies by holding down or pressing the Selection button multiple times.

Tips for print success

To successfully print, the HP cartridges should be functioning properly with sufficient ink, the paper should be loaded correctly, and the product should have the appropriate settings.

Cartridge tips

- Use genuine HP ink cartridges.
- Install both the black and tri-color cartridges correctly. For more information, see [Replace the cartridges](#).
- Check the estimated ink levels in the cartridges to make sure there is sufficient ink. For more information, see [Check the estimated ink levels](#).
- For more information, see [Improve print quality](#).

Paper loading tips

- Load a stack of paper (not just one page). All of the paper in the stack should be the same size and type to avoid a paper jam.
- Load paper with side to be printed on facing up.
- Ensure that paper loaded in the input tray lays flat and the edges are not bent or torn.
- Adjust the paper-width guide in the input tray to fit snugly against all paper. Make sure the paper-width guide does not bend the paper in the input tray.
- For more information, see [Load media](#).

Printer settings tips

- On the **Paper/Quality** tab of the print driver, select the appropriate paper type and quality from the **Media** drop down menu.
- Click the **Advanced** button, and select the appropriate **Paper Size** from the **Paper/Output** drop-down menu.
- Click the HP Printer desktop icon to open the Printer Software. In the Printer Software, click **Printer Actions** and then click **Set Preferences** to access the print driver.



NOTE: You can also access the Printer Software by clicking **Start > Programs > HP > HP Deskjet 3000 J310 series > HP Deskjet 3000 J310 series**

Notes

- Genuine HP ink cartridges are designed and tested with HP printers and papers to help you easily produce great results, time after time.



NOTE: HP cannot guarantee the quality or reliability of non-HP supplies. Product service or repairs required as a result of using a non-HP supply will not be covered under warranty.

If you believe you purchased genuine HP ink cartridges, go to:

www.hp.com/go/anticounterfeit

- Ink level warnings and indicators provide estimates for planning purposes only.



NOTE: When you receive a low-ink warning message, consider having a replacement cartridge available to avoid possible printing delays. You do not need to replace the cartridges until print quality becomes unacceptable.

- You can print your document on both sides of the paper, instead of just one side.



NOTE: Click the **Advanced** button on the **Paper/Quality** or **Layout** tab. From the **Pages to Print** drop-down menu select **Print Odd Pages Only**. Click **OK** to print. After the odd numbered pages of the document have been printed, remove the document from the output tray. Reload the paper in the input tray with the blank side facing up. Return to the **Pages to Print** drop-down menu and then select **Print Even Pages Only**. Click **OK** to print.

- Print using black ink only



NOTE: If you want to print a black and white document using black ink only, click the **Advanced** button. From the **Print in Grayscale** drop-down menu select **Black Ink Only**, then click the **OK** button. If you see **Black and White** as an option on the **Paper/Quality** tab or the **Layout** tab, select it.



[Click here to go online for more information.](#)

Print using the maximum dpi

Use maximum dots per inch (dpi) mode to print high-quality, sharp images on photo paper.

See technical specifications for the print resolution of the maximum dpi mode.

Printing in maximum dpi takes longer than printing with other settings and requires a large amount of disk space.

To print in Maximum dpi mode

1. Make sure you have photo paper loaded in the input tray.
2. On the **File** menu in your software application, click **Print**.
3. Make sure the product is the selected printer.
4. Click the button that opens the **Properties** dialog box.
Depending on your software application, this button might be called **Properties**, **Options**, **Printer Setup**, **Printer**, or **Preferences**.
5. Click the **Paper/Quality** tab.
6. In the **Media** drop-down list, click **Photo Paper, Best Quality**.



NOTE: **Photo Paper, Best Quality** must be selected from the **Media** drop-down list on the **Paper/Quality** tab to enable printing in maximum DPI.

7. Click the **Advanced** button.
8. In the **Printer Features** area, select **Yes** from the **Print in Max DPI** drop-down list.
9. Select **Paper Size** from **Paper/Output** drop-down menu.
10. Click **OK** to close the advanced options.
11. Confirm **Orientation** on **Layout** tab, then click **OK** to print.

4 Paper basics

You can load many different types and sizes of paper in the HP Printer, including letter or A4 paper, photo paper, transparencies, and envelopes.

This section contains the following topics:

[Load media](#)

Recommended papers for printing

If you want the best print quality, HP recommends using HP papers that are specifically designed for the type of project you are printing.

Depending on your country/region, some of these papers might not be available.

ColorLok

HP recommends plain papers with the ColorLok logo for printing and copying of everyday documents. All papers with the ColorLok logo are independently tested to meet high standards of reliability and print quality, and produce documents with crisp, vivid color, bolder blacks, and dry faster than ordinary plain papers. Look for papers with the ColorLok logo in a variety of weights and sizes from major paper manufacturers.



HP Advanced Photo Paper

This thick photo paper features an instant-dry finish for easy handling without smudging. It resists water, smears, fingerprints, and humidity. Your prints have a look and feel comparable to a store-processed photo. It is available in several sizes, including A4, 8.5 x 11 inch, 10 x 15 cm (4 x 6 inch) (with or without tabs), 13 x 18 cm (5 x 7 inch), and two finishes - glossy or soft gloss (satin matte). It is acid-free for longer lasting documents.

HP Everyday Photo Paper

Print colorful, everyday snapshots at a low cost, using paper designed for casual photo printing. This affordable, photo paper dries quickly for easy handling. Get sharp, crisp images when you use this paper with any inkjet printer. It is available in semi-gloss finish in several sizes, including A4, 8.5 x 11 inch, and 10 x 15 cm (4 x 6 inch) (with or without tabs). For longer-lasting photos, it is acid-free.

HP Brochure Paper or HP Superior Inkjet Paper

These papers are glossy-coated or matte-coated on both sides for two-sided use. They are the perfect choice for near-photographic reproductions and business graphics for report covers, special presentations, brochures, mailers, and calendars.

HP Premium Presentation Paper or HP Professional Paper

These papers are heavy two-sided matte papers perfect for presentation, proposals, reports, and newsletters. They are heavyweight for an impressive look and feel.

HP Bright White Inkjet Paper

HP Bright White Inkjet Paper delivers high-contrast colors and sharp text. It is opaque enough for two-sided color usage with no show-through, which makes it ideal for newsletters, reports, and flyers. It features ColorLok Technology for less smearing, bolder blacks, and vivid colors.

HP Printing Paper

HP Printing Paper is a high-quality multifunction paper. It produces documents that look and feel more substantial than documents printed on standard multipurpose or copy paper. It features ColorLok Technology for less smearing, bolder blacks, and vivid colors. It is acid-free for longer lasting documents.

HP Office Paper

HP Office Paper is a high-quality multifunction paper. It is suitable for copies, drafts, memos, and other everyday documents. It features ColorLok Technology for less smearing, bolder blacks, and vivid colors. It is acid-free for longer lasting documents.

HP Iron-On Transfers

HP Iron-on Transfers (for color fabrics or for light or white fabrics) are the ideal solution for creating custom T-shirts from your digital photos.

HP Premium Inkjet Transparency Film

HP Premium Inkjet Transparency Film make your color presentations vivid and even more impressive. This film is easy to use and handle and dries quickly without smudging.

HP Photo Value Pack

HP Photo Value Packs conveniently package original HP cartridges and HP Advanced Photo Paper to save you time and take the guesswork out of printing affordable professional photos with your HP Printer. Original HP inks and HP Advanced Photo Paper have been designed to work together so your photos are long lasting and vivid, print after print. Great for printing out an entire vacation's worth of photos or multiple prints to share.



NOTE: At this time, some portions of the HP Web site are available in English only.

To order HP papers and other supplies, go to www.hp.com/buy/supplies. If prompted, choose your country/region, follow the prompts to select your product, and then click one of the shopping links on the page.

Load media

- ▲ Select a paper size to continue.

Load full-size paper

- Raise the input tray
 - Raise the input tray.

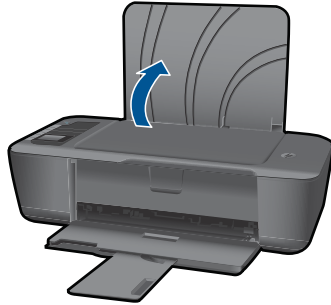

- Lower the output tray
 - Lower the output tray and pull out the tray extender.



- c. Slide paper-width guide to the left
- ❑ Slide paper-width guide to the left.

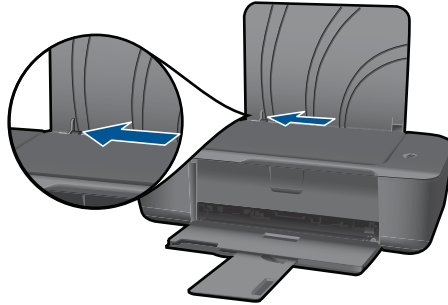

- d. Load paper.
- ❑ Insert stack of paper into input tray with short edge forward and print side up.

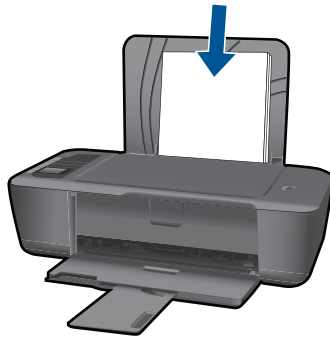

- ❑ Slide stack of paper down until it stops.
- ❑ Slide paper-width guide to the right until it stops at edge of paper.



Load small-size paper

- a. Raise the input tray
 - Raise the input tray.

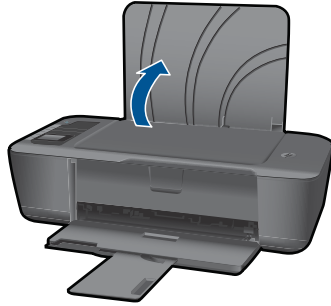

- b. Lower the output tray
 - Lower the output tray and pull out the tray extender.

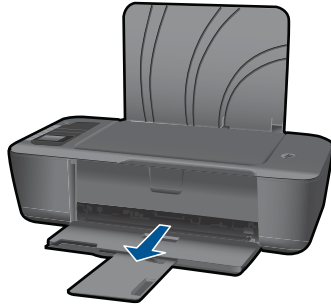

- c. Slide paper-width guide to the left.
- Slide paper-width guide to the left.

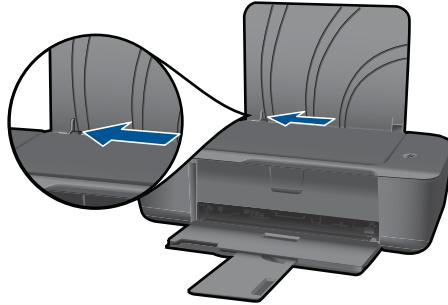

- d. Load paper.
- Insert stack of photo paper with short edge down and print side up.
 - Slide stack of paper forward until it stops.

 **NOTE:** If the photo paper you are using has perforated tabs, load photo paper so that tabs are on top.

- Slide paper-width guide to the right until it stops at edge of paper.

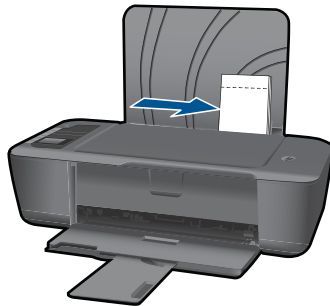

Load envelopes

- a. Raise the input tray
- Raise the input tray.

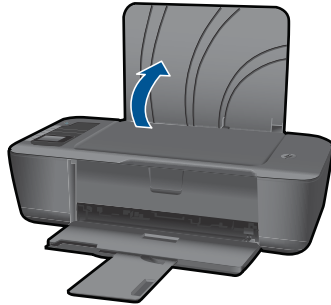

- b. Lower the output tray
- Lower the output tray and pull out the tray extender.

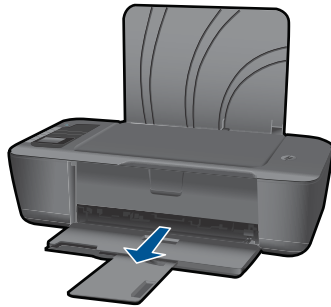

- c. Slide paper-width guide to the left.
- Slide paper-width guide to the left.

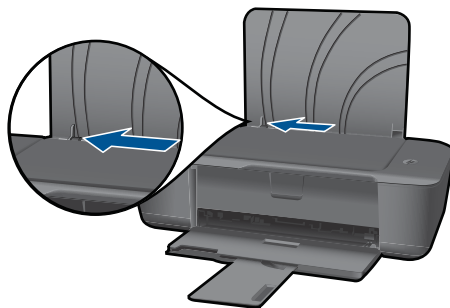

- Remove all paper from the main input tray.
- d. Load envelopes.
 - Insert one or more envelopes into far-right side of the input tray. The side to be printed on should face up. The flap should be on the left side and facing down.
 - Slide stack of envelopes down until it stops.
 - Slide paper-width guide to the right against stack of envelopes until it stops.

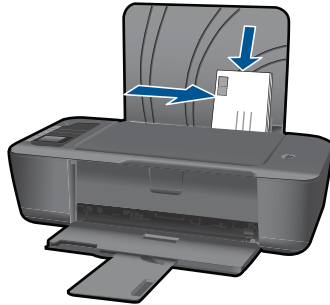

5 Work with cartridges

- [Check the estimated ink levels](#)
- [Order ink supplies](#)
- [Replace the cartridges](#)
- [Use single-cartridge mode](#)
- [Cartridge warranty information](#)

Check the estimated ink levels

You can easily check the ink supply level to determine how soon you might need to replace a cartridge. The ink supply level shows an estimate of the amount of ink remaining in the cartridges.

To check the ink levels from the Printer Software

1. Click the HP Printer desktop icon to open the Printer Software.

 **NOTE:** You can also access the Printer Software by clicking **Start > Programs > HP > HP Deskjet 3000 J310 series > HP Deskjet 3000 J310 series**

2. In the Printer Software, click **Estimated Ink Levels**.

 **NOTE:** If you have installed a refilled or remanufactured cartridge, or a cartridge that has been used in another printer, the ink level indicator might be inaccurate or unavailable.

NOTE: Ink level warnings and indicators provide estimates for planning purposes only. When you receive a low-ink warning message, consider having a replacement cartridge available to avoid possible printing delays. You do not have to replace the cartridges until the print quality is unacceptable.

NOTE: Ink from the cartridges is used in the printing process in a number of different ways, including in the initialization process, which prepares the product and cartridges for printing, and in printhead servicing, which keeps print nozzles clear and ink flowing smoothly. In addition, some residual ink is left in the cartridge after it is used. For more information, see www.hp.com/go/inkusage.

Order ink supplies

Before ordering cartridges, locate the correct cartridge number. The cartridge number is printed on the label of the cartridge. If an old cartridge is not available, you can find the number on the printer and in the printer software

Locate the cartridge number on the printer

- ▲ The cartridge number is located inside the cartridge door.

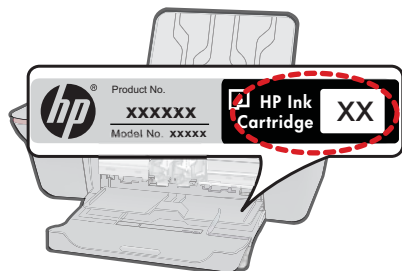

Locate the cartridge number in the Printer Software

1. Click the HP Printer desktop icon to open the Printer Software.

 **NOTE:** You can also access the Printer Software by clicking **Start > Programs > HP > HP Deskjet 3000 J310 series > HP Deskjet 3000 J310 series**

2. In the Printer Software, click **Shop For Supplies Online**. The correct cartridge number will be automatically displayed when you use this link.

To order genuine HP supplies for the HP Printer, go to www.hp.com/buy/supplies. If prompted, choose your country/region, follow the prompts to select your product, and then click one of the shopping links on the page.

 **NOTE:** Ordering cartridges online is not supported in all countries/regions. If it is not available in your country/region, you may still view supplies information and print a list for reference when shopping at a local HP reseller.

Related topics

[Choose the right cartridges](#)

Choose the right cartridges

HP recommends that you use original HP cartridges. Original HP cartridges are designed and tested with HP printers to help you easily produce great results, time after time.

Related topics

[Order ink supplies](#)

Replace the cartridges

To replace the cartridges

1. Check power.
2. Load paper.
3. Remove cartridge.
 - a. Open cartridge door.

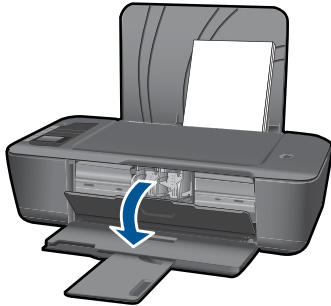

Wait for print carriage to move to center of the product.

- b. Press down to release cartridge, then remove it from slot.

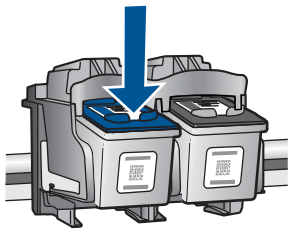

4. Insert new cartridge.
 - a. Remove cartridge from packaging.



- b. Remove plastic tape using pink pull tab.

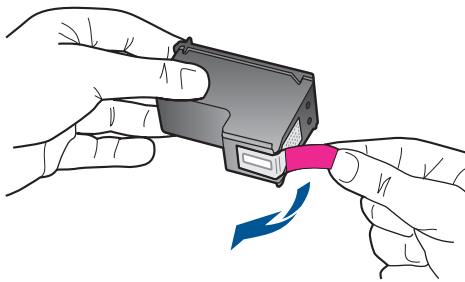

- c. Slide cartridge into slot until it clicks into place.

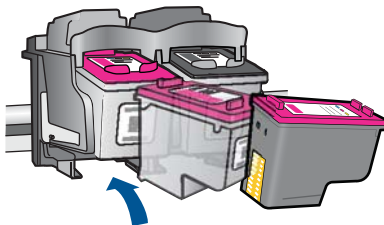

- d. Close cartridge door.

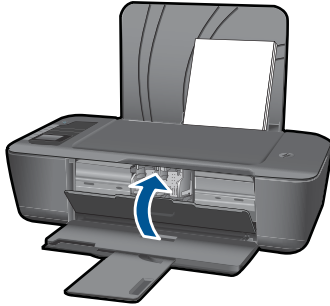

5. Align cartridges.

Related topics

- [Choose the right cartridges](#)
- [Order ink supplies](#)

Use single-cartridge mode

Use the single-cartridge mode to operate the HP Printer with only one print cartridge. The single-cartridge mode is initiated when a print cartridge is removed from the print cartridge carriage. During single-cartridge mode, the product can only print jobs from the computer.

 **NOTE:** When the HP Printer operates in single-cartridge mode, a message is displayed on screen. If the message is displayed and two print cartridges are installed in the product, verify that the protective piece of plastic tape has been removed from each print cartridge. When plastic tape covers the print cartridge contacts, the product cannot detect that the print cartridge is installed.

Exit single-cartridge mode

Install two print cartridges in the HP Printer to exit single-cartridge mode.

Related topics

- [Replace the cartridges](#)

Cartridge warranty information

The HP cartridge warranty is applicable when the product is used in its designated HP printing device. This warranty does not cover HP ink products that have been refilled, remanufactured, refurbished, misused, or tampered with.

During the warranty period the product is covered as long as the HP ink is not depleted and the end of warranty date has not been reached. The end of warranty date, in YYYY/MM/DD format, may be found on the product as indicated:

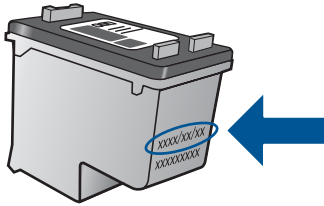

For a copy of the HP Limited Warranty Statement, see the printed documentation that came with the product.

6 Connectivity

Add the HP Printer to a network

- [WiFi Protected Setup \(WPS\)](#)
- [Alternative Wireless Connection Method](#)
- [USB Connection](#)

WiFi Protected Setup (WPS)

To connect the HP Printer to a wireless network using WiFi Protected Setup (WPS), you will need the following:

- A wireless 802.11 network that includes a WPS-enabled wireless router or access point.
- A desktop computer or laptop with either wireless networking support, or a network interface card (NIC). The computer must be connected to the wireless network that you intend to install the HP Printer on.

To connect the HP Printer using WiFi Protected Setup (WPS)

1. Do one of the following:

Use Push Button (PBC) method

- ▲ Set up wireless connection.
 - Press the wireless button on the control panel to show the wireless menu options on the printer display.
 - Select **Wireless Settings** on the printer display.
 - Select **WPS**.
 - Select **Push Button** and follow the on-screen instructions on the printer display.

 **NOTE:** The product begins a timer for approximately two minutes in which the corresponding button on the networking device needs to be pressed.

Use PIN method

- ▲ Set up wireless connection.
 - Press the wireless button on the control panel to show the wireless menu options on the printer display.
 - Select **Wireless Settings** on the printer display.
 - Select **WPS**.
 - Select **PIN**. The printer display will display a PIN.

- ❑ Enter the PIN on WPS-enabled router or other networking device.
- ❑ Follow the on-screen instructions on the printer display.

 **NOTE:** The product begins a timer for approximately two minutes in which the PIN needs to be entered on the networking device.

2. View the animation for this topic.

Alternative Wireless Connection Method

To connect the HP Printer to an integrated wireless WLAN 802.11 network, you will need the following:

- ❑ A wireless 802.11 network that includes a wireless router or access point.
If you connect the HP Printer on a wireless network that has Internet access, HP recommends that you use a wireless router (access point or base station) that uses Dynamic Host Configuration Protocol (DHCP).
- ❑ A desktop computer or laptop with either wireless networking support, or a network interface card (NIC). The computer must have an available USB port to temporarily connect to the product. The computer must be connected to the wireless network that you intend to install the HP Printer on.
- ❑ The network name assigned to your home network. Also called the SSID.
- ❑ WEP key or WPA Passphrase (if needed).

To connect the product

1. Insert the product Software CD in the computer CD-ROM drive.
2. Follow the instructions on the screen.
When you are prompted, connect the product to the computer using the USB setup cable included in the box. Follow the onscreen prompts to enter your wireless network settings. The product will attempt to connect to the network. If the connection fails, follow the prompts to correct the problem, and then try again.
3. When the setup is finished, you will be prompted to disconnect the USB cable and test the wireless network connection. Once the product connects successfully to the network, install the software on each computer that will use the product over the network.

See [Tips for setting up and using a networked printer](#) for more information.

USB Connection

The HP Printer supports a rear USB 2.0 High Speed port for connection to a computer.

To connect the product with the USB cable

- ▲ Refer to the setup instructions that came with your product for information on connecting to a computer with a USB cable.

 **NOTE:** Do not connect the USB cable to the product until you are prompted to do so.

To enable printer sharing on a Windows computer

- ▲ Refer to the user guide that came with your computer or see the Windows onscreen Help.

Tips for setting up and using a networked printer

Use the following tips to set up and use a networked printer:

- When setting up the wireless networked printer, make sure your wireless router or access point is powered on. The printer searches for wireless routers and lists the network names on the computer during wireless setup.
- If your computer is connected to a Virtual Private Network (VPN), you need to disconnect from the VPN before you can access any other device on your network., including the printer.
- Learn how to find your network security settings. [Click here to go online for more information.](#)
- Learn about the Network Diagnostic Utility and other troubleshooting tips. [Click here to go online for more information.](#)
- Learn how to change from a USB to wireless connection. [Click here to go online for more information.](#)
- Learn how to work with your firewall and anti-virus programs during printer setup. [Click here to go online for more information.](#)

7 Solve a problem

This section contains the following topics:

- [Improve print quality](#)
- [Clear a paper jam](#)
- [Unable to print](#)
- [Networking](#)
- [HP support](#)



[Click here to go online for more information.](#)

Improve print quality

1. Make sure you are using genuine HP cartridges.
2. Check the print properties to make sure you have selected the appropriate paper type and print quality from the **Media** drop-down list. In the Printer Software, click **Printer Actions** and then click **Set Preferences** to access the print properties.
3. Check the estimated ink levels to determine if the cartridges are low on ink. For more information, see [Check the estimated ink levels](#). If the print cartridges are low on ink consider replacing them.
4. Align the printer cartridges

To align the cartridges from the Printer Software

 **NOTE:** Aligning the cartridges ensures high-quality output. The HP Printer prompts you to align the cartridges when you print a document after installing a new cartridge.

- a. Load letter or A4 unused plain white paper into the input tray.
 - b. In the Printer Software, click **Printer Actions** and then click **Maintenance Tasks** to access the **Printer Toolbox**.
 - c. The **Printer Toolbox** appears.
 - d. Click **Align Ink Cartridges** tab. The product prints an alignment sheet.
5. Print a diagnostics page if the cartridges are not low on ink.

To print a diagnostics page

- a. Load letter or A4 unused plain white paper into the input tray.
- b. In the Printer Software, click **Printer Actions** and then click **Maintenance Tasks** to access the **Printer Toolbox**.
- c. Click **Print Diagnostic Information** to print a diagnostics page. Review the blue, magenta, yellow, and black boxes on the diagnostics page. If you are seeing

streaks in the color and black boxes, or no ink in portions of the boxes, then automatically clean the cartridges

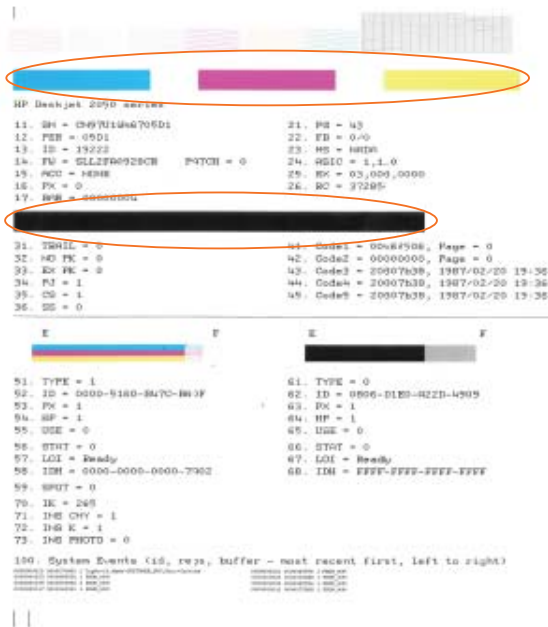

6. Clean the cartridges automatically, if the diagnostic page shows streaks or missing portions of the color and black boxes.

To clean the cartridges automatically

- a. Load letter or A4 unused plain white paper into the input tray.
- b. In the Printer Software, click **Printer Actions** and then click **Maintenance Tasks** to access the **Printer Toolbox**.
- c. Click **Clean Ink Cartridges**. Follow the onscreen instructions.

If the above solutions do not resolve the problem, [click here for more online troubleshooting](#).

Clear a paper jam

Clear a paper jam.

To clear a paper jam

1. Press the cancel button to try to clear the jam automatically. If this does not work, the paper jam will need to be cleared manually.
2. Locate the paper jam

Input tray

If the paper jam is located near the back input tray, pull the paper gently out of the input tray.



Output tray

- If the paper jam is located near the front output tray, pull the paper gently out of the output tray.



- You may need to open the carriage door and slide the print carriage to the right to access the paper jam.



Inside of printer

- If the paper jam is located inside the printer, open the cleanout door located on the bottom of the printer. Press tabs on both sides of the cleanout door.

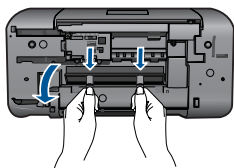

- Remove jammed paper.

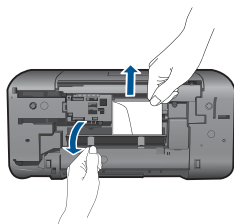

- Close the cleanout door. Gently push the door towards the printer until both latches snap into place.

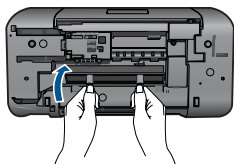

3. Press the OK button on the control panel to continue the current job.

If the above solutions do not resolve the problem, [click here for more online troubleshooting](#).

Prevent paper jams

- Do not overfill the input tray.
- Remove printed papers from the output tray frequently.
- Ensure that paper loaded in the input tray lays flat and the edges are not bent or torn.
- Do not combine different paper types and paper sizes in the input tray; the entire stack of paper in the input tray must be the same size and type.
- Adjust the paper-width guide in the input tray to fit snugly against all paper. Make sure the paper-width guide does not bend the paper in the input tray.
- Do not force paper too far forward in the input tray.

If the above solutions do not resolve the problem, [click here for more online troubleshooting](#).

Unable to print

Make sure that the printer is turned on and that there is paper in the tray. If you are still unable to print, try the following in order:

1. Check for error messages and resolve.
2. Disconnect and reconnect the USB cable.
3. Verify that the product is not paused or offline.

To verify that the product is not paused or offline

 **NOTE:** HP provides a Printer Diagnostic Utility that can automatically fix this issue.



[Click here to go online for more information.](#) Otherwise, follow the steps below.

- a. Depending upon your operating system, do one of the following:
 - **Windows 7:** From the Windows **Start** menu, click **Devices and Printers**.
 - **Windows Vista:** From the Windows **Start** menu, click **Control Panel**, and then click **Printers**.
 - **Windows XP:** From the Windows **Start** menu, click **Control Panel**, and then click **Printers and Faxes**.
 - b. Double-click the icon for your product to open the print queue.
 - c. On the **Printer** menu, make sure there are no check marks next to **Pause Printing** or **Use Printer Offline**.
 - d. If you made any changes, try to print again.
4. Verify that the product is set as the default printer.

To verify that the product is set as the default printer

 **NOTE:** HP provides a Printer Diagnostic Utility that can automatically fix this issue.



[Click here to go online for more information.](#) Otherwise, follow the steps below.

- a. Depending upon your operating system, do one of the following:
 - **Windows 7:** From the Windows **Start** menu, click **Devices and Printers**.
 - **Windows Vista:** From the Windows **Start** menu, click **Control Panel**, and then click **Printers**.
 - **Windows XP:** From the Windows **Start** menu, click **Control Panel**, and then click **Printers and Faxes**.
- b. Make sure the correct product is set as the default printer.
The default printer has a check mark in a black or green circle next to it.
- c. If the wrong product is set as the default printer, right-click the correct product and select **Set as Default Printer**.
- d. Try using your product again.

5. Restart the print spooler.

To restart the print spooler

 **NOTE:** HP provides a Printer Diagnostic Utility that can automatically fix this issue.

 [Click here to go online for more information.](#) Otherwise, follow the steps below.

- a. Depending upon your operating system, do one of the following:

Windows 7

- From the Windows **Start** menu, click **Control Panel, System and Security**, and then **Administrative Tools**.
- Double-click **Services**.
- Right-click the **Print Spooler**, and then click **Properties**.
- On the **General** tab, next to **Startup type**, make sure that **Automatic** is selected.
- If the service is not already running, under **Service status**, click **Start**, and then click **OK**.

Windows Vista

- From the Windows **Start** menu, click **Control Panel, System and Maintenance, Administrative Tools**.
- Double-click **Services**.
- Right-click the **Print Spooler service**, and then click **Properties**.
- On the **General** tab, next to **Startup type**, make sure that **Automatic** is selected.
- If the service is not already running, under **Service status**, click **Start**, and then click **OK**.

Windows XP

- From the Windows **Start** menu, right click **My Computer**.
 - Click **Manage**, and then click **Services and Applications**.
 - Double-click **Services**, and then select **Print Spooler**.
 - Right-click **Print Spooler**, and click **Restart** to restart the service.
- b. Make sure the correct product is set as the default printer.
The default printer has a check mark in a black or green circle next to it.
 - c. If the wrong product is set as the default printer, right-click the correct product and select **Set as Default Printer**.
 - d. Try using your product again.

- Restart the computer.
- Clear the print queue.

To clear the print queue

 **NOTE:** HP provides a Printer Diagnostic Utility that can automatically fix this issue.

 [Click here to go online for more information.](#) Otherwise, follow the steps below.

- Depending upon your operating system, do one of the following:
 - Windows 7:** From the Windows **Start** menu, click **Devices and Printers**.
 - Windows Vista:** From the Windows **Start** menu, click **Control Panel**, and then click **Printers**.
 - Windows XP:** From the Windows **Start** menu, click **Control Panel**, and then click **Printers and Faxes**.
- Double-click the icon for your product to open the print queue.
- On the **Printer** menu, click **Cancel all documents** or **Purge Print Document**, and then click **Yes** to confirm.
- If there are still documents in the queue, restart the computer and try printing again after the computer has restarted.
- Check the print queue again to make sure it is clear, and then try to print again. If the print queue is not clear, or if it is clear but jobs are still failing to print, proceed to the next solution.

If the above solutions do not resolve the problem, [click here for more troubleshooting online](#).

Clear the print carriage

Remove any objects, such as paper, that are blocking the print carriage.

 **NOTE:** Do not use any tools or other devices to remove jammed paper. Always use caution when removing jammed paper from inside the product.

 [Click here to go online for more information.](#)

Identify a defective cartridge

If both the tri-color and black cartridge lights are blinking, and the power light is on, both cartridges may still have tape on, or are missing. First make sure that the pink tape has been removed from both cartridges, and that both cartridges are installed. If both cartridge

lights are still blinking, then one or both cartridges may be defective. To determine if one cartridge is defective do the following:

1. Remove black cartridge.
2. Close cartridge door.
3. If the **On** light blinks, the tri-color cartridge should be replaced. If the **On** light does not blink, replace the black cartridge.

Prepare the trays

Open output tray

- ▲ Output tray must be open to begin printing.

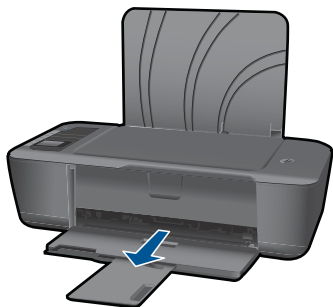

Close cartridge door

- ▲ Cartridge door must be closed to begin printing.

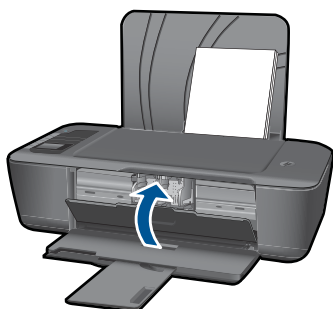

 [Click here to go online for more information.](#)

Networking

- Learn how to find your network security settings. [Click here to go online for more information.](#)
- Learn about the Network Diagnostic Utility and other troubleshooting tips. [Click here to go online for more information.](#)

- Learn how to change from a USB to wireless connection. [Click here to go online for more information.](#)
- Learn how to work with your firewall and anti-virus programs during printer setup. [Click here to go online for more information.](#)

HP support

- [Register the product](#)
- [Support process](#)
- [HP support by phone](#)
- [Additional warranty options](#)

Register the product

By taking just a few quick minutes to register, you can enjoy quicker service, more efficient support, and product support alerts. If you did not register your printer while installing the software, you can register now at <http://www.register.hp.com>.

Support process

If you have a problem, follow these steps:

1. Check the documentation that came with the product.
2. Visit the HP online support Web site at www.hp.com/support. HP online support is available to all HP customers. It is the fastest source for up-to-date product information and expert assistance and includes the following features:
 - Fast access to qualified online support specialists
 - Software and driver updates for the product
 - Valuable product and troubleshooting information for common problems
 - Proactive product updates, support alerts, and HP newsgrams that are available when you register the product
3. Call HP support. Support options and availability vary by product, country/region, and language.

HP support by phone

Phone support options and availability vary by product, country/region, and language.

This section contains the following topics:

- [Phone support period](#)
- [Placing a call](#)
- [Support phone numbers](#)
- [After the phone support period](#)

Phone support period

One year of phone support is available in North America, Asia Pacific, and Latin America (including Mexico). To determine the duration of phone support in Europe, the Middle East, and Africa, go to www.hp.com/support. Standard phone company charges apply.

Placing a call

Call HP support while you are in front of the computer and the product. Be prepared to provide the following information:

- Product name (HP Deskjet 3000 J310 series)
- Model number (located inside the cartridge door)

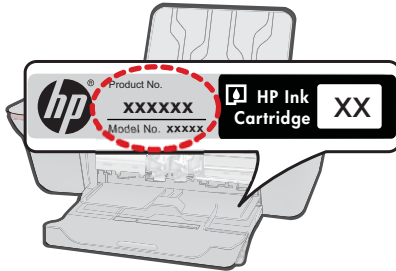

- Serial number (located on the back or bottom of the product)
- Messages that appear when the situation occurs
- Answers to these questions:
 - Has this situation happened before?
 - Can you re-create it?
 - Did you add any new hardware or software to your computer at about the time that this situation began?
 - Did anything else occur prior to this situation (such as a thunderstorm, product was moved, etc.)?

Support phone numbers

For the most current HP list of telephone support numbers and call costs information, see www.hp.com/support.

After the phone support period

After the phone support period, help is available from HP at an additional cost. Help may also be available at the HP online support Web site: www.hp.com/support. Contact your HP dealer or call the support phone number for your country/region to learn more about support options.

Additional warranty options

Extended service plans are available for the HP Printer at additional costs. Go to www.hp.com/support, select your country/region and language, then explore the services and warranty area for information about the extended service plans.

8 Technical information

The technical specifications and international regulatory information for the HP Printer are provided in this section.

For additional specifications, see the printed documentation that came with the HP Printer.

This section contains the following topics:

- [Notice](#)
- [Specifications](#)
- [Environmental product stewardship program](#)
- [Regulatory notices](#)

Notice

Hewlett-Packard Company notices

The information contained in this document is subject to change without notice.

All rights reserved. Reproduction, adaptation, or translation of this material is prohibited without prior written permission of Hewlett-Packard, except as allowed under copyright laws. The only warranties for HP products and services are set forth in the express warranty statements accompanying such products and services. Nothing herein should be construed as constituting an additional warranty. HP shall not be liable for technical or editorial errors or omissions contained herein.

© 2009 Hewlett-Packard Development Company, L.P.

Microsoft, Windows, Windows XP, and Windows Vista are U.S. registered trademarks of Microsoft Corporation.

Windows 7 is either a registered trademark or trademark of Microsoft Corporation in the United States and/or other countries.

Intel and Pentium are trademarks or registered trademarks of Intel Corporation or its subsidiaries in the United States and other countries.

Specifications

Technical specifications for the HP Printer are provided in this section. For complete product specifications, see the Product Data Sheet at www.hp.com/support.

System requirements

For information about future operating system releases and support, visit the HP online support Web site at www.hp.com/support.

Environmental specifications

- Recommended operating temperature range: 15 °C to 32 °C (59 °F to 90 °F)
- Allowable operating temperature range: 5 °C to 40 °C (41 °F to 104 °F)
- Humidity: 15% to 80% RH non-condensing; 28 °C maximum dewpoint
- Non-operating (Storage) temperature range: -40 °C to 60 °C (-40 °F to 140 °F)
- In the presence of high electromagnetic fields, it is possible the output from the HP Printer may be slightly distorted
- HP recommends using a USB cable less than or equal to 3 m (10 feet) in length to minimize injected noise due to potential high electromagnetic fields

Input tray capacity

Plain paper sheets (80 g/m² [20lb]): Up to 50

Envelopes: Up to 5

Index cards: Up to 20

Photo paper sheets: Up to 20

Output tray capacity

Plain paper sheets (80 g/m² [20lb]): Up to 30

Envelopes: Up to 5

Index cards: Up to 10

Photo paper sheets: Up to 10

Paper size

For a complete list of supported media sizes, see the printer software.

Paper weights

Plain Paper: 64 to 90 g/m² (16 to 24 lb)

Envelopes: 75 to 90 g/m² (20 to 24 lb)

Cards: Up to 200 g/m² (110-lb index maximum)

Photo Paper: Up to 280 g/m² (75 lb)

Print specifications

- Print speeds vary according to the complexity of the document
- Method: drop-on-demand thermal inkjet
- Language: PCL3 GUI

Print resolution

Draft mode

- Color Input/Black Render: 300x300dpi
- Output (Black/Color): Automatic

Normal mode

- Color Input/Black Render: 600x300dpi
- Output (Black/Color): Automatic

Plain-Best mode

- Color Input/Black Render: 600x600dpi
- Output: 600x1200dpi (Black), Automatic (Color)

Photo-Best mode

- Color Input/Black Render: 600x600dpi
- Output (Black/Color): Automatic

Max DPI mode

- Color Input/Black Render: 1200x1200dpi
- Output: Automatic (Black), 4800x1200 optimized dpi (Color)

Power specifications

0957-2286

- Input voltage: 100-240Vac (+/- 10%)
- Input frequency: 50/60 Hz (+/- 3Hz)

0957-2290

- Input voltage: 200-240Vac (+/- 10%)
- Input frequency: 50/60 Hz (+/- 3Hz)



NOTE: Use only with the power adapter supplied by HP.

Cartridge yield

Visit www.hp.com/go/learnaboutsupplies for more information on estimated cartridge yields.

Acoustic information

If you have Internet access, you can get acoustic information from the HP Web site. Go to: www.hp.com/support.

Environmental product stewardship program

Hewlett-Packard is committed to providing quality products in an environmentally sound manner. Design for recycling has been incorporated into this product. The number of materials has been kept to a minimum while ensuring proper functionality and reliability. Dissimilar materials have been designed to separate easily. Fasteners and other connections are easy to locate, access, and remove using common tools. High priority parts have been designed to access quickly for efficient disassembly and repair.

For more information, visit HP's Commitment to the Environment Web site at:

www.hp.com/hpinfo/globalcitizenship/environment/index.html

This section contains the following topics:

- [Eco-Tips](#)
- [Paper use](#)
- [Plastics](#)
- [Material safety data sheets](#)
- [Recycling program](#)
- [HP inkjet supplies recycling program](#)
- [Power consumption](#)
- [Disposal of waste equipment by users in private households in the European Union](#)
- [Chemical Substances](#)
- [Toxic and hazardous substance table](#)

Eco-Tips

HP is committed to helping customers reduce their environmental footprint. HP has provided the Eco-Tips below to help you focus on ways to assess and reduce the impact of your printing choices. In addition to specific features in this product, please visit the HP Eco Solutions web site for more information on HP's environmental initiatives.

www.hp.com/hpinfo/globalcitizenship/environment/

Your product's Eco features

- **Energy Savings information:** To determine the ENERGY STAR® qualification status for this product, see www.hp.com/go/energystar.
- **Recycled Materials:** For more information regarding recycling of HP products, please visit: www.hp.com/hpinfo/globalcitizenship/environment/recycle/

Paper use

This product is suited for the use of recycled paper according to DIN 19309 and EN 12281:2002.

Plastics

Plastic parts over 25 grams are marked according to international standards that enhance the ability to identify plastics for recycling purposes at the end of product life.

Material safety data sheets

Material safety data sheets (MSDS) can be obtained from the HP Web site at:

www.hp.com/go/msds

Recycling program

HP offers an increasing number of product return and recycling programs in many countries/regions, and partners with some of the largest electronic recycling centers throughout the world. HP

conserves resources by reselling some of its most popular products. For more information regarding recycling of HP products, please visit:

www.hp.com/hpinfo/globalcitizenship/environment/recycle/

HP inkjet supplies recycling program

HP is committed to protecting the environment. The HP Inkjet Supplies Recycling Program is available in many countries/regions, and lets you recycle used print cartridges and ink cartridges free of charge. For more information, go to the following Web site:

www.hp.com/hpinfo/globalcitizenship/environment/recycle/

Power consumption

Hewlett-Packard printing and imaging equipment marked with the ENERGY STAR® logo is qualified to the U.S. Environmental Protection Agency's ENERGY STAR specifications for imaging equipment. The following mark will appear on ENERGY STAR qualified imaging products:



Additional ENERGY STAR qualified imaging product model information is listed at: www.hp.com/go/energystar

1907/2006 of the European Parliament and the Council). A chemical information report for this product can be found at: www.hp.com/go/reach.

Toxic and hazardous substance table

有毒有害物质表						
根据中国《电子信息产品污染控制管理办法》						
零件描述	有毒有害物质和元素					
	铅	汞	镉	六价铬	多溴联苯	多溴联苯醚
外壳和托盘*	0	0	0	0	0	0
电线*	0	0	0	0	0	0
印刷电路板*	X	0	0	0	0	0
打印系统*	X	0	0	0	0	0
显示器*	X	0	0	0	0	0
喷墨打印机墨盒*	0	0	0	0	0	0
驱动光盘*	X	0	0	0	0	0
扫描仪*	X	X	0	0	0	0
网络配件*	X	0	0	0	0	0
电路板*	X	0	0	0	0	0
自动双面打印系统*	0	0	0	0	0	0
外部电源*	X	0	0	0	0	0

0: 指此部件的所有均一材质中包含的这种有毒有害物质, 含量低于SJ/T11363-2006 的限制
X: 指此部件使用的均一材质中至少有一种包含的这种有毒有害物质, 含量高于SJ/T11363-2006 的限制
注: 环保使用期限的参考标识取决于产品正常工作的温度和湿度等条件
*以上只适用于使用这些部件的产品

Regulatory notices

The HP Printer meets product requirements from regulatory agencies in your country/region.

This section contains the following topics:

- [Regulatory model identification number](#)
- [FCC statement](#)
- [Notice to users in Korea](#)
- [VCCI \(Class B\) compliance statement for users in Japan](#)
- [Notice to users in Japan about the power cord](#)
- [HP Deskjet 3000 J310 series declaration of conformity](#)
- [European Union Regulatory Notice](#)
- [Regulatory wireless statements](#)

Regulatory model identification number

For regulatory identification purposes, your product is assigned a Regulatory Model Number. The Regulatory Model Number for your product is VCVRA-1005. This regulatory number should not be confused with the marketing name (HP Deskjet 3000 J310 series, etc.) or product numbers (CB730A, etc.).

FCC statement

FCC statement

The United States Federal Communications Commission (in 47 CFR 15.105) has specified that the following notice be brought to the attention of users of this product.

This equipment has been tested and found to comply with the limits for a Class B digital device, pursuant to Part 15 of the FCC Rules. These limits are designed to provide reasonable protection against harmful interference in a residential installation. This equipment generates, uses and can radiate radio frequency energy and, if not installed and used in accordance with the instructions, may cause harmful interference to radio communications. However, there is no guarantee that interference will not occur in a particular installation. If this equipment does cause harmful interference to radio or television reception, which can be determined by turning the equipment off and on, the user is encouraged to try to correct the interference by one or more of the following measures:

- Reorient the receiving antenna.
- Increase the separation between the equipment and the receiver.
- Connect the equipment into an outlet on a circuit different from that to which the receiver is connected.
- Consult the dealer or an experienced radio/TV technician for help.

For further information, contact:
Manager of Corporate Product Regulations
Hewlett-Packard Company
3000 Hanover Street
Palo Alto, Ca 94304
(650) 857-1501

Modifications (part 15.21)

The FCC requires the user to be notified that any changes or modifications made to this device that are not expressly approved by HP may void the user's authority to operate the equipment.

This device complies with Part 15 of the FCC Rules. Operation is subject to the following two conditions: (1) this device may not cause harmful interference, and (2) this device must accept any interference received, including interference that may cause undesired operation.

Notice to users in Korea

B 급 기기 (가정용 방송통신기기)	이 기기는 가정용(B급)으로 전자파적합등록을 한 기기로서 주로 가정에서 사용하는 것을 목적으로 하며, 모든 지역에서 사용할 수 있습니다.
------------------------	--

VCCI (Class B) compliance statement for users in Japan

この装置は、クラスB情報技術装置です。この装置は、家庭環境で使用することを目的としていますが、この装置がラジオやテレビジョン受信機に近接して使用されると、受信障害を引き起こすことがあります。取扱説明書に従って正しい取り扱いをして下さい。

VCCI-B

Notice to users in Japan about the power cord

製品には、同梱された電源コードをお使い下さい。
同梱された電源コードは、他の製品では使用出来ません。

HP Deskjet 3000 J310 series declaration of conformity



DECLARATION OF CONFORMITY

according to ISO/IEC 17050-1 and EN 17050-1

DoC #: VCVRA-1005-01

Supplier's Name: Hewlett-Packard Company
Supplier's Address: SE 34th Street, Vancouver, WA 98683-8906, USA

declares, that the product

Product Name and Model: HP Deskjet 3000 printer J310 series
Regulatory Model Number:¹⁾ VCVRA-1005
Product Options: All
Radio Module: SDGOB-0892
Power Adapters: 0957-2286
0957-2290 (China and India only)

conforms to the following Product Specifications and Regulations:

EMC: Class B

CISPR 22:2005 + A1:2005 + A2:2006 / EN 55022:2006 + A1:2007
CISPR 24:1997 +A1:2001 +A2:2002 / EN 55024:1998 +A1:2001 +A2:2003
IEC 61000-3-2: 2005 / EN 61000-3-2:2006
IEC 61000-3-3: 1994 + A1:2001 / EN 61000-3-3:1995 +A1:2001 + A2:2005
FCC CFR 47 Part 15 / ICES-003, issue 4

Safety:

IEC 60950-1:2005 / EN 60950-1:2006
IEC 60825-1:1993 +A1:1997 +A2:2001 / EN 60825-1:1994 +A1:2002 +A2:2001
IEC 62311: 2007 / EN 62311:2008

Telecom:

EN 300 328 V1.7.1
EN 301 489-1 V1.6.1
EN 301 489-17 V1.3.2

Energy Use:

Regulation (EC) No. 1275/2008
ENERGY STAR® Qualified Imaging Equipment Operational Mode (OM) Test Procedure

This device complies with part 15 of the FCC Rules. Operation is subject to the following two conditions:
(1) This device may not cause harmful interference, and (2) this device must accept any interference received, including interference that may cause undesired operation.

The product herewith complies with the requirements of the Low Voltage Directive 2006/95/EC, the EMC Directive 2004/108/EC, the EuP Directive 2005/32/EC, the R&TTE Directive 1999/5/EC and the European Council Recommendation 1999/519/EC on the limitation of Electromagnetic fields to the general public, and carries the **CE** marking accordingly.

Additional Information:

- 1) This product is assigned a Regulatory Model Number which stays with the regulatory aspects of the design. The Regulatory Model Number is the main product identifier in the regulatory documentation and test reports, this number should not be confused with the marketing name or the product numbers.

November 3, 2009
Vancouver, WA

Local contact for regulatory topics only:

EMEA: Hewlett-Packard GmbH, HQ-TRE, Herrenberger Strasse 140, 71034 Boeblingen, Germany
U.S.: Hewlett-Packard, 3000 Hanover St., Palo Alto 94304, U.S.A. 650-857-1501

www.hp.com/go/certificates

European Union Regulatory Notice

European Union Regulatory Notice

Products bearing the CE marking comply with the following EU Directives:

- Low Voltage Directive 2006/95/EC
- EMC Directive 2004/108/EC
- EuP Directive 2005/32/EC

CE compliance of this product is valid only if powered with the correct CE-marked AC adapter provided by HP.

If this product has telecommunications functionality, it also complies with the essential requirements of the following EU Directive:

- R&TTE Directive 1999/5/EC

Compliance with these directives implies conformity to harmonized European standards (European Norms) that are listed in the EU Declaration of Conformity issued by HP for this product or product family. This compliance is indicated by one of the following conformity markings placed on the product.

The following CE marking is valid for non-telecommunications products and for EU harmonized telecommunication products, such as wired fax, and wireless Bluetooth.



The following CE marking is valid for EU non-harmonized telecommunications products, such as wireless LAN.



The wireless telecommunications functionality of this product may be used in the following EU and EFTA countries:

Austria, Belgium, Bulgaria, Cyprus, Czech Republic, Denmark, Estonia, Finland, France, Germany, Greece, Hungary, Iceland, Ireland, Italy, Latvia, Liechtenstein, Lithuania, Luxembourg, Malta, Netherlands, Norway, Poland, Portugal, Slovak Republic, Romania, Slovenia, Spain, Sweden, Switzerland, and United Kingdom.

Regulatory wireless statements

This section contains the following regulatory information pertaining to wireless products:

- [Exposure to radio frequency radiation](#)
- [Notice to users in Brazil](#)
- [Notice to users in Canada](#)
- [Notice to users in Taiwan](#)
- [European Union regulatory notice](#)

Exposure to radio frequency radiation

Exposure to radio frequency radiation



Caution The radiated output power of this device is far below the FCC radio frequency exposure limits. Nevertheless, the device shall be used in such a manner that the potential for human contact during normal operation is minimized. This product and any attached external antenna, if supported, shall be placed in such a manner to minimize the potential for human contact during normal operation. In order to avoid the possibility of exceeding the FCC radio frequency exposure limits, human proximity to the antenna shall not be less than 20 cm (8 inches) during normal operation.

Notice to users in Brazil

Aviso aos usuários no Brasil

Este equipamento opera em caráter secundário, isto é, não tem direito à proteção contra interferência prejudicial, mesmo de estações do mesmo tipo, e não pode causar interferência a sistemas operando em caráter primário. (Res.ANATEL 282/2001).

Notice to users in Canada

Notice to users in Canada/Note à l'attention des utilisateurs canadiens

For Indoor Use. This digital apparatus does not exceed the Class B limits for radio noise emissions from the digital apparatus set out in the Radio Interference Regulations of the Canadian Department of Communications. The internal wireless radio complies with RSS 210 and RSS GEN of Industry Canada.

Utiliser à l'intérieur. Le présent appareil numérique n'émet pas de bruit radioélectrique dépassant les limites applicables aux appareils numériques de la classe B prescrites dans le Règlement sur le brouillage radioélectrique édicté par le ministère des Communications du Canada. Le composant RF interne est conforme à la norme RSS-210 and RSS GEN d'Industrie Canada.

Notice to users in Taiwan

低功率電波輻射性電機管理辦法

第十二條

經型式認證合格之低功率射頻電機，非經許可，公司、商號或使用者均不得擅自變更頻率、加大功率或變更設計之特性及功能。

第十四條

低功率射頻電機之使用不得影響飛航安全及干擾合法通信；經發現有干擾現象時，應立即停用，並改善至無干擾時方得繼續使用。

前項合法通信，指依電信法規定作業之無線電通信。低功率射頻電機須忍受合法通信或工業、科學及醫藥用電波輻射性電機設備之干擾。

European Union regulatory notice

Products with 2.4-GHz wireless LAN devices

France

L'utilisation de cet équipement (2.4 GHz Wireless LAN) est soumise a certaines restrictions: Cet équipement peut être utilisé à l'intérieur d'un bâtiment en utilisant toutes les fréquences de 2400 à 2483.5 MHz (Chaîne 1-13). Pour une utilisation en environnement extérieur, vous devez utiliser les fréquences comprises entre 2400-2454 MHz (Chaîne 1-9). Pour les dernières restrictions, voir <http://www.arcep.fr>

Italia

E' necessaria una concessione ministeriale anche per l'uso del prodotto. Verifici per favore con il proprio distributore o direttamente presso la Direzione Generale Pianificazione e Gestione Frequenze.

Index

A

after the support period 42

C

customer support
warranty 42

E

environment
Environmental product
stewardship program 45
environmental
specifications 43

I

interface card 29, 30

N

network
interface card 29, 30

P

paper
recommended types 15
phone support 41
phone support period
period for support 41
print
specifications 44

R

recycle
ink cartridges 46
regulatory notices
regulatory model
identification number 48
wireless statements 52

S

support process 41
system requirements 43

T

technical information
environmental
specifications 43
print specifications 44
system requirements 43

W

warranty 42

