

HP Pavilion Entertainment PC

User Guide

© Copyright 2010 Hewlett-Packard
Development Company, L.P.

Bluetooth is a trademark owned by its proprietor and used by Hewlett-Packard Company under license. Microsoft and Windows are U.S. registered trademarks of Microsoft Corporation. SD Logo is a trademark of its proprietor.

The information contained herein is subject to change without notice. The only warranties for HP products and services are set forth in the express warranty statements accompanying such products and services. Nothing herein should be construed as constituting an additional warranty. HP shall not be liable for technical or editorial errors or omissions contained herein.

Second Edition: June 2010

First Edition: May 2010

Document Part Number: 602650-002

Product notice

This user guide describes features that are common to most models. Some features may not be available on your computer.

To obtain the latest version of the *User Guide*, go to the HP Web site at <http://www.hp.com/support>.

Safety warning notice

-
- △ **WARNING!** To reduce the possibility of heat-related injuries or of overheating the computer, do not place the computer directly on your lap or obstruct the computer air vents. Use the computer only on a hard, flat surface. Do not allow another hard surface, such as an adjoining optional printer, or a soft surface, such as pillows or rugs or clothing, to block airflow. Also, do not allow the AC adapter to contact the skin or a soft surface, such as pillows or rugs or clothing, during operation. The computer and the AC adapter comply with the user-accessible surface temperature limits defined by the International Standard for Safety of Information Technology Equipment (IEC 60950).
-

Table of contents

1 Getting started	1
Using HP QuickWeb (select models only)	1
2 Features	2
Identifying hardware	2
Components	2
Top components	2
TouchPad	2
Lights	3
Keys	4
Front components	5
Right-side components	5
Left-side components	6
Bottom components	8
Display components	9
Wireless antennas	10
Additional hardware components	11
Labels	11
3 Wireless and local area networks	13
Using wireless devices	13
Identifying wireless and network status icons	13
Using the wireless controls	14
Using the wireless button	14
Using Wireless Assistant software	15
Using HP Connection Manager (select models only)	15
Using operating system controls	15
Using a WLAN	16
Setting up a WLAN	16
Protecting your WLAN	16
Roaming to another network	17
Using HP Mobile Broadband (select models only)	17
Inserting a SIM	18
Removing a SIM	19
Using Bluetooth wireless devices	19
Bluetooth and Internet Connection Sharing (ICS)	20
Troubleshooting wireless connection problems	20
Cannot connect to a WLAN	20

Cannot connect to a preferred WLAN network	21
Network icon for WLAN is not displayed	21
Current WLAN network security codes are unavailable	21
WLAN connection is very weak	22
Cannot connect to the wireless router	22
Connecting to a local area network (LAN)	22

4 Pointing devices and keyboard 24

Using pointing devices	24
Setting pointing device preferences	24
Using the TouchPad	24
Two-finger scrolling	24
Rotating (select models only)	25
Pinching (select models only)	25
Using the action keys	26
Using the hotkeys	27
Using keypads	28
Using the embedded numeric keypad	29
Enabling and disabling the embedded numeric keypad	29
Switching key functions on the embedded numeric keypad	30
Using an optional external numeric keypad	30
Cleaning the TouchPad and keyboard	30

5 Multimedia 31

Multimedia features	31
Adjusting the volume	31
Using the media activity keys	32
Multimedia software	32
Using HP MediaSmart software	33
Using multimedia software	33
Installing multimedia software from a disc	33
Audio	33
Connecting external audio devices	34
Checking your audio functions	34
Video	35
Connecting an external monitor or projector	35
Connecting an HDMI device	35
Configuring audio for HDMI (select models only)	36
Webcam	36
Webcam tips	37
Adjusting webcam properties	37

6 Power management	38
Setting power devices	38
Using power-saving states	38
Initiating and exiting Sleep	38
Initiating and exiting Hibernation	39
Using the battery meter	39
Using power plans	39
Viewing the current power plan	39
Selecting a different power plan	40
Customizing power plans	40
Setting password protection on wakeup	40
Using external AC power	40
Connecting AC power	41
Testing an AC adapter	41
Using battery power	42
Finding battery information in Help and Support	42
Using Battery Check	42
Displaying the remaining battery charge	43
Inserting or removing the battery	43
Charging a battery	44
Maximizing battery discharge time	45
Managing low battery levels	45
Identifying low battery levels	45
Resolving a low battery level	46
Resolving a low battery level when external power is available	46
Resolving a low battery level when a charged battery is available ...	46
Resolving a low battery level when no power source is available ...	46
Resolving a low battery level when the computer cannot exit	
Hibernation	46
Calibrating a battery	46
Step 1: Fully charge the battery	46
Step 2: Disable Hibernation and Sleep	47
Step 3: Discharge the battery	47
Step 4: Fully recharge the battery	48
Step 5: Reenable Hibernation and Sleep	48
Conserving battery power	48
Storing a battery	49
Disposing of a used battery	49
Replacing the battery	49
Shutting down the computer	49

7 Memory modules	51
-------------------------------	-----------

8 Drives and external devices	54
Drives	54
Identifying installed drives	54
Handling drives	54
Improving hard drive performance	55
Using Disk Defragmenter	55
Using Disk Cleanup	56
Replacing the hard drive in the hard drive bay	56
Using HP ProtectSmart Hard Drive Protection (select models only)	58
Identifying HP ProtectSmart Hard Drive Protection status	58
Managing power with a parked hard drive	59
Using HP ProtectSmart Hard Drive Protection software	59
Using external drives	59
Connecting optional external drives	60
Sharing optical drives	60
External devices	61
Using a USB device	61
Connecting a USB device	61
Removing a USB device	61
Using Digital Media Slot cards	62
Inserting a digital card	62
Removing a digital card	63
9 Security	64
Protecting the computer	64
Using passwords	64
Setting passwords in Windows	65
Setting passwords in Setup Utility	65
Administrator password	66
Managing an administrator password	66
Entering an administrator password	66
Power-on password	67
Managing a power-on password	67
Entering a power-on password	67
Using antivirus software	67
Using firewall software	68
Installing critical security updates	68
Installing an optional security cable	68
10 Changing QuickWeb settings	70
Turning HP QuickWeb on and off	70

Appendix A Setup Utility (BIOS)	71
Starting Setup Utility	71
Using Setup Utility	71
Navigating and selecting in Setup Utility	71
Changing the language of Setup Utility	71
Displaying system information	72
Restoring default settings in Setup Utility	72
Exiting Setup Utility	73
Setup Utility menus	73
Main menu	73
Security menu	73
System Configuration menu	73
Diagnostics menu	74
Updating the BIOS	74
Determining the BIOS version	74
Downloading a BIOS update	75
Updating programs and drivers	76
Appendix B Backup and recovery	77
Creating recovery discs	77
Backing up your information	78
Using Windows Backup and Restore	79
Using system restore points	79
When to create restore points	79
Create a system restore point	79
Restore to a previous date and time	80
Performing a recovery	80
Recovering using the recovery discs	80
Recovering using the dedicated recovery partition	80
Index	81

1 Getting started

Your computer's main operating system is Microsoft® Windows®. Your computer may also feature HP QuickWeb (select models only).

- The Microsoft Windows operating system displays the desktop on the display and controls your computer's hardware, peripherals, and software programs.
- If your computer includes QuickWeb, it allows you to quickly browse the Internet, view digital photos, listen to music, or keep in touch using e-mail, instant messages, or Skype (select models only), without having to start your main operating system.

 **NOTE:** To disable or reenable QuickWeb, refer to the "Changing QuickWeb settings" chapter. To learn more about QuickWeb, refer to the software Help included with QuickWeb, which can be accessed by clicking the **Help** icon in the notification area.

Using HP QuickWeb (select models only)

To start QuickWeb:

1. Turn on your computer. The HP QuickWeb Home screen appears.
2. Click an icon on the QuickWeb Home screen to launch an application.

To start QuickWeb from Microsoft Windows:

- ▲ Select **Start**, click the arrow next to the Shut down button, and then click **Restart**. Your computer restarts and displays the HP QuickWeb Home screen.

– or –

- ▲ Select **Start > All Programs > HP QuickWeb**. Click **HP QuickWeb Configuration Tool**. Click the **Home** tab, and then select the **Go** button located next to **Do you want to shut down Windows and go to QuickWeb?**

 **NOTE:** To learn more about HP QuickWeb, refer to the QuickWeb software Help.

2 Features

Identifying hardware

To see a list of hardware installed in the computer, select **Start > Control Panel > System and Security**. Then in the **System** area, click **Device Manager**.

You can also add hardware or modify device configurations using Device Manager.

 **NOTE:** Windows® includes the User Account Control feature to improve the security of your computer. You may be prompted for your permission or password for tasks such as installing software, running utilities, or changing Windows settings. Refer to Help and Support for more information.

Components

Top components

TouchPad

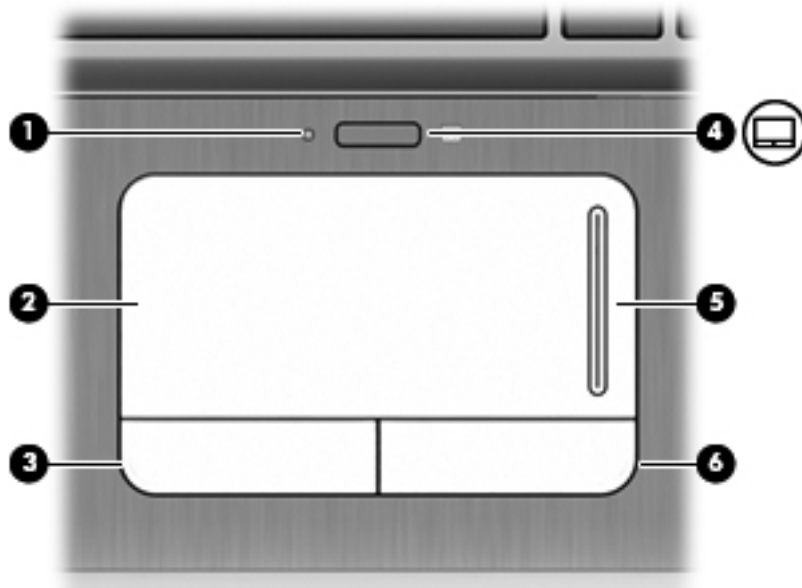

Component	Description
(1) TouchPad light	<ul style="list-style-type: none">• White: TouchPad is enabled.• Amber: TouchPad is disabled.
(2) TouchPad*	Moves the pointer and selects or activates items on the screen.
(3) Left TouchPad button*	Functions like the left button on an external mouse.

Component	Description	
(4)	TouchPad on/off button	Enables/disables the TouchPad.
(5)	TouchPad scroll zone	Scrolls up or down.
(6)	Right TouchPad button*	Functions like the right button on an external mouse.

*This table describes factory settings. To view and change pointing device preferences, select **Start > Devices and Printers**. Then, right-click the device representing your computer, and click **Mouse settings**.

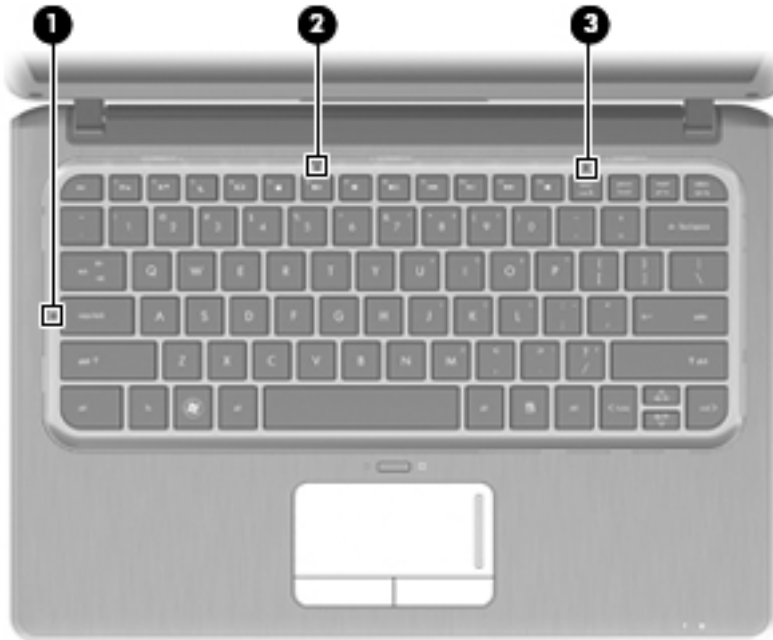

Lights

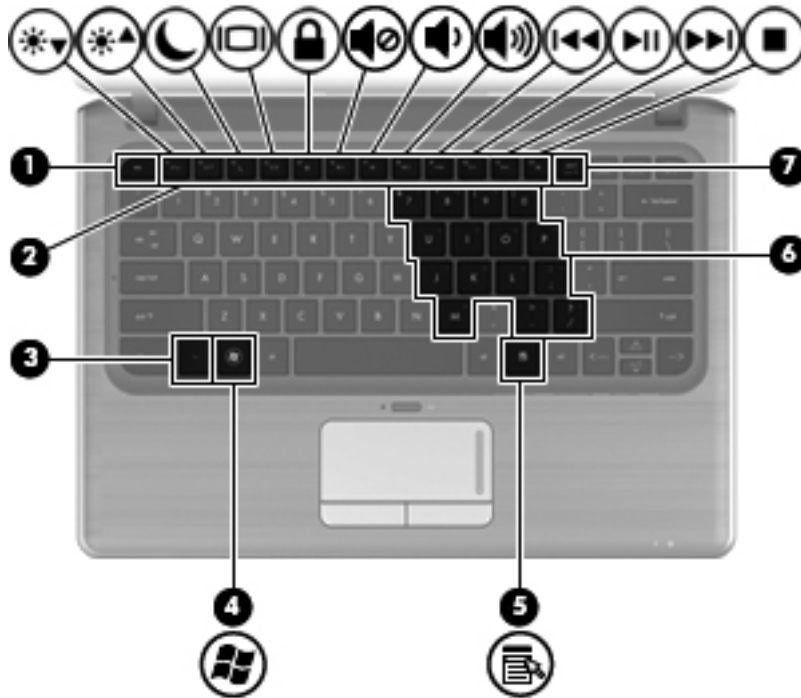

Component	Description	
(1)	Caps lock light	On: Caps lock is on.
(2)	Mute light	On: Computer sound is off.
(3)	Num lock light	On: The embedded numeric keypad is enabled or num lock is on for an optional external numeric keypad.

Keys



Component	Description
(1) <code>esc</code> key	Displays system information when pressed in combination with the <code>fn</code> key.
(2) Action keys	Execute frequently used system functions.
(3) <code>fn</code> key	Executes frequently used system functions when pressed in combination with an arrow key, the <code>num lk</code> key, or the <code>esc</code> key.
(4)  Windows logo key	Displays the Windows Start menu.
(5)  Windows applications key	Displays a shortcut menu for items beneath the pointer.
(6) Embedded numeric keypad keys	When the keypad has been enabled, the keys can be used like the keys on an external numeric keypad.
(7) <code>num lk</code> key	Enables/disables the embedded numeric keypad when pressed in combination with the <code>fn</code> key.

Front components



Component	Description
(1) Speakers (2)	Produce sound.
(2) Battery light	<p>On: A battery is charging.</p> <p>Blinking: A battery that is the only available power source has reached a low battery level. When the battery reaches a critical battery level, the battery light begins blinking rapidly.</p> <p>Off: If the computer is plugged into an external power source, the light is turned off when all batteries in the computer are fully charged. If the computer is not plugged into an external power source, the light stays off until the battery reaches a low battery level.</p>
(3) Drive light	<p>White: The hard drive is being accessed.</p> <p>Blinking: The hard drive or an optional external optical drive is being accessed.</p> <p>Amber: HP ProtectSmart Hard Drive Protection has temporarily parked the hard drive.</p>

Right-side components

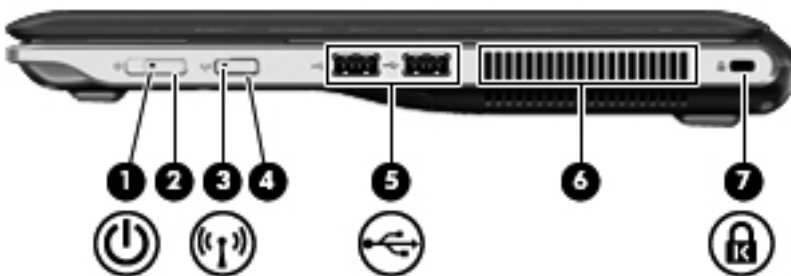

Component	Description
(1) Power light	<ul style="list-style-type: none"> On: The computer is on. Blinking: The computer is in the Sleep state. Off: The computer is off or in Hibernation.

Component	Description
(2) Power switch	<ul style="list-style-type: none"> When the computer is off, slide the switch to turn on the computer. When the computer is on, slide the switch briefly to initiate Sleep. When the computer is in the Sleep state, slide the switch briefly to exit Sleep. When the computer is in Hibernation, slide the switch briefly to exit Hibernation. <p>If the computer has stopped responding and Windows® shutdown procedures are ineffective, slide and hold the power switch for at least 5 seconds to turn off the computer.</p> <p>To learn more about your power settings, select Start > Control Panel > System and Security > Power Options.</p>
(3) Wireless light	<ul style="list-style-type: none"> Blue: An integrated wireless device, such as a wireless local area network (WLAN) device, a wireless wide area network (WWAN) device, and/or a Bluetooth® device, is on. Amber: All wireless devices are off.
(4) Wireless button	<p>Turns the wireless feature on or off but does not create a wireless connection.</p> <p>NOTE: To establish a wireless connection, a wireless network must already be set up.</p>
(5) USB ports (2)	<p>Connect optional USB devices.</p> <p>NOTE: Select models include an optional external USB optical disc drive. For more information, refer to the printed <i>Quick Setup</i> poster.</p>
(6) Vent	<p>Enables airflow to cool internal components.</p> <p>NOTE: The computer fan starts up automatically to cool internal components and prevent overheating. It is normal for the internal fan to cycle on and off during routine operation.</p>
(7) Security cable slot	<p>Attaches an optional security cable to the computer.</p> <p>NOTE: The security cable is designed to act as a deterrent, but it may not prevent the computer from being mishandled or stolen.</p>

Left-side components

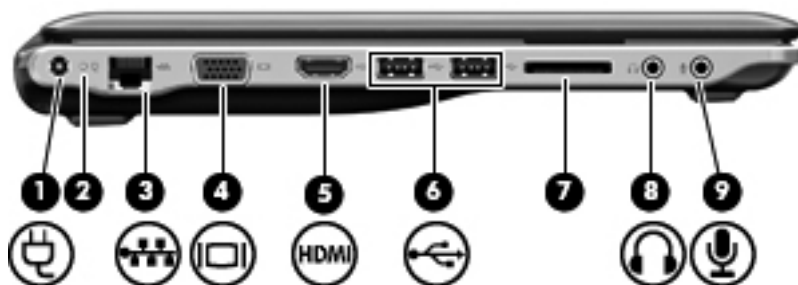

Component	Description
(1) Power connector	Connects an AC adapter.

Component	Description
(2) AC adapter light	<ul style="list-style-type: none"> • On: The computer is connected to external power. • Off: The computer is not connected to external power.
(3) RJ-45 (network) jack	Connects a network cable.
(4) External monitor port	Connects an external VGA monitor or projector.
(5) HDMI port	Connects an optional video or audio device, such as a high-definition television, or any compatible digital or audio component.
(6) USB ports (2)	<p>Connect optional USB devices.</p> <p>NOTE: Select models can be configured with an optional external USB optical disc drive. For more information, refer to the printed <i>Quick Setup</i> poster.</p>
(7) Digital Media Slot	<p>Supports the following digital card formats:</p> <ul style="list-style-type: none"> • Memory Stick (MS) • Memory Stick Pro (MSP) • MultiMediaCard (MMC) • Secure Digital (SD) Memory Card • Secure Digital High Capacity (SDHC) Memory Card • xD-Picture Card (XD) • xD-Picture Card (XD) Type H • xD-Picture Card (XD) Type M
(8) Audio-out (headphone) jack	<p>Produces sound when connected to optional powered stereo speakers, headphones, ear buds, a headset, or television audio.</p> <p>NOTE: When a device is connected to the headphone jack, the computer speakers are disabled.</p>
(9) Audio-in (microphone) jack	Connects an optional computer headset microphone, stereo array microphone, or monaural microphone.

Bottom components

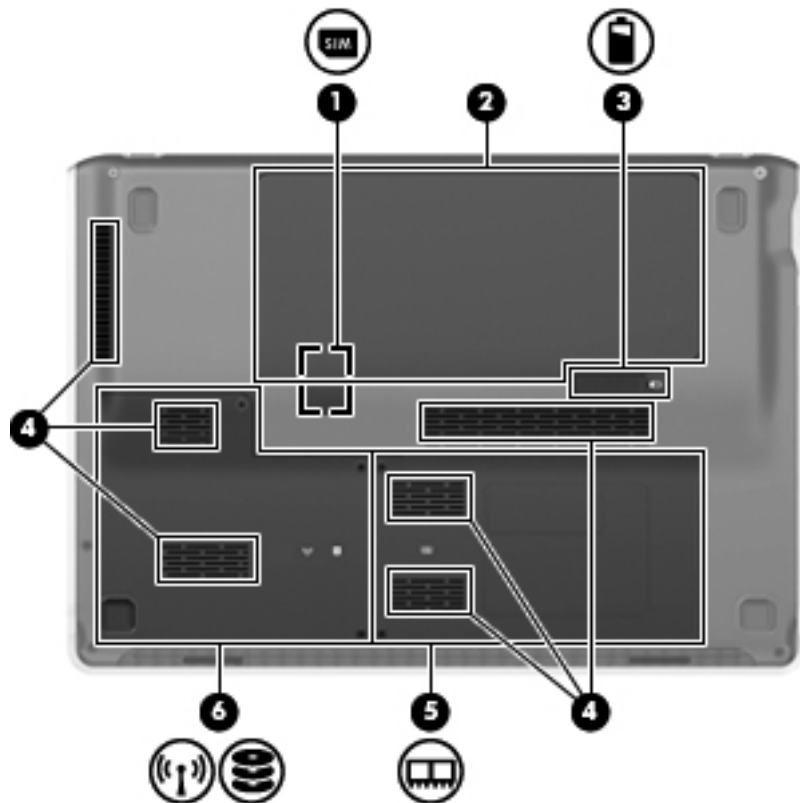

Component	Description
(1) Subscriber identity module (SIM) slot (select models only)	Located inside the battery bay.
(2) Battery bay	Holds the battery.
(3)  Battery release latch	Releases the battery from the battery bay.
(4) Vents (6)	Enable airflow to cool internal components. NOTE: The computer fan starts up automatically to cool internal components and prevent overheating. It is normal for the internal fan to cycle on and off during routine operation.

Component	Description
(5) Memory module compartment	<p>Contains the memory module slot (2 slots on select models) and wireless LAN (WLAN) module.</p> <p>CAUTION: To prevent an unresponsive system, replace the wireless module only with a wireless module authorized for use in the computer by the governmental agency that regulates wireless devices in your country or region. If you replace the module and then receive a warning message, remove the module to restore computer functionality, and then contact technical support through Help and Support.</p>
(6) Hard drive bay	<p>Holds the hard drive and, on select models, a wireless wide area network (WWAN) module.</p> <p>CAUTION: To prevent an unresponsive system, replace the wireless module only with a wireless module authorized for use in the computer by the governmental agency that regulates wireless devices in your country or region. If you replace the module and then receive a warning message, remove the module to restore computer functionality, and then contact technical support through Help and Support.</p>

Display components

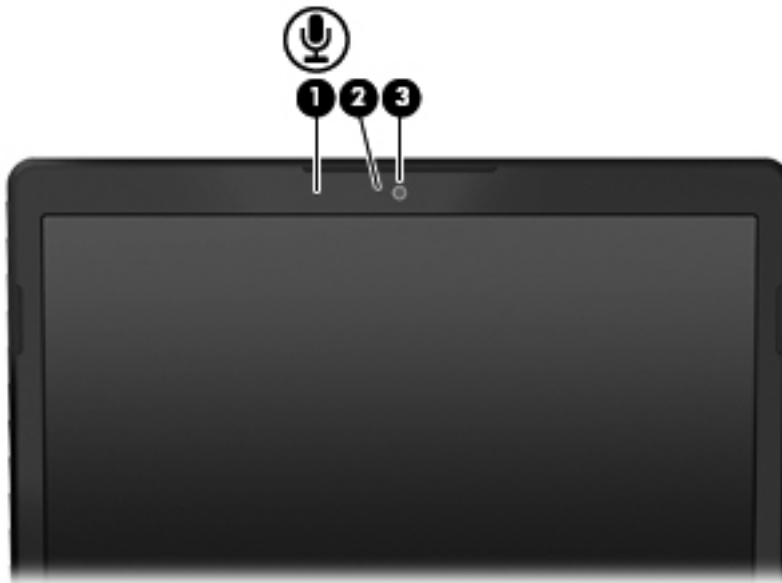

Component	Description
(1) Internal microphone	Records sound.
(2) Webcam light	On: The webcam is in use.
(3) Webcam	Records video and captures still photographs.

Wireless antennas

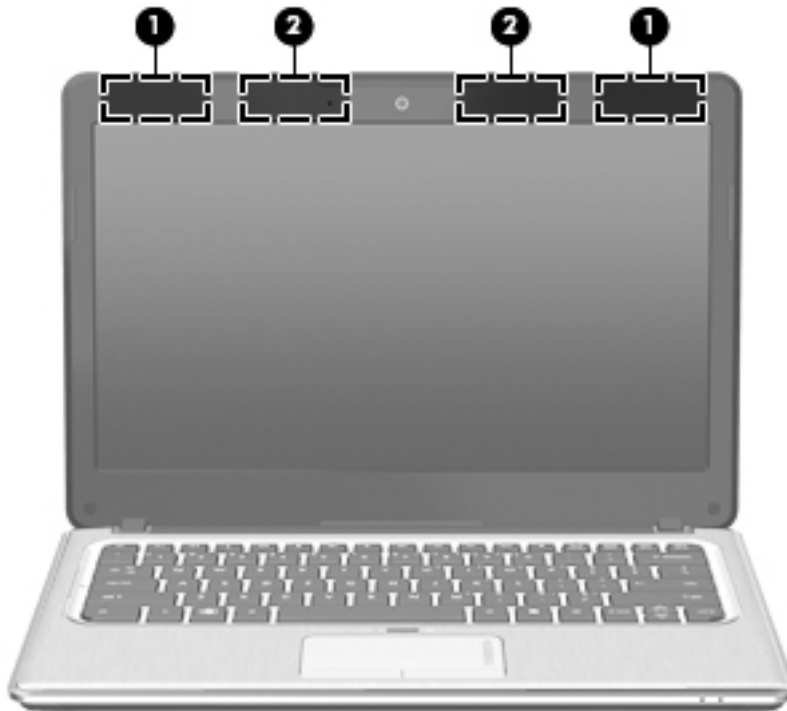

Component	Description
(1) WWAN antennas (2) (select models only)*	Send and receive wireless signals to communicate with wireless wide-area networks (WWANs).
(2) WLAN antennas (2)*	Send and receive wireless signals to communicate with wireless local area networks (WLANs).

*The antennas are not visible from the outside of the device. For optimal transmission, keep the areas immediately around the antennas free from obstructions.

To see wireless regulatory notices, refer to the section of the *Regulatory, Safety and Environmental Notices* that applies to your country or region. These notices are located in Help and Support.

Additional hardware components



Component	Description
(1) Power cord*	Connects the AC adapter.
(2) AC adapter	Converts AC power to DC power.
(3) Battery	Powers the computer when the computer is not plugged into external power.

*Power cords vary in appearance by country or region.

Labels

The labels affixed to the computer provide information you may need when you troubleshoot system problems or travel internationally with the computer:

- Serial number label—Provides important information, including the following:

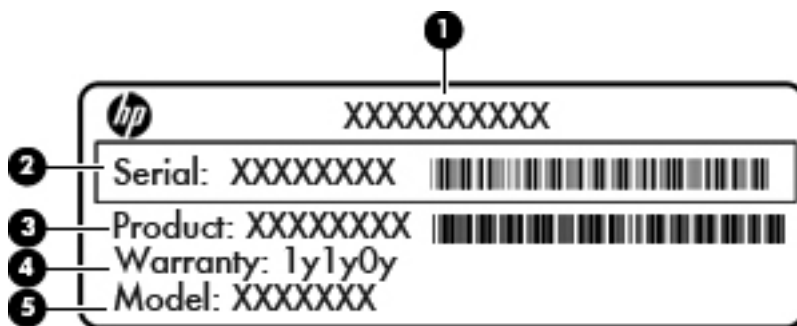

Component	Description
(1)	Product name
(2)	Serial number
(3)	Product number

(4)	Warranty period
(5)	Model description (select models)

Have this information available when you contact technical support. The serial number label is affixed to the bottom of the computer.

- Microsoft® Certificate of Authenticity—Contains the Windows Product Key. You may need the Product Key to update or troubleshoot the operating system. The Microsoft Certificate of Authenticity is affixed to the bottom of the computer.
- Regulatory label—Provides regulatory information about the computer. The regulatory label is affixed inside the battery bay.
- Wireless certification label or labels (select models only)—Provide information about optional wireless devices and the approval markings of some of the countries or regions in which the devices have been approved for use. If your computer model includes one or more wireless devices, one or more certification labels are included with your computer. You may need this information when traveling internationally. Wireless certification labels are affixed to the bottom of the computer.
- SIM (subscriber identity module) label (select models only)—Provides the ICCID (Integrated Circuit Card Identifier) of the SIM. This label is located inside the battery bay.
- HP Mobile Broadband Module serial number label (select models only)—Provides the serial number of the HP Mobile Broadband Module. This label is located inside the battery bay.

3 Wireless and local area networks

Using wireless devices

Wireless technology transfers data across radio waves instead of wires. Your computer may be equipped with one or more of the following wireless devices:

- **Wireless local area network (WLAN) device**—Connects the computer to wireless local area networks (commonly referred to as Wi-Fi networks, wireless LANs, or WLANs) in corporate offices, your home, and public places such as airports, restaurants, coffee shops, hotels, and universities. In a WLAN, each mobile wireless device communicates with a wireless router or a wireless access point.
- **HP Mobile Broadband Module**—A wireless wide area network (WWAN) device that provides access to information wherever mobile network operator service is available. In a WWAN, each mobile device communicates to a mobile network operator’s base station. Mobile network operators install networks of base stations (similar to cell phone towers) throughout large geographic areas, effectively providing coverage across entire states, regions, or even countries.
- **Bluetooth® device**—Creates a personal area network (PAN) to connect to other Bluetooth-enabled devices such as computers, phones, printers, headsets, speakers, and cameras. In a PAN, each device communicates directly with other devices, and devices must be relatively close together—typically within 10 meters (approximately 33 feet) of each other.

Computers with WLAN devices support one or more of the following IEEE industry standards:



- 802.11b, the first popular standard, supports data rates of up to 11 Mbps and operates at a frequency of 2.4 GHz.
- 802.11g supports data rates of up to 54 Mbps and operates at a frequency of 2.4 GHz. An 802.11g WLAN device is backward compatible with 802.11b devices, so they can operate on the same network.
- 802.11a supports data rates of up to 54 Mbps and operates at a frequency of 5 GHz.





 **NOTE:** 802.11a is not compatible with 802.11b and 802.11g.

- 802.11n supports data rates of up to 450 Mbps and may operate at 2.4 GHz or 5 GHz, making it backward compatible with 802.11a, b, and g.

For more information on wireless technology, refer to the information and Web site links provided in Help and Support.

Identifying wireless and network status icons

Icon	Name	Description
	Wireless (connected)	Identifies the location of the wireless light and the wireless button on the computer. Also identifies the Wireless Assistant software on the computer and indicates that one or more of the wireless devices are on.
	Wireless (disconnected)	Identifies the Wireless Assistant software on the computer and indicates that all of the wireless devices are off.

	HP Connection Manager	Opens HP Connection Manager, which enables you to create a connection with an HP Mobile Broadband device (select models only).
	Wired network (connected)	Indicates that one or more of your network drivers are installed and one or more network devices are connected to the network.
	Wired network (disabled/disconnected)	Indicates that the following conditions exist: <ul style="list-style-type: none"> • One or more of your network drivers are installed. • All network devices or all wireless devices are disabled in Windows® Control Panel.
	Network (connected)	Indicates that the following conditions exist: <ul style="list-style-type: none"> • One or more of your network drivers are installed. • One or more network devices are connected to a wireless network. • One or more network devices are connected to a wired network.
	Network (disabled/disconnected)	Indicates that the following conditions exist: <ul style="list-style-type: none"> • One or more of your network drivers are installed. • Either no wireless connections are available or all wireless network devices are disabled by the wireless button or Wireless Assistant. • Wireless connections are available.

Using the wireless controls

You can control the wireless devices in your computer using these features:

- Wireless button or wireless switch (referred to in this guide as the wireless button)
- Wireless Assistant software
- HP Connection Manager software (select models only)
- Operating system controls

Using the wireless button

The computer has a wireless button, one or more wireless devices, and one or two wireless lights, depending on the model. All of the wireless devices on your computer are enabled at the factory, so the wireless light is on (blue) when you turn on the computer.

The wireless light indicates the overall power state of your wireless devices, not the status of individual devices. If the wireless light is blue, at least one wireless device is on. If the wireless light is off, all wireless devices are off.

 **NOTE:** On some models, the wireless light is amber when all wireless devices are off.

Because the wireless devices are enabled at the factory, you can use the wireless button to turn on or turn off the wireless devices simultaneously. Individual wireless devices can be controlled through Wireless Assistant software.

Using Wireless Assistant software

A wireless device can be turned on or off using the Wireless Assistant software. If a wireless device is disabled in Setup Utility, it must be reenabled in Setup Utility before it can be turned on or off using Wireless Assistant.

 **NOTE:** Enabling or turning on a wireless device does not automatically connect the computer to a network or a Bluetooth-enabled device.

To view the state of the wireless devices, click the **Show hidden icons** icon, the arrow at the left of the notification area, and position the mouse pointer over the wireless icon.

If the wireless icon is not displayed in the notification area, complete the following steps to change Wireless Assistant properties:

1. Select **Start > Control Panel > Hardware > Windows Mobility Center**.
2. Click the wireless icon in the Wireless Assistant tile, which is located in the bottom row of Windows® Mobility Center.
3. Click **Properties**.
4. Select the check box next to **HP Wireless Assistant icon in notification area**.
5. Click **Apply**.
6. Click **Close**.

For more information, refer to the Wireless Assistant software Help:

1. Open Wireless Assistant by clicking the wireless icon in Windows Mobility Center.
2. Click the **Help** button.

Using HP Connection Manager (select models only)

You can use HP Connection Manager to connect to WWANs using the HP Mobile Broadband device in your computer (select models only).

To start Connection Manager, click the **Connection Manager** icon in the notification area, at the far right of the taskbar.

– or –

Select **Start > All Programs > HP Connection Manager > HP Connection Manager**.

For more details about using Connection Manager, refer to the Connection Manager software Help.

Using operating system controls

Some operating systems also offer a way to manage integrated wireless devices and the wireless connection. For example, Windows provides the Network and Sharing Center that allows you to set up a connection or network, connect to a network, manage wireless networks, and diagnose and repair network problems.

To access the Network and Sharing Center, select **Start > Control Panel > Network and Internet > Network and Sharing Center**.

For more information, select **Start > Help and Support**.

Using a WLAN

With a WLAN device, you can access a wireless local area network (WLAN), which is composed of other computers and accessories that are linked by a wireless router or a wireless access point.

 **NOTE:** The terms *wireless router* and *wireless access point* are often used interchangeably.

- A large-scale WLAN, such as a corporate or public WLAN, typically uses wireless access points that can accommodate a large number of computers and accessories and can separate critical network functions.
- A home or small office WLAN typically uses a wireless router, which allows several wireless and wired computers to share an Internet connection, a printer, and files without requiring additional pieces of hardware or software.

To use the WLAN device in your computer, you must connect to a WLAN infrastructure (provided through a service provider or a public or corporate network).

Setting up a WLAN

To set up a WLAN and connect to the Internet, you need the following equipment:

- A broadband modem (either DSL or cable) **(1)** and high-speed Internet service purchased from an Internet service provider (ISP)
- A wireless router (purchased separately) **(2)**
- The wireless computer **(3)**

The illustration below shows an example of a wireless network installation that is connected to the Internet.

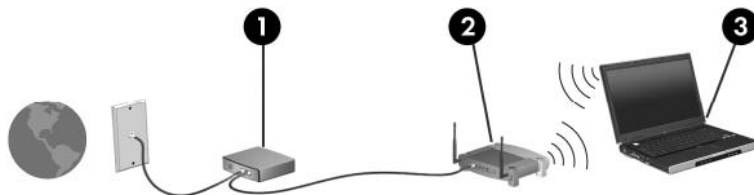

As your network grows, additional wireless and wired computers can be connected to the network to access the Internet.

For help in setting up your WLAN, refer to the information provided by your router manufacturer or your ISP.

Protecting your WLAN

Because the WLAN standard was designed with only limited security capabilities—basically to foil casual eavesdropping rather than more powerful forms of attack—it is essential to understand that WLANs are vulnerable to well-known and well-documented security weaknesses.

WLANs in public areas, or “hotspots,” like coffee shops and airports may not provide any security. New technologies are being developed by wireless manufacturers and hotspot service providers that make the public environment more secure and anonymous. If you are concerned about the security of your computer in a hotspot, limit your network activities to noncritical e-mail and basic Internet surfing.

When you set up a WLAN or access an existing WLAN, always enable security features to protect your network from unauthorized access. The common security levels are Wi-Fi Protected Access (WPA)-Personal and Wired Equivalent Privacy (WEP). Because wireless radio signals travel outside

the network, other WLAN devices can pick up unprotected signals and either connect to your network (uninvited) or capture information being sent across it. However, you can take precautions to protect your WLAN:

- **Use a wireless transmitter with built-in security**

Many wireless base stations, gateways, or routers provide built-in security features such as wireless security protocols and firewalls. With the correct wireless transmitter, you can protect your network from the most common wireless security risks.

- **Work behind a firewall**

A firewall is a barrier that checks both data and requests for data that are sent to your network, and discards any suspicious items. Firewalls are available in many varieties, both software and hardware. Some networks use a combination of both types.

- **Use wireless encryption**

A variety of sophisticated encryption protocols is available for your WLAN. Find the solution that works best for your network security:

- **Wired Equivalent Privacy (WEP)** is a wireless security protocol that encodes or encrypts all network data before it is transmitted using a WEP key. Usually, you can allow the network to assign the WEP key. Alternatively, you can set up your own key, generate a different key, or choose other advanced options. Without the correct key, others will not be able to use the WLAN.
- **WPA (Wi-Fi Protected Access)**, like WEP, uses security settings to encrypt and decrypt data that is transmitted over the network. However, instead of using one static security key for encryptions as WEP does, WPA uses “temporal key integrity protocol” (TKIP) to dynamically generate a new key for every packet. It also generates different sets of keys for each computer on the network.

Roaming to another network

When you move your computer within range of another WLAN, Windows attempts to connect to that network. If the attempt is successful, your computer is automatically connected to the new network. If Windows does not recognize the new network, follow the same procedure you used initially to connect to your WLAN.

Using HP Mobile Broadband (select models only)

HP Mobile Broadband enables your computer to use wireless wide area networks (WWANs) to access the Internet from more places and over larger areas than it can access by using WLANs. Using HP Mobile Broadband requires a network service provider (called a *mobile network operator*), which in most cases is a mobile phone network operator. Coverage for HP Mobile Broadband is similar to mobile phone voice coverage.

When used with mobile network operator service, HP Mobile Broadband gives you the freedom to stay connected to the Internet, send e-mail, or connect to your corporate network whether you are on the road or outside the range of Wi-Fi hotspots.

HP Mobile Broadband supports the following technologies:

- HSPA (High Speed Packet Access), which provides access to networks based on the Global System for Mobile Communications (GSM) telecommunications standard.
- EV-DO (Evolution Data Optimized), which provides access to networks based on the code division multiple access (CDMA) telecommunications standard.

You may need the HP Mobile Broadband Module serial number to activate mobile broadband service. The serial number is printed on a label inside the battery bay of your computer.

Some mobile network operators require the use of a subscriber identity module (SIM). A SIM contains basic information about you, such as a personal identification number (PIN), as well as network information. Some computers include a SIM that is preinstalled in the battery bay. If the SIM is not preinstalled, it may be provided in the HP Mobile Broadband information included with your computer, or the mobile network operator may provide it separately from the computer.

For information on inserting and removing the SIM, refer to the “Inserting a SIM” and “Removing a SIM” sections in this chapter.

For information on HP Mobile Broadband and how to activate service with a preferred mobile network operator, refer to the HP Mobile Broadband information included with your computer. For additional information, see the HP Web site at <http://www.hp.com/go/mobilebroadband> (US only).

Inserting a SIM

△ **CAUTION:** When inserting a SIM, position the card with the slanted corner as shown in the illustration. If a SIM is inserted backwards or upside down, the battery may not snap into place properly and could damage the SIM and the SIM connector.

To prevent damage to the connectors, use minimal force when inserting a SIM.

To insert a SIM:

1. Shut down the computer. If you are not sure whether the computer is off or in Hibernation, turn the computer on by sliding the power switch. Then shut down the computer through the operating system.
2. Close the display.
3. Disconnect all external devices connected to the computer.
4. Unplug the power cord from the AC outlet.
5. Turn the computer upside down on a flat surface, with the battery bay toward you.
6. Remove the battery.
7. Insert the SIM into the SIM slot, and gently push the SIM into the slot until it is firmly seated.

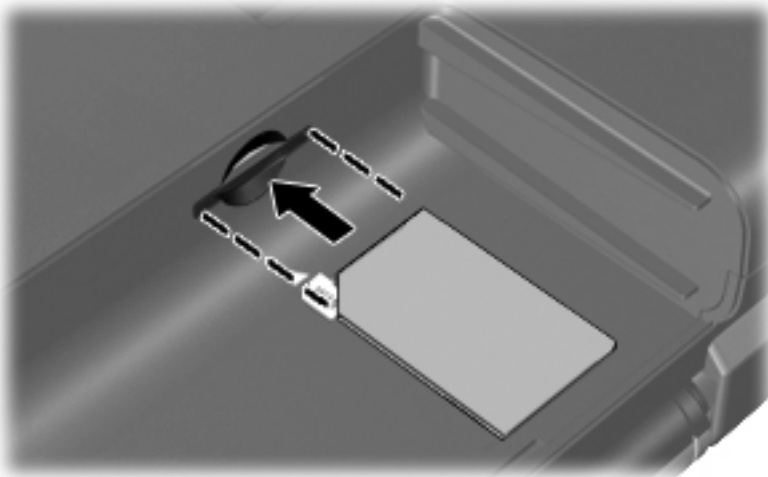

8. Replace the battery.

 **NOTE:** HP Mobile Broadband is disabled if the battery is not replaced.

9. Turn the computer right-side up, and then reconnect external power and external devices.
10. Turn on the computer.

Removing a SIM

To remove a SIM:

1. Shut down the computer. If you are not sure whether the computer is off or in Hibernation, turn the computer on by sliding the power switch. Then shut down the computer through the operating system.
2. Close the display.
3. Disconnect all external devices connected to the computer.
4. Unplug the power cord from the AC outlet.
5. Turn the computer upside down on a flat surface, with the battery bay toward you.
6. Remove the battery.
7. Press in on the SIM **(1)**, and then remove it from the slot **(2)**.

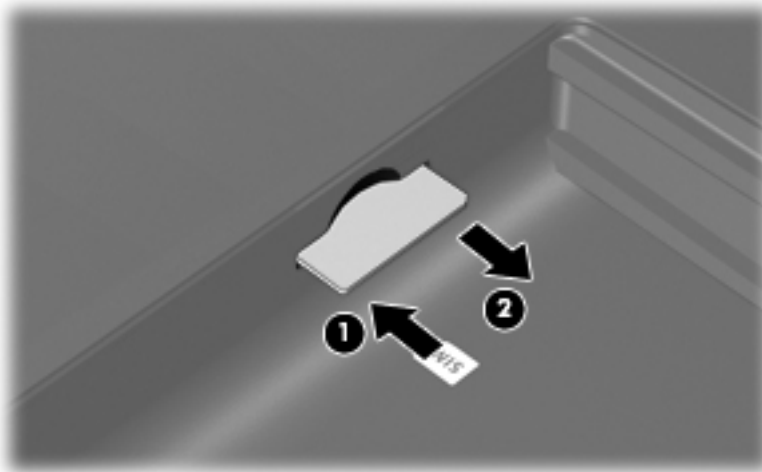

8. Replace the battery.
9. Turn the computer right-side up, and then reconnect external power and external devices.
10. Turn on the computer.

Using Bluetooth wireless devices

A Bluetooth device provides short-range wireless communications that replace the physical cable connections that traditionally link electronic devices such as the following:

- Computers (desktop, notebook, PDA)
- Phones (cellular, cordless, smart phone)
- Imaging devices (printer, camera)
- Audio devices (headset, speakers)

Bluetooth devices provide peer-to-peer capability that allows you to set up a personal area network (PAN) of Bluetooth devices. For information on configuring and using Bluetooth devices, refer to the Bluetooth software Help.

Bluetooth and Internet Connection Sharing (ICS)

HP does **not** recommend setting up one computer with Bluetooth as a host and using it as a gateway through which other computers may connect to the Internet. When two or more computers are connected using Bluetooth, and Internet Connection Sharing (ICS) is enabled on one of the computers, the other computers may not be able to connect to the Internet using the Bluetooth network.

The strength of Bluetooth is in synchronizing information transfers between your computer and wireless devices including cellular phones, printers, cameras, and PDAs. The inability to consistently connect two or more computers to share the Internet through Bluetooth is a limitation of Bluetooth and the Windows operating system.

Troubleshooting wireless connection problems

Some possible causes for wireless connection problems include the following:

- Network configuration (SSID or security) has been changed.
- Wireless device is not installed correctly or has been disabled.
- Wireless device or router hardware has failed.
- Wireless device encountered interference from other devices.

 **NOTE:** Wireless networking devices are included with select computer models only. If wireless networking is not listed in the feature list on the side of the original computer package, you may add wireless networking capability to the computer by purchasing a wireless networking device.

Before working your way through the sequence of possible solutions to your network connection problem, be sure that device drivers are installed for all wireless devices.

Use the procedures in this chapter to diagnose and repair a computer that does not connect to the network you want to use.

Cannot connect to a WLAN

If you have a problem connecting to a WLAN, confirm that the integrated WLAN device is properly installed on your computer:

 **NOTE:** Windows includes the User Account Control feature to improve the security of your computer. You may be prompted for your permission or password for tasks such as installing software, running utilities, or changing Windows settings. Refer to Help and Support for more information.

1. Select **Start > Control Panel > System and Security**.
2. In the **System** area, click **Device Manager**.
3. Click the arrow next to **Network adapters** to expand the list and show all adapters.
4. Identify the WLAN device from the Network adapters list. The listing for a WLAN device may include the terms *wireless*, *wireless LAN*, *WLAN*, *Wi-Fi*, or *802.11*.

If no WLAN device is listed, either your computer does not have an integrated WLAN device, or the driver of the WLAN device is not properly installed.

For more information on troubleshooting WLANs, refer to the Web site links provided in Help and Support.

Cannot connect to a preferred WLAN network

Windows can automatically repair a corrupted WLAN connection:

- If there is a network icon in the notification area, at the far right of the taskbar, right-click the icon, and then click **Troubleshoot problems**.

Windows resets your network device and attempts to reconnect to one of the preferred networks.

- If there is no network icon in the notification area, follow these steps:
 1. Select **Start > Control Panel > Network and Internet > Network and Sharing Center**.
 2. Click **Troubleshoot problems** and select a network to repair.

Network icon for WLAN is not displayed

If the network status icon is not displayed in the notification area after you configure the WLAN, the software driver is either missing or corrupted. A Windows “Device not Found” error message may also be displayed. The driver must be reinstalled.

Get the latest version of the WLAN device software and drivers for your computer from the HP Web site at <http://www.hp.com>. If the WLAN device you are using was purchased separately, consult the manufacturer's Web site for the latest software.

To get the latest version of the WLAN device software for your computer, follow these steps:

1. Open your Web browser and go to <http://www.hp.com/support>.
2. Select your country or region.
3. Click the option for software and driver downloads, and then type your computer model number in the search box.
4. Press **enter**, and then follow the on-screen instructions.

 **NOTE:** If the WLAN device you are using was purchased separately, consult the manufacturer's Web site for the latest software.

Current WLAN network security codes are unavailable

If you are prompted for a network key or a name (SSID) when connecting to a WLAN, the network is protected by security. You must have the current codes to make a connection on a secure network. The SSID and network key are alphanumeric codes that you enter into your computer to identify your computer to the network.

- For a network connected to your personal wireless router, review the router user guide for instructions on setting up the same codes on both the router and the WLAN device.
- For a private network, such as a network in an office or at a public Internet chat room, contact the network administrator to obtain the codes, and then enter the codes when prompted to do so.

Some networks change the SSID or network keys used in their routers or access points on a regular basis to improve security. You must change the corresponding code in your computer accordingly.

If you are provided with new wireless network keys and SSID for a network, and if you have previously connected to that network, follow the steps below to connect to the network:

1. Select **Start > Control Panel > Network and Internet > Network and Sharing Center**.
2. In the left panel, click **Manage wireless networks**.

A list showing the available WLANs is displayed. If you are in a hotspot where several WLANs are active, several are displayed.

3. Right-click the network, and then click **Properties**.

 **NOTE:** If the network you want is not listed, check with the network administrator to be sure that the router or access point is operating.

4. Click the **Security** tab and enter the correct wireless encryption data into the **Network security key** box.
5. Click **OK** to save these settings.

WLAN connection is very weak

If the connection is very weak, or if your computer cannot make a connection to a WLAN, follow the steps below to minimize interference from other devices:

- Move your computer closer to the wireless router or access point.
- Temporarily disconnect devices such as a microwave, cordless phone, or cellular phone to be sure that other wireless devices are not interfering.

Cannot connect to the wireless router

If you are trying to connect to the wireless router and are unsuccessful, reset the wireless router by removing power from the router for 10 to 15 seconds.

If the computer still cannot make a connection to a WLAN, restart the wireless router. For details, refer to the router manufacturer's instructions.

Connecting to a local area network (LAN)

Connecting to a local area network (LAN) requires an 8-pin, RJ-45 network cable (purchased separately). If the network cable contains noise suppression circuitry (**1**), which prevents interference from TV and radio reception, orient the circuitry end of the cable (**2**) toward the device.



To connect the network cable:

⚠ **WARNING!** To reduce the risk of electric shock, fire, or damage to the equipment, do not plug a modem cable or telephone cable into an RJ-45 (network) jack.

1. Plug the network cable into the network jack (1) on the computer.
2. Plug the other end of the cable into a network wall jack (2).

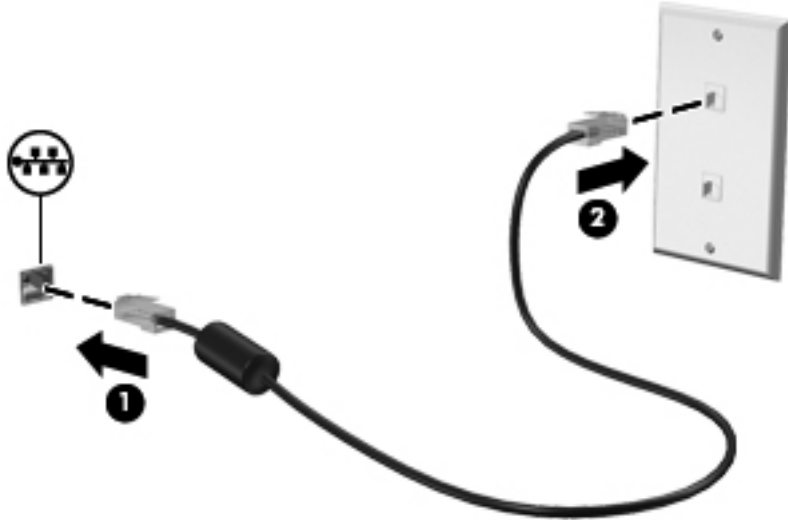

4 Pointing devices and keyboard

Using pointing devices

 **NOTE:** In addition to the TouchPad, you can also connect an external USB mouse to the computer using one of the USB ports on the computer.

Setting pointing device preferences

To access Mouse Properties, select **Start > Devices and printers**. Then, right-click the device representing your computer, and click **Mouse settings**.

Use Mouse Properties in Windows® to customize settings for pointing devices, such as button configuration, click speed, and pointer options.

Using the TouchPad

To move the pointer, slide your finger across the TouchPad surface in the direction you want the pointer to go. Use the TouchPad buttons like the corresponding buttons on an external mouse. To scroll up and down using the TouchPad vertical scroll zone, slide your finger up or down over the lines.

 **NOTE:** If you are using the TouchPad to move the pointer, you must lift your finger off the TouchPad before moving it to the scroll zone. Simply sliding your finger from the TouchPad to the scroll zone does not activate the scrolling function.

NOTE: For information on identifying the TouchPad components, refer to [TouchPad on page 2](#)

The following features are not available in all software. They are functional only in software that supports them.

Two-finger scrolling

Two-finger scrolling is useful for moving up or down on a page or image. To scroll, place two fingers on the TouchPad, and then drag them across the TouchPad in an up, down, left, or right motion.

 **NOTE:** Scrolling speed is controlled by finger speed.

NOTE: Two-finger scrolling is enabled at the factory. To disable two-finger scrolling, select **Control panel > Hardware and Sound > Mouse > Multitouch Gestures**. Then, clear the check box next to the function you want to disable.

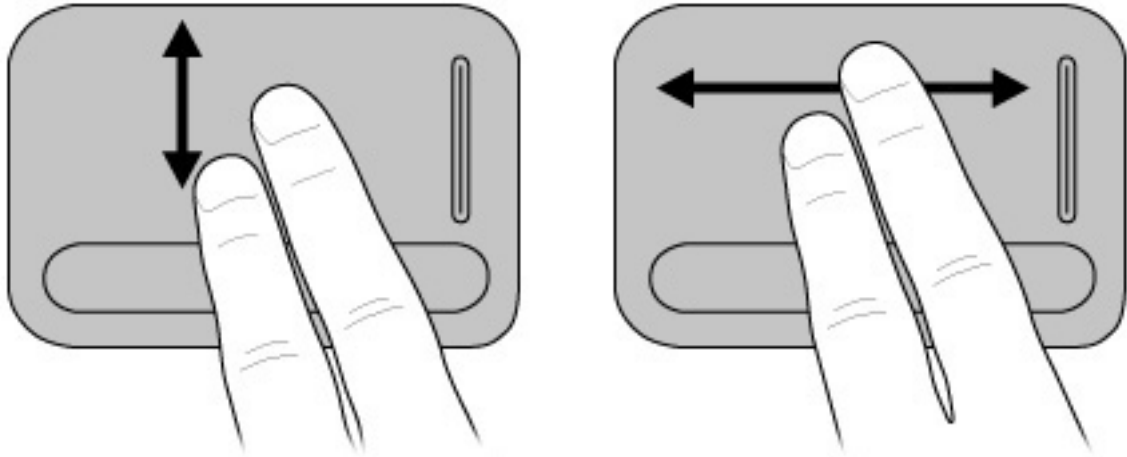

Rotating (select models only)

 **NOTE:** For some computer models, rotating is disabled at the factory. To enable rotating, select **Control panel > Hardware and Sound > Mouse > Multitouch Gestures**. Then, select the check box next to the function you want to enable.

Rotating allows you to rotate items such as photos and pages. To rotate, anchor your thumb on the TouchPad, and then move your forefinger in a semicircular motion around your thumb.

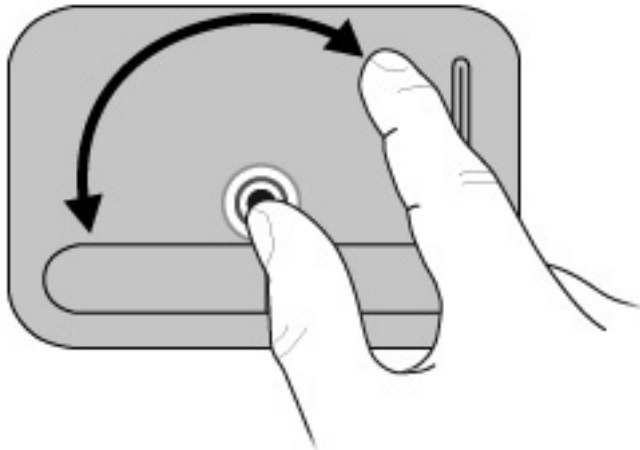

Pinching (select models only)

 **NOTE:** Pinching is enabled at the factory. To disable pinching, select **Control panel > Hardware and Sound > Mouse > Multitouch Gestures**. Then, clear the check box next to the function you want to disable.

Pinching allows you to zoom in or out on items such as PDFs, images, and photos.

To pinch:

- Zoom in by holding two fingers together on the TouchPad, and then pull the fingers apart to increase an object's size.
- Zoom out by holding two fingers apart on the TouchPad, and then pull the fingers together to decrease an object's size.

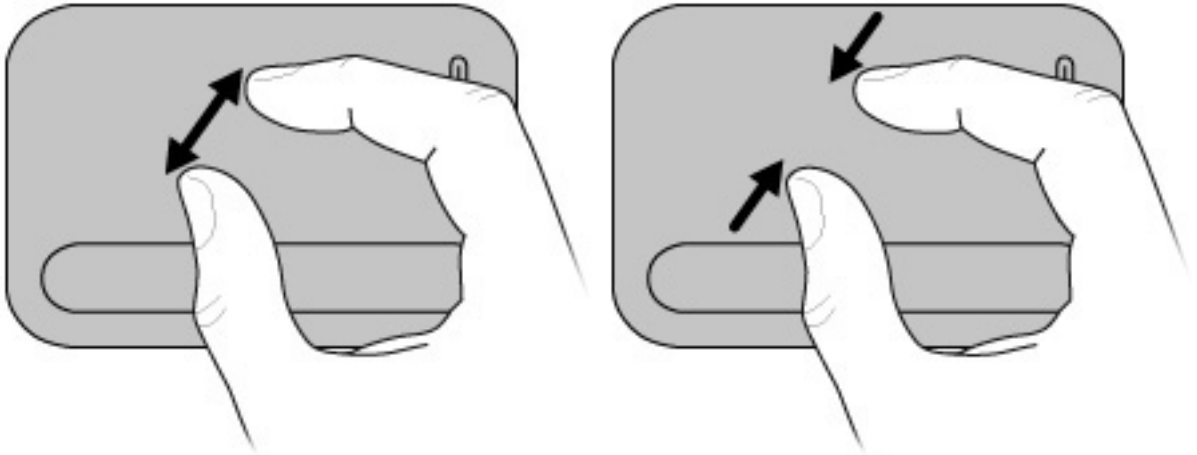

NOTE: Your computer also supports additional TouchPad features. To enable these features, select **Start > Devices and Printers**. Then, right-click the device representing your computer, and select **Mouse settings**.

Using the action keys

Action keys are customized actions that are assigned to specific keys at the top of the keyboard.











To use an action key, press and hold this key to activate the assigned function.

NOTE: Depending on the application you are using, pressing the **fn** key and one of the action keys opens a specific shortcut menu within that application.

NOTE: The action key feature is enabled at the factory. You can disable this feature in Setup Utility (BIOS) and revert back to pressing the **fn** key and one of the action keys to activate the assigned function. Refer to [Setup Utility \(BIOS\) on page 71](#) for additional information.



Key	Icon	Description
Decrease brightness		Decreases the screen brightness level incrementally.

Key	Icon	Description
Increase brightness		Increases the screen brightness level incrementally.
Sleep		Initiates Sleep.
Switch screen image		<p>Switches the screen image among display devices connected to the system. For example, if a monitor is connected to the computer, repeatedly pressing the switch screen image key alternates the screen image from computer display to monitor display to simultaneous display on both the computer and the monitor.</p> <p>Most external monitors receive video information from the computer using the external VGA video standard or HDMI. The switch screen image key can also alternate images among other devices receiving video information from the computer.</p>
QuickLock		Initiates the QuickLock security feature.
Volume mute		Mutes or restores speaker sound.
Volume down		Decreases speaker sound incrementally.
Volume up		Increases speaker sound incrementally.
Previous track		Plays the previous track of a CD or the previous section of the DVD or BD.
Play/pause		Plays, pauses, or resumes an audio CD, a DVD, or a BD.
Next track		Plays the next track of an audio CD or the next section of the DVD or BD.
Stop		Stops audio playback of a CD, a DVD, or a BD.

Using the hotkeys

Hotkeys are combinations of the **fn** key (1) and either the **esc** key (2) or one of the arrow keys (3).



Hotkey	Description
<code>fn+esc</code>	Displays information about system hardware components and the system BIOS version number.
<code>fn+up arrow</code>	Scrolls the page up.
<code>fn+down arrow</code>	Scrolls the page down.
<code>fn+left arrow</code>	Depending on the software, one of the following functions occurs: <ul style="list-style-type: none"> Returns the pointer to the beginning of the line where the pointer is located. <p>– or –</p> <ul style="list-style-type: none"> Returns to the beginning of the document.
<code>fn+right arrow</code>	Depending on the software, one of the following functions occurs: <ul style="list-style-type: none"> Places the pointer at the end of the line. <p>– or –</p> <ul style="list-style-type: none"> Scrolls to the end of the document.

To use a hotkey command, follow either of these steps:

- Briefly press the `fn` key, and then briefly press the second key of the hotkey command.
- or –
- Press and hold down the `fn` key, briefly press the second key of the hotkey command, and then release both keys at the same time.

Using keypads

The computer has an embedded numeric keypad and also supports an optional external numeric keypad or an optional external keyboard that includes a numeric keypad.

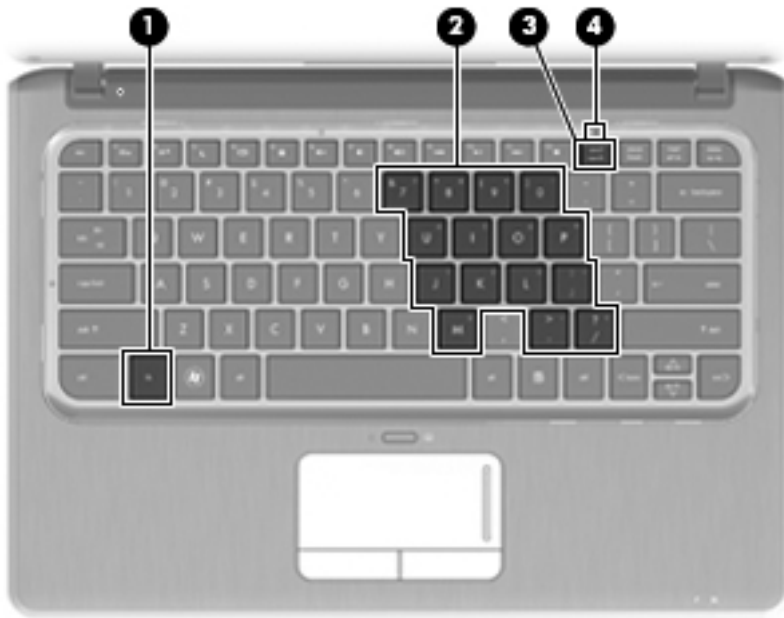

Component	Description
(1) <code>fn</code> key	Enables/disables the embedded numeric keypad when pressed in combination with the <code>num lk</code> key.
(2) Embedded numeric keypad	Can be used like an external numeric keypad.
(3) <code>num lk</code> key	Enables/disables the embedded numeric keypad when pressed in combination with the <code>fn</code> key.
(4) Num lock light	<ul style="list-style-type: none"> On: The embedded numeric keypad is enabled. – or – On: Num lock is enabled on a connected optional numeric keypad.

Using the embedded numeric keypad

The 15 keys of the embedded numeric keypad can be used like the keys on an external keypad. When the embedded numeric keypad is turned on, each key on the keypad performs the function indicated by the icon in the upper-right corner of the key.

Enabling and disabling the embedded numeric keypad

Press `fn+num lk` to enable the embedded numeric keypad. The num lock light is turned on. Press `fn +num lk` again to return the keys to their standard keyboard functions.

NOTE: The embedded numeric keypad will not function while an external keyboard or numeric keypad is connected to the computer or to an optional docking device or expansion product.

Switching key functions on the embedded numeric keypad

You can temporarily alternate the functions of keys on the embedded numeric keypad between their standard keyboard functions and their keypad functions by using the **fn** key or the **fn+shift** key combination.

- To change the function of a keypad key to keypad functions while the keypad is off, press and hold the **fn** key while pressing the keypad key.
- To use the keypad keys temporarily as standard keys while the keypad is on:
 - Press and hold the **fn** key to type in lowercase.
 - Press and hold **fn+shift** to type in uppercase.

Using an optional external numeric keypad

Keys on most external numeric keypads function differently according to whether num lock is on or off. (Num lock is turned off at the factory.) For example:

- When num lock is on, most keypad keys type numbers.
- When num lock is off, most keypad keys function like the arrow, page up, or page down keys.

When num lock on an external keypad is turned on, the num lock light on the computer is turned on. When num lock on an external keypad is turned off, the num lock light on the computer is turned off.

To turn num lock on or off on an external keypad as you work:

- ▲ Press the **num lk** key on the external keypad, not on the computer.

Cleaning the TouchPad and keyboard

Dirt and grease on the TouchPad can cause the pointer to jump around on the screen. To avoid this, clean the TouchPad with a damp cloth, and wash your hands frequently when using the computer.

-
- ⚠ **WARNING!** To reduce the risk of electric shock or damage to internal components, do not use a vacuum cleaner attachment to clean the keyboard. A vacuum cleaner can deposit household debris on the keyboard surface.
-

Clean the keyboard regularly to prevent keys from sticking and to remove dust, lint, and particles that can become trapped beneath the keys. A can of compressed air with a straw extension can be used to blow air around and under the keys to loosen and remove debris.

5 Multimedia

Multimedia features

Your computer includes multimedia features that allow you to listen to music, watch movies, and view pictures. Your computer may include the following multimedia components:

- External optical drive (select models only) for playing audio and video discs
- Integrated speakers for listening to music
- Integrated microphone for recording your own audio
- Integrated webcam that allows you to capture and share video
- Preinstalled multimedia software that allows you to play and manage your music, movies, and pictures
- Multimedia buttons and hotkeys that provide fast access to multimedia tasks

The following sections explain how to use the multimedia components included with your computer.

Adjusting the volume

You can adjust the volume using the computer volume keys.

- To mute or restore volume, press the volume mute key **(1)**.
- To decrease volume, press the volume down key **(2)**.
- To increase volume, press the volume up key **(3)**.



 **NOTE:** Volume can also be controlled through the Windows operating system and some programs.

Using the media activity keys

The media activity keys control the play of an audio CD or a DVD or BD that is inserted into an external optical drive (select models only).

- When an audio CD or a DVD or BD is not playing, press the play/pause key **(2)** to play the disc.
- When an audio CD or a DVD or BD is playing, use the following keys:
 - To play the previous track of an audio CD or the previous chapter of a DVD, press the previous track key **(1)**.
 - To pause or resume playing the disc, press the play/pause key **(2)**.
 - To play the next track of an audio CD or the next chapter of a DVD, press the next track key **(3)**.
 - To stop the disc, press the stop key **(4)**.



Multimedia software

The computer includes preinstalled multimedia software. If you have an external optical drive (select models only), the software can help you perform the following multimedia tasks, in addition to the ones described in this section:

- Playing digital media, including audio and video CDs, audio and video DVDs, and BDs
- Creating or copying data CDs
- Creating, editing, and burning audio CDs
- Creating, editing, and burning a video or movie to a DVD or video CD

Using HP MediaSmart software

HP MediaSmart turns your computer into a mobile entertainment center. With MediaSmart, you can enjoy music and DVD and BD movies. You can also manage and edit your photo collections. MediaSmart includes the following features:

- Playlist upload support:
 - Upload your MediaSmart photo playlists to Internet photo albums, such as Snapfish.
 - Upload your MediaSmart video playlists to YouTube.
 - Export your MediaSmart playlist to the CyberLink DVD Suite.
- Pandora Internet radio (North America only)—Listen to music selected just for you, streamed from the Internet.

To start MediaSmart:

- ▲ Click the **HP MediaSmart** icon on the desktop.

For more information on using MediaSmart, select **Start > Help and Support**, and then type `MediaSmart` in the Search box.

Using multimedia software

To locate and use other preinstalled multimedia software:

- ▲ Select **Start > All Programs**, and then open the multimedia program you want to use. For example, if you want to use Windows Media Player to play an audio CD, click **Windows Media Player**.

 **NOTE:** Some programs may be located in subfolders.

Installing multimedia software from a disc

Although your computer does not have an installed optical drive, you can easily access software, as well as install software and access data from one of the following ways:

- Use an external optical drive (select models only).

 **NOTE:** The external optical drive must be connected to the USB port *on the computer*, not to a USB port on another external device, such as a hub or docking station. For additional information on external optical drives, refer to [Using external drives on page 59](#).

- Share an optical drive from another computer that has an optical drive on your home network.

 **NOTE:** You must have a home network set up in order to share an optical drive. For additional information on sharing optical drives, refer to [Sharing optical drives on page 60](#).

NOTE: Some discs, such as DVD movies and game discs, may be copy-protected and therefore unusable through DVD or CD sharing.

Audio

Your computer enables you to use a variety of audio features:

- Play music using your computer speakers and/or connected external speakers
- Record sound using the internal microphone or connect an external microphone

- Download music from the Internet
- Create multimedia presentations using audio and images
- Transmit sound and images with instant messaging programs
- Stream radio programs
- Create (burn) audio CDs using an optional optical drive

Connecting external audio devices

 **WARNING!** To reduce the risk of personal injury, adjust the volume before putting on headphones, earbuds, or a headset. For additional safety information, refer to the *Regulatory, Safety and Environmental Notices*.

To connect external devices such as external speakers, headphones, earbuds, a headset, television audio, or a headset microphone, refer to the information provided with the device. For best results, remember the following tips:

- Be sure that the device cable is securely connected to the correct jack on your computer. (Cable connectors are normally color-coded to match the corresponding jacks on the computer.)
- Be sure to install any drivers required by the external device.

 **NOTE:** A driver is a required program that functions like a translator between the device and the programs that use the device.

Checking your audio functions

To check the system sound on your computer, follow these steps:

1. Select **Start > Control Panel**.
2. Click **Hardware and Sound**.
3. Click **Sound**.
4. When the Sound window opens, click the **Sounds** tab. Under **Program Events**, select any sound event, such as a beep or alarm, and click the **Test** button.

You should hear sound through the speakers or through connected headphones.

To check the record functions of the computer, follow these steps:

1. Select **Start > All Programs > Accessories > Sound Recorder**.
2. Click **Start Recording** and speak into the microphone. Save the file to your desktop.
3. Open Windows Media Player or MediaSmart and play back the sound.

 **NOTE:** For best results when recording, speak directly into the microphone and record sound in a setting free of background noise.

To confirm or change the audio settings on your computer, select **Start > Control Panel > Hardware and Sound > Sound**.

Video

Your computer enables you to use a variety of video features:

- Watch movies
- Play games over the Internet
- Edit pictures and video and create presentations
- Connect external video devices

Connecting an external monitor or projector

The external monitor port connects an external display device such as an external monitor or a projector to the computer.

- ▲ To connect a display device, connect the device cable to the external monitor port.

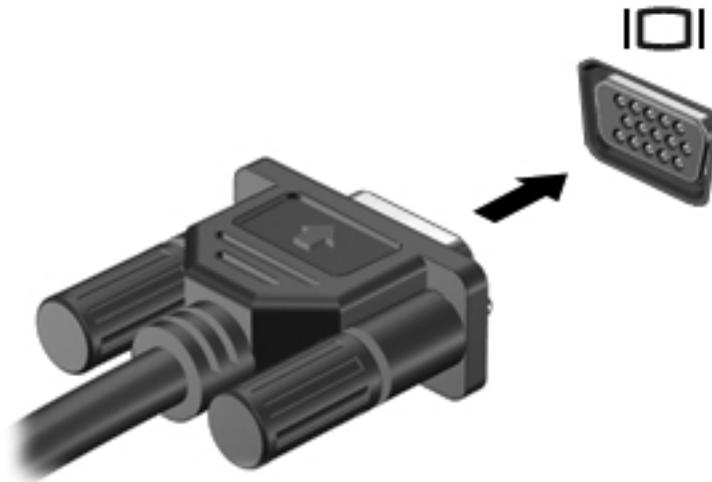

 **NOTE:** If a properly connected external display device does not display an image, press the switch screen image key to transfer the image to the device. Repeatedly pressing the switch screen image key alternates the screen image between the computer display and the device.

Connecting an HDMI device

The computer includes an HDMI (High Definition Multimedia Interface) port. The HDMI port connects the computer to an optional video or audio device, such as a high-definition television, or any compatible digital or audio component.

 **NOTE:** To transmit video signals through the HDMI port, you need an HDMI cable (purchased separately).

The computer can support one HDMI device connected to the HDMI port, while simultaneously supporting an image on the computer display or any other supported external display.

To connect a video or audio device to the HDMI port:

1. Connect one end of the HDMI cable to the HDMI port on the computer.

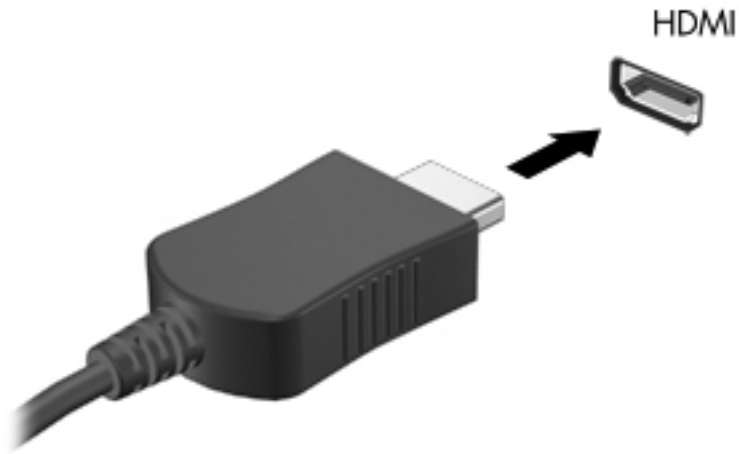

2. Connect the other end of the cable to the video device, according to the device manufacturer's instructions.
3. Press the switch screen image key on the computer to switch the image between the display devices connected to the computer.

Configuring audio for HDMI (select models only)

To configure HDMI audio, first connect an audio or video device, such as a high-definition TV, to the HDMI port on your computer. Then configure the default audio playback device as follows:

1. Right-click the **Speakers** icon in the notification area, at far right of the taskbar, and then click **Playback devices**.
2. On the **Playback** tab, click either **Digital Output** or **Digital Output Device (HDMI)**.
3. Click **Set Default**, and then click **Ok**.

To return audio to the computer speakers, follow these steps:

1. Right-click the **Speakers** icon in the notification area, at far right of the taskbar, and then click **Playback devices**.
2. On the **Playback** tab, click **Speakers**.
3. Click **Set Default**, and then click **Ok**.

Webcam

Your computer includes an integrated webcam, located at the top of the display. The webcam is an input device that allows you to capture and share video and still photographs.

To use the webcam, click the **HP MediaSmart** icon on the desktop, and select the webcam icon on the MediaSmart SmartMenu.

 **NOTE:** For more information on using HP MediaSmart, click **Start > Help and Support**, and type `MediaSmart` in the Search box.

For optimum performance, observe the following guidelines while using the webcam:

- If you are having trouble viewing or sending multimedia files to someone on another LAN or outside your network firewall, temporarily disable the firewall, perform the task you want to perform, and then reenable the firewall. To permanently resolve the problem, reconfigure the firewall as necessary, and adjust the policies and settings of other intrusion detection systems.
- Whenever possible, place bright light sources behind the camera and out of the picture area.

Webcam tips

For optimum performance, observe the following guidelines while using the integrated webcam:

- Be sure that you have the latest version of an instant message program before attempting a video conversation.
- Your integrated webcam may not work properly across some network firewalls. If you are having trouble viewing or sending video to someone on another LAN or outside your network firewall, contact your Internet service provider for assistance.
- Whenever possible, place bright light sources behind the webcam and out of the picture area.

Adjusting webcam properties

You can adjust webcam properties using the Properties dialog box, which is accessible from various programs that use the integrated camera, usually from a configuration, settings, or properties menu:

- **Brightness**—Controls the amount of light that is incorporated into the image. A higher brightness setting creates a brighter image; a lower brightness setting creates a darker image.
- **Contrast**—Controls the difference between lighter and darker areas on the image. A higher contrast setting intensifies the image; a lower contrast setting maintains more of the original information's dynamic range but leads to a flatter image.
- **Hue**—Controls the aspect of color that distinguishes it from another color (what makes a color red, green, or blue). Hue is distinct from saturation, which measures the intensity of the hue.
- **Saturation**—Controls the strength of color in the final image. A higher saturation setting creates a bolder image; a lower saturation setting creates a more subtle image.
- **Sharpness**—Controls the definition of edges in an image. A higher sharpness setting creates a more defined image; a lower sharpness setting creates a softer image.
- **Gamma**—Controls the contrast affecting the mid-level grays or midtones of an image. Adjusting the gamma of an image allows you to change the brightness values of the middle range of gray tones without dramatically altering the shadows and highlights. A lower gamma setting makes grays look black, and makes dark colors even darker.
- **Backlight Comp**—Compensates in cases where a subject with a large amount of background light would otherwise be obscured by blooming or silhouetting.

For information about using the webcam, select **Start > Help and Support**.

6 Power management

Setting power devices

Using power-saving states

The computer has two power-saving states enabled at the factory: Sleep and Hibernation.

When Sleep is initiated, the power light blinks and the screen clears. Your work is saved to memory, thereby conserving power and letting you exit Sleep faster than exiting Hibernation. While the computer is in the Sleep state, the power light blinks. If the computer is in the Sleep state for an extended period or if the battery reaches a critical battery level while in the Sleep state, the computer initiates Hibernation.

△ **CAUTION:** To prevent possible audio and video degradation, loss of audio or video playback functionality, or loss of information, do not initiate Sleep or Hibernation while reading from or writing to a disc or an external media card.

📝 **NOTE:** You cannot initiate any type of networking connection or perform any computer functions while the computer is in the Sleep state or in Hibernation.

Initiating and exiting Sleep

The system is set at the factory to initiate Sleep after 15 minutes of inactivity when running on battery power and 30 minutes of inactivity when running on external power.

Power settings and timeouts can be changed using Power Options in Windows® Control Panel.

With the computer on, you can initiate Sleep in any of the following ways:

- Press the Sleep key.
- Slide the power switch briefly.
- Close the display.
- Click **Start**, and then click the **Power** button.
- Click **Start**, click the arrow next to the Shut down button, and then click **Sleep**.

You can exit Sleep in any of the following ways:

- Slide the power switch briefly.
- If the display is closed, open the display.
- Press a key on the keyboard.
- Activate the TouchPad.

When the computer exits Sleep, the power light turns on and your work returns to the screen where you stopped working.

📝 **NOTE:** If you have set a password to be required on wakeup, you must enter your Windows password before your work is returned to the screen.

Initiating and exiting Hibernation

The system is set at the factory to initiate Hibernation after 1,080 minutes (18 hours) of inactivity when running on battery power, 1,080 minutes (18 hours) of inactivity when running on external power, or when the battery reaches a critical battery level.

Power settings and timeouts can be changed using Power Options in Windows Control Panel.

To initiate Hibernation:

- ▲ Click **Start**, click the arrow next to the Shut down button, and then click **Hibernate**.

To exit Hibernation:

- ▲ Slide the power switch briefly.

The power light turns on and your work returns to the screen where you stopped working.

 **NOTE:** If you have set a password to be required on wakeup, you must enter your Windows password before your work is returned to the screen.

Using the battery meter

The battery meter is located in the notification area, at the far right of the taskbar. The battery meter allows you to quickly access power settings, view remaining battery charge, and select a different power plan.

- To display the percentage of remaining battery charge and the current power plan, move the pointer over the battery meter icon.
- To access Power Options, or to change the power plan, click the battery meter icon and select an item from the list.

Different battery meter icons indicate whether the computer is running on battery or external power. The icon also displays a message if the battery has reached a low battery level, critical battery level, or reserve battery level.

To hide or display the battery meter icon:

1. Right-click the **Show hidden icons** icon (the arrow at the left side of the notification area).
2. Click **Customize notification icons**.
3. Under **Behaviors**, click **Show icon and notifications** for the Power icon.
4. Click **OK**.

Using power plans

A power plan is a collection of system settings that manages how the computer uses power. Power plans can help you conserve power or maximize performance.

You can change power plan settings or create your own power plan.

Viewing the current power plan

- ▲ Click the battery meter icon in the notification area, at the far right of the taskbar.

– or –

Select **Start > Control Panel > System and Security > Power Options**.

Selecting a different power plan

- ▲ Click the battery meter icon in the notification area, and then select a power plan from the list.
– or –
Select **Start > Control Panel > System and Security > Power Options**, and then select a power plan from the list.

Customizing power plans

1. Click the battery meter icon in the notification area and then click **More power options**.
– or –
Select **Start > Control Panel > System and Security > Power Options**.
2. Select a power plan, and then click **Change plan settings**.
3. Make changes to the settings.
4. To change additional settings, click **Change advanced power settings** and make your changes.

Setting password protection on wakeup

To set the computer to prompt for a password when the computer exits Sleep or Hibernation, follow these steps:

1. Select **Start > Control Panel > System and Security > Power Options**.
2. In the left pane, click **Require a password on wakeup**.
3. Click **Change Settings that are currently unavailable**.
4. Click **Require a password (recommended)**.

 **NOTE:** If you need to create a user account password or change your current user account password, click **Create or change your user account password**, and then follow the on-screen instructions. If you do not need to create or change a user account password, go to step 5.

5. Click **Save changes**.

Using external AC power

External AC power is supplied through an approved AC adapter.

-
- ⚠ **WARNING!** To reduce potential safety issues, use only the AC adapter provided with the computer, a replacement AC adapter provided by HP, or a compatible AC adapter purchased from HP.
-

Connect the computer to external AC power under any of the following conditions:

-
- ⚠ **WARNING!** Do not charge the computer battery while you are onboard aircraft.
-
- When you are charging or calibrating a battery
 - When you are installing or modifying system software
 - When you are writing information to a CD or DVD

When you connect the computer to external AC power, the following events occur:

- The battery begins to charge.
- If the computer is turned on, the battery meter icon in the notification area changes appearance.

When you disconnect external AC power, the following events occur:

- The computer switches to battery power.
- The display brightness is automatically decreased to save battery life. To increase display brightness, press the **f2** hotkey or reconnect the AC adapter.

Connecting AC power

⚠ **WARNING!** To reduce the risk of electric shock or damage to the equipment:

Plug the power cord into an AC outlet that is easily accessible at all times.

Disconnect power from the computer by unplugging the power cord from the AC outlet (not by unplugging the power cord from the computer).

If provided with a 3-pin attachment plug on the power cord, plug the cord into a grounded (earthed) 3-pin outlet. Do not disable the power cord grounding pin, for example, by attaching a 2-pin adapter. The grounding pin is an important safety feature.

To connect the computer to external AC power:

1. Plug the adapter into the power connector **(1)** on the computer.
2. Plug the power cord into the adapter **(2)**.
3. Plug the other end of the power cord into an AC outlet **(3)**.

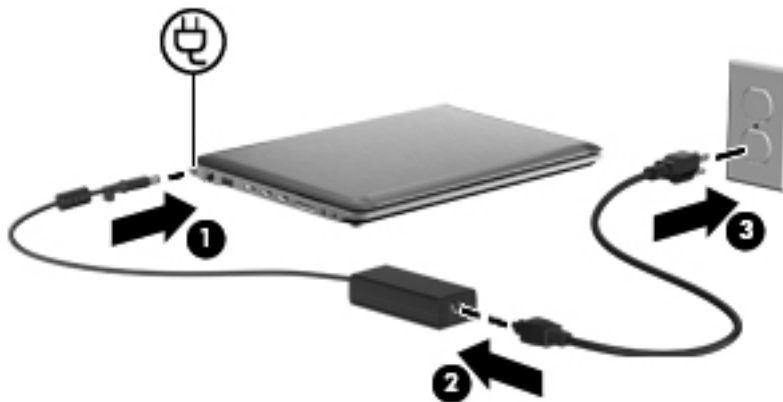

Testing an AC adapter

Test the AC adapter if the computer exhibits any of the following symptoms when it is connected to AC power:

- The computer does not turn on.
- The display does not turn on.
- The power light is off.

To test the AC adapter:

1. Remove the battery from the computer.
2. Connect the AC adapter to the computer, plug the power cord into the AC adapter, and then plug the power cord into an AC outlet.
3. Turn on the computer.
 - If the power light turns **on**, the AC adapter is working properly.
 - If the power light remains **off**, the AC adapter is not functioning and should be replaced.

Contact technical support for information on obtaining a replacement AC power adapter. Select **Start > Help and Support > Get assistance**.

Using battery power

When a charged battery is in the computer and the computer is not plugged into external power, the computer runs on battery power. When the computer is plugged into external AC power, the computer runs on AC power.

If the computer contains a charged battery and is running on external AC power supplied through the AC adapter, the computer switches to battery power if the AC adapter is disconnected from the computer.

 **NOTE:** The display brightness is decreased to save battery life when you disconnect AC power. To increase display brightness, use the increase brightness key or reconnect the AC adapter.

You can keep a battery in the computer or in storage, depending on how you work. Keeping the battery in the computer whenever the computer is plugged into AC power charges the battery and also protects your work in case of a power outage. However, a battery in the computer slowly discharges when the computer is off and unplugged from external power.

 **WARNING!** To reduce potential safety issues, use only the battery provided with the computer, a replacement battery provided by HP, or a compatible battery purchased from HP.

Finding battery information in Help and Support

Help and Support provides the following tools and information about the battery:

- Battery Check tool to test battery performance
- Information on calibration, power management, and proper care and storage to maximize battery life
- Information on battery types, specifications, life cycles, and capacity

To access battery information:

- ▲ Select **Start > Help and Support > Learn > Power Plans: Frequently Asked Questions**.

Using Battery Check

Help and Support provides information on the status of the battery installed in the computer.

To run Battery Check:

1. Connect the AC adapter to the computer.

 **NOTE:** The computer must be connected to external power for Battery Check to function properly.

2. Select **Start > Help and Support > Troubleshoot > Power, Thermal and Mechanical**.
3. Click the **Power** tab, and then click **Battery Check**.

Battery Check examines the battery and its cells to see if they are functioning properly, and then reports the results of the examination.

Displaying the remaining battery charge

- ▲ Move the pointer over the battery meter icon in the notification area, at the far right of the taskbar.

Inserting or removing the battery

- △ **CAUTION:** Removing a battery that is the sole power source can cause loss of information. To prevent loss of information, initiate Hibernation or shut down the computer through Windows before removing the battery.

To insert the battery:

1. Turn the computer upside down on a flat surface.
2. Insert the battery (1) into the battery bay (2) and pivot the battery downward. Press down on the battery until you hear a click.
3. Slide the battery release latch (3) to lock the battery in place.

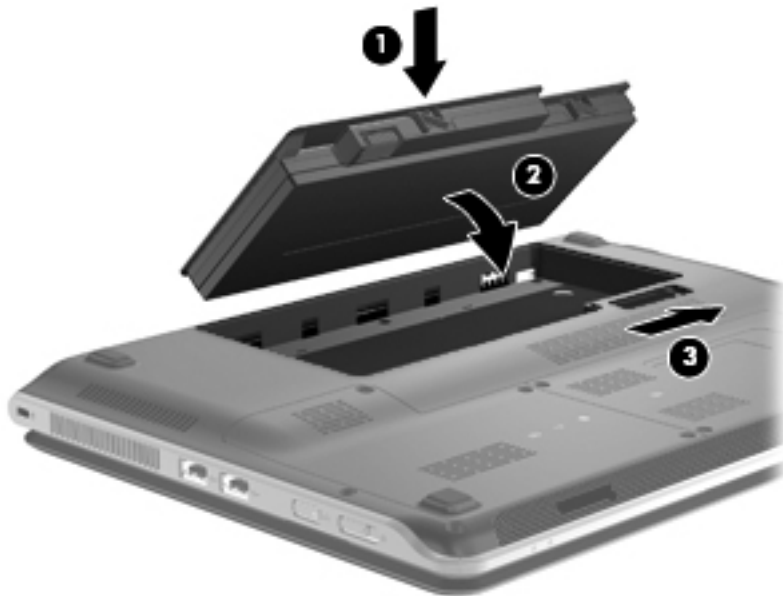

To remove the battery:

1. Turn the computer upside down on a flat surface.
2. Slide the battery release latch (1), and then pivot the battery (2) upward.

3. Remove the battery (3).

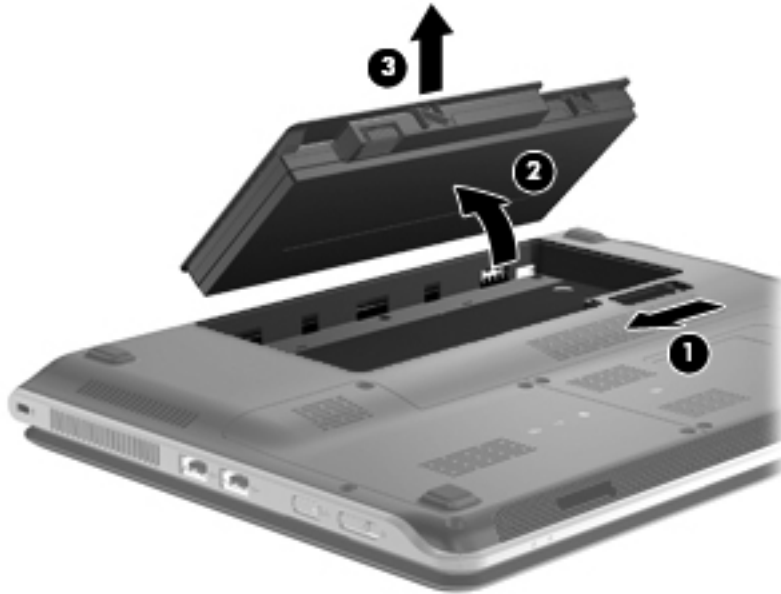

Charging a battery

WARNING! Do not charge the computer battery while you are onboard aircraft.

The battery charges whenever the computer is plugged into external power through an AC adapter or an optional power adapter.

The battery charges whether the computer is off or in use, but it charges faster when the computer is off.

Charging may take longer if a battery is new, has been unused for 2 weeks or more, or is much warmer or cooler than room temperature.

To prolong battery life and optimize the accuracy of battery charge displays, follow these recommendations:

- If you are charging a new battery, charge it fully before turning on the computer.
- Charge the battery until the battery light turns off.

NOTE: If the computer is on while the battery is charging, the battery meter in the notification area may show 100 percent charge before the battery is fully charged.

- Allow the battery to discharge below 5 percent of a full charge through normal use before charging it.
- If the battery has been unused for one month or more, calibrate the battery instead of simply charging it.

The battery light on the computer displays the following charge status:

- On: The battery is charging.
- Blinking: The battery has reached a low battery level or critical battery level and is not charging.
- Off: The battery is fully charged, in use, or not installed.

Maximizing battery discharge time

Battery discharge time varies depending on the features you use while on battery power. Maximum discharge time gradually shortens, as the battery storage capacity naturally degrades.

Tips for maximizing battery discharge time:

- Lower the brightness on the display.
- Check the **Power saver** setting in Power Options.
- Remove the battery from the computer when it is not being used or charged.
- Store the battery in a cool, dry location.

Managing low battery levels

The information in this section describes the alerts and system responses set at the factory. Some low-battery alerts and system responses can be changed using Power Options in Windows Control Panel. Preferences set using Power Options do not affect lights.

Identifying low battery levels

When a battery that is the sole power source for the computer reaches a low battery level, the battery light blinks.

If a low battery level is not resolved, the computer enters a critical battery level, and the battery light begins blinking rapidly.

The computer takes the following actions for a critical battery level:

- If Hibernation is enabled and the computer is on or in Sleep, the computer initiates Hibernation.
- If Hibernation is disabled and the computer is on or in Sleep, the computer remains briefly in Sleep, and then shuts down and loses any unsaved information.

Resolving a low battery level

△ **CAUTION:** To reduce the risk of losing information when the computer reaches a critical battery level and has initiated Hibernation, do not restore power until the power light turns off.

Resolving a low battery level when external power is available

- ▲ Connect one of the following devices:
 - AC adapter
 - Optional expansion product or docking device
 - Optional power adapter

Resolving a low battery level when a charged battery is available

1. Turn off the computer or initiate Hibernation.
2. Remove the discharged battery, and then insert a charged battery.
3. Turn on the computer.

Resolving a low battery level when no power source is available

- ▲ Initiate Hibernation.
 - or –
 - Save your work and shut down the computer.

Resolving a low battery level when the computer cannot exit Hibernation

When the computer lacks sufficient power to exit Hibernation, follow these steps:

1. Insert a charged battery or plug the computer into external power.
2. Exit Hibernation by briefly sliding the power switch.

Calibrating a battery

Calibrate a battery under the following conditions:

- When battery charge displays seem inaccurate
- When you observe a significant change in battery run time

Even if a battery is heavily used, it should not need to be calibrated more than once a month. It is also not necessary to calibrate a new battery.

Step 1: Fully charge the battery

△ **WARNING!** Do not charge the computer battery while you are onboard aircraft.

📝 **NOTE:** The battery charges whether the computer is off or in use, but it charges faster when the computer is off.

To fully charge the battery:

1. Insert the battery into the computer.
2. Connect the computer to an AC adapter, optional power adapter, optional expansion product, or optional docking device, and then plug the adapter or device into external power.

The battery light on the computer turns on.

3. Leave the computer plugged into external power until the battery is fully charged.

The battery light on the computer turns off.

Step 2: Disable Hibernation and Sleep

1. Click the battery meter icon in the notification area, and then click **More power options**.

– or –

Select **Start > Control Panel > System and Security > Power Options**.

2. Under the current power plan, click **Change plan settings**.
3. Record the **Turn off the display** settings listed in the **On battery** column so that you can reset them after the calibration.
4. Change the **Turn off the display** settings to **Never**.
5. Click **Change advanced power settings**.
6. Click the plus sign next to **Sleep**, and then click the plus sign next to **Hibernate after**.
7. Record the **On battery** setting under **Hibernate after** so that you can reset it after the calibration.
8. Change the **On battery** setting to **Never**.
9. Click **OK**.
10. Click **Save changes**.

Step 3: Discharge the battery

The computer must remain on while the battery is being discharged. The battery can discharge whether or not you are using the computer, but the battery discharges faster while you are using it.

- If you plan to leave the computer unattended during the discharge, save your information before beginning the discharge procedure.
- If you use the computer occasionally during the discharge procedure and have set energy-saving timeouts, expect the following performance from the system during the discharge process:
 - The monitor will not turn off automatically.
 - Hard drive speed will not decrease automatically when the computer is idle.
 - System-initiated Hibernation will not occur.

To discharge a battery:

1. Unplug the computer from its external power source, but do *not* turn off the computer.
2. Run the computer on battery power until the battery is discharged. The battery light begins to blink when the battery has discharged to a low battery level. When the battery is discharged, the battery light turns off and the computer shuts down.

Step 4: Fully recharge the battery

To recharge the battery:

1. Plug the computer into external power and maintain external power until the battery is fully recharged. When the battery is recharged, the battery light on the computer turns off.

You can use the computer while the battery is recharging, but the battery charges faster if the computer is off.

2. If the computer is off, turn it on when the battery is fully charged and the battery light has turned off.

Step 5: Reenable Hibernation and Sleep

△ **CAUTION:** Failure to reenable Hibernation after calibration may result in a full battery discharge and information loss if the computer reaches a critical battery level.

1. Click the battery meter icon in the notification area, and then click **More power options**.
– or –
Select **Start > Control Panel > System and Security > Power Options**.
2. Under the current power plan, click **Change plan settings**.
3. Reenter the settings that you recorded for the items in the **On battery** column.
4. Click **Change advanced power settings**.
5. Click the plus sign next to **Sleep**, and then click the plus sign next to **Hibernate after**.
6. Reenter the setting that you recorded for **On battery**.
7. Click **OK**.
8. Click **Save changes**.

Conserving battery power

- Select the Power saver power plan through Power Options under **System and Security** in Windows Control Panel.
- Turn off wireless and local area network (LAN) connections and exit modem applications when you are not using them.
- Disconnect external devices that are not plugged into an external power source, when you are not using them.
- Stop, disable, or remove any external media cards that you are not using.
- Use the f1 and f2 hotkeys to adjust screen brightness as needed.
- If you leave your work, initiate Sleep or Hibernation, or shut down the computer.

Storing a battery

△ **CAUTION:** To prevent damage to a battery, do not expose it to high temperatures for extended periods of time.

If a computer will be unused and unplugged from external power for more than 2 weeks, remove the battery and store it separately.

To prolong the charge of a stored battery, place it in a cool, dry place.

📝 **NOTE:** A stored battery should be checked every 6 months. If the capacity is less than 50 percent, recharge the battery before returning it to storage.

Calibrate a battery before using it if it has been stored for one month or more.

Disposing of a used battery

△ **WARNING!** To reduce the risk of fire or burns, do not disassemble, crush, or puncture; do not short external contacts; do not dispose of in fire or water.

Replacing the battery

Computer battery life varies, depending on power management settings, programs running on the computer, display brightness, external devices connected to the computer, and other factors.

Battery Check notifies you to replace the battery when an internal cell is not charging properly, or when the battery storage capacity has reached a "weak" condition. A message refers you to the HP Web site for more information about ordering a replacement battery. If the battery is possibly covered by an HP warranty, instructions include a warranty ID.

📝 **NOTE:** To ensure that you always have battery power when you need it, HP recommends purchasing a new battery when the storage capacity indicator turns green-yellow.

Shutting down the computer

△ **CAUTION:** Unsaved information is lost when the computer is shut down.

The Shut down command closes all open programs, including the operating system, and then turns off the display and computer.

Shut down the computer under any of the following conditions:

- When you need to replace the battery or access components inside the computer
- When you are connecting an external hardware device that does not connect to a USB port
- When the computer will be unused and disconnected from external power for an extended period

Although you can shut down the computer with the power switch, the recommended procedure is to use the Windows Shut down command.

To shut down the computer:

 **NOTE:** If the computer is in the Sleep state or in Hibernation, you must first exit Sleep or Hibernation before shutdown is possible.

1. Save your work and close all open programs.
2. Click **Start**.
3. Click **Shut down**.

If the computer is unresponsive and you are unable to use the preceding shutdown procedures, try the following emergency procedures in the sequence provided:

- Press **ctrl+alt+delete**, and then click the **Power** button.
- Slide and hold the power switch for at least 5 seconds.
- Disconnect the computer from external power and remove the battery.

7 Memory modules

The computer has one memory module compartment, which is located on the bottom of the computer. The memory capacity of the computer can be upgraded by replacing the existing memory module.

- △ **WARNING!** To reduce the risk of electric shock and damage to the equipment, unplug the power cord and remove all batteries before installing a memory module.
- △ **CAUTION:** Electrostatic discharge (ESD) can damage electronic components. Before beginning any procedure, ensure that you are discharged of static electricity by touching a grounded metal object.

To add or replace a memory module:

1. Save your work.
2. Shut down the computer and close the display.

If you are not sure whether the computer is off or in Hibernation, turn the computer on by sliding the power switch. Then shut down the computer through the operating system.

3. Disconnect all external devices connected to the computer.
4. Unplug the power cord from the AC outlet.
5. Turn the computer upside down on a flat surface.
6. Remove the battery from the computer.
7. Loosen the 2 memory module compartment screws **(1)**.
8. Lift the memory module compartment cover **(2)** away from the computer.

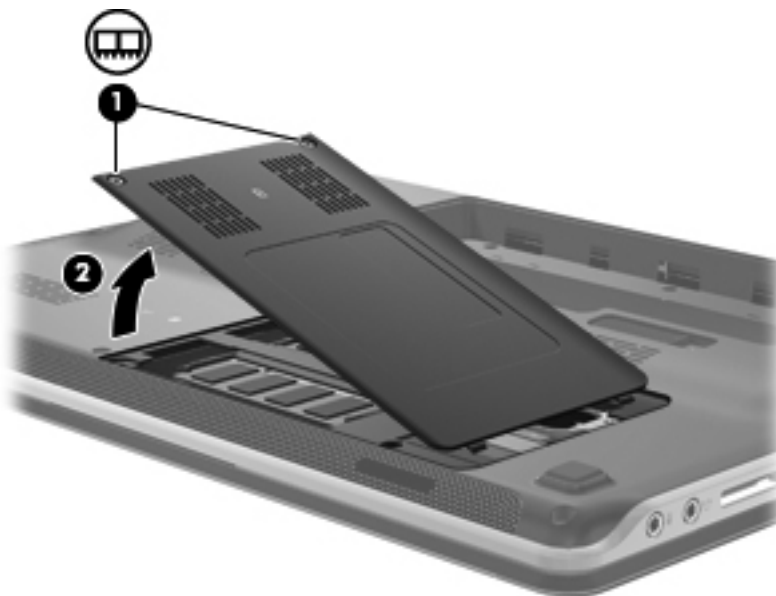

9. If you are replacing a memory module, remove the existing memory module:

- a. Pull away the retention clips (1) on each side of the memory module.

The memory module tilts up.

△ **CAUTION:** To prevent damage to the memory module, hold the memory module by the edges only. Do not touch the components on the memory module.

- b. Grasp the edge of the memory module (2), and gently pull the module out of the memory module slot.

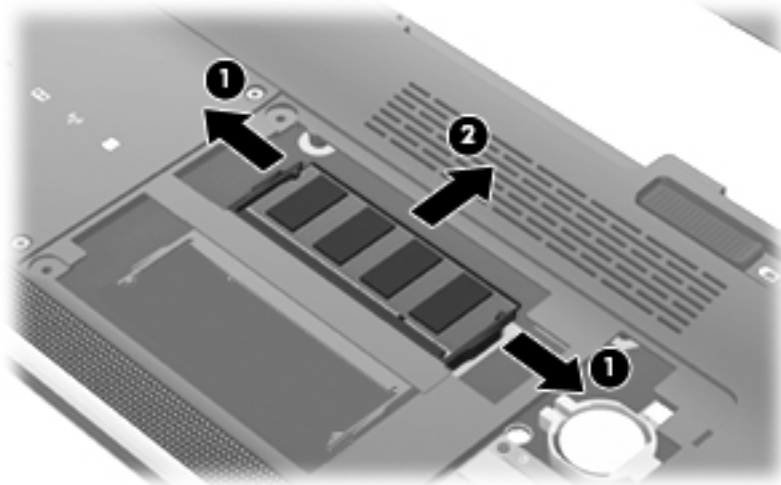

To protect a memory module after removal, place it in an electrostatic-safe container.

10. Insert a new memory module:

△ **CAUTION:** To prevent damage to the memory module, hold the memory module by the edges only. Do not touch the components on the memory module.

- a. Align the notched edge (1) of the memory module with the tab in the memory module slot.
- b. With the memory module at a 45-degree angle from the surface of the memory module compartment, press the module (2) into the memory module slot until it is seated.

△ **CAUTION:** To prevent damage to the memory module, do not bend the memory module.

- c. Gently press the memory module **(3)** down, applying pressure to both the left and right edges of the memory module, until the retention clips snap into place.

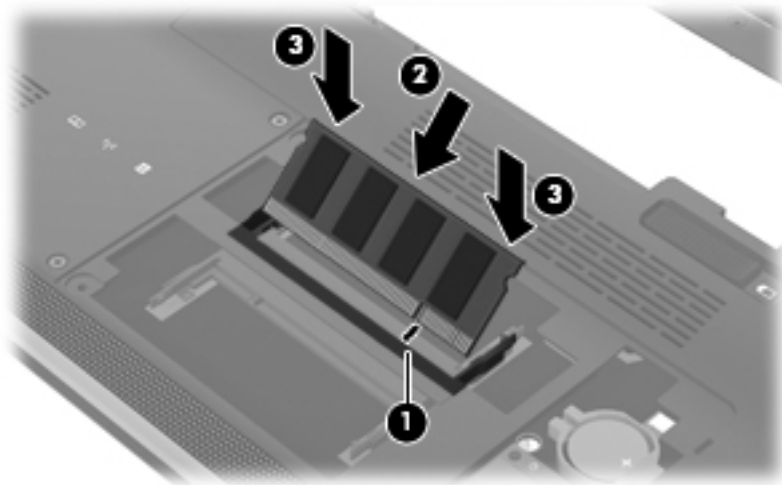

- 11. Align the tabs on the memory module compartment cover with the notches on the computer **(1)** and close the cover **(2)**.
- 12. Tighten the 2 memory module compartment screws **(3)**.

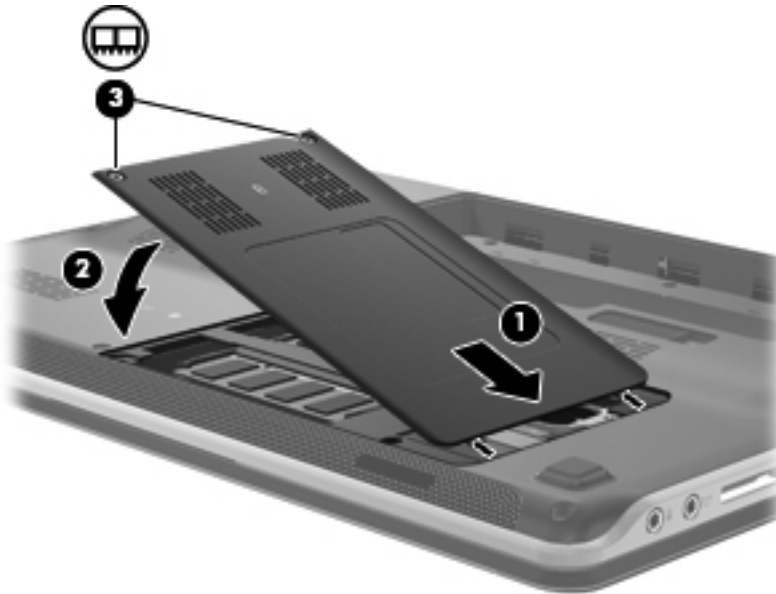

- 13. Replace the battery.
- 14. Turn the computer right-side up, and then reconnect external power and external devices.
- 15. Turn on the computer.

8 Drives and external devices

Drives

Identifying installed drives

Your computer includes a hard drive (with a rotating disc) or a solid state-drive (SSD) with solid-state memory. Because it has no moving parts, an SSD does not generate as much heat as a hard drive.

To view the drives installed on the computer, select **Start > Computer**.

 **NOTE:** Windows® includes the User Account Control feature to improve the security of your computer. You may be prompted for your permission or password for tasks such as installing software, running utilities, or changing Windows settings. Refer to Help and Support for more information.

Handling drives

Drives are fragile computer components that must be handled with care. Refer to the following cautions before handling drives. Additional cautions are included with the procedures to which they apply.

△ **CAUTION:** To reduce the risk of damage to the computer, damage to a drive, or loss of information, observe these precautions:

Before you move a computer that is connected to an external hard drive, initiate Sleep and allow the screen to clear, or properly disconnect the external hard drive.

Before handling a drive, discharge static electricity by touching the unpainted metal surface of the drive.

Do not touch the connector pins on a removable drive or on the computer.

Handle a drive carefully; do not drop a drive or place items on it.

Before removing or inserting a drive, shut down the computer. If you are unsure whether the computer is off, in the Sleep state, or in Hibernation, turn the computer on and then shut it down through the operating system.

Do not use excessive force when inserting a drive into a drive bay.

Do not type on the keyboard or move the computer while the optical drive (select models only) is writing to a disc. The write process is sensitive to vibration.

When the battery is the only source of power, be sure that the battery is sufficiently charged before writing to media.

Avoid exposing a drive to temperature or humidity extremes.

Avoid exposing a drive to liquids. Do not spray the drive with cleaning products.

Remove media from a drive before removing the drive from the drive bay, or traveling with, shipping, or storing a drive.

If a drive must be mailed, place the drive in a bubble-pack mailer or other suitable protective packaging and label the package "FRAGILE."

Avoid exposing a drive to magnetic fields. Security devices with magnetic fields include airport walk-through devices and security wands. The airport security devices that check carry-on luggage, such as conveyor belts, use X-rays instead of magnetism and does not damage a drive.

Improving hard drive performance

Using Disk Defragmenter

As you use the computer, files on the hard drive become fragmented. Disk Defragmenter consolidates the fragmented files and folders on the hard drive so that the system can run more efficiently.

To run Disk Defragmenter:

1. Select **Start > All Programs > Accessories > System Tools > Disk Defragmenter**.
2. Click **Defragment now**.

 **NOTE:** Windows® includes the User Account Control feature to improve the security of your computer. You may be prompted for your permission or password for tasks such as installing applications, running utilities, or changing Windows settings. Refer to Help and Support for more information.

For additional information, access the Disk Defragmenter software Help.

Using Disk Cleanup

Disk Cleanup searches the hard drive for unnecessary files that you can safely delete to free up disk space and help the computer to run more efficiently.

To run Disk Cleanup:

1. Select **Start > All Programs > Accessories > System Tools > Disk Cleanup**.
2. Follow the on-screen instructions.

Replacing the hard drive in the hard drive bay

△ **CAUTION:** To prevent information loss or an unresponsive system:

Shut down the computer before removing the hard drive from the hard drive bay. Do not remove the hard drive while the computer is on, in the Sleep state, or in Hibernation.

If you are not sure whether the computer is off or in Hibernation, turn the computer on by sliding the power switch. Then shut down the computer through the operating system.

To remove the hard drive:

1. Save your work.
2. Shut down the computer and close the display.
3. Disconnect all external devices connected to the computer.
4. Unplug the power cord from the AC outlet.
5. Turn the computer upside down on a flat surface.
6. Remove the battery from the computer.
7. With the hard drive bay toward you, loosen the 3 hard drive cover screws (1).
8. Lift the hard drive cover away from the computer (2).

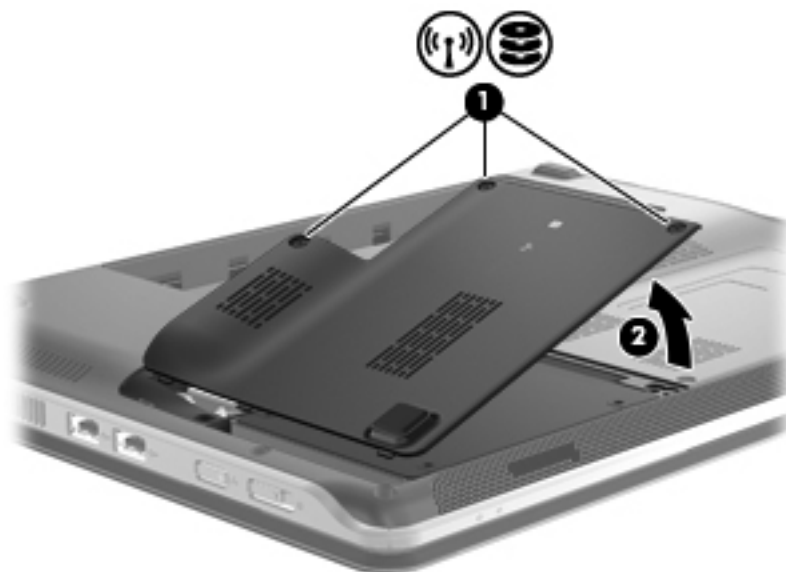

9. Loosen the 2 screws (1) that secure the hard drive to the computer.
10. Slide the hard drive to the left (2) to disconnect the hard drive.

11. Pivot the hard drive upward (3) and lift the hard drive out of the hard drive bay (4).

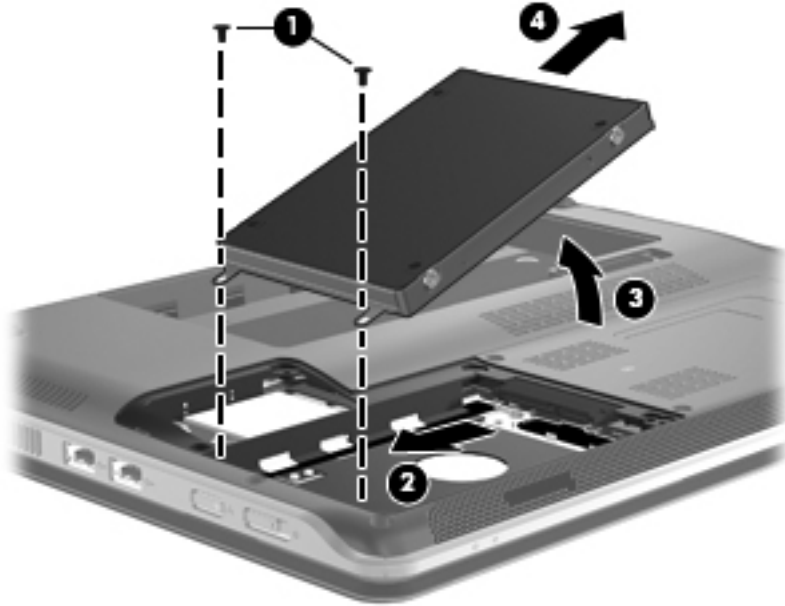

To install a hard drive:

1. Insert the hard drive into the hard drive bay (1).
2. Pivot the hard drive downward (2), and then slide the hard drive (3) to the right until the hard drive snaps into place.
3. Tighten the 2 screws (4) that secure the hard drive to the computer.

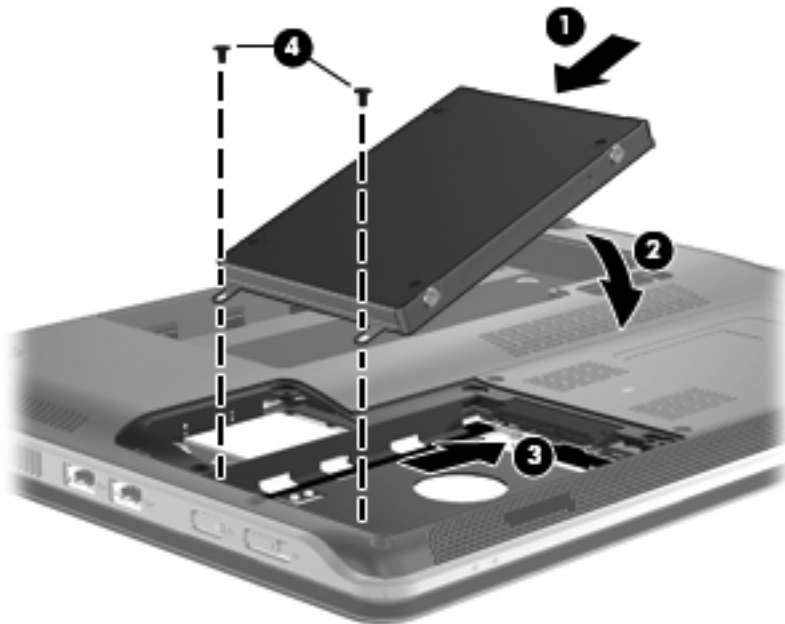

4. Align the tabs (1) on the hard drive cover with the notches on the computer.
5. Close the cover (2).

6. Tighten the 3 hard drive cover screws (3).

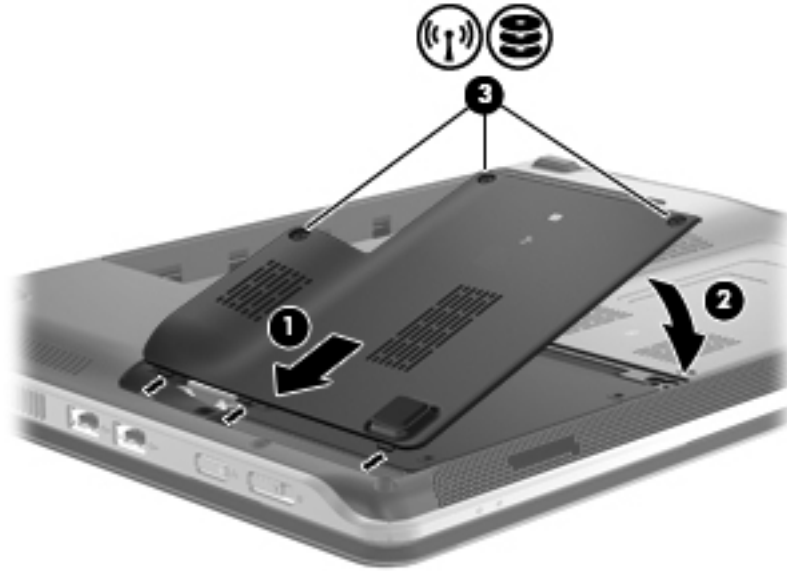

Using HP ProtectSmart Hard Drive Protection (select models only)

HP ProtectSmart Hard Drive Protection protects a hard drive by parking the drive and halting data requests under either of the following conditions:

- You drop the computer.
- You move the computer with the display closed while the computer is running on battery power.

A short time after the end of one of these events, HP ProtectSmart Hard Drive Protection returns the hard drive to normal operation.

 **NOTE:** Because solid-state drives (SSD) lack moving parts, protection by HP ProtectSmart Hard Drive Protection is unnecessary.

NOTE: Hard drives connected to USB ports are not protected by HP ProtectSmart Hard Drive Protection.

For more information, refer to the HP ProtectSmart Hard Drive Protection software Help.

Identifying HP ProtectSmart Hard Drive Protection status

The drive light on the computer turns amber to show that the drive is parked. To determine whether drives are currently protected or whether a drive is parked, select **Start > Control Panel > Hardware and Sound > Windows Mobility Center**:

- If the software is enabled, a green check mark is superimposed over the hard drive icon.
- If the software is disabled, a red X is superimposed over the hard drive icon.
- If the drives are parked, a yellow moon is superimposed over the hard drive icon.

 **NOTE:** The icon in the Mobility Center may not show the most up-to-date status for the drive. For immediate updates after a change in status, enable the notification area icon.

To enable the notification area icon:

1. Select **Start > Control Panel > Hardware and Sound > HP ProtectSmart Hard Drive Protection**.

 **NOTE:** If prompted by User Account Control, click **Yes**.

2. On the **Icon in System Tray** row, click **Show**.
3. Click **OK**.

Managing power with a parked hard drive

If HP ProtectSmart Hard Drive Protection has parked the drive, the computer will behave in the following ways:

- The computer will not shut down.
- The computer will not initiate Sleep or Hibernation, except as described in the following Note.

 **NOTE:** If the computer is running on battery power and reaches a critical battery level, HP ProtectSmart Hard Drive Protection allows the computer to initiate Hibernation.

Before you move the computer, HP recommends that you either shut it down or initiate Sleep or Hibernation.

Using HP ProtectSmart Hard Drive Protection software

The HP ProtectSmart Hard Drive Protection software enables you to perform the following tasks:

- Enable and disable HP ProtectSmart Hard Drive Protection.

 **NOTE:** Depending on your user privileges, you may not be able to enable or disable HP ProtectSmart Hard Drive Protection. Additionally, members of an Administrator group can change the privileges for non-Administrator users.

- Determine whether a drive in the system is supported.

To open the software and change settings, follow these steps:

1. In Mobility Center, click the hard drive icon to open the HP ProtectSmart Hard Drive Protection window.

– or –

Select **Start > Control Panel > Hardware and Sound > HP ProtectSmart Hard Drive Protection**.

 **NOTE:** If prompted by User Account Control, click **Yes**.

2. Click the appropriate button to change settings.
3. Click **OK**.

Using external drives

Removable external drives expand your options for storing and accessing information.

USB drives include the following types:

- 1.44-megabyte diskette drive
- Hard drive module (a hard drive with an adapter attached)

- DVD-ROM Drive
- DVD/CD-RW Combo Drive
- DVD±RW and CD-RW Combo Drive
- DVD±RW and CD-RW SuperMulti Double-Layer Combo Drive
- DVD±RW and CD-RW SuperMulti Double-Layer Combo Drive with LightScribe
- Blu-ray ROM DVD±R/RW SuperMulti DL Drive
- Blu-ray ROM with LightScribe DVD±R/RW SuperMulti DL Drive

 **NOTE:** For more information about required software and drivers, or to learn which computer port to use, refer to the manufacturer's instructions.

To connect an external drive to the computer:

△ **CAUTION:** To reduce the risk of damage to the equipment when connecting a powered drive, be sure that the AC power cord is unplugged.

1. Connect the drive to the computer.
2. If you are connecting a powered drive, plug the drive power cord into a grounded AC outlet.

To disconnect a powered drive, disconnect it from the computer, and then unplug the AC power cord.

Connecting optional external drives

 **NOTE:** For more information about required software and drivers, or to learn which computer port to use, refer to the manufacturer's instructions.

To connect an external drive to the computer:

△ **CAUTION:** To reduce the risk of damage to the equipment when connecting a powered drive, be sure that the drive is turned off and the AC power cord is unplugged.

1. Connect the drive to the computer.
2. If you are connecting a powered drive, plug the device power cord into a grounded AC outlet.
3. Turn on the drive.

To disconnect an unpowered external drive, turn off the drive, and then disconnect it from the computer. To disconnect a powered external drive, turn off the drive, disconnect it from the computer, and then unplug the AC power cord.

Sharing optical drives

Although your computer does not have an installed optical drive, you can easily access software, as well as install applications and access data, by sharing an optical drive from another computer that has an optical drive and is on the same wired or wireless network. Sharing drives is a feature of the Windows operating system that allows a drive on another computer to be made available for other people to use on a network.

 **NOTE:** For information on setting up a home network and sharing a drive, refer to Help and Support.

NOTE: Some discs, such as DVD movies and game discs, may be copy-protected and therefore unusable through DVD or CD sharing.

External devices

Using a USB device

A USB port connects an optional external device, such as a USB keyboard, mouse, drive, printer, scanner, or hub, to the computer or to an optional docking device or optional expansion product.

Some USB devices may require additional support software, which is usually included with the device. For more information about device-specific software, refer to the manufacturer's instructions.

The computer has 4 USB ports, which support USB 1.0, USB 1.1, and USB 2.0 devices. An optional USB hub, optional docking device, or an optional expansion product provides additional USB ports that can be used with the computer.

Connecting a USB device

△ **CAUTION:** To prevent damage to a USB connector, use minimal force to connect a USB device.

▲ To connect a USB device to the computer, connect the USB cable for the device to the USB port.



You will hear a sound when the device has been detected.

📄 **NOTE:** The first time you connect a USB device, the "Installing device driver software" message is displayed in the notification area, at the far right of the taskbar.

Removing a USB device

△ **CAUTION:** To prevent loss of information or an unresponsive system, use the following procedure to safely remove the USB device.

CAUTION: To prevent damage to a USB connector, do not pull on the cable to remove the USB device.

To remove a USB device:

1. Click the **Safely Remove Hardware and Eject Media** icon in the notification area, at the far right of the taskbar.

 **NOTE:** To display the **Safely Remove Hardware and Eject Media** icon, click the **Show hidden icons** icon (the arrow at the left of in the notification area).

2. Click the name of the device in the list.

 **NOTE:** You are prompted that it is safe to remove the hardware device.

3. Remove the device.

Using Digital Media Slot cards

Optional digital cards provide secure data storage and convenient data sharing. These cards are often used with digital media–equipped cameras and PDAs as well as with other computers.

The Digital Media Slot supports the following digital card formats:

- Memory Stick (MS)
- Memory Stick Pro (MSP)
- MultiMediaCard (MMC)
- Secure Digital (SD) Memory Card
- Secure Digital High Capacity (SDHC) Memory Card
- xD-Picture Card (XD)
- xD-Picture Card (XD) Type H
- xD-Picture Card (XD) Type M

Inserting a digital card

△ **CAUTION:** To avoid damaging the digital card or the computer, do not insert any type of adapter into the Digital Media Slot.

CAUTION: To prevent damage to the digital card connectors, use minimal force to insert a digital card.

1. Hold the digital card label-side up, with the connectors facing the computer.

2. Insert the card into the Digital Media Slot, and then push in on the card until it is firmly seated.

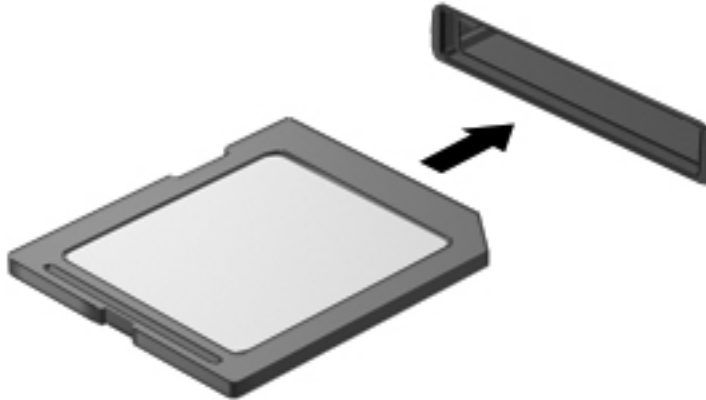

You will hear a sound when the device has been detected, and a menu of options may be displayed.

Removing a digital card

△ **CAUTION:** To prevent loss of data or an unresponsive system, use the following procedure to safely remove the digital card.

1. Save your information and close all programs associated with the digital card.

📄 **NOTE:** To stop a data transfer, click **Cancel** in the operating system Copying window.

2. To remove the digital card:

- a. Click the **Safely Remove Hardware and Eject Media** icon in the notification area, at the far right of the taskbar.

📄 **NOTE:** To display the **Safely Remove Hardware and Eject Media** icon, click the **Show hidden icons** icon (the arrow at the left of the notification area).

- b. Click the name of the digital card in the list.

📄 **NOTE:** You are prompted that it is safe to remove the hardware device.

3. Press in on the digital card (1), and then remove the card from the slot (2).

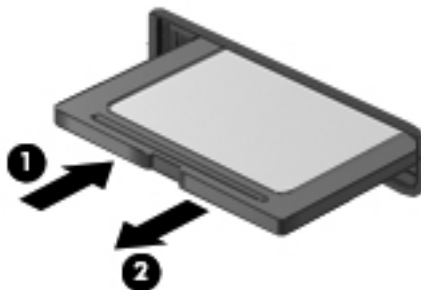

9 Security

Protecting the computer

Standard security features provided by the Windows® operating system and the non-Windows Setup Utility can protect your personal settings and data from a variety of risks.

Follow the procedures in this guide to use the following features:

- Passwords
- Antivirus software
- Firewall software
- Critical security updates
- Optional security cable

 **NOTE:** Security solutions are designed to act as deterrents, but they may not deter software attacks or prevent the computer from being mishandled or stolen.

NOTE: Before you send your computer for service, remove all password and fingerprint settings.

Computer risk	Security feature
Unauthorized use of the computer	<ul style="list-style-type: none">• QuickLock• Power-on password
Computer viruses	Norton Internet Security software
Unauthorized access to data	<ul style="list-style-type: none">• Firewall software• Windows updates
Unauthorized access to Setup Utility, BIOS settings, and other system identification information	Administrator password
Ongoing or future threats to the computer	Critical security updates from Microsoft
Unauthorized access to a Windows user account	User password
Unauthorized removal of the computer	Security cable slot (used with an optional security cable)

Using passwords

A password is a group of characters that you choose to secure your computer information. Several types of passwords can be set, depending on how you want to control access to your information. Passwords can be set in Windows or in the non-Windows Setup Utility preinstalled on the computer.

 **CAUTION:** To prevent being locked out of the computer, record each password you set. Because most passwords are not displayed as they are set, changed, or deleted, it is essential to record each password immediately and store it in a secure place.

You can use the same password for a Setup Utility feature and for a Windows security feature. You can also use the same password for more than one Setup Utility feature.

Use the following guidelines when setting a password in Setup Utility:

- A password can be any combination of up to 8 letters and numbers and is case sensitive.
- A password set in Setup Utility must be entered at a Setup Utility prompt. A password set in Windows must be entered at a Windows prompt.

Use the following tips for creating and saving passwords:

- When creating passwords, follow requirements set by the program.
- Write down your passwords and store them in a secure place away from the computer.
- Do not store passwords in a file on the computer.
- Do not use your name or other personal information that could be easily discovered by an outsider.

The following sections list Windows and Setup Utility passwords and describe their functions. For additional information about Windows passwords, such as screen-saver passwords, select **Start > Help and Support**.

Setting passwords in Windows

Password	Function
Administrator password	Protects administrator-level access to computer contents. NOTE: This password cannot be used to access Setup Utility contents.
User password	Protects access to a Windows user account. It also protects access to the computer contents and must be entered when you exit Sleep or Hibernation.
QuickLock	Protects the computer by requiring a password to be entered in the Windows Log On dialog box before you access the computer. After you set a user or administrator password, follow these steps: <ol style="list-style-type: none">1. To initiate QuickLock, press and hold the QuickLock (f5) key.2. Exit QuickLock by entering your Windows user or administrator password.

Setting passwords in Setup Utility

Password	Function
Administrator password*	<ul style="list-style-type: none">• Protects access to Setup Utility.• After this password is set, it must be entered each time you access Setup Utility. CAUTION: If you forget your administrator password, you cannot access Setup Utility.

Password	Function
Power-on password*	<ul style="list-style-type: none"> Protects access to the computer contents. After this password is set, it must be entered each time you turn on or restart the computer, or exit Hibernation. <p>CAUTION: If you forget your power-on password, you cannot turn on or restart the computer, or exit Hibernation.</p> <p>NOTE: The administrator password can be used in place of the power-on password.</p>

*For details about each of these passwords, refer to the following topics.

Administrator password

Your administrator password protects the configuration settings and system identification information in Setup Utility. After this password is set, you must enter it each time you access Setup Utility.

Your administrator password is not interchangeable with an administrator password set in Windows, nor is it displayed as it is set, entered, changed, or deleted. Be sure that you record your password and store it in a safe place.

Managing an administrator password

To set, change, or delete this password, follow these steps:

1. Open Setup Utility by turning on or restarting the computer. While the “Press the ESC key for Startup Menu” message is displayed in the lower-left corner of the screen, press **f10**.

– or –

Open Setup Utility by turning on or restarting the computer. While the “Press the ESC key for Startup Menu” message is displayed in the lower-left corner of the screen, press **esc**. When the Startup Menu is displayed, press **f10**.

2. Use the arrow keys to select **Security > Set Administrator Password**, and then press **enter**.
 - To set an administrator password, type your password in the **Enter New Password** and **Confirm New Password** fields, and then press **enter**.
 - To change an administrator password, type your current password in the **Enter Current Password** field, type a new password in the **Enter New Password** and **Confirm New Password** fields, and then press **enter**.
 - To delete an administrator password, type your current password in the **Enter Password** field, and then press **enter** 4 times.
3. To save your changes and exit Setup Utility, use the arrow keys to select **Exit > Exit Saving Changes**.

Your changes go into effect when the computer restarts.

Entering an administrator password

At the **Enter Password** prompt, type your administrator password, and then press **enter**. After 3 unsuccessful attempts to enter the administrator password, you must restart the computer and try again.

Power-on password

Your power-on password prevents unauthorized use of the computer. After this password is set, it must be entered each time you turn on or restart the computer, or exit Hibernation. A power-on password is not displayed as it is set, entered, changed, or deleted.

Managing a power-on password

To set, change, or delete this password, follow these steps:

1. Open Setup Utility by turning on or restarting the computer. While the “Press the ESC key for Startup Menu” message is displayed in the lower-left corner of the screen, press **f10**.

– or –

Open Setup Utility by turning on or restarting the computer. While the “Press the ESC key for Startup Menu” message is displayed in the lower-left corner of the screen, press **esc**. When the Startup Menu is displayed, press **f10**.

2. Use the arrow keys to select **Security > Set Power-On Password**, and then press **enter**.
 - To set a power-on password, type your password in the **Enter New Password** and **Confirm New Password** fields, and then press **enter**.
 - To change a power-on password, type your current password in the **Enter Current Password** field, type a new password in the **Enter New Password** and **Confirm New Password** fields, and then press **enter**.
 - To delete a power-on password, type your current password in the **Enter Current Password** field, and then press **enter** 4 times.
3. To save your changes and exit Setup Utility, use the arrow keys to select **Exit > Exit Saving Changes**.

Your changes go into effect when the computer restarts.

Entering a power-on password

At the **Enter Password** prompt, type your password, and then press **enter**. After 3 unsuccessful attempts to enter the password, you must restart the computer and try again.

Using antivirus software

When you use the computer to access e-mail, a network, or the Internet, you expose it to computer viruses. Computer viruses can disable the operating system, programs, or utilities, or cause them to function abnormally.

Antivirus software can detect most viruses, destroy them, and in most cases, repair any damage they have caused. To provide ongoing protection against newly discovered viruses, antivirus software must be kept up to date.

Norton Internet Security, an antivirus program, is preinstalled on the computer. The software includes 60 days of free updates. It is strongly recommended that you protect the computer against new viruses beyond 60 days by purchasing extended update service. Instructions for using and updating Norton Internet Security software and for purchasing extended update service are provided within the program. To view and access Norton Internet Security, select **Start > All Programs > Norton Internet Security**.

For more information about computer viruses, type `viruses` in the Search box in Help and Support.

Using firewall software

When you use the computer for e-mail, network, or Internet access, unauthorized persons may be able to gain access to the computer, your personal files, and information about you. Use the firewall software preinstalled on the computer to protect your privacy.

Firewall features include logging and reporting of network activity, and automatic monitoring of all incoming and outgoing traffic. Refer to the firewall user guide or contact your firewall manufacturer for more information.

 **NOTE:** Under some circumstances a firewall can block access to Internet games, interfere with printer or file sharing on a network, or block authorized e-mail attachments. To temporarily resolve the problem, disable the firewall, perform the task that you want to perform, and then reenable the firewall. To permanently resolve the problem, reconfigure the firewall.

Installing critical security updates

 **CAUTION:** Microsoft sends alerts regarding critical updates. To protect the computer from security breaches and computer viruses, install all critical updates from Microsoft as soon as you receive an alert.

Updates to the operating system and other software may have become available after the computer was shipped. To be sure that all available updates are installed on the computer, observe these guidelines:

- Run Windows Update as soon as possible after you set up your computer. Use the update link at **Start > All Programs > Windows Update**.
- Run Windows Update monthly thereafter.
- Obtain updates to Windows and other Microsoft® programs, as they are released, from the Microsoft Web site and through the updates link in Help and Support.

Installing an optional security cable

 **NOTE:** A security cable is designed to act as a deterrent, but it may not prevent the computer from being mishandled or stolen.

1. Loop the security cable around a secured object.
2. Insert the key **(1)** into the cable lock **(2)**.
3. Insert the cable lock into the security cable slot on the computer **(3)**, and then lock the cable lock with the key.

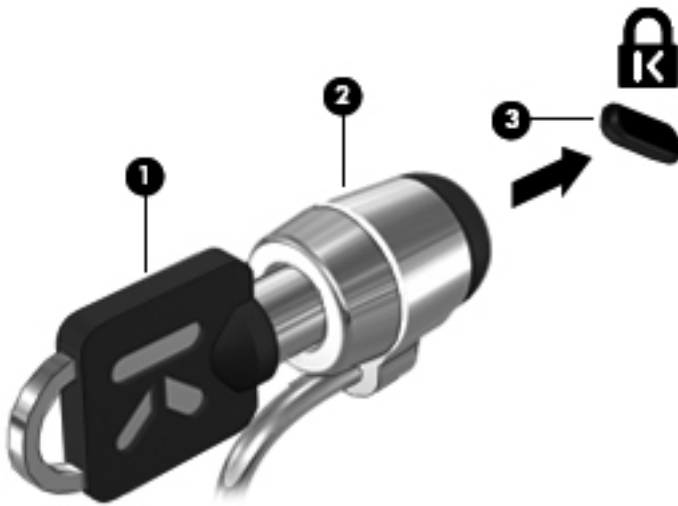

10 Changing QuickWeb settings

Turning HP QuickWeb on and off

To disable or reenable QuickWeb from within the Windows operating system:

1. Select **Start > All Programs > HP QuickWeb > HP QuickWeb Configuration Tool**. The QuickWeb dialog box is displayed.
2. Click the **Status** tab.
3. Select the **Enable** or **Disable** check box to turn on or off QuickWeb.
4. Click **OK**.

 **NOTE:** The HP QuickWeb Configuration Tool can also be accessed by selecting **Start > Control Panel**, and then clicking the **View by** arrow. Select **Large icons** or **Small icons** to locate the HP QuickWeb Configuration Tool.

A Setup Utility (BIOS)

Starting Setup Utility

Setup Utility is a ROM-based information and customization utility that can be used even when your Windows® operating system is not working.

The utility reports information about the computer and provides settings for startup, security, and other preferences.

To start Setup Utility:

- ▲ Open Setup Utility by turning on or restarting the computer. While the “Press the ESC key for Startup Menu” message is displayed in the lower-left corner of the screen, press **f10**.

– or –

1. Open Setup Utility by turning on or restarting the computer. While the “Press the ESC key for Startup Menu” message is displayed in the lower-left corner of the screen, press **esc**.
2. When the Startup Menu is displayed, press **f10**.

Using Setup Utility

Navigating and selecting in Setup Utility

Because Setup Utility is not Windows based, it does not support the TouchPad. Navigation and selection are by keystroke.

- To choose a menu or a menu item, use the arrow keys.
- To choose an item in a list or to toggle a field, for example an Enable/Disable field, use either the arrow keys or **f5** or **f6**.
- To select an item, press **enter**.
- To close a text box or return to the menu display, press **esc**.
- To display additional navigation and selection information while Setup Utility is open, press **f1**.

Changing the language of Setup Utility

The following procedure explains how to change the language of Setup Utility. If Setup Utility is not already running, begin at step 1. If Setup Utility is already running, begin at step 2.

1. Open Setup Utility by turning on or restarting the computer. While the “Press the ESC key for Startup Menu” message is displayed in the lower-left corner of the screen, press **f10**.

– or –

Open Setup Utility by turning on or restarting the computer. While the “Press the ESC key for Startup Menu” message is displayed in the lower-left corner of the screen, press **esc**. When the Startup Menu is displayed, press **f10**.

2. Use the arrow keys to select **System Configuration > Language**, and then press **enter**.

3. Use the arrow keys to select a language, and then press **enter**.
4. When a confirmation prompt with your language selected is displayed, press **enter**.
5. To save your change and exit Setup Utility, use the arrow keys to select **Exit > Exit Saving Changes**, and then press **enter**.

Your change goes into effect immediately.

Displaying system information

The following procedure explains how to display system information in Setup Utility. If Setup Utility is not open, begin at step 1. If Setup Utility is open, begin at step 2.

1. Open Setup Utility by turning on or restarting the computer. While the “Press the ESC key for Startup Menu” message is displayed in the lower-left corner of the screen, press **f10**.
– or –
Open Setup Utility by turning on or restarting the computer. While the “Press the ESC key for Startup Menu” message is displayed in the lower-left corner of the screen, press **esc**. When the Startup Menu is displayed, press **f10**.
2. Select the **Main** menu. System information such as the system time and date, and identification information about the computer is displayed.
3. To exit Setup Utility without changing any settings, use the arrow keys to select **Exit > Exit Discarding Changes**, and then press **enter**.

Restoring default settings in Setup Utility

The following procedure explains how to restore Setup Utility default settings. If Setup Utility is not already running, begin at step 1. If Setup Utility is already running, begin at step 2.

1. Open Setup Utility by turning on or restarting the computer. While the “Press the ESC key for Startup Menu” message is displayed in the lower-left corner of the screen, press **f10**.
– or –
Open Setup Utility by turning on or restarting the computer. While the “Press the ESC key for Startup Menu” message is displayed in the lower-left corner of the screen, press **esc**. When the Startup Menu is displayed, press **f10**.
2. Use the arrow keys to select **Exit > Load Setup Defaults**, and then press **enter**.
3. When the Setup Confirmation is displayed, press **enter**.
4. To save your change and exit Setup Utility, use the arrow keys to select **Exit > Exit Saving Changes**, and then press **enter**.

Setup Utility default settings go into effect when the computer restarts.

 **NOTE:** Your password, security, and language settings are not changed when you restore the factory default settings.

Exiting Setup Utility

You can exit Setup Utility with or without saving changes.

- To exit Setup Utility and save your changes from the current session:
If Setup Utility menus are not visible, press **esc** to return to the menu display. Then use the arrow keys to select **Exit > Exit Saving Changes**, and then press **enter**.
- To exit Setup Utility without saving your changes from the current session:
If Setup Utility menus are not visible, press **esc** to return to the menu display. Then use the arrow keys to select **Exit > Exit Discarding Changes**, and then press **enter**.

After either choice, the computer restarts in Windows.

Setup Utility menus

The menu tables in this section provide an overview of Setup Utility options.

 **NOTE:** Some Setup Utility menu items listed in this chapter may not be supported by your computer.

Main menu

Select	To do this
System information	<ul style="list-style-type: none">• View and change the system time and date.• View identification information about the computer.• View specification information about the processor, memory size, system BIOS, and keyboard controller version (select models only).

Security menu

Select	To do this
Administrator password	Enter, change, or delete an administrator password.
Power-On Password	Enter, change, or delete a power-on password.

System Configuration menu

Select	To do this
Language Support	Change the language of Setup Utility.
Virtualization Technology (select models only)	Enable/disable the processor Virtualization Technology.
Fan Always On	Enabled/disable Fan Always On. When enabled, the computer fan will always be on.
Action Key Mode	Enable/disable the Action Key Mode.

Select	To do this
Boot Options	<p>Set the following boot options:</p> <ul style="list-style-type: none"> • POST Hot Key Delay (sec.)—Set the delay for the user to press hot keys in intervals of 5 seconds each (0, 5, 10, 15, 20). • QuickWeb Support—Enable/disable the QuickWeb Boot Menu during Setup Utility. Set the delay for the user to start Setup Utility in 5 or 10 second intervals. • CD-ROM Boot—Enable/disable boot from CD-ROM • Floppy Boot—Enable/disable boot from diskette. • Internal Network Adapter Boot—Enable/disable boot from Network Adapter. • Boot Order—Set the boot order for: <ul style="list-style-type: none"> ◦ Notebook Hard Drive ◦ Internal CD/DVD ROM Drive ◦ USB Diskette on Key/USB Hard Drive ◦ USB CD/DVD ROM Drive ◦ USB Floppy ◦ Network adapter
LAN Power Saving (select models only)	Enable/disable the LAN Power Saving Mode.

Diagnostics menu

Select	To do this
Primary Hard Disk Self Test	Run a comprehensive self-test on the hard drive.
Memory Test	Run a diagnostic test on the system memory.

Updating the BIOS

Updated versions of the BIOS may be available on the HP Web site. Most BIOS updates on the HP Web site are packaged in compressed files called *SoftPaqs*.

Some download packages contain a file named Readme.txt, which contains information regarding installing and troubleshooting the file.

Determining the BIOS version

To determine whether available BIOS updates contain later BIOS versions than those currently installed on the computer, you need to know the version of the system BIOS currently installed.

BIOS version information (also known as *ROM date* and *System BIOS*) can be displayed by pressing **fn+esc** (if you are already in Windows) or by opening Setup Utility.

To use Setup Utility for displaying BIOS information:

1. Open Setup Utility by turning on or restarting the computer. While the “Press the ESC key for Startup Menu” message is displayed in the lower-left corner of the screen, press **f10**.
2. If Setup Utility does not open with the system information displayed, use the arrow keys to select the **Main** menu.

When the Main menu is selected, BIOS and other system information is displayed.

3. To exit Setup Utility, use the arrow keys to select **Exit > Exit Discarding Changes**, and then press **enter**.

Downloading a BIOS update

- △ **CAUTION:** To prevent damage to the computer or an unsuccessful installation, download and install a BIOS update only when the computer is connected to reliable external power using the AC adapter. Do not download or install a BIOS update while the computer is running on battery power, docked in an optional docking device or an optional expansion product, or connected to an optional power source. During the download and installation, follow these instructions:

Do not disconnect power from the computer by unplugging the power cord from the AC outlet.

Do not shut down the computer or initiate Sleep or Hibernation.

Do not insert, remove, connect, or disconnect any device, cable, or cord.

To download a BIOS update:

1. Access the page on the HP Web site that provides software for your computer:
Select **Start > Help and Support**, and then click the link for software, driver, and BIOS updates.
2. Follow the instructions on the screen to identify your computer and access the BIOS update you want to download.
3. At the download area, follow these steps:
 - a. Identify the BIOS update that is later than the BIOS version currently installed on your computer. Make a note of the date, name, or other identifier. You may need this information to locate the update later, after it has been downloaded to your hard drive.
 - b. Follow the instructions on the screen to download your selection to the hard drive.

Make a note of the path to the location on your hard drive where the BIOS update will be downloaded. You will need to access this path when you are ready to install the update.

- 📄 **NOTE:** If you connect your computer to a network, consult the network administrator before installing any software updates, especially system BIOS updates.

BIOS installation procedures vary. Follow any instructions that are displayed on the screen after the download is complete. If no instructions are displayed, follow these steps:

1. Open Windows Explorer by selecting **Start > Computer**.
2. Double-click your hard drive designation. The hard drive designation is typically Local Disk (C:).
3. Using the hard drive path you recorded earlier, open the folder on your hard drive that contains the update.
4. Double-click the file that has an .exe extension (for example, *filename.exe*).

The BIOS installation begins.

5. Complete the installation by following the instructions on the screen. The system automatically shuts down after the BIOS has successfully updated.

 **NOTE:** After a message on the screen reports a successful installation, you can delete the downloaded file from your hard drive.

Updating programs and drivers

To download and install software other than a BIOS update, follow these steps:

1. Access the page on the HP Web site that provides software for your device:
Select **Start > Help and Support**, and then select the software and drivers update.
2. Follow the instructions on the screen to find the software you want to update.
3. At the download area, select the software you want to download and follow the instructions on the screen.

 **NOTE:** Make a note of the path to the location on your hard drive where the software will be downloaded. You will need to access this path when you are ready to install the software.

4. When the download is complete, open Windows Explorer by selecting **Start > Computer**.
5. Double-click your hard drive designation. The hard drive designation is typically Local Disk (C:).
6. Using the hard drive path you recorded earlier, open the folder on your hard drive that contains the update.
7. Double-click the file that has an .exe extension (for example, *filename.exe*).
The installation begins.
8. Complete the installation by following the instructions on the screen.

 **NOTE:** After a message on the screen reports a successful installation, you can delete the downloaded file from your hard drive.

B Backup and recovery

Recovery after a system failure is as complete as your most current backup. HP recommends that you create recovery discs immediately after software setup. As you add new software and data files, you should continue to back up your system on a regular basis to maintain a reasonably current backup.

Tools provided by the operating system and HP Recovery Manager software are designed to help you with the following tasks for safeguarding your information and restoring it in case of a system failure:

- Creating a set of recovery discs using Recovery Manager.
- Backing up your information regularly to protect your important system files.
- Creating system restore points using the Windows® System Restore feature, and periodically copy them to disc.
- Recovering a program or driver (Recovery Manager software feature). This feature helps you reinstall a program or driver without performing a full system recovery.
- Performing a full system recovery (Recovery Manager software feature). With Recovery Manager, you can recover your full factory image if you experience system failure or instability. Recovery Manager works from a dedicated recovery partition on the hard drive or from recovery discs you created or purchased.

Creating recovery discs

HP recommends that you create recovery discs to be sure that you can restore your system to its original factory state if you experience serious system failure or instability. Create these discs after setting up the computer for the first time.

Handle these discs carefully and keep them in a safe place. The software allows the creation of only one set of recovery discs.

 **NOTE:** If your computer does not include an internal optical drive, you can use an optional external optical drive (select models only) to create recovery discs, or you can purchase recovery discs for your computer from the HP Web site.

NOTE: The external optical drive must be connected to the USB port *on the computer*, not to a USB port on another external device, such as a hub or docking station.

Note the following guidelines before creating recovery discs:

- You will need high-quality DVD-R, double-layer DVD-R, DVD+R, double-layer DVD+R, BD-R (writable Blu-ray), or CD-R discs. All these discs are purchased separately. DVDs and BDs have a much higher capacity than CDs. If you use CDs, up to 20 discs may be required, whereas only a few DVDs or BDs are required.

 **NOTE:** Read-write discs, such as CD-RW, DVD±RW, double-layer DVD±RW, and BD-RE (rewritable Blu-ray) discs, are not compatible with the Recovery Manager software.

- The computer must be connected to AC power during this process.
- Only one set of recovery discs can be created per computer.

- Number each disc before inserting it into the optical drive.
- If necessary, you can exit the program before you have finished creating the recovery discs. The next time you open Recovery Manager, you will be prompted to continue the disc creation process.

To create a set of recovery discs:

1. Select **Start > All Programs > Recovery Manager > Recovery Disc Creation**.
Recovery Manager opens.
2. Follow the on-screen instructions.

Backing up your information

Recovery after a system failure is as complete as your latest backup. You should create a set of recovery discs immediately after software setup. These discs will allow you to start up (boot) the computer in case of system instability or failure.

As you add new software and data files, you should continue to back up your system on a regular basis to maintain a reasonably current backup. Back up your system at the following times:

- On a regularly scheduled basis

 **NOTE:** Set reminders to back up your information periodically.

- Before the computer is repaired or restored
- Before you add or modify hardware or software

Note the following when backing up:

- Create a set of recovery discs using Recovery Manager.
- Create system restore points using the Windows® System Restore feature, and periodically copy them to disc.
- Store personal files in the Documents library and back up this folder periodically.
- Back up templates stored in their associated programs.
- Save customized settings in a window, toolbar, or menu bar by taking a screen shot of your settings. The screen shot can be a time-saver if you have to reset your preferences.

To copy the screen and paste it into a word-processing document, follow these steps:

1. Display the screen.
 2. Copy the screen:
 - To copy only the active window, press **alt+fn+prt sc**.
 - To copy the entire screen, press **fn+prt sc**.
 3. Open a word-processing document, and then select **Edit > Paste**.
 4. Save the document.
- You can back up your information to an external hard drive, a network drive, or discs.
 - When backing up to discs, use any of the following types of discs (purchased separately): CD-R, CD-RW, DVD+R, DVD+R DL, DVD-R, DVD-R DL, or DVD±RW. The discs you use will depend on the type of external optical drive connected to your computer.

 **NOTE:** The external optical drive must be connected to a USB port *on the computer*, not to a USB port on another external device, such as a hub or docking station.

NOTE: DVDs and DVDs with double-layer (DL) support store more information than CDs, so using them for backup reduces the number of recovery discs required.

- When backing up to discs, number each disc before inserting it into the optical drive.

Using Windows Backup and Restore

To create a backup using Windows Backup and Restore, follow these steps:

 **NOTE:** Be sure that the computer is connected to AC power before you start the backup process.

NOTE: The backup process may take over an hour, depending on file size and the speed of the computer.

1. Select **Start > All Programs > Maintenance > Backup and Restore**.
2. Follow the on-screen instructions to set up and create a backup.

 **NOTE:** Windows® includes the User Account Control feature to improve the security of your computer. You may be prompted for your permission or password for tasks such as installing software, running utilities, or changing Windows settings. Refer to Help and Support for more information.

Using system restore points

When you back up your system, you are creating a system restore point. A system restore point allows you to save and name a snapshot of your hard drive at a specific point in time. You can then recover back to that point if you want to reverse subsequent changes made to your system.

 **NOTE:** Recovering to an earlier restore point does not affect data files saved or e-mails created since the last restore point.

You also can create additional restore points to provide increased protection for your system files and settings.

When to create restore points

- Before you add or extensively modify software or hardware
- Periodically, whenever the system is performing optimally

 **NOTE:** If you revert to a restore point and then change your mind, you can reverse the restoration.

Create a system restore point

1. Select **Start > Control Panel > System and Security > System**.
2. In the left pane, click **System Protection**.
3. Click the **System Protection** tab.
4. Under **Protection settings**, select the disk for which you want to create a restore point.
5. Click **Create**.
6. Follow the on-screen instructions.

Restore to a previous date and time

To revert to a restore point (created at a previous date and time), when the computer was functioning optimally, follow these steps:

1. Select **Start > Control Panel > System and Security > System**.
2. In the left pane, click **System protection**.
3. Click the **System Protection** tab.
4. Click the **System Restore** button.
5. Follow the on-screen instructions.

Performing a recovery

 **NOTE:** You can recover only files that you have previously backed up. HP recommends that you use HP Recovery Manager to create a set of recovery discs (an entire drive backup) as soon as you set up your computer.

Recovery Manager software allows you to repair or restore the system if you experience system failure or instability. Recovery Manager works from recovery discs you created (select models only) or purchased, or from a dedicated recovery partition on the hard drive or solid-state drive (SSD).

 **NOTE:** Windows has its own built-in repair features, such as System Restore. If you have not already tried these features, try them before using Recovery Manager.

NOTE: Recovery Manager recovers only software that was preinstalled at the factory. Software not provided with this computer must be downloaded from the manufacturer's Web site or reinstalled from the disc provided by the manufacturer.

Recovering using the recovery discs

To restore the system from the recovery discs:

1. Back up all personal files.
2. Insert the first recovery disc into the optical drive and restart the computer.
3. Follow the on-screen instructions.

Recovering using the dedicated recovery partition

On some models, you can perform a recovery from the partition on the hard drive from either the Start button or **f11**. This restores the computer to its factory condition.

To restore the system from the partition, follow these steps:

1. Access Recovery Manager in either of the following ways:
 - Select **Start > All Programs > Recovery Manager > Recovery Manager**.
 - or –
 - Turn on or restart the computer, and then press **esc** while the “Press the ESC key for Startup Menu” message is displayed at the bottom of the screen. Then press **f11** while the “Press <F11> for System Recovery” message is displayed on the screen.
2. Click **System Recovery** in the **Recovery Manager** window.
3. Follow the on-screen instructions.

Index

A

- AC adapter
 - identifying 11
 - testing 41
- AC adapter light, identifying 7
- AC power, connecting 41
- action key mode 73
- action keys
 - audio CD, DVD, or BD
 - controls 27
 - decrease screen brightness 26
 - identifying 4
 - muting speaker sound 27
 - QuickLock 27
 - Sleep 27
 - switching screen image 27
 - using 26
 - volume 31
- administrator password
 - creating 66
 - entering 66
 - managing 66
- airport security devices 55
- antennas 10
- antivirus software, using 67
- applications key, Windows 4
- audio devices, connecting
 - external 34
- audio functions, checking 34
- audio-in (microphone) jack, identifying 7
- audio-out (headphone) jack, identifying 7

B

- backing up
 - customized window, toolbar, and menu bar settings 78
 - personal files 78
 - templates 78
- battery
 - calibrating 46
 - charging 44, 46

- conserving power 48
- discharging 45
- disposing 49
- inserting 43
- low battery levels 45
- recharging 48
- removing 43
- replacing 49
- storing 49
- battery bay 12
- battery bay, identifying 8
- battery light 5, 45
- battery power 42
- battery release latch 8, 43
- battery temperature 49
- battery, identifying 11
- bays
 - battery 12
 - hard drive 9
- BD drive 60
- Blu-ray Disc ROM with SuperMulti DVD±R/RW Double Layer 60
- Bluetooth device 13
- Bluetooth label 12
- boot options 74
- boot order 74
- buttons
 - TouchPad 2
 - TouchPad on/off 3
 - wireless 6

C

- cables
 - LAN 22
 - USB 61
- calibrating battery 46
- caps lock light, identifying 3
- CD drive 60
- Certificate of Authenticity label 12
- charging batteries 44, 46
- checking audio functions 34
- compartments
 - memory module 9

- WLAN module 9
- WWAN module 9
- components
 - additional hardware 11
 - bottom 8
 - display 9
 - front 5
 - left-side 6
 - right-side 5
 - top 2
- connection, external power 41
- connector, power 6
- conservation, power 48
- cord, power 11
- critical battery level 45
- critical security updates, installing 68

D

- default settings, restoring 72
- Diagnostics menu 74
- digital card
 - inserting 62
 - removing 63
 - stopping 63
 - supported formats 62
- Digital Media Slot, identifying 7
- Disk Cleanup software 56
- Disk Defragmenter software 55
- diskette drive 59
- display image, switching 27
- drive light, identifying 5
- drive media 38
- drives
 - boot order 74
 - connecting external 60
 - diskette 59
 - external 59
 - hard 56, 57, 59
 - optical 60
- DVD drive 60

E

- encryption 17

End hotkey 28
entering a power-on
password 67
entering an administrator
password 66
esc key, identifying 4
external audio devices,
connecting 34
external drive 59
external monitor port,
identifying 7, 35
external optical drive 33

F
f11 80
fan always on 73
firewall 17
firewall software, using 68
fn key, identifying 4, 27
full system recovery 77

H
hard drive
external 59
HP ProtectSmart Hard Drive
Protection 58
installing 57
removing 56
replacing 56
hard drive bay, identifying 9
HDMI port, identifying 7, 35
HDMI, connecting 35
headphone (audio-out) jack 7
Hibernation
exiting 39
initiated during critical battery
level 45
initiating 39
high-definition devices,
connecting 35
Home hotkey 28
hotkeys
description 27
display system information 28
End 28
Home 28
page down 28
page up 28
using 28

HP Connection Manager
software 15
HP Mobile Broadband
Module 17, 18
HP ProtectSmart Hard Drive
Protection 58
HP USB Ethernet Adapter,
connecting 22
hubs 61

I
icons
network 13, 21
wireless 13
installed drives, identifying 54
integrated webcam light,
identifying 9
interference, minimizing 22
internal microphone, identifying 9
Internet connection setup 16

J
jacks
audio-in (microphone) 7
audio-out (headphone) 7
RJ-45 (network) 7

K
keyboard hotkeys, identifying 27
keypad keys, identifying 4
keypad, embedded
enabling and disabling 29
identifying 28
switching key functions 30
using 29
keypad, external
num lock 30
using 30
keys
action 4
esc 4
fn 4
keypad 4
num lk 4
volume mute 31
Windows applications 4
Windows logo 4

L
labels
Bluetooth 12

HP Mobile Broadband
Module 12
Microsoft Certificate of
Authenticity 12
regulatory 12
serial number 11
SIM 12
wireless certification 12
WLAN 12
language support 73
latch, battery release 8
lights
battery 5
caps lock 3
drive 5, 58
mute 3
num lock 3, 29
power 5, 7
TouchPad 2
webcam 9
wireless 6
local area network (LAN)
cable required 22
connecting cable 22
low battery level 45

M
Main menu 73
maintenance
Disk Cleanup 56
Disk Defragmenter 55
managing a power-on
password 67
managing an administrator
password 66
media activity keys 32
media controls, keys 27
MediaSmart
starting 33
using 33
memory module
inserting 52
removing 52
memory module compartment
cover
removing 51
replacing 53
memory module compartment,
identifying 9
memory test 74

- microphone (audio-in) jack 7
 - Microsoft Certificate of Authenticity label 12
 - minimizing interference 22
 - monitor port, external 7
 - monitor, connecting 35
 - mouse, external, setting preferences 24
 - multimedia software
 - installing 33
 - using 33
 - mute key, using 31
 - mute light, identifying 3
- N**
- network cable
 - connecting 22
 - noise suppression circuitry 22
 - network icon 13, 21
 - network key 21
 - network security codes
 - network key 21
 - SSID 21
 - noise suppression circuitry, network cable 22
 - num lk key, identifying 4
 - num lock light, identifying 3, 29
 - num lock, external keypad 30
- O**
- operating system
 - Microsoft Certificate of Authenticity label 12
 - Product Key 12
 - optical drive
 - external 33
 - sharing 33, 60
- P**
- page down hotkey 28
 - page up hotkey 28
 - passwords
 - administrator 66
 - power-on 67
 - set in Setup Utility 65
 - set in Windows 65
 - pinching TouchPad gesture 25
 - pointing devices, setting preferences 24
 - ports
 - external monitor 7, 35
 - HDMI 7, 35
 - USB 6, 7, 61
 - power
 - connecting 41
 - conserving 48
 - power connector, identifying 6
 - power cord, identifying 11
 - power light, identifying 5
 - power switch, identifying 6
 - power-on password
 - creating 67
 - entering 67
 - managing 67
 - primary hard disk self test 74
 - Product Key 12
 - product name and number, computer 11
 - programs, updating 76
 - programs, using 33
 - projector, connecting 35
- Q**
- QuickLock key 27
- R**
- readable media 38
 - recovering a program or driver 77
 - recovering using the dedicated recovery partition 80
 - recovering using the recovery discs 80
 - recovery discs 77
 - Recovery Manager 77, 80
 - recovery partition 77
 - recovery, system 80
 - regulatory information
 - regulatory label 12
 - wireless certification labels 12
 - restore points 79
 - RJ-45 (network) jack, identifying 7
 - rotating TouchPad gesture 25
- S**
- screen brightness keys 27
 - screen image, switching 27
 - scrolling regions, TouchPad 3
 - scrolling TouchPad gesture 24
 - security cable slot, identifying 6
 - security cable, installing 68
 - Security menu 73
 - security, wireless 16
 - serial number label 11
 - serial number, computer 11
 - setup of WLAN 16
 - Setup Utility
 - changing the language 71
 - displaying system information 72
 - exiting 73
 - menus 73
 - navigating 71
 - passwords set in 65
 - restoring default settings 72
 - selecting 71
 - starting 71
 - shared drives 60
 - shutdown 49
 - SIM
 - inserting 18
 - removing 19
 - SIM slot, identifying 8
 - Sleep
 - exiting 38
 - initiating 38
 - Sleep key 27
 - slots
 - Digital Media 7
 - security cable 6
 - SIM 8
 - software
 - Disk Cleanup 56
 - Disk Defragmenter 55
 - HP Connection Manager 15
 - MediaSmart 33
 - using 33
 - Wireless Assistant 15
 - solid-state drive (SSD) 54, 80
 - speakers, identifying 5
 - storing battery 49
 - supported discs 77
 - switch, power 6
 - System Configuration menu 73
 - system failure or instability 77
 - system information
 - displaying 72
 - hotkey 28
 - Setup Utility 72
 - system restore points 79

T

- temperature 49
- TouchPad
 - buttons 2
 - identifying 2
 - scrolling regions 3
 - using 24
- TouchPad gestures
 - pinching 25
 - rotating 25
 - scrolling 24
 - zooming 25
- TouchPad light, identifying 2
- TouchPad on/off button 3
- traveling with the
 - computer 12, 49
- turning off the computer 49

U

- unresponsive system 49
- USB cable, connecting 61
- USB devices
 - connecting 61
 - description 61
 - removing 61
 - stopping 61
- USB hubs 61
- USB ports, identifying 6, 7, 61

V

- vents, identifying 6, 8
- Virtualization Technology 73
- volume
 - adjusting 31
 - keys 31
 - mute 31
- volume keys, identifying 27
- volume mute key 31
- volume mute key, identifying 27

W

- webcam
 - adjusting properties 37
 - identifying 9
 - tips 37
- webcam light, identifying 9
- Windows applications key,
 - identifying 4
- Windows logo key, identifying 4
- Windows, passwords set in 65
- wireless antennas 10

- Wireless Assistant
 - software 14, 15
- wireless button 14
- wireless button, identifying 6
- wireless certification label 12
- wireless controls
 - button 14
 - HP Connection Manager 14
 - operating system 14
 - Wireless Assistant
 - software 14
- wireless icon 13
- wireless light, identifying 6, 14
- wireless network (WLAN)
 - equipment needed 16
 - security 16
- WLAN antennas, identifying 10
- WLAN device 12, 13
- WLAN label 12
- writable media 38
- WWAN antennas, identifying 10
- WWAN device 17

Z

- zooming TouchPad gesture 25

