

# Notebook PC

## User Guide

© Copyright 2010 Hewlett-Packard  
Development Company, L.P.

Bluetooth is a trademark owned by its proprietor and used by Hewlett-Packard Company under license. Intel is a trademark of Intel Corporation in the U.S. and other countries or regions. Java is a U.S. trademark of Sun Microsystems, Inc. Microsoft and Windows are U.S. registered trademarks of Microsoft Corporation. SD Logo is a trademark of its proprietor.

The information contained herein is subject to change without notice. The only warranties for HP products and services are set forth in the express warranty statements accompanying such products and services. Nothing herein should be construed as constituting an additional warranty. HP shall not be liable for technical or editorial errors or omissions contained herein.

Second Edition: October 2010

First Edition: March 2010

Document Part Number: 601865-002

#### **Product notice**

This user guide describes features that are common to most models. Some features may not be available on your computer.

## Safety warning notice

- 
- △ **WARNING!** To reduce the possibility of heat-related injuries or of overheating the computer, do not place the computer directly on your lap or obstruct the computer air vents. Use the computer only on a hard, flat surface. Do not allow another hard surface, such as an adjoining optional printer, or a soft surface, such as pillows or rugs or clothing, to block airflow. Also, do not allow the AC adapter to contact the skin or a soft surface, such as pillows or rugs or clothing, during operation. The computer and the AC adapter comply with the user-accessible surface temperature limits defined by the International Standard for Safety of Information Technology Equipment (IEC 60950).
-



---

# Table of contents

<b>1 Features</b> .....	<b>1</b>
Identifying hardware .....	1
Top components .....	1
TouchPad .....	1
Lights .....	3
Buttons, switch, and speaker .....	4
Keys .....	6
Front components .....	7
Right-side components .....	8
Left-side components .....	9
Bottom components .....	9
Multimedia components .....	11
Wireless antennas (select models only) .....	12
Additional hardware components .....	13
Identifying the labels .....	13
<b>2 Networking</b> .....	<b>15</b>
Using wireless devices (select models only) .....	15
Identifying wireless and network icons .....	15
Using the wireless controls .....	16
Using the wireless key .....	16
Using Wireless Assistant software (select models only) .....	17
Using operating system controls .....	17
Using a WLAN .....	18
Setting up a WLAN .....	18
Protecting your WLAN .....	18
Connecting to a WLAN .....	19
Roaming to another network .....	20
Using Bluetooth wireless devices (select models only) .....	21
Bluetooth and Internet Connection Sharing (ICS) .....	21
Troubleshooting wireless connection problems .....	22
Cannot create a WLAN connection .....	22

Cannot connect to a preferred network .....	23
Network icon is not displayed .....	23
Current network security codes are unavailable .....	23
WLAN connection is very weak .....	24
Cannot connect to the wireless router .....	24
Using the modem (select models only) .....	25
Connecting a modem cable (purchased separately) .....	25
Connecting a country-specific modem cable adapter (purchased separately) .....	26
Selecting a location setting .....	26
Viewing the current location selection .....	26
Adding new locations when traveling .....	27
Solving travel connection problems .....	28
Connecting to a local area network (LAN) .....	30
<b>3 Pointing devices and keyboard .....</b>	<b>31</b>
Using pointing devices .....	31
Setting pointing device preferences .....	31
Using the TouchPad .....	31
Connecting an external mouse .....	31
Using the keyboard .....	31
Using hotkeys .....	31
Displaying system information .....	33
Opening Help and Support .....	34
Decreasing screen brightness .....	34
Increasing screen brightness .....	34
Switching the screen image .....	34
Initiating Sleep (fn+f5) .....	35
Initiating QuickLock (fn+f6) (select models) .....	35
Launching Web browser (fn+f7) (select models) .....	35
Launching printer (fn+f8) (select models) .....	35
Muting speaker sound (fn+f7) (select models) .....	35
Decreasing speaker sound (fn+f8) (select models) .....	35
Increasing speaker sound (fn+f9) (select models) .....	36
Playing the previous track or section of an audio CD or a DVD (fn+f10) (select models) .....	36
Playing, pausing, or resuming an audio CD or a DVD (fn+f11) (select models) .....	36
Playing the next track or section of an audio CD or a DVD (fn+f12) (select models) .....	36
Using the embedded numeric keypad .....	37
Enabling and disabling the embedded numeric keypad .....	37

Switching key functions on the embedded numeric keypad .....	37
Using an optional external numeric keypad .....	38
<b>4 Multimedia .....</b>	<b>39</b>
Multimedia features .....	39
Identifying your multimedia components .....	39
Adjusting the volume .....	41
Multimedia software .....	42
Accessing your preinstalled multimedia software .....	42
Using multimedia software .....	42
Installing multimedia software from a disc .....	43
Audio .....	44
Connecting external audio devices .....	44
Checking your audio functions .....	44
Video .....	46
Connecting an external monitor or projector .....	46
Using the external monitor port .....	46
Using the HDMI port .....	46
Configuring audio for HDMI .....	47
Optical drive (select models only) .....	48
Identifying the installed optical drive .....	48
Using optical discs (CDs, DVDs, and BDs) .....	48
Selecting the right disc (CDs, DVDs, and BDs) .....	48
CD-R discs .....	49
CD-RW discs .....	49
DVD±R discs .....	49
DVD±RW discs .....	49
LightScribe DVD+R discs .....	49
Blu-ray Discs (BDs) .....	49
Playing a CD, DVD, or BD .....	50
Configuring AutoPlay .....	51
Changing DVD region settings .....	51
Observing the copyright warning .....	51
Copying a CD or DVD .....	52
Creating (burning) a CD or DVD .....	52
Removing an optical disc (CD, DVD, or BD) .....	53
Troubleshooting .....	53
The optical disc tray does not open for removal of a CD, DVD, or BD .....	53
The computer does not detect the optical drive .....	54
Preventing playback disruptions .....	55
A disc does not play .....	55

A disc does not play automatically .....	56
A movie stops, skips, or plays erratically .....	56
A movie is not visible on an external display .....	56
The process of burning a disc does not begin, or it stops before completion ...	57
A device driver must be reinstalled .....	57
Obtaining the latest HP device drivers .....	57
Obtaining Microsoft device drivers .....	58
Webcam .....	59
Webcam tips .....	59
Adjusting webcam properties .....	59
<b>5 Power management .....</b>	<b>61</b>
Setting power options .....	61
Using power-saving states .....	61
Initiating and exiting Sleep .....	61
Initiating and exiting Hibernation .....	62
Using the battery meter .....	62
Using power plans .....	62
Viewing the current power plan .....	62
Selecting a different power plan .....	63
Customizing power plans .....	63
Setting password protection on wakeup .....	63
Using external AC power .....	64
Connecting the AC adapter .....	64
Using battery power .....	65
Using Battery Check .....	65
Displaying the remaining battery charge .....	66
Inserting or removing the battery .....	66
Charging a battery .....	67
Maximizing battery discharge time .....	68
Managing low battery levels .....	68
Identifying low battery levels .....	68
Resolving a low battery level .....	68
Resolving a low battery level when external power is available .....	69
Resolving a low battery level when a charged battery is available .....	69
Resolving a low battery level when no power source is available ....	69
Resolving a low battery level when the computer cannot exit Hibernation .....	69
Calibrating a battery .....	69
Step 1: Fully charge the battery .....	69



Step 2: Disable Hibernation and Sleep .....	70
Step 3: Discharge the battery .....	70
Step 4: Fully recharge the battery .....	71
Step 5: Reenable Hibernation and Sleep .....	71
Conserving battery power .....	71
Storing a battery .....	72
Disposing of a used battery .....	72
Replacing the battery .....	72
Testing an AC adapter .....	73
Shutting down the computer .....	73
<b>6 Drives .....</b>	<b>75</b>
Identifying installed drives .....	75
Handling drives .....	75
Improving hard drive performance .....	77
Using Disk Defragmenter .....	77
Using Disk Cleanup .....	77
Using external drives .....	78
Using optional external devices .....	78
Replacing the hard drive .....	79
<b>7 External devices .....</b>	<b>83</b>
Using a USB device .....	83
Connecting a USB device .....	83
Removing a USB device .....	83
Using USB legacy support .....	84
Using external drives .....	85
Using optional external devices .....	85
<b>8 External media cards .....</b>	<b>86</b>
Using Media Card Reader cards .....	86
Inserting a digital card .....	86
Removing a digital card .....	87
Using ExpressCards (select models only) .....	88
Configuring an ExpressCard .....	88
Inserting an ExpressCard .....	88
Removing an ExpressCard .....	89
<b>9 Memory modules .....</b>	<b>91</b>
Adding or replacing a memory module in the expansion memory module slot .....	92

Upgrading a memory module in the primary memory module slot .....	96
<b>10 Security .....</b>	<b>100</b>
Protecting the computer .....	100
Using passwords .....	101
Setting passwords in Windows .....	101
Setting passwords in Computer Setup .....	101
BIOS administrator password .....	102
Managing a BIOS administrator password .....	102
Entering a BIOS administrator password .....	103
Using Computer Setup DriveLock .....	103
Setting a DriveLock password .....	104
Entering a DriveLock password .....	104
Changing a DriveLock password .....	104
Removing DriveLock protection .....	105
Using Computer Setup Auto DriveLock .....	105
Entering an Automatic DriveLock password .....	106
Removing Automatic DriveLock protection .....	106
Using Computer Setup security features .....	107
Securing system devices .....	107
Viewing Computer Setup System Information .....	107
Using Computer Setup System IDs .....	108
Using antivirus software .....	109
Using firewall software .....	109
Installing critical updates .....	110
Using HP ProtectTools Security Manager (select models only) .....	111
Installing a security cable .....	111
<b>11 Software updates .....</b>	<b>112</b>
Updating software .....	112
Updating the BIOS .....	114
Determining the BIOS version .....	114
Downloading a BIOS update .....	115
Updating programs and drivers .....	116
Using SoftPaq Download Manager .....	117
<b>12 Backup and recovery .....</b>	<b>118</b>
Backing up your information .....	119
Performing a recovery .....	121
Using the Windows recovery tools .....	121

Using f11 .....	122
Using a Windows 7 operating system DVD (purchased separately) .....	122
<b>13 Computer Setup .....</b>	<b>124</b>
Starting Computer Setup .....	124
Using Computer Setup .....	124
Navigating and selecting in Computer Setup .....	124
Restoring factory settings in Computer Setup .....	125
Computer Setup menus .....	125
File menu .....	126
Security menu .....	126
System Configuration menu .....	127
<b>14 MultiBoot .....</b>	<b>132</b>
About the boot device order .....	132
Enabling boot devices in Computer Setup .....	134
Considering boot order changes .....	135
Choosing MultiBoot preferences .....	136
Setting a new boot order in Computer Setup .....	136
Dynamically choosing a boot device using the F9 prompt .....	136
Setting a MultiBoot Express prompt .....	137
Entering MultiBoot Express preferences .....	137
<b>15 Management and printing .....</b>	<b>138</b>
Using Client Management Solutions .....	138
Configuring and deploying a software image .....	138
Managing and updating software .....	139
HP Client Manager for Altiris (select models only) .....	139
HP Client Configuration Manager (CCM) (select models only) .....	140
HP System Software Manager (SSM) .....	140
<b>16 Cleaning guidelines .....</b>	<b>142</b>
Cleaning products .....	142
Cleaning procedures .....	143
Cleaning the display .....	143
Cleaning the sides and cover .....	143
Cleaning the TouchPad and keyboard .....	143
Cleaning a tablet PC pen and pen holder .....	143
<b>Index .....</b>	<b>144</b>



---

# 1 Features

## Identifying hardware

To see a list of hardware installed in the computer:

- ▲ Select **Start > Control Panel > System and Security**. Then in the **System** area, click **Device Manager**.

You can also add hardware or modify device configurations using Device Manager.

---

 **NOTE:** Windows® includes the User Account Control feature to improve the security of your computer. You may be prompted for your permission or password for tasks such as installing software, running utilities, or changing Windows settings. Refer to Windows Help and Support for more information.

---

## Top components

### TouchPad



---

Component	Description
(1) TouchPad*	Moves the pointer and selects or activates items on the screen.
(2) TouchPad button*	The left and right sides of the single button function like the left and right buttons on an external mouse.

---

---

<b>Component</b>	<b>Description</b>
<b>(3)</b> TouchPad scroll zone	Scrolls up or down.

---

\*This table describes factory settings. To view or change pointing device preferences, select **Start > Devices and Printers**. Then, right-click the device representing your computer, and select **Mouse settings**.

---

## Lights

 **NOTE:** Refer to the illustration that most closely matches your computer.

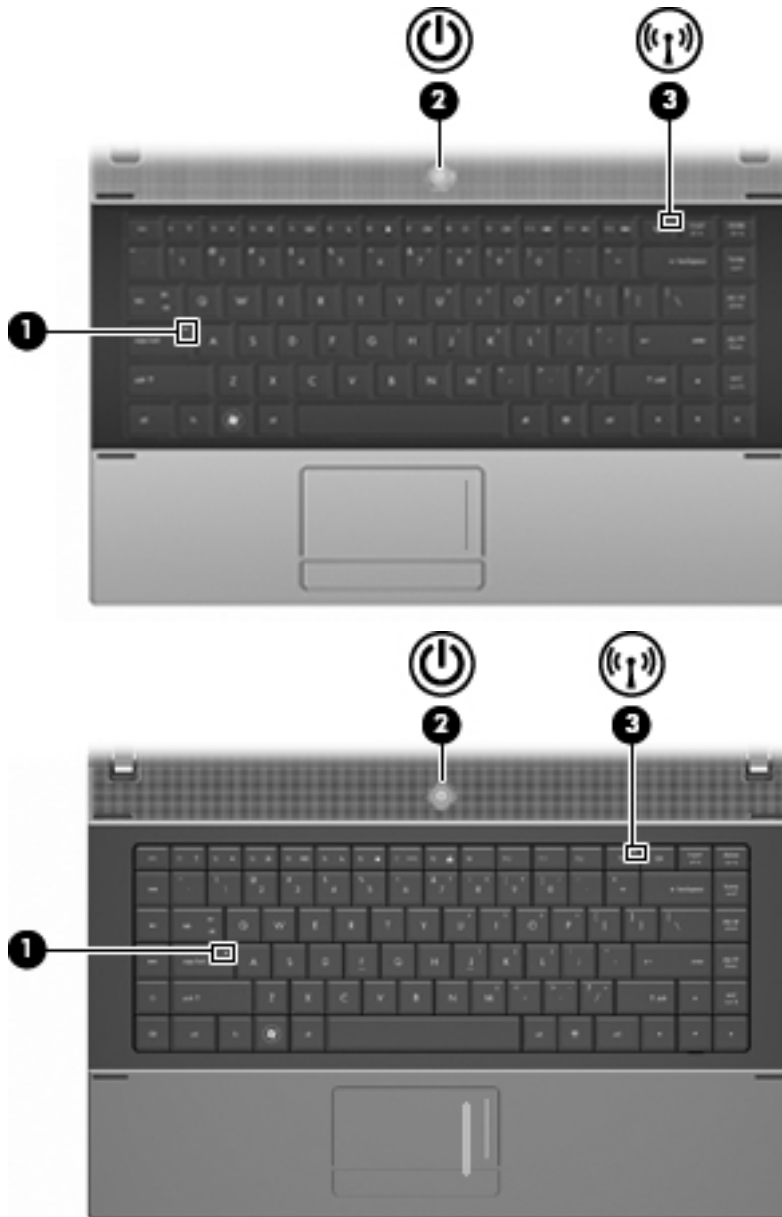

Component	Description
(1) Caps lock light	On: Caps lock is on.

Component	Description
(2) Power light	<ul style="list-style-type: none"> <li>On: The computer is on.</li> <li>Blinking: The computer is in the Sleep state.</li> <li>Off: The computer is off or in Hibernation.</li> </ul>
(3) Wireless light	<ul style="list-style-type: none"> <li>White: An integrated wireless device, such as a wireless local area network (WLAN) device and/or a Bluetooth® device, is on.</li> <li>Amber: All wireless devices are off.</li> </ul>

## Buttons, switch, and speaker



Component	Description
(1) Speaker	Produces sound.



---

Component	Description
(2) Internal display switch	Turns off the display if the panel lid is closed while the power is on.
(3) Power button	<ul style="list-style-type: none"><li data-bbox="839 300 1430 352">• When the computer is off, press the button to turn on the computer.</li><li data-bbox="839 378 1461 430">• When the computer is on, press the button to shut down the computer.</li><li data-bbox="839 455 1437 508">• When the computer is in the Sleep state, press the button briefly to exit Sleep.</li><li data-bbox="839 533 1406 585">• When the computer is in Hibernation, press the button briefly to exit Hibernation.</li></ul> <p data-bbox="839 611 1461 684">If the computer has stopped responding and Windows shutdown procedures are ineffective, press and hold the power button for at least 5 seconds to turn off the computer.</p> <p data-bbox="839 709 1461 758">To learn more about your power settings, select <b>Start &gt; Control Panel &gt; System and Security &gt; Power Options</b>.</p>

---

## Keys

 **NOTE:** Refer to the illustration and table that most closely matches your computer.

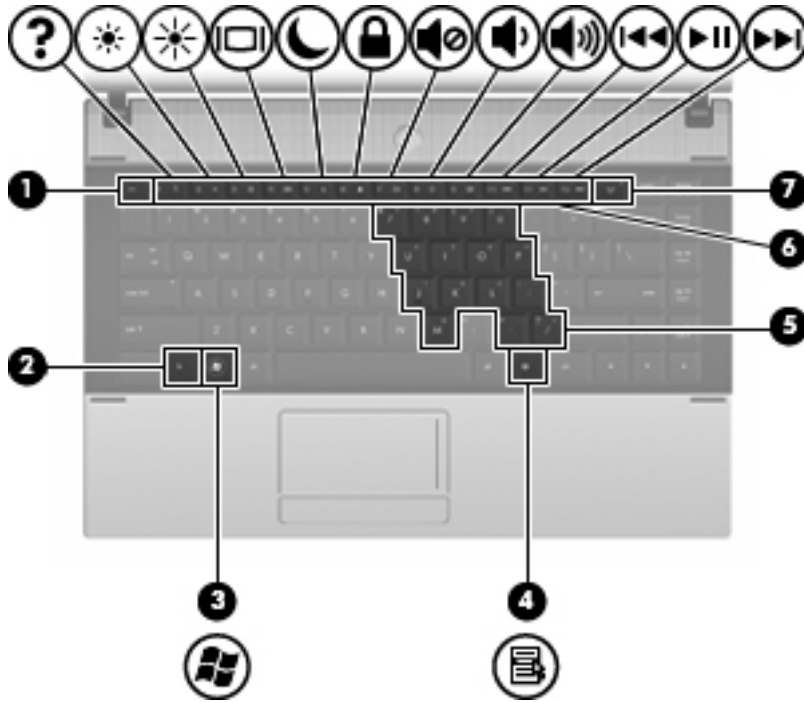

Component	Description
(1) <a href="#">esc</a> key	Displays system information when pressed in combination with the <a href="#">fn</a> key.
(2) <a href="#">fn</a> key	Executes frequently used system functions when pressed in combination with a function key or the <a href="#">esc</a> key.
(3) Windows logo key	Displays the Windows Start menu.
(4) Windows applications key	Displays a shortcut menu for items beneath the cursor.
(5) Embedded numeric keypad keys	Can be used like the keys on an external numeric keypad when pressed in combination with the <a href="#">fn</a> and <a href="#">num lk</a> keys.
(6) Function keys	Execute frequently used system functions when pressed in combination with the <a href="#">fn</a> key.
(7) Wireless key	Because the wireless devices are enabled at the factory, use the wireless key to turn on or turn off the wireless devices simultaneously.

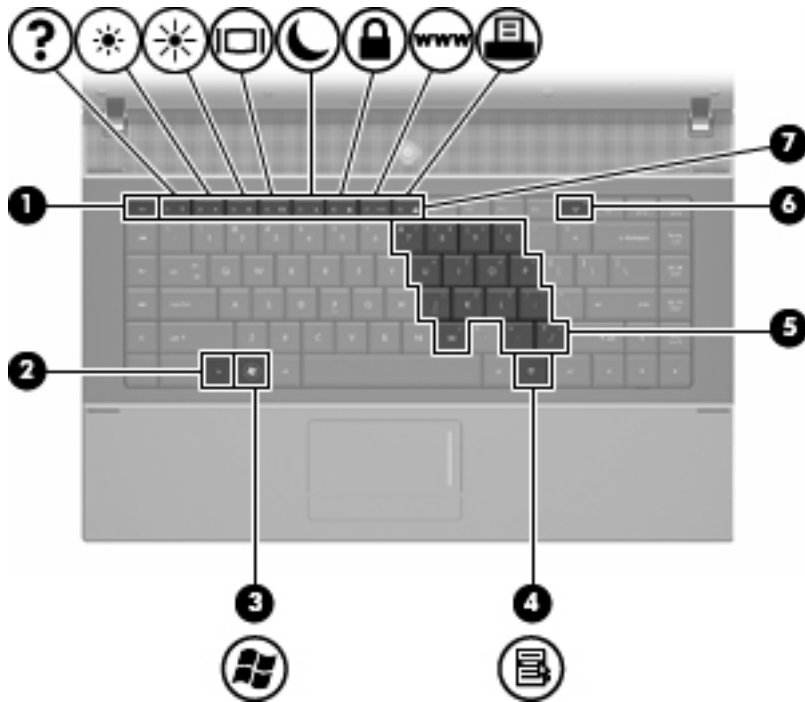

Component	Description
(1) <code>esc</code> key	Displays system information when pressed in combination with the <code>fn</code> key.
(2) <code>fn</code> key	Executes frequently used system functions when pressed in combination with a function key or the <code>esc</code> key.
(3) Windows logo key	Displays the Windows Start menu.
(4) Windows applications key	Displays a shortcut menu for items beneath the cursor.
(5) Embedded numeric keypad keys	Can be used like the keys on an external numeric keypad when pressed in combination with the <code>fn</code> and <code>num lk</code> keys.
(6) Wireless key	Because the wireless devices are enabled at the factory, use the wireless key to turn on or turn off the wireless devices simultaneously.
(7) Function keys	Execute frequently used system functions when pressed in combination with the <code>fn</code> key.

## Front components

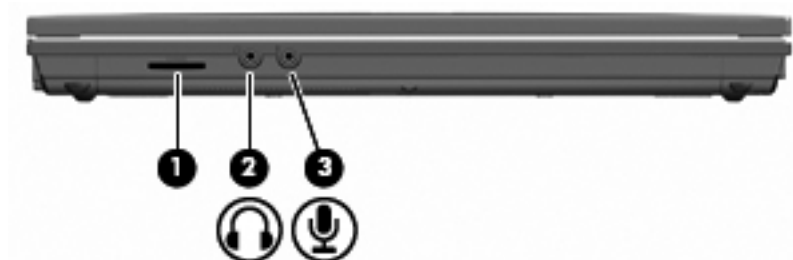

Component	Description
(1) SD Card Reader	Supports the following optional digital card formats: <ul style="list-style-type: none"> <li>MultiMediaCard (MMC)</li> <li>MultiMediaCard 4.2 (MMC Plus, including MMC Plus HC)</li> <li>Secure Digital (SD) Memory Card</li> <li>Secure Digital High Capacity (SDHC) Memory Card</li> <li>Secure Digital High Speed (SDHS) Memory Card</li> </ul>
(2) Audio-out (headphone) jack	Produces sound when connected to optional powered stereo speakers, headphones, ear buds, a headset, or television audio. <b>NOTE:</b> When a device is connected to the headphone jack, the computer speakers are disabled.
(3) Audio-in (microphone) jack	Connects an optional computer headset microphone, stereo array microphone, or monaural microphone.

## Right-side components

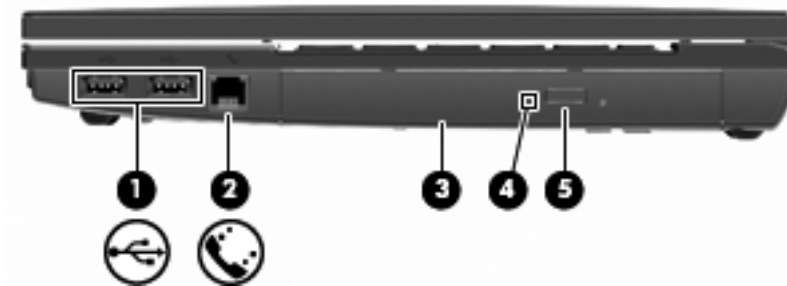

Component	Description
(1) USB ports (2)	Connect optional USB devices.
(2) RJ-11 (modem) jack (select models only)	Connects a modem cable.
(3) Optical drive (select models only)	Reads optical discs and, on select models, also writes to optical discs.
(4) Optical drive light (select models only)	Blinking: The optical drive is being accessed.
(5) Optical drive button (select models only)	Opens optical drive tray.

## Left-side components

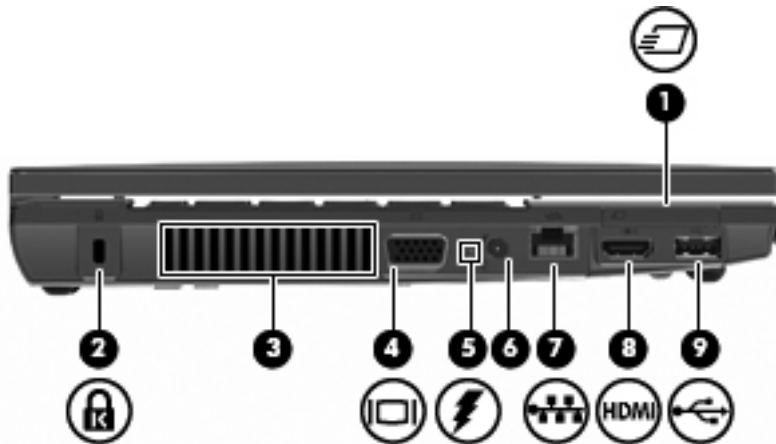

Component	Description
(1) ExpressCard slot	Supports optional ExpressCards.
(2) Security cable slot	Attaches an optional security cable to the computer. <b>NOTE:</b> The security cable is designed to act as a deterrent, but it may not prevent the computer from being mishandled or stolen.
(3) Vent	Enables airflow to cool internal components. <b>NOTE:</b> The computer fan starts up automatically to cool internal components and prevent overheating. It is normal for the internal fan to cycle on and off during routine operation.
(4) External monitor port	Connects an external VGA monitor or projector.
(5) Battery light	<ul style="list-style-type: none"> <li>Amber: A battery is charging.</li> <li>Turquoise: A battery is close to full charge capacity.</li> <li>Blinking amber: A battery that is the only available power source has reached a low battery level. When the battery reaches a critical battery level, the battery light begins blinking rapidly.</li> <li>Off: If the computer is plugged into an external power source, the light turns off when all batteries in the computer are fully charged. If the computer is not plugged into an external power source the light stays off until the battery reaches a low battery level.</li> </ul>
(6) Power connector	Connects an AC adapter.
(7) RJ-45 (network) jack	Connects a network cable.
(8) HDMI port	Connects an optional HDMI device.
(9) USB port (1)	Connect optional USB devices.

## Bottom components

 **NOTE:** Refer to the illustration that most closely matches your computer.

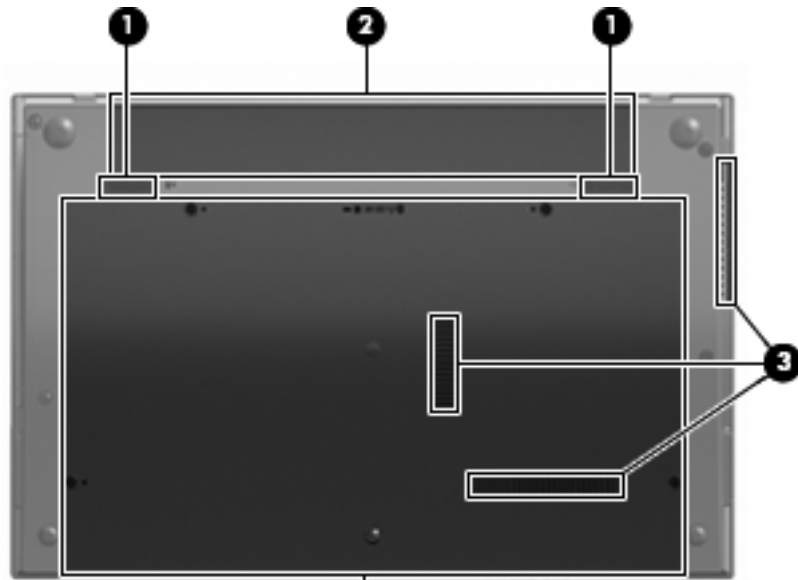
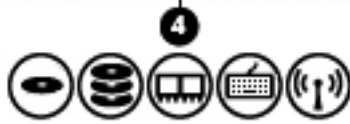
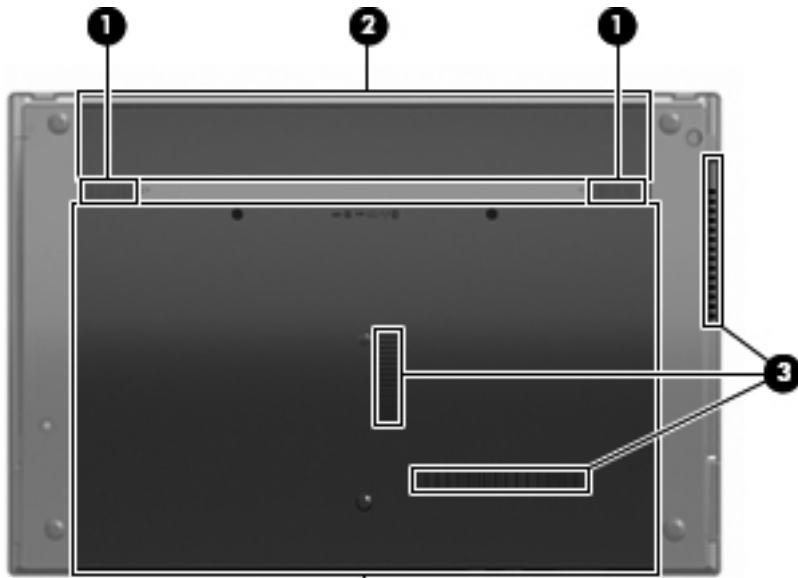

Component	Description
(1) Battery release latches (2)	Release the battery from the battery bay.
(2) Battery bay	Holds the battery.

Component	Description
(3) Vents (3)	Enable airflow to cool internal components.  <b>NOTE:</b> The computer fan starts up automatically to cool internal components and prevent overheating. It is normal for the internal fan to cycle on and off during routine operation.
(4) Memory module compartment	Contains the memory module slots.
WLAN module compartment	Contains the wireless LAN module slot.  <b>CAUTION:</b> To prevent an unresponsive system and the display of a warning message, replace the WLAN module with only a module authorized for use in the computer by the governmental agency that regulates wireless devices in your country. If you replace the module and then receive a warning message, remove the module to restore computer functionality, and then contact technical support through Help and Support.
Hard drive bay	Holds the hard drive and a Bluetooth device.

## Multimedia components



Component	Description
(1) Webcam light (select models only)	On: The webcam is in use.
(2) Webcam (select models only)	Records video and captures still photographs.

Component	Description
(3) Integrated microphone	Records sound.
(4) Audio-out (headphone) jack	Produces sound when connected to optional powered stereo speakers, headphones, ear buds, a headset, or television audio.  <b>NOTE:</b> When a device is connected to the headphone jack, the computer speakers are disabled.
(5) Audio-in (microphone) jack	Connects an optional computer headset microphone, stereo array microphone, or monaural microphone.
(6) Speaker	Produces sound.

## Wireless antennas (select models only)

On select computer models, at least 2 antennas send and receive signals from one or more wireless devices. These antennas are not visible from the outside of the computer.

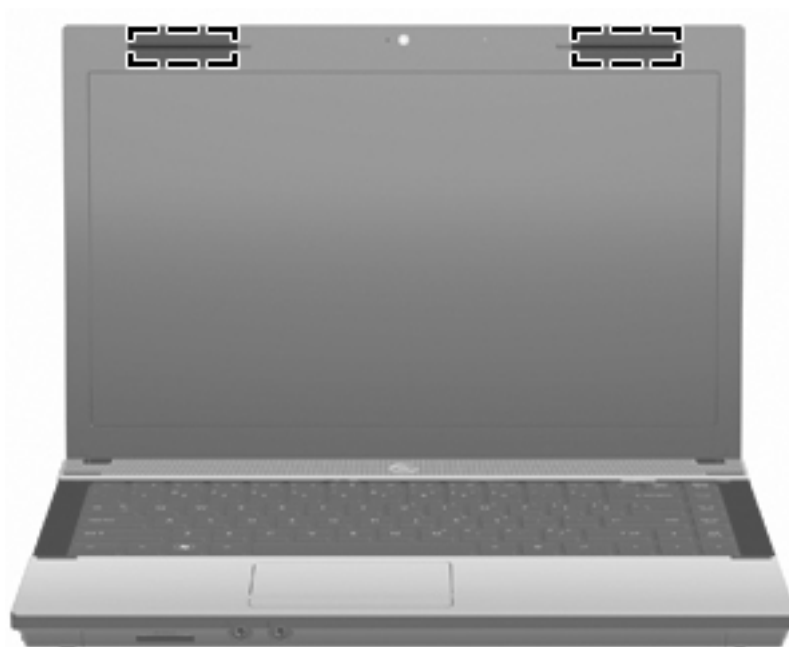

**NOTE:** For optimal transmission, keep the areas immediately around the antennas free from obstructions.

To see wireless regulatory notices, refer to the section of the *Regulatory, Safety and Environmental Notices* that applies to your country or region. These notices are located in Help and Support.



## Additional hardware components



Component	Description
(1) Power cord*	Connects an AC adapter to an AC outlet.
(2) AC adapter	Converts AC power to DC power.
(3) Battery*	Powers the computer when the computer is not plugged into external power.

\*Modem cables, batteries, modem cable adapters, and power cords vary in appearance by country or region.

## Identifying the labels

The labels affixed to the computer provide information you may need when you troubleshoot system problems or travel internationally with the computer:

- Service tag—Provides important information, including the following:



- Product name (1). This is the product name affixed to the front of your notebook.
- Serial number (s/n) (2). This is an alphanumeric identifier that is unique to each product.
- Part number/Product number (p/n) (3). This number provides specific information about the product's hardware components. The part number helps a service technician to determine what components and parts are needed.

- Model description **(4)**. This is the number you use to locate documents, drivers, and support for your notebook.
- Warranty period **(5)**. Describes the duration of the warranty period for this computer.

Have this information available when you contact technical support. The service tag label is affixed to the bottom of the computer.

- Microsoft® Certificate of Authenticity—Contains the Windows Product Key. You may need the Product Key to update or troubleshoot the operating system. This certificate is affixed to the bottom of the computer.
- Regulatory label—Provides regulatory information about the computer. The regulatory label is affixed to the bottom of the computer.
- Modem approval label—Provides regulatory information about the modem and lists the agency approval markings required by some of the countries in which the modem has been approved for use. You may need this information when traveling internationally. The modem approval label is affixed to the bottom of the computer.
- Wireless certification label(s) (select models only)—Provide information about optional wireless devices and the approval markings of some of the countries in which the devices have been approved for use. An optional device may be a WLAN device or a Bluetooth device. If your computer model includes one or more wireless devices, one or more certification labels are included with your computer. You may need this information when traveling internationally. Wireless certification labels are affixed to the bottom of the computer.

---

## 2 Networking

### Using wireless devices (select models only)

Wireless technology transfers data across radio waves instead of wires. Your computer may be equipped with one or more of the following wireless devices:

- **WLAN device**—Connects the computer to wireless local area networks (commonly referred to as Wi-Fi networks, wireless LANs, or WLANs) in corporate offices, your home, and public places such as airports, restaurants, coffee shops, hotels, and universities. In a WLAN, each mobile wireless device communicates with a wireless router or a wireless access point.
- **Bluetooth device**—Creates a personal area network (PAN) to connect to other Bluetooth-enabled devices such as computers, phones, printers, headsets, speakers, and cameras. In a PAN, each device communicates directly with other devices, and devices must be relatively close together—typically within 10 meters (approximately 33 feet) of each other.

Computers with WLAN devices support one or more of the following IEEE industry standards:

- 802.11b, the first popular standard, supports data rates of up to 11 Mbps and operates at a frequency of 2.4 GHz.
- 802.11g supports data rates of up to 54 Mbps and operates at a frequency of 2.4 GHz. An 802.11g WLAN device is backward compatible with 802.11b devices, so they can operate on the same network.
- 802.11a supports data rates of up to 54 Mbps and operates at a frequency of 5 GHz.

---

 **NOTE:** 802.11a is not compatible with 802.11b and 802.11g.

---

- 802.11n supports data rates of up to 450 Mbps and may operate at 2.4 GHz or 5 GHz, making it backward compatible with 802.11a, b, and g.

---

 **NOTE:** The specifications for the 802.11n WLAN are draft specifications and are not final. If the final specifications differ from the draft specifications, it may affect the ability of the computer to communicate with other 802.11n WLAN devices.

---







For more information on wireless technology, refer to the information and Web site links provided in Help and Support.

### Identifying wireless and network icons

---

Icon	Name	Description
------	------	-------------

---

	Wireless (connected)	Identifies the location of the wireless lights and the wireless buttons on the computer. Also identifies the Wireless Assistant software on the computer and indicates that one or more of the wireless devices are on.
	Wireless (disconnected)	Identifies the Wireless Assistant software on the computer and indicates that all of the wireless devices are off.
	Wired network (connected)	Indicates that one or more of your network drivers are installed and one or more network devices are connected to the network.
	Wired network (disabled/disconnected)	Indicates that one or more of your network drivers are installed, all network devices or all wireless devices are disabled in Windows Control Panel, and no network devices are connected to a wired network.
	Network (connected)	Indicates that one or more of your network drivers are installed, one or more network devices are connected to a wireless network, and one or more network devices may be connected to a wired network.
	Network (disconnected)	Indicates that one or more of your network drivers are installed and wireless connections are available, but no network devices are connected to a wired or wireless network.
	Network (disabled/disconnected)	Indicates that one or more of your network drivers are installed, no wireless connections are available or all wireless network devices are disabled by the wireless button or Wireless Assistant, and no network devices are connected to a wired network.

## Using the wireless controls

You can control the wireless devices in your computer using these features:

- Wireless key or wireless button (referred to in this guide as the wireless key)
- Wireless Assistant software (select models only)
- Operating system controls

## Using the wireless key

The computer has a wireless key, one or more wireless devices, and one wireless light. All of the wireless devices on your computer are enabled at the factory, so the wireless light is on (white) when you turn on the computer.

The wireless light indicates the overall power state of your wireless devices, not the status of individual devices. If the wireless light is white, at least one wireless device is on. If the wireless light is amber, all wireless devices are off.

Because the wireless devices are enabled at the factory, you can use the wireless key to turn on or turn off the wireless devices simultaneously. Individual wireless devices can be controlled through Wireless Assistant software (select models only) or through Computer Setup.

 **NOTE:** If the wireless devices are disabled by Computer Setup, the wireless key will not work until you reenables your devices.

## Using Wireless Assistant software (select models only)

A wireless device can be turned on or off using the Wireless Assistant software. If a wireless device is disabled by Computer Setup, it must be reenabled by Computer Setup before it can be turned on or off using Wireless Assistant.

 **NOTE:** Enabling or turning on a wireless device does not automatically connect the computer to a network or a Bluetooth-enabled device.

---

To view the state of the wireless devices, click the **Show hidden icons** icon, the arrow at the left of the notification area, and position the cursor over the wireless icon.

If the wireless icon is not displayed in the notification area, complete the following steps to change the Wireless Assistant properties:

1. Select **Start > Control Panel > Hardware and Sound > Windows Mobility Center**.
2. Click the wireless icon in the Wireless Assistant tile, which is located in the bottom row of Windows Mobility Center.
3. Click **Properties**.
4. Select the check box next to **HP Wireless Assistant icon in notification area**.
5. Click **Apply**.
6. Click **Close**.

For more information, refer to the Wireless Assistant software Help:

1. Open Wireless Assistant by clicking the wireless icon in Windows Mobility Center.
2. Click the **Help** button.

## Using operating system controls

Some operating systems also offer a way to manage integrated wireless devices and the wireless connection. For example, Windows provides the Network and Sharing Center that allows you to set up a connection or network, connect to a network, manage wireless networks, and diagnose and repair network problems.

To access the Network and Sharing Center, select **Start > Control Panel > Network and Internet > Network and Sharing Center**.

For more information, refer to Help and Support.

## Using a WLAN

With a WLAN device, you can access a WLAN, which is composed of other computers and accessories that are linked by a wireless router or a wireless access point.

 **NOTE:** The terms *wireless router* and *wireless access point* are often used interchangeably.

- A large-scale WLAN, such as a corporate or public WLAN, typically uses wireless access points that can accommodate a large number of computers and accessories and can separate critical network functions.
- A home or small office WLAN typically uses a wireless router, which allows several wireless and wired computers to share an Internet connection, a printer, and files without requiring additional pieces of hardware or software.

To use the WLAN device in your computer, you must connect to a WLAN infrastructure (provided through a service provider or a public or corporate network).

## Setting up a WLAN

To set up a WLAN and connect to the Internet, you need the following equipment:

- A broadband modem (either DSL or cable) **(1)** and high-speed Internet service purchased from an Internet service provider (ISP)
- A wireless router (purchased separately) **(2)**
- The wireless computer **(3)**

The illustration below shows an example of a wireless network installation that is connected to the Internet.

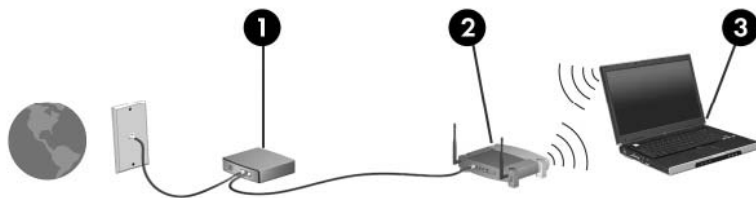

As your network grows, additional wireless and wired computers can be connected to the network to access the Internet.

For help in setting up your WLAN, refer to the information provided by your router manufacturer or your ISP.

## Protecting your WLAN

Because the WLAN standard was designed with only limited security capabilities—basically to foil casual eavesdropping rather than more powerful forms of attack—it is essential to understand that WLANs are vulnerable to well-known and well-documented security weaknesses.

WLANs in public areas, or “hotspots,” like coffee shops and airports, may not provide any security. New technologies are being developed by wireless manufacturers and hotspot service providers that make the public environment more secure and anonymous. If you are concerned about the security of your computer in a hotspot, limit your network activities to noncritical e-mail and basic Internet surfing.

When you set up a WLAN or access an existing WLAN, always enable security features to protect your network from unauthorized access. The common security levels are Wi-Fi Protected Access (WPA) and Wired Equivalent Privacy (WEP). Because wireless radio signals travel outside the network, other WLAN devices can pick up unprotected signals and either connect to your network (uninvited) or capture information being sent across it. However, you can take precautions to protect your WLAN:

- **Use a wireless transmitter with built-in security**

Many wireless base stations, gateways, and routers provide built-in security features such as wireless security protocols and firewalls. With the correct wireless transmitter, you can protect your network from the most common wireless security risks.

- **Work behind a firewall**

A firewall is a barrier that checks both data and requests for data that are sent to your network and then discards any suspicious items. Firewalls are available in many varieties, both software and hardware. Some networks use a combination of both types.

- **Use wireless encryption**

A variety of sophisticated encryption protocols is available for your WLAN. Find the solution that works best for your network security:

- **Wired Equivalent Privacy (WEP)** is a wireless security protocol that uses a WEP key to encode or encrypt all network data before it is transmitted. Usually, you can allow the network to assign the WEP key. Alternatively, you can set up your own key, generate a different key, or choose other advanced options. Without the correct key, others will not be able to use the WLAN.
- **WPA (Wi-Fi Protected Access)**, like WEP, uses security settings to encrypt and decrypt data that is transmitted over the network. However, instead of using one static security key for encryptions as WEP does, WPA uses *temporal key integrity protocol* (TKIP) to dynamically generate a new key for every packet. It also generates different sets of keys for each computer on the network.

## Connecting to a WLAN

To connect to the WLAN, follow these steps:

1. Be sure that the WLAN device is on. If it is on, the wireless light is on (white). If the wireless light is amber, press the wireless button.
2. Click the network icon in the notification area, at the far right of the taskbar.
3. Select your WLAN from the list.
4. Click **Connect**.

If the network is a security-enabled WLAN, you are prompted to enter a network security key, which is a security code. Type the code, and then click **OK** to complete the connection.

---

 **NOTE:** If no WLANs are listed, you are out of range of a wireless router or access point.

**NOTE:** If you do not see the network you want to connect to, click **Open Network and Sharing Center**, and then click **Set up a new connection or network**. A list of options is displayed. You can choose to manually search for and connect to a network or to set up a new network connection.

---

After the connection is made, place the mouse pointer over the network icon in the notification area, at the far right of the taskbar, to verify the name and status of the connection.

---

 **NOTE:** The functional range (how far your wireless signals travel) depends on WLAN implementation, router manufacturer, and interference from other electronic devices or structural barriers such as walls and floors.

---

More information about using a WLAN is available through the following resources:

- Information from your ISP and the manufacturer's instructions included with your wireless router and other WLAN equipment
- Information and Web site links provided in Help and Support

For a list of public WLANs near you, contact your ISP or search the Web. Web sites that list public WLANs include Cisco Internet Mobile Office Wireless Locations, Hotspotlist, and Geektools. Check with each public WLAN location for cost and connection requirements.

For additional information on connecting your computer to a corporate WLAN, contact your network administrator or IT department.

## Roaming to another network

When you move your computer within range of another WLAN, Windows attempts to connect to that network. If the attempt is successful, your computer is automatically connected to the new network. If Windows does not recognize the new network, follow the same procedure you used initially to connect to your WLAN.



## Using Bluetooth wireless devices (select models only)

A Bluetooth device provides short-range wireless communications that replace the physical cable connections that traditionally link electronic devices, such as the following:

- Computers (desktop, notebook, PDA)
- Phones (cellular, cordless, smart phone)
- Imaging devices (printer, camera)
- Audio devices (headset, speakers)

Bluetooth devices provide peer-to-peer capability that allows you to set up a personal area network (PAN) of Bluetooth devices. For information on configuring and using Bluetooth devices, refer to the Bluetooth software Help.

### Bluetooth and Internet Connection Sharing (ICS)

HP does **not** recommend setting up one computer with Bluetooth as a host and using it as a gateway through which other computers may connect to the Internet. When two or more computers are connected using Bluetooth, and Internet Connection Sharing (ICS) is enabled on one of the computers, the other computers may not be able to connect to the Internet using the Bluetooth network.

The strength of Bluetooth is in synchronizing information transfers between your computer and wireless devices including cellular phones, printers, cameras, and PDAs. The inability to consistently connect two or more computers to share the Internet through Bluetooth is a limitation of Bluetooth and the Windows operating system.

# Troubleshooting wireless connection problems

Some possible causes for wireless connection problems include the following:

- Network configuration (SSID or security) has been changed.
- Wireless device is not installed correctly or has been disabled.
- Wireless device or router hardware has failed.
- Wireless device encountered interference from other devices.

---

 **NOTE:** Wireless networking devices are included with select computer models only. If wireless networking is not listed in the feature list on the side of the original computer package, you may add wireless networking capability to the computer by purchasing a wireless networking device.

---

Before working your way through the sequence of possible solutions to your network connection problem, be sure that device drivers are installed for all wireless devices.

Use the procedures in this chapter to diagnose and repair a computer that does not connect to the network you want to use.

## Cannot create a WLAN connection

If you have a problem connecting to a WLAN, confirm that the integrated WLAN device is properly installed on your computer:

---

 **NOTE:** Windows includes the User Account Control feature to improve the security of your computer. You may be prompted for your permission or password for tasks such as installing software, running utilities, or changing Windows settings. Refer to Windows Help and Support for more information.

---

1. Select **Start > Control Panel > System and Security**.
2. In the **System** area, click **Device Manager**.
3. Click the arrow next to **Network adapters** to expand the list and show all adapters.
4. Identify the WLAN device from the Network adapters list. The listing for a WLAN device may include the term *wireless*, *wireless LAN*, *WLAN*, *Wi-Fi*, or *802.11*.

If no WLAN device is listed, either your computer does not have an integrated WLAN device, or the driver for the WLAN device is not properly installed.

For more information on troubleshooting WLANs, refer to the Web site links provided in Help and Support.

## Cannot connect to a preferred network

Windows can automatically repair a corrupted WLAN connection:

- If there is a network icon in the notification area, at the far right of the taskbar, right-click the icon, and then click **Troubleshoot problems**.

Windows resets your network device and attempts to reconnect to one of the preferred networks.

- If there is no network icon in the notification area, follow these steps:
  1. Select **Start > Control Panel > Network and Internet > Network and Sharing Center**.
  2. Click **Troubleshoot problems**, and then select the network you wish to repair.

## Network icon is not displayed

If the network icon is not displayed in the notification area after you configure the WLAN, the software driver is either missing or corrupted. A Windows "Device not Found" error message may also be displayed. The driver must be reinstalled.

To get the latest version of the WLAN device software for your computer, follow these steps:

1. Open your Internet browser and go to <http://www.hp.com/support>.
2. Select your country or region.
3. Click the option for software and driver downloads, and then type your computer model number in the Search box.
4. Press **enter**, and then follow the on-screen instructions.



---

**NOTE:** If the WLAN device you are using was purchased separately, consult the manufacturer's Web site for the latest software.

---

## Current network security codes are unavailable

If you are prompted for a network key or a name (SSID) when connecting to a WLAN, the network is protected by security. You must have the current codes to make a connection on a secure network. The SSID and network key are alphanumeric codes that you enter into your computer to identify your computer to the network.

- For a network connected to your personal wireless router, review the router user guide for instructions on setting up the same codes on both the router and the WLAN device.
- For a private network, such as a network in an office or at a public Internet chat room, contact the network administrator to obtain the codes, and then enter the codes when prompted to do so.

Some networks change the SSID or network keys used in their routers or access points on a regular basis to improve security. You must change the corresponding code in your computer accordingly.

If you are provided with new wireless network keys and SSID for a network, and if you have previously connected to that network, follow the steps below to connect to the network:

1. Select **Start > Control Panel > Network and Internet > Network and Sharing Center**.
2. Click **Manage wireless networks** in the left panel.

A list showing the available WLANs is displayed. If you are in a hotspot where several WLANs are active, several will be displayed.

3. Select the network in the list, right-click the network, and then click **Properties**.

---

 **NOTE:** If the network you want is not listed, check with the network administrator to be sure that the router or access point is operating.

---

4. Click the **Security** tab, and then enter the correct wireless encryption data into the **Network security key** field.
5. Click **OK** to save these settings.

## WLAN connection is very weak

If the connection is very weak, or if your computer cannot make a connection to a WLAN, minimize interference from other devices, as follows:

- Move your computer closer to the wireless router or access point.
- Temporarily disconnect other wireless devices such as a microwave, cordless phone, or cellular phone to be sure that they are not interfering.

If the connection does not improve, try forcing the device to reestablish all connection values:

1. Select **Start > Control Panel > Network and Internet > Network and Sharing Center**.
2. Click **Manage wireless networks** in the left panel.

A list showing the available WLANs is displayed. If you are in a hotspot where several WLANs are active, several will be displayed.

3. Click a network, and then click **Remove**.

## Cannot connect to the wireless router

If you are trying to connect to the wireless router and are unsuccessful, reset the wireless router by removing power from the router for 10 to 15 seconds.

If the computer still cannot make a connection to a WLAN, restart the wireless router. For details, refer to the router manufacturer's instructions.

## Using the modem (select models only)

The modem must be connected to an analog telephone line using a 6-pin, RJ-11 modem cable (purchased separately). In some countries, a country-specific modem cable adapter (purchased separately) is also required. Jacks for digital PBX systems may resemble analog telephone jacks, but they are not compatible with the modem.

⚠ **WARNING!** Connecting the internal analog modem to a digital line can permanently damage the modem. Immediately disconnect the modem cable if you accidentally connect it to a digital line.

If the modem cable contains noise suppression circuitry **(1)**, which prevents interference from TV and radio reception, orient the circuitry end **(2)** of the cable toward the computer.



## Connecting a modem cable (purchased separately)

⚠ **WARNING!** To reduce the risk of electric shock, fire, or damage to the equipment, do not plug a modem cable (purchased separately) or telephone cable into the RJ-45 (network) jack.

To connect a modem cable:

1. Plug the modem cable into the modem jack **(1)** on the computer.
2. Plug the modem cable into the RJ-11 telephone wall jack **(2)**.

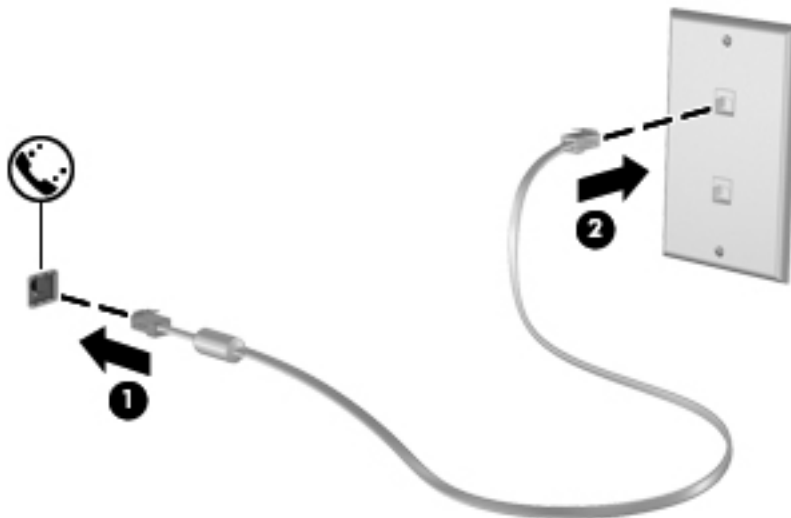

## Connecting a country-specific modem cable adapter (purchased separately)

Telephone jacks vary by country. To use the modem and the modem cable (purchased separately) outside the country in which you purchased the computer, you must obtain a country-specific modem cable adapter (purchased separately).

To connect the modem to an analog telephone line that does not have an RJ-11 telephone jack, follow these steps:

1. Plug the modem cable into the modem jack **(1)** on the computer.
2. Plug the modem cable into the country-specific modem cable adapter **(2)**.
3. Plug the country-specific modem cable adapter **(3)** into the telephone wall jack.

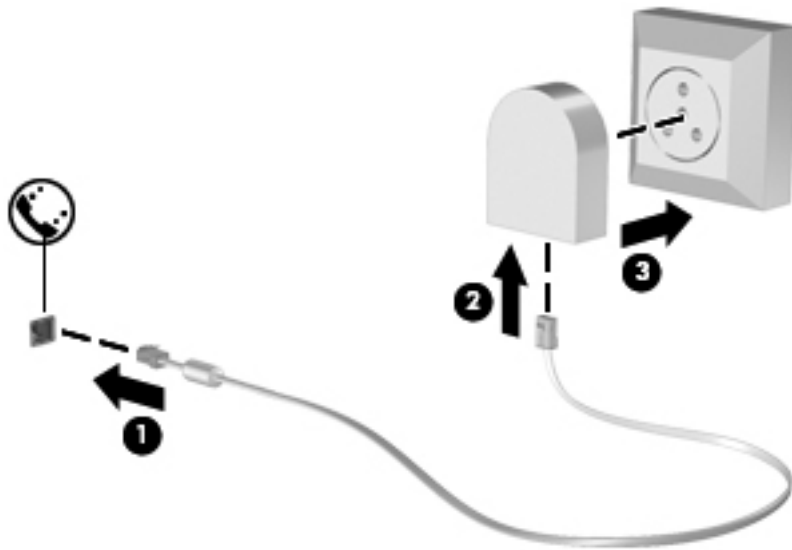

## Selecting a location setting

### Viewing the current location selection

To view the current location setting for the modem, follow these steps:

1. Select **Start > Control Panel**.
2. Click **Clock, Language, and Region**.
3. Click **Region and Language**.
4. Click the **Location** tab to display your location.

## Adding new locations when traveling

By default, the only location setting available to the modem is a location setting for the country in which you purchased the computer. As you travel to different countries, set the internal modem to a location setting that meets the operating standards of the country in which you are using the modem.

As you add new location settings, they are saved by the computer so that you can switch among settings at any time. You can add multiple location settings for any country.

△ **CAUTION:** To prevent losing your home country settings, do not delete your current modem country settings. To enable modem use in other countries while preserving your home country configuration, add a new configuration for each location in which you will use the modem.

**CAUTION:** To prevent configuring the modem in a way that violates the telecommunications regulations and laws of the country you are visiting, select the country in which the computer is located. The modem may not function properly if the correct country selection is not made.

To add a location setting for the modem, follow these steps:

1. Select **Start > Devices and Printers**.
2. Right-click the device that represents your computer, and click **Modem settings**.

 **NOTE:** You must set up an initial (current) location area code before you can view the Dialing Rules tab. If you do not have a location set up, you will be prompted to enter the location when you click Modem settings.

3. Click the **Dialing Rules** tab.
4. Click **New**. (The New Location window is displayed.)
5. In the **Location name** box, type a name (such as “home” or “work”) for the new location setting.
6. Select a country or region from the **Country/region** drop-down list. (If you select a country or region that is not supported by the modem, the Country/region selection for *USA* or *UK* is displayed by default.)
7. Enter the area code, a carrier code (if necessary), and the number to access an outside line (if necessary).
8. Next to **Dial using**, click **Tone** or **Pulse**.
9. Click **OK** to save your new location setting. (The Phone and Modem window is displayed.)
10. Do one of the following:
  - To set your new location setting as the current location, click **OK**.
  - To select another location setting as the current location setting, select your preference from the settings in the **Location** list, and then click **OK**.

 **NOTE:** You can use the preceding procedure to add location settings for places within your own country as well as in other countries. For example, you could add a setting named “Work” that includes dialing rules for accessing an outside line.

## Solving travel connection problems

If you experience modem connection problems when using the computer outside of the country in which you purchased it, try the following suggestions:

- **Check the telephone line type.**

The modem requires an analog, not a digital, telephone line. A line described as a PBX line is usually a digital line. A telephone line described as a data line, fax machine line, modem line, or standard telephone line is usually an analog line.

- **Check for pulse or tone dialing.**

An analog telephone line supports one of two dialing modes: pulse dialing or tone dialing. These dialing mode options are selected in the Phone and Modem settings. The dialing mode option selected must match the dialing mode supported by the telephone line in your location.

To determine the dialing mode supported by a telephone line, dial a few digits on the telephone, and then listen for clicks (pulses) or tones. Clicks indicate that the telephone line supports pulse dialing. Tones indicate that the telephone line supports tone dialing.

To change the dialing mode in your current modem location setting, follow these steps:

1. Select **Start > Devices and Printers**.
2. Right-click the device that represents your computer, and click **Modem settings**.
3. Click the **Dialing Rules** tab.
4. Select your modem location setting.
5. Click **Edit**.
6. Click either **Tone** or **Pulse**.
7. Click **OK** twice.

- **Check the telephone number you are dialing and the response of the remote modem.**

Dial a telephone number, make sure there is a response from the remote modem, and then hang up.

- **Set the modem to ignore dial tones.**

If the modem receives a dial tone it does not recognize, it does not dial and displays a “No Dial Tone” error message.

To set the modem to ignore all dial tones before dialing, follow these steps:

1. Select **Start > Devices and Printers**.
2. Right-click the device that represents your computer, and click **Modem settings**.
3. Click the **Modems** tab.
4. Click the listing for the modem.
5. Click **Properties**.
6. Click **Modem**.



7. Clear the check box for **Wait for dial tone before dialing**.
8. Click **OK** twice.

## Connecting to a local area network (LAN)

Connecting to a local area network (LAN) requires an 8-pin, RJ-45 network cable (purchased separately). If the network cable contains noise suppression circuitry (1), which prevents interference from TV and radio reception, orient the circuitry end of the cable (2) toward the computer.



To connect the network cable:

1. Plug the network cable into the network jack (1) on the computer.
2. Plug the other end of the cable into a network wall jack (2).

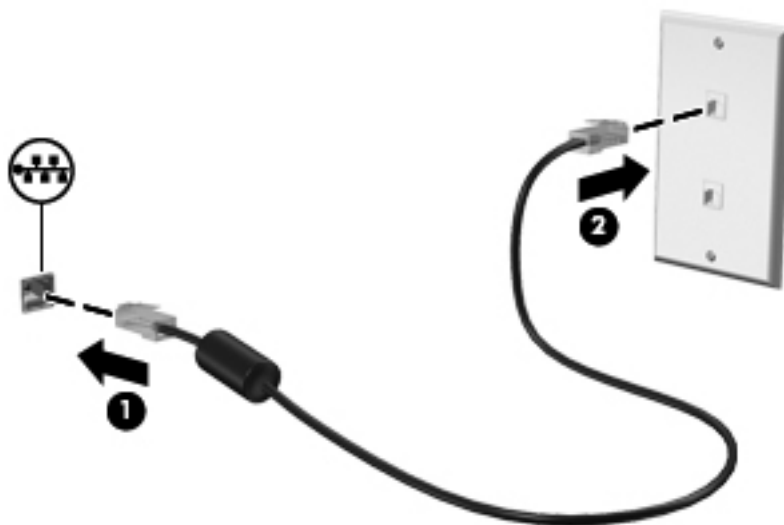

**⚠ WARNING!** To reduce the risk of electric shock, fire, or damage to the equipment, do not plug a modem or telephone cable into the RJ-45 (network) jack.

---

## 3 Pointing devices and keyboard

### Using pointing devices

#### Setting pointing device preferences

Use Mouse Properties in Windows to customize settings for pointing devices, such as button configuration, click speed, and pointer options.

To access Mouse Properties, select **Start > Devices and Printers**. Then, right-click the device representing your computer, and select **Mouse settings**.

#### Using the TouchPad

To move the pointer, slide your finger across the TouchPad surface in the direction you want the pointer to go. Use the TouchPad buttons like the corresponding buttons on an external mouse. To scroll up and down using the TouchPad vertical scroll zone, slide your finger up or down over the lines.

---

 **NOTE:** If you are using the TouchPad to move the pointer, you must lift your finger off the TouchPad before moving it to the scroll zone. Simply sliding your finger from the TouchPad to the scroll zone will not activate the scrolling function.

---

#### Connecting an external mouse

You can connect an external USB mouse to the computer using one of the USB ports on the computer. A wireless Bluetooth mouse can be used only on Bluetooth-enabled computers (select models only); follow the instructions provided with the device.

### Using the keyboard

#### Using hotkeys

Hotkeys are combinations of the **fn** key **(1)** and either the **esc** key **(2)** or one of the function keys **(3)**.

The icons on the **f1** through **f12** keys represent the hotkey functions. Hotkey functions and procedures are discussed in the following sections.

---

 **NOTE:** Refer to the illustration that most closely matches your computer.

---



Function	Hotkey
Display system information.	<a href="#">fn+esc</a>
Open Help and Support.	<a href="#">fn+f1</a>
Decrease screen brightness.	<a href="#">fn+f2</a>
Increase screen brightness.	<a href="#">fn+f3</a>
Switch the screen image.	<a href="#">fn+f4</a>
Initiate Sleep.	<a href="#">fn+f5</a>
Initiate QuickLock.	<a href="#">fn+f6</a>
Mute speaker sound.	<a href="#">fn+f7</a>
Decrease speaker sound.	<a href="#">fn+f8</a>
Increase speaker sound.	<a href="#">fn+f9</a>
Play previous track.	<a href="#">fn+f10</a>
Play, pause, or resume a CD, DVD, or BD.	<a href="#">fn+f11</a>
Play next track.	<a href="#">fn+f12</a>

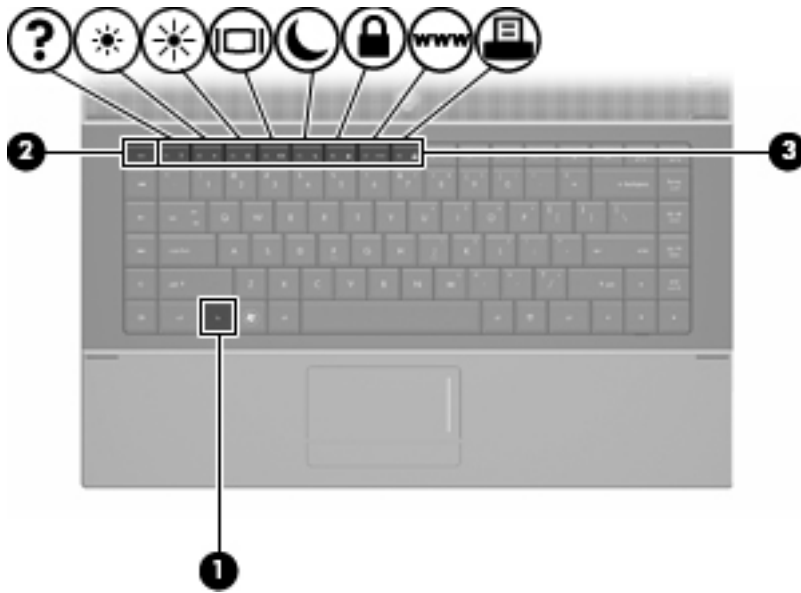

Function	Hotkey
Display system information.	<a href="#">fn+esc</a>
Open Help and Support.	<a href="#">fn+f1</a>
Decrease screen brightness.	<a href="#">fn+f2</a>
Increase screen brightness.	<a href="#">fn+f3</a>
Switch the screen image.	<a href="#">fn+f4</a>
Initiate Sleep.	<a href="#">fn+f5</a>
Initiate QuickLock	<a href="#">fn+f6</a>
Launch Web browser.	<a href="#">fn+f7</a>
Launch printer.	<a href="#">fn+f8</a>

To use a hotkey command on the computer keyboard, follow either of these steps:

- Briefly press the **fn** key, and then briefly press the second key of the hotkey command.  
– or –
- Press and hold down the **fn** key, briefly press the second key of the hotkey command, and then release both keys at the same time.

## Displaying system information

Press [fn+esc](#) to display information about system hardware components and the system BIOS version number.

In the Windows [fn+esc](#) display, the version of the system BIOS (basic input-output system) is displayed as the BIOS date. On some computer models, the BIOS date is displayed in decimal format. The BIOS date is sometimes called the system ROM version number.

## Opening Help and Support

Press **fn+f1** to open Help and Support.

In addition to providing information about your Windows operating system, Help and Support provides the following information and tools:

- Information about your computer, such as model and serial number, installed software, hardware components, and specifications
- Answers to questions about using your computer
- Tutorials to help you learn to use the computer and Windows features
- Updates for the Windows operating system, drivers, and the software provided on your computer
- Checkups for computer functionality
- Automated and interactive troubleshooting, repair solutions, and system recovery procedures
- Links to support specialists

## Decreasing screen brightness

Press **fn+f2** to decrease screen brightness. Hold down the hotkey to decrease the brightness level incrementally.

## Increasing screen brightness

Press **fn+f3** to increase screen brightness. Hold down the hotkey to increase the brightness level incrementally.

## Switching the screen image

Press **fn+f4** to switch the screen image among display devices connected to the system. For example, if a monitor is connected to the computer, pressing **fn+f4** alternates the screen image from computer display to monitor display to simultaneous display on both the computer and the monitor.

Most external monitors receive video information from the computer using the external VGA video standard. The **fn+f4** hotkey can also alternate images among other devices receiving video information from the computer.

The following video transmission types, with examples of devices that use them, are supported by the **fn+f4** hotkey:

- LCD (computer display)
- External VGA (most external monitors)
- HDMI (televisions, camcorders, DVD players, VCRs, and video capture cards with HDMI ports)
- Composite video (televisions, camcorders, DVD players, VCRs, and video capture cards with composite-video-in jacks)

---

 **NOTE:** Composite video devices can be connected to the system only by using an optional docking device or optional expansion product

---

## Initiating Sleep (fn+f5)

 **CAUTION:** To reduce the risk of information loss, save your work before initiating Sleep.

Press **fn+f5** to initiate Sleep.

When Sleep is initiated, your information is stored in system memory, the screen is cleared, and power is conserved. While the computer is in the Sleep state, the power lights blink.

The computer must be on before you can initiate Sleep.

 **NOTE:** If a critical battery level occurs while the computer is in the Sleep state, the computer initiates Hibernation and the information stored in memory is saved to the hard drive. The factory setting for critical battery action is Hibernate, but this setting can be changed using Power Options in Windows Control Panel.

To exit Sleep, briefly press the power button.

The function of the **fn+f5** hotkey can be changed. For example, you can set the **fn+f5** hotkey to initiate Hibernation instead of Sleep.

 **NOTE:** In all Windows operating system windows, references to the *sleep button* apply to the **fn+f5** hotkey.

## Initiating QuickLock (fn+f6) (select models)

Press **fn+f6** to initiate the QuickLock security feature.

QuickLock protects your information by displaying the operating system Log On window. While the Log On window is displayed, the computer cannot be accessed until a Windows user password or a Windows administrator password is entered.

 **NOTE:** Before you can use QuickLock, you must set a Windows user password or a Windows administrator password. For instructions, refer to Help and Support.

To use QuickLock, press **fn+f6** to display the Log On window and lock the computer. Then follow the instructions on the screen to enter your Windows user password or your Windows administrator password and access the computer.

## Launching Web browser (fn+f7) (select models)

To launch your default Web browser, press **fn+f7**.

## Launching printer (fn+f8) (select models)

To print the item displayed, press **fn+f8** to activate your printer.

## Muting speaker sound (fn+f7) (select models)

Press **fn+f7** to mute speaker sound. Press the hotkey again to restore speaker sound.

## Decreasing speaker sound (fn+f8) (select models)

Press **fn+f8** to decrease speaker volume. Hold down the hotkey to decrease speaker volume incrementally.

### **Increasing speaker sound (fn+f9) (select models)**

Press **fn+f9** to increase speaker volume. Hold down the hotkey to increase speaker volume incrementally.

### **Playing the previous track or section of an audio CD or a DVD (fn+f10) (select models)**

While an audio CD or a DVD is playing, press **fn+f10** to play the previous track of the CD or the previous section of the DVD.

### **Playing, pausing, or resuming an audio CD or a DVD (fn+f11) (select models)**

The **fn+f11** hotkey functions only when an audio CD or a DVD is inserted.

- If the audio CD or the DVD is not playing, press **fn+f11** to begin or resume the play.
- If the audio CD or the DVD is playing, press **fn+f11** to pause the play.

### **Playing the next track or section of an audio CD or a DVD (fn+f12) (select models)**

While an audio CD or a DVD is playing, press **fn+f12** to play the next track of the CD or the next section of the DVD.



# Using the embedded numeric keypad

The 15 keys of the embedded numeric keypad can be used like the keys on an external keypad. When the embedded numeric keypad is turned on, each key on the keypad performs the function indicated by the icon in the upper-right corner of the key.

## Enabling and disabling the embedded numeric keypad

Press **fn+num lk** to enable the embedded numeric keypad. Press **fn+num lk** again to return the keys to their standard keyboard functions.

---

 **NOTE:** The embedded numeric keypad will not function while an external keyboard or numeric keypad is connected to the computer.

---

## Switching key functions on the embedded numeric keypad

You can temporarily alternate the functions of keys on the embedded numeric keypad between their standard keyboard functions and their keypad functions by using the **fn** key or the **fn+shift** key combination.

- To change the function of a keypad key to keypad functions while the keypad is off, press and hold the **fn** key while pressing the keypad key.
- To use the keypad keys temporarily as standard keys while the keypad is on:
  - Press and hold the **fn** key to type in lowercase.
  - Press and hold **fn+shift** to type in uppercase.

## Using an optional external numeric keypad

Keys on most external numeric keypads function differently according to whether num lock is on or off. (Num lock is turned off at the factory.) For example:

- When num lock is on, most keypad keys type numbers.
- When num lock is off, most keypad keys function like the arrow, page up, or page down keys.

When num lock on an external keypad is turned on, the num lock light on the computer is turned on. When num lock on an external keypad is turned off, the num lock light on the computer is turned off.

To turn num lock on or off on an external keypad as you work:

- ▲ Press the **num lk** key on the external keypad, not on the computer.

---

# 4 Multimedia

## Multimedia features

Your computer includes multimedia features that allow you to listen to music, watch movies, and view pictures. Your computer may include the following multimedia components:

- Optical drive for playing audio and video discs
- Integrated speakers for listening to music
- Integrated microphone for recording your own audio
- Integrated webcam that allows you to capture and share video
- Preinstalled multimedia software that allows you to play and manage your music, movies, and pictures
- Hotkeys that provide fast access to multimedia tasks

---

 **NOTE:** Your computer may not include all of the components listed.

---

The following sections explain how to identify and use the multimedia components included with your computer.

## Identifying your multimedia components

The following illustration and table describe the multimedia features of the computer.

---

 **NOTE:** Your computer may look slightly different from the illustration in this section.

---

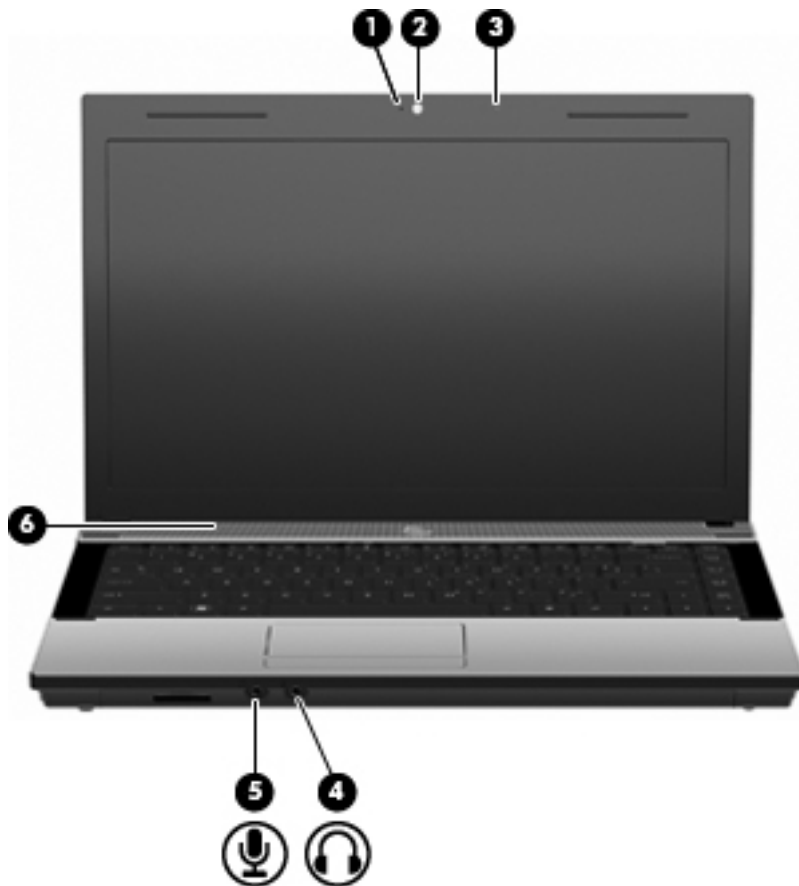

Component	Description
(1) Webcam light (select models only)	On: The webcam is in use.
(2) Webcam	Records video and captures still photographs.
(3) Integrated microphone	Records sound.
(4) Audio-out (headphone) jack	Produces sound when connected to optional powered stereo speakers, headphones, ear buds, a headset, or television audio. <b>NOTE:</b> When a device is connected to the headphone jack, the computer speakers are disabled.
(5) Audio-in (microphone) jack	Connects an optional computer headset microphone, stereo array microphone, or monaural microphone.
(6) Speaker	Produce sound.

## Adjusting the volume

You can adjust the volume using the following controls:

- Computer volume keys (select models only):
  - To mute or restore volume, press and hold the **fn** key (1), and then press the mute key **f7** (2).
  - To decrease volume, press and hold the **fn** key (1), and then tap the volume down key **f8** (3) until the desired volume level is reached.
  - To increase volume, press and hold the **fn** key (1), and then tap the volume up key **f9** (4) until the desired volume level is reached.

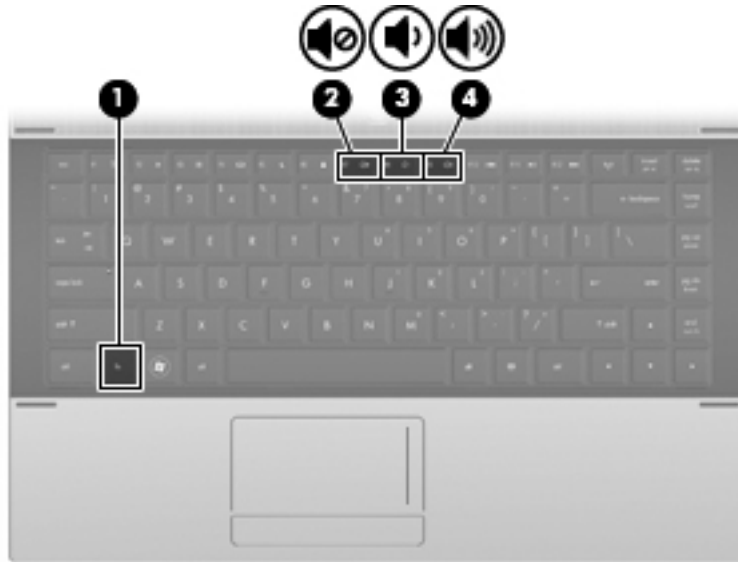

- Windows volume control:
  - a. Click the **Speakers** icon in the notification area, at the far right of the taskbar.
  - b. Increase or decrease the volume by moving the slider up or down. Click the **Mute Speakers** icon to mute the volume.

– or –

  - a. Right-click the **Speakers** icon in the notification area, and then click **Open Volume Mixer**.
  - b. In the Speakers column, you can increase or decrease the volume by moving the slider up or down. You can also mute the volume by clicking the **Mute Speakers** icon.

If the Speakers icon is not displayed in the notification area, follow these steps to add it:

  - a. Right-click the **Show hidden icons** icon (the arrow at the left side of the notification area).
  - b. Click **Customize notification icons**.

- c. Under **Behaviors**, select **Show icon and notifications** for the Speakers icon
  - d. Click **OK**.
- Program volume control:  
Volume can also be adjusted within some programs.

## Multimedia software

The computer includes preinstalled multimedia software. Some computer models also include additional multimedia software on an optical disc.

Depending on the hardware and software included with the computer, the following multimedia tasks may be supported:

- Playing digital media, including audio and video CDs, DVDs, and BDs, and Internet radio
- Creating or copying data CDs
- Creating, editing, and burning audio CDs
- Creating, editing, and burning a video or movie to a DVD or video CD

---

△ **CAUTION:** To prevent loss of information or damage to a disc, observe the following guidelines:

Before writing to a disc, connect the computer to a reliable external power source. Do not write to a disc while the computer is running on battery power.

Before writing to a disc, close all open programs except the disc software you are using.

Do not copy directly from a source disc to a destination disc or from a network drive to a destination disc. Instead, copy from a source disc or network drive to your hard drive, and then copy from your hard drive to the destination disc.

Do not use the computer keyboard or move the computer while the computer is writing to a disc. The write process is sensitive to vibration.

---

## Accessing your preinstalled multimedia software

To access your preinstalled software:

- ▲ Select **Start > All Programs**, and then open the multimedia program that you want to use.

---

📝 **NOTE:** Some programs may be located in subfolders.

---

## Using multimedia software

1. Select **Start > All Programs**, and then open the multimedia program you want to use. For example, if you want to use Windows Media Player to play an audio CD, click **Windows Media Player**.

---

📝 **NOTE:** Some programs may be located in subfolders.

---

2. Insert the media disc, such as an audio CD, into the optical drive.
3. Follow the instructions on the screen.

– or –

1. Insert the media disc, such as an audio CD, into the optical drive.  
An AutoPlay dialog box opens.
2. Click a multimedia task from the list of tasks.

## Installing multimedia software from a disc

1. Insert the disc into the optical drive.
2. When the installation wizard opens, follow the on-screen instructions.
3. Restart the computer if prompted to do so.

---

 **NOTE:** For information about using software included with the computer, refer to the software manufacturer's instructions. These instructions may be provided on disc, as online Help files, or on the software manufacturer's Web site.

---

# Audio

Your computer enables you to use a variety of audio features:

- Play music using your computer speakers and/or connected external speakers
- Record sound using the internal microphone or connect an external microphone
- Download music from the Internet
- Create multimedia presentations using audio and images
- Transmit sound and images with instant messaging programs
- Stream radio programs (select models only) or receive FM radio signals
- Create, or “burn,” audio CDs (select models only)

## Connecting external audio devices

---

 **WARNING!** To reduce the risk of personal injury, adjust the volume before putting on headphones, earbuds, or a headset. For additional safety information, refer to the *Regulatory, Safety and Environmental Notices*.

---

To connect external devices such as external speakers, headphones, or a microphone, refer to the information provided with the device. For best results, remember the following tips:

- Be sure that the device cable is securely connected to the correct jack on your computer. (Cable connectors are normally color-coded to match the corresponding jacks on the computer.)
- Be sure to install any drivers required by the external device.

---

 **NOTE:** A driver is a required program that acts like a translator between the device and the programs that use the device.

---

## Checking your audio functions

To check the system sound on your computer, follow these steps:

1. Right-click the Volume icon on the taskbar, and then select **Sounds**.

– or –

Select **Start > Control Panel > Hardware and Sound > Sound**.

2. When the Sound window opens, click the **Sounds** tab. Under **Program Events**, select any sound event, such as a beep or alarm, and click the **Test** button.

You should hear sound through the speakers or through connected headphones.

To check the record functions of the computer, follow these steps:

1. Select **Start > All Programs > Accessories > Sound Recorder**.
2. Click **Start Recording** and speak into the microphone. Save the file to your desktop.
3. Open Windows Media Player and play back the sound.



---

 **NOTE:** For best results when recording, speak directly into the microphone and record sound in a setting free of background noise.

---

To confirm or change the audio settings on your computer, select **Start > Control Panel > Hardware and Sound > Sound**.

# Video

Your computer enables you to use a variety of video features:

- Watch movies
- Play games over the Internet and offline
- Edit pictures and video to create presentations
- Connect external video devices

## Connecting an external monitor or projector

Your computer has an external monitor port that allows you to connect external monitors and projectors.

### Using the external monitor port

The external monitor port connects an external display device, such as an external monitor or a projector, to the computer.

- ▲ To connect a display device, connect the device cable to the external monitor port.

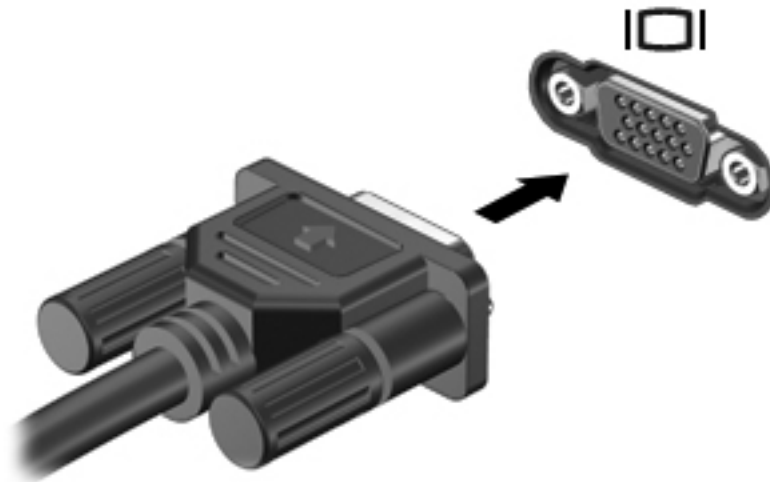

---

 **NOTE:** If a properly connected external display device does not display an image, press **fn+f4** to transfer the image to the device. Repeatedly pressing **fn+f4** alternates the screen image between the computer display and the device.

---

### Using the HDMI port

Select computer models include an HDMI (High Definition Multimedia Interface) port. The HDMI port connects the computer to an optional video or audio device, such as a high-definition television, or any compatible digital or audio component.

The computer can support one HDMI device connected to the HDMI port, while simultaneously supporting an image on the computer display or any other supported external display.

---

 **NOTE:** To transmit video signals through the HDMI port, you need an HDMI cable (purchased separately), available from most electronics retailers.

---

To connect a video or audio device to the HDMI port:

1. Plug one end of the HDMI cable into the HDMI port on the computer.

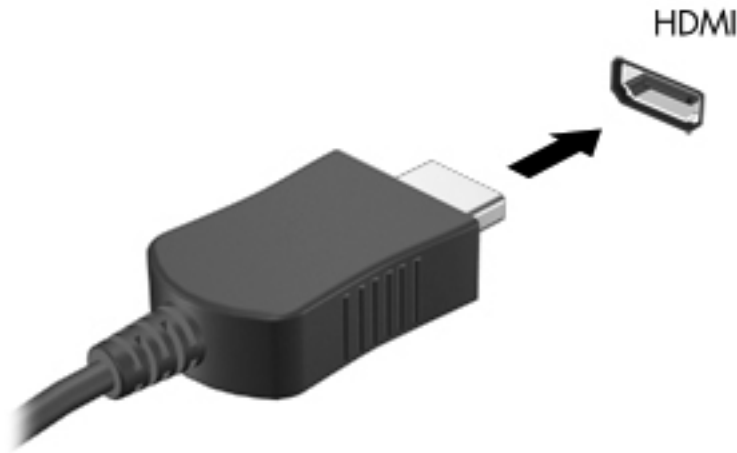

2. Connect the other end of the cable to the video device, according to the device manufacturer's instructions.
3. Press **fn+f4** to switch the image between the display devices connected to the computer.

## Configuring audio for HDMI

To configure HDMI audio, first connect an audio or video device, such as a high-definition TV, to the HDMI port on your computer. Then configure the default audio playback device as follows:

1. Right-click the **Speaker** icon in the notification area, at the far right of the taskbar, and then click **Playback devices**.
2. On the **Playback** tab, click either **Digital Output** or **Digital Output Device (HDMI)**.
3. Click **Set Default**, and then click **OK**.

To return audio to the computer speakers, follow these steps:

1. Right-click the **Speaker** icon in the notification area, at the far right of the taskbar, and then click **Playback devices**.
2. On the **Playback** tab, click **Speakers**.
3. Click **Set Default**, and then click **OK**.

## Optical drive (select models only)

Depending on the type of optical drive and software installed in your computer, the optical drive plays, copies, and creates CDs, DVDs, or BDs.

### Identifying the installed optical drive

- ▲ Select **Start > Computer**.

You will see a list of all the devices installed on your computer, including your optical drive. You may have one of the following types of drives:

- DVD-ROM Drive
- DVD±R SuperMulti DL LightScribe Drive

 **NOTE:** Both drives listed above may not be supported by your computer.

### Using optical discs (CDs, DVDs, and BDs)

An optical drive, such as a DVD-ROM drive, supports optical discs (CDs and DVDs). These discs store information, such as music, photos, and movies. DVDs have a higher storage capacity than CDs.

Your optical drive can read standard CD and DVD discs. If your optical drive is a Blu-ray Disc (BD) drive, it can also read BDs.

 **NOTE:** Some of the optical drives listed may not be supported by your computer. The listed drives are not necessarily all of the supported optical drives.

Some optical drives can also write to optical discs, as described in the following table.

Optical drive type	Write to CD-RW	Write to DVD±RW/R	Write to DVD±R DL	Write label to LightScribe CD or DVD ±RW/R	Write to BD R/RE
DVD-ROM Drive	No	No	No	No	No
DVD±R SuperMulti DL LightScribe Drive*†	Yes	Yes	Yes	Yes	No

\*Double-layer discs can store more data than single-layer discs. However, double-layer discs burned with this drive may not be compatible with many single-layer DVD drivers and players.

†LightScribe discs must be purchased separately. LightScribe creates a grayscale image similar to black-and-white photography.

△ **CAUTION:** To prevent possible audio and video degradation, loss of information, or loss of audio or video playback functionality, do not initiate Sleep or Hibernation while reading a CD, DVD, or BD, or writing to a CD or DVD.

### Selecting the right disc (CDs, DVDs, and BDs)

An optical drive supports optical discs (CDs and DVDs, and BDs). CDs, used to store digital data, are also used for commercial audio recordings and are convenient for your personal storage needs.

DVDs and BDs are used primarily for movies, software, and data backup purposes. DVDs and BDs are the same form factor as CDs, but have a much higher storage capacity.

 **NOTE:** The optical drive on your computer may not support all the types of optical discs discussed in this section.

---

## CD-R discs

Use CD-R (write-once) discs to create permanent archives and to share files with virtually anyone. Typical uses include the following:

- Distributing large presentations
- Sharing scanned and digital photos, video clips, and written data
- Making your own music CDs
- Keeping permanent archives of computer files and scanned home records
- Offloading files from your hard drive to free up disk space

After data is recorded, it cannot be erased or written over.

## CD-RW discs

Use a CD-RW disc (a rewritable version of a CD) to store large projects that must be updated frequently. Typical uses include the following:

- Developing and maintaining large documents and project files
- Transporting work files
- Making weekly backups of hard drive files
- Updating photos, video, audio, and data continuously

## DVD±R discs

Use blank DVD±R discs to permanently store large amounts of information. After data is recorded, it cannot be erased or written over.

## DVD±RW discs

Use DVD±RW discs if you want to be able to erase or write over data that you saved earlier. This type of disc is ideal for testing audio or video recordings before you burn them to a CD or DVD that cannot be changed.

## LightScribe DVD+R discs

Use LightScribe DVD+R discs for sharing and storing data, home videos, and photos. These discs are read-compatible with most DVD-ROM drives and DVD video players. With a LightScribe-enabled drive and LightScribe software, you can write data to the disc and then add a designer label to the outside of the disc.

## Blu-ray Discs (BDs)

BD is a high-density optical disc format for the storage of digital information, including high-definition video. A single-layer Blu-ray Disc can store 25 GB, over 5 times the storage capacity of a single-layer

DVD at 4.7 GB. A dual-layer Blu-ray Disc can store 50 GB, almost 6 times the storage capacity of a dual-layer DVD at 8.5 GB.

Typical uses include the following:

- Storage of large amounts of data
- High-definition video playback and storage
- Video games

---

 **NOTE:** As Blu-ray is a new format containing new technologies, certain disc, digital connection, compatibility and/or performance issues may arise, and do not constitute defects in the product. Flawless playback on all systems is not guaranteed.

---

## Playing a CD, DVD, or BD

1. Turn on the computer.
2. Press the release button **(1)** on the drive bezel to release the disc tray.
3. Pull out the tray **(2)**.
4. Hold the disc by the edges to avoid touching the flat surfaces and position the disc label-side up over the tray spindle.

---

 **NOTE:** If the tray is not fully accessible, tilt the disc carefully to position it over the spindle.

---

5. Gently press the disc **(3)** down onto the tray spindle until the disc snaps into place.

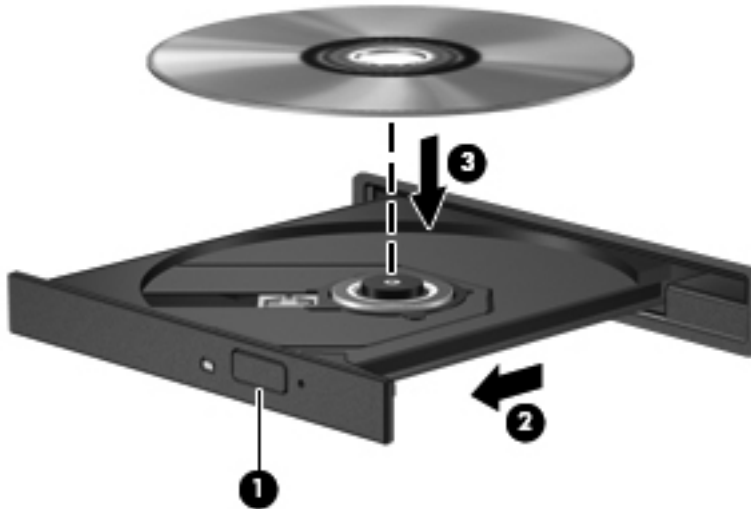

6. Close the disc tray.

If you have not yet configured AutoPlay, as described in the following section, an AutoPlay dialog box opens. It prompts you to select how you want to use the media content.

---

 **NOTE:** For best results, be sure that your AC adapter is plugged into an external power source while playing a BD.

---

## Configuring AutoPlay

1. Select **Start > Default Programs > Change AutoPlay settings**.
2. Confirm that the **Use AutoPlay for all media and devices** check box is selected.
3. Click **Choose a default**, and then select one of the available options for each media type listed.

---

 **NOTE:** Choose WinDVD to play DVDs.

---

4. Click **Save**.

---

 **NOTE:** For more information about AutoPlay, refer to Help and Support.

---

## Changing DVD region settings

Most DVDs that contain copyrighted files also contain region codes. The region codes help protect copyrights internationally.

You can play a DVD containing a region code only if the region code on the DVD matches the region setting on your DVD drive.

---

 **CAUTION:** The region settings on your DVD drive can be changed only 5 times.

The region setting you select the fifth time becomes the permanent region setting on the DVD drive.

The number of region changes remaining is displayed on the DVD Region tab.

---

To change settings through the operating system:

1. Select **Start > Control Panel > System and Security**. Then in the **System** area, click **Device Manager**.

---

 **NOTE:** Windows includes the User Account Control feature to improve the security of your computer. You may be prompted for your permission or password for tasks such as installing software, running utilities, or changing Windows settings. Refer to Windows Help and Support for more information.

---

2. Click the plus sign (+) next to **DVD/CD-ROM drives**.
3. Right-click the DVD drive for which you want to change region settings, and then click **Properties**.
4. Click the **DVD Region** tab, and change settings.
5. Click **OK**.

## Observing the copyright warning

It is a criminal offense, under applicable copyright laws, to make unauthorized copies of copyright-protected material, including computer programs, films, broadcasts, and sound recordings. Do not use this computer for such purposes.

---

 **NOTE:** For details about using software included with the computer, refer to the software manufacturer's instructions. These instructions may be provided with the software, on disc, or on the manufacturer's Web site.

---

## Copying a CD or DVD

1. Select **Start > All Programs > Roxio > Creator Business**.

 **NOTE:** If this is the first time you have used Roxio, you must accept the program license agreement before you can complete this process.

---

2. In the right pane, click **Copy Disc**.
3. Insert the disc you want to copy into the optical drive.
4. Click **Copy Disc** at the bottom right of the screen.

Creator Business reads the source disc and copies the data to a temporary folder on your hard drive.

5. When prompted, remove the source disc from the optical drive and insert a blank disc into the drive.

After the information is copied, the disc you created is ejected automatically.

## Creating (burning) a CD or DVD

 **CAUTION:** Observe the copyright warning. It is a criminal offense, under applicable copyright laws, to make unauthorized copies of copyright-protected material, including computer programs, films, broadcasts, and sound recordings. Do not use this computer for such purposes.

---

If your optical drive is a CD-RW, DVD-RW, or DVD±RW optical drive, you can use software such as Windows Media Player to burn data and audio files, including MP3 and WAV music files.

Observe the following guidelines when burning a CD or DVD:

- Before burning a disc, save and close any open files and close all programs.
- A CD-R or DVD-R is usually best for burning audio files because after the information is copied, it cannot be changed.
- Because some home and car stereos will not play CD-RWs, use CD-Rs to burn music CDs.
- A CD-RW or DVD-RW is generally best for burning data files or for testing audio or video recordings before you burn them to a CD or DVD that cannot be changed.
- DVD players used in home systems usually do not support all DVD formats. Refer to the user guide that came with your DVD player for a list of supported formats.
- An MP3 file uses less space than other music file formats, and the process for creating an MP3 disc is the same as the process for creating a data file. MP3 files can be played only on MP3 players or on computers with MP3 software installed.

To burn a CD or DVD, follow these steps:

1. Download or copy the source files into a folder on your hard drive.
2. Insert a blank disc into the optical drive.
3. Select **Start > All Programs** and the name of the software you want to use.
4. Select the kind of disc you want to create—data, audio, or video.



5. Right-click **Start**, click **Open Windows Explorer**, and then navigate to the folder where the source files are stored.
6. Open the folder, and then drag the files to the drive that contains the blank disc.
7. Initiate the burning process as directed by the program you have selected.

For specific instructions, refer to the software manufacturer's instructions. These instructions may be provided with the software, on disc, or on the manufacturer's Web site.

## Removing an optical disc (CD, DVD, or BD)

1. Press the release button (1) on the drive bezel to release the disc tray, and then gently pull out the tray (2) until it stops.
2. Remove the disc (3) from the tray by gently pressing down on the spindle while lifting the outer edges of the disc. Hold the disc by the edges and avoid touching the flat surfaces.

---

 **NOTE:** If the tray is not fully accessible, tilt the disc carefully as you remove it.

---

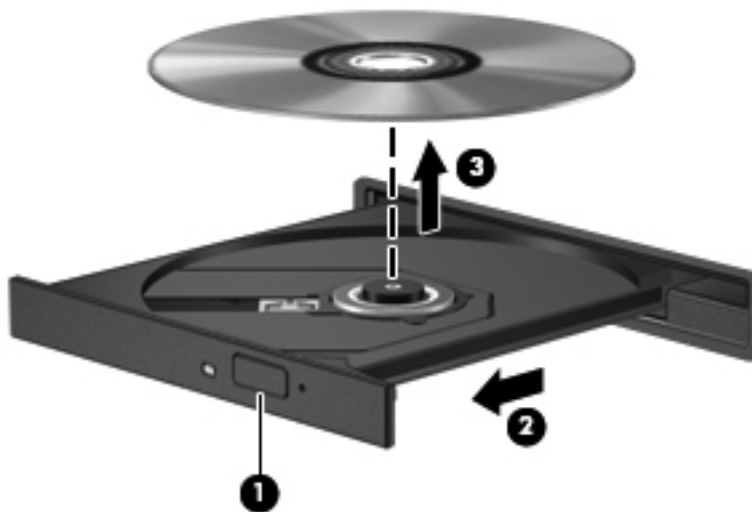

3. Close the disc tray and place the disc in a protective case.

## Troubleshooting

The following sections describe several common issues and resolutions.

### The optical disc tray does not open for removal of a CD, DVD, or BD

1. Insert the end of a paper clip (1) into the release access in the front bezel of the drive.
2. Press in gently on the paper clip until the disc tray is released, and then pull out the tray (2) until it stops.

3. Remove the disc **(3)** from the tray by gently pressing down on the spindle while lifting the outer edges of the disc. Hold the disc by the edges and avoid touching the flat surfaces.

 **NOTE:** If the tray is not fully accessible, tilt the disc carefully as you remove it.

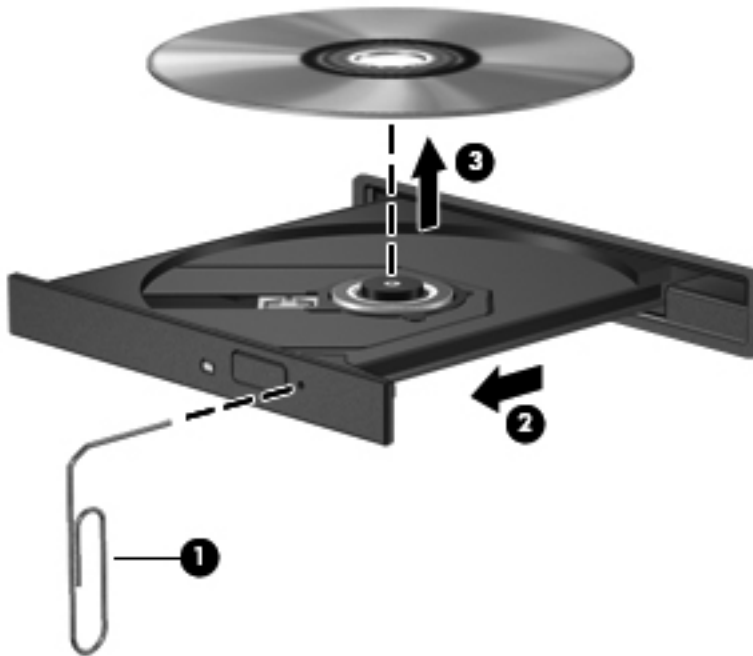

4. Close the disc tray and place the disc in a protective case.

### The computer does not detect the optical drive

If Windows does not detect an attached device, the device driver software may be missing or corrupted. If you suspect that the DVD/CD-ROM drive is not being detected, verify that the optical drive is listed in the Device Manager utility.

1. Remove any discs from the optical drive.
2. Select **Start > Control Panel > System and Security > Device Manager**. If prompted by User Account Control, click **Continue**.
3. In the Device Manager window, click the plus sign (+) next to **Discs Drives** or **DVD/CD-ROM drives**, unless a minus sign (-) is already showing. Look for an optical drive listing.
4. Right-click the optical device listing to perform the following tasks:
  - Update the driver.
  - Uninstall the device.

- Scan for hardware changes. Windows scans your system for installed hardware and installs any required default drivers.
- Click **Properties** to see if the device is working properly.
  - The Properties window provides details about the device to help you troubleshoot issues.
  - Click the **Driver** tab to update, disable, or uninstall drivers for this device.

## Preventing playback disruptions

To reduce the possibility of playback disruption:

- Save your work and close all open programs before playing a CD, DVD, or BD.
- Do not connect or disconnect hardware while playing a disc.

Do not initiate Hibernation or Sleep while playing a disc. Otherwise, you may see a warning message asking if you want to continue. If this message is displayed, click **No**. After you click No, the computer may behave in either of the following ways:

- Playback may resume.
- or –
- The playback window in the multimedia program may close. To return to playing the CD, DVD, or BD, click the **Play** button in your multimedia program to restart the disc. In rare cases, you may need to exit the program and then restart it.

## A disc does not play

- Save your work and close all open programs before playing a CD, DVD, or BD.
- Log off the Internet before playing a CD, DVD, or BD.
- Be sure that you insert the disc properly.
- Be sure that the disc is clean. If necessary, clean the disc with filtered water and a lint-free cloth. Wipe from the center of the disc to the outer edge.
- Check the disc for scratches. If you find scratches, treat the disc with an optical disc repair kit available at many electronics stores.
- Disable Sleep mode before playing the disc.

Do not initiate Hibernation or Sleep while playing a disc. Otherwise, you may see a warning message asking if you want to continue. If this message is displayed, click **No**. After you click No, the computer may behave in either of the following ways:

- Playback may resume.
- or –
- The playback window in the multimedia program may close. To return to playing the disc, click the **Play** button in your multimedia program to restart the disc. In rare cases, you may need to exit the program and then restart it.
- Increase system resources:

Turn off external devices such as printers and scanners. Disconnecting these devices frees up valuable system resources and results in better playback performance.

Change desktop color properties. Because the human eye cannot easily tell the difference between colors beyond 16 bits, you should not notice any loss of color while watching a movie if you lower system color properties to 16-bit color, as follows:

1. Right-click anywhere on the desktop except on an icon, and then select **Screen resolution**.
2. Click **Advanced settings > Monitor** tab.
3. Click **High Color (16 bit)**, if this setting is not already selected.
4. Click **OK**.

### A disc does not play automatically

1. Select **Start > Control Panel > Hardware and Sound > Autoplay**.
2. Confirm that the **Use AutoPlay for all media and devices** check box is selected.
3. Click **Save**.

A CD, DVD, or BD should now start automatically when it is inserted into the optical drive.

### A movie stops, skips, or plays erratically

- Clean the disc.
- Conserve system resources by trying the following suggestions:
  - Log off the Internet.
  - Change the color properties of the desktop:
    1. Right-click on a blank area of the computer desktop, and then select **Personalize > Display Settings**.
    2. Set **Colors** to **Medium (16 bit)**, if this setting is not already selected.
  - Disconnect external devices, such as a printer, scanner, camera, or handheld device.

### A movie is not visible on an external display

1. If both the computer display and an external display are turned on, press **fn+f4** one or more times to switch between the two displays.
2. Configure the monitor settings to make the external display primary:
  - a. Right-click on a blank area of the computer desktop, and then select **Personalize > Display Settings**.
  - b. Specify a primary display and a secondary display.

 **NOTE:** When using both displays, the DVD image will not appear on any display designated as the secondary display.

To get information about a multimedia question not covered in this guide, select **Start > Help and Support**.

## The process of burning a disc does not begin, or it stops before completion

- Be sure that all other programs are closed.
- Turn off Sleep mode and Hibernation.
- Be sure that you are using the right kind of disc for your drive. See your user guides for more information about disc types.
- Be sure that the disc is inserted properly.
- Select a slower write speed and try again.
- If you are copying a disc, save the information on the source disc to your hard drive before trying to burn the contents to a new disc, and then burn from your hard drive.
- Reinstall the disc-burning device driver located in the DVD/CD-ROM drives category in Device Manager.

## A device driver must be reinstalled

1. Remove any discs from the optical drive.
2. Click **Start > Control Panel > System and Security > Device Manager**.
3. In the Device Manager window, click the plus sign (+) next to the type of driver you want to uninstall and reinstall (for example, DVD/CD-ROMs, Modems, and so on), unless a minus sign (-) is already showing.
4. Right-click the device listed and click **Uninstall**. When prompted, confirm that you want to delete the driver, but do not restart the computer.

Repeat for any other drivers you want to delete.

5. In the Device Manager window, click **Action**, and then click **Scan for hardware changes**. Windows scans your system for installed hardware and installs default drivers for anything requiring drivers.

---

 **NOTE:** If you are prompted to restart the computer, save all open files, and then continue with the restart.

---

6. Reopen Device Manager, if necessary, and then verify that the drivers are once again listed.
7. Try to use your device.

If uninstalling and reinstalling the device drivers does not correct the problem, you may need to update your drivers using the procedures in the following section.

## Obtaining the latest HP device drivers

Follow either of the following procedures to obtain HP device drivers.

To use HP Support Assistant:

1. Select **Start > All Programs > HP > HP Support Assistant > Maintenance: Software Updates**.
2. On the HP Welcome screen, click **Settings**, and then select a time when the utility should check for software updates on the Web.
3. Click **Next** to immediately check for HP software updates.

To use the HP Web site to obtain HP device drivers:

1. Open your Internet browser, go to <http://www.hp.com/support>, and then select your country or region.
2. Click the option for software and driver downloads, and then type your computer model number in the product box.
3. Press **enter**, and then follow the on-screen instructions.

### Obtaining Microsoft device drivers

You can obtain the latest Windows device drivers by using Windows Update. This Windows feature can be set to automatically check for and install updates for your hardware drivers, as well as for the Windows operating system and other Microsoft products.

To use Windows Update:

1. Click **Start > All Programs > Windows Update**.

---

 **NOTE:** If you have not previously set up Windows Update, you will be prompted to enter settings before you can check for updates.

---

2. Click **Check for updates**.
3. Follow the on-screen instructions.

# Webcam

 **NOTE:** This section describes features that are common to most models. Some features may not be available on your computer.

Your computer includes an integrated webcam, located at the top of the display. With the preinstalled software, you can use the webcam to take a photo, record a video, or make an audio recording. You can preview the photo, video recording, or audio recording, and save it on your computer hard drive.

To access the webcam and HP Webcam software, select **Start > All Programs > HP > HP Webcam**.

The webcam software enables you to experiment with the following features:

- Video—Record and play back webcam video.
- Audio—Record and play back audio.
- Streaming video—Use with instant message software solutions that support UVC (Universal Video Class) cameras.
- Snapshots—Take still photos.

## Webcam tips

For optimum performance, observe the following guidelines while using the webcam:

- Be sure that you have the latest version of an instant message program before starting a video conversation.
- The webcam may not work properly across some network firewalls.

 **NOTE:** If you are having trouble viewing or sending multimedia files to someone on another LAN or outside your network firewall, temporarily disable the firewall, perform the task you want to perform, and then reenable the firewall. To permanently resolve the problem, reconfigure the firewall as necessary, and adjust the policies and settings of other intrusion detection systems. For additional information, contact your network administrator or IT department.

- Whenever possible, place bright light sources behind the webcam and out of the picture area.

 **NOTE:** For details about using your webcam, click the **Help** menu in the webcam software Help.

## Adjusting webcam properties

You can adjust webcam properties using the Properties dialog box, which is accessible from various programs that use the integrated webcam, usually from a configuration, settings, or properties menu:

- **Brightness**—Controls the amount of light that is incorporated into the image. A higher brightness setting creates a brighter image; a lower brightness setting creates a darker image.
- **Contrast**—Controls the difference between lighter and darker areas on the image. A higher contrast setting intensifies the image; a lower contrast setting maintains more of the original information's dynamic range, but leads to a flatter image.
- **Hue**—Controls the aspect of color that distinguishes it from another color (what makes a color red, green, or blue). Hue is distinct from saturation, which measures the intensity of the hue.
- **Saturation**—Controls the strength of color in the final image. A higher saturation setting creates a bolder image; a lower saturation setting creates a more subtle image.

- **Sharpness**—Controls the definition of edges in an image. A higher sharpness setting creates a more defined image; a lower sharpness setting creates a softer image.
- **Gamma**—Controls the contrast affecting the mid-level grays or midtones of an image. Adjusting the gamma of an image allows you to change the brightness values of the middle range of gray tones without dramatically altering the shadows and highlights. A lower gamma setting makes grays look black, and makes dark colors even darker.

For information about using the webcam, select **Start > Help and Support**.



---

# 5 Power management

## Setting power options

### Using power-saving states

The computer has two power-saving states enabled at the factory: Sleep and Hibernation.

When Sleep is initiated, the power lights blink and the screen clears. Your work is saved to memory. Exiting Sleep is faster than exiting Hibernation. If the computer is in the Sleep state for an extended period or if the battery reaches a critical battery level while in the Sleep state, the computer initiates Hibernation.

When Hibernation is initiated, your work is saved to a hibernation file on the hard drive and the computer turns off.

---

△ **CAUTION:** To prevent possible audio and video degradation, loss of audio or video playback functionality, or loss of information, do not initiate Sleep or Hibernation while reading from or writing to a disc or an external media card.

📝 **NOTE:** You cannot initiate any type of networking connection or perform any computer functions while the computer is in the Sleep state or in Hibernation.

---

### Initiating and exiting Sleep

The system is set at the factory to initiate Sleep after 15 minutes of inactivity when running on battery power and 30 minutes of inactivity when running on external power.

Power settings and timeouts can be changed using Power Options in Windows® Control Panel.

With the computer on, you can initiate Sleep in either of the following ways:

- Press **fn+f5**.
- Click **Start**, click the arrow next to the Shut down button, and then click **Sleep**.

To exit Sleep:

- ▲ Briefly press the power button.

When the computer exits Sleep, the power lights turn on and your work returns to the screen where you stopped working.

---

📝 **NOTE:** If you have set a password to be required when the computer exits Sleep, you must enter your Windows password before your work will return to the screen.

---

## Initiating and exiting Hibernation

The system is set at the factory to initiate Hibernation after 1080 minutes (18 hours) of inactivity when running on both battery power and external power, or when the battery reaches a critical battery level.

Power settings and timeouts can be changed using Power Options in Windows Control Panel.

To initiate Hibernation:

1. Click **Start**, and then click the arrow next to the Shut down button.
2. Click **Hibernate**.

To exit Hibernation:

- ▲ Briefly press the power button.

The power lights turn on and your work returns to the screen where you stopped working.

---

 **NOTE:** If you have set a password to be required when the computer exits Hibernation, you must enter your Windows password before your work will return to the screen.

---

## Using the battery meter

The battery meter is located in the notification area, at the far right of the taskbar. The battery meter allows you to quickly access power settings, view remaining battery charge, and select a different power plan.

- To display the percentage of remaining battery charge and the current power plan, move the pointer over the battery meter icon.
- To access Power Options, or to change the power plan, click the battery meter icon and select an item from the list.

Different battery meter icons indicate whether the computer is running on battery or external power. The icon also displays a message if the battery has reached a low battery level, critical battery level, or reserve battery level.

To hide or display the battery meter icon:

1. Click the **Show hidden icons** icon (the arrow at the left side of the notification area).
2. Click **Customize notification icons**.
3. Under **Behaviors**, select **Show icons and notifications** next to the Power icon.
4. Click **OK**.

## Using power plans

A power plan is a collection of system settings that manages how the computer uses power. Power plans can help you conserve power or maximize performance.

You can change power plan settings or create your own power plan.

## Viewing the current power plan

- ▲ Click the battery meter icon in the notification area, at the far right of the taskbar.

– or –

Select **Start > Control Panel > System and Security > Power Options**.

## Selecting a different power plan

- ▲ Click the battery meter icon in the notification area, and then select a power plan from the list.

– or –

Select **Start > Control Panel > System and Security > Power Options**, and then select a power plan from the list.

## Customizing power plans

1. Click the battery meter icon in the notification area and then click **More power options**.

– or –

Select **Start > Control Panel > System and Security > Power Options**.

2. Select a power plan, and then click **Change plan settings**.
3. Change the settings as needed.
4. To change additional settings, click **Change advanced power settings** and make your changes.

## Setting password protection on wakeup

To set the computer to prompt for a password when the computer exits Sleep or Hibernation, follow these steps:

1. Select **Start > Control Panel > System and Security > Power Options**.
2. In the left pane, click **Require a password on wakeup**.
3. Click **Change Settings that are currently unavailable**.
4. Click **Require a password (recommended)**.

---

 **NOTE:** If you need to create a user account password or change your current user account password, click **Create or change your user account password**, and then follow the on-screen instructions. If not, go to step 5.

---

5. Click **Save changes**.

## Using external AC power

External AC power is supplied through one of the following devices:

---

⚠ **WARNING!** To reduce potential safety issues, use only the AC adapter provided with the computer, a replacement AC adapter provided by HP, or a compatible AC adapter purchased from HP.

---

- Approved AC adapter
- Optional docking device or optional expansion product

Connect the computer to external AC power under any of the following conditions:

---

⚠ **WARNING!** Do not charge the computer battery while you are onboard an aircraft.

---

- When you are charging or calibrating a battery
- When you are installing or modifying system software
- When you are writing information to a CD, or DVD.

When you connect the computer to external AC power, the following events occur:

- The battery begins to charge.
- If the computer is turned on, the battery meter icon in the notification area changes appearance.

When you disconnect external AC power, the following events occur:

- The computer switches to battery power.
- The display brightness is automatically decreased to save battery life. To increase display brightness, press the **fn+f3** hotkey or reconnect the AC adapter.

## Connecting the AC adapter

---

⚠ **WARNING!** To reduce the risk of electric shock or damage to the equipment:

---

Plug the power cord into an AC outlet that is easily accessible at all times.

Disconnect power from the computer by unplugging the power cord from the AC outlet (not by unplugging the power cord from the computer).

If provided with a 3-pin attachment plug on the power cord, plug the cord into a grounded (earthed) 3-pin outlet. Do not disable the power cord grounding pin, for example, by attaching a 2-pin adapter. The grounding pin is an important safety feature.

---

To connect the computer to external AC power, follow these steps:

1. Plug the AC adapter into the power connector **(1)** on the computer.
2. Plug the power cord into the AC adapter **(2)**.

3. Plug the other end of the power cord into an AC outlet (3).

 **NOTE:** Your computer may look slightly different from the illustration in this section.

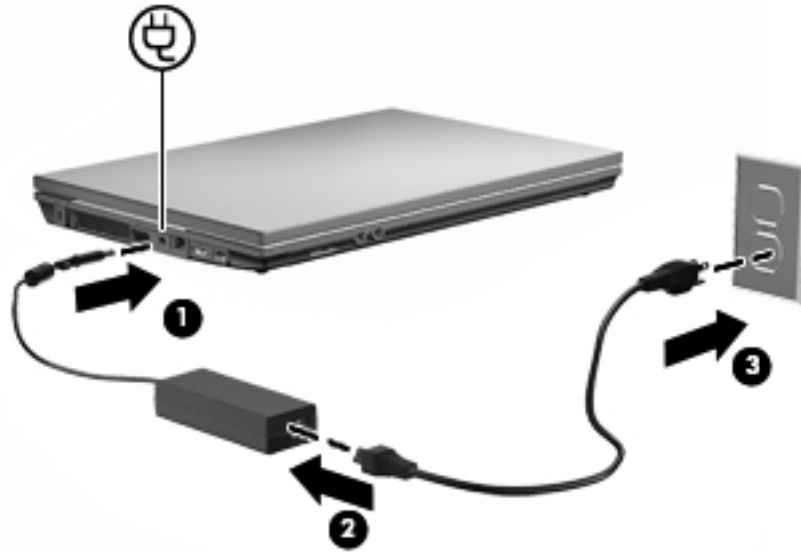

## Using battery power

When a charged battery is in the computer and the computer is not plugged into external power, the computer runs on battery power. When the computer is plugged into external AC power, the computer runs on AC power.

If the computer contains a charged battery and is running on external AC power supplied through the AC adapter, the computer switches to battery power if the AC adapter is disconnected from the computer.

 **NOTE:** The display brightness is decreased to save battery life when you disconnect AC power. To increase display brightness, use the **fn+f3** hotkey or reconnect the AC adapter.

You can keep a battery in the computer or in storage, depending on how you work. Keeping the battery in the computer whenever the computer is plugged into AC power charges the battery and also protects your work in case of a power outage. However, a battery in the computer slowly discharges when the computer is off and unplugged from external power.

 **WARNING!** To reduce potential safety issues, use only the battery provided with the computer, a replacement battery provided by HP, or a compatible battery purchased from HP.

Computer battery life varies, depending on power management settings, programs running on the computer, display brightness, external devices connected to the computer, and other factors.

## Using Battery Check

Battery Check provides information on the status of the battery installed in the computer.

To run Battery Check:

1. Connect the AC adapter to the computer.

 **NOTE:** The computer must be connected to external power for Battery Check to function properly.

2. Select **Start > Help and Support > Troubleshoot: Diagnostics > Power, Thermal and Mechanical > Power > Battery Check**.

Battery Check examines the battery and its cells to see if they are functioning properly, and then reports the results of the examination.

## Displaying the remaining battery charge

- ▲ Move the pointer over the battery meter icon in the notification area, at the far right of the taskbar.

## Inserting or removing the battery

- △ **CAUTION:** Removing a battery that is the sole power source can cause loss of information. To prevent loss of information, save your work, and initiate Hibernation or shut down the computer through Windows before removing the battery.

To insert the battery:

1. Turn the computer upside down on a flat surface, with the battery bay toward you.
2. Insert the battery into the battery bay (1) until it is seated.

The battery release latch (2) automatically locks the battery into place.

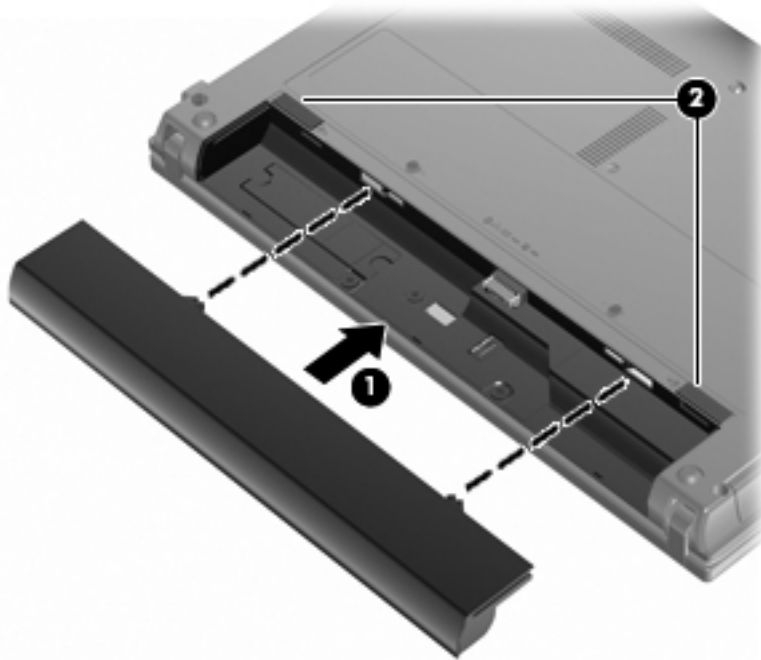

To remove the battery:

1. Turn the computer upside down on a flat surface, with the battery bay toward you.
2. Slide the battery release latch (1) to release the battery.
3. Remove the battery (2).

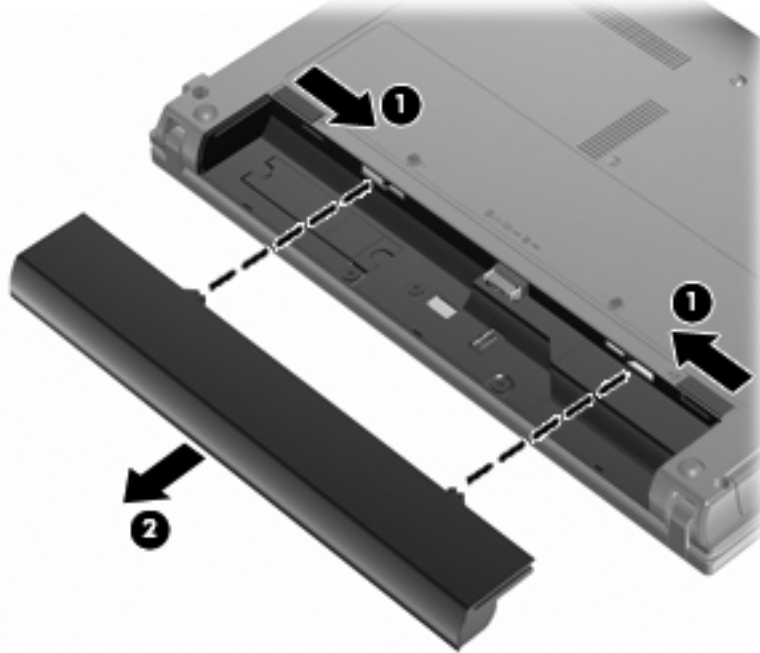

## Charging a battery

**⚠ WARNING!** Do not charge the computer battery while you are onboard aircraft.

The battery charges whenever the computer is plugged into external power through an AC adapter, an optional power adapter, an optional expansion product, or an optional docking device.

The battery charges whether the computer is off or in use, but it charges faster when the computer is off.

Charging may take longer if a battery is new, has been unused for 2 weeks or more, or is much warmer or cooler than room temperature.

To prolong battery life and optimize the accuracy of battery charge displays, follow these recommendations:

- If you are charging a new battery, charge it fully before turning on the computer.
- Charge the battery until the battery light turns off.

**📝 NOTE:** If the computer is on while the battery is charging, the battery meter in the notification area may show 100 percent charge before the battery is fully charged.

- Allow the battery to discharge below 5 percent of a full charge through normal use before charging it.
- If the battery has been unused for one month or more, calibrate the battery instead of simply charging it.

The battery light displays charge status:

- On: The battery is charging.
- Blinking: The battery has reached a low battery level or critical battery level and is not charging.
- Off: The battery is fully charged, in use, or not installed.

## Maximizing battery discharge time

Battery discharge time varies, depending on the features you use while on battery power. Maximum discharge time gradually shortens as the battery storage capacity naturally degrades.

Tips for maximizing battery discharge time:

- Lower the brightness on the display.
- Check the **Power saver** setting in Power Options.
- Remove the battery from the computer when it is not being used or charged.
- Store the battery in a cool, dry location.

## Managing low battery levels

The information in this section describes the alerts and system responses set at the factory. Some low-battery alerts and system responses can be changed using Power Options in Windows Control Panel (**Start > Control Panel > System and Security > Power Options**). Preferences set using Power Options do not affect lights.

### Identifying low battery levels

When a battery that is the sole power source for the computer reaches a low battery level, the battery light blinks.

If a low battery level is not resolved, the computer enters a critical battery level, and the battery light blinks rapidly.

The computer takes the following actions for a critical battery level:

- If Hibernation is enabled and the computer is on or in the Sleep state, the computer initiates Hibernation.
- If Hibernation is disabled and the computer is on or in the Sleep state, the computer remains briefly in the Sleep state, and then shuts down and loses any unsaved information.

### Resolving a low battery level

---

△ **CAUTION:** To reduce the risk of losing information when the computer reaches a critical battery level and has initiated Hibernation, do not restore power until the power lights turn off.

---



## Resolving a low battery level when external power is available

- ▲ Connect one of the following devices:
  - AC adapter
  - Optional expansion product or optional docking device
  - Optional power adapter

## Resolving a low battery level when a charged battery is available

1. Turn off the computer or initiate Hibernation.
2. Remove the discharged battery, and then insert a charged battery.
3. Turn on the computer.

## Resolving a low battery level when no power source is available

- ▲ Initiate Hibernation.
  - or –
  - Save your work and shut down the computer.

## Resolving a low battery level when the computer cannot exit Hibernation

When the computer lacks sufficient power to exit Hibernation, follow these steps:

1. Insert a charged battery or plug the computer into external power.
2. Exit Hibernation by briefly pressing the power button.

## Calibrating a battery

Calibrate a battery under the following conditions:

- When battery charge displays seem inaccurate
- When you observe a significant change in battery run time

Even if a battery is heavily used, it should not need to be calibrated more than once a month. It is also not necessary to calibrate a new battery.

### Step 1: Fully charge the battery

---

⚠ **WARNING!** Do not charge the computer battery while you are onboard aircraft.

📝 **NOTE:** The battery charges whether the computer is off or in use, but it charges faster when the computer is off.

---

To fully charge the battery:

1. Insert the battery into the computer.
2. Connect the computer to an AC adapter, optional power adapter, optional expansion product, or optional docking device, and then plug the adapter or device into external power.

The battery light on the computer turns on.

3. Leave the computer plugged into external power until the battery is fully charged.

The battery light on the computer turns off.

## Step 2: Disable Hibernation and Sleep

1. Click the battery meter icon in the notification area, and then click **More power options**.

– or –

Select **Start > Control Panel > System and Security > Power Options**.

2. Under the current power plan, click **Change plan settings**.
3. Record the **Turn off the display** and **Put the computer to sleep** settings listed in the **On battery** column so that you can reset them after the calibration.
4. Change the **Turn off the display** and **Put the computer to sleep** settings to **Never**.
5. Click **Change advanced power settings**.
6. Click the plus sign next to **Sleep**, and then click the plus sign next to **Hibernate after**.
7. Record the **On battery** setting under **Hibernate after** so that you can reset it after the calibration.
8. Change the **On battery** setting to **Never**.
9. Click **OK**.
10. Click **Save changes**.

## Step 3: Discharge the battery

The computer must remain on while the battery is being discharged. The battery can discharge whether or not you are using the computer, but the battery will discharge faster while you are using it.

- If you plan to leave the computer unattended during the discharge, save your information before beginning the discharge procedure.
- If you use the computer occasionally during the discharge procedure and have set energy-saving timeouts, expect the following performance from the system during the discharge process:
  - The monitor will not turn off automatically.
  - Hard drive speed will not decrease automatically when the computer is idle.
  - System-initiated Hibernation will not occur.

To discharge a battery:

1. Unplug the computer from its external power source, but do *not* turn off the computer.
2. Run the computer on battery power until the battery is discharged. The battery light begins to blink when the battery has discharged to a low battery level. When the battery is discharged, the battery light turns off and the computer shuts down.

## Step 4: Fully recharge the battery

To recharge the battery:

1. Plug the computer into external power and maintain external power until the battery is fully recharged. When the battery is recharged, the battery light on the computer turns off.

You can use the computer while the battery is recharging, but the battery will charge faster if the computer is off.

2. If the computer is off, turn it on when the battery is fully charged and the battery light has turned off.

## Step 5: Reenable Hibernation and Sleep

△ **CAUTION:** Failure to reenable Hibernation after calibration may result in a full battery discharge and information loss if the computer reaches a critical battery level.

1. Click the battery meter icon in the notification area, and then click **More power options**.

– or –

Select **Start > Control Panel > System and Security > Power Options**.

2. Under the current power plan, click **Change plan settings**.
3. Reenter the settings that you recorded for the items in the **On battery** column.
4. Click **Change advanced power settings**.
5. Click the plus sign next to **Sleep**, and then click the plus sign next to **Hibernate after**.
6. Reenter the setting that you recorded for **On battery**.
7. Click **OK**.
8. Click **Save changes**.

## Conserving battery power

- Select the Power saver power plan through Power Options under **System and Security** in Windows Control Panel.
- Turn off wireless and local area network (LAN) connections and exit modem applications when you are not using them.
- Disconnect external devices that are not plugged into an external power source, when you are not using them.
- Stop, disable, or remove any external media cards that you are not using.

- Use the **fn+f2** and **fn+f3** hotkeys to adjust screen brightness as needed.
- If you leave your work, initiate Sleep or Hibernation, or shut down the computer.

## Storing a battery

---

△ **CAUTION:** To prevent damage to a battery, do not expose it to high temperatures for extended periods of time.

---

If a computer will be unused and unplugged from external power for more than 2 weeks, remove the battery and store it separately.

To prolong the charge of a stored battery, place it in a cool, dry place.

---

📖 **NOTE:** A stored battery should be checked every 6 months. If the capacity is less than 50 percent, recharge the battery before returning it to storage.

---

Calibrate a battery before using it if it has been stored for one month or more.

## Disposing of a used battery

---

△ **WARNING!** To reduce the risk of fire or burns, do not disassemble, crush, or puncture; do not short external contacts; do not dispose of in fire or water.

---

For additional information, refer to the *Regulatory, Safety and Environmental Notices* included with this computer.

## Replacing the battery

Computer battery life varies, depending on the power management settings, programs running on the computer, display brightness, external devices connected to the computer, and other factors.

Battery Check notifies you to replace the battery when an internal cell is not charging properly, or when the battery storage capacity has reached a “weak” condition. A message refers you to the HP Web site for more information about ordering a replacement battery. If the battery is possibly covered by an HP warranty, instructions include a warranty ID.

---

📖 **NOTE:** To ensure that you always have battery power when you need it, HP recommends purchasing a new battery when the storage capacity indicator turns green-yellow.

---

## Testing an AC adapter

Test the AC adapter if the computer exhibits any of the following symptoms:

- The computer will not turn on when connected to the AC adapter.
- The display does not turn on when the computer is connected to the AC adapter and external power.
- The power light is off when the computer is connected to the AC adapter.

To test the AC adapter:

1. Remove the battery from the computer.
2. Connect the AC adapter to the computer and to an AC outlet.
3. Turn on the computer.
  - If the power light turns **on**, the AC adapter is functioning properly.
  - If the power light remains **off**, the AC adapter is not functioning and should be replaced.

Contact technical support for information on obtaining a replacement AC power adapter. Select **Start > Help and Support > Get assistance**.

## Shutting down the computer

---

△ **CAUTION:** Unsaved information will be lost when the computer is shut down.

---

The Shut down command closes all open programs, including the operating system, and then turns off the display and computer.

Shut down the computer under any of the following conditions:

- When you need to replace the battery or access components inside the computer
- When you are connecting an external hardware device that does not connect to a USB port
- When the computer will be unused and disconnected from external power for an extended period

Although you can shut down the computer with the power button, the recommended procedure is to use the Windows Shut down command.

To shut down the computer, follow these steps:

---

 **NOTE:** If the computer is in the Sleep state or in Hibernation, you must first exit Sleep or Hibernation before shutdown is possible.

---

1. Save your work and close all open programs.
2. Click **Start**.
3. Click **Shut down**.

If the computer is unresponsive and you are unable to use the preceding shutdown procedures, try the following emergency procedures in the sequence provided:

- Press `ctrl+alt+delete`, and then click the **Power** button.
- Press and hold the power button for at least 5 seconds.
- Disconnect the computer from external power and remove the battery.

---

# 6 Drives

## Identifying installed drives

To view the drives installed on the computer, select **Start > Computer**.

---

 **NOTE:** Windows includes the User Account Control feature to improve the security of your computer. You may be prompted for your permission or password for tasks such as installing software, running utilities, or changing Windows settings. Refer to Windows Help and Support for more information.

---

## Handling drives

Drives are fragile computer components that must be handled with care. Refer to the following cautions before handling drives. Additional cautions are included with the procedures to which they apply.

---

△ **CAUTION:** To reduce the risk of damage to the computer, damage to a drive, or loss of information, observe these precautions:

Before you move a computer that is connected to an external hard drive, initiate Sleep and allow the screen to clear, or properly disconnect the external hard drive.

Before handling a drive, discharge static electricity by touching the unpainted metal surface of the drive.

Do not touch the connector pins on a removable drive or on the computer.

Handle a drive carefully; do not drop a drive or place items on it.

Before removing or inserting a drive, shut down the computer. If you are unsure whether the computer is off or in Hibernation, turn the computer on and then shut it down through the operating system.

Do not use excessive force when inserting a drive into a drive bay.

Do not type on the keyboard or move the computer while the optical drive (select models only) is writing to a disc. The write process is sensitive to vibration.

When the battery is the only source of power, be sure that the battery is sufficiently charged before writing to media.

Avoid exposing a drive to temperature or humidity extremes.

Avoid exposing a drive to liquids. Do not spray the drive with cleaning products.

Remove media from a drive before removing the drive from the drive bay, or traveling with, shipping, or storing a drive.

If a drive must be mailed, place the drive in a bubble-pack mailer or other suitable protective packaging and label the package "FRAGILE."

Avoid exposing a drive to magnetic fields. Security devices with magnetic fields include airport walk-through devices and security wands. The airport security devices that check carry-on luggage, such as conveyor belts, use X-rays instead of magnetism and will not damage a drive.

---



# Improving hard drive performance

## Using Disk Defragmenter

As you use the computer, files on the hard drive become fragmented. Disk Defragmenter consolidates the fragmented files and folders on the hard drive so that the system can run more efficiently.

After you start Disk Defragmenter, it works without supervision. Depending on the size of your hard drive and the number of fragmented files, Disk Defragmenter may take more than an hour to complete. You may want to set it to run during the night or another time when you do not need access to your computer.

HP recommends defragmenting your hard drive at least once a month. You may set Disk Defragmenter to run on a monthly schedule, but you can defragment your computer manually at any time.

To run Disk Defragmenter:

1. Select **Start > All Programs > Accessories > System Tools > Disk Defragmenter**.
2. Click **Defragment disk**.

---

 **NOTE:** Windows includes the User Account Control feature to improve the security of your computer. You may be prompted for your permission or password for tasks such as installing software, running utilities, or changing Windows settings. Refer to Windows Help and Support for more information.

---

For additional information, access the Disk Defragmenter software Help.

## Using Disk Cleanup

Disk Cleanup searches the hard drive for unnecessary files that you can safely delete to free up disk space and help the computer to run more efficiently.

To run Disk Cleanup:

1. Select **Start > All Programs > Accessories > System Tools > Disk Cleanup**.
2. Follow the on-screen instructions.

## Using external drives

Removable external drives expand your options for storing and accessing information.

USB drives include the following types:

- 1.44-megabyte diskette drive
- Hard drive module (a hard drive with an adapter attached)
- DVD-ROM Drive
- DVD+/-RW SuperMulti Double-Layer LightScribe Drive
- Blu-ray ROM DVD+/-RW SuperMulti Double-Layer LightScribe Drive

## Using optional external devices

---

 **NOTE:** For more information about required software and drivers, or to learn which computer port to use, refer to the manufacturer's instructions.

---

To connect an external device to the computer:

 **CAUTION:** To reduce the risk of damage to the equipment when connecting a powered device, be sure that the device is turned off and the AC power cord is unplugged.

---

1. Connect the device to the computer.
2. If you are connecting a powered device, plug the device power cord into a grounded AC outlet.
3. Turn on the device.

To disconnect an unpowered external device, turn off the device, and then disconnect it from the computer. To disconnect a powered external device, turn off the device, disconnect it from the computer, and then unplug the AC power cord.

# Replacing the hard drive

△ **CAUTION:** To prevent information loss or an unresponsive system:

Shut down the computer before removing the hard drive from the hard drive bay. Do not remove the hard drive while the computer is on, in the Sleep state, or in Hibernation.

If you are not sure whether the computer is off or in Hibernation, turn the computer on by pressing the power button. Then, shut down the computer through the operating system.

To remove a hard drive:

1. Save your work.
2. Shut down the computer and close the display.
3. Disconnect all external hardware devices connected to the computer.
4. Unplug the power cord from the AC outlet.
5. Turn the computer upside down on a flat surface, with the hard drive bay toward you.
6. Remove the battery from the computer.
7. Loosen the bottom door screws (1).
8. Slide the bottom door forward (2), and then lift it away from the computer (3).

📄 **NOTE:** Refer to the illustration that most closely matches your computer.

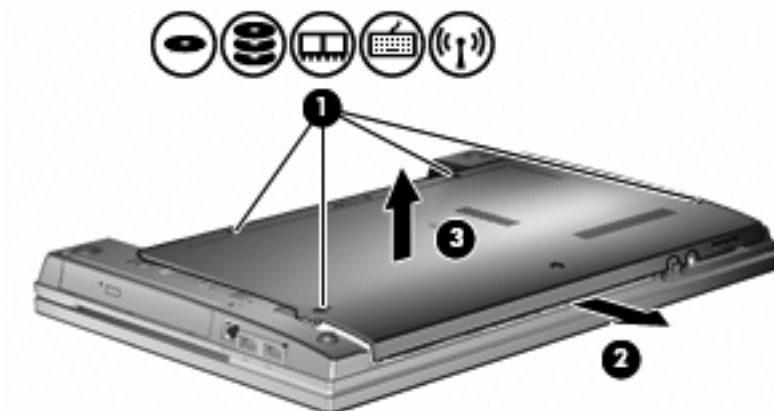
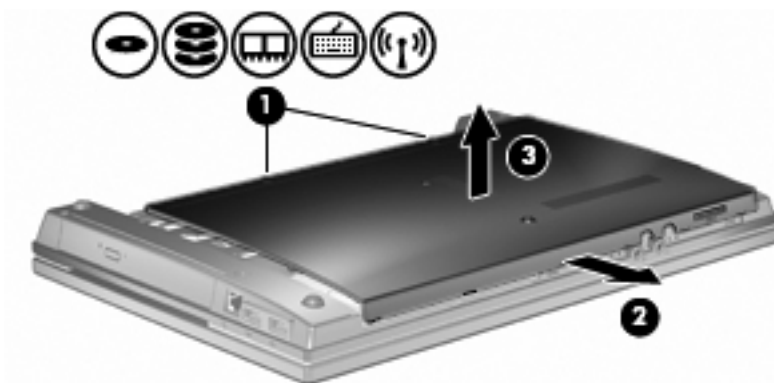

9. Remove the 2 screws securing the rear of the drive (1).

10. Loosen the hard drive screw (2).
11. Pull the hard drive tab (3) to the left to disconnect the hard drive.
12. Lift the hard drive (4) out of the hard drive bay.

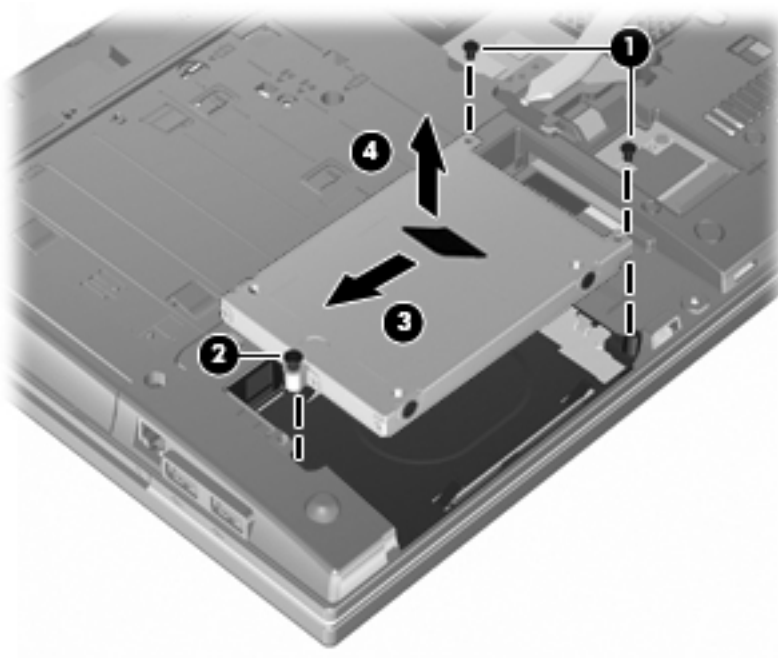

To install a hard drive:

1. Insert the hard drive into the hard drive bay (1).
2. Pull the hard drive tab (2) to the right to connect the hard drive.
3. Tighten the hard drive screw (3).

4. Replace and secure the 2 screws at the rear of the drive.

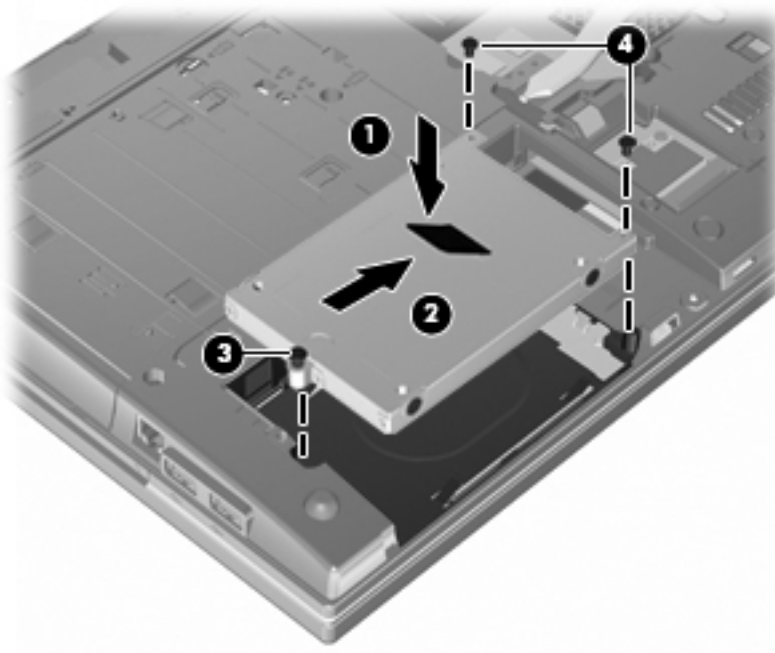

5. Replace the bottom door (1) sliding it securely into place (2).

6. Tighten the bottom door screws (3).

 **NOTE:** Refer to the illustration that most closely matches your computer.

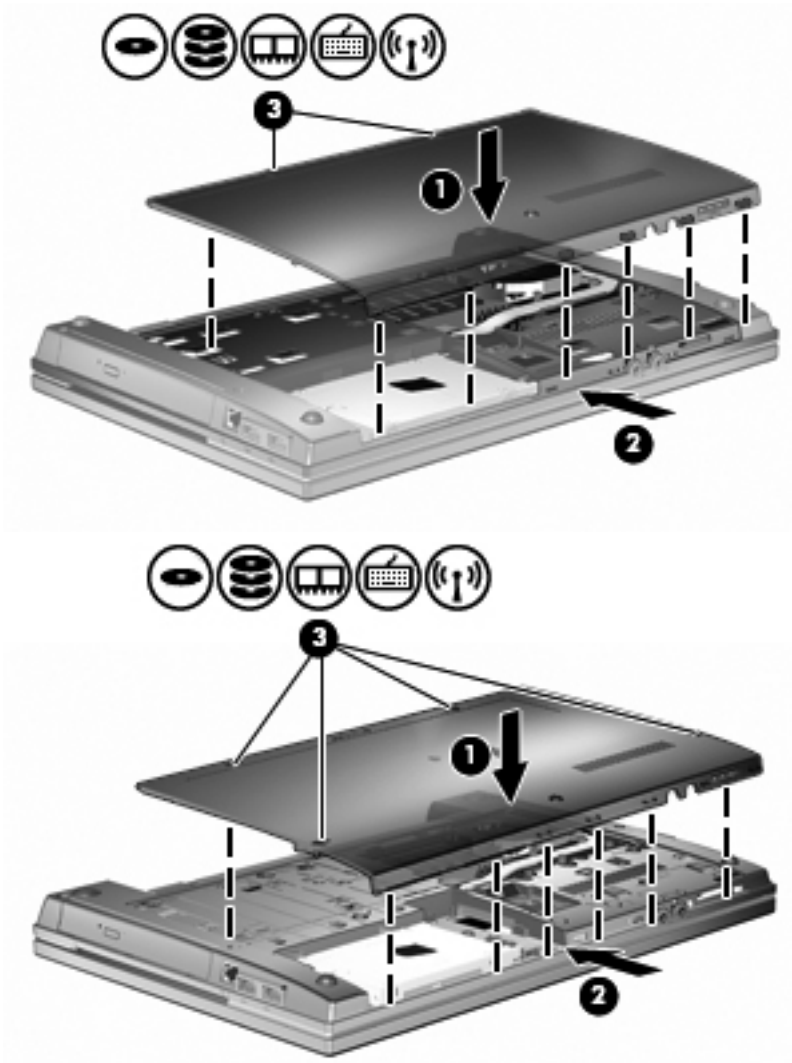

---

# 7 External devices

## Using a USB device

Universal Serial Bus (USB) is a hardware interface that can be used to connect an optional external device, such as a USB keyboard, mouse, drive, printer, scanner, or hub.

Some USB devices may require additional support software, which is usually included with the device. For more information about device-specific software, refer to the manufacturer's instructions.

Your computer model has 3 USB ports, which support USB 1.0, USB 1.1, and USB 2.0 devices. A USB hub provides additional USB ports that can be used with the computer.

## Connecting a USB device

---

△ **CAUTION:** To prevent damage to a USB connector, use minimal force to connect a USB device.

- ▲ To connect a USB device to the computer, connect the USB cable for the device to the USB port.



You will hear a sound when the device has been detected.

---

📄 **NOTE:** The first time you connect a USB device, a message is displayed in the notification area to let you know the device is recognized by the computer.

---

## Removing a USB device

---

△ **CAUTION:** To prevent loss of information or an unresponsive system, use the following procedure to safely remove a USB device.

**CAUTION:** To prevent damage to a USB connector, do not pull on the cable to remove the USB device.

---

To remove a USB device:

1. Click the **Safely Remove Hardware and Eject Media** icon in the notification area, at the far right of the taskbar.

 **NOTE:** To display the Safely Remove Hardware and Eject Media icon, click the **Show hidden icons** icon (the arrow at the left side of the notification area).

---

2. Click the name of the device in the list.

You are informed that it is safe to remove the hardware device.

3. Remove the device.

## Using USB legacy support

USB legacy support (enabled by default) permits the following actions:

- Using a USB keyboard, mouse, or hub connected to a USB port on the computer during startup or in an MS-DOS-based program or utility
- Starting or restarting from an optional external MultiBay or an optional USB bootable device

USB legacy support is enabled at the factory. To disable or enable USB legacy support:

1. Open Computer Setup by turning on or restarting the computer, and then pressing **f10** while the HP logo is displayed in the lower-left corner of the screen.
2. Use the tab key to select **System Configuration > Device configurations**, and then press **enter**.
3. Press **enter** and use the arrow keys to enable or disable USB legacy support, and then press **f10**.
4. To save your preferences and exit Computer Setup, use the arrow keys to select **File > Save changes and exit**. Then follow the instructions on the screen.

Your preferences go into effect when the computer restarts.



## Using external drives

Removable external drives expand your options for storing and accessing information. A USB drive can be added by connecting the drive to a USB port on the computer.

USB drives include the following types:

- 1.44-megabyte diskette drive
- Hard drive module (a hard drive with an adapter attached)
- DVD-ROM Drive
- DVD+/-RW SuperMulti DL LightScribe Drive
- Blu-ray ROM DVD+/-RW SuperMulti DL LightScribe Drive

## Using optional external devices

---

 **NOTE:** For more information about required software and drivers, or to learn which computer port to use, refer to the manufacturer's instructions.

---

To connect an external device to the computer:

 **CAUTION:** To reduce the risk of damage to the equipment when connecting a powered device, be sure that the device is turned off and the AC power cord is unplugged.

---

1. Connect the device to the computer.
2. If you are connecting a powered device, plug the device power cord into a grounded AC outlet.
3. Turn on the device.

To disconnect an unpowered external device, turn off the device, and then disconnect it from the computer. To disconnect a powered external device, turn off the device, disconnect it from the computer, and then unplug the AC power cord.

---

## 8 External media cards

### Using Media Card Reader cards

Optional digital cards provide secure data storage and convenient data sharing. These cards are often used with digital media-equipped cameras and PDAs, as well as with other computers.

The Digital Media Slot supports the following digital card formats:

- MultiMediaCard (MMC)
- MultiMedia Card 4.2
- Secure Digital (SD) Memory Card
- Secure Digital High Capacity (SDHC) Memory Card
- Secure Digital High Speed (SDHS) Memory Card

### Inserting a digital card

---

△ **CAUTION:** To avoid damaging the digital card or the computer, do not insert any type of adapter into the SD Card Reader.

**CAUTION:** To prevent damage to the digital card connectors, use minimal force to insert a digital card.

---

1. Hold the digital card label-side up, with the connectors facing the computer.

2. Insert the card into the Media Card Reader, and then push in on the card until it is firmly seated.

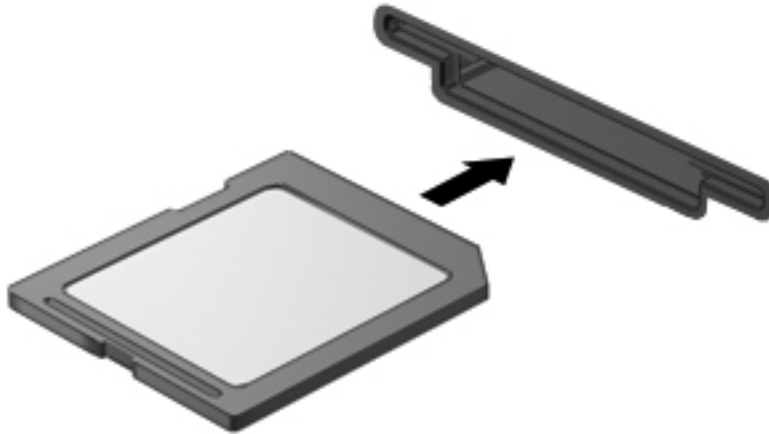

You will hear a sound when the device has been detected, and a menu of available options may be displayed.

## Removing a digital card

---

△ **CAUTION:** To prevent loss of data or an unresponsive system, use the following procedure to safely remove the digital card.

---

Save your information and close all programs associated with the digital card.

📄 **NOTE:** To stop a data transfer, click **Cancel** in the operating system Copying window.

---

To remove a digital card:

- ▲ To eject the digital card, press in on the card (1), and then remove it from the slot (2).

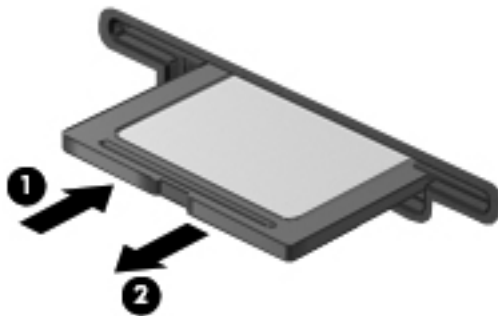

## Using ExpressCards (select models only)

An ExpressCard is a high-performance PC Card that is inserted into the ExpressCard slot.

Like standard PC Cards, ExpressCards are designed to conform to the standard specifications of the Personal Computer Memory Card International Association (PCMCIA).

### Configuring an ExpressCard

Install only the software required for your device. If you are instructed by the ExpressCard manufacturer to install device drivers:

- Install only the device drivers for your operating system.
- Do not install other software, such as card services, socket services, or enablers, supplied by the ExpressCard manufacturer.

### Inserting an ExpressCard

△ **CAUTION:** To prevent damage to the computer and external media cards, do not insert a PC Card into an ExpressCard slot.

**CAUTION:** To prevent damage to the connectors:

Use minimal force when inserting an ExpressCard.

Do not move or transport the computer when an ExpressCard is in use.

The ExpressCard slot may contain a protective insert. To remove the insert:

1. Press in on the insert (1) to unlock it.
2. Pull the insert out of the slot (2).

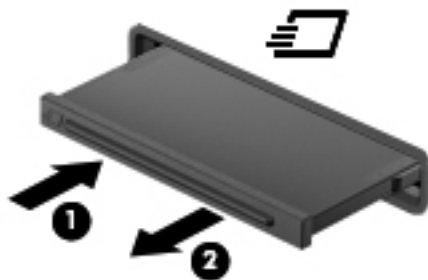

To insert an ExpressCard:

1. Hold the card label-side up, with the connectors facing the computer.

2. Insert the card into the ExpressCard slot, and then push in on the card until it is firmly seated.

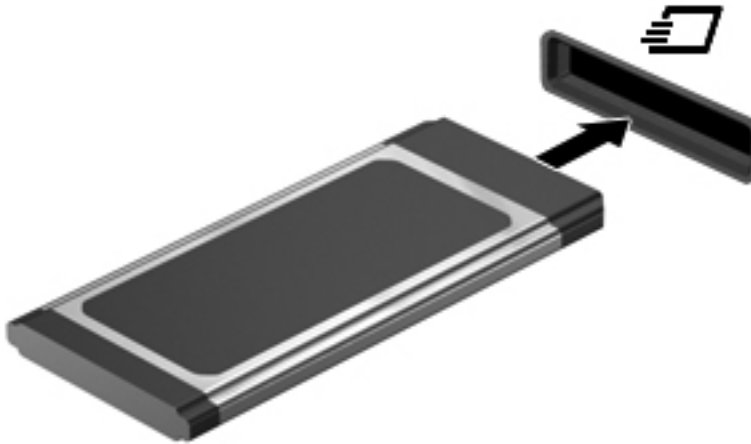

You will hear a sound when the device has been detected, and a menu of options may be displayed.

---

 **NOTE:** The first time you insert an ExpressCard, a message is displayed in the notification area to let you know the device is recognized by the computer.

---

 **NOTE:** An inserted ExpressCard uses power even when idle. To conserve power, stop or remove an ExpressCard when it is not in use.

---

## Removing an ExpressCard

---

 **CAUTION:** To prevent loss of data or an unresponsive system, use the following procedure to safely remove the ExpressCard.

---

Save your information and close all programs associated with the ExpressCard.

---

 **NOTE:** To stop a data transfer, click **Cancel** in the operating system Copying window.

---

To remove an ExpressCard:

1. Click the **Safely Remove Hardware and Eject Media** icon in the notification area, at the far right of the taskbar.

---

 **NOTE:** To display the Safely Remove Hardware and Eject Media icon, click the **Show hidden icons** icon (the arrow at the left side of the notification area).

---

2. Click the name of the ExpressCard in the list.

---

 **NOTE:** You are informed that it is safe to remove the hardware device.

---

3. Release and remove the ExpressCard:
  - a. Gently press in on the ExpressCard **(1)** to unlock it.
  - b. Pull the ExpressCard out of the slot **(2)**.

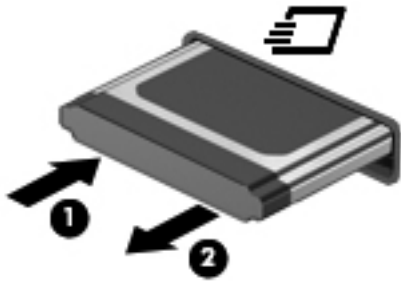

---

## 9 Memory modules

The computer has one memory module compartment, which is located on the bottom of the computer.

The memory capacity of the computer can be upgraded by adding a memory module to the vacant expansion memory module slot or by upgrading the existing memory module in the primary memory module slot.

All memory modules installed in the computer must be the same type. When upgrading memory capacity, verify that the upgrade modules are the same type as those already installed in the computer.

- 
- △ **WARNING!** To reduce the risk of electric shock and damage to the equipment, unplug the power cord and remove all batteries before installing a memory module.
  - △ **CAUTION:** Electrostatic discharge (ESD) can damage electronic components. Before beginning any procedure, touch a grounded metal object to be sure that you are discharged of static electricity.
-

# Adding or replacing a memory module in the expansion memory module slot

The expansion memory module slot is stacked above the primary memory module slot. To add or replace a memory module in the expansion memory module slot, follow these steps:

1. Save your work.
2. Shut down the computer and close the display.  
  
If you are not sure whether the computer is off or in Hibernation, turn the computer on by pressing the power button. Then shut down the computer through the operating system.
3. Disconnect all external devices connected to the computer.
4. Unplug the power cord from the AC outlet.
5. Turn the computer upside down on a flat surface.
6. Remove the battery from the computer.
7. Loosen the bottom door screws (1).
8. Slide the bottom door forward (2), and then lift it (3) away from the computer.

 **NOTE:** Refer to the illustration that most closely matches your computer.

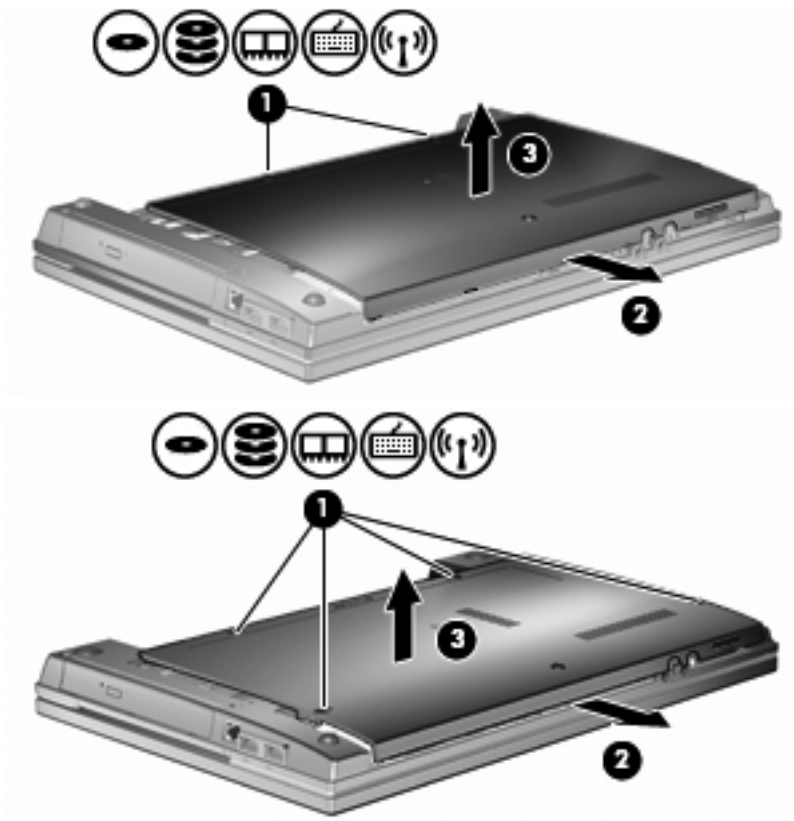



9. Remove the memory module from the expansion memory slot:
  - a. Pull away the retention clips (1) on each side of the memory module.  
The memory module tilts up.

△ **CAUTION:** To prevent damage to the memory module, hold the memory module by the edges only. Do not touch the components on the memory module.

- b. Grasp the edge of the memory module (2), and gently pull the module out of the memory module slot.

To protect a memory module after removal, place it in an electrostatic-safe container.

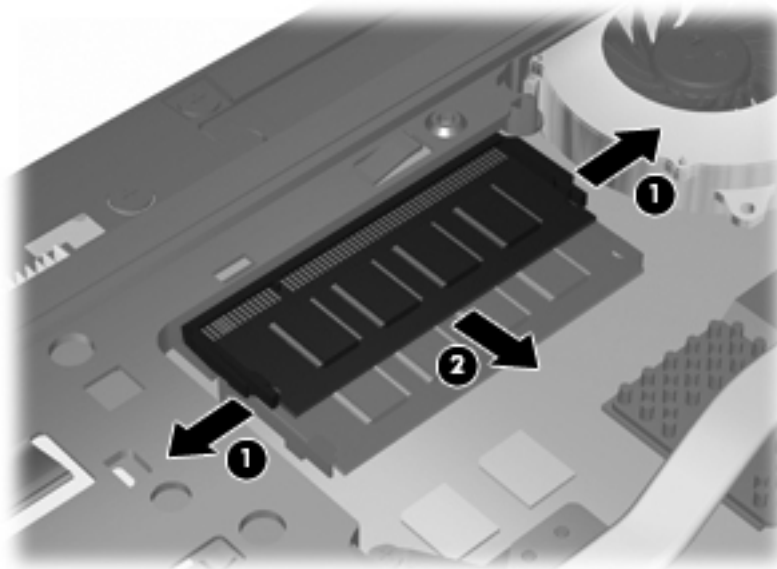

10. Insert a memory module in the expansion memory slot:
  - a. Align the notched edge (1) of the memory module with the tab in the memory module slot.  
△ **CAUTION:** To prevent damage to the memory module, hold the memory module by the edges only. Do not touch the components on the memory module, and do not bend the memory module.
  - b. With the memory module at a 45-degree angle from the surface of the memory module compartment, press the module (2) into the memory module slot until it is seated.

- c. Gently press the memory module **(3)** down, applying pressure to both the left and right edges of the memory module, until the retention clips snap into place.

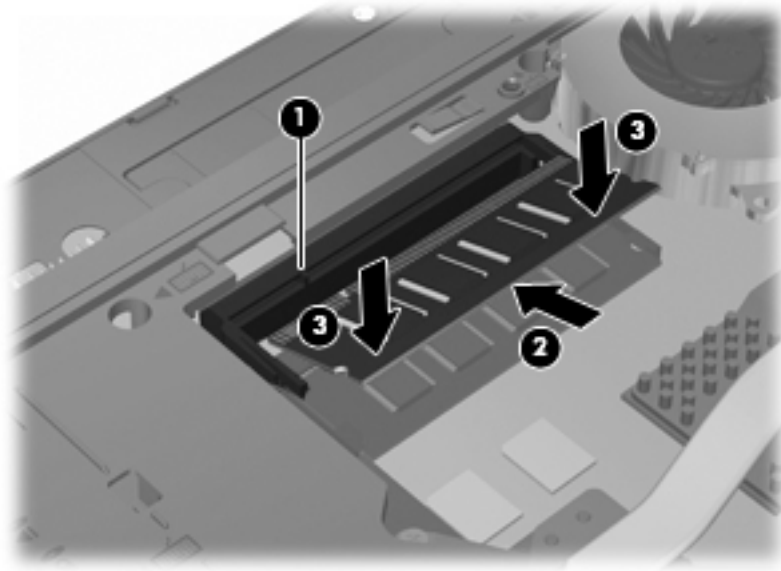

- 11. Replace the bottom door **(1)** sliding it securely into place **(2)**.

12. Tighten the bottom door screws (3).

 **NOTE:** Refer to the illustration that most closely matches your computer.

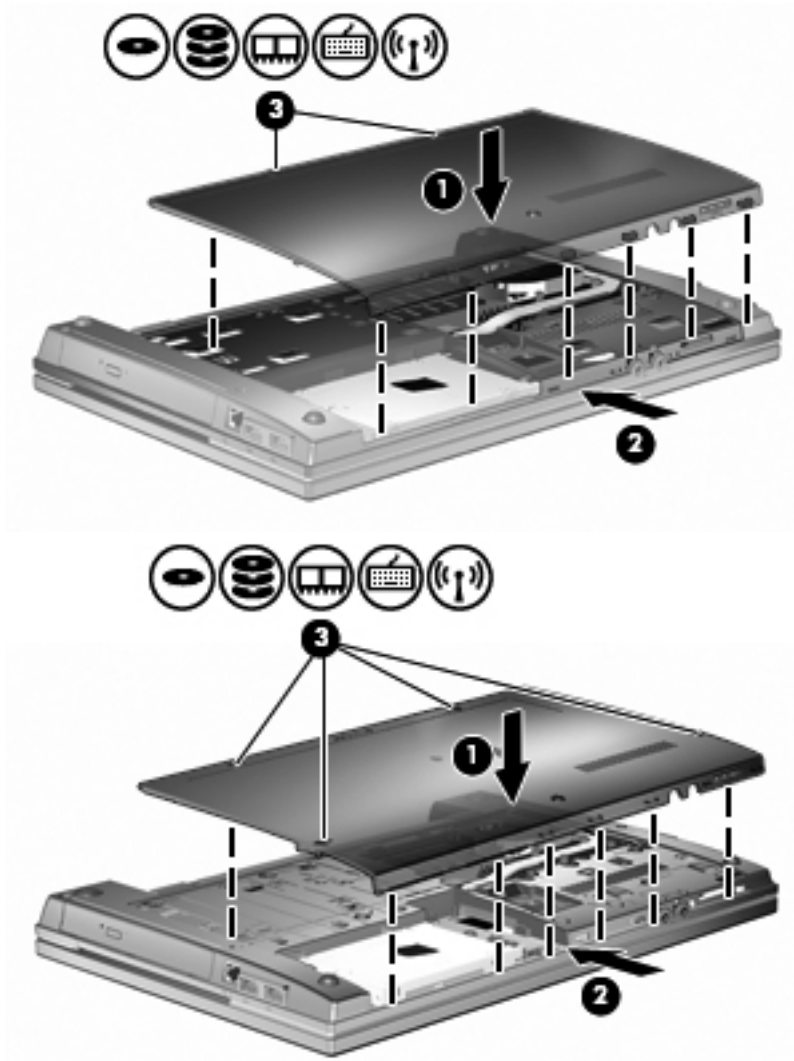

13. Replace the battery.
14. Turn the computer right-side up, and then reconnect external power and external devices.
15. Turn on the computer.

## Upgrading a memory module in the primary memory module slot

The expansion memory module slot is stacked above the primary memory module slot. To upgrade a memory module in the primary memory module slot, follow these steps:

1. Save your work.
2. Shut down the computer and close the display.  
If you are not sure whether the computer is off or in Hibernation, turn the computer on by pressing the power button. Then shut down the computer through the operating system.
3. Disconnect all external devices connected to the computer.
4. Unplug the power cord from the AC outlet.
5. Turn the computer upside down on a flat surface.
6. Remove the battery from the computer.
7. Loosen the bottom door screws (1).
8. Slide the bottom door forward (2), and then lift it (3) away from the computer.

 **NOTE:** Refer to the illustration that most closely matches your computer.

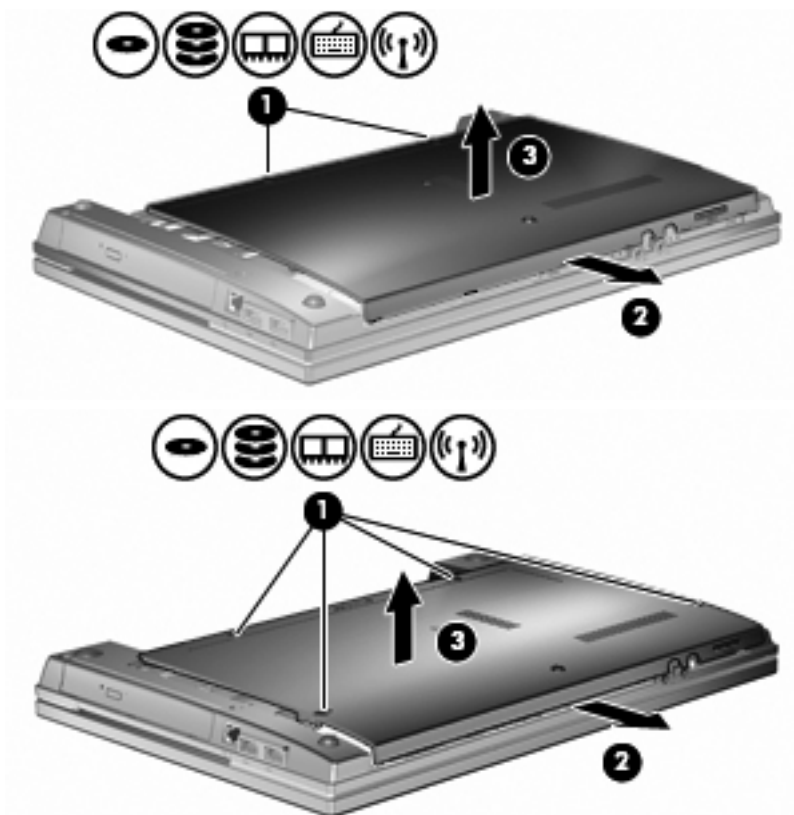

 **NOTE:** If a memory module is installed in the expansion memory module slot, first remove the expansion memory module.

9. Remove the memory module from the primary memory slot:
  - a. Pull away the retention clips (1) on each side of the memory module.

The memory module tilts up.

△ **CAUTION:** To prevent damage to the memory module, hold the memory module by the edges only. Do not touch the components on the memory module.

- b. Grasp the edge of the memory module (2), and gently pull the module out of the memory module slot.

To protect a memory module after removal, place it in an electrostatic-safe container.

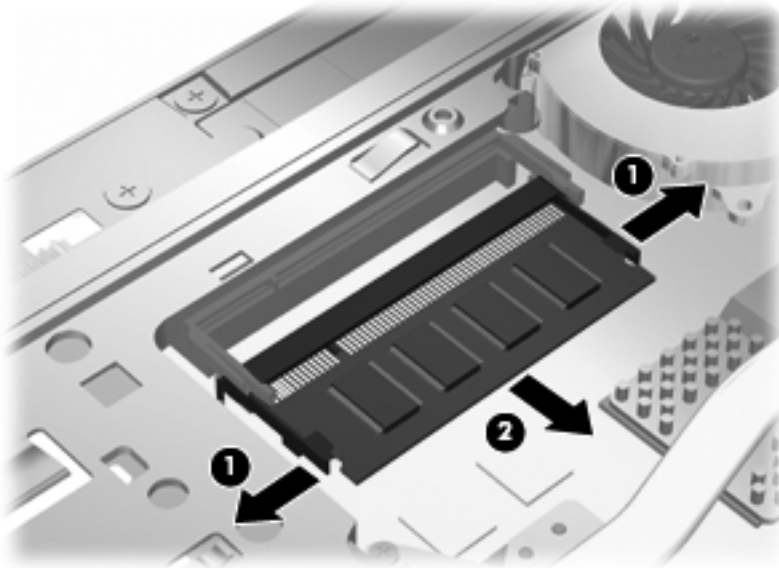



10. Insert a memory module in the primary memory module slot:
  - a. Align the notched edge (1) of the memory module with the tab in the memory module slot.

△ **CAUTION:** To prevent damage to the memory module, hold the memory module by the edges only. Do not touch the components on the memory module, and do not bend the memory module.

- b. With the memory module at a 45-degree angle from the surface of the memory module compartment, press the module (2) into the memory module slot until it is seated.

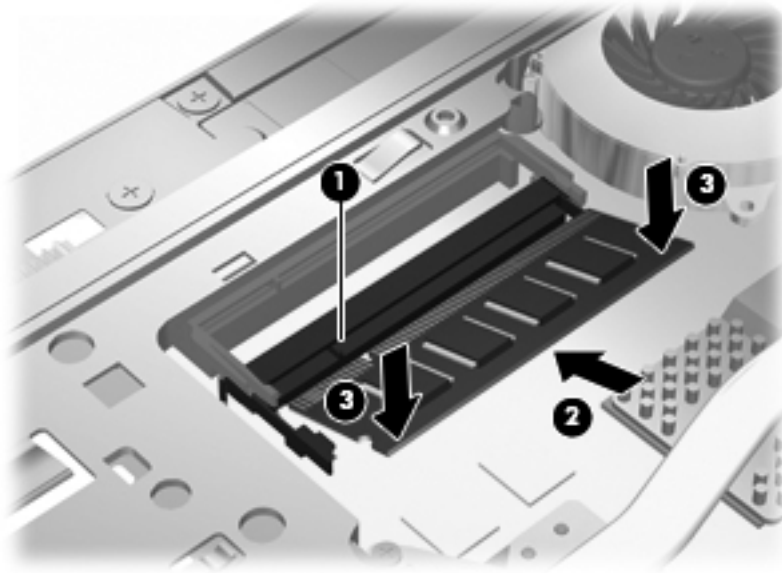
- c. Gently press the memory module **(3)** down, applying pressure to both the left and right edges of the memory module, until the retention clips snap into place.



 **NOTE:** If you removed a memory module from the expansion memory slot before removing the primary memory module, replace the memory module in the expansion memory module slot.

11. Replace the bottom door **(1)** sliding it securely into place **(2)**.

12. Tighten the bottom door screws. (3).

 **NOTE:** Refer to the illustration that most closely matches your computer.

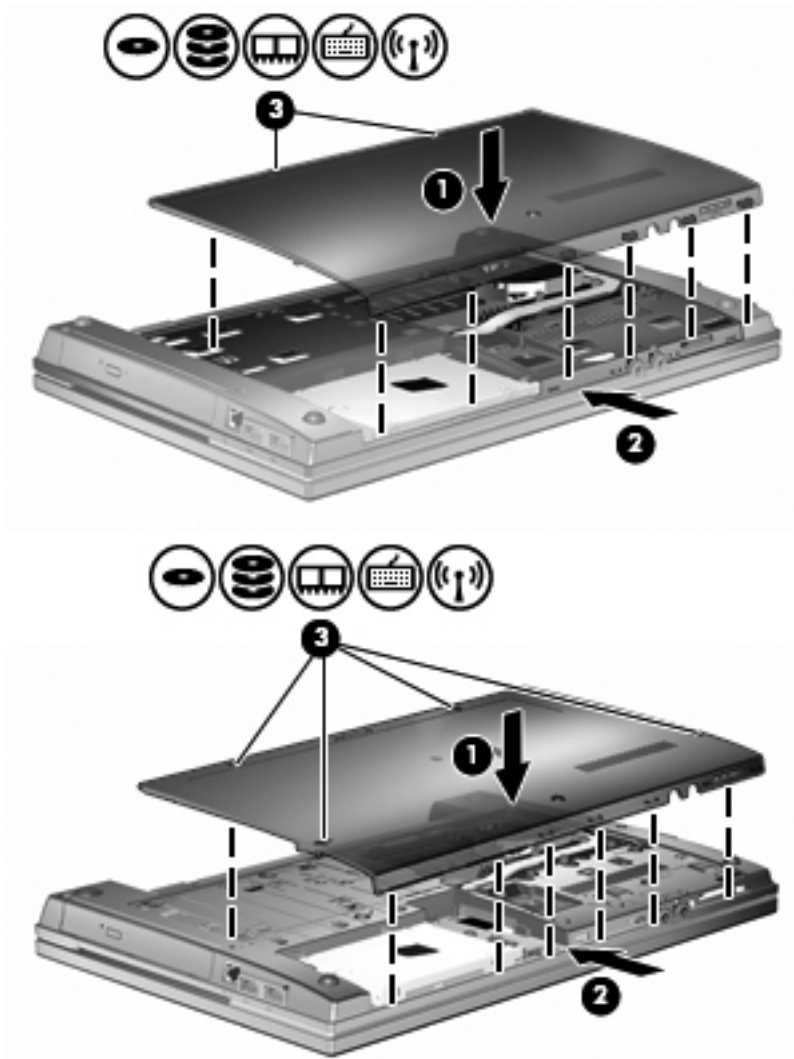

13. Replace the battery.
14. Turn the computer right-side up, and then reconnect external power and external devices.
15. Turn on the computer.

---

# 10 Security

## Protecting the computer

 **NOTE:** Security solutions are designed to act as deterrents. These deterrents may not prevent a product from being mishandled or stolen.

**NOTE:** Your computer supports CompuTrace, which is an online security-based tracking and recovery service available in select regions. If the computer is stolen, CompuTrace can track the computer if the unauthorized user accesses the Internet. You must purchase the software and subscribe to the service in order to use CompuTrace. For information about ordering the CompuTrace software, go to the HP Web site at <http://www.hpshopping.com>.

Security features provided with your computer can protect the computer, personal information, and data from a variety of risks. The way you use your computer will determine which security features you need to use.

The Windows operating system offers certain security features. Additional security features are listed in the following table. Most of these additional security features can be configured in the Computer Setup utility (referred to hereafter as Computer Setup).

To protect against	Use this security feature
Unauthorized use of the computer	HP ProtectTools Security Manager, in combination with a password, smart card (select models only), and/or fingerprint reader (select models only)
Unauthorized access to Computer Setup (f10)	BIOS administrator password in Computer Setup*
Unauthorized access to the contents of a hard drive	DriveLock password in Computer Setup*
Unauthorized startup from an optical drive, diskette drive, or internal network adapter	Boot options feature in Computer Setup*
Unauthorized access to a Windows user account	HP ProtectTools Security Manager
Unauthorized access to data	<ul style="list-style-type: none"><li>• Firewall software</li><li>• Windows updates</li><li>• Drive encryption for HP ProtectTools</li></ul>
Unauthorized access to Computer Setup settings and other system identification information	BIOS administrator password in Computer Setup*
Unauthorized removal of the computer	Security cable slot (used with an optional security cable)

\*Computer Setup is a preinstalled, ROM-based utility that can be used even when the operating system is not working or will not load. You can use either a pointing device (TouchPad, pointing stick, or USB mouse) or the keyboard to navigate and make selections in Computer Setup.



## Using passwords

Most security features use passwords. Whenever you set a password, write down the password and store it in a secure location away from the computer. Note the following password considerations:

- Setup and DriveLock passwords are set in Computer Setup and are managed by the system BIOS.
- The embedded security password, which is an HP ProtectTools Security Manager password, can be enabled in Computer Setup to provide BIOS password protection in addition to their normal HP ProtectTools functions. The embedded security password is used with the optional embedded security chip.
- Windows passwords are set only in the Windows operating system.
- If you forget the BIOS administrator password set in Computer Setup, you can use HP SpareKey to access the utility.
- If you forget both the DriveLock user password and the DriveLock master password set in Computer Setup, the hard drive that is protected by the passwords is permanently locked and can no longer be used.

You can use the same password for a Computer Setup feature and for a Windows security feature. You can also use the same password for more than one Computer Setup feature.

Use the following tips for creating and saving passwords:

- When creating passwords, follow requirements set by the program.
- Write down your passwords and store them in a secure place away from the computer.
- Do not store passwords in a file on the computer.

The following tables list commonly used Windows and BIOS administrator passwords and describe their functions.

### Setting passwords in Windows

Windows passwords	Function
Administrator password*	Protects access to a Windows administrator-level account.
User password*	Protects access to a Windows user account.

\*For information about setting a Windows administrator password or a Windows user password, select **Start > Help and Support**.

### Setting passwords in Computer Setup

BIOS administrator passwords	Function
BIOS administrator password	Protects access to Computer Setup.

BIOS administrator passwords	Function
DriveLock master password	Protects access to the internal hard drive that is protected by DriveLock. It is also used to remove DriveLock protection. This password is set under DriveLock Passwords during the enable process.
DriveLock user password	Protects access to the internal hard drive that is protected by DriveLock, and is set under DriveLock Passwords during the enable process.

## BIOS administrator password

The Computer Setup BIOS administrator password protects the configuration settings and system identification information in Computer Setup. After this password is set, it must be entered to access Computer Setup and to make changes using Computer Setup.

Note the following characteristics of the BIOS administrator password:

- It is not interchangeable with a Windows administrator password, although both passwords can be identical.
- It is not displayed as it is set, entered, changed, or deleted.
- It must be set and entered with the same keys. For example, a BIOS administrator password set with keyboard number keys will not be recognized if you enter it thereafter with embedded numeric keypad number keys.
- It can include any combination of up to 32 letters and numbers and is not case sensitive unless mandated by the administrator.

## Managing a BIOS administrator password

A BIOS administrator password is set, changed, and deleted in Computer Setup.

To set or change this password in Computer Setup, follow these steps:

1. Turn on or restart the computer, and then press **esc** while the “Press the ESC key for Startup Menu” message is displayed at the bottom of the screen.
2. Press **f10** to enter BIOS Setup.
3. Use a pointing device or the arrow keys to select **Security > Change Password**, and then press **enter**.
4. When prompted, type your current password.
5. When prompted, type your new password.
6. When prompted, type your new password again to confirm.
7. To save your changes and exit Computer Setup, click the **Save** icon in the lower-left corner of the screen, and then follow the on-screen instructions.

– or –

Use the arrow keys to select **File > Save Changes and Exit**, and then press **enter**.

Your changes go into effect when the computer restarts.

To delete this password in Computer Setup, follow these steps:

1. Turn on or restart the computer, and then press **esc** while the “Press the ESC key for Startup Menu” message is displayed at the bottom of the screen.
2. Press **f10** to enter BIOS Setup.
3. Use a pointing device or the arrow keys to select **Security > Change Password**, and then press **enter**.
4. When prompted, type your current password.
5. When prompted for the new password, leave the field empty, and then press **enter**.
6. Read the warning. To continue, select **YES**.
7. When prompted to type your new password again, leave the field empty, and then press **enter**.
8. To save your changes and exit Computer Setup, click the **Save** icon in the lower-left corner of the screen, and then follow the on-screen instructions.

– or –

Use the arrow keys to select **File > Save Changes and Exit**, and then press **enter**.

Your changes go into effect when the computer restarts.

## Entering a BIOS administrator password

At the **BIOS administrator password** prompt, type your password (using the same kind of keys you used to set the password), and then press **enter**. After three unsuccessful attempts to enter the BIOS administrator password, you must restart the computer and try again.

## Using Computer Setup DriveLock

---

△ **CAUTION:** To prevent the DriveLock-protected hard drive from becoming permanently unusable, record the DriveLock user password and the DriveLock master password in a safe place away from your computer. If you forget both DriveLock passwords, the hard drive will be permanently locked and can no longer be used.

---

DriveLock protection prevents unauthorized access to the contents of a hard drive. DriveLock can be applied only to the internal hard drive(s) of the computer. After DriveLock protection is applied to a drive, a password must be entered to access the drive. The drive must be inserted into the computer or an advanced port replicator in order for it to be accessed by the DriveLock passwords.

To apply DriveLock protection to an internal hard drive, a user password and a master password must be set in Computer Setup. Note the following considerations about using DriveLock protection:

- After DriveLock protection is applied to a hard drive, the hard drive can be accessed only by entering either the user password or the master password.
- The owner of the user password should be the day-to-day user of the protected hard drive. The owner of the master password may be either a system administrator or the day-to-day user.
- The user password and the master password can be identical.
- You can delete a user password or master password only by removing DriveLock protection from the drive. DriveLock protection can be removed from the drive only with the master password.

## Setting a DriveLock password

To set a DriveLock password in Computer Setup, follow these steps:

1. Turn on the computer, and then press **esc** while the “Press the ESC key for Startup Menu” message is displayed at the bottom of the screen.
2. Press **f10** to enter BIOS Setup.
3. Use a pointing device or the arrow keys to select **Security > DriveLock Password**, and then press **enter**.
4. Use a pointing device to click the hard drive you want to protect.

– or –

Use the arrow keys to select the hard drive you want to protect, and then press **enter**.

5. Read the warning. To continue, select **YES**.
6. Type your master password in the **New password** and **Verify new password** fields, and then press **enter**.
7. Type your user password in the **New password** and **Verify new password** fields, and then press **enter**.
8. To confirm DriveLock protection on the drive you have selected, type `DriveLock` in the confirmation field, and then press **enter**.



---

**NOTE:** The DriveLock confirmation is case sensitive.

---

9. To save your changes and exit Computer Setup, click the **Save** icon in the lower-left corner of the screen, and then follow the on-screen instructions.

– or –

Use the arrow keys to select **File > Save Changes and Exit**, and then press **enter**.

Your changes go into effect when the computer restarts.

## Entering a DriveLock password

Be sure that the hard drive is inserted into the computer (not into an optional docking device or external MultiBay).

At the **DriveLock Password** prompt, type your user or master password (using the same kind of keys you used to set the password), and then press **enter**.

After two incorrect attempts to enter the password, you must shut down the computer and try again.

## Changing a DriveLock password

To change a DriveLock password in Computer Setup, follow these steps:

1. Turn on the computer, and then press **esc** while the “Press the ESC key for Startup Menu” message is displayed at the bottom of the screen.
2. Press **f10** to enter BIOS Setup.

3. Use a pointing device or the arrow keys to select **Security > DriveLock Password**, and then press [enter](#).
4. Use a pointing device to select an internal hard drive.  
– or –  
Use the arrow keys to select an internal hard drive, and then press [enter](#).
5. Use a pointing device or the arrow keys to select the password you want to change.
6. Type your current password in the **Old password** field, type a new password in the **New password** and **Verify new password** fields, and then press [enter](#).
7. To save your changes and exit Computer Setup, click the **Save** icon in the lower-left corner of the screen, and then follow the on-screen instructions.  
– or –  
Use the arrow keys to select **File > Save Changes and Exit**, and then press [enter](#).

Your changes go into effect when the computer restarts.

## Removing DriveLock protection

To remove DriveLock protection in Computer Setup, follow these steps:

1. Turn on the computer, and then press [esc](#) while the “Press the ESC key for Startup Menu” message is displayed at the bottom of the screen.
2. Press [f10](#) to enter BIOS Setup.
3. Use a pointing device or the arrow keys to select **Security > DriveLock Password**, and then press [enter](#).
4. Use a pointing device or the arrow keys to select an internal hard drive, and then press [enter](#).
5. Use a pointing device or the arrow keys to select **Disable protection**.
6. Type your master password, and then press [enter](#).
7. To save your changes and exit Computer Setup, click the **Save** icon in the lower-left corner of the screen, and then follow the on-screen instructions.  
– or –  
Use the arrow keys to select **File > Save Changes and Exit**, and then press [enter](#).

Your changes go into effect when the computer restarts.

## Using Computer Setup Auto DriveLock

In a multiple-user environment, you can set an Automatic DriveLock password. When the Automatic DriveLock password is enabled, a random user password and a DriveLock master password will be created for you. When any user passes the password credential, the same random user and DriveLock master password will be used to unlock the drive.

---

 **NOTE:** You must have a BIOS administrator password before you can access the Automatic DriveLock features.

---

## Entering an Automatic DriveLock password

To enable an Automatic DriveLock password in Computer Setup, follow these steps:

1. Turn on or restart the computer, and then press **esc** while the “Press the ESC key for Startup Menu” message is displayed at the bottom of the screen.
2. Press **f10** to enter BIOS Setup.
3. Use a pointing device or the arrow keys to select **Security > Automatic DriveLock**, and then press **enter**.
4. Use a pointing device or the arrow keys to select an internal hard drive, and then press **enter**.
5. Read the warning. To continue, select **YES**.
6. To save your changes and exit Computer Setup, click the **Save** icon in the lower-left corner of the screen, and then follow the on-screen instructions.

– or –

Use the arrow keys to select **File > Save Changes and Exit**, and then press **enter**.

## Removing Automatic DriveLock protection

To remove DriveLock protection in Computer Setup, follow these steps:

1. Turn on or restart the computer, and then press **esc** while the “Press the ESC key for Startup Menu” message is displayed at the bottom of the screen.
2. Press **f10** to enter BIOS Setup.
3. Use a pointing device or the arrow keys to select **Security > Automatic DriveLock**, and then press **enter**.
4. Use a pointing device or the arrow keys to select an internal hard drive, and then press **enter**.
5. Use a pointing device or the arrow keys to select **Disable protection**.
6. To save your changes and exit Computer Setup, click the **Save** icon in the lower-left corner of the screen, and then follow the on-screen instructions.

– or –

Use the arrow keys to select **File > Save Changes and Exit**, and then press **enter**.

# Using Computer Setup security features

## Securing system devices

You can disable or enable system devices from the following menus in Computer Setup:

- Boot Options
- Device Configurations
- Built-In Device Options
- Port Options

To disable or reenable system devices in Computer Setup, follow these steps:

1. Turn on or restart the computer, and then press **esc** while the “Press the ESC key for Startup Menu” message is displayed at the bottom of the screen.
2. Press **f10** to enter BIOS Setup.
3. Use a pointing device or the arrow keys to select **System Configuration > Boot Options**, or **System Configuration > Device Configurations**, or **System Configuration > Built-In Device Options**, or **System Configuration > Port Options**.
4. Press **enter**.
5. To disable an option, use a pointing device to clear the checkbox next to the option.  
– or –  
Use the arrow keys to select the option, and then press **enter**.
6. To reenable an option, use a pointing device to check the box next to the option.  
– or –  
Use the arrow keys to select the option, and then press **enter**.
7. To save your changes and exit Computer Setup, click the **Save** icon in the lower-left corner of the screen, and then follow the on-screen instructions.  
– or –  
Use the arrow keys to select **File > Save Changes and Exit**, and then press **enter**.

Your changes go into effect when the computer restarts.

## Viewing Computer Setup System Information

The System Information feature in Computer Setup provides two types of system information:

- Identification information about the computer model and the batteries
- Specification information about the processor, cache, memory, ROM, video revision, and keyboard controller revision

To view this general system information in Computer Setup, follow these steps:

1. Turn on or restart the computer, and then press **esc** while the “Press the ESC key for Startup Menu” message is displayed at the bottom of the screen.
2. Press **f10** to enter BIOS Setup.
3. Use a pointing device or the arrow keys to select **File > System Information**, and then press **enter**.

---

 **NOTE:** To prevent unauthorized access to this information, you must create a BIOS administrator password in Computer Setup.

---

## Using Computer Setup System IDs

The System IDs feature in Computer Setup allows you to display or enter the computer asset tag and ownership tag.

---

 **NOTE:** To prevent unauthorized access to this information, you must create a BIOS administrator password in Computer Setup.

---

To manage this feature in Computer Setup, follow these steps:

1. Turn on or restart the computer, and then press **esc** while the “Press the ESC key for Startup Menu” message is displayed at the bottom of the screen.
2. Press **f10** to enter BIOS Setup.
3. Use a pointing device or the arrow keys to select **Security > System IDs**, and then press **enter**.
4. Use a pointing device or the arrow keys to select **Notebook Asset Tag** or **Notebook Ownership Tag**, and then enter the information.
5. Press **enter** when finished.
6. To save your changes and exit Computer Setup, click the **Save** icon in the lower-left corner of the screen, and then follow the on-screen instructions.

– or –

Use the arrow keys to select **File > Save Changes and Exit**, and then press **enter**.

Your changes go into effect when the computer restarts.



## Using antivirus software

When you use the computer to access e-mail, a network, or the Internet, you expose the computer to computer viruses. Computer viruses can disable the operating system, programs, or utilities, or cause them to function abnormally.

Antivirus software can detect most viruses, destroy them, and in most cases, repair any damage they have caused. To provide ongoing protection against newly discovered viruses, antivirus software must be kept up to date.

An antivirus program may be preinstalled on your computer and may include a trial offer. It is strongly recommended that you upgrade the trial offer or purchase the antivirus program of your choice in order to fully protect your computer.

For more information about computer viruses, type `viruses` in the Search box in Help and Support.

## Using firewall software

Firewalls are designed to prevent unauthorized access to a system or network. A firewall can be a software program you install on your computer and/or network, or it can be a solution made up of both hardware and software.

There are two types of firewalls to consider:

- Host-based firewalls—software that protects only the computer it is installed on.
- Network-based firewalls—installed between your DSL or cable modem and your home network to protect all the computers on the network.

When a firewall is installed on a system, all data sent to and from the system is monitored and compared with a set of user-defined security criteria. Any data that does not meet those criteria is blocked.

Your computer or networking equipment may already have a firewall installed. If not, firewall software solutions are available.

---

 **NOTE:** Under some circumstances a firewall can block access to Internet games, interfere with printer or file sharing on a network, or block authorized e-mail attachments. To temporarily resolve the problem, disable the firewall, perform the task that you want to perform, and then reenable the firewall. To permanently resolve the problem, reconfigure the firewall as necessary, and adjust the policies and settings of other intrusion detection systems. For additional information, contact your network administrator or IT department.

---

## Installing critical updates

△ **CAUTION:** Microsoft sends alerts regarding critical updates. To protect the computer from security breaches and computer viruses, install all critical updates from Microsoft as soon as you receive an alert.

---

Updates to the operating system and other software may have become available *after* the computer was shipped. To be sure that all available updates are installed on the computer, observe these guidelines:

- Run Windows Update monthly to install the latest software from Microsoft.
- Obtain updates, as they are released, from the Microsoft Web site and through the updates link in Help and Support.

# Using HP ProtectTools Security Manager (select models only)

HP ProtectTools Security Manager software is preinstalled on select computer models. This software can be accessed through Windows Control Panel. It provides security features that help protect against unauthorized access to the computer, networks, and critical data. For more information, refer to the HP ProtectTools online Help.

## Installing a security cable

 **NOTE:** A security cable is designed to act as a deterrent, but it may not prevent the computer from being mishandled or stolen.

1. Loop the security cable around a secured object.
2. Insert the key (1) into the cable lock (2).
3. Insert the cable lock into the security cable slot on the computer (3), and then lock the cable lock with the key.

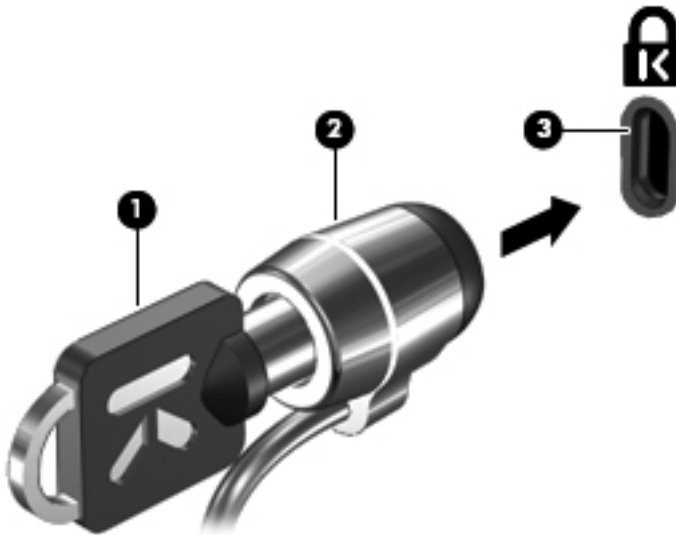

 **NOTE:** The location of the security cable slot varies by computer model.

---

# 11 Software updates

## Updating software

Updated versions of the software provided with your computer are available either through the HP Assistant utility or on the HP Web site.

HP Assistant automatically checks for updates from HP. The utility runs at a specified interval and provides a list of support alerts, such as security enhancements, and optional software and driver updates.

You can manually check for updates at any time by selecting **Start > Help and Support > Maintain**, and then follow the on-screen instructions.

Most software on the HP Web site is packaged in compressed files called *SoftPaqs*. Some BIOS updates may be packaged in compressed files called *ROMPaqs*.

Some download packages contain a file named *Readme.txt*, which contains information regarding installing and troubleshooting the file. (*Readme.txt* files included with *ROMPaqs* are provided in English only.)

You can also access software updates by obtaining the *Support Software* disc (purchased separately). This disc includes device drivers, BIOS updates, and utilities.

To purchase the current *Support Software* disc or a subscription that provides both the current version and future versions of the disc, follow these steps:

1. Open your Internet browser, and go to <http://www.hp.com/support>.
2. Select your country or region.
3. Click the option for software and driver downloads, and then type your computer model number in the product box.
4. Press **enter**.
5. Follow the on-screen instructions.

To update the software using a *Support Software* disc, follow these steps:

1. Insert the *Support Software* disc into the optical drive.
2. Follow the on-screen instructions.

To update the software using the HP Web site, follow these steps:

1. Identify your computer model, product category, and series or family. Prepare for a system BIOS update by identifying the BIOS version currently installed on the computer. For details, refer to the "Determining the BIOS version" section.

If your computer is connected to a network, consult the network administrator before installing any software updates, especially system BIOS updates.

---

 **NOTE:** The computer system BIOS is stored on the system ROM. The BIOS initializes the operating system, determines how the computer will interact with the hardware devices, and provides for data transfer among hardware devices, including the time and date.

**NOTE:** Windows includes the User Account Control feature to improve the security of your computer. You may be prompted for your permission or password for tasks such as installing software, running utilities, or changing Windows settings. Refer to Windows Help and Support for more information.

---

2. Open your Internet browser, and go to <http://www.hp.com/support>.
3. Select your country or region.
4. Click the option for software and driver downloads, and then type your computer model number in the product box.
5. Press **enter**.
6. Follow the on-screen instructions.

# Updating the BIOS

To update the BIOS, first determine what BIOS version you currently have, and then download and install the new BIOS.

## Determining the BIOS version

BIOS version information (also known as *ROM date* and *System BIOS*) can be displayed by pressing **fn+esc** (if you are already in Windows) or by using Computer Setup.

To use Computer Setup for displaying BIOS information, follow these steps:

1. Turn on or restart the computer, and then press **esc** while the “Press the ESC key for Startup Menu” message is displayed at the bottom of the screen.
2. Press **f10** to enter BIOS Setup.
3. Use a pointing device or the arrow keys to select **File > System Information**.
4. Press **esc** to return to the **File** menu.
5. Click **Exit** in the lower-left corner of the screen, and then follow the on-screen instructions.

– or –

Use the arrow keys to select **File > Ignore changes and exit**, and then press **enter**.

## Downloading a BIOS update

- △ **CAUTION:** To prevent damage to the computer or an unsuccessful installation, download and install a BIOS update only when the computer is connected to reliable external power using the AC adapter. Do not download or install a BIOS update while the computer is running on battery power, docked in an optional docking device, or connected to an optional power source. During the download and installation, follow these guidelines:

Do not disconnect power from the computer by unplugging the power cord from the AC outlet.

Do not shut down the computer or initiate Sleep or Hibernation.

Do not insert, remove, connect, or disconnect any device, cable, or cord.

To download a BIOS update:

-  **NOTE:** BIOS updates are posted as needed. A newer BIOS update may not be available for your computer. It is recommended that you check the HP Web site periodically for BIOS updates.

1. Open your Internet browser, go to <http://www.hp.com/support>, and then select your country or region.
2. Click the option for software and driver downloads, type your computer model number in the product box, and then press **enter**.
3. Click your specific product from the models listed.
4. Click your operating system.
5. Follow the on-screen instructions to access the BIOS update you want to download. Make a note of the download date, name, or other identifier. You may need this information to locate the update later, after it has been downloaded to your hard drive.
6. At the download area, perform these steps:
  - a. Identify the BIOS update that is newer than the BIOS version currently installed on your computer.
  - b. Follow the instructions on the screen to download your selection to the hard drive.

Make a note of the path to the location on your hard drive where the BIOS update will be downloaded. You will need to access this path when you are ready to install the update.

-  **NOTE:** If you connect your computer to a network, consult the network administrator before installing any software updates, especially system BIOS updates.

BIOS installation procedures vary. Follow any instructions that are displayed on the screen after the download is complete. If no instructions are displayed, follow these steps:

1. Open Windows Explorer by selecting **Start > Computer**.
2. Double-click your hard drive designation. The hard drive designation is typically Local Disk (C:).
3. Using the hard drive path you recorded earlier, open the folder on your hard drive that contains the update.
4. Double-click the file that has an .exe extension (for example, *filename.exe*).

The BIOS installation begins.

---

 **NOTE:** Windows includes the User Account Control feature to improve the security of your computer. You may be prompted for your permission or password for tasks such as installing software, running utilities, or changing Windows settings. Refer to Windows Help and Support for more information.

---

5. Complete the installation by following the on-screen instructions.

 **NOTE:** After a message on the screen reports a successful installation, you may delete the downloaded file from your hard drive.

---

## Updating programs and drivers

1. Open your Internet browser, go to <http://www.hp.com/support>, and then select your country or region.
2. Click the option for software and driver downloads, type your computer model number in the product box, and then press **enter**.

– or –

If you want a specific SoftPaq, type the SoftPaq number in the **Search** box, at the top-right corner of the screen. Then press **enter**, and follow the instructions provided. Proceed to step 6.

3. Click your specific product from the models listed.
4. Click your operating system.
5. When the list of updates is displayed, click an update to open a window containing additional information.
6. Click **Download**.
7. Click **Run** to install the updated software without downloading the file.

– or –

Click **Save** to save the file to your computer. When prompted, select a storage location on your hard drive.

After the file is downloaded, navigate to the folder where the file was stored, and then double-click the file to install the update.

8. If prompted to do so, restart your computer after the installation is complete.



# Using SoftPaq Download Manager

HP SoftPaq Download Manager (SDM) is a tool that provides quick access to SoftPaq information for HP business computers without requiring the SoftPaq number. Using this tool, you can easily search for SoftPaqs and then download and unpack them.

SoftPaq Download Manager works by reading and downloading, from the HP FTP site, a published database file containing computer model and SoftPaq information. SoftPaq Download Manager allows you to specify one or more computer models to determine which SoftPaqs are available for download.

SoftPaq Download Manager checks the HP FTP site for updates to the database and software. If updates are found, they are downloaded and applied automatically.

SoftPaq Download Manager is available on the HP Web site. To use SoftPaq Download Manager to download SoftPaqs, you must first download and install the program. Go to the HP Web site at <http://www.hp.com/go/sdm>, and follow the instructions to download and install SoftPaq Download Manager.

To download SoftPaqs:

1. Select **Start > All Programs > HP Software Setup > HP SoftPaq Download Manager**.
2. When the SoftPaq Download Manager opens for the first time, a window is displayed asking if you want to show only software for the computer you are using or to show the software for all supported models. Select **Show software for all supported models**. If you have used HP SoftPaq Download Manager previously, go to Step 3.
  - a. Select your operating system and language filters in the Configuration Options window. The filters limit the number of options that are listed in the Product Catalog pane. For example, if only Windows 7 Professional is selected in the operating system filter, the only operating system that is displayed in the Product Catalog is Windows 7 Professional.
  - b. To add other operating systems, change the filter settings in the Configuration Options window. Refer to the HP SoftPaq Download Manager software Help for more information.
3. In the left pane, click the plus sign (+) to expand the model list, and then select the model or models of the products you want to update.
4. Click **Find Available SoftPaqs** to download a list of available SoftPaqs for the selected computer.
5. Select from the list of available SoftPaqs, and then click **Download Only** if you have many SoftPaqs to download, because the SoftPaq selection and Internet connection speed determine how long the download process will take.

If you want to download only one or two SoftPaqs and have a high-speed Internet connection, click **Download & Unpack**.

6. Right-click **Install SoftPaq** in the SoftPaq Download Manager software to install the selected SoftPaqs on the computer.

---

## 12 Backup and recovery

To protect your information, use Windows Backup and Restore to back up individual files and folders, back up your entire hard drive (select models only), create system repair discs (select models only), or create system restore points. In case of system failure, you can use the backup files to restore the contents of your computer.

Windows Backup and Restore provides the following options:

- Creating a system repair disc (select models only)
- Backing up individual files and folders
- Creating a system image (select models only)
- Scheduling automatic backups (select models only)
- Creating system restore points
- Recovering individual files
- Restoring the computer to a previous state
- Recovering information using recovery tools

---

 **NOTE:** For detailed instructions, perform a search for these topics in Help and Support.

**NOTE:** In case of system instability, HP recommends that you print the recovery procedures and save them for later use.

---

# Backing up your information

Recovery after a system failure is as complete as your most current backup. You should create system repair discs (select models only) and your initial backup immediately after software setup. As you add new software and data files, you should continue to back up your system on a regular basis to maintain a reasonably current backup. The system repair discs (select models only) are used to start up (boot) the computer and repair the operating system in case of system instability or failure. Your initial and subsequent backups allow you to restore your data and settings if a failure occurs.

You can back up your information to an optional external hard drive, a network drive, or discs.

Note the following when backing up:

- Store personal files in the Documents library, and back it up regularly.
- Back up templates that are stored in their associated programs.
- Save customized settings that appear in a window, toolbar, or menu bar by taking a screen shot of your settings. The screen shot can be a time-saver if you have to reset your preferences.

To create a screen shot:

1. Display the screen you want to save.
2. Copy the screen image:

To copy only the active window, press **alt+fn+prt sc**.

To copy the entire screen, press **fn+prt sc**.

3. Open a word-processing document, and then select **Edit > Paste**.

The screen image is added to the document.

4. Save the document.

- When backing up to discs, use any of the following types of discs (purchased separately): CD-R, CD-RW, DVD+R, DVD+R DL, DVD-R, DVD-R DL, or DVD±RW. The discs you use will depend on the type of optical drive installed in your computer.

---

 **NOTE:** DVDs and DVDs with double-layer (DL) support store more information than CDs, so using them for backup reduces the number of recovery discs required.

---

- When backing up to discs, number each disc before inserting it into the optical drive of the computer.

To create a backup using Backup and Restore, follow these steps:

---

 **NOTE:** Be sure that the computer is connected to AC power before you start the backup process.

---

**NOTE:** The backup process may take over an hour, depending on file size and the speed of the computer.

---

1. Select **Start > All Programs > Maintenance > Backup and Restore**.
2. Follow the on-screen instructions to set up your backup, create a system image (select models only), or create a system repair disc (select models only).

---

 **NOTE:** Windows includes the User Account Control feature to improve the security of your computer. You may be prompted for your permission or password for tasks such as installing software, running utilities, or changing Windows settings. Refer to Windows Help and Support for more information.

---

# Performing a recovery

In case of system failure or instability, the computer provides the following tools to recover your files:

- Windows recovery tools: You can use Windows Backup and Restore to recover information you have previously backed up. You can also use Windows Startup Repair to fix problems that might prevent Windows from starting correctly.
- **f11** recovery tools: You can use the **f11** recovery tools to recover your original hard drive image. The image includes the Windows operating system and software programs installed at the factory.

---

 **NOTE:** If you are unable to boot (start up) your computer and you cannot use the system repair discs you previously created (select models only), you must purchase a Windows 7 operating system DVD to reboot the computer and repair the operating system. For additional information, refer to the “Using a Windows 7 operating system DVD (purchased separately)” section in this guide.

---

## Using the Windows recovery tools

To recover information you previously backed up, follow these steps:

1. Select **Start > All Programs > Maintenance > Backup and Restore**.
2. Follow the on-screen instructions to recover your system settings, your computer (select models only), or your files.

---

 **NOTE:** Windows includes the User Account Control feature to improve the security of your computer. You may be prompted for your permission or password for tasks such as installing software, running utilities, or changing Windows settings. Refer to Windows Help and Support for more information.

---

To recover your information using Startup Repair, follow these steps:

 **CAUTION:** Using Startup Repair completely erases hard drive contents and reformats the hard drive. All files you have created and any software installed on the computer are permanently removed. When reformatting is complete, the recovery process restores the operating system, as well as the drivers, software, and utilities from the backup used for recovery.

---

1. If possible, back up all personal files.
2. If possible, check for the presence of the Windows partition and the HP Recovery partition.

To check for the Windows partition, select **Start > Computer**.

To check for the HP Recovery partition, select **Start**, right-click **Computer**, click **Manage**, and then click **Disk Management**.

---

 **NOTE:** If the Windows partition and the HP Recovery partition are not listed, you must recover your operating system and programs using the Windows 7 operating system DVD and the *Driver Recovery* disc (both purchased separately). For additional information, refer to the “Using a Windows 7 operating system DVD (purchased separately)” section in this guide.

---

3. If the Windows partition and the HP Recovery partition are listed, restart the computer, and then press **f8** before the Windows operating system loads.
4. Select **Startup Repair**.
5. Follow the on-screen instructions.

---

 **NOTE:** For additional information on recovering information using the Windows tools, perform a search for these topics in Help and Support.

---

## Using f11

△ **CAUTION:** Using **f11** completely erases hard drive contents and reformats the hard drive. All files you have created and any software installed on the computer are permanently removed. The **f11** recovery tool reinstalls the operating system and HP programs and drivers that were installed at the factory. Software not installed at the factory must be reinstalled.

---

To recover the original hard drive image using **f11**, follow these steps:

1. If possible, back up all personal files.
2. If possible, check for the presence of the HP Recovery partition: select **Start**, right-click **Computer**, click **Manage**, and then click **Disk Management**.

 **NOTE:** If the HP Recovery partition is not listed, you must recover your operating system and programs using the Windows 7 operating system DVD and the *Driver Recovery* disc (both purchased separately). For additional information, refer to the “Using a Windows 7 operating system DVD (purchased separately)” section in this guide.

---

3. If the HP Recovery partition is listed, restart the computer, and then press **esc** while the “Press the ESC key for Startup Menu” message is displayed at the bottom of the screen.
4. Press **f11** while the “Press <F11> for recovery” message is displayed on the screen.
5. Follow the on-screen instructions.

## Using a Windows 7 operating system DVD (purchased separately)

If you are unable to boot (start up) your computer and you cannot use the system repair discs you previously created (select models only), you must purchase a Windows 7 operating system DVD to reboot the computer and repair the operating system. Make sure that your most recent backup (stored on discs or on an external drive) is easily accessible. To order a Windows 7 operating system DVD, go to <http://www.hp.com/support>, select your country or region, and then follow the on-screen instructions. You can also order the DVD by calling technical support. For contact information, refer to the *Worldwide Telephone Numbers* booklet included with the computer.

△ **CAUTION:** Using a Windows 7 operating system DVD completely erases hard drive contents and reformats the hard drive. All files you have created and any software installed on the computer are permanently removed. When reformatting is complete, the recovery process helps you restore the operating system, as well as drivers, software, and utilities.

---

To initiate recovery using a Windows 7 operating system DVD, follow these steps:

 **NOTE:** This process takes several minutes.

---

1. If possible, back up all personal files.
2. Restart the computer, and then insert the Windows 7 operating system DVD into the optical drive before the Windows operating system loads.
3. When prompted, press any keyboard key.
4. Follow the on-screen instructions.
5. Click **Next**.

6. Select **Repair your computer**.
7. Follow the on-screen instructions.

---

# 13 Computer Setup

## Starting Computer Setup

Computer Setup is a preinstalled, ROM-based utility that can be used even when the operating system is not working or will not load.

 **NOTE:** Some of the Computer Setup menu items listed in this guide may not be supported by your computer.

**NOTE:** An external keyboard or mouse connected to a USB port can be used with Computer Setup only if USB legacy support is enabled.

To start Computer Setup, follow these steps:

1. Turn on or restart the computer, and then press **esc** while the “Press the ESC key for Startup Menu” message is displayed at the bottom of the screen.
2. Press **f10** to enter BIOS Setup.

## Using Computer Setup

### Navigating and selecting in Computer Setup

The information and settings in Computer Setup are accessed from the File, Security, and System Configuration menus.

To navigate and select in Computer Setup, follow these steps:

1. Turn on or restart the computer, and then press **esc** while the “Press the ESC key for Startup Menu” message is displayed at the bottom of the screen.
  - To select a menu or a menu item, use the tab key and the keyboard arrow keys, and then press **enter**, or use a pointing device to click the item.
  - To scroll up and down, click the up arrow or the down arrow in the upper-right corner of the screen, or use the up arrow key or the down arrow key.
  - To close open dialog boxes and return to the main Computer Setup screen, press **esc**, and then follow the on-screen instructions.



---

 **NOTE:** You can use either a pointing device (TouchPad, pointing stick, or USB mouse) or the keyboard to navigate and make selections in Computer Setup.

---

2. Press **f10** to enter BIOS Setup.
3. Select the **File**, **Security**, or **System Configuration** menu.

To exit Computer Setup menus, choose one of the following methods:

- To exit Computer Setup menus without saving your changes, click the **Exit** icon in the lower-left corner of the screen, and then follow the on-screen instructions.  
– or –  
Use the tab key and the arrow keys to select **File > Ignore Changes and Exit**, and then press **enter**.
- To save your changes and exit Computer Setup menus, click the **Save** icon in the lower-left corner of the screen, and then follow the on-screen instructions.  
– or –  
Use the tab key and the arrow keys to select **File > Save Changes and Exit**, and then press **enter**.

Your changes go into effect when the computer restarts.

## Restoring factory settings in Computer Setup

---

 **NOTE:** Restoring defaults will not change the hard drive mode.

---

To return all settings in Computer Setup to the values that were set at the factory, follow these steps:

1. Turn on or restart the computer, and then press **esc** while the “Press the ESC key for Startup Menu” message is displayed at the bottom of the screen.
2. Press **f10** to enter BIOS Setup.
3. Use a pointing device or the arrow keys to select **File > Restore Defaults**.
4. Follow the on-screen instructions.
5. To save your changes and exit, click the **Save** icon in the lower-left corner of the screen, and then follow the on-screen instructions.

– or –

Use the arrow keys to select **File > Save Changes and Exit**, and then press **enter**.

Your changes go into effect when the computer restarts.

---

 **NOTE:** Your password settings and security settings are not changed when you restore the factory settings.

---

## Computer Setup menus

The menu tables in this section provide an overview of Computer Setup options.

 **NOTE:** Some of the Computer Setup menu items listed in this chapter may not be supported by your computer.

## File menu

Select	To do this
System Information	<ul style="list-style-type: none"><li>• View identification information for the computer and the batteries in the system.</li><li>• View specification information for the processor, cache and memory size, system ROM, video revision, and keyboard controller version.</li></ul>
Set System Date and Time	Set or change the date and time on the computer.
System Diagnostics	Displays the following information: <ul style="list-style-type: none"><li>• System Information<ul style="list-style-type: none"><li>◦ Identification information for the computer and the batteries in the system.</li><li>◦ Specification information for the processor, cache and memory size, system ROM, video revision, and keyboard controller version.</li></ul></li><li>• Start-up Test—Verifies the system components needed for starting the computer.</li><li>• Run-In Test—Runs a comprehensive check on system memory.</li><li>• Hard Disk Test—Runs a comprehensive self-test on any hard drive in the system.</li><li>• Memory Test—Runs a comprehensive test on any memory installed in the computer.</li><li>• Battery Test—Runs a comprehensive test on any batteries installed in the computer.</li><li>• Error Log—Displays a log file if any errors have occurred.</li></ul>
Restore Defaults	Replace the configuration settings in Computer Setup with the original factory settings. (Hard drive mode, password settings, and security settings are not changed when you restore the factory settings.)
Reset BIOS security to factory default	Restore the BIOS security settings to the factory default.
Ignore Changes and Exit	Cancel any changes entered during the current session. Then exit and restart the computer.
Save Changes and Exit	Save any changes entered during the current session. Then exit and restart the computer. Your changes go into effect when the computer restarts.

## Security menu

 **NOTE:** Some of the menu items listed in this section may not be supported by your computer.

Select	To do this
Setup BIOS Administrator Password	Set up a BIOS administrator password.
<b>User Management &gt; Create a New BIOS User Account</b> (requires a BIOS administrator password)	<ul style="list-style-type: none"> <li>Select from a list of BIOS users.</li> <li>Select from a list of ProtectTools users.</li> </ul>
Password Policy (requires a BIOS administrator password)	Revise password policy criteria.
HP SpareKey	Enable/disable HP SpareKey (enabled by default).
Always Prompt for HP SpareKey Enrollment	Enable/disable HP SpareKey enrollment (enabled by default).
Fingerprint Reset on Reboot (If Present)	Reset/clear the fingerprint reader ownership (select models only; disabled by default).
Change Password	Enter, change, or delete a BIOS administrator password.
HP SpareKey Enrollment	Enroll or reset HP SpareKey, which is a set of security questions and answers used if you forget your password.
<b>Anti Theft &gt; AT-p</b> (select models only)	Enable/disable Anti-Theft Protection.
DriveLock Password	<ul style="list-style-type: none"> <li>Enable/disable DriveLock on any computer hard drive (enabled by default).</li> <li>Change a DriveLock user password or master password.</li> </ul> <p><b>NOTE:</b> DriveLock settings are accessible only when you enter Computer Setup by turning on (not restarting) the computer.</p>
Automatic DriveLock	Enable/disable Automatic DriveLock support (disabled by default).
Disk Sanitizer	Run Disk Sanitizer to destroy all existing data on the primary hard drive or the drive in the upgrade bay.  <b>CAUTION:</b> If you run Disk Sanitizer, the data on the selected drive is destroyed permanently.
System IDs	Enter a user-defined computer asset tracking number and ownership tag.

## System Configuration menu

 **NOTE:** Some of the listed System Configuration options may not be supported by your computer.

Select	To do this
Language	Change the Computer Setup language.

Select	To do this
Boot Options	<ul style="list-style-type: none"> <li>• Set a startup menu delay (in seconds).</li> <li>• Set the MultiBoot Express Boot Popup delay in seconds.</li> <li>• Enable/disable custom logo (disabled by default).</li> <li>• Enable/disable display diagnostic URL (enabled by default).</li> <li>• Enable/disable CD-ROM boot (enabled by default).</li> <li>• Enable/disable SD card boot (enabled by default).</li> <li>• Enable/disable floppy boot (enabled by default).</li> <li>• Enable/disable PXE internal NIC boot (enabled by default).</li> <li>• Enable/Disable Unified Extensible Firmware Interface (UEFI) Boot Mode (disabled by default).</li> <li>• Set the legacy boot order.</li> </ul>
Device Configurations	<ul style="list-style-type: none"> <li>• Enable/disable USB legacy support (enabled by default). When enabled, USB legacy support allows the following: <ul style="list-style-type: none"> <li>◦ Use of a USB keyboard in Computer Setup, even when a Windows operating system is not running.</li> <li>◦ Startup from bootable USB devices, including a hard drive, diskette drive, or optical drive connected by a USB port to the computer</li> </ul> </li> <li>• Select a parallel port mode: ECP (Enhanced Capabilities Port), standard, bidirectional, or EPP (Enhanced Parallel Port).</li> <li>• Enable/disable fan always on while connected to an AC outlet (enabled by default).</li> <li>• Enable/disable Data Execution Prevention (select models only). When enabled, the processor can disable some virus code execution, which helps to improve computer security (enabled by default).</li> <li>• Select a SATA (Serial Advanced Technology Attachment) device mode. The following options are available: <ul style="list-style-type: none"> <li>◦ AHCI (Advanced Host Controller Interface)</li> <li>◦ IDE (Integrated Drive Electronics)</li> <li>◦ RAID (Redundant Array of Independent Disks) (select models only)</li> </ul> </li> </ul>

---

Select	To do this
	<p><b>NOTE:</b> Availability of these options varies by computer model.</p> <ul style="list-style-type: none"><li>• Enable/disable secondary battery fast charge (enabled by default).</li><li>• Enable/disable HP QuickLook (enabled by default).</li><li>• Enable/disable preboot authentication on HP QuickLook boot (enabled by default).</li><li>• Enable/disable HP QuickWeb (enabled by default).</li><li>• Enable/disable HP QuickWeb write protect (disabled by default).</li><li>• Enable/disable virtualization technology (select models only; disabled by default).</li><li>• Enable/disable Intel TXT (Trusted Execution Technology) (select models only; disabled by default).</li><li>• Enable/disable Multi Core CPU (enabled by default).</li><li>• Enable/disable Intel HT technology (enabled by default).</li><li>• Enable/disable wake on USB (enabled by default).</li><li>• Enable/disable Num lock state at boot (disabled by default).</li></ul>

---

Select	To do this
Built-In Device Options	<ul style="list-style-type: none"> <li>• Enable/disable the wireless button state (enabled by default).</li> <li>• Enable/disable embedded WWAN device (select models only; enabled by default).</li> <li>• Enable/disable embedded WLAN Device (enabled by default).</li> <li>• Enable/disable the embedded Bluetooth device (enabled by default).</li> <li>• Enable/disable the network interface controller (LAN) (enabled by default).</li> <li>• Enable/disable LAN/WLAN switching (disabled by default).</li> <li>• Set the wake on LAN state. Options include the following: <ul style="list-style-type: none"> <li>◦ Disabled</li> <li>◦ Boot to Network (default setting)</li> <li>◦ Follow Boot Order</li> </ul> </li> <li>• Enable/disable the ambient light sensor (enabled by default).</li> <li>• Enable/disable the notebook upgrade bay device (enabled by default).</li> <li>• Enable/disable the fingerprint device (enabled by default).</li> <li>• Enable/disable the integrated camera (enabled by default).</li> <li>• Enable/disable the power monitor circuit (enabled by default).</li> <li>• Enable/disable the audio device (enabled by default).</li> <li>• Enable/disable a modem device (enabled by default).</li> <li>• Enable/disable the microphone (enabled by default).</li> <li>• Enable/disable the internal speakers (enabled by default).</li> </ul>

Select	To do this
Port Options	<p><b>NOTE:</b> All port options are enabled by default.</p> <ul style="list-style-type: none"> <li>• Enable/disable the serial port (select models only).</li> <li>• Enable/disable the parallel port (select models only).</li> <li>• Enable/disable the flash media reader.</li> <li>• Enable/disable the USB port.</li> </ul> <p><b>CAUTION:</b> Disabling the USB port also disables MultiBay devices and ExpressCard devices on the advanced port replicator.</p> <ul style="list-style-type: none"> <li>• Enable/disable the 1394 port (select models only).</li> <li>• Enable/disable the ExpressCard slot.</li> <li>• Enable/disable the eSATA port.</li> </ul>
AMT Options (select models only).	<p><b>NOTE:</b> All AMT options are disabled by default.</p> <ul style="list-style-type: none"> <li>• Enable/disable firmware verbosity.</li> <li>• Enable/disable AMT setup prompt (Ctrl-P).</li> <li>• Enable/disable USB key provisioning support.</li> <li>• Enable/disable unconfigure AMT on next boot.</li> <li>• Select terminal emulation mode. Options include the following: <ul style="list-style-type: none"> <li>◦ ANSI (default setting)</li> <li>◦ VT100</li> </ul> </li> <li>• Enable/disable firmware progress event support.</li> <li>• Enable/disable initiate Intel CIRA.</li> </ul>
Set Security Level	Change, view, or hide security levels for all BIOS menu items.
Restore Security Defaults	Restore the default security settings.

---

# 14 MultiBoot

## About the boot device order

As the computer starts, the system attempts to boot from enabled boot devices. The MultiBoot utility, which is enabled at the factory, controls the order in which the system selects a boot device. Boot devices can include optical drives, diskette drives, a network interface card (NIC), hard drives, and USB devices. Boot devices contain bootable media or files that the computer needs to start and operate properly.

---

 **NOTE:** Some boot devices must be enabled in Computer Setup before they can be included in the boot order.

---

The factory setting is for the computer to select the boot device by searching enabled boot devices and drive bay locations in the following order:

---

 **NOTE:** Some of the boot devices and drive bay locations listed may not be supported on your computer.

---

- Notebook upgrade bay
- Internal hard drive
- USB diskette drive
- USB CD-ROM
- USB hard drive
- Notebook Ethernet
- Secure Digital (SD) Memory Card
- Docking station upgrade bay
- External SATA drive

You can change the order in which the computer searches for a boot device by changing the boot order in Computer Setup. You can also press **esc** while the “Press the ESC key for Startup Menu” message is displayed at the bottom of the screen, and then press **f9**. Pressing **f9** displays a menu that shows the current boot devices and allows you to select a boot device. Or, you can use MultiBoot Express to set the computer to prompt you for a boot location each time the computer turns on or restarts.

If MultiBoot is disabled, the computer uses a fixed boot order that consists of first searching for a drive A boot device. If none is found, the computer looks for a drive C boot device. Drive A boot devices include optical drives and diskette drives. Drive C boot devices include optical drives and hard drives.



The NIC does not have an assigned drive letter.

---

 **NOTE:** An optical drive (such as a CD-ROM drive) can boot either as drive A or drive C, depending on the format of the boot CD.

---

The following list describes the factory setting for boot order in which drive letters A and C are assigned when MultiBoot is disabled. (The actual order varies by configuration.)

- Boot order for drive A boot devices:
  1. Optical drive in an optional docking device or in an optional external MultiBay that contains a disc formatted as drive A
  2. Optical drive in the internal MultiBay (select models only) that contains a disc formatted as drive A
  3. Diskette drive in an optional docking device or in an optional external MultiBay
- Boot order for drive C boot devices:
  1. Optical drive in an optional docking device or in an optional external MultiBay that contains a disc formatted as drive C
  2. Optical drive in the internal MultiBay (select models only) that contains a disc formatted as drive C
  3. Hard drive in the computer hard drive bay
  4. Hard drive in an optional docking device or in an optional external MultiBay

---

 **NOTE:** Because no drive letter is associated with the NIC, changing the boot order of a NIC does not affect the drive letters of the other devices.

---

## Enabling boot devices in Computer Setup

The computer will boot to a USB device or a NIC device only if the device has first been enabled in Computer Setup.

To start Computer Setup and enable a USB device or a NIC device as a boot device, follow these steps:

1. Turn on or restart the computer, and then press **esc** while the “Press the ESC key for Startup Menu” message is displayed at the bottom of the screen.
2. Press **f10** to enter BIOS Setup.
3. To enable bootable media in USB drives or in drives inserted into an optional docking device (select models only), use a pointing device or the arrow keys to select **System Configuration > Device Configurations**. Confirm that USB legacy support is selected.

---

 **NOTE:** The USB Port option must be enabled in order to use USB legacy support. It is enabled at the factory. If the port becomes disabled, reenable it by selecting **System Configuration > Port Options**, and then selecting **USB Port**.

---

– or –

To enable a NIC device, select **System Configuration > Boot Options**, and then selecting **PXE Internal NIC boot**.

4. To save your changes and exit Computer Setup, click the **Save** icon in the lower-left corner of the screen, and then follow the on-screen instructions.

– or –

Use the arrow keys to select **File > Save Changes and Exit**, and then press **enter**.

Your changes go into effect when the computer restarts.

---

 **NOTE:** To connect a NIC to a Preboot eXecution Environment (PXE) or Remote Program Load (RPL) server without using MultiBoot, press **esc** while the “Press the ESC key for Startup Menu” message is displayed at the bottom of the screen, and then quickly press **f12**.

---

## Considering boot order changes

Before changing the boot order, note the following considerations:

- When the computer restarts after the boot order has been changed, the computer attempts to start using the new boot order.
- If there is more than one type of boot device, the computer attempts to boot using the first of each type of boot device (except for optical devices). For example, if the computer is connected to an optional docking device (select models only) that contains a hard drive, this hard drive will be shown in the boot order as a USB hard drive. If the system attempts to boot from this USB hard drive and fails, it will not attempt to boot to the hard drive in the hard drive bay. Instead, it will try to boot to the next type of device in the boot order. However, if there are two optical devices, and the first optical device does not boot (either because it does not contain media or the media is not a boot disc), the system will try to boot to the second optical device.
- Changing the boot order also changes the logical drive designations. For example, if you start up from a CD-ROM drive with a disc formatted as drive C, that CD-ROM drive becomes drive C and the hard drive in the hard drive bay becomes drive D.
- The computer will boot from a NIC device only if the device has been enabled in the Built-In Device Options menu of Computer Setup and if booting from the device has been enabled in the Boot Options menu of Computer Setup. Booting from a NIC does not affect logical drive designations because no drive letter is associated with the NIC.
- Drives in an optional docking device (select models only) are treated like external USB devices in the boot order.

## Choosing MultiBoot preferences

You can use MultiBoot in the following ways:

- To set a new boot order that the computer uses each time it is turned on, by changing the boot order in Computer Setup.
- To dynamically choose the boot device, by pressing **esc** while the “Press the ESC key for Startup Menu” message is displayed at the bottom of the screen, and then pressing **f9** to enter the Boot Device Options menu.
- To use MultiBoot Express to set variable boot orders. This feature prompts you for a boot device each time the computer is turned on or restarted.

### Setting a new boot order in Computer Setup

To start Computer Setup and set a boot device order that the computer uses each time it is turned on or restarted, follow these steps:

1. Turn on or restart the computer, and then press **esc** while the “Press the ESC key for Startup Menu” message is displayed at the bottom of the screen.
2. Press **f10** to enter BIOS Setup.
3. Use a pointing device or the arrow keys to select the Legacy Boot Order list, and then press **enter**.
4. To move the device up in the boot order, use a pointing device to click the up arrow or press the **+** key.

– or –

To move the device down in the boot order, click the down arrow or press the **-** key.

5. To save your changes and exit Computer Setup, click the **Save** icon in the lower-left corner of the screen, and then follow the on-screen instructions.

– or –

Use the arrow keys to select **File > Save Changes and Exit**, and then press **enter**.

Your changes go into effect when the computer restarts.

### Dynamically choosing a boot device using the F9 prompt

To dynamically choose a boot device for the current startup sequence, follow these steps:

1. Turn on or restart the computer, press **esc** while the “Press the ESC key for Startup Menu” message is displayed at the bottom of the screen.
2. Open the Boot Device Options menu, by pressing **f9**.
3. Use a pointing device or the arrow keys to select a boot device, and then press **enter**.

Your changes go into effect immediately.

## Setting a MultiBoot Express prompt

To start Computer Setup and set the computer to display the MultiBoot startup location menu each time the computer is started or restarted, follow these steps:

1. Turn on or restart the computer, and then press **esc** while the “Press the ESC key for Startup Menu” message is displayed at the bottom of the screen.
2. Press **f10** to enter BIOS Setup.
3. Use a pointing device or the arrow keys to select **System Configuration > Boot Options**, and then press **enter**.
4. In the **Express Boot Popup Delay (Sec)** field, enter the length of time in seconds that you want the computer to display the startup location menu before it defaults to the current MultiBoot setting. (When 0 is selected, the Express Boot startup location menu is not displayed.)
5. To save your changes and exit Computer Setup, click the **Save** icon in the lower-left corner of the screen, and then follow the on-screen instructions.

– or –

Use the arrow keys to select **File > Save Changes and Exit**, and then press **enter**.

Your changes go into effect when the computer restarts.

## Entering MultiBoot Express preferences

When the Express Boot menu displays during startup, you have the following choices:

- To specify a boot device from the Express Boot menu, select your preference within the allotted time, and then press **enter**.
- To prevent the computer from defaulting to the current MultiBoot setting, press any key before the allotted time expires. The computer will not start until you select a boot device and press **enter**.
- To allow the computer to start according to the current MultiBoot settings, wait for the allotted time to expire.

---

# 15 Management and printing

## Using Client Management Solutions

Client Management Solutions software provides standards-based solutions for managing client (user) desktop, workstation, notebook, and tablet computers in a networked environment.

Client management includes the following key capabilities and features:

- Initial software image deployment
- Remote system software installation
- Software management and updates
- ROM updates
- Tracking and security of computer assets (the hardware and software installed on the computer)
- Fault notification and recovery of certain system software and hardware components

---

 **NOTE:** Support for specific features described in this section may vary, depending on computer model and/or version of management software installed on the computer.

---

## Configuring and deploying a software image

The computer is shipped with a preinstalled system software image. The initial software image is configured during the first-time setup of the computer. After a brief software "unbundling" occurs, the computer is ready to be used.

A customized software image can be deployed (distributed) in one of the following ways:

- Installing additional software applications after unbundling the preinstalled software image
- Using software deployment tools, such as Altiris Deployment Solutions, to replace the preinstalled software with a customized software image
- Using a disk-cloning process to copy the contents from one hard drive to another

The deployment method you use depends on your organization's technology environment and processes.

---

 **NOTE:** The Computer Setup utility and other system features provide further assistance with configuration management and troubleshooting, power management, and the recovery of system software.

---

## Managing and updating software

HP provides several tools for managing and updating software on client computers:

- HP Client Manager for Altiris (select models only)

---

 **NOTE:** To download HP Client Manager for Altiris or to obtain more information about HP Client Manager for Altiris, see the HP Web site at <http://www.hp.com>.

---

- HP Client Configuration Manager (CCM) (select models only)
- HP System Software Manager (SSM)

### HP Client Manager for Altiris (select models only)

HP Client Manager for Altiris integrates Intelligent Manageability technology into Altiris software. HP Client Manager for Altiris provides superior hardware management capabilities for HP devices:

- Detailed views of hardware inventory for asset management
- System Checkup monitoring and diagnostics
- Web-accessible reporting of business-critical details, such as thermal warnings and memory alerts
- Remote updating of system software, such as device drivers and the system BIOS

---

 **NOTE:** Additional functionality can be added when HP Client Manager for Altiris is used with optional Altiris Solutions software (purchased separately).

---

When HP Client Manager for Altiris (installed on a client computer) is used with Altiris Solutions software (installed on an administrator computer), HP Client Manager for Altiris provides increased management functionality and centralized hardware management of client devices for the following IT life-cycle areas:

- Inventory and asset management
  - Software license compliance
  - Computer tracking and reporting
  - Computer lease contract information and fixed asset tracking
- System software deployment and migration
  - Windows migration
  - System deployment
  - Personality (personal user settings) migration

- Help desk and problem resolution
  - Management of help desk tickets
  - Remote troubleshooting
  - Remote problem resolution
  - Client disaster recovery
- Software and operations management
  - Ongoing client management
  - HP system software deployment
  - Application self-healing (the ability to identify and repair certain application problems)

Altiris Solutions software provides easy-to-use software distribution capabilities. HP Client Manager for Altiris enables communication with the Altiris Solutions software, which can be used to complete new hardware deployment or personality migration to a new operating system using easy-to-follow wizards. HP Client Manager for Altiris is available for download from the HP Web site.

When Altiris Solutions software is used in conjunction with HP System Software Manager or HP Client Manager for Altiris, administrators can also update the system BIOS and device driver software from a central console.

## HP Client Configuration Manager (CCM) (select models only)

HP CCM automates the management of software such as operating systems, programs, software updates, and content and configuration settings to ensure that each computer is maintained in the correct configuration. With these automated management solutions, you can manage software throughout the life cycle of the computer.

CCM enables you to perform the following tasks:

- Collect hardware and software inventory across multiple platforms
- Prepare a software package and conduct impact analysis prior to distribution
- Target individual computers, workgroups, or entire populations of computers for deployment and maintenance of software and content according to policies
- Provision and manage operating systems, applications, and content on distributed computers from any location
- Integrate CCM with help desks and other system management tools for seamless operations
- Leverage a common infrastructure for management of software and content on standard computing devices across any network for all enterprise users
- Scale to meet enterprise needs

## HP System Software Manager (SSM)

HP SSM lets you remotely update system-level software on multiple systems simultaneously. When executed on a client computer, SSM detects versions of both hardware and software, and then updates designated software from a central repository, known as a file store. Driver versions that are supported by SSM are denoted with a special icon on the HP driver download Web site and on the



*Support Software* CD. To download the SSM utility or to obtain more information on SSM, see the HP Web site at <http://www.hp.com/go/ssm> (English only).

---

# 16 Cleaning guidelines

This chapter provides the best practices and recommendations for safely cleaning and disinfecting your notebook or tablet PC.

## Cleaning products

Use the following products to safely clean and disinfect your notebook or tablet PC.

- Dimethyl benzyl ammonium chloride 0.3 percent maximum concentration (for example, germicidal disposable wipes. These wipes come in a variety of brand names.)
- Alcohol-free glass cleaning fluid
- Water with mild soap solution
- Dry microfiber cleaning cloth or a chamois (static-free cloth without oil)
- Static-free cloth wipes

---

△ **CAUTION:** Avoid the following cleaning products:

Strong aromatic solvents, such as acetone, ammonium chloride, methylene chloride, and hydrocarbons can permanently damage the surface of the notebook or the tablet PC.

Fibrous materials, such as paper towels, which can scratch the notebook or tablet PC. Over time, dirt particles and cleaning agents can get trapped in the scratches.

---

## Cleaning procedures

Follow the procedures in this section to safely clean your notebook or tablet PC.

- △ **WARNING!** To prevent electric shock or damage to components, do not attempt to clean your notebook or tablet PC while it is turned on. Before cleaning your notebook or tablet PC, turn off the power to the notebook or tablet PC by shutting down the computer, disconnect the external power, and then disconnect all powered external devices.
- △ **CAUTION:** Do not spray cleaning agents or liquids directly on any notebook or tablet PC surface. Liquids that are allowed to drip on the surface can permanently damage internal components.

### Cleaning the display

Gently wipe the display using a soft, lint-free cloth moistened with an *alcohol-free* glass cleaner. Be sure that the display is dry before closing the display lid.

### Cleaning the sides and cover

To clean and disinfect the sides and cover, use a soft microfiber cloth or chamois moistened with one of the cleaning solutions listed previously or use an acceptable germicidal disposable wipe.

-  **NOTE:** When cleaning the cover of the notebook, use a circular motion to aid in removing dirt and debris.

### Cleaning the TouchPad and keyboard

- △ **CAUTION:** When cleaning the TouchPad and keyboard, do not let liquids drip between the keys. A liquid spill can permanently damage internal components.
  - To clean and disinfect the TouchPad and keyboard, use a soft microfiber cloth or chamois moistened with one of the cleaning solutions listed previously, or use an acceptable germicidal disposable wipe.
  - To prevent keys from sticking and to remove dust, lint, and particles trapped beneath the keys, use a can of compressed air with a straw extension.
- △ **WARNING!** To reduce the risk of electric shock or damage to internal components, do not use a vacuum cleaner attachment to clean the keyboard. A vacuum cleaner can deposit household debris on the keyboard surface.

### Cleaning a tablet PC pen and pen holder

Using one of the cleaning solutions listed previously, moisten a soft microfiber cloth or chamois or use an acceptable germicidal disposable wipe:

- To clean the pen, rub the pen in an up and down motion to aid in removing dirt and debris.
- To clean the pen holder, use a rotating motion around the opening of the pen holder.
- △ **CAUTION:** Do not put any fluid or insert any material other than the tablet PC pen in the pen holder. The pen holder is not sealed off from some of the internal electronics of the tablet PC.

---

# Index

- A**
- AC adapter
  - connecting 64
- AC adapter, identifying 13
- administrator password 101
- airport security devices 76
- Altiris Deployment Solutions 138
- AMT options
  - AMT setup prompt (Ctrl-P) 131
  - firmware progress event support 131
  - firmware verbosity 131
  - Initiate Intel CIRA 131
  - terminal emulation mode 131
  - unconfigure AMT on next boot 131
  - USB key provisioning support 131
- antennas 12
- Anti Theft 127
- antivirus software 109
- applications key, Windows 6, 7
- audio devices, connecting
  - external 44
- audio functions, checking 44
- audio, configuring 47
- audio-in (microphone) jack, identifying 8, 12, 40
- audio-out (headphone) jack, identifying 8, 12, 40
- Automatic DriveLock password
  - entering 106
  - removing 106
- AutoPlay 51
- B**
- backing up files 119
- Backup and Restore 118, 119
- battery
  - calibrating 69
  - charging 67, 69
  - conserving power 71
  - disposing 72
  - inserting 66
  - low battery levels 68
  - recharging 71
  - removing 66
  - replacing 72
  - storing 72
- battery bay 10, 14
- battery charge, maximizing 68
- battery check 72
- battery light 67, 68
- battery light, identifying 9
- battery power 65
- battery release latches 66
- battery release latches, identifying 10, 66
- battery temperature 72
- battery, identifying 13
- bays
  - battery 10, 14
  - hard drive 11
- BD
  - playing 50, 55
  - removing 53
- BIOS administrator password 127
- BIOS update
  - downloading 115
  - installing 115
- Bluetooth
  - device 15
  - label 14
- Bluetooth device 21
- boot devices, enabling 134
- boot options 128
- boot order 128
- bottom door
  - removing 92
  - replacing 94, 98
- built-in device
  - ambient light sensor 130
  - audio device 130
  - Bluetooth device 130
  - fingerprint reader 130
  - integrated camera 130
  - internal speakers 130
  - LAN/WLAN switching 130
  - microphone 130
  - modem 130
  - network interface controller (LAN) 130
  - power monitor circuit 130
  - Wake on LAN 130
  - wireless button 130
  - WLAN device 130
  - WWAN device 130
- built-in device options 130
- buttons
  - power 5
  - TouchPad 1
- C**
- cable
  - LAN 30
  - modem 25
- cables
  - USB 83
- calibrating battery 69
- caps lock, identifying 3
- CD
  - copying 52
  - playing 50, 55
  - protecting 42

- removing 53
- writing to 42
- CD drive 78, 85
- Certificate of Authenticity label 14
- changing boot order 136
- charging batteries 67, 69
- checking audio functions 44
- cleaning
  - display 143
  - keyboard 143
  - pen holder 143
  - tablet PC pen 143
  - TouchPad 143
- cleaning guidelines 142
- cleaning procedures 143
- cleaning products 142
- compartments
  - memory module 11
- components
  - additional hardware 13
  - bottom 9
  - front 7
  - left-side 9
  - multimedia 11
  - right-side 8
  - top 1
  - wireless antennas 12
- composite video 34
- computer information 114
- Computer Setup
  - BIOS administrator password 102
  - device security 107
  - DriveLock password 103
  - enabling bootable devices 134
  - File menu 126
  - navigating and selecting 124
  - restoring factory settings 125
  - Security menu 126
  - setting boot order 136
  - setting MultiBoot Express prompt 137
  - System Configuration menu 127
- Computer Setup utility 138
- configuring ExpressCards 88
- connecting to a LAN 30
- connecting to a WLAN 19
- Connection Manager icon 15
- connection, external power 64
- connector, power 9
- conservation, power 71
- copyright warning 51
- cord, power 13
- corporate WLAN connection 19
- country-specific modem cable adapter 26
- creating a backup 119
- critical battery level 68
- D**
  - deployment, software 138
  - device configurations 128
  - device drivers
    - HP drivers 57
    - Microsoft drivers 58
    - reinstalling 57
  - device security 107
  - digital card
    - inserting 86
    - removing 87
    - stopping 87
  - Disk Cleanup software 77
  - Disk Defragmenter software 77
  - disk sanitizer 127
  - diskette drive 78, 85
  - display
    - cleaning 143
    - image, switching 34
    - screen brightness hotkeys 34
  - drive media 61
  - DriveLock password
    - changing 104
    - description 103
    - entering 104
    - removing 105
    - setting 104
  - DriveLock, automatic 127
  - drives
    - boot order 128, 132
    - caring for 75
    - diskette 78, 85
    - DVD-ROM 48
    - DVD±R SuperMulti DL LightScribe Drive 48
    - external 78, 85
    - hard 78, 79, 80, 85
    - optical 78, 85
- See *also* hard drive; optical drive
- DVD
  - changing region setting 51
  - copying 52
  - playing 50, 55
  - protecting 42
  - removing 53
  - writing to 42
- DVD drive 78, 85
- DVD region settings 51
- E**
  - earbuds 12, 40
  - embedded keypad keys, identifying 6, 7
  - encryption 19
  - esc key, identifying 6, 7
  - Execution enabled 128
  - ExpressCard
    - configuring 88
    - inserting 88
    - removing 89
    - removing insert 88
    - stopping 89
  - ExpressCard slot, identifying 9
  - external audio devices, connecting 44
  - external drive 78, 85
  - external monitor port 46
  - external monitor port, identifying 9
- F**
  - f11 recovery 122
  - File menu 126
  - firewall 19
  - fn key 31
  - fn key, identifying 6, 7
  - function keys, identifying 6, 7, 31
- H**
  - hard disk drive
    - external 78
    - installing 80
    - replacing 79
  - hard drive
    - external 78, 85
    - installing 80
    - replacing 79
  - hard drive bay, identifying 11

- hard drive recovery 122
  - hardware, identifying 1
  - HDMI port 34, 46
  - headphone (audio-out) jack 8, 12, 40
  - headphones 12, 40
  - Help and Support hotkey 34
  - Hibernation
    - exiting 62
    - initiated during critical battery level 68
    - initiating 62
  - hotkeys
    - audio CD or DVD controls 36
    - decreasing screen brightness 34
    - decreasing speaker volume 35
    - description 31
    - displaying system information 33
    - increasing screen brightness 34
    - increasing speaker volume 36
    - initiating QuickLock 35
    - initiating Sleep 35
    - muting speaker sound 35
    - opening Help and Support 34
    - switching screen image 34
    - using 33
    - volume mute 41
  - HP Client Configuration Manager 139, 140
  - HP Client Manager for Altiris 139
  - HP QuickLook 129
  - HP SpareKey enrollment 127
  - HP System Software Manager 139, 140
  - hubs 83
- I**
- icons
    - Connection Manager 15
    - network 23
    - network status 15
    - wireless 15
  - image, computer 138
  - Intel HT Technology 129
  - interference, minimizing 24
  - internal display switch, identifying 5
  - Internet connection setup 18
- J**
- jacks
    - audio-in (microphone) 8, 40
    - audio-out (headphone) 8, 40
    - RJ-11 (modem) 8
    - RJ-45 (network) 9
- K**
- keyboard hotkeys, identifying 31
  - keyboard, cleaning 143
  - keypad, embedded
    - enabling and disabling 37
    - switching key functions 37
    - using 37
  - keypad, external
    - num lock 38
    - using 38
  - keys
    - embedded keypad 6, 7
    - esc 6, 7
    - fn 6, 7
    - function 6, 7
    - Windows applications 6, 7
    - Windows logo 6, 7
    - wireless 6, 7
- L**
- labels
    - Bluetooth 14
    - Microsoft Certificate of Authenticity 14
    - modem approval 14
    - regulatory 14
    - service tag 13
    - wireless certification 14
    - WLAN 14
  - LAN, connecting 30
  - language, changing in Computer Setup 127
  - latches, battery release 10
  - legacy support, USB 124, 128
  - lights
    - battery 9
    - caps lock 3
    - power 4
    - wireless 4
  - local area network (LAN)
    - cable required 30
    - connecting cable 30
  - logical drive designations 135
  - low battery level 68
- M**
- maintenance
    - Disk Cleanup 77
    - Disk Defragmenter 77
  - media controls, hotkeys 36
  - memory module
    - adding 92
    - inserting 97
    - removing 93, 97
    - replacing 92, 96
    - upgrading primary 96
  - memory module compartment, identifying 11
  - memory, replacing memory modules 92, 96
  - microphone (audio-in) jack 8
  - microphone, identifying 12, 40
  - Microsoft Certificate of Authenticity label 14
  - minimizing interference 24
  - modem approval label 14
  - modem cable
    - connecting 25
    - country-specific cable adapter 26
    - noise suppression circuitry 25
  - modem software
    - setting/adding location 26
    - travel connection problems 28
  - monitor port, external 9
  - monitor, connecting 46
  - mouse, external
    - connecting 31
    - setting preferences 31
  - Multi Core CPU 129
  - MultiBoot Express 132, 137
  - multimedia components, identifying 39
  - multimedia software
    - using 42
  - mute hotkey 41

## N

- network cable
  - connecting 30
  - noise suppression circuitry 30
- network icon 23
- network key 23
- network security codes
  - network key 23
  - SSID 23
- Network Service Boot 134
- network status icon 15
- NIC boot device 132, 134
- noise suppression circuitry
  - modem cable 25
  - network cable 30
- num lock, external keypad 38
- numeric keypad 6, 7

## O

- operating system
  - Microsoft Certificate of Authenticity label 14
  - Product Key 14
- optical disc
  - removing 53
  - using 48
  - writing to 42
- optical drive
  - playing 55
  - protecting 42
- optical drive, identifying 8

## P

- parallel port mode 128
- passwords
  - administrator 101
  - BIOS administrator 102
  - DriveLock 103
  - user 101
- pointing devices
  - setting preferences 31
- port options
  - 1394 port 131
  - eSATA port 131
  - ExpressCard slot 131
  - flash media reader 131
  - parallel port 131
  - serial port 131
  - USB port 131

## ports

- external monitor 9, 46
- HDMI 9, 46
- USB 8, 9, 83
- power
  - connecting 64
  - conserving 71
- power button, identifying 5
- power connector, identifying 9
- power cord, identifying 13
- power light, identifying 4
- Product Key 14
- product name and number, computer 13
- programs
  - using multimedia 42
- projector, connecting 46
- protecting playback 55
- public WLAN connection 19
- PXE server 134

## Q

- QuickLock hotkey 35

## R

- readable media 61
- recovery partition 122
- region codes, DVD 51
- regulatory information
  - modem approval label 14
  - regulatory label 14
  - wireless certification labels 14
- release latches, battery 10, 66
- restore
  - factory settings 126
  - security defaults 131
- restoring
  - hard drive 122
- RJ-11 (modem) jack, identifying 8
- RJ-45 (network) jack, identifying 9

## S

- SATA (Serial Advanced Technology Attachment) devices
  - AHCI (Advanced Host Controller Interface) 128
  - IDE (Integrated Drive Electronics) 128
- screen brightness hotkeys 34

- screen image, switching 34
- scroll zone, TouchPad 2
- SD Card Reader, identifying 8
- Secondary Battery Fast Charge 129
- security cable slot, identifying 9
- Security menu
  - always prompt for HP SpareKey enrollment 127
  - Automatic DriveLock 127
  - change password 127
  - DriveLock 127
  - fingerprint reader reset 127
  - HP Sparekey 127
  - HP Sparekey enrollment 127
  - password policy 127
  - set up BIOS administrator password 127
  - System IDs 127
- security, wireless 18
- serial number, computer 13
- service tag 13
- set security level 131
- setup of WLAN 18
- setup utility
  - File menu 126
  - navigating and selecting 124
  - restoring factory settings 125
  - Security menu 126
  - System Configuration menu 127
- setup, computer 1
- shutdown 73
- shutting down 73
- Sleep
  - exiting 61
  - initiating 61
- Sleep hotkey 35
- slots
  - ExpressCard 9
  - memory 91
  - memory module 11
  - security cable 9
  - WLAN 11
- SoftPaqs, downloading 116, 117
- software
  - BIOS update 115
  - deployment 138
  - Disk Cleanup 77
  - Disk Defragmenter 77

- recovery 138
- updates 139
- updating programs and drivers 116
- using 42
- Wireless Assistant 17
- speaker, identifying 4, 12, 40
- storing battery 72
- system
  - date and time 126
  - diagnostics 126
  - fan 128
  - IDs 127
  - information 126
- System Configuration menu 127
- system information
  - hotkey 33

## T

- temperature 72
- tips, webcam 59
- TouchPad
  - cleaning 143
  - using 31
- TouchPad button, identifying 1
- TouchPad scroll zone, identifying 2
- TouchPad, identifying 1
- traveling with the computer
  - modem approval label 14
- troubleshooting
  - AutoPlay 56
  - device drivers 57
  - disc burning 57
  - disc does not play 55
  - external display 56
  - HP device drivers 57
  - Microsoft device drivers 58
  - modem 28
  - movie play 56
  - optical disc tray 53
  - optical drive detection 54
  - wireless network problems 22
- turning off the computer 73
- TXT (Trusted Execution Technology) 129

## U

- Unified Extensible Firmware Interface (UEFI) mode 128

- unresponsive system 73
- updates, software 139
- USB cable, connecting 83
- USB devices
  - connecting 83
  - description 83
  - removing 83
- USB hubs 83
- USB legacy support 84, 124, 128
- USB ports, identifying 8, 9, 83
- user password 101
- using the webcam 59

## V

- vents, identifying 9, 11
- video transmission types 34
- Virtualization Technology 129
- volume
  - hotkeys 41
  - mute hotkey 41
- volume, adjusting 41

## W

- Web sites
  - HP System Software Manager 141
- webcam
  - identifying 40
  - tips 59
  - using 59
- webcam light, identifying 11
- webcam properties, adjusting 59
- webcam, identifying 11
- Windows 7 operating system
  - DVD 122
- Windows applications key, identifying 6, 7
- Windows logo key, identifying 6, 7
- wireless antennas 12
- Wireless Assistant software 16, 17
- wireless certification label 14
- wireless controls
  - Connection Manager software 16
  - key 16
  - operating system 16
  - Wireless Assistant software 16

- wireless devices, types 15
- wireless icon 15
- wireless key 16
- wireless key, identifying 6, 7
- wireless light 16
- wireless light, identifying 4
- wireless network (WLAN)
  - connecting 19
  - corporate WLAN connection 19
  - described 15
  - equipment needed 18
  - functional range 20
  - public WLAN connection 19
  - security 18
  - using 18
- wireless network problems, troubleshooting 22
- WLAN device 14, 15, 18
- WLAN label 14
- WLAN module compartment, identifying 11
- writable media 61



