



# HP ScanJet Enterprise 8500 fn1

User Guide

**Copyright and License**

© Copyright 2015 HP Development Company, L.P.

Reproduction, adaptation, or translation without prior written permission is prohibited, except as allowed under the copyright laws.

The information contained herein is subject to change without notice.

The only warranties for HP products and services are set forth in the express warranty statements accompanying such products and services. Nothing herein should be construed as constituting an additional warranty. HP shall not be liable for technical or editorial errors or omissions contained herein.

Edition 1, 11/2015

**Trademark Credits**

Adobe®, Adobe Photoshop®, Acrobat®, and PostScript® are trademarks of Adobe Systems Incorporated.

Apple and the Apple logo are trademarks of Apple Computer, Inc., registered in the U.S. and other countries. iPod is a trademark of Apple Computer, Inc. iPod is for legal or rightholder-authorized copying only. Don't steal music.

Microsoft®, Windows®, Windows® XP, and Windows Vista® are U.S. registered trademarks of Microsoft Corporation.

UNIX® is a registered trademark of The Open Group.

---

# Table of contents

<b>1 Product basics</b> .....	<b>1</b>
Product features .....	2
Front view .....	4
Back view .....	4
Sleep Mode .....	6
Auto-shutdown feature .....	7
<b>2 Control panel</b> .....	<b>9</b>
Control-panel layout .....	10
Interpret control panel status lights .....	11
Control panel messages .....	12
Home screen .....	13
Buttons on the touch screen .....	14
Control-panel help system .....	15
<b>3 Administration - Configure the product</b> .....	<b>17</b>
Supported utilities for Windows .....	18
HP Web Jetadmin .....	18
Embedded Web Server .....	18
HP Digital Sending Software (HP DSS) .....	18
Supported network protocols .....	19
Supported e-mail protocols .....	21
Basic configuration using the Administration menu .....	22
Navigate the Administration menu .....	22
Jetdirect menus .....	23
Configure language settings .....	28
Configure time settings .....	28
Assign IP address .....	28
Set up and configure e-mail settings using the E-mail Setup Wizard .....	29
Manually configure IPv4 TCP/IP parameters from the control panel .....	29
Manually configure IPv6 TCP/IP parameters from the control panel .....	30

Disable network protocols (optional) .....	30
Link speed and duplex settings .....	31
Basic configuration using the Embedded Web Server .....	32
View or change network settings .....	32
Set or change the administrator password .....	32
Configure e-mail options .....	32
Save to Network Folder Setup .....	33
Configure save to SharePoint options .....	33
Configure USB storage device settings .....	34
Configure Quick Sets .....	34
Configure general security settings .....	35
Configure access control security settings .....	35
Additional configuration using the Embedded Web Server .....	36
<b>4 Administration - Manage the product .....</b>	<b>37</b>
Use information pages .....	38
Use the Embedded Web Server .....	39
Open the Embedded Web Server .....	39
Embedded Web Server options .....	39
Use HP Web Jetadmin software .....	41
Controlling digital-sending security .....	42
Network authentication .....	42
Secure e-mail .....	42
Restrict software access .....	42
Security features .....	43
Secure the Embedded Web Server .....	43
Manage temporary job files .....	43
Secure Storage Erase .....	44
Data affected .....	44
Secure File Erase .....	44
Secure Disk Erase .....	44
HP High-Performance Secure Hard Disks .....	44
Manage certificates .....	45
Load a certificate .....	45
Load a certificate revocation list (CRL) .....	45
Authentication and authorization .....	45
Energy settings .....	47
Upgrade the firmware .....	48
Backup product data .....	49
Restore product data .....	50

<b>5 Load originals .....</b>	<b>51</b>
Use the automatic document feeder (ADF) .....	52
Document loading tips .....	52
Document loading tips for mixed-size documents .....	53
How to load documents .....	53
Use the scanning glass .....	55
<b>6 Scan and send documents .....</b>	<b>57</b>
Sign in .....	57
New scanner features .....	58
Preview a scan .....	59
Use the Image Preview screen .....	59
Send a scanned document to one or more e-mails .....	61
Use the address book .....	61
Create a recipient list .....	61
Use the Personal or Shared Contacts address book .....	61
Add entries to the Personal or Shared Contacts address books .....	61
Delete entries from the Personal Contacts address book .....	62
Use the Send E-mail screen .....	62
Send documents .....	63
Send a document .....	63
Use the auto-complete function .....	63
Fax a scanned document .....	64
Use the Send Fax screen .....	64
Send a fax .....	65
Save to a network folder or USB storage device .....	66
Save to a SharePoint site .....	67
Send or save a document using Quick Sets .....	68
Scan to a workflow destination .....	69
<b>7 Maintain the product .....</b>	<b>71</b>
Order maintenance and scanning supplies .....	72
Clean the touch screen .....	72
Clean the scanning glass, scanning strip, and automatic document feeder (ADF) duplex background .....	72
Clean the rollers .....	76
<b>8 Replace and install components .....</b>	<b>79</b>
Replace the rollers .....	80
Replace the separation pad .....	84
Replace the front panel .....	88

Replace the keyboard .....	91
Replace the hard drive .....	93
Install a Jetdirect card .....	96
Install an accessory into the hardware integration pocket .....	98
<b>9 Troubleshooting .....</b>	<b>101</b>
Scan errors .....	101
Basic troubleshooting tips .....	103
Installation problems .....	104
Initialization or hardware problems .....	104
Check the Ethernet connection .....	104
Check that the product has power .....	105
Reset the product .....	105
The product has paused or shut down .....	106
The product is displaying a “pause” message on the touch screen .....	106
I received an e-mail indicating that the product has shut down .....	106
Paper feeding problems .....	107
Paper jamming, skewing, misfeeds, or multiple-page feeds .....	107
Scanning fragile originals .....	107
Paper does not feed from the product .....	107
Originals are curling up in the document output tray .....	108
The bottom of the scanned image is cut off .....	108
The scanned images have streaks or scratches .....	108
An item loaded in the document input tray jams repeatedly .....	108
Clear jams from the paper path .....	108
The product has stopped working correctly .....	110
Solve e-mail problems .....	111
Validate the SMTP gateway address .....	111
Validate the LDAP gateway address .....	111
Solve network problems .....	112
Restore factory settings .....	113
Contact HP Support .....	113
<b>10 Specifications and warranty .....</b>	<b>115</b>
Product specifications .....	116
Document feeder specifications .....	116
Environmental specifications .....	116
Certificate of Volatility .....	117
Volatile memory .....	117
Non-volatile memory .....	117
Hard disk drive memory .....	117

Regulatory model number .....	118
Environmental product stewardship program .....	119
Protecting the environment .....	119
Ozone production .....	119
Power consumption .....	120
Toner consumption .....	120
Paper use .....	120
Plastics .....	120
HP LaserJet print supplies .....	120
Paper .....	121
Material restrictions .....	121
Disposal of waste equipment by users (EU and India) .....	121
Electronic hardware recycling .....	121
Brazil hardware recycling information .....	122
Chemical substances .....	122
Product Power Data per European Union Commission Regulation 1275/2008 .....	122
SEPA Ecolabel User Information (China) .....	122
The regulation of the implementation on China energy label for printer, fax, and copier .....	122
Restriction on Hazardous Substances statement (India) .....	123
Restriction on Hazardous Substances statement (Turkey) .....	123
Restriction on Hazardous Substances statement (Ukraine) .....	123
Substances Table (China) .....	123
Material Safety Data Sheet (MSDS) .....	124
EPEAT .....	124
For more information .....	124
HP limited warranty statement .....	125
UK, Ireland, and Malta .....	126
Austria, Belgium, Germany, and Luxemburg .....	126
Belgium, France, and Luxemburg .....	127
Italy .....	128
Spain .....	128
Denmark .....	129
Norway .....	129
Sweden .....	129
Portugal .....	129
Greece and Cyprus .....	130
Hungary .....	130
Czech Republic .....	130
Slovakia .....	131
Poland .....	131
Bulgaria .....	131

Romania .....	132
Belgium and the Netherlands .....	132
Finland .....	132
Slovenia .....	133
Croatia .....	133
Latvia .....	133
Lithuania .....	134
Estonia .....	134

<b>Index .....</b>	<b>135</b>
--------------------	------------



---

# 1 Product basics

This User Guide covers what you need to know about using your product.

- [Product features](#)
- [Front view](#)
- [Back view](#)
- [Sleep Mode](#)
- [Auto-shutdown feature](#)

# Product features

**Table 1-1 Features**

<b>Resolution</b>	600 pixels per inch (ppi)
<b>Memory</b>	<ul style="list-style-type: none"><li>• 1792 MB of random-access memory (RAM).<ul style="list-style-type: none"><li>◦ 512 MB on formatter</li><li>◦ 1024 MB on scanner</li><li>◦ 256 on Jetdirect Inside (JDI) networking</li></ul></li><li>• Memory Enhancement technology (MEt) automatically compresses data to use RAM more efficiently.</li></ul>
<b>User interface</b>	<ul style="list-style-type: none"><li>• HP Easy Select full color control panel</li><li>• Embedded Web Server (EWS) to configure the product and gain access to support</li></ul>
<b>Paper-handling</b>	<ul style="list-style-type: none"><li>• <b>Document feeder:</b> Holds up to 100 sheets of paper.</li><li>• <b>Two-sided scanning:</b> The document feeder has an automatic duplexer for scanning two-sided documents.</li><li>• <b>Blank page suppression:</b> Suppresses blank pages in scanned output (works best with white or light-colored pages).</li><li>• <b>Standard output tray:</b> The output tray is located near the bottom of the product.</li><li>• HP Precision Feed technology with multiphase pick process, advanced separation and intelligent picking technologies, mixed-stack handling, and ultrasonic double-feed detection.</li></ul>
<b>Connectivity</b>	<ul style="list-style-type: none"><li>• Local area network (LAN) connector (RJ-45) for Jetdirect Inside (JDI)</li><li>• One enhanced input/output (EIO) slot</li><li>• Covered USB 2.0 connection for FAT-formatted portable storage device. The Administrator must enable this USB port before it can be used. <b>NOTE:</b> USB-connected external hard drives are not supported.</li><li>• Optional HP Digital Sending Software (DSS).</li><li>• Hardware integration pocket.</li></ul>
<b>Environmental features</b>	<ul style="list-style-type: none"><li>• <a href="#">Sleep Timer Settings</a> saves energy by causing the scanner to default to Sleep Mode after 15 minutes of inactivity.</li><li>• High content of recyclable components and materials</li><li>• ENERGY STAR® qualified</li></ul>
<b>Security features</b>	<ul style="list-style-type: none"><li>• Secure disk erase</li><li>• Secure storage erase</li><li>• Secure file erase</li><li>• Authentication</li></ul>

**Table 1-1 Features (continued)**

---

	<ul style="list-style-type: none"><li>◦ User access code authentication</li><li>◦ Windows (Kerberos and NTLM)</li><li>◦ LDAP</li><li>• Jetdirect Inside (JDI)<ul style="list-style-type: none"><li>◦ IPsec</li><li>◦ Password protection</li><li>◦ SSL</li><li>◦ TLS</li><li>◦ SNMPv3</li><li>◦ 802.1x authentication</li><li>◦ IPP over TLS</li></ul></li><li>• Secure communication between the product and network servers</li><li>• IPsec security (hardware)</li><li>• HP High-Performance Secure Hard Disk</li></ul>
<b>Scanning and sending</b>	<ul style="list-style-type: none"><li>• Modes for text, graphics, and mixed text and graphics formats</li><li>• Embedded OCR</li><li>• Job-interrupt feature</li><li>• Control-panel animations (for example, jam recovery)</li><li>• Scan and send to e-mail, fax, network folder, USB device, and SharePoint<ul style="list-style-type: none"><li>◦ Address book for e-mail and fax</li><li>◦ Send to digital fax (Internet and LAN fax)</li></ul></li><li>• Retrieve contacts from a network directory (LDAP)</li><li>• Automatic duplex (two-sided) scanning</li></ul>

---

## Front view

**⚠ CAUTION:** If you need to move the product, always lift the product from the base. Do not lift using the keyboard.

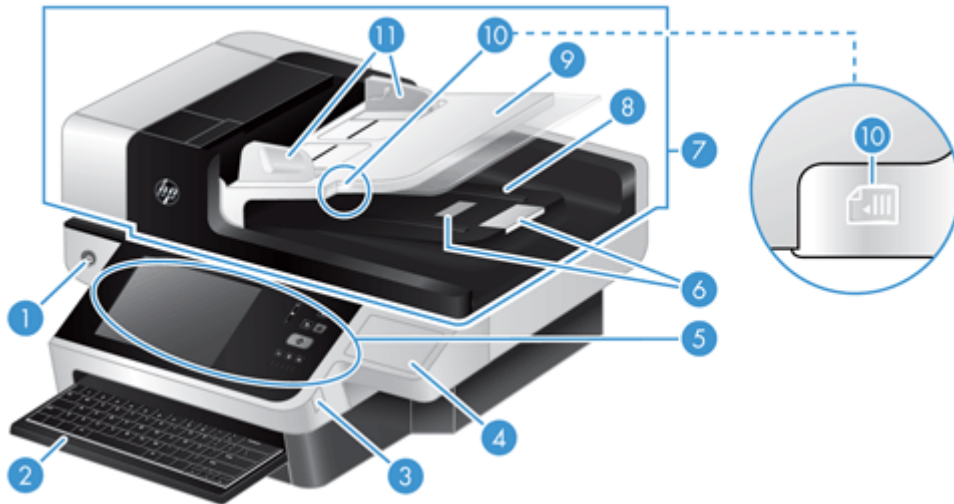

1	Power button
2	Keyboard
3	Covered USB connector for FAT-formatted portable storage device
4	Covered hardware integration pocket
5	Control panel
6	Paper stops
7	Automatic document feeder (ADF)
8	ADF output tray
9	ADF input tray
10	Document load/detect LED
11	Paper guides

## Back view

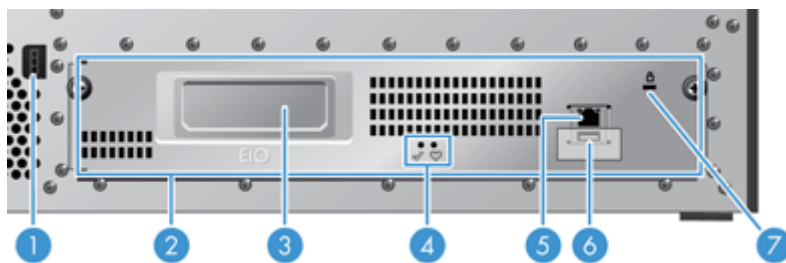

1	Power connector
2	Rear panel drawer assembly

---

3	EIO card slot
4	Formatter status LEDs (both are green; under normal conditions, the left LED is on steady and the right LED blinks)
5	Ethernet port
6	USB host port (under user-removable label)
7	Slot for a cable-type security lock

---

## Sleep Mode

The scanner will enter Sleep Mode after 15 minutes of inactivity. To exit Sleep Mode, do any one of the following:

- Press any button
- Touch the touch screen
- Lift the flatbed scanner lid
- Connect a USB device

## Auto-shutdown feature

This product is equipped with a safety feature that protects from overheating due to a blocked fan vent or a fan failure.

- Under some conditions, the touch screen will display a “pause” message for 12 minutes before initiating shutdown.
- If the product detects that the fan has failed (causing the drive to overheat), the product will shut itself down. If this occurs, the product will send e-mail to notify the current user (if the user is logged in) and the administrator of the shutdown.





---







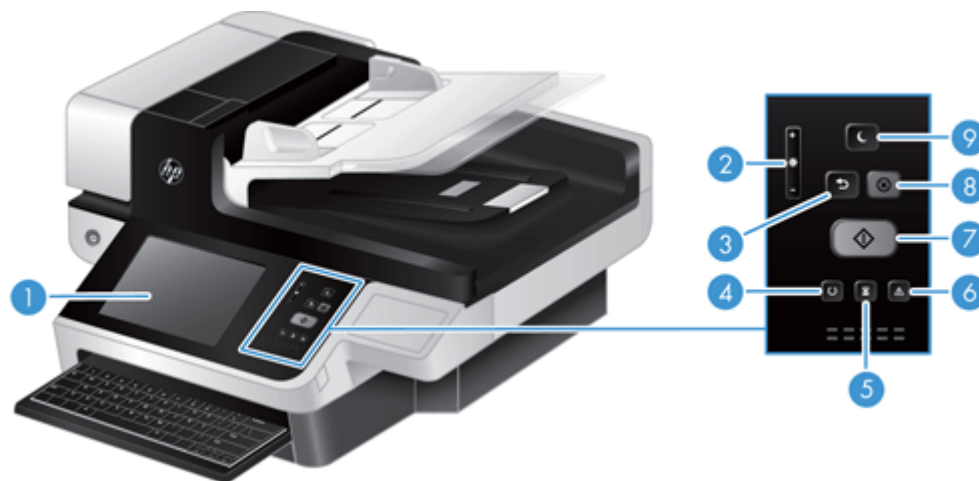

## 2 Control panel

- [Control-panel layout](#)
- [Interpret control panel status lights](#)
- [Control panel messages](#)
- [Home screen](#)
- [Buttons on the touch screen](#)
- [Control-panel help system](#)

## Control-panel layout















The control panel includes a touch screen graphical display, job-control buttons, a keyboard, and three light-emitting diode (LED) status lights.



1		Touch screen	Use the touch screen to access product functions.
2		Touch screen brightness-adjustment control	Use this control to increase or decrease the brightness of the touch screen display.
3		Reset button	Resets the job settings to factory or user-defined default values.
4		Ready LED	The Ready LED indicates that the product is ready to begin processing any job.
5		Data LED	The Data LED indicates that the product is receiving data.
6		Attention LED	The Attention LED indicates that the product has a condition that requires intervention.
7		Start button	Starts digital sending (e-mail and fax, for example), or continues a job that has been interrupted.
8		Stop button	Stops the active job and opens the Job Status screen.
9		Sleep button	If the product is inactive for a long period of time, it automatically enters a sleep mode. To place the product into sleep mode or to reactivate the product, press the Sleep button.

## Interpret control panel status lights

The product has six LEDs on the control panel that indicate product status. The table below explains how to interpret these LEDs.

LED behavior	Description
All LEDs are off.	The product is turned off.
Sleep LED  is on.	The scanner is in sleep (power conservation) mode.
Sleep LED  is flashing.	The scanner is entering or exiting sleep mode.
Sleep LED  is off.	The scanner is not in sleep mode, nor is it transitioning sleep status (on or off).
Power LED  is on.	The product is powered on.
Power LED  is blinking.	The AC adapter is plugged in to the product, and the product is turned off.
Power LED  is off.	The power supply is not providing power to the product.
Ready LED  is on.	The product is online and able to accept input.
Ready LED  is flashing.	The product is pausing a request or has stopped receiving input.
Ready LED  is off.	The product is paused and unable to accept input. This may be because the product was deliberately paused, or because the product is in an error state.
Data LED  is on.	The product has data buffered that it has finished processing and is waiting for more data to be transmitted, or the product is paused. When the Attention LED is flashing at the same time, there is an error and there is data waiting to be processed.
Data LED  is flashing.	The product is receiving or processing data.
Data LED  is off.	There is no data for the product to process.
Attention LED  is on.	The product has encountered a critical error, the nature of which is indicated on the display.
Attention LED  is flashing quickly.	The product has encountered an error which requires user intervention, such as a jam in the automatic document feeder.
Attention LED  is off.	No error condition exists.



**NOTE:** Status and error conditions appear on the display.

## Control panel messages

The product provides robust control panel messaging. When a message appears on the control panel, follow the on-screen instructions to resolve the issue. If the product displays an “Error” or “Attention” message, and no steps are shown to resolve the issue, turn the product off then on. Contact HP support if you continue to experience issues with the product.

To get additional information for warnings that appear in the status line, touch the Warning button.

For additional information on a variety of topics, touch the Help button in the upper-right corner of the Home screen.

# Home screen

The Home screen provides access to the product features, and it indicates the current status of the product.



1	Features	<p>Depending on how the product is configured, the features that appear in this area can include any of the following items:</p> <ul style="list-style-type: none"> <li>• Fax</li> <li>• E-mail</li> <li>• Job Status</li> <li>• Save to Network Folder</li> <li>• Save to USB</li> <li>• Quick Sets</li> <li>• Workflow</li> <li>• Administration</li> <li>• Service</li> </ul>
2	Product status line	The status line provides information about the overall product status. Various buttons appear in this area, depending on the current status.
3	Help button	Touch the Help button to open the embedded help system.
4	Scroll bar	Touch the up or down arrows on the scroll bar to see the complete list of available features.
5	<a href="#">Sign In/Sign Out</a>	Touch this button to sign in or sign out of the product. After you sign out, the product restores all options to the default settings.
6	<a href="#">Network Address</a> button	Touch the <a href="#">Network Address</a> button to find information about the network connection.
7	<a href="#">Language</a> button	Touch the <a href="#">Language</a> button to open the <a href="#">Language</a> screen and change the touch screen display language.
8	Date and time	The current date and time appear here. You can select the format that the product uses to show the date and time, for example 12-hour format or 24-hour format.

## Buttons on the touch screen

The touch screen provides information about the product status. Various buttons can appear in this area.



**Home button.** Touch this button to go to the Home screen from any other screen.



**Start button.** Touch this button to begin the action for the feature that you are using.

**NOTE:** The name of this button changes for each feature. For example, in the digital fax feature, the button is named [Send Fax](#).



**Error button.** This button appears whenever the product has an error that requires attention before it can continue. Touch the Error button to see a message that describes the error. The message also has instructions for solving the problem.



**Warning button.** This button appears when the product has a problem but can continue functioning. Touch the Warning button to see a message that describes the problem. The message also has instructions for solving the problem.



**Help button.** Touch this button to open the built-in online Help system.



**Language button.** Touch this button to open the [Language](#) screen and set the touch screen display language.

---

## Control-panel help system

The product has a built-in Help system that explains how to use each screen. To open the Help system, touch the Help button in the upper-right corner of the screen.

For some screens, the Help opens to a global menu where you can search for specific topics. You can browse through the menu structure by touching the buttons in the menu.

For screens that contain settings for individual jobs, the Help opens to a topic that explains the options for that screen.

If the product alerts you of an error or warning, touch the Error or Warning button to open a message that describes the problem. The message also contains instructions to help solve the problem.





---

## 3 Administration - Configure the product

A network administrator will need to configure the product for use on the network, so you can scan to e-mail and other destinations. The configuration settings are accessible from the Embedded Web Server, HP Web Jetadmin software, or the control panel.

- [Supported utilities for Windows](#)
- [Supported network protocols](#)
- [Supported e-mail protocols](#)
- [Basic configuration using the Administration menu](#)
- [Basic configuration using the Embedded Web Server](#)
- [Additional configuration using the Embedded Web Server](#)

## Supported utilities for Windows

- [HP Web Jetadmin](#)
- [Embedded Web Server](#)
- [HP Digital Sending Software \(HP DSS\)](#)

### HP Web Jetadmin

HP Web Jetadmin is a simple print and imaging peripheral management software tool that helps optimize product use, control color costs, secure products, and streamline supplies management by enabling remote configuration, proactive monitoring, security troubleshooting, and reporting of printing and imaging products.

To download a current version of HP Web Jetadmin and for the latest list of supported host systems, visit [www.hp.com/go/webjetadmin](http://www.hp.com/go/webjetadmin).

When installed on a host server, a Windows client can gain access to HP Web Jetadmin by using a supported Web browser (such as Microsoft® Internet Explorer) by navigating to the HP Web Jetadmin host.

### Embedded Web Server

The product is equipped with an Embedded Web Server, which provides access to information about product and network activities. This information appears in a Web browser, such as Microsoft Internet Explorer or Mozilla Firefox.

The Embedded Web Server resides on the product. It is not loaded on a network server.

The Embedded Web Server provides an interface to the product that anyone who has a network-connected computer and a standard Web browser can use. No special software is installed or configured, but you must have a supported Web browser on your computer. To gain access to the Embedded Web Server, type the IP address for the product in the address line of the browser. (To find the IP address, touch the [Network Address](#) button on the Home screen.)

### HP Digital Sending Software (HP DSS)

You can install the optional HP Digital Sending Software. This software runs as a service on a network server and allows multiple products to send jobs through the server. It is not necessary to install any software or drivers on individual users' computers. For information about compatible versions of HP DSS and to purchase the software, see [www.hp.com/go/dss](http://www.hp.com/go/dss).

# Supported network protocols

The product supports the TCP/IP network protocol, the most widely used and accepted networking protocol. Many networking services utilize this protocol. The following tables list the supported networking services and protocols.

**Table 3-1 Network device discovery**

Service name	Description
SLP (Service Location Protocol)	Device-discovery protocol, used to help find and configure network devices. Used primarily by Microsoft-based programs.

**Table 3-2 Messaging and management**

Service name	Description
HTTP (Hyper Text Transfer Protocol)	Allows Web browsers to communicate with the Embedded Web Server.
EWS (Embedded Web Server)	Allows you to manage the product through a Web browser.
SNMP (Simple Network Management Protocol)	Used by network applications for product management. SNMP v1, SNMP v3, and standard MIB-II (Management Information Base) objects are supported.
LLMNR (Link Local Multicast Name Resolution)	Specifies if the product responds to LLMNR requests over IPv4 and IPv6.
TFTP Configuration	Use TFTP to download a configuration file containing additional configuration parameters, such as SNMP or non-default settings, for Jetdirect Inside (JDI).

**Table 3-3 IP addressing**

Service name	Description
DHCP (Dynamic Host Configuration Protocol)	For automatic IPv4 and IPv6 address assignment. The DHCP server provides the product with an IP address. Generally, no user intervention is required for the product to obtain an IP address from a DHCP server.
BOOTP (Bootstrap Protocol)	For automatic IP address assignment. The BOOTP server provides the product with an IP address. Requires the administrator to input a product's MAC hardware address on the BOOTP server for the product to obtain an IP address from that server.
Auto IP	For automatic IP address assignment. If neither a DHCP server nor a BOOTP server is present, the product uses this service to generate a unique IP address.
Manual	For manual IP address assignment. Requires the administrator to manually assign a static IP address.

**Table 3-4 Security features**

<b>Service name</b>	<b>Description</b>
IPsec/Firewall	Provides network-layer security on IPv4 and IPv6 networks. A firewall provides simple control of IP traffic. IPsec provides additional protection through authentication and encryption protocols.
SNMP v3	Employs a user-based security model for SNMP v3, which provides user authentication and data privacy through encryption.
Access control list (ACL)	Specifies the individual host systems, or networks of host systems, that are allowed to access the server and the attached network product.
SSL/TLS	Allows you to transmit private documents via the Internet and guarantee privacy and data integrity between the client and server applications.
IPsec batch configuration	Provides network-layer security through the simple control of IP traffic to and from the product. This protocol provides the benefits of encryption and authentication and allows for multiple configurations.

# Supported e-mail protocols

The product supports Simple Mail Transfer Protocol (SMTP) and Lightweight Directory Access Protocol (LDAP).

## SMTP

- SMTP is a set of rules that define the interaction between programs that send and receive e-mail. In order for the product to send documents to e-mail, it must be connected to a LAN that has access to an e-mail server that supports SMTP. The SMTP server must also have Internet access.
- If you are using a LAN connection, contact your system administrator to obtain the IP address or host name for your SMTP server. If you are connecting through a DSL or cable connection, contact the internet service provider to obtain the SMTP server IP address.

## LDAP

- LDAP is used to gain access to a database of information. When the product uses LDAP, it searches a global list of e-mail addresses. As you begin to type the e-mail address, LDAP uses an auto-complete feature that supplies a list of e-mail addresses that match the characters you type. As you type additional characters, the list of matching e-mail addresses becomes smaller.
- The product supports LDAP, but a connection to an LDAP server is not required in order for the product to be able to send to e-mail.



**NOTE:** If you need to change the LDAP settings, you must change them using the Embedded Web Server.

## Basic configuration using the Administration menu

You can use the [Initial Setup](#) application to complete this subset of configuration tasks if you have not disabled [Initial Setup](#) on the Home screen: set language settings, configure date and time format, set date and time, and access the E-mail Setup Wizard.

- [Navigate the Administration menu](#)
- [Configure language settings](#)
- [Configure time settings](#)
- [Assign IP address](#)
- [Set up and configure e-mail settings using the E-mail Setup Wizard](#)
- [Manually configure IPv4 TCP/IP parameters from the control panel](#)
- [Manually configure IPv6 TCP/IP parameters from the control panel](#)
- [Disable network protocols \(optional\)](#)
- [Link speed and duplex settings](#)

### Navigate the Administration menu

From the Home screen, touch the [Administration](#) button to open the menu structure. You might need to scroll to the bottom of the Home screen to see this feature.

The [Administration](#) menu has several sub-menus that you can use for some setup tasks. (Use the Embedded Web Server to configure all settings.) Touch the name of a menu to expand the structure. A plus sign (+) next to a menu name means that it contains sub-menus. Continue opening the structure until you reach the option that you want to configure. To return to the previous level, touch the Back button .

 **NOTE:** The Back button  is not available on all screens.

To exit the [Administration](#) menu, touch the Home button  in the upper-left corner of the screen.

The product has built-in Help that explains each of the features that are available through the menus. Help is available for many menus on the right-hand side of the touch screen.

The table in this section provides general information about each menu. For information about specific entries in each menu, see the built-in Help.

**Table 3-5 Administration menus**

Menu item	Description
<a href="#">Reports</a>	Use this menu to view information pages and reports that are stored internally on the product.
<a href="#">General Settings</a>	Use this menu to set options for setting the time and period of inactivity before the product enters sleep mode.
<a href="#">Scan/Digital Send Settings</a>	Use this menu to set up e-mail, save-to-network-folder, save-to-USB-device, and digital-send-service options.
<a href="#">Fax Settings</a>	Use this menu to set up fax-send options.
<a href="#">Display Settings</a>	Use this menu to set up basic display and device behavior settings (keypress sound, display language, network address button display, scanner inactivity timeout, and more).

**Table 3-5 Administration menus (continued)**

Menu item	Description
Network Settings	Use this menu to set up I/O timeout options and to access the Jetdirect menu.
Troubleshooting	Use this menu to help resolve problems. Available options include access to event logs and diagnostic tests, ability to retrieve diagnostic data, and ability to generate debugging data.

## Jetdirect menus

Administration > Network Settings > Embedded Jetdirect Menu

**Table 3-6 Jetdirect menus**

Menu item	Sub-menu item	Sub-menu item	Values and Description
Information	Print Sec Report		<b>Yes:</b> Print the security report.
			<b>No (default):</b> Do not print the security report.
TCP/IP	Enable		<b>On (default):</b> Enable the TCP/IP protocol.
			<b>Off:</b> Disable the TCP/IP protocol.
		Host Name	An alphanumeric string, up to 32 characters, used to identify the product. This name is listed on the HP Jetdirect configuration page. The default host name is NPIxxxxxx, where xxxxxx is the last six digits of the LAN hardware (MAC) address.
	IPv4 Settings	Config Method	Specifies the method that TCP/IPv4 parameters will be configured on the HP Jetdirect server.  <b>Bootp:</b> Use BOOTP (Bootstrap Protocol) for automatic configuration from a BOOTP server.  <b>DHCP:</b> Use DHCP (Dynamic Host Configuration Protocol) for automatic configuration from a DHCPv4 server. If selected and a DHCP lease exists, <b>DHCP Release</b> and <b>DHCP Renew</b> menus are available to set DHCP lease options.  <b>Auto IP:</b> Use automatic link-local IPv4 addressing. An address in the form 169.254.x.x is assigned automatically.  <b>Manual:</b> Use the <b>Manual Settings</b> menu to configure TCP/IPv4 parameters.
		Default IP	Specify the IP address to default to when the Jetdirect server is unable to obtain an IP address from the network during a forced TCP/IP reconfiguration (for example, when manually configured to use BOOTP or DHCP).  <b>Auto IP:</b> A link-local IP address 169.254.x.x is set.  <b>Legacy:</b> The address 192.0.0.192 is set, consistent with older HP Jetdirect products.

**Table 3-6 Jetdirect menus (continued)**

Menu item	Sub-menu item	Sub-menu item	Values and Description
		DHCP Release	<p>This menu appears if the <a href="#">Config Method</a> item was set to the <a href="#">DHCP</a> value and a DHCP lease for the Jetdirect server exists.</p> <p><b>Yes:</b> The current DHCP lease and the leased IP address are released.</p> <p><b>No (default):</b> The current DHCP lease is saved.</p>
		DHCP Renew	<p>This menu appears if the <a href="#">Config Method</a> item was set to the <a href="#">DHCP</a> value and a DHCP lease for the Jetdirect server exists.</p> <p><b>Yes:</b> The Jetdirect server requests to renew the current DHCP lease.</p> <p><b>No (default):</b> The Jetdirect server does not request to renew the DHCP lease.</p>
		Manual Settings	<p>(Available only if the <a href="#">Config Method</a> item is set to the <a href="#">Manual</a> value) Configure parameters directly from the control panel:</p> <p><b>IP Address:</b> The unique IP address of the product (n.n.n.n), where n is a value from 0 to 255.</p> <p><b>Subnet Mask:</b> The subnet mask for the product (m.m.m.m), where m is a value from 0 to 255.</p> <p><b>Syslog Server:</b> The IP address of the syslog server used to receive and log syslog messages.</p> <p><b>Default Gateway:</b> The IP address of the gateway or router used for communications with other networks.</p> <p><b>Idle Timeout:</b> The time period, in seconds, after which an idle TCP data connection is closed (default is 270 seconds, 0 disables the timeout).</p>
		Primary DNS	Specify the IP address (n.n.n.n) of a Primary DNS Server.
		Secondary DNS	Specify the IP address (n.n.n.n) of a Secondary Domain Name System (DNS) Server.
	IPv6 Settings	Enable	<p>Use this item to enable or disable IPv6 operation on the server.</p> <p><b>On (default):</b> IPv6 is enabled.</p> <p><b>Off:</b> IPv6 is disabled.</p>
		Address	Type the server address, a 32 hexadecimal digit IPv6 node address that uses the colon hexadecimal syntax.
		Manual	<p>Use this item to manually set IPv6 addresses on the server.</p> <p><b>Enable:</b> Select this item and choose the <b>On</b> setting to enable manual configuration, or the <b>Off</b> setting to disable manual configuration.</p> <p><b>Address:</b> Use this item to type a 32 hexadecimal digit IPv6 node address that uses the colon hexadecimal syntax.</p>



**Table 3-6 Jetdirect menus (continued)**

Menu item	Sub-menu item	Sub-menu item	Values and Description
		DHCPv6 Policy	<p><b>Router Specified:</b> The stateful auto-configuration method to be used by the Jetdirect server is determined by a router. The router specifies whether the Jetdirect server obtains its address, its configuration information, or both from a DHCPv6 server.</p> <p><b>Router Unavailable (default):</b> If a router is not available, the Jetdirect server should attempt to obtain its stateful configuration from a DHCPv6 server.</p> <p><b>Always:</b> Whether or not a router is available, the Jetdirect server always attempts to obtain its stateful configuration from a DHCPv6 server.</p>
		Primary DNS	Use this item to specify an IPv6 address for a primary DNS server that the Jetdirect server should use.
		Secondary DNS	Use this item to specify an IPv6 address for a secondary DNS server that the Jetdirect server should use.
	Proxy Server		<p>Specifies the proxy server to be used by embedded applications in the product. A proxy server is typically used by network clients for Internet access. It caches Web pages, and provides a degree of Internet security, for those clients.</p> <p>To specify a proxy server, enter its IPv4 address or fully-qualified domain name. The name can be up to 255 octets.</p> <p>For some networks, you may need to contact your Independent Service Provider (ISP) for the proxy server address.</p>
	Proxy Port		Type the port number used by the proxy server for client support. The port number identifies the port reserved for proxy activity on your network, and can be a value from 1 to 65535.
	Idle Timeout		The time period, in seconds, after which an idle TCP data connection is closed, and can be a value from 0 to 3600 (default is 270 seconds, 0 disables the timeout).
Security	Secure Web		<p>For configuration management, specify whether the Embedded Web Server will accept communications using HTTPS (Secure HTTP) only, or both HTTP and HTTPS.</p> <p><b>HTTPS Required:</b> For secure, encrypted communications, only HTTPS access is accepted. The Jetdirect server will appear as a secure site.</p> <p><b>HTTPS Optional (default):</b> Access using either HTTP or HTTPS is permitted.</p>
	IPSec		<p>Specify the IPSec status on the Jetdirect server.</p> <p><b>Keep:</b> IPSec or firewall status remains the same as currently configured.</p> <p><b>Disable (default):</b> IPSec or firewall operation on the Jetdirect server is disabled.</p>

**Table 3-6 Jetdirect menus (continued)**

Menu item	Sub-menu item	Sub-menu item	Values and Description
		802.1X	Reset 802.1X settings to factory defaults.  Reset: Reset 802.1X settings to factory defaults.  Keep (default): Retain current 802.1X settings.
		Announcement Agent	Set announcement agent preferences.  Enable(default): Enable the announcement agent.  Disable: Disable the announcement agent.
		Reset Security	Specify whether the current security settings on the Jetdirect server will be saved or reset to factory defaults.  Yes: Security settings are reset to factory defaults.  No (default): The current security settings are maintained.
Diagnostics	Embedded Tests	LAN HW Test	Yes: Run a LAN hardware test.  No (default): Do not run a LAN hardware test.
		HTTP Test	Yes: Run an HTTP test.  No (default): Do not run an HTTP test.
		SNMP Test	Yes: Run an SNMP test.  No (default): Do not run an SNMP test.
		Data Path Test	Yes: Run a data path test.  No (default): Do not run data path test.
		Select All Tests	Yes: Select all tests.  No (default): Do not select all tests.
		Execution Time (H)	Set the time delay, in hours, for test execution. When you click <b>Execute</b> , the selected tests will execute after this interval. Valid values are 0–24, default is 1.
		Execute	Yes: Execute the selected tests..  No (default): Do not execute the selected tests.
	Ping Test	Dest Type	Select the destination type for this test.  IPV4 (default)  IPV6
		Dest IPv4	Enter the IP address for the IPv4 destination.
		Dest IPv6	Enter the IP address for the IPv6 destination.
		Packet Size	Specify the packet size for this test. Valid values are 64–2048, default is 64.
		Timeout	Set the timeout value for this test. Valid values are 1–100, default is 1.

**Table 3-6 Jetdirect menus (continued)**

Menu item	Sub-menu item	Sub-menu item	Values and Description
		Count	Set the count value for this test. Valid values are 0–100, default is 4.
		Print Results	Yes: Print test results. No (default): Do not print test results.
		Execute	Yes: Execute the selected tests.. No (default): Do not execute the selected tests.
	Ping Results	Packets Sent	Number of packets sent. Valid values are 0–65535.
		Packets Received	Number of packets received. Valid values are 0–65535.
		Percent Lost	Percent of loss. Valid values are 0–100.
		RTT Min	Valid values are 0–4096.
		RTT Max	Valid values are 0–4096.
		RTT Average	Valid values are 0–4096.
		Ping in Progress	Yes No
		Refresh	Yes No
Link Speed			<p>The link speed and communication mode of the Jetdirect server must match the network. The available settings depend on the product and installed Jetdirect server. Select one of the following link configuration settings:</p> <p><b>CAUTION:</b> If you change the link setting, network communications with the Jetdirect server and network product might be lost.</p> <p><b>Auto</b> (default): The Jetdirect server uses auto-negotiation to configure itself with the highest link speed and communication mode allowed. If auto-negotiation fails, either the <b>100TX Half</b> value or the <b>10T Half</b> value is set depending on the detected link speed of the hub/switch port. (A 1000T half-duplex selection is not supported.)</p> <p><b>10T Half:</b> 10 Mbps, half-duplex operation.</p> <p><b>10T Full:</b> 10 Mbps, full-duplex operation.</p> <p><b>100TX Half:</b> 100 Mbps, half-duplex operation.</p> <p><b>100TX Full:</b> 100 Mbps, full-duplex operation.</p> <p><b>100TX Auto:</b> Limits auto-negotiation to a maximum link speed of 100 Mbps.</p> <p><b>1000T Full:</b> 1000 Mbps, full-duplex operation.</p>

## Configure language settings



To configure language settings, follow these steps:

1. At the product control panel, touch the [Administration](#) button, touch the [Display Settings](#) menu, and then touch the [Language Settings](#) option.
2. Under [Language](#), touch the language for the control panel display.
3. Under [Keyboard Layout](#), touch the keyboard layout for the touch screen keyboard, and then touch [Save](#).

---

 **NOTE:** The language you select can impact the organization of the keys on the touch screen keyboard. Also note that there may be more than one keyboard layout for a specific language.

---

 **NOTE:** You can also configure language settings by touching the [Language](#) button  on the Home screen.

---

## Configure time settings

To configure time settings, follow these steps:

1. At the product control panel, touch the [Administration](#) button, touch the [General Settings](#) menu, and then touch the [Date/Time Settings](#) option.
2. Set the date and time.
  - a. Touch [Date/Time](#).
  - b. Set the date, month, and year by touching the appropriate button and using the arrow to set the desired value.
  - c. Set the time by touching the appropriate button and using the arrow to set the desired value; touch the [AM/PM](#) button to toggle the value.

---

 **NOTE:** Touch [Adjust Daylight Savings](#) if appropriate.

---

- d. Touch the appropriate time zone button.
- e. Touch [Save](#).

---

 **NOTE:** To change the date and time format, touch [Date/Time Format](#) on the Date/Time Settings screen.

---

3. Configure the sleep timer setting.
  - a. On the General Settings screen, touch [Energy Settings](#), and then touch [Sleep Timer Settings](#).
  - b. Touch the [Minutes](#) box to select it, and then use the pop-up keypad to set the value in minutes.
  - c. Select the appropriate action for [Wake/Auto On to These Events](#).
  - d. Touch [OK](#), and then touch [Save](#).

---

 **NOTE:** You can also configure the Sleep Schedule feature from the Energy Settings screen.

---

## Assign IP address

If the network uses dynamic host configuration protocol (DHCP), the IP address can be assigned automatically. Otherwise, you must manually assign an IP address.

To use DHCP and assign the IP address automatically, follow these steps:

1. At the product control panel, touch the [Administration](#) button, touch the [Network Settings](#) option, touch the [Embedded Jetdirect Menu](#) option, touch the [TCP/IP](#) option, touch the [IPv4 Settings](#) option, and then touch the [Config Method](#) option.
2. Touch [DHCP](#).
3. Touch [Save](#).

To manually assign an IP address:

1. At the product control panel, touch the [Administration](#) button, touch the [Network Settings](#) option, touch the [Embedded Jetdirect Menu](#) option, touch the [TCP/IP](#) option, touch the [IPv4 Settings](#) option, and then touch the [Config Method](#) option.
2. Touch [Manual](#), and then touch [Save](#).
3. On the IPv4 Settings screen, touch [Manual Settings](#), and then touch [IP Address](#).
4. Touch the first IP address entry field and use the keyboard to enter the first portion of the IP address.
5. Enter the remaining portions of the IP address, and then touch [Save](#).

## Set up and configure e-mail settings using the E-mail Setup Wizard

Make sure you have a functioning Internet connection before completing this procedure.

1. At the product control panel, touch the [Administration](#) button, touch the [Scan/Digital Send Settings](#) option, touch the [E-mail Settings](#) option, and then touch [E-mail Setup Wizard](#).



**NOTE:** You can also use Initial Setup if it is still enabled (touch the [Administration](#) button, touch the [Initial Setup](#) option, and then touch the [E-mail Setup Wizard](#) option).

2. Select an SMTP server option, and then follow the onscreen instructions; touch [Next](#) as you complete each screen in the wizard.
3. Touch **Finish** on the final wizard screen to complete setup and close the wizard.

You can also use the Embedded Web Server (EWS) to set up the address book with LDAP (Lightweight Directory Access Protocol).

1. Click the **Security** tab, click **Access Control**, and then click the **Setup** link for LDAP.
2. Follow the onscreen instructions to set up and configure LDAP.





**NOTE:** You must select the **Enable LDAP Sign In** checkbox (under **Setup**) to enable this sign-in method.

3. When configuration is complete, click **OK**.

## Manually configure IPv4 TCP/IP parameters from the control panel

In addition to using the Embedded Web Server, you can also use the control-panel menus to set an IPv4 address, subnet mask, and default gateway.

1. At the product control panel, touch the [Administration](#) button, touch the [Network Settings](#) menu, touch the [Embedded Jetdirect Menu](#) option, touch the [TCP/IP](#) option, touch the [IPv4 Settings](#) option, and then touch the [Config Method](#) option.
2. Touch [Manual](#), and then touch [Save](#).
3. Touch the Back button  to return to the IPv4 Settings screen.
4. On the IPv4 Settings screen, touch [Manual Settings](#), and then touch the option you wish to manually set and follow the onscreen instructions to change the option setting.
5. Touch the Back button  repeatedly until you return to the [Embedded Jetdirect Menu](#).
6. Touch the [Link Speed](#) option.
7. Touch one of the following options.

Setting	Description
<a href="#">Auto</a>	The product automatically configures itself for the highest link speed and communication mode allowed on the network.
<a href="#">10T Half</a>	10 megabytes per second (Mbps), half-duplex operation
<a href="#">10T Full</a>	10 Mbps, full-duplex operation
<a href="#">100TX Half</a>	100 Mbps, half-duplex operation
<a href="#">100TX Full</a>	100 Mbps, full-duplex operation
<a href="#">100TX Auto</a>	Limits auto-negotiation to a maximum link speed of 100 Mbps
<a href="#">1000T Full</a>	1000 Mbps, full-duplex operation

8. Touch the [Save](#) button.

## Manually configure IPv6 TCP/IP parameters from the control panel

In addition to using the Embedded Web Server, you can also use the control-panel menus to set an IPv6 address.

1. At the product control panel, touch the [Administration](#) button, touch the [Network Settings](#) menu, touch the [Embedded Jetdirect Menu](#) option, touch the [TCP/IP](#) option, touch the [IPv6 Settings](#) option, touch the [Address](#) option, touch the [Manual Settings](#) option, and then touch the [Enable](#) option.
2. Touch the [On](#) option, and then touch the [Save](#) button.
3. Touch the [Address](#) option, and then touch the data entry field.
4. Use the keyboard to enter the address, and then touch the [Save](#) button.

## Disable network protocols (optional)

By factory default, all supported network protocols are enabled. Disabling unused protocols has the following benefits:

- Decreases product-generated network traffic
- Provides only pertinent information on the configuration page
- Allows the product control panel to display protocol-specific error and warning messages

## Link speed and duplex settings

The link speed and communication mode of the product must match the network. For most situations, leave the product in automatic mode. Incorrect changes to the link speed and duplex settings might prevent the product from communicating with other network devices. If you need to make changes, use the product control panel.



---

**NOTE:** Making changes to these settings causes the product to turn off and then on. Make changes only when the product is idle.

---

1. At the product control panel, touch the [Administration](#) button, touch the [Network Settings](#) menu, and then touch the [Jetdirect Menu](#) option.
2. Touch the down arrow until the [Link Speed](#) option displays.
3. Touch the [Save](#) button. The product turns off and then on.

## Basic configuration using the Embedded Web Server

When the product is connected to the network, the Embedded Web Server (EWS) is automatically available.

To start the EWS, open a web browser on a computer and type the IP address of the product. To find the IP address or host name, touch the [Network Address](#) button on the Home screen on the product control panel.

- [View or change network settings](#)
- [Set or change the administrator password](#)
- [Configure e-mail options](#)
- [Save to Network Folder Setup](#)
- [Configure save to SharePoint options](#)
- [Configure USB storage device settings](#)
- [Configure Quick Sets](#)
- [Configure general security settings](#)
- [Configure access control security settings](#)

### View or change network settings

You can use the Embedded Web Server to view or change IP configuration settings.

1. Open the Embedded Web Server.
2. Click the **Networking** tab to obtain network information. You can change settings as needed.

### Set or change the administrator password

Use the Embedded Web Server to set an administrator password or change an existing password. When set, you must enter this password before you can access and change configuration settings.

1. Open the Embedded Web Server and click the **Networking** tab.
2. In the left-side pane, click the **Authorization** option.

---

 **NOTE:** If a password has previously been set, you are prompted to type the password. Type the password, and then click the **Apply** button.

---

3. Type the new password in the **Password** box and in the **Confirm Password** box.
4. At the bottom of the window, click the **Apply** button to save the password.

---

 **NOTE:** You can also set a local administrator password from the **General Security** option on the **Security** tab. When set, you must enter this password to change settings within the Embedded Web Server.

---

### Configure e-mail options

1. Open the Embedded Web Server.
2. Click the **Scan/Digital Send** tab.



3. In the left navigation pane, click the **E-mail Setup** entry.
4. Select **Enable Send to E-mail** and click **Add**, follow the SMTP wizard to complete the required fields and any additional fields you want, and then click the **Apply** button.

---

 **TIP:** You must specify an outgoing SMTP server and complete the **From:** field. See the Embedded Web Server Help for more information.

---

5. To add addresses to the Address book, click the **Address Book** entry in the left navigation pane and then follow the onscreen instructions.

After you have configured the e-mail settings, send an e-mail to yourself by using the digital-send feature. If you receive the e-mail, you have successfully configured the digital-sending feature.

If you do not receive the e-mail, use these actions to resolve issues:

- Check the SMTP and address to make sure that you typed them correctly.
- View the configuration page. Verify that the SMTP gateway address is correct.
- Make sure that the network is operating correctly. Send an e-mail to yourself from a computer. If you receive the e-mail, the network is operating correctly. If you do not receive the e-mail, contact your network administrator or Internet service provider (ISP).

## Save to Network Folder Setup

Before configuring network folders, set up shared folders following the instructions for your network operating system.

1. Open the Embedded Web Server.
2. Click the **Scan/Digital Send** tab.
3. On the left navigation menu, click the **Save to Network Folder Setup** entry.
4. Select the **Enable Save to Network Folder** checkbox.

---

 **NOTE:** If you select **Use credentials of user to connect after Sign In at the control panel** in the **Authentication Settings** drop-down list, the logged-in user must have permissions to write to the specified network folder.

---

5. Set the default settings you want for all folders and then click the **Apply** button.
6. To specify network folders to which to save documents, click the **Add** button in the **Quick Sets** area and follow the onscreen instructions.

## Configure save to SharePoint options

Before you can complete this procedure, the destination folder to which you want to save scanned files must exist on the SharePoint site, and you must have write access to the destination folder.

1. Open the Embedded Web Server.
2. Click the **Scan/Digital Send** tab.
3. On the left navigation menu, click the **Save to SharePoint** entry.
4. Select the **Enable Scan to SharePoint** checkbox, and then click **Add**.

5. On the first screen of the quick set wizard, supply a title and description for the scan-to-SharePoint quick set, select the button location for the quick set and options for user interaction at the control panel, and then click **Next**.
6. On the SharePoint Destination Settings dialog, click **Add** to create a scan-to-SharePoint destination, and then follow the instructions at the top of the SharePoint Destination Settings dialog.
  - a. Using your browser, navigate to the SharePoint scan destination folder, copy the destination path, paste the path into the **SharePoint Path** field on the Add SharePoint Path dialog, and complete the remainder of the dialog fields as desired.



**NOTE:** If you select **Use credentials of user to connect after Sign In at the control panel** in the **Authentication Settings** drop-down list, the logged-in user must have permissions to write to the specified SharePoint site.

- Make sure to provide a fully-qualified domain name in the **Windows Domain** field (this field is case-sensitive).
  - Make sure to select **Generate Short URL** to remove extraneous characters from the path name.
- b. When you have finished defining the SharePoint settings, click **OK**, and then click **Next**.
  - c. Complete the remainder of the Quick Set Wizard dialogs as appropriate, clicking **Next** to progress to the next dialog.
  - d. When you reach the Summary dialog, click **Finish** to complete setup.

Once you have created a save-to-SharePoint quick set, you can scan to the SharePoint destination using the quick set either directly from the Home screen or from the [Quick Sets](#) button on the Home screen.

## Configure USB storage device settings

1. Open the Embedded Web Server.
2. Click the **Scan/Digital Send** tab.
3. On the left navigation menu, click the **Save to USB Setup** entry.
4. Select the **Enable Save to USB** checkbox.
5. Set the default settings you want.
6. Click the **Apply** button.

## Configure Quick Sets

1. Open the Embedded Web Server.
2. Click the **General** tab.
3. On the left navigation menu, click the **Quick Sets Setup** entry.
4. Click the **Add** button, and then follow the onscreen instructions in the Quick Set Wizard.
5. When you are done, click the **Apply** button.



**TIP:** You can also configure Quick Sets on other setup pages in the Embedded Web Server.

## Configure general security settings

1. Open the Embedded Web Server.
2. Click the **Security** tab, and then click **General Security**.
3. Type a new password and then type the password again to verify.
4. Select **Enable Host USB plug and play** if you wish to enable the covered USB port on the front of the product.
5. Click **Apply**.

## Configure access control security settings

Completing each step may take you to multiple screens.

1. Open the Embedded Web Server.
  2. Specify and configure the security method to be used (LDAP or Windows).
    - a. Click the **Security** tab, and then click **Access Control**.
    - b. Under **Enable and Configure Sign In Methods**, click **Setup** to configure the desired sign-in method (LDAP or Windows).
    - c. Follow the onscreen instructions on the selected sign-in method setup screen; when setup is complete, click **OK**.
  3. Under **Sign In and Permission Policies** on the Access Control screen, set device feature access settings for each level of user, and then select a **Manage Permission Sets...** option.
  4. Under **Relationships Between Network Users or Groups and Device Permissions**, select the default permission set for each type of sign in method.
  5. (Optional): Under **Device User Accounts**, set up individual user accounts if you are not using users and groups to grant device access.
  6. When all access control security settings are complete, click **Apply**.
  7. Select a file erase mode for erasing temporary job files.
    - a. Click the **Security** tab, and then click **Protect Stored Data**.
    - b. Under **Managing Temporary Job Files**, select the method for erasing temporary job files, and then click **Apply**.
1. Open the Embedded Web Server.
  2. Click the **Security** tab, and then click **General Security**.
  3. Type a new password and then type the password again to verify.
  4. Select **Enable Host USB plug and play** if you wish to enable the covered USB port on the front of the product.
  5. Click **Apply**.

## Additional configuration using the Embedded Web Server

The following table identifies configuration options available from the Embedded Web Server (EWS). For information about specific options, see the EWS Help.

**Table 3-7 Embedded Web Server configuration options**

EWS tab	Options
Scan/Digital Send	Address Book, E-mail Setup, Save to Network Folder Setup, Save to USB Setup, OXPd: Workflow, Digital Sending Software Setup
Fax	Fax Send Setup, Speed Dials
Networking	<ul style="list-style-type: none"><li data-bbox="858 548 1428 604">• Configuration (TCP/IP Settings, Network Settings, Select Language)</li><li data-bbox="858 625 1428 682">• Security (Settings, Authorization, Management Protocols, 802.1X Authentication, IP/Sec Firewall)</li><li data-bbox="858 703 1428 760">• Diagnostics (Network Statistics, Protocol Info, Configuration Page)</li></ul>

---

## 4 Administration - Manage the product

This section presents information about how to care for and maintain the product.

- [Use information pages](#)
- [Use the Embedded Web Server](#)
- [Use HP Web Jetadmin software](#)
- [Controlling digital-sending security](#)
- [Security features](#)
- [Energy settings](#)
- [Upgrade the firmware](#)
- [Backup product data](#)
- [Restore product data](#)

Occasional cleaning of the product helps ensure high-quality scans. The amount of care necessary depends upon several factors, including the amount of use and the environment. You should perform routine cleaning as necessary.

---

 **CAUTION:** Before placing an item in the document feeder, make sure that the item does not contain wet glue, correction fluid, or other substances that can be transferred to the interior of the product.

Make sure there are no curls, wrinkles, staples, paper clips, or any other attached material. Sheets should not be stuck together.

---

## Use information pages

1. From the Home screen, touch the [Administration](#) button and then touch the [Reports](#) option to view pages that give details about the device and its current configuration and status.
  2. Touch the information page option you want to see, and then touch [View](#).
- [Configuration/Status Pages](#)
    - [Administration Menu Map](#)
    - [Current Settings Page](#)
    - [Configuration Page](#)
    - [File Directory Page](#)
    - [Web Services Status Page](#)
    - [Usage Page](#)
  - [Fax Reports](#)
    - [Speed Dial List](#)

## Use the Embedded Web Server

When the HP Scanjet Enterprise 8500 fn1 is connected to a network, you can use the Embedded Web Server to view status information, change settings, and manage the product from your computer.

To use the Embedded Web Server, you must have Microsoft Internet Explorer 5.01 or later or Netscape 6.2 or later for Windows, Mac OS, and Linux (Netscape only). Netscape Navigator 4.7 is required for HP-UX 10 and HP-UX 11.

The Embedded Web Server works when the product is connected to an IP-based network. You do not have to have Internet access to open and use the Embedded Web Server.

When the product is connected to the network, the Embedded Web Server is automatically available.



**NOTE:** Some Embedded Web Server options are only available to the network administrator, and some settings might require a password.

You can use the Embedded Web Server without being connected to the Internet; however, some features will not be available.

- [Open the Embedded Web Server](#)
- [Embedded Web Server options](#)

## Open the Embedded Web Server

1. In a supported Web browser on your computer, type the product IP address or host name in the address/URL field. To find the IP address or host name, touch the [Network Address](#) button on the Home screen.



**NOTE:** After you open the URL, you can bookmark it so that you can return to it quickly in the future.

2. The Embedded Web Server has seven tabs that contain settings and information about the product: **Information**, **General**, **Scan/Digital Send**, **Fax**, **Troubleshooting**, **Security**, and **Networking**. Click the tab that you want to view.

## Embedded Web Server options

The following table describes the types of information you can obtain or tasks you can perform using the Embedded Web Server tabs. The options that appear on each tab can change when you upgrade firmware, so refer to the Embedded Web Server Help for detailed information about tabs and their options.



**NOTE:** Each tab also provides links to the **HP Instant Support** and **Product Support** websites.

Tab	Options
<b>Information</b>	The <b>Information</b> tab provides access to information about the product's operational status, configuration settings, event logs, and usage statistics.
<b>General</b>	The <b>General</b> tab provides access to the control panel <a href="#">Administration</a> menu. Options on this tab also allow you to sign up to receive e-mail alerts and configuration and supplies usage information, record device information, set language and date and time options, and more.  <b>NOTE:</b> The <b>General</b> tab can be password-protected. If this product is on a network, always consult with the system administrator before changing settings on this tab.

Tab	Options
<b>Scan/Digital Send</b>	<p>The <b>Scan/Digital Send</b> tab allows you to set up and configure e-mail, save-to-USB, save-to-network-folder, and digital-sending-software options, populate an address book, and connect to workflow services.</p> <p><b>NOTE:</b> If the product is configured to use the optional HP Digital Sending Software, the options on these tabs are not available. Instead, all digital-sending configuration is performed by using the HP Digital Sending Software.</p>
<b>Fax</b>	<p>The <b>Fax</b> tab allows you to set up and configure fax sending and speed dial options.</p>
<b>Troubleshooting</b>	<p>The <b>Troubleshooting</b> tab allows you access device reports and logs, locate and install new firmware, and restore device settings to factory defaults.</p> <p><b>NOTE:</b> Upgrading firmware requires that an administrator password be set in the <b>General Security</b> area of the <b>Security</b> tab.</p>
<b>Security</b>	<p>The <b>Security</b> tab allows you to configure general security, access control, and stored data protection options, as well as to manage certificates.</p>
<b>Networking</b>	<p>The <b>Networking</b> tab allows you to change network settings from your computer when both the product and your computer are connected to an IP-based network.</p> <p><b>NOTE:</b> The <b>Networking</b> tab can be password-protected.</p>



## Use HP Web Jetadmin software

HP Web Jetadmin is a Web-based software solution for remotely installing, monitoring, and troubleshooting network-connected peripherals. Management is proactive, allowing network administrators the ability to resolve issues before users are affected. Download this free, enhanced-management software at [www.hp.com/go/webjetadmin](http://www.hp.com/go/webjetadmin).

Plug-ins can be installed into HP Web Jetadmin to provide support for specific product features. The HP Web Jetadmin software can automatically notify you when new plug-ins are available. On the **Product Update** page, follow the directions to automatically connect to the HP Web site and install the latest device plug-ins for your product.



**NOTE:** Browsers must be Java™-enabled.

---

## Controlling digital-sending security

The product has been designed with security in mind. It includes a variety of features that work to protect the security of the digital-sending process.

### Network authentication

The product's most basic security feature is its ability to require a network login before a user can use the digital-sending functions. This prevents unauthorized users from walking up to the product and sending documents. Additionally, the product supports several authentication methods that offer a high level of encryption and security.

### Secure e-mail

In addition to the secure email option on this scanner, a number of third-party software vendors offer services for secure e-mail delivery. The [Secondary e-mail](#) feature is designed to work with one of these third-party software programs for users that require an extra measure of data security.

### Restrict software access

In order to keep the product secure, you must also restrict access to the software programs that can be used to configure the product.

You can also set a local administrator password using the **General Security** option on the **Security** tab in the Embedded Web Server (EWS) to prevent access to the device-settings tabs. After the password has been set, users can only see the EWS **Information** tab.

# Security features

The following security features are available on this product.

- [Secure the Embedded Web Server](#)
- [Manage temporary job files](#)
- [Secure Storage Erase](#)
- [Secure File Erase](#)
- [Secure Disk Erase](#)
- [HP High-Performance Secure Hard Disks](#)
- [Manage certificates](#)
- [Authentication and authorization](#)

## Secure the Embedded Web Server

Assign a password for access to the Embedded Web Server so that unauthorized users cannot change the product settings.

1. Open the Embedded Web Server.
2. Click the **Security** tab.
3. On the left side of the window, click the **General Security** link.
4. Type the password in the **New Password** box, and type it again in the **Verify Password** box.
5. Click the **Apply** button. Make note of the password and store it in a safe place.

## Manage temporary job files

To specify how your product manages temporary job files that are created when scans are initiated, follow these steps.

1. In the Embedded Web Server, click the **Security** tab, and then click the **Protect Stored Data** link.
2. Under **Managing Temporary Job Files**, select a file erase mode.
  - **Non-Secure Fast Erase.** This is a simple file-table erase function. Access to the file is removed, but actual data is retained on the disk until it is overwritten by subsequent data-storage operations. This is the fastest mode. Non-Secure Fast Erase is the default erase mode.
  - **Secure Fast Erase.** Access to the file is removed, and the data is overwritten with a fixed identical character pattern. This is slower than Non-Secure Fast Erase, but all data is overwritten. Secure Fast Erase meets the U.S. Department of Defense 5220-22.M requirements for the clearing of disk media.
  - **Secure Sanitize Erase.** This level is similar to the Secure Fast Erase mode. In addition, data is repetitively overwritten by using an algorithm that prevents any residual data persistence. This mode will impact performance. Secure Sanitize Erase meets standards for clearing disk media defined in NIST Special Publication 800-88 Guidelines for Media Sanitation and the U.S. Department of Defense Updated DSS Clearing and Sanitization Matrix.
3. Click **Apply**.

## Secure Storage Erase

Use the **Secure Storage Erase** option in the Embedded Web Server to protect deleted data from unauthorized access on the product hard drive. The **Secure Storage Erase** option provides two secure erase types, both of which meet the U.S. NIST Special Publication 800–88 guidelines for media sanitization.

1. In the Embedded Web Server, click the **Security** tab, click the **Protect Stored Data** option, and then click the **Erase Options** button.
2. Select a storage erase option.
  - **Secure Fast Erase.** Access to the file is removed, and the data is overwritten one time with a fixed identical character pattern.
  - **Secure Sanitize Erase.** This level is similar to **Secure Fast Erase** but data is overwritten three times. This will impact performance.
3. Click the **Erase** button.

## Data affected

Data affected (covered) by the **Secure Storage Erase** feature includes stored fax files, stored jobs, and HP and third-party application data.

This feature will not impact data that is stored on flash-based product non-volatile RAM (NVRAM) that is used to store default settings, page counts, and similar data. This feature does not affect data that is stored on a system RAM disk (if one is used). This feature does not impact data that is stored on the flash-based system boot RAM.

## Secure File Erase

Changing the **Secure File Erase** mode does not overwrite previous data on the disk, nor does it immediately perform a full-disk sanitization. Changing the **Secure File Erase** mode changes how the product cleans up temporary data for jobs after the erase mode has been changed.

## Secure Disk Erase

[Secure Disk Erase](#) permanently erases all the data on the hard drive. If you have an encrypted hard drive, this function also unlocks the encrypted hard drive, thereby allowing the drive to be read by any device.

---

 **WARNING!** Only use this option at product end-of-life. Since [Secure Disk Erase](#) permanently erases all data (including the product operating system), the product will not boot up.

---

You can access the [Secure Disk Erase](#) feature from the product's Administrative Tools option on the Boot menu. To access the Boot menu, press the Power button to turn off the product, press and hold the Escape key on the keyboard, and then press the Power button to turn on the product while continuing to hold the Escape key until the Boot menu displays.

## HP High-Performance Secure Hard Disks

This product supports an encrypted hard disk that might be installed in the EIO slot, on the formatter board, or in both locations. The only encrypted hard disk that is supported is the disk that comes bundled with the product. Encrypted hard disks provide hardware-based encryption so you can securely store sensitive scan data without impacting product performance. Encrypted hard disks use the latest Advanced Encryption Standard (AES) and have versatile time-saving features and robust functionality.

## Manage certificates

The product has a built-in self-signed certificate, which allows for encryption and a reasonable level of trust for network communications with entities such as the LDAP server (communication that can include user names and passwords). However, some networks require trusted certificates. In these cases, you might be required to install a certificate from the network certificate authority.

The certificate manager also allows you to load certificate revocation lists (CRL).

### Load a certificate

1. From a Web browser, open the Embedded Web Server by typing the IP address of the product.
2. On the main Embedded Web Server page, click the **Security** tab, and then select the **Certificate Management** entry.

---

 **NOTE:** If the **Certificate Management** page is unavailable, update the product firmware.

---

3. Under **Install Certificate**, click **Browse...** to locate the certificate you want to load.

---

 **NOTE:** Find certificates at the location where a network administrator created them. If the certificate you select is password-protected, you will need to enter the certificate password.

---

4. Click **Import** to import the certificate. The certificate will appear in the certificates list after it is loaded.

### Load a certificate revocation list (CRL)

1. From a Web browser, open the Embedded Web Server by typing the IP address of the product.
2. On the main EWS page, click the **Security** entry, and then select the **Certificate Management** entry.

---

 **NOTE:** If the Certificate Management page is unavailable, update the product firmware.

---

3. Under **Install Certificate**, click **Browse...** to locate the CRL to load.

4. Click **Import** to import the CRL. The CRL will appear in the certificate revocation list after it is loaded.

## Authentication and authorization

You can secure access to various parts of the control panel menu by establishing passwords. These passwords can be created to be local to the product, or can be obtained from the network by configuring Windows or LDAP server information.

To configure these settings using the Embedded Web Server, follow these steps.

1. In the Embedded Web Server, click the **Security** tab, and then click the **Access Control** link.
2. Configure access control options.
  - **Enable and Configure Sign In Methods.** This section allows the administrator to configure the Windows or LDAP network settings. The product uses these settings to obtain user information from the server.
  - **Sign In and Permission Policies.** This section allows the administrator to manage product permissions. By default, the product will support Guest, Administrator, and User permission sets. The administrator can add permission sets, and can configure which sign-in method to use on control panel applications.

- **Relationships Between Network Users or Groups and Device Permissions.** This section allows the administrator to select the default permission set for Windows and LDAP sign-in methods.
- **Device User Accounts.** This section allows the administrator to establish user access codes.

# Energy settings

To manage the product's energy settings using the Embedded Web Server, follow these steps:

1. Start the Embedded Web Server.
2. Click the **General** tab, and then select **Energy Settings**.
3. Under **Sleep Schedule**, click **Add** to open the Sleep Schedule window.
  - a. Follow the onscreen instructions to define a weekly or holiday sleep schedule event.
  - b. Click **Apply** to save the sleep schedule event.
4. Under **Sleep Timer Settings** on the **Energy Settings** dialog, click [Sleep Mode/Auto Off After](#), enter the number of minutes of activity after which you want the scanner to enter Sleep Mode, and then click **Apply**



---

**NOTE:** You can also configure energy settings from the control panel Home screen. Touch [Administration](#), touch [General Settings](#), and then touch [Energy Settings](#).

---

# Upgrade the firmware



**NOTE:** You must have access to the product's local administrator password to complete this task.

1. From the Home screen, touch the **Administration** button, touch the **Reports** button, and then touch the **Configuration/Status Pages** button.



**NOTE:** Check the **Configuration Page** option; the report lists the current firmware revision number.

2. See [www.hp.com/support](http://www.hp.com/support), search for your product, and then look for a link to downloads to see if there is a newer version of firmware available.
3. Copy the new firmware file to a USB storage device, and then plug the USB device into the USB connector beside the control panel.



**CAUTION:** Make sure to leave the USB storage device plugged into the USB connector until all upgrades are installed, the product has rebooted, and the Home screen is displayed on the touch screen.

4. From the Home screen, touch the **Device Maintenance** button, and then touch the **USB Firmware Upgrade** button.
5. Touch **Firmware Upgrade Bundle**, and then touch the **Upgrade** button.

The upgrade process can take a few minutes.

6. When prompted, touch the **Yes** button to reboot the product.

Starting the product after a firmware upgrade may take up to 20 minutes.

7. If necessary, repeat the previous two steps to install a second upgrade.



**NOTE:** You can also upgrade firmware using the Embedded Web Server. Start the Embedded Web Server, click the **General** tab, click **Firmware Upgrade** in the left navigation pane, and then follow the onscreen instructions to download a firmware upgrade directly to your product.



## Backup product data

HP recommends doing routine, scheduled backups as a best practice.

To backup data stored on the product, follow these steps:

1. Start the Embedded Web Server (EWS).
2. Click the **General** tab, and then select **Backup and Restore**.
3. Under **Backup/Restore**, select **Backup**, and then supply the UNC folder path to which the backup file will be stored.

---

 **NOTE:** If the backup folder is encrypted, you must enter the encryption key in the **Encryption Key** field under **Authentication Settings**.

---

4. Under **Authentication Settings**, enter the Windows domain, username, and password, and then click **OK** to create the backup file.

A progress meter indicates the status of the backup operation.

---

 **NOTE:** You can also backup data from the control panel Home screen. Touch [Device Maintenance](#), touch [Backup/Restore](#), and then touch [Backup Data](#).

---

## Restore product data

To restore backed-up product data, follow these steps:

1. Start the Embedded Web Server (EWS).
2. Click the **General** tab, and then select **Backup and Restore**.
3. Under **Backup/Restore**, select **Restore**, and then supply the full pathname to the file which you wish to restore.



**NOTE:** If the backup folder is encrypted, you must enter the encryption key in the **Encryption Key** field under **Authentication Settings**.

---

4. Under **Authentication Settings**, enter the Windows domain, username, and password, and then click **OK** to restore the backup file.

A progress meter indicates the status of the restore operation. The product automatically restarts when the restore operation is complete.



**NOTE:** You can also restore backed-up data from the control panel Home screen. Touch [Device Maintenance](#), touch [Backup/Restore](#), and then touch [Restore Data](#).

---

---

## 5 Load originals

- [Use the automatic document feeder \(ADF\)](#)
- [Use the scanning glass](#)

# Use the automatic document feeder (ADF)

For helpful information on loading your documents properly, refer to the following topics.













- [Document loading tips](#)
- [Document loading tips for mixed-size documents](#)
- [How to load documents](#)

## Document loading tips

- The maximum capacity of the document feeder and output tray varies by paper size and weight. For 75g/m<sup>2</sup> (20 lb) paper (the standard weight for most printer and photocopier paper), the maximum capacity is 100 sheets. For heavier paper, the maximum capacity is less.
- The automatic document feeder (ADF) supports the following paper types.

	Width	Length	Weight (or thickness)
Standard stock (single page)	68-216 mm (2.7-8.5 in)	148-864 mm (5.8-34 in)	49-120 g/m <sup>2</sup> (13-32 lbs)
Standard stock (multiple pages)	68-216 mm (2.7-8.5 in)	148-356 mm (5.8-14 in)	49-120 g/m <sup>2</sup> (13-32 lbs)

- Scanning the following types of documents with the ADF might result in paper jams or damage to the documents. To scan these documents, use the scanning glass instead of the ADF.

	Wrinkled or creased documents		Curled documents
	Torn documents		Documents with paper clips or staples
	Carbon paper		Coated paper
	Extremely thin, translucent paper		Paper with adhesive notes or flags attached
	Photos		Overhead transparencies
	Papers that are stuck together		Paper with wet substances such as glue or correction fluid

- Smooth out any folds or curls in your documents before placing them into the feeder. If the leading edge of a document is curled or folded, it may cause a paper jam.
- When loading paper that is smaller than 148 mm (5.8 in) in width, place the long edge of the page parallel to the paper guides.
- To scan fragile documents (such as photos or documents on wrinkled or very lightweight paper), place the document face down on the scanning glass.

- Make sure that the hatch on the document feeder is securely latched. To properly close the hatch, press until you hear a click.
- Adjust the paper guides to the width of the documents. Make sure that the paper guides touch the edges of the original. If there is any clearance between the paper guides and the edges of the documents, the scanned image might be skewed.
- When placing a stack of documents into the feeder, gently set the stack in the document feeder. Do not drop the stack into the feeder.

---

 **TIP:** The document load/detect LED on the clear portion of the document feeder input tray is on when documents are positioned correctly.

---

- To prevent skewing, always load stacks of documents of the same dimensions. However, if you must load stacks of mixed document sizes, center all documents in the stack by width before inserting them in the document feeder.
- Clean the scanning rollers if the rollers are visibly dirty or after scanning a document that has pencil writing on it.

## Document loading tips for mixed-size documents

You can load the document feeder with groups of documents that have different widths or lengths. If your document contains different sized pages, you can scan it as described below.

- If your documents have the same width but different lengths (legal and letter size, for example), you can scan them as a single job. The scanned items will have the same length as the original items in the document.
- If you want to prevent skewing and ensure that each scanned item has the same width and length as the original, use the **Job Build** feature. Each segment of the job build must have documents of the same width and length.

## How to load documents

1. Adjust the paper guides to the width of the documents. Take care not to overtighten the guides, which can restrict paper feeding.



When scanning small originals such as checks, it is especially important that the paper guides fit snugly against the edges of the original.

2. Fan the stack of document pages to ensure that the pages do not stick together. Fan the edge that will be pointing into the feeder in one direction, and then fan that same edge in the opposite direction.



3. Align the edges of the documents by tapping the bottom of the stack against the table top. Rotate the stack 90 degrees and repeat.

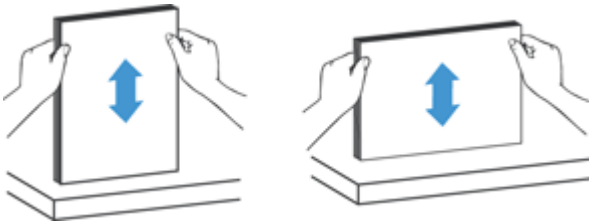

4. Gently set the stack in the document feeder. Load the pages face up with the top of the pages pointing into the feeder.

*For best results, do not drop the stack into the feeder and do not tap the top edge of the stack after you have placed it in the document feeder.*



---

**TIP:** Avoid feeding a document with a leading edge that has been folded or frayed. When you begin scanning, select a profile whose page loading selection matches the edge you are feeding first to ensure that the scan reflects the orientation of the original document.

---

5. Verify that the paper guides are aligned with the edges of the stack.

## Use the scanning glass

Place items that do not meet the specifications for the automatic document feeder (ADF) directly onto the scanning glass.

Minimum size:	No minimum size
Maximum size:	216 x 356 mm (8.5 x 14 in)



**NOTE:** Not all the length of the scanning glass is in the active imaging area, so make sure to position your originals as indicated by the reference mark on the edge of the scanning glass.

Place the original face down on the scanning glass, as indicated by the reference mark. For landscape pages, place the page face down with the top of the page pointing toward the back of the product.



**TIP:** To scan multiple pictures at the same time, arrange the pictures that you want to scan on the scanning glass with at least 6 mm (0.25 in) of space between items.





---

## 6 Scan and send documents

- [Sign in](#)
- [New scanner features](#)
- [Preview a scan](#)
- [Send a scanned document to one or more e-mails](#)
- [Fax a scanned document](#)
- [Save to a network folder or USB storage device](#)
- [Save to a SharePoint site](#)
- [Send or save a document using Quick Sets](#)
- [Scan to a workflow destination](#)

### Sign in

Depending on how your administrator has configured access privileges, you might need to sign in before using the product as well as when you access product features. The access your administrator has set for you might limit the features available to you.

1. Touch the **Sign In** button.
2. Complete the required fields, and then touch the **OK** button.

## New scanner features

- **Automatically Straighten (auto-deskew):** Use this feature to automatically straighten the scanned image when pages are skewed during scanning.
- **Automatic Tone**
- **Cropping Options:** Use this feature to specify a method to automatically crop the scan for digital sending.
  - **Do not crop** does not crop the scan.
  - **Crop to paper** crops the scan to the edge of the document being scanned through the automatic document feeder, based on the specified original document size.
  - **Crop to content** crops the image to the smallest possible rectangular area that has detectable content.
- **Edge Erase:** Use this feature to remove blemishes (such as dark borders or staple marks) by cleaning the specified edges of the scanned images to the specified measurement.
- **Job Build:** Use this feature to divide a complex job into smaller segments (for example, when scanning a document that has more pages than the document feeder can hold, or when scanning pages of different sizes in one job).
- **Retrieve from USB:** Use this feature to retrieve the following file types from an inserted USB device: .PDF, .PRN, .PCL, .PS, CHT.
- **Send document to a network printer:** Use this feature to send the output file to a specified network printer.
- **Scan document to a SharePoint site:** Use this feature to send the output file to a SharePoint destination.

## Preview a scan

Use the touch screen to navigate through the options on the Image Preview screen.

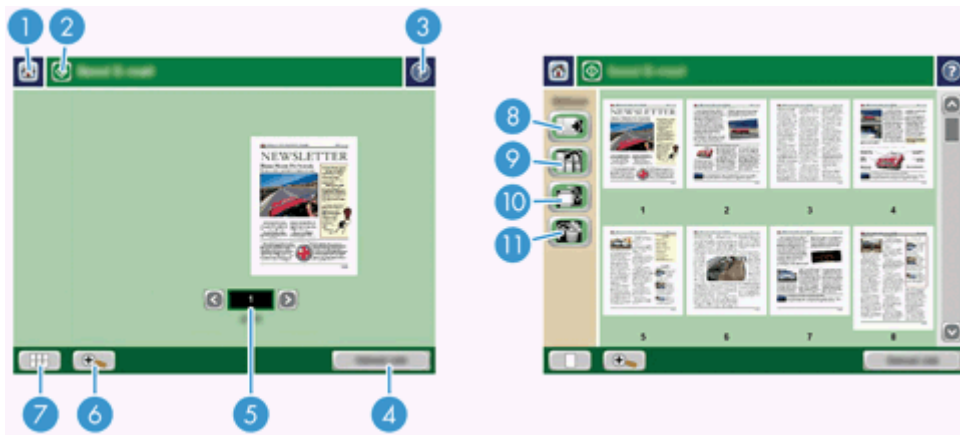

1	Home button	Touch this button to open the Home screen.
2	Start button	Touch this button to scan the document and send it to the specified destination.
3	Help button	Touch this button for control-panel help.
4	Cancel Job button	Touch this button to cancel your changes and return to previous screen.
5	Page control field	Type a number to view a page.
6	Zoom button	Touch this button to view the preview magnified.
7	View button	Touch this button to switch between single and multi-page views and to access more options.
8	Append Pages button	Touch this button to append a newly scanned document to the end of the document in the preview.
9	Move Pages button	Touch this button to move a selected page or pages.
10	Rotate Pages button	Touch this button to rotate the scan clockwise in increments of 90 degrees.
11	Delete Pages button	Touch this button to delete a selected page or pages.

## Use the Image Preview screen

You can preview a document and adjust certain document job options before sending the scan. The Image Preview screen is available for all scan destinations, but not all document job options are available for all scan destinations.

1. From a scan screen, touch the [Preview](#) button.
2. To increase the magnification for viewing purposes only, touch the Zoom button. Touch it again to return to the original magnification. To view parts of the zoomed page that might be off the screen, place your finger on the image and drag.

3. To see a multi-page view of the scanned document and move, append, delete, or rotate pages, touch the View button.
4. When you are done making changes, touch the Start button to save your changes and send the scan or the [Cancel Job](#) button to cancel your changes and return to the previous screen.

### Append pages

1. From the Image Preview screen, touch the View button.
2. Touch the Append Pages button.
3. In the [Append New Pages](#) dialog box, touch the [Scan](#) button. The pages are appended to the end of the document.

### Move pages

1. From the Image Preview screen, touch the View button.
2. Touch the pages you want to move. To deselect a page, touch it again. To select contiguous pages, touch the first and last pages of the group you want.
3. Touch the Move Pages button.
4. Touch the Insert icon where you want to move the pages.

### Rotate pages

1. From the Image Preview screen, touch the View button.
2. Touch the pages you want to rotate. To deselect a page, touch it again. To select contiguous pages, touch the first and last pages of the group you want.
3. Touch the Rotate Pages button. The page rotates clockwise in 90-degree increments with each touch.

### Delete pages

1. From the Image Preview screen, touch the View button.
2. Touch the pages you want to delete. To deselect a page, touch it again.
3. Touch the Delete Pages button.

## Send a scanned document to one or more e-mails

The e-mail feature offers the following benefits:

- Sends documents to multiple e-mail addresses, saving time and delivery costs.
- Delivers files in black-and-white or in color. Files can be sent in different file formats that the recipient can manipulate.

In order to use the e-mail feature, the product needs to be connected to a valid SMTP local area network that includes Internet access.

### Use the address book

You can send e-mail to a list of recipients using the address book feature. See your system administrator for information about configuring address lists.



**NOTE:** You can also use the Embedded Web Server (EWS) to create and manage the address book. The EWS address book can be used to add, edit, or delete single addresses or distribution lists.

### Create a recipient list

1. From the Home screen, touch the **E-mail** button.
2. Touch the **To:** field and then type the recipients' e-mail addresses. Separate multiple entries with a semicolon or by pressing enter on the keyboard.



**TIP:** You can also use the address book to enter e-mail addresses. For more information, see the built-in Help.

3. The names in the recipient list are placed in the text line of the keyboard screen. To add a recipient that is not found in the address book, type the e-mail address.
4. Touch the **OK** button.
5. Finish typing information in the **cc:**, **bcc:**, **Subject:**, and **Message:** fields on the **Send E-mail** screen, if necessary. To check the list of recipients, touch the down arrow in the **To:** text line.
6. Touch the **Start** button.

### Use the Personal or Shared Contacts address book

Use the Personal or Shared Contacts address book to store frequently-used e-mail addresses and to insert them into the **From:**, **To:**, **cc:**, or **bcc:** fields.

To open an address book, touch the Address Book button , and then select the appropriate contact entry.

### Add entries to the Personal or Shared Contacts address books

1. Touch the add button **+**.
2. Touch the **Name** field, and type a name for the new entry.  
The name is the alias for the entry.
3. Type the e-mail address for the new entry, complete any additional optional fields, and then touch the **OK** button.

## Delete entries from the Personal Contacts address book

You can delete entries that you no longer use.

 **NOTE:** To change an entry, highlight the text you want to change, and then type the new text.

1. Touch the entry that you want to delete from the Personal Contacts address book.
2. Touch the Remove button  in the lower right corner.
3. In the confirmation dialog box that appears, touch the **Delete** button to delete the entry or touch the **Cancel** button to return to the Address Book screen.

## Use the Send E-mail screen

Use the touch screen to navigate through the options on the **E-mail** screen.

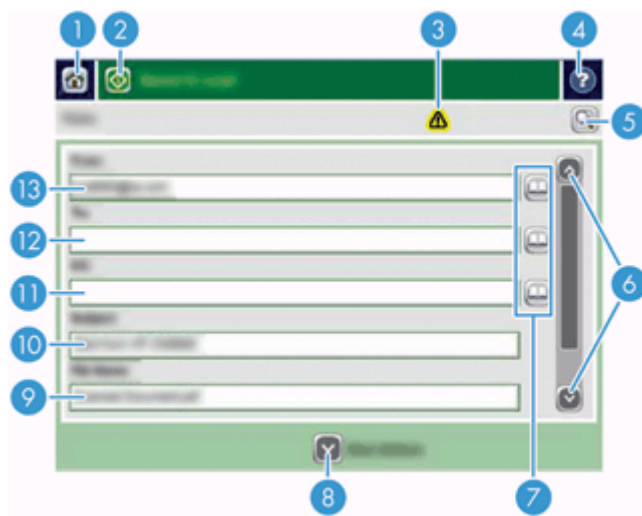

1	Home button	Touch this button to open the Home screen.
2	Send E-mail button	Touch this button to scan the document and send an e-mail file to the specified e-mail addresses.
3	Error/warning button	This button appears only when there is an error or warning in the status line area. Touch it to open a pop-up screen that will help you resolve the error or warning.
4	Help button	Touch this button for control-panel help.
5	Preview button	Touch this button to display a preview that you can modify before sending the scanned document.
6	Scroll bar	Use the Scroll bar to view and set up the <b>cc:</b> , <b>bcc:</b> , <b>Message:</b> , and <b>File Name:</b> fields. Touch any of those fields and add the necessary information.
7	Address book buttons	Touch these buttons to use the address book to populate the <b>To:</b> , <b>cc:</b> , or <b>bcc:</b> fields.
8	More Options button	Touch this button to change certain e-mail settings for the current scan job.
9	File Name: field	Touch this field and then type the name of the scanned document.
10	Subject: field	Touch this field and then type a subject title.
11	cc: field	Touch this field and then type the e-mail addresses of those secondary individuals whom you want to receive the scanned document.

---

12	<b>To:</b> field	Touch this field and then type the e-mail addresses of those primary individuals whom you want to receive the scanned document.
13	<b>From:</b> field	Touch this field and then type your e-mail address. If the system administrator has configured the product to do so, this field might automatically insert a default address.

---

## Send documents

The product scans both black-and-white and color originals. You can use default settings or change the scanning preferences and file formats.

---

 **TIP:** You can perform these tasks for a single-page document by placing the document face-down on the scanner glass.

---

## Send a document

1. Place the document face up in the document feeder.
2. From the Home screen, touch the **E-mail** button.
3. If prompted, type your user name and password.
4. Complete the **From:** and **To:** fields. Scroll down and complete the **cc:**, **bcc:**, and **Message:** fields if appropriate. Your user name or other default information might appear in the **From:** field. If so, you might not be able to change it.
5. (Optional) Touch the **More Options** button to change the settings for the document that you are sending (for example, the document's original size). If you are sending a two-sided document, you should select **Sides** and an option with a two-sided original. For information about other available features, see the built-in Help.
6. Touch the Start button to begin sending.
7. When you are finished, remove the original document from the output tray.

## Use the auto-complete function

When you type characters into the **To:**, **cc:**, or **From:** fields on the **Send E-mail** screen, the auto-complete function is activated. As you type the required address or name, the product automatically searches the address book list and completes the address or name by using the first match. You can then select that name by pressing enter on the keyboard, or continue typing the name until auto-complete finds the correct entry. If you type a character that does not match any entry in the list, the auto-complete text is removed from the display to indicate that you are typing an address that is not in the address book.

# Fax a scanned document

## Use the Send Fax screen

Use the touch screen to navigate through the options on the [Send Fax](#) screen.

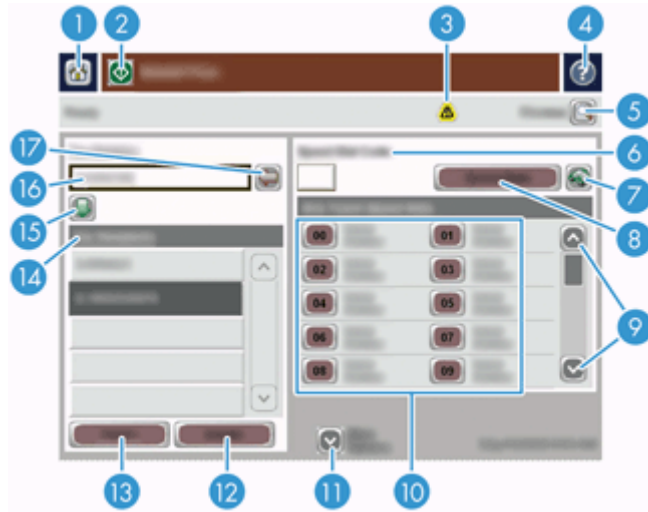

1	Home button	Touch this button to open the Home screen.
2	Send Fax button	Touch this button to scan the document and send a fax to the provided fax numbers.
3	Error/warning button	This button appears only when there is an error or warning in the status line area. Touch it to open a pop-up screen that will help you resolve the error or warning.
4	Help button	Touch this button for control-panel Help.
5	Preview button	Touch this button to display a preview that you can modify before faxing the scanned document.
6	Speed Dial Code field	Touch this button to type a speed dial code directly.
7	Search button	Touch this button to search for a speed dial code by name.
8	Speed Dials button	Touch this button to edit the speed dial.
9	Scroll bars	Use the scroll bar to view more entries.
10	One Touch Speed Dials list	Touch a button in this area to add the fax number to the Fax Recipients list.
11	More Options button	Touch this button to change certain fax settings for the current scan job.
12	Details button	Touch this button to display more information about the fax number highlighted in the Fax Recipients list.
13	Delete button	Touch this button to remove the highlighted fax number from the Fax Recipients list.
14	Fax Recipients list	Lists the numbers you have selected to receive the scanned document.
15	Add fax number button	Touch this button to add the fax number in the Fax Number: field to the Fax Recipients list.
16	Fax Number: field	Touch this field and then type a fax number.
17	Delete character button	Touch this button to backspace and delete numbers in the Fax Number: field.



## Send a fax

1. Place the document face up in the document feeder.
2. From the Home screen, touch the [Fax](#) button.
3. If prompted, type your user name and password.
4. Specify the fax numbers by using one or both of these methods:

---

Use the [Fax Number:](#) field      Type the fax number.

(Optional) Type additional fax numbers separated by semi-colons.

---

Use a speed dial      From the [Send Fax](#) screen, touch the code in the [One Touch Speed Dials](#) list.

---

5. (Optional) Touch the [More Options](#) button to change the settings for the document that you are sending. For information about available features, see the built-in Help.
6. Touch the Start button to begin sending.

## Save to a network folder or USB storage device

If the system administrator has made the feature available, the product can scan a file and save it to either a USB storage device or a network folder. Supported operating systems for folder destinations include Windows 2000, Windows XP, Windows Server 2003, and Windows Server 2008.

1. Place the document face up in the document feeder.
2. If you are saving to a USB storage device, insert it into the USB connector next to the control panel.
3. On the Home screen, touch either the [Save to Network Folder](#) or the [Save to USB](#) button.
4. In the folders list, touch the folder in which you want to save the document.
5. Select a quick set or touch the [File Name:](#) field, and then type the name of the file.
6. Touch the [More Options](#) button to change the settings for the document you are sending.
7. Touch the Start button.



**NOTE:** The additional options are the same as the e-mail options.

---

## Save to a SharePoint site

If the system administrator has made the feature available, the product can scan a document and save the file to a SharePoint site.

1. Place the document face up in the document feeder.
2. On the Home screen, touch the **Save to SharePoint** button.
3. Select an existing SharePoint quick set.

---

 **TIP:** A SharePoint quick set is either accessible directly from the Home screen, or from the **Quick Sets** button on the Home screen, depending on how the save-to-SharePoint option was defined.

---

4. If prompted, type your user name and password.
5. If necessary, press the **Start** button on the control panel to start the scan.

---

 **NOTE:** It is possible to configure a scan-to-SharePoint quick set to start automatically when the SharePoint option is selected.

---

## Send or save a document using Quick Sets

If the system administrator has made the feature available, the product can scan a file using preset settings for fax numbers, e-mail recipients, network folders, or USB storage devices.

Depending on how your administrator has configured [Quick Sets](#), you can also touch the [Quick Sets](#) button on the Home screen to display a list of available [Quick Sets](#).

1. Place the document face up in the document feeder.
2. From the Home screen, touch a [Quick Sets](#) button. Those [Quick Sets](#) buttons that have a small Start icon on them start scanning when you touch them.
3. If prompted, type your user name and password.
4. If a screen for sending the scanned document to e-mail, fax, or a network folder displays, complete the fields, and then touch the Start button.

## Scan to a workflow destination



**NOTE:** This product feature is provided by the optional Digital Sending Software.

---

If the system administrator has enabled the workflow functionality, you can scan a document and send it to a custom workflow destination. A workflow destination gives you the ability to send additional information, along with the scanned document, to a specified network or file transfer protocol (FTP) location. Prompts for specific information appear on the control-panel display. The system administrator can also designate a printer as a workflow destination, which allows you to scan a document and then send it directly to a network printer for printing.

1. Place the document face up in the document feeder.
2. From the Home screen, touch a workflow button.
3. Complete the fields. The fields vary based on how your administrator has configured the workflow.
4. Touch the Start button.



---

# 7 Maintain the product

This section presents information about how to maintain the product.

- [Order maintenance and scanning supplies](#)
- [Clean the touch screen](#)
- [Clean the scanning glass, scanning strip, and automatic document feeder \(ADF\) duplex background](#)
- [Clean the rollers](#)

## Order maintenance and scanning supplies

You can purchase maintenance parts for your product.

1. See the HP product parts Web site at [www.hp.com/buy/parts](http://www.hp.com/buy/parts).
2. Select your language, and then click the arrow.

## Clean the touch screen

Clean the touch screen whenever it is necessary to remove fingerprints or dust. Wipe the touch screen gently with a clean, water-dampened, lint-free cloth.

---

 **CAUTION:** Use water only. Solvents or cleaners can damage the touch screen. Do not pour or spray water directly onto the touch screen.

---

## Clean the scanning glass, scanning strip, and automatic document feeder (ADF) duplex background

The scanning glass, scanning strip, and ADF duplex background should be cleaned periodically or any time a scanned image has streaks.

To clean these components, follow these steps:

1. Press the Power button to turn off the product, and then disconnect the power cable.
2. Open the scanning lid.



3. Clean the scanning glass and scanning strip with a soft, lint-free cloth that has been sprayed with a mild glass cleaner.



---

**⚠ CAUTION:** Use only glass cleaner to clean the scanning glass and scanning strip. Avoid cleaners that contain abrasives, acetone, benzene, and carbon tetrachloride, all of which can damage the scanning glass. Avoid isopropyl alcohol because it can leave streaks on the glass.

Do not spray the glass cleaner directly on the scanning glass or scanning strip. If too much glass cleaner is applied, the cleaner could leak under the scanning glass or scanning strip and damage the product.

---

4. Dry the glass with a dry, soft, lint-free cloth.

5. Close the scanning lid, and then raise the scan input tray until it is perpendicular to the product.



6. Press in on the ADF duplex background tabs to release the ADF duplex background (1), and then pull forward to remove the ADF duplex background from its housing (2).

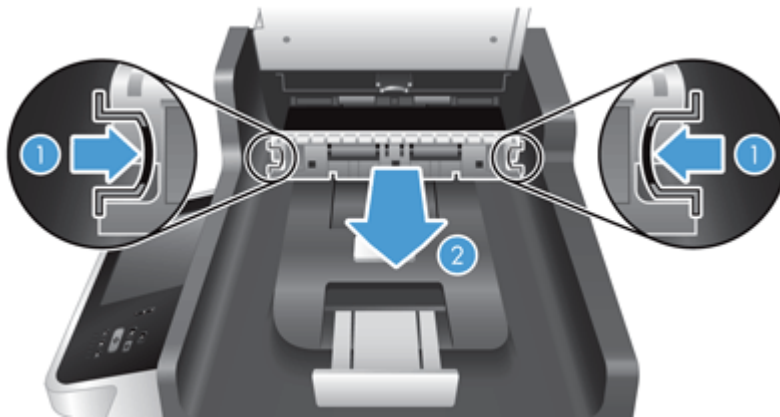

7. Wipe the two scanning strips (one black, one white) on the ADF duplex background (1) and the strip inside the ADF duplex background enclosure (2) with a soft, lint-free cloth that has been moistened with warm water.

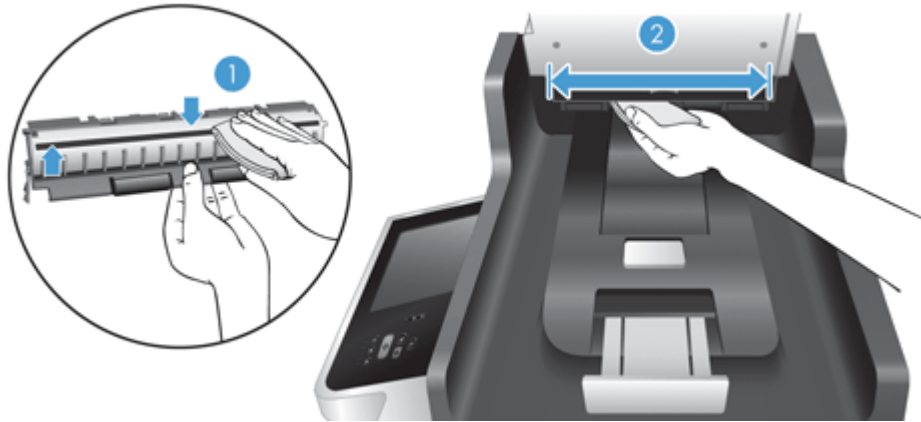

8. Dry the scanning strips with a dry, soft, lint-free cloth, and then slide the component into its housing until both tabs click into place.



9. Lower the scan input tray into place, and then reconnect the power supply to the product.
10. Press the Power button to turn on the product.

## Clean the rollers

Clean the rollers under the following conditions:

- You experience repeated document jams.
- The product does not pull pages into the paper path.
- The scanned images are elongated.
- You frequently scan any of the following types of documents: coated paper, chemically treated documents such as carbonless paper, documents with a large amount of calcium carbonate, documents written with pencils, documents on which the toner has not fused.

To clean the rollers, follow these steps:

1. Press the Power button to turn off the product, and then disconnect the power cable.
2. Open the automatic document feeder (ADF) hatch.



3. Remove any visible lint or dust from each of the feed rollers and the separation pad using compressed air or a clean lint-free cloth moistened with warm water.

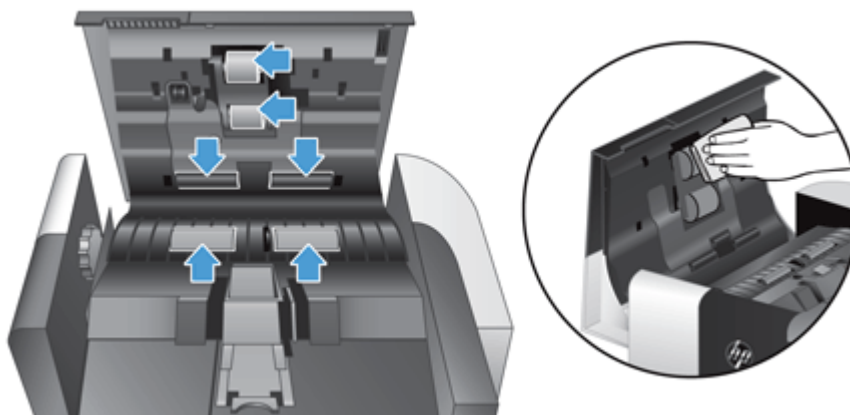

4. Close the ADF hatch, and then reconnect the power supply to the product.
5. Press the Power button to turn on the product, and then update the product maintenance history.

- a. On the Home screen, touch the [Device Maintenance](#) button.
- b. Touch the [Clean Rollers](#) button.
- c. Scroll down through the online maintenance procedure and touch the [Complete Maintenance Procedure](#) button.
- d. Touch [OK](#) to record the maintenance activity and reset the counters to zero.



---

## 8 Replace and install components

This section presents information about how to replace and install product components.

- [Replace the rollers](#)
- [Replace the separation pad](#)
- [Replace the front panel](#)
- [Replace the keyboard](#)
- [Replace the hard drive](#)
- [Install a Jetdirect card](#)
- [Install an accessory into the hardware integration pocket](#)

Animations which guide you through several maintenance tasks are available on the web. For the latest parts information and animations, see [www.hp.com/support](http://www.hp.com/support), and search on your product.

## Replace the rollers

Replace the rollers under the following conditions:

- When the message **Document Feeder Kit Low** displays in the status line on the Home screen (a warning button displays to the right of the status line).
- If you experience repeated document jams and cleaning the rollers did not help.

---

 **TIP:** An animation which guides you through removing and replacing the rollers is available on the web (see [www.hp.com/support](http://www.hp.com/support), and search on your product).

---

The roller replacement kit includes a replacement separation pad. Make sure to replace the separation pad when you replace the rollers. To order the replacement kit, see [www.hp.com/buy/parts](http://www.hp.com/buy/parts).

---

 **NOTE:** The roller replacement kit is a consumable and is not covered under warranty or standard service agreements.

---

To replace the rollers, follow these steps:

1. Press the Power button to turn off the product, and then disconnect the power cable.
2. Open the automatic document feeder (ADF) hatch.





3. Slide your fingertip behind the tab on the roller assembly door, and then pull gently forward and down to open the door.

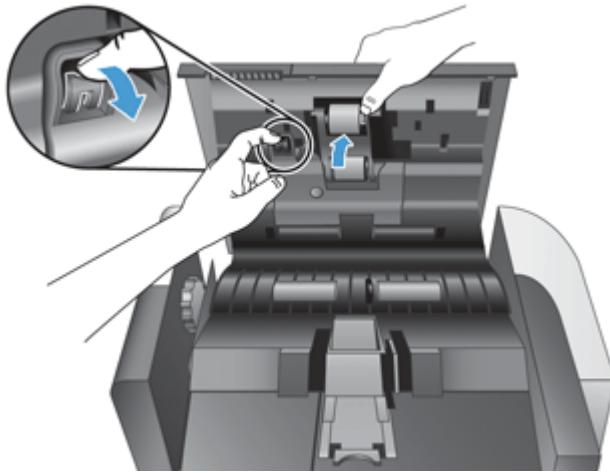

4. Holding the roller assembly door down and out of the way, grasp the roller assembly and slide it to the left to release it from the enclosure.

**CAUTION:** Do not touch the rollers with bare fingers, as oils from your fingers could impact performance.

**NOTE:** You might feel a slight resistance when sliding the roller assembly.

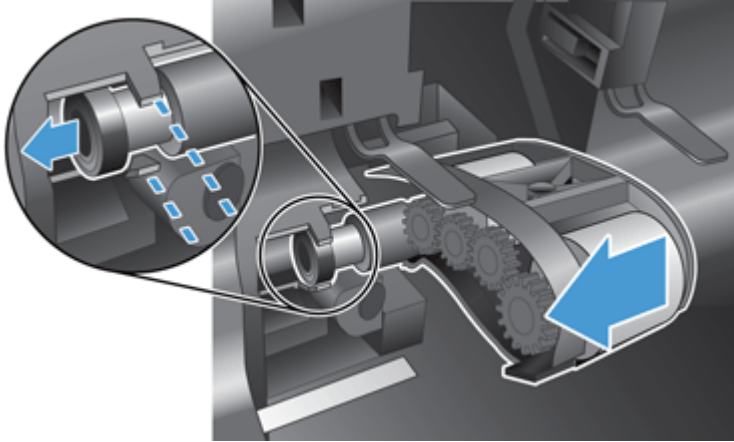

**CAUTION:** Take care not to press down on the alignment tabs (1) or against the tab to the right of the roller assembly (2).

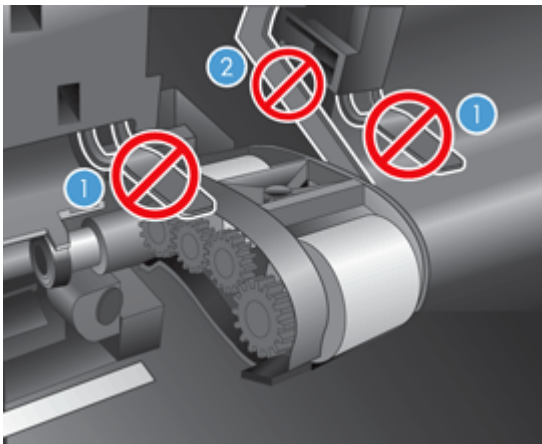

5. Lift the roller assembly out and set it aside.

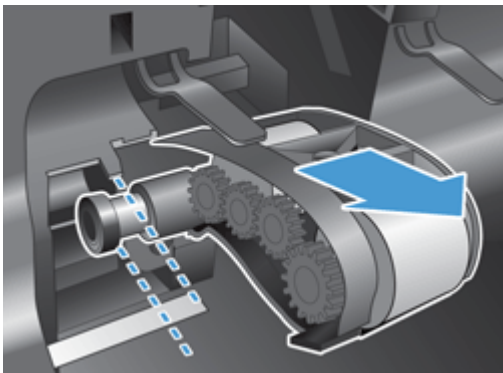

6. Holding the roller assembly door down and out of the way, insert the new roller assembly into the enclosure and slide it to the right until it is seated firmly.

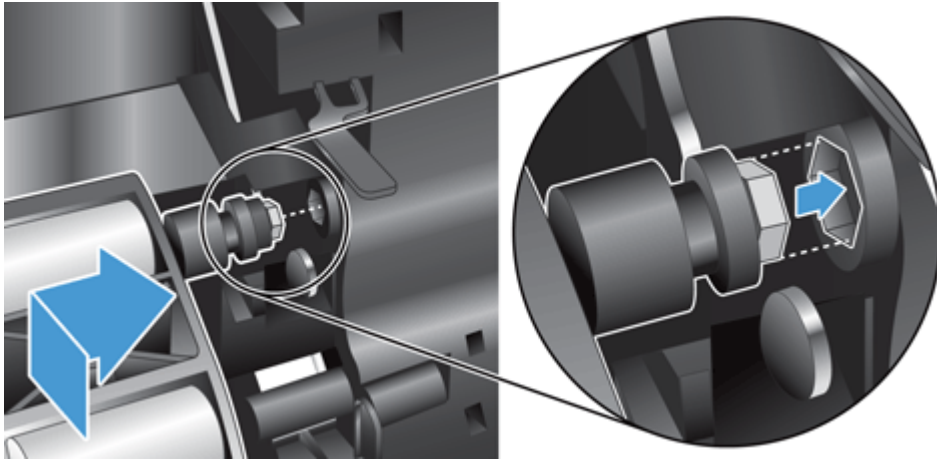

7. Close the roller assembly door, pressing firmly against the door until you hear a click (the click indicates that the latch is seated correctly).

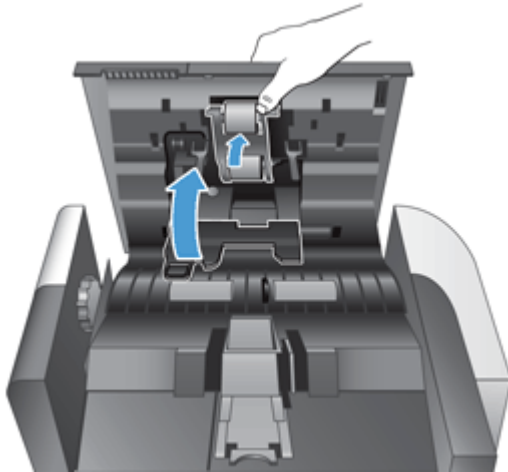

---

 **NOTE:** HP recommends that you replace the rollers and separation pad every 100,000 scans.

---

Once the rollers are replaced, replace the separation pad and then log the maintenance activity.

## Replace the separation pad

The roller replacement kit includes a replacement separation pad. Always replace the separation pad when you replace the rollers. To order the roller replacement kit, see [www.hp.com/buy/parts](http://www.hp.com/buy/parts).

 **TIP:** An animation which guides you through removing and replacing the separation pad is available on the web (see [www.hp.com/support](http://www.hp.com/support), and search on your product).

To replace the separation pad, follow these steps:

1. Make sure the scanner is turned off and the power cable is disconnected.
2. Open the automatic document feeder (ADF) hatch.



3. Raise the ADF input tray (1), and then press forward on the separation pad latch to release the separation pad from its locked position (2).

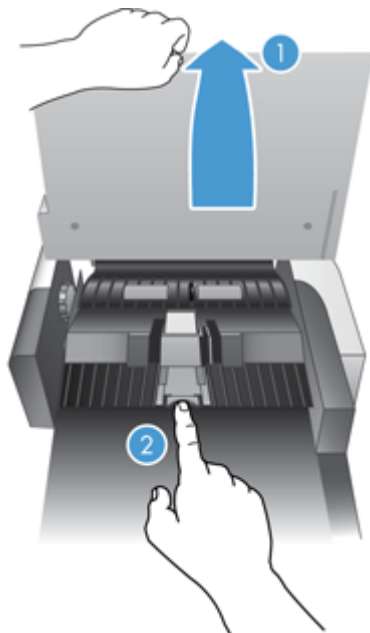

4. Lift up on the separation pad component, release it from its housing, and set it aside.

 **TIP:** This is easier to do if you lower the input tray.

 **CAUTION:** Do not touch the pad itself with bare fingers, as oils from your fingers could impact performance.

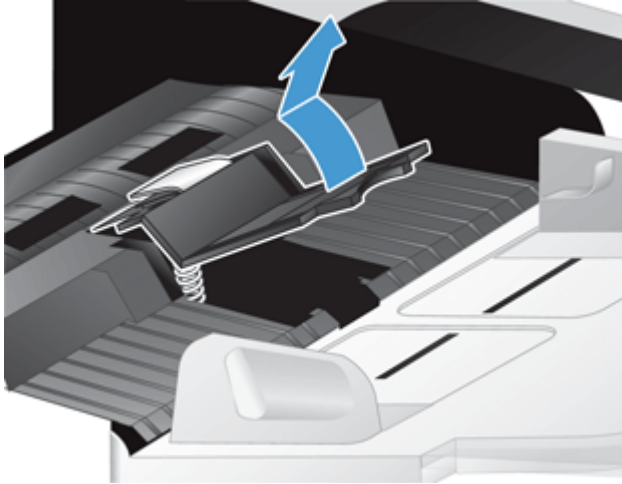

5. Slide the rear edge of the new separation pad component into its housing, ensuring that the spring below the pad is not bent down.

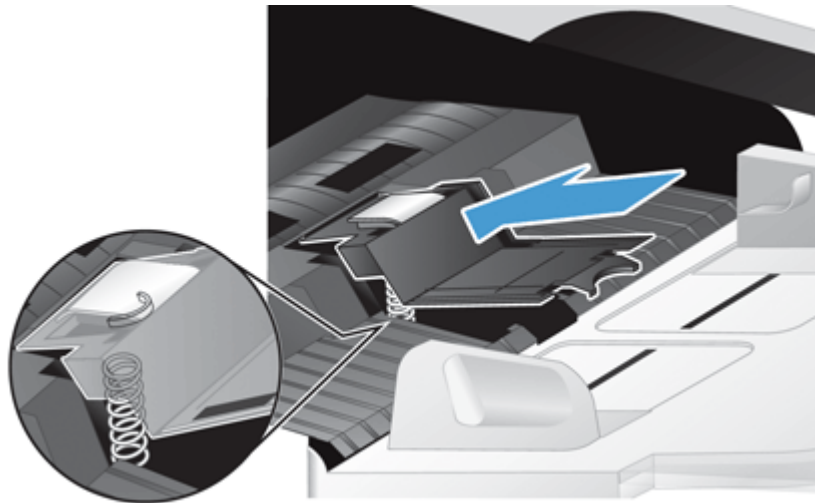

6. Press down on the front portion of the separation pad component until you hear an audible click, indicating that the pad is seated firmly.

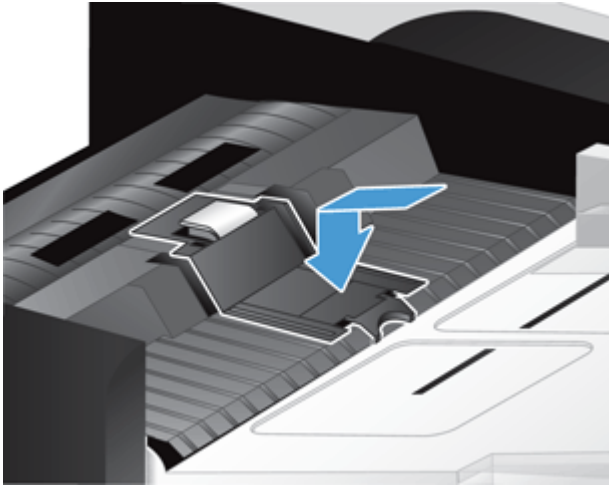

 **TIP:** Taking care not to touch the pad with bare fingers, press down on the pad and then release, ensuring that the pad springs back up. This indicates that the spring below the pad is positioned correctly.

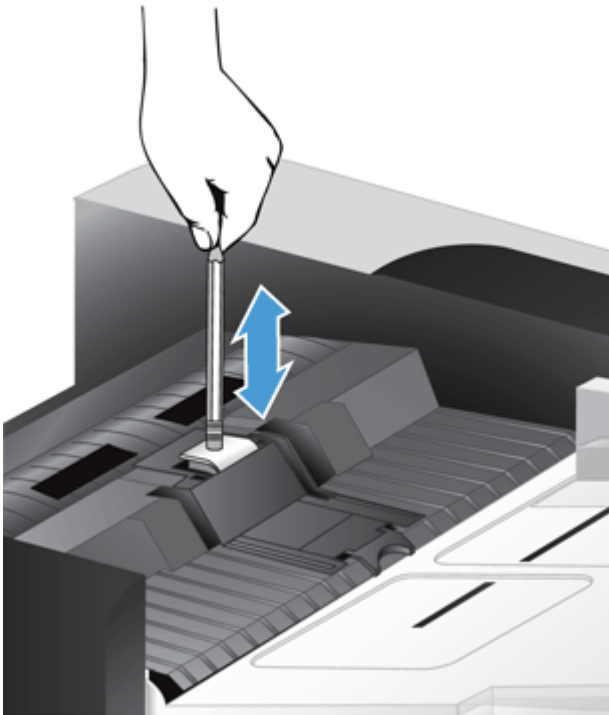

7. Close the ADF hatch, reconnect the power supply to the product, and then turn on the product.
8. Update the product maintenance history.
  - a. On the Home screen, touch the [Administration](#) button.
  - b. Touch the [Manage Supplies](#) button, touch the [Reset Supplies](#) option, and then touch the [New Document Feeder Kit](#) option.

- c. Scroll down through the online maintenance procedure and touch the [Complete Maintenance Procedure](#) button.
- d. Touch [OK](#) to record the maintenance activity and reset the counters to zero.



**NOTE:** HP recommends that you replace the rollers and separation pad every 100,000 scans.

---

## Replace the front panel

 **TIP:** An animation which guides you through removing and replacing the front panel is available on the web (see [www.hp.com/support](http://www.hp.com/support), and search on your product).

To replace the front panel, follow these steps:

1. Press the Power button to turn off the product, and then disconnect the power cable.
2. Raise the scan lid.
3. Locate the indents on the underside of the front panel, press in at the location shown, and then lift the front panel gently as it releases.

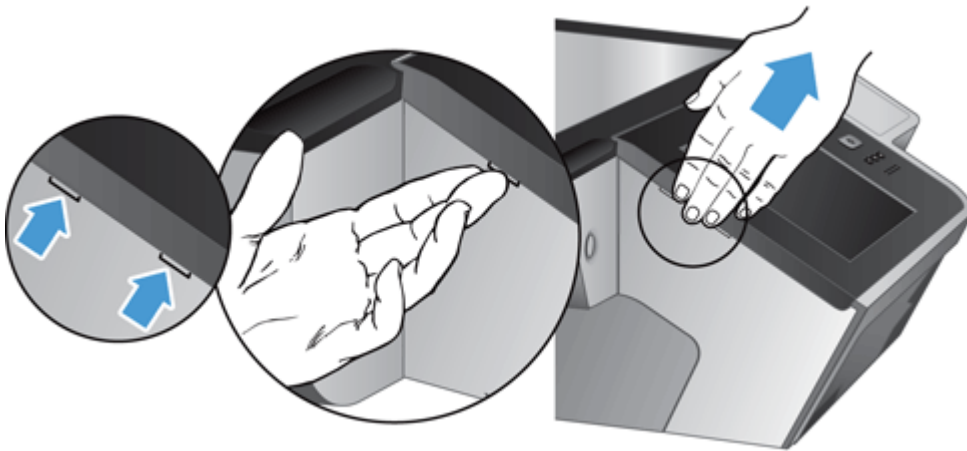

4. Invert the front panel, hold it firmly with one hand, disconnect the ribbon cable (1), and then gently pull the ribbon cable through the cable restraint (2).

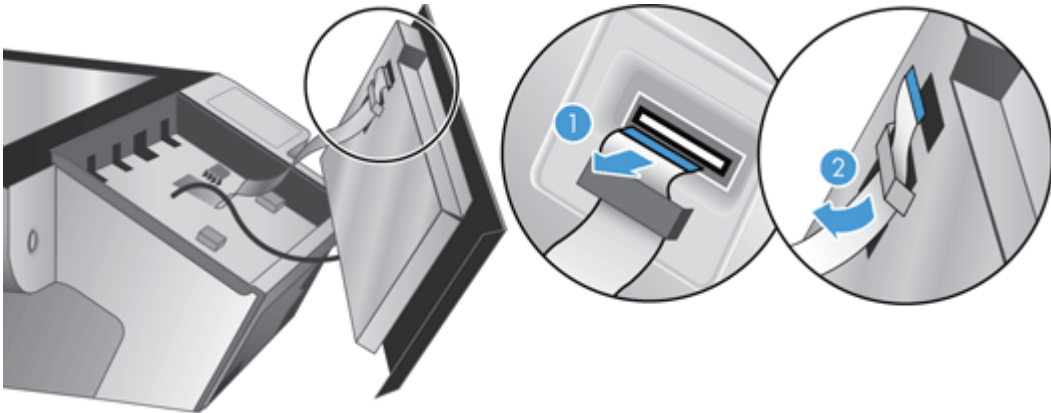



5. While still holding the front panel in an inverted position, disconnect the front panel cable and set the front panel aside.

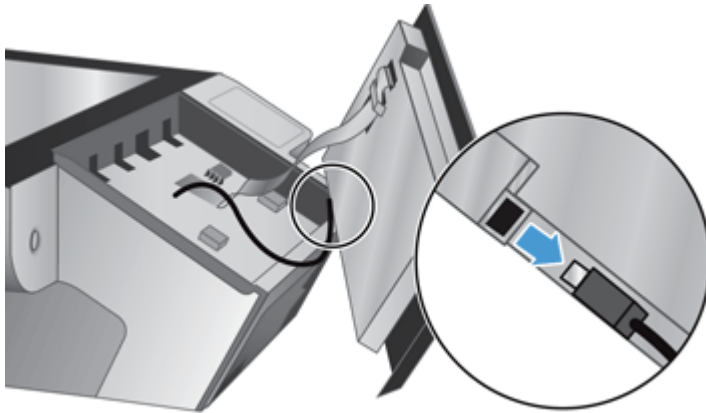

6. Connect the new front panel to the front panel cable.

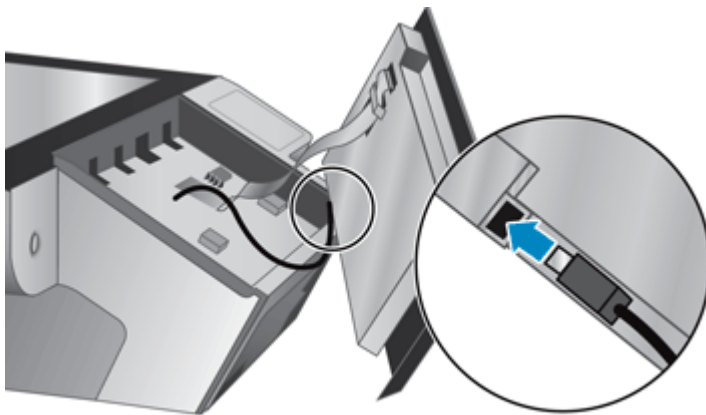

7. Gently feed the ribbon cable through the cable restraint (1) and connect the ribbon cable (2).

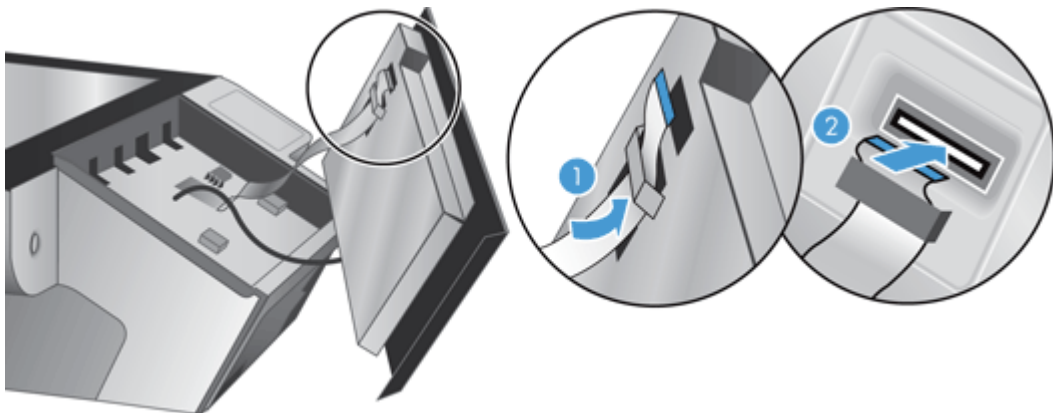

8. Invert the front panel so that it is touch screen side up, position the front panel to align with the bezel (1), and then press down on the front panel to seat it in place (2).

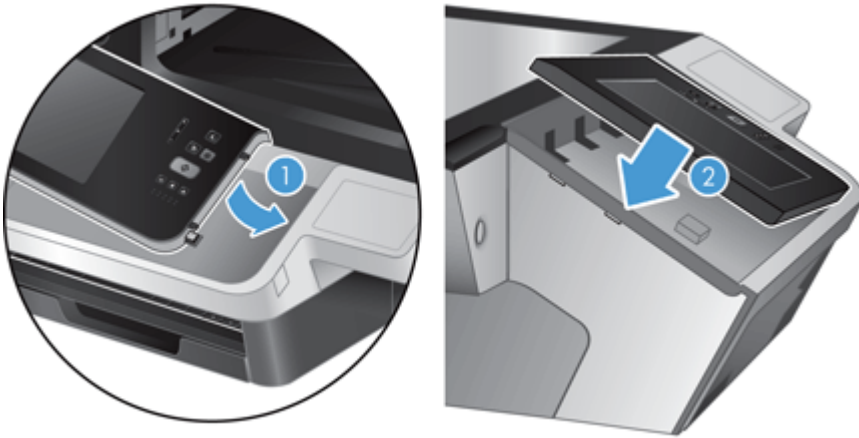

9. Close the scan lid, reconnect the power cable, and then turn on the product.

# Replace the keyboard

You can order keyboards in several languages as accessories.

To replace the keyboard, follow these steps:

1. Press the Power button to turn off the product, and then disconnect the power cable.
2. Remove the keyboard.
  - a. Slide the four sliding tabs toward the front of the product to release the keyboard (1), and then gently lift the keyboard up and away from the keyboard frame (2).



- b. Gently squeeze in on the cable connector to release the keyboard cable, and then set the keyboard aside.



3. Insert the new keyboard.
  - a. Connect the new keyboard's cable.



- b.** Position the new keyboard over the keyboard frame so the fixed tabs on the keyboard align with the tab slots on the frame (1), gently push the keyboard against the keyboard frame (2), and then push the four sliding tabs in to secure the keyboard (3).

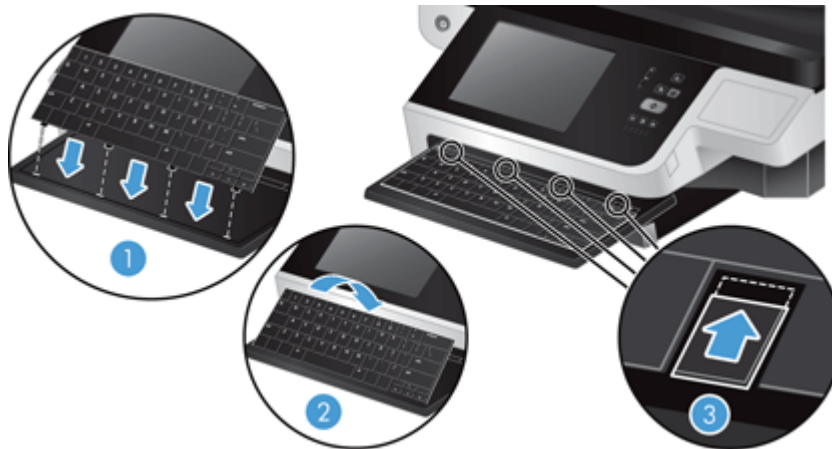

- 4.** Reconnect the power supply to the product, and then press the **Power** button to turn on the product.

# Replace the hard drive

HP recommends doing routine, scheduled backups as a best practice. Doing routine backups will minimize data loss in the event of a hard drive failure.

To replace the hard drive, follow these steps.

1. Press the Power button to turn off the product (1), disconnect power from the product (2), and then disconnect the Ethernet cable (3).

If used, remove the cable-style lock (sometimes called a “Kensington lock”).

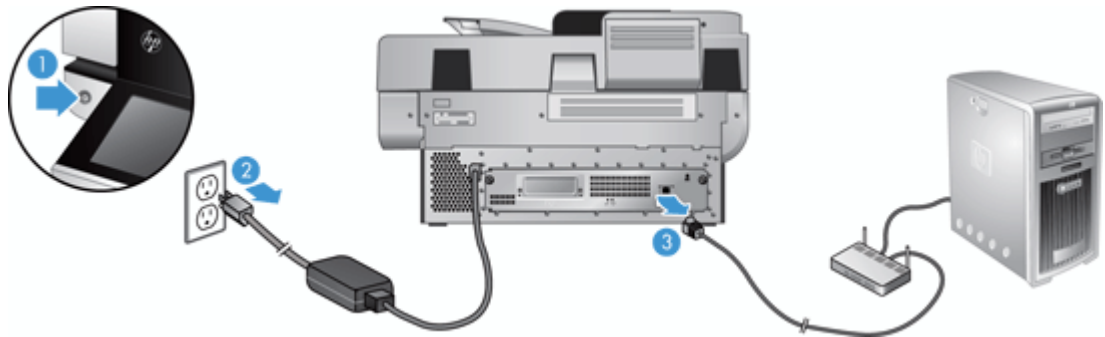

2. Loosen the two thumbscrews which secure the rear panel drawer assembly to the product (1), and then slide the drawer assembly out of its enclosure.

You may encounter some resistance as you slide the drawer assembly.

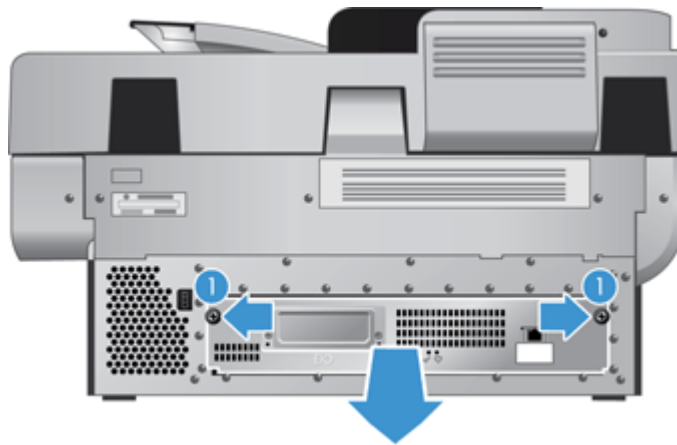

3. Gently lift the drive rail lever on the left leading edge of the hard drive (1), slide the drive forward (2), and then disconnect the cable from the hard drive.

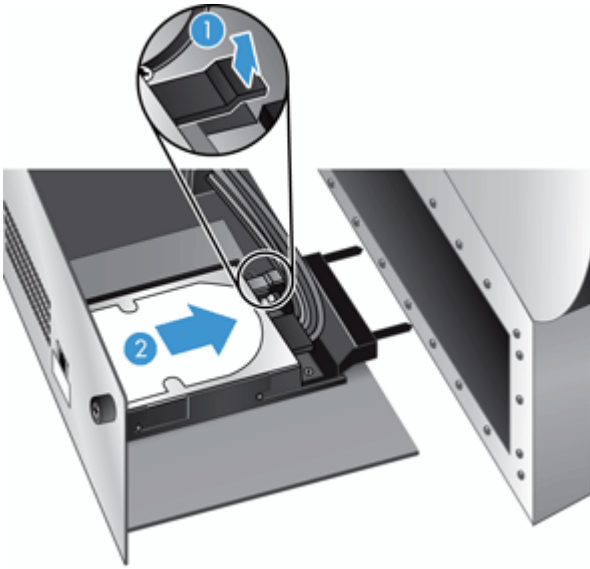

4. Lift the hard drive out of the drawer assembly and set the hard drive aside.
5. Remove the black plastic rails from the drive you just removed, and then attach them to the new drive.

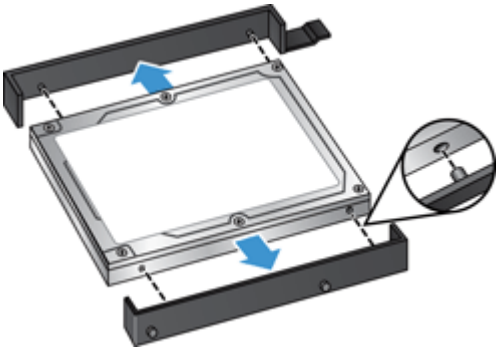

6. Slide the hard drive into the drive housing until it snaps into place (ensure that the pegs on the side of the drive rails fit into the slot on the drive housing), and then connect the drive cable to the drive.

 **NOTE:** Make sure to tuck the drive cable under the cable restraint.



7. Slide the rear panel drawer assembly into place (taking care that no cables are pinched), ensure that the drawer assembly is seated firmly against the chassis, and then tighten the thumbscrews.
8. Reconnect the power and Ethernet cables, and, optionally, the cable-style lock, and then press the Power button to turn on the product.

## Install a Jetdirect card

To install a Jetdirect card, follow these steps.

1. Press the Power button to turn off the product (1), disconnect power from the product (2), and then disconnect the Ethernet cable (3).

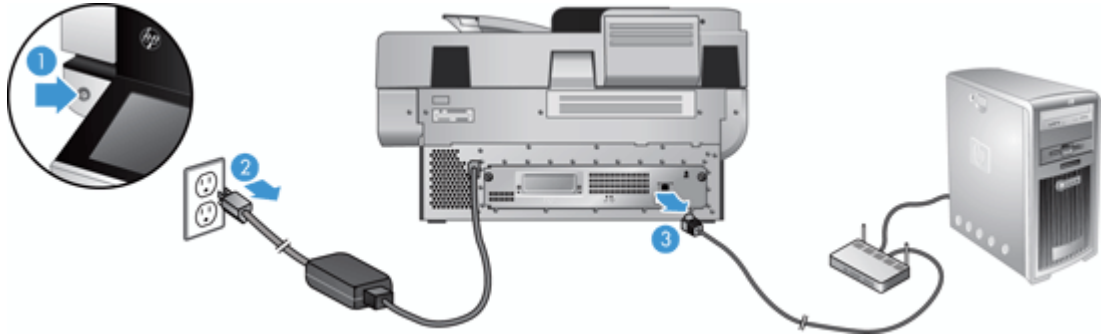

2. Loosen the two screws which secure the Jetdirect card cover plate to the back of the product (1), and then remove the cover plate (2) and set it aside.

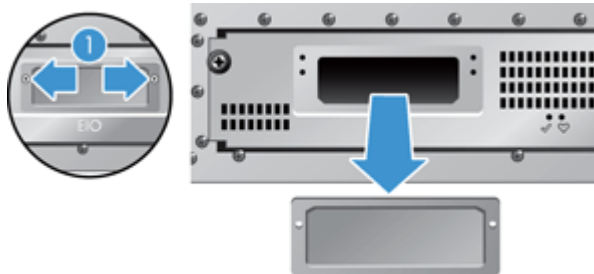

3. Remove the replacement Jetdirect card from its packaging and insert the card into the card slot ledge-side up, as shown.

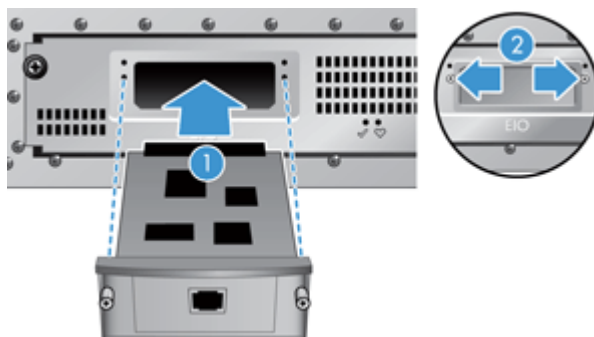

- a. Align the card with the guide rails in the slot.
- b. Firmly press the card into the slot until the card is seated (2), and then secure the card with the card plate screws (1).



4. Connect the Ethernet cable to the formatter (1), reconnect power (2), and then press the Power button to turn on the product (3).

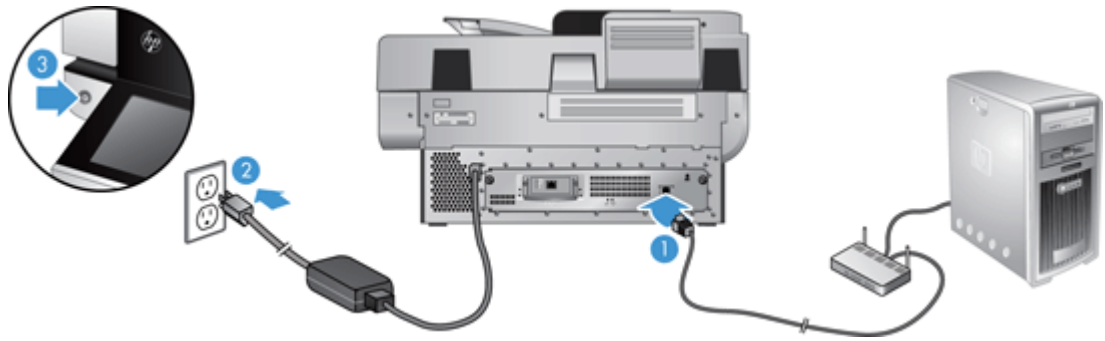

## Install an accessory into the hardware integration pocket

You can install a separately-purchaseable HP accessory (for example, a proximity reader, fingerprint reader, or magnetic-swipe reader) into the integrated hardware integration pocket (HIP).

 **NOTE:** This procedure describes installing a proximity card reader. Steps identified as **if applicable** might not apply to other HIP accessories. Always refer to the installation instructions that came with your accessory.

To install an accessory into the HIP, follow these steps:

1. Press the Power button to turn off the product (1), and then disconnect the power cable (2)..

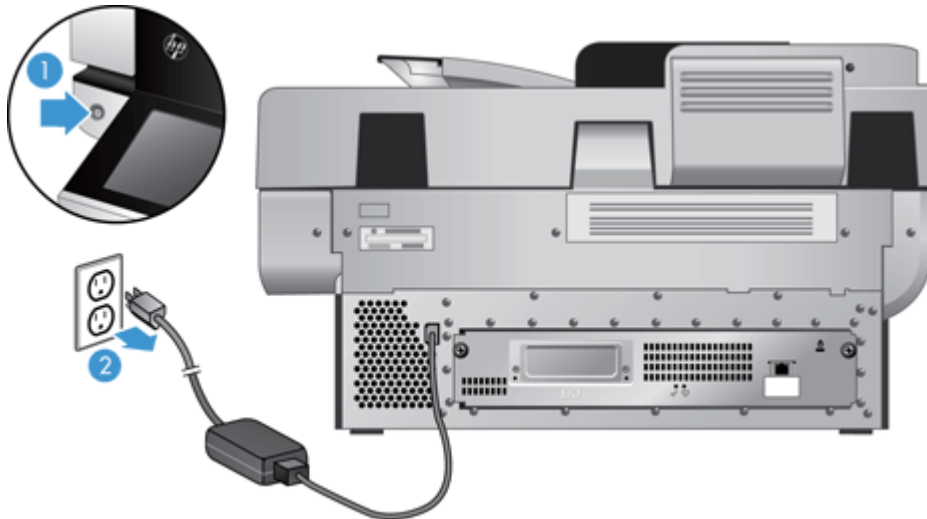

2. Insert the edge of a credit card into the groove at the top of the HIP cover and gently pry the cover free; set the cover aside.

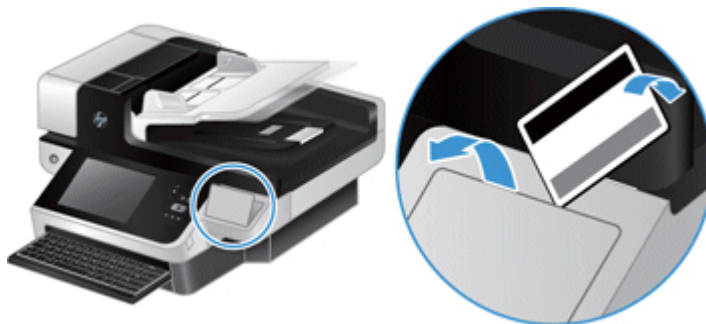

3. Remove the HIP accessory from its packaging and install the accessory into the HIP.
  - a. Connect the accessory's USB cable into the connector on the left side of the HIP enclosure.



- b. Connect the USB cable to the cable connector on the accessory (1), and then connect the grounding connector to the grounding strip on the accessory, if applicable (2).

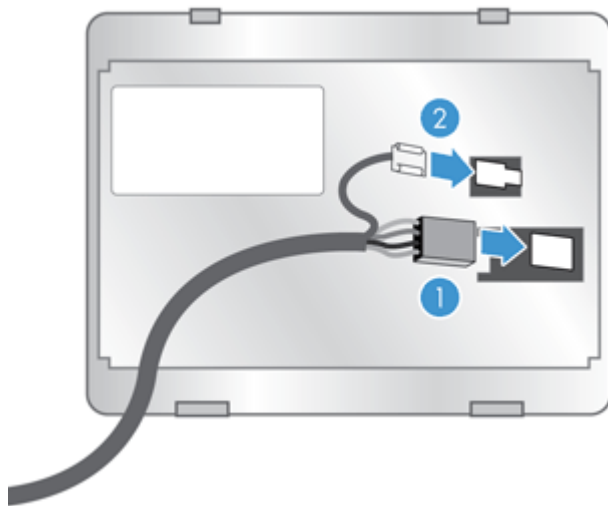

 **NOTE:** The connectors shown are for a proximity card reader. The cable connector for your accessory might be slightly different, and might not include a ground connector.

- c. Align the pegs on the underside of the accessory with the connectors in the HIP, insert the accessory into the HIP, and then press down gently to snap the accessory into place.

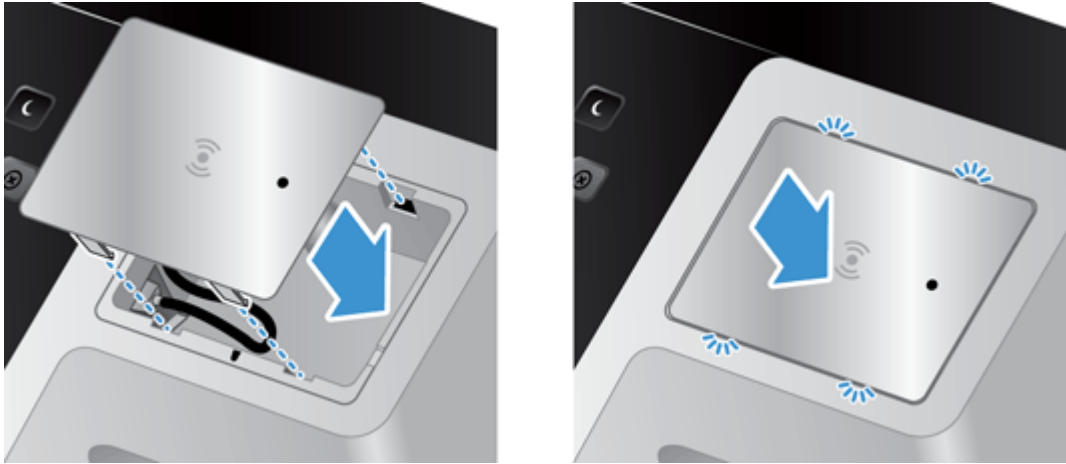

4. Connect the power cable, and then press the Power button to turn on the product.

---

# 9 Troubleshooting

This section contains solutions for common problems with the product.

- [Scan errors](#)
- [Basic troubleshooting tips](#)
- [Installation problems](#)
- [Initialization or hardware problems](#)
- [The product has paused or shut down](#)
- [Paper feeding problems](#)
- [The product has stopped working correctly](#)
- [Solve e-mail problems](#)
- [Solve network problems](#)
- [Restore factory settings](#)
- [Contact HP Support](#)

For additional troubleshooting, see the Help for the HP scanning program that you are using.

## Scan errors

Follow the displayed instructions and, if applicable, video to resolve an error.

Error	Description
<b>ADF empty</b>	No document was detected in the document feeder.
<b>Automatic calibration failed</b>	A hardware failure occurred when the product attempted to calibrate prior to scanning.
<b>Communication failed</b>	A scanner communication failure occurred.
<b>Fan failed</b>	The product's fan failed.
<b>Hardware error</b>	A hardware failure occurred.
<b>Hatch open</b>	The hatch on the document feeder is open or not securely latched.
<b>Lamp failed</b>	The product lamp failed.
<b>Mispick</b>	The product has detected a document feeder page mispick (for example, no pages fed through the product).

<b>Error</b>	<b>Description</b>
<b>Multi-pick</b>	The product has detected a multiple-page feed error.
<b>Multi-pick sensor failed</b>	The product's multi-pick paper sensor has failed.
<b>Paper jam</b>	The product has detected a document feeder paper jam.

## Basic troubleshooting tips

Simple issues such as smudges on the scanning glass or loose cables can cause your product to produce fuzzy scans, operate in an unexpected manner, or fail to operate. Always check the following items when you encounter scanning problems.

- If scans are fuzzy, check to see if the scanning strip to the left of the scanning glass is dirty or smudged. If so, clean the scanning strip.  
  
If you are scanning a document that will be analyzed using Optical Character Recognition (OCR), make sure that the original document is clear enough to be analyzed.
- Make sure that the Ethernet and power cables are firmly seated in their respective connectors on the back of the product, and that the power cord is plugged into a working electrical outlet or surge protector.
- Ensure that the product is receiving power.
  - Check that the green LED on the power supply case is on.
  - If the green LED is not on, ensure that power is available to the power outlet or surge protector that the power supply is plugged into.
  - If power is available to the power outlet or surge protector but the green LED is still not on, the power supply might be defective. Contact [www.hp.com/support](http://www.hp.com/support) for assistance.
- Make sure that the two formatter status LEDs on the back panel drawer assembly are green (one should glow steadily, the other should blink). This indicates that the formatter is functioning correctly.
- Make sure that the product buttons are enabled.
- Press the Power button to turn off the product, wait 30 seconds, and then press the Power button again to turn on the product.
- Make sure the automatic document feeder (ADF) hatch is closed.
- Verify that the product is connected to the LAN, and that the product is correctly configured to use the network.

If you continue to have problems, it is possible that your firmware or associated drivers are out of date or have become corrupted. See [www.hp.com/support](http://www.hp.com/support) to locate firmware and driver updates for your product.

## Installation problems

Cable type	Action
Power supply cable	<p>The power supply is connected between the product and a power outlet.</p> <ul style="list-style-type: none"><li>• Ensure that the power supply is securely connected to the product.</li><li>• Ensure that the power cable is securely connected between the power supply and a live electrical outlet or surge protector.</li><li>• If the power cable is connected to a surge protector, ensure that the surge protector is plugged into an outlet and turned on.</li><li>• Press the Power button to turn off the product, wait 30 seconds, and then press the Power button again to turn on the product.</li></ul>
Ethernet cable	<p>Ensure that the Ethernet cable is securely connected between the product and a network router, Ethernet jack, or Ethernet switch.</p> <p>For additional Ethernet troubleshooting information, see <a href="http://www.hp.com/support">www.hp.com/support</a>, select your country/region, and then use the search tool to find <b>Ethernet</b> or <b>network</b> troubleshooting topics.</p>

## Initialization or hardware problems

- [Check the Ethernet connection](#)
- [Check that the product has power](#)
- [Reset the product](#)

### Check the Ethernet connection

1. Ensure that the Ethernet cable is firmly connected between the product and a router, Ethernet jack, or Ethernet switch.
2. If the Ethernet cable is connected to a network router or Ethernet switch, try connecting it to a different port on the router or switch.
3. Press the Power button to turn off the product, wait 30 seconds, and then press the Power button again to turn on the product.



## Check that the product has power

The power cable is connected between the product and a power outlet.

- Ensure that the power cable is securely connected between the product and a live electrical outlet.
- If the power cable is connected to a surge protector, ensure that the surge protector is plugged into an outlet and turned on.
- Ensure that the product is receiving power.
  - Check that the green LED on the power supply case is on.
  - If the green LED is not on, ensure that power is available to the power outlet or surge protector that the power supply is plugged into.
  - If power is available to the power outlet or surge protector but the green LED is still not on, the power supply might be defective. Contact [www.hp.com/support](http://www.hp.com/support) for assistance.

If the problem persists after verifying the above items, follow these steps:

1. Press the Power button to turn off the product, and then disconnect the power cable.
2. Wait 30 seconds.
3. Reconnect the power cable, and then turn on the product.

## Reset the product

If you receive an error message similar to **Scanner initialization failed** or **Scanner not found** when trying to use the product, you should reset the product.

To reset the product, follow these steps:

1. Press the Power button to turn off the product, and then disconnect the power cable.
2. Wait 30 seconds.
3. Reconnect the power cable, and then press the Power button.

## The product has paused or shut down

- [The product is displaying a “pause” message on the touch screen](#)
- [I received an e-mail indicating that the product has shut down](#)

### The product is displaying a “pause” message on the touch screen

The product has detected that the hard drive is overheating, and will shut itself down after displaying the “pause” message for 12 minutes.

### I received an e-mail indicating that the product has shut down

The product has detected that the hard drive is overheating because of a fan failure. To protect hard drive data, the product has shut itself down.

## Paper feeding problems

- [Paper jamming, skewing, misfeeds, or multiple-page feeds](#)
- [Scanning fragile originals](#)
- [Paper does not feed from the product](#)
- [Originals are curling up in the document output tray](#)
- [The bottom of the scanned image is cut off](#)
- [The scanned images have streaks or scratches](#)
- [An item loaded in the document input tray jams repeatedly](#)
- [Clear jams from the paper path](#)

### Paper jamming, skewing, misfeeds, or multiple-page feeds

- Check that all rollers are in place and that the roller doors and automatic document feeder (ADF) hatch are closed.
- If the pages look skewed as they feed into the paper path, check the resulting scanned images in the software to ensure that they are not skewed.
- The pages might not be placed correctly. Straighten the pages and adjust the paper guides to center the stack.
- The paper guides must be touching the sides of the paper stack to work properly. Please ensure that the paper stack is straight and the guides are against the paper stack.
- The document feeder or output tray might contain more than the maximum number of pages. Load fewer pages in the document feeder, and remove pages from the output tray.
- Verify that there are no pieces of paper, staples, paper clips, or other debris in the paper path.
- Clean the paper path to help reduce misfeeds. If misfeeds still occur, clean the rollers. If misfeeds still occur, replace the rollers.

### Scanning fragile originals

To safely scan fragile originals (photographs or documents on wrinkled or very lightweight paper) place originals on the scanning glass. Do not use the automatic document feeder (ADF).

### Paper does not feed from the product

Reload the pages into the document feeder, ensuring that they make contact with the rollers.

The automatic document feeder (ADF) hatch might not be securely latched. Open the ADF hatch and then close it by pressing firmly.

A problem with the product hardware might exist. Follow this procedure to test the product:

1. Ensure that the power supply is securely connected between the product and a live electrical outlet or surge protector. Check that the green LED on the power supply case is on to verify that the power supply is functional.
2. If the power supply is connected to a surge protector, ensure that the surge protector is plugged into an outlet and turned on.
3. Press the Power button to turn off the product, and then disconnect the power cable.
4. Wait 30 seconds.
5. Reconnect the power cable to the product, and then press the Power button.
6. Try to rescan.

## Originals are curling up in the document output tray

Under dry conditions, lightweight originals such as those printed on carbonless copy paper may curl in the output tray. To minimize curl, flatten curled edges on the originals before placing them in the document feeder. If you cannot flatten curled edges, make sure the curled edges are facing down when you place the originals in the document feeder.

## The bottom of the scanned image is cut off

By default, the scanning software can scan media that is up to 356 mm (14 in) long. For longer pages, the end of the document is not included in the scanned image.

## The scanned images have streaks or scratches

After each step, try another scan to see if the streaks or scratches are still apparent. If so, then try the next step. For information on cleaning the product, see the **Care and maintenance** section.

- Check that the originals are clean and unwrinkled.
- Clean the scanning strip, which is to the left of the scanning glass.
- Clean the rollers manually.

## An item loaded in the document input tray jams repeatedly

- The item might not meet the guidelines for acceptable originals.
- The item might have something on it, such as staples or self-adhesive notes on the original that must be removed.
- Make sure the paper guides touch the edges of the original.

## Clear jams from the paper path

To clear a paper jam:

1. Open the automatic document feeder (ADF) hatch.



2. Remove the originals or any obstructions from the paper path.

 **TIP:** Use the green thumb wheel on the left side of the open hatch to manually advance originals through the paper path.

3. Remove the ADF duplex background, remove any debris, and then slide the component back into its housing until it clicks into place.

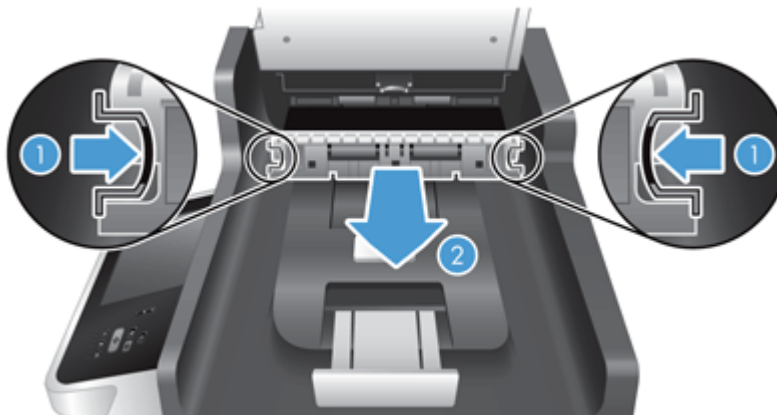

4. Close the ADF hatch until it snaps into place.
5. Reload the unscanned originals in the document feeder.
6. Resume scanning.

If you experience repeated jams, ensure that the hatch door is fully closed.

## The product has stopped working correctly

If the product stops scanning, follow these steps. After each step, start a scan to see if the product is working. If the problem persists, proceed with the next step.

1. A cable might be loose. Ensure that the Ethernet, power supply, and power cables are properly connected.
2. Ensure that the product is receiving power.
  - a. Check that the green LED on the power supply case is on.
  - b. If the green LED is not on, ensure that power is available to the power outlet or surge protector that the power supply cable is plugged into, and that the power cable is securely connected to the power supply and the product.
  - c. If power is available to the power outlet or surge protector but the green LED is still not on, the power supply might be defective. See [www.hp.com/support](http://www.hp.com/support) for assistance.
3. Press the Power button to turn off the product, wait 30 seconds, and then touch the Power button again to turn on the product.

## Solve e-mail problems

If you are unable to send e-mails by using the digital-send feature, you might need to reconfigure the SMTP gateway address or the LDAP gateway address. View a configuration page to find the current SMTP and LDAP gateway addresses. Use the following procedures to check if the SMTP and LDAP gateway addresses are valid.

### Validate the SMTP gateway address



---

**NOTE:** This procedure is for Windows operating systems.

---

1. Open an MS-DOS command prompt: click **Start**, click **Run**, and then type `cmd`.
2. Type `telnet` followed by the SMTP gateway address and then the number 25, which is the port over which the product is communicating. For example, type `telnet 123.123.123.123 25` where "123.123.123.123" represents the SMTP gateway address.
3. Press **Enter**. If the SMTP gateway address is *not* valid, the response contains the message `Could not open connection to the host on port, 25: Connect failed`.
4. If the SMTP gateway address is not valid, contact the network administrator.

### Validate the LDAP gateway address



---

**NOTE:** This procedure is for Windows operating systems.

---

1. Open Windows Explorer. In the address bar, type `LDAP://` immediately followed by the LDAP gateway address. For example, type `LDAP://12.12.12.12` where "12.12.12.12" represents the LDAP gateway address.
2. Press **Enter**. If the LDAP gateway address is valid, the **Find People** dialog box opens.
3. If the LDAP gateway address is not valid, contact the network administrator.

## Solve network problems

Check the following items to verify that the product is communicating with the network. Before beginning, view the information pages.

If you still cannot connect to the network after checking these items, see [www.hp.com/support](http://www.hp.com/support).

1. Are your power and power supply cables connected properly, and is the product turned on?
2. Are your network cables connected properly?

Make sure that the product is attached to the network using the appropriate port and cable. Check each cable connection to make sure it is secure and in the right place. If the problem continues, try a different cable or ports on the hub or transceiver.

3. Are the link speed and duplex settings set correctly?

HP recommends leaving this setting in automatic mode (the default setting).

4. Can you "ping" the product using its IP address?

Use the command prompt to ping the product from your computer. For example:

```
ping 192.168.45.39
```

Ensure that the ping displays round-trip times.

If you are able to ping the product, verify that the IP address configuration for the product is correct on the computer. If it is correct, delete and then add the product again.

If the ping command failed, verify that the network hubs are on, and then verify that the network settings, the product, and the computer are all configured for the same network.

5. Have any software applications been added to the network?

Make sure they are compatible and that they are installed correctly.

6. Is your protocol enabled?

Use the Embedded Web Server to check the status of protocols.

7. Does the product appear in HP Web Jetadmin or other management application?

- Verify network settings on the Network configuration screen.
- Confirm the network settings for the product using the product control panel.



## Restore factory settings

To restore factory settings, follow these steps:

1. Touch the **Administration** button, touch the **General Settings** button, and then touch the **Restore Factory Settings** button.
2. Touch the buttons associated with the subsystems you wish to reset to factory defaults, and then touch the **Reset** button.

## Contact HP Support

For support contact information, see [www.hp.com/support](http://www.hp.com/support).



---

# 10 Specifications and warranty

This section contains regulatory information and product specifications for your product.

- [Product specifications](#)
- [Document feeder specifications](#)
- [Environmental specifications](#)
- [Certificate of Volatility](#)
- [Regulatory model number](#)
- [Environmental product stewardship program](#)
- [HP limited warranty statement](#)

## Product specifications

Name	Description
Scanner type	Flatbed with automatic document feeder (ADF)
Size	Width: 570 mm (20.35 in), Depth: 434.6 mm (17.1 in), Height: 206.6 mm ( 8.14 in)
Weight	19.1 kg (42.1 lbs)
Scanning element	Charge-coupled device (CCD)
Optical resolution	600 x 600 dpi hardware
Network specifications	<ul style="list-style-type: none"><li>• 10/100/Gigabit Ethernet</li><li>• IPSec (authentication and encryption protocols)</li><li>• IPv4 and IPv6 address assignment</li></ul>
AC power	<ul style="list-style-type: none"><li>• AC input for power supply: 100–240V~, 50/60Hz, 2600mA</li><li>• DC output for power supply: +32 Vdc, 5625mA, 180W</li></ul>
Power consumption	For power consumption information, see <a href="http://www.hp.com/support">www.hp.com/support</a> .
System requirements	To view minimum and recommended system requirements, go to <a href="http://www.hp.com">www.hp.com</a> , select your country/region, search on your product model, and then search on <b>datasheet</b> .

## Document feeder specifications

Name	Description
Paper tray capacity	100 sheets of 75 g/m <sup>2</sup> (20 lb)
Minimum paper size	68 x 148 mm (2.7 x 5.8 in)
Maximum paper size	216 x 864 mm (8.5 x 34 in)
Minimum paper weight	49 g/m <sup>2</sup> (13 lb)
Maximum paper weight	120 g/m <sup>2</sup> (32 lb)

## Environmental specifications

Name	Description
Temperature	Operating the product: 10° to 35° C (50° to 95° F)
	Storage: -40° to 65° C (-40° to 149° F)
Relative humidity	Operating the product: 10% to 80% noncondensing 10° to 35° C (50° to 95° F)
	Storage: up to 90% at 0° to 65° C (32° to 149° F)



**NOTE:** In the presence of high electromagnetic fields, it is possible the output from the HP product may be slightly distorted.

 **NOTE:** HP is committed to providing our customers with information about the chemical substances in our products as needed to comply with legal requirements such as REACH (Regulation EC No 1907/2006 of the European Parliament and the Council). A chemical information report for this product can be found at [www.hp.com/go/reach](http://www.hp.com/go/reach).

---

## Certificate of Volatility

This statement explains the volatility of customer data stored in memory and outlines how to erase secure data from the device.

### Volatile memory

The product utilizes volatile memory (1792 MB) to store customer data during the scan process. When you turn off the product, this volatile memory is erased.

### Non-volatile memory

The product utilizes non-volatile flash memory (2 MB) to store system control data and user preference settings. Non-volatile memory does not store any customer scan data. To clear non-volatile memory and restore it to factory defaults, use the Embedded Web Server.

 **TIP:** You can also clear non-volatile memory from the Home screen on the control panel (touch [Administration](#), touch [General Settings](#), and then touch [Restore Factory Settings](#)).

---

### Hard disk drive memory

The product contains one encrypted hard disk drive (160 GB or larger) that may retain data after you turn off the product, including customer jobs and temporary data such as stored scan data or fax files. To securely erase the data, start the Embedded Web Server, click the **Security** tab, click the **Protect Stored Data** entry in the left pane, click the **Erase Options** button, and then select the **Secure Sanitize Erase** option.

 **NOTE:** If you erase the drive using **Secure Sanitize Erase**, you will not be able to use the drive in any device (for example, another scanner or a computer) until you reformat the drive.

---

The **Secure Sanitize Erase** feature meets standards for clearing disk media defined in NIST Special Publication 800-88 Guidelines for Media Sanitation and the U.S. Department of Defense Updated DSS Clearing and Sanitization Matrix.

## Regulatory model number

For regulatory identification purposes your product has been assigned a Regulatory Model Number. The Regulatory Model Number for your product is FCLSD-0901. This regulatory model number should not be confused with the marketing name (HP Scanjet Enterprise 8500 fn1) or product number (L2717A). Additional regulatory information about your product can be found on the regulatory\_supplement.pdf file in the product documentation.

# Environmental product stewardship program

- [Protecting the environment](#)
- [Ozone production](#)
- [Power consumption](#)
- [Toner consumption](#)
- [Paper use](#)
- [Plastics](#)
- [HP LaserJet print supplies](#)
- [Paper](#)
- [Material restrictions](#)
- [Disposal of waste equipment by users \(EU and India\)](#)
- [Electronic hardware recycling](#)
- [Brazil hardware recycling information](#)
- [Chemical substances](#)
- [Product Power Data per European Union Commission Regulation 1275/2008](#)
- [SEPA Ecolabel User Information \(China\)](#)
- [The regulation of the implementation on China energy label for printer, fax, and copier](#)
- [Restriction on Hazardous Substances statement \(India\)](#)
- [Restriction on Hazardous Substances statement \(Turkey\)](#)
- [Restriction on Hazardous Substances statement \(Ukraine\)](#)
- [Substances Table \(China\)](#)
- [Material Safety Data Sheet \(MSDS\)](#)
- [EPEAT](#)
- [For more information](#)

## Protecting the environment

HP is committed to providing quality products in an environmentally sound manner. This product has been designed with several attributes to minimize impacts on our environment.

## Ozone production

The airborne emissions of ozone for this product has been measured according to a generally recognized method\* and when these emissions data are applied to a “generic office model exposure scenario”\*\*, HP is able to determine there is no appreciable amount of ozone generated during printing that exceeds any current indoor air quality standards or guidelines.

\* Test method for the determination of emissions from hardcopy devices with respect to awarding the environmental label for office devices with printing function; RAL-UZ 171 – BAM July, 2012

\*\* Based on ozone concentration when printing 2 hours per day in a 32 cubic meter room with a ventilation rate of 0.72 air changes per hour with HP printing supplies

## Power consumption

Power usage drops significantly while in Ready, Sleep, or Off mode, which saves natural resources and saves money without affecting the high performance of this product. HP printing and imaging equipment marked with the ENERGY STAR® logo is qualified to the U.S. Environmental Protection Agency's ENERGY STAR specifications for imaging equipment. The following mark will appear on ENERGY STAR qualified imaging products:



Additional ENERGY STAR qualified imaging product model information is listed at:

[www.hp.com/go/energystar](http://www.hp.com/go/energystar)

## Toner consumption

EconoMode uses less toner, which might extend the life of the print cartridge. HP does not recommend the full-time use of EconoMode. If EconoMode is used full-time, the toner supply might outlast the mechanical parts in the print cartridge. If print quality begins to degrade and is no longer acceptable, consider replacing the print cartridge.

## Paper use

This product's duplex feature (manual or automatic) and N-up printing (multiple pages printed on one page) capability can reduce paper usage and the resulting demands on natural resources.

## Plastics

Plastic parts over 25 grams are marked according to international standards that enhance the ability to identify plastics for recycling purposes at the end of the product's life.

## HP LaserJet print supplies

Original HP Supplies were designed with the environment in mind. HP makes it easy to conserve resources and paper when printing. And when you are done, we make it easy and free to recycle.<sup>1</sup>

All HP cartridges returned to HP Planet Partners go through a multiphase recycling process where materials are separated and refined for use as raw material in new Original HP cartridges and everyday products. No Original HP cartridges returned through HP Planet Partners are ever sent to a landfill, and HP never refills or resells Original HP cartridges.

**To participate in HP Planet Partners return and recycling program, visit [www.hp.com/recycle](http://www.hp.com/recycle). Select your country/region for information on how to return HP printing supplies. Multi-lingual program information and instructions are also included in every new HP LaserJet print cartridge package.**

<sup>1</sup> Program availability varies. For more information, visit [www.hp.com/recycle](http://www.hp.com/recycle).



## Paper

This product is capable of using recycled paper and lightweight paper (EcoFFICIENT™) when the paper meets the guidelines outlined in the *HP LaserJet Printer Family Print Media Guide*. This product is suitable for the use of recycled paper and lightweight paper (EcoFFICIENT™) according to EN12281:2002.

## Material restrictions

This HP product does not contain added mercury.

If this HP product contains a battery, it may require special handling at end-of-life.

HP ScanJet Enterprise 8500 fn1	
Type	Lithium carbon monofluoride
Weight	2.4 g
Location	On formatter
User-removable	No



## 廢電池請回收

For recycling information, you can go to [www.hp.com/recycle](http://www.hp.com/recycle), or contact your local authorities or the Electronics Industries Alliance: [www.eiae.org](http://www.eiae.org).

## Disposal of waste equipment by users (EU and India)



This symbol means do not dispose of your product with your other household waste. Instead, you should protect human health and the environment by handing over your waste equipment to a designated collection point for the recycling of waste electrical and electronic equipment. For more information, please contact your household waste disposal service, or go to: [www.hp.com/recycle](http://www.hp.com/recycle).

## Electronic hardware recycling

HP encourages customers to recycle used electronic hardware. For more information about recycling programs go to: [www.hp.com/recycle](http://www.hp.com/recycle).

## Brazil hardware recycling information



Não descarte o produto eletrônico em lixo comum

Este produto eletrônico e seus componentes não devem ser descartados no lixo comum, pois embora estejam em conformidade com padrões mundiais de restrição a substâncias nocivas, podem conter, ainda que em quantidades mínimas, substâncias impactantes ao meio ambiente. Ao final da vida útil deste produto, o usuário deverá entregá-lo à HP. A não observância dessa orientação sujeitará o infrator às sanções previstas em lei.

Após o uso, as pilhas e/ou baterias dos produtos HP deverão ser entregues ao estabelecimento comercial ou rede de assistência técnica autorizada pela HP.

Para maiores informações, inclusive sobre os pontos de recebimento, acesse:

[www.hp.com.br/reciclar](http://www.hp.com.br/reciclar)

## Chemical substances

HP is committed to providing our customers with information about the chemical substances in our products as needed to comply with legal requirements such as REACH (Regulation EC No 1907/2006 of the European Parliament and the Council). A chemical information report for this product can be found at: [www.hp.com/go/reach](http://www.hp.com/go/reach).

## Product Power Data per European Union Commission Regulation 1275/2008

For product power data, including the power consumption of the product in networked standby if all wired network ports are connected and all wireless network ports are activated, please refer to section P14 'Additional Information' of the product IT ECO Declaration at [www.hp.com/hpinfo/globalcitizenship/environment/productdata/itecodesktop-pc.html](http://www.hp.com/hpinfo/globalcitizenship/environment/productdata/itecodesktop-pc.html).

## SEPA Ecolabel User Information (China)

中国环境标志产品认证

噪声63.0 dB(A)的产品不宜置于室内,请在室外使用

如需使用本产品打印文件,请保持良好通风

如需确认本产品能耗状态,按下源按钮,并插入电源

您可使用废纸以减少浪费

## The regulation of the implementation on China energy label for printer, fax, and copier

根据复印机、打印机和传真机能效标识实施规则,本机具能效等级根据复印机、打印机和传真机能效限定值及能效等级(“GB21521”)方法计算得出,能效等级和TEC(典型值)

1. 能效等级

能效分为三等能效,能效最高,根据产品类型和速度,能效等级

2. 能效

2.1 LaserJet 打印机的能效

- 能耗

能耗是依据GB21521测试方法测得的用电量，此数据每瓦(kWh)。

所有能效等级按照CEL-37选择，所有能效等级均符合，因此本产品的能效等级与能效等级相同。

有关详细信息，请参考GB21521标准。

## Restriction on Hazardous Substances statement (India)

This product complies with the "India E-waste Rule 2011" and prohibits use of lead, mercury, hexavalent chromium, polybrominated biphenyls or polybrominated diphenyl ethers in concentrations exceeding 0.1 weight % and 0.01 weight % for cadmium, except for the exemptions set in Schedule 2 of the Rule.

## Restriction on Hazardous Substances statement (Turkey)

Türkiye Cumhuriyeti: EEE Yönetmeliğine Uygun

## Restriction on Hazardous Substances statement (Ukraine)

Обладнання відповідає вимогам Технічного регламенту щодо обмеження використання деяких небезпечних речовин в електричному та електронному обладнанні, затвердженого постановою Кабінету Міністрів України від 3 грудня 2008 № 1057

## Substances Table (China)

产品中有害物质或元素的名称及含量  
根据中国《电子信息产品污染控制管理办法》



部件名称	有害物质					
	铅 (Pb)	汞 (Hg)	镉 (Cd)	六价铬 (Cr(VI))	多溴联苯 (PBB)	多溴二苯醚 (PBDE)
打印引擎	X	0	0	0	0	0
复印机组件	X	0	0	0	0	0
控制面板	X	0	0	0	0	0
塑料外壳	0	0	0	0	0	0
格式化板组件	X	0	0	0	0	0
碳粉盒	X	0	0	0	0	0

0614-15

本表格依据 SJ/T 11364 的规定编制。

0: 表示该有害物质在该部件所有均质材料中的含量均在 GB/T 26572 规定的限量要求以下。

X: 表示该有害物质至少在该部件的某一均质材料中的含量超出 GB/T 26572 规定的限量要求。

此表中所有名称中含“X”的部件均符合欧盟 RoHS 立法。

注：环保使用期限的参考标识取决于产品正常工作的温度和湿度等条件

## Material Safety Data Sheet (MSDS)

Material Safety Data Sheets (MSDS) for supplies containing chemical substances (for example, toner) can be obtained by accessing the HP Web site at [www.hp.com/go/msds](http://www.hp.com/go/msds).

## EPEAT

Many HP products are designed to meet EPEAT. EPEAT is a comprehensive environmental rating that helps identify greener electronics equipment. For more information on EPEAT go to [www.epeat.net](http://www.epeat.net). For information on HP's EPEAT registered products go to [www.hp.com/hpinfo/globalcitizenship/environment/pdf/epeat\\_printers.pdf](http://www.hp.com/hpinfo/globalcitizenship/environment/pdf/epeat_printers.pdf).

## For more information

To obtain information about these environmental topics:

- Product environmental profile sheet for this and many related HP products
- HP's commitment to the environment
- HP's environmental management system
- HP's end-of-life product return and recycling program
- Material Safety Data Sheets

Visit [www.hp.com/go/environment](http://www.hp.com/go/environment).

Also, visit [www.hp.com/recycle](http://www.hp.com/recycle).

# HP limited warranty statement

HP PRODUCT	DURATION OF LIMITED WARRANTY
HP ScanJet Enterprise 8500 fn1	One-year limited warranty

HP warrants to you, the end-user customer, that HP hardware and accessories will be free from defects in materials and workmanship after the date of purchase, for the period specified above. If HP receives notice of such defects during the warranty period, HP will, at its option, either repair or replace products which prove to be defective. Replacement products may be either new or equivalent in performance to new.

HP warrants to you that HP software will not fail to execute its programming instructions after the date of purchase, for the period specified above, due to defects in material and workmanship when properly installed and used. If HP receives notice of such defects during the warranty period, HP will replace software which does not execute its programming instructions due to such defects.

HP does not warrant that the operation of HP products will be uninterrupted or error free. If HP is unable, within a reasonable time, to repair or replace any product to a condition as warranted, you will be entitled to a refund of the purchase price upon prompt return of the product.

HP products may contain remanufactured parts equivalent to new in performance or may have been subject to incidental use.

Warranty does not apply to defects resulting from (a) improper or inadequate maintenance or calibration, (b) software, interfacing, parts or supplies not supplied by HP, (c) unauthorized modification or misuse, (d) operation outside of the published environmental specifications for the product, or (e) improper site preparation or maintenance.

TO THE EXTENT ALLOWED BY LOCAL LAW, THE ABOVE WARRANTIES ARE EXCLUSIVE AND NO OTHER WARRANTY OR CONDITION, WHETHER WRITTEN OR ORAL, IS EXPRESSED OR IMPLIED AND HP SPECIFICALLY DISCLAIMS ANY IMPLIED WARRANTIES OR CONDITIONS OF MERCHANTABILITY, SATISFACTORY QUALITY, AND FITNESS FOR A PARTICULAR PURPOSE. Some countries/regions, states or provinces do not allow limitations on the duration of an implied warranty, so the above limitation or exclusion might not apply to you. This warranty gives you specific legal rights and you might also have other rights that vary from country/region to country/region, state to state, or province to province.

HP's limited warranty is valid in any country/region or locality where HP has a support presence for this product and where HP has marketed this product. The level of warranty service you receive may vary according to local standards. HP will not alter form, fit or function of the product to make it operate in a country/region for which it was never intended to function for legal or regulatory reasons.

TO THE EXTENT ALLOWED BY LOCAL LAW, THE REMEDIES IN THIS WARRANTY STATEMENT ARE YOUR SOLE AND EXCLUSIVE REMEDIES. EXCEPT AS INDICATED ABOVE, IN NO EVENT WILL HP OR ITS SUPPLIERS BE LIABLE FOR LOSS OF DATA OR FOR DIRECT, SPECIAL, INCIDENTAL, CONSEQUENTIAL (INCLUDING LOST PROFIT OR DATA), OR OTHER DAMAGE, WHETHER BASED IN CONTRACT, TORT, OR OTHERWISE. Some countries/regions, states or provinces do not allow the exclusion or limitation of incidental or consequential damages, so the above limitation or exclusion may not apply to you.

THE WARRANTY TERMS CONTAINED IN THIS STATEMENT, EXCEPT TO THE EXTENT LAWFULLY PERMITTED, DO NOT EXCLUDE, RESTRICT OR MODIFY AND ARE IN ADDITION TO THE MANDATORY STATUTORY RIGHTS APPLICABLE TO THE SALE OF THIS PRODUCT TO YOU.

## UK, Ireland, and Malta

The HP Limited Warranty is a commercial guarantee voluntarily provided by HP. The name and address of the HP entity responsible for the performance of the HP Limited Warranty in your country/region is as follows:

**UK:** HP Inc UK Limited, Cain Road, Amen Corner, Bracknell, Berkshire, RG12 1HN

**Ireland:** Hewlett-Packard Ireland Limited, Liffey Park Technology Campus, Barnhall Road, Leixlip, Co.Kildare

**Malta:** Hewlett-Packard Europe B.V., Amsterdam, Meyrin Branch, Route du Nant-d'Avril 150, 1217 Meyrin, Switzerland

**United Kingdom:** The HP Limited Warranty benefits apply in addition to any legal rights to a guarantee from seller of nonconformity of goods with the contract of sale. These rights expire six years from delivery of goods for products purchased in England or Wales and five years from delivery of goods for products purchased in Scotland. However various factors may impact your eligibility to receive these rights. For further information, please consult the following link: Consumer Legal Guarantee ([www.hp.com/go/eu-legal](http://www.hp.com/go/eu-legal)) or you may visit the European Consumer Centers website ([http://ec.europa.eu/consumers/solving\\_consumer\\_disputes/non-judicial\\_redress/ecc-net/index\\_en.htm](http://ec.europa.eu/consumers/solving_consumer_disputes/non-judicial_redress/ecc-net/index_en.htm)). Consumers have the right to choose whether to claim service under the HP Limited Warranty or against the seller under the legal guarantee.

**Ireland:** The HP Limited Warranty benefits apply in addition to any statutory rights from seller in relation to nonconformity of goods with the contract of sale. However various factors may impact your eligibility to receive these rights. Consumer statutory rights are not limited or affected in any manner by HP Care Pack. For further information, please consult the following link: Consumer Legal Guarantee ([www.hp.com/go/eu-legal](http://www.hp.com/go/eu-legal)) or you may visit the European Consumer Centers website ([http://ec.europa.eu/consumers/solving\\_consumer\\_disputes/non-judicial\\_redress/ecc-net/index\\_en.htm](http://ec.europa.eu/consumers/solving_consumer_disputes/non-judicial_redress/ecc-net/index_en.htm)). Consumers have the right to choose whether to claim service under the HP Limited Warranty or against the seller under the legal guarantee.

**Malta:** The HP Limited Warranty benefits apply in addition to any legal rights to a two-year guarantee from seller of nonconformity of goods with the contract of sale; however various factors may impact your eligibility to receive these rights. Consumer statutory rights are not limited or affected in any manner by the HP Limited Warranty. For further information, please consult the following link: Consumer Legal Guarantee ([www.hp.com/go/eu-legal](http://www.hp.com/go/eu-legal)) or you may visit the European Consumer Centers website ([http://ec.europa.eu/consumers/solving\\_consumer\\_disputes/non-judicial\\_redress/ecc-net/index\\_en.htm](http://ec.europa.eu/consumers/solving_consumer_disputes/non-judicial_redress/ecc-net/index_en.htm)). Consumers have the right to choose whether to claim service under the HP Limited Warranty or against the seller under two-year legal guarantee.

## Austria, Belgium, Germany, and Luxemburg

Die beschränkte HP Herstellergarantie ist eine von HP auf freiwilliger Basis angebotene kommerzielle Garantie. Der Name und die Adresse der HP Gesellschaft, die in Ihrem Land für die Gewährung der beschränkten HP Herstellergarantie verantwortlich ist, sind wie folgt:

**Deutschland:** HP Deutschland GmbH, Schickardstr. 32, D-71034 Böblingen

**Österreich:** HP Austria GmbH., Technologiestrasse 5, A-1120 Wien

**Luxemburg:** Hewlett-Packard Luxembourg S.C.A., 75, Parc d'Activités Capellen, Rue Pafebruc, L-8308 Capellen

**Belgien:** HP Belgium BVBA, Hermeslaan 1A, B-1831 Diegem

Die Rechte aus der beschränkten HP Herstellergarantie gelten zusätzlich zu den gesetzlichen Ansprüchen wegen Sachmängeln auf eine zweijährige Gewährleistung ab dem Lieferdatum. Ob Sie Anspruch auf diese Rechte haben, hängt von zahlreichen Faktoren ab. Die Rechte des Kunden sind in keiner Weise durch die beschränkte HP Herstellergarantie eingeschränkt bzw. betroffen. Weitere Hinweise finden Sie auf der folgenden Website: Gewährleistungsansprüche für Verbraucher ([www.hp.com/go/eu-legal](http://www.hp.com/go/eu-legal)) oder Sie können die Website des Europäischen Verbraucherzentrums ([http://ec.europa.eu/consumers/solving\\_consumer\\_disputes/non-](http://ec.europa.eu/consumers/solving_consumer_disputes/non-)

[judicial\\_redress/ecc-net/index\\_en.htm](http://judicial_redress/ecc-net/index_en.htm)) besuchen. Verbraucher haben das Recht zu wählen, ob sie eine Leistung von HP gemäß der beschränkten HP Herstellergarantie in Anspruch nehmen oder ob sie sich gemäß der gesetzlichen zweijährigen Haftung für Sachmängel (Gewährleistung) sich an den jeweiligen Verkäufer wenden.

## Belgium, France, and Luxemburg

La garantie limitée HP est une garantie commerciale fournie volontairement par HP. Voici les coordonnées de l'entité HP responsable de l'exécution de la garantie limitée HP dans votre pays:

**France:** HP France SAS, société par actions simplifiée identifiée sous le numéro 448 694 133 RCS Evry, 1 Avenue du Canada, 91947, Les Ulis

**G.D. Luxembourg:** Hewlett-Packard Luxembourg S.C.A., 75, Parc d'Activités Capellen, Rue Pafebruc, L-8308 Capellen

**Belgique:** HP Belgium BVBA, Hermeslaan 1A, B-1831 Diegem

**France:** Les avantages de la garantie limitée HP s'appliquent en complément des droits dont vous disposez au titre des garanties légales applicables dont le bénéfice est soumis à des conditions spécifiques. Vos droits en tant que consommateur au titre de la garantie légale de conformité mentionnée aux articles L. 211-4 à L. 211-13 du Code de la Consommation et de celle relatives aux défauts de la chose vendue, dans les conditions prévues aux articles 1641 à 1648 et 2232 du Code de Commerce ne sont en aucune façon limités ou affectés par la garantie limitée HP. Pour de plus amples informations, veuillez consulter le lien suivant : Garanties légales accordées au consommateur ([www.hp.com/go/eu-legal](http://www.hp.com/go/eu-legal)). Vous pouvez également consulter le site Web des Centres européens des consommateurs ([http://ec.europa.eu/consumers/solving\\_consumer\\_disputes/non-judicial\\_redress/ecc-net/index\\_en.htm](http://ec.europa.eu/consumers/solving_consumer_disputes/non-judicial_redress/ecc-net/index_en.htm)). Les consommateurs ont le droit de choisir d'exercer leurs droits au titre de la garantie limitée HP, ou auprès du vendeur au titre des garanties légales applicables mentionnées ci-dessus.

### POUR RAPPEL:

Garantie Légale de Conformité:

*« Le vendeur est tenu de livrer un bien conforme au contrat et répond des défauts de conformité existant lors de la délivrance.*

*Il répond également des défauts de conformité résultant de l'emballage, des instructions de montage ou de l'installation lorsque celle-ci a été mise à sa charge par le contrat ou a été réalisée sous sa responsabilité ».*

Article L211-5 du Code de la Consommation:

*« Pour être conforme au contrat, le bien doit:*

*1° Etre propre à l'usage habituellement attendu d'un bien semblable et, le cas échéant:*

*- correspondre à la description donnée par le vendeur et posséder les qualités que celui-ci a présentées à l'acheteur sous forme d'échantillon ou de modèle;*

*- présenter les qualités qu'un acheteur peut légitimement attendre eu égard aux déclarations publiques faites par le vendeur, par le producteur ou par son représentant, notamment dans la publicité ou l'étiquetage;*

*2° Ou présenter les caractéristiques définies d'un commun accord par les parties ou être propre à tout usage spécial recherché par l'acheteur, porté à la connaissance du vendeur et que ce dernier a accepté ».*

Article L211-12 du Code de la Consommation:

*« L'action résultant du défaut de conformité se prescrit par deux ans à compter de la délivrance du bien ».*

Garantie des vices cachés

Article 1641 du Code Civil : « *Le vendeur est tenu de la garantie à raison des défauts cachés de la chose vendue qui la rendent impropre à l'usage auquel on la destine, ou qui diminuent tellement cet usage que l'acheteur ne l'aurait pas acquise, ou n'en aurait donné qu'un moindre prix, s'il les avait connus.* »

Article 1648 alinéa 1 du Code Civil:

« *L'action résultant des vices rédhibitoires doit être intentée par l'acquéreur dans un délai de deux ans à compter de la découverte du vice.* »

**G.D. Luxembourg et Belgique:** Les avantages de la garantie limitée HP s'appliquent en complément des droits dont vous disposez au titre de la garantie de non-conformité des biens avec le contrat de vente. Cependant, de nombreux facteurs peuvent avoir un impact sur le bénéfice de ces droits. Vos droits en tant que consommateur au titre de ces garanties ne sont en aucune façon limités ou affectés par la garantie limitée HP. Pour de plus amples informations, veuillez consulter le lien suivant : Garanties légales accordées au consommateur ([www.hp.com/go/eu-legal](http://www.hp.com/go/eu-legal)) ou vous pouvez également consulter le site Web des Centres européens des consommateurs ([http://ec.europa.eu/consumers/solving\\_consumer\\_disputes/non-judicial\\_redress/ecc-net/index\\_en.htm](http://ec.europa.eu/consumers/solving_consumer_disputes/non-judicial_redress/ecc-net/index_en.htm)). Les consommateurs ont le droit de choisir de réclamer un service sous la garantie limitée HP ou auprès du vendeur au cours d'une garantie légale de deux ans.

## Italy

La Garanzia limitata HP è una garanzia commerciale fornita volontariamente da HP. Di seguito sono indicati nome e indirizzo della società HP responsabile della fornitura dei servizi coperti dalla Garanzia limitata HP nel vostro Paese:

**Italia:** HP Italy S.r.l., Via G. Di Vittorio 9, 20063 Cernusco S/Naviglio

I vantaggi della Garanzia limitata HP vengono concessi ai consumatori in aggiunta ai diritti derivanti dalla garanzia di due anni fornita dal venditore in caso di non conformità dei beni rispetto al contratto di vendita. Tuttavia, diversi fattori possono avere un impatto sulla possibilità di beneficiare di tali diritti. I diritti spettanti ai consumatori in forza della garanzia legale non sono in alcun modo limitati, né modificati dalla Garanzia limitata HP. Per ulteriori informazioni, si prega di consultare il seguente link: Garanzia legale per i clienti ([www.hp.com/go/eu-legal](http://www.hp.com/go/eu-legal)), oppure visitare il sito Web dei Centri europei per i consumatori ([http://ec.europa.eu/consumers/solving\\_consumer\\_disputes/non-judicial\\_redress/ecc-net/index\\_en.htm](http://ec.europa.eu/consumers/solving_consumer_disputes/non-judicial_redress/ecc-net/index_en.htm)). I consumatori hanno il diritto di scegliere se richiedere un servizio usufruendo della Garanzia limitata HP oppure rivolgendosi al venditore per far valere la garanzia legale di due anni.

## Spain

Su Garantía limitada de HP es una garantía comercial voluntariamente proporcionada por HP. El nombre y dirección de las entidades HP que proporcionan la Garantía limitada de HP (garantía comercial adicional del fabricante) en su país es:

**España:** Hewlett-Packard Española S.L. Calle Vicente Aleixandre, 1 Parque Empresarial Madrid - Las Rozas, E-28232 Madrid

Los beneficios de la Garantía limitada de HP son adicionales a la garantía legal de 2 años a la que los consumidores tienen derecho a recibir del vendedor en virtud del contrato de compraventa; sin embargo, varios factores pueden afectar su derecho a recibir los beneficios bajo dicha garantía legal. A este respecto, la Garantía limitada de HP no limita o afecta en modo alguno los derechos legales del consumidor ([www.hp.com/go/eu-legal](http://www.hp.com/go/eu-legal)). Para más información, consulte el siguiente enlace: Garantía legal del consumidor o puede visitar el sitio web de los Centros europeos de los consumidores ([http://ec.europa.eu/consumers/solving\\_consumer\\_disputes/non-judicial\\_redress/ecc-net/index\\_en.htm](http://ec.europa.eu/consumers/solving_consumer_disputes/non-judicial_redress/ecc-net/index_en.htm)). Los clientes tienen derecho a elegir si reclaman un servicio acogiéndose a la Garantía limitada de HP o al vendedor de conformidad con la garantía legal de dos años.



## Denmark

Den begrænsede HP-garanti er en garanti, der ydes frivilligt af HP. Navn og adresse på det HP-selskab, der er ansvarligt for HP's begrænsede garanti i dit land, er som følger:

**Danmark:** HP Inc Danmark ApS, Engholm Parkvej 8, 3450, Allerød

Den begrænsede HP-garanti gælder i tillæg til eventuelle juridiske rettigheder, for en toårig garanti fra sælgeren af varer, der ikke er i overensstemmelse med salgsaftalen, men forskellige faktorer kan dog påvirke din ret til at opnå disse rettigheder. Forbrugerens lovbestemte rettigheder begrænses eller påvirkes ikke på nogen måde af den begrænsede HP-garanti. Se nedenstående link for at få yderligere oplysninger: Forbrugerens juridiske garanti ([www.hp.com/go/eu-legal](http://www.hp.com/go/eu-legal)) eller du kan besøge De Europæiske Forbrugercentres websted ([http://ec.europa.eu/consumers/solving\\_consumer\\_disputes/non-judicial\\_redress/ecc-net/index\\_en.htm](http://ec.europa.eu/consumers/solving_consumer_disputes/non-judicial_redress/ecc-net/index_en.htm)). Forbrugere har ret til at vælge, om de vil gøre krav på service i henhold til HP's begrænsede garanti eller hos sælger i henhold til en toårig juridisk garanti.

## Norway

HPs garanti er en begrenset og kommersiell garanti som HP selv har valgt å tilby. Følgende lokale selskap innestår for garantien:

**Norge:** HP Norge AS, Rolfbuktveien 4b, 1364 Fornebu

HPs garanti kommer i tillegg til det mangelsansvar HP har i henhold til norsk forbrukerkjøpslovgivning, hvor reklamasjonsperioden kan være to eller fem år, avhengig av hvor lenge salgsgjenstanden var ment å vare. Ulike faktorer kan imidlertid ha betydning for om du kvalifiserer til å kreve avhjelp iht slikt mangelsansvar. Forbrukerens lovmessige rettigheter begrenses ikke av HPs garanti. Hvis du vil ha mer informasjon, kan du klikke på følgende kobling: Juridisk garanti for forbruker ([www.hp.com/go/eu-legal](http://www.hp.com/go/eu-legal)) eller du kan besøke nettstedet til de europeiske forbrukersentrene ([http://ec.europa.eu/consumers/solving\\_consumer\\_disputes/non-judicial\\_redress/ecc-net/index\\_en.htm](http://ec.europa.eu/consumers/solving_consumer_disputes/non-judicial_redress/ecc-net/index_en.htm)). Forbrukere har retten til å velge å kreve service under HPs garanti eller iht selgerens lovpålagte mangelsansvar.

## Sweden

HP:s begränsade garanti är en kommersiell garanti som tillhandahålls frivilligt av HP. Namn och adress till det HP-företag som ansvarar för HP:s begränsade garanti i ditt land är som följer:

**Sverige:** HP PPS Sverige AB, SE-169 73 Stockholm

Fördelarna som ingår i HP:s begränsade garanti gäller utöver de lagstadgade rättigheterna till tre års garanti från säljaren angående varans bristande överensstämmelse gentemot köpeavtalet, men olika faktorer kan påverka din rätt att utnyttja dessa rättigheter. Konsumentens lagstadgade rättigheter varken begränsas eller påverkas på något sätt av HP:s begränsade garanti. Mer information får du om du följer denna länk: Lagstadgad garanti för konsumenter ([www.hp.com/go/eu-legal](http://www.hp.com/go/eu-legal)) eller så kan du gå till European Consumer Centers webbplats ([http://ec.europa.eu/consumers/solving\\_consumer\\_disputes/non-judicial\\_redress/ecc-net/index\\_en.htm](http://ec.europa.eu/consumers/solving_consumer_disputes/non-judicial_redress/ecc-net/index_en.htm)). Konsumenter har rätt att välja om de vill ställa krav enligt HP:s begränsade garanti eller på säljaren enligt den lagstadgade treåriga garantin.

## Portugal

A Garantia Limitada HP é uma garantia comercial fornecida voluntariamente pela HP. O nome e a morada da entidade HP responsável pela prestação da Garantia Limitada HP no seu país são os seguintes:

**Portugal:** HPCP – Computing and Printing Portugal, Unipessoal, Lda., Edifício D. Sancho I, Quinta da Fonte, Porto Salvo, Lisboa, Oeiras, 2740 244

As vantagens da Garantia Limitada HP aplicam-se cumulativamente com quaisquer direitos decorrentes da legislação aplicável à garantia de dois anos do vendedor, relativa a defeitos do produto e constante do contrato de venda. Existem, contudo, vários fatores que poderão afetar a sua elegibilidade para beneficiar de tais direitos. Os direitos legalmente atribuídos aos consumidores não são limitados ou afetados de forma alguma pela Garantia Limitada HP. Para mais informações, consulte a ligação seguinte: Garantia legal do consumidor ([www.hp.com/go/eu-legal](http://www.hp.com/go/eu-legal)) ou visite o Web site da Rede dos Centros Europeus do Consumidor ([http://ec.europa.eu/consumers/solving\\_consumer\\_disputes/non-judicial\\_redress/ecc-net/index\\_en.htm](http://ec.europa.eu/consumers/solving_consumer_disputes/non-judicial_redress/ecc-net/index_en.htm)). Os consumidores têm o direito de escolher se pretendem reclamar assistência ao abrigo da Garantia Limitada HP ou contra o vendedor ao abrigo de uma garantia jurídica de dois anos.

## Greece and Cyprus

Η Περιορισμένη εγγύηση HP είναι μια εμπορική εγγύηση η οποία παρέχεται εθελοντικά από την HP. Η επωνυμία και η διεύθυνση του νομικού προσώπου HP που παρέχει την Περιορισμένη εγγύηση HP στη χώρα σας είναι η εξής:

**Ελλάδα /Κύπρος:** HP Printing and Personal Systems Hellas EPE, Tzavella 1-3, 15232 Chalandri, Attiki

**Ελλάδα /Κύπρος:** HP Συστήματα Εκτύπωσης και Προσωπικών Υπολογιστών Ελλάς Εταιρεία Περιορισμένης Ευθύνης, Tzavella 1-3, 15232 Chalandri, Attiki

Τα προνόμια της Περιορισμένης εγγύησης HP ισχύουν επιπλέον των νόμιμων δικαιωμάτων για διετή εγγύηση έναντι του Πωλητή για τη μη συμμόρφωση των προϊόντων με τις συνομολογημένες συμβατικά ιδιότητες, ωστόσο η άσκηση των δικαιωμάτων σας αυτών μπορεί να εξαρτάται από διάφορους παράγοντες. Τα νόμιμα δικαιώματα των καταναλωτών δεν περιορίζονται ούτε επηρεάζονται καθ' οιονδήποτε τρόπο από την Περιορισμένη εγγύηση HP. Για περισσότερες πληροφορίες, συμβουλευτείτε την ακόλουθη τοποθεσία web: Νόμιμη εγγύηση καταναλωτή ([www.hp.com/go/eu-legal](http://www.hp.com/go/eu-legal)) ή μπορείτε να επισκεφτείτε την τοποθεσία web των Ευρωπαϊκών Κέντρων Καταναλωτή ([http://ec.europa.eu/consumers/solving\\_consumer\\_disputes/non-judicial\\_redress/ecc-net/index\\_en.htm](http://ec.europa.eu/consumers/solving_consumer_disputes/non-judicial_redress/ecc-net/index_en.htm)). Οι καταναλωτές έχουν το δικαίωμα να επιλέξουν αν θα αξιώσουν την υπηρεσία στα πλαίσια της Περιορισμένης εγγύησης HP ή από τον πωλητή στα πλαίσια της νόμιμης εγγύησης δύο ετών.

## Hungary

A HP korlátozott jótállás egy olyan kereskedelmi jótállás, amelyet a HP a saját elhatározásából biztosít. Az egyes országokban a HP mint gyártó által vállalt korlátozott jótállást biztosító HP vállalatok neve és címe:

**Magyarország:** HP Inc Magyarország Kft., H-1117 Budapest, Alíz utca 1.

A HP korlátozott jótállásban biztosított jogok azokon a jogokon felül illetik meg Önt, amelyek a termékeknek az adásvételi szerződés szerinti minőségére vonatkozó kétéves, jogszabályban foglalt eladói szavatosságból, továbbá ha az Ön által vásárolt termékre alkalmazandó, a jogszabályban foglalt kötelező eladói jótállásból erednek, azonban számos körülmény hatással lehet arra, hogy ezek a jogok Önt megilletik-e. További információért kérjük, keresse fel a következő webhelyet: Jogi Tájékoztató Fogyasztóknak ([www.hp.com/go/eu-legal](http://www.hp.com/go/eu-legal)) vagy látogassa meg az Európai Fogyasztói Központok webhelyét ([http://ec.europa.eu/consumers/solving\\_consumer\\_disputes/non-judicial\\_redress/ecc-net/index\\_en.htm](http://ec.europa.eu/consumers/solving_consumer_disputes/non-judicial_redress/ecc-net/index_en.htm)). A fogyasztóknak jogában áll, hogy megválasszák, hogy a jótállással kapcsolatos igényüket a HP korlátozott jótállás alapján vagy a kétéves, jogszabályban foglalt eladói szavatosság, illetve, ha alkalmazandó, a jogszabályban foglalt kötelező eladói jótállás alapján érvényesítik.

## Czech Republic

Omezená záruka HP je obchodní zárukou dobrovolně poskytovanou společností HP. Názyv a adresy společností skupiny HP, které odpovídají za plnění omezené záruky HP ve vaší zemi, jsou následující:

**Česká republika:** HP Inc Czech Republic s. r. o., Za Brumlovkou 5/1559, 140 00 Praha 4

Výhody, poskytované omezenou zárukou HP, se uplatňují jako doplněk k jakýmkoli právním nárokům na dvouletou záruku poskytnutou prodejcem v případě nesouladu zboží s kupní smlouvou. Váš nárok na uznání těchto práv však může záviset na mnohých faktorech. Omezená záruka HP žádným způsobem neomezuje ani neovlivňuje zákonná práva zákazníka. Další informace získáte kliknutím na následující odkaz: Zákonná záruka spotřebitele ([www.hp.com/go/eu-legal](http://www.hp.com/go/eu-legal)) případně můžete navštívit webové stránky Evropského spotřebitelského centra ([http://ec.europa.eu/consumers/solving\\_consumer\\_disputes/non-judicial\\_redress/ecc-net/index\\_en.htm](http://ec.europa.eu/consumers/solving_consumer_disputes/non-judicial_redress/ecc-net/index_en.htm)). Spotřebitelé mají právo se rozhodnout, zda chtějí službu reklamovat v rámci omezené záruky HP nebo v rámci zákonem stanovené dvouleté záruky u prodejce.

## Slovakia

Obmedzená záruka HP je obchodná záruka, ktorú spoločnosť HP poskytuje dobrovoľne. Meno a adresa subjektu HP, ktorý zabezpečuje plnenie vyplývajúce z Obmedzenej záruky HP vo vašej krajine:

**Slovenská republika:** HP Inc Slovakia, s.r.o., Galvaniho 7, 821 04 Bratislava

Výhody Obmedzenej záruky HP sa uplatnia vedľa prípadných zákaznických zákonných nárokov voči predávajúcemu z vás, ktoré spočívajú v nesúlade vlastností tovaru s jeho popisom podľa predmetnej zmluvy. Možnosť uplatnenia takých prípadných nárokov však môže závisieť od rôznych faktorov. Služby Obmedzenej záruky HP žiadnym spôsobom neobmedzujú ani neovplyvňujú zákonné práva zákazníka, ktorý je spotrebiteľom. Ďalšie informácie nájdete na nasledujúcom prepojení: Zákonná záruka spotrebiteľa ([www.hp.com/go/eu-legal](http://www.hp.com/go/eu-legal)), prípadne môžete navštíviť webovú lokalitu európskych zákaznických stredísk ([http://ec.europa.eu/consumers/solving\\_consumer\\_disputes/non-judicial\\_redress/ecc-net/index\\_en.htm](http://ec.europa.eu/consumers/solving_consumer_disputes/non-judicial_redress/ecc-net/index_en.htm)). Spotrebiteľia majú právo zvoliť si, či chcú uplatniť servis v rámci Obmedzenej záruky HP alebo počas zákonnej dvojročnej záručnej lehoty u predajcu.

## Poland

Ograniczona gwarancja HP to komercyjna gwarancja udzielona dobrowolnie przez HP. Nazwa i adres podmiotu HP odpowiedzialnego za realizację Ograniczonej gwarancji HP w Polsce:

**Polska:** HP Inc Polska sp. z o.o., Szturmowa 2a, 02-678 Warszawa, wpisana do rejestru przedsiębiorców prowadzonego przez Sąd Rejonowy dla m.st. Warszawy w Warszawie, XIII Wydział Gospodarczy Krajowego Rejestru Sądowego, pod numerem KRS 0000546115, NIP 5213690563, REGON 360916326, GIOŚ E0020757WZBW, kapitał zakładowy 480.000 PLN.

Świadczenia wynikające z Ograniczonej gwarancji HP stanowią dodatek do praw przysługujących nabywcy w związku z dwuletnią odpowiedzialnością sprzedawcy z tytułu niezgodności towaru z umową (rękojmią). Niemniej, na możliwość korzystania z tych praw mają wpływ różne czynniki. Ograniczona gwarancja HP w żaden sposób nie ogranicza praw konsumenta ani na nie nie wpływa. Więcej informacji można znaleźć pod następującym łączem: Gwarancja prawna konsumenta ([www.hp.com/go/eu-legal](http://www.hp.com/go/eu-legal)), można także odwiedzić stronę internetową Europejskiego Centrum Konsumentckiego ([http://ec.europa.eu/consumers/solving\\_consumer\\_disputes/non-judicial\\_redress/ecc-net/index\\_en.htm](http://ec.europa.eu/consumers/solving_consumer_disputes/non-judicial_redress/ecc-net/index_en.htm)). Konsumenti mają prawo wyboru co do możliwości skorzystania albo z usług gwarancyjnych przysługujących w ramach Ograniczonej gwarancji HP albo z uprawnień wynikających z dwuletniej rękojmi w stosunku do sprzedawcy.

## Bulgaria

Ограничената гаранция на HP представлява търговска гаранция, доброволно предоставяна от HP. Името и адресът на дружеството на HP за вашата страна, отговорно за предоставянето на гаранционната поддръжка в рамките на Ограничената гаранция на HP, са както следва:

HP Inc Bulgaria EOOD (Ейч Пи Инк България EOOD), гр. София 1766, район р-н Младост, бул. Околовръстен Път No 258, Бизнес Център Камбаните

Предимствата на Ограничената гаранция на HP се прилагат в допълнение към всички законови права за двугодишна гаранция от продавача при несъответствие на стоката с договора за продажба. Въпреки това, различни фактори могат да окажат влияние върху условията за получаване на тези права. Законите права на потребителите не са ограничени или засегнати по никакъв начин от Ограничената гаранция на HP. За допълнителна информация, моля вижте Правната гаранция на потребителя ([www.hp.com/go/eu-legal](http://www.hp.com/go/eu-legal)) или посетете уебсайта на Европейския потребителски център ([http://ec.europa.eu/consumers/solving\\_consumer\\_disputes/non-judicial\\_redress/ecc-net/index\\_en.htm](http://ec.europa.eu/consumers/solving_consumer_disputes/non-judicial_redress/ecc-net/index_en.htm)). Потребителите имат правото да избират дали да претендират за извършване на услуга в рамките на Ограничената гаранция на HP или да потърсят такава от търговеца в рамките на двугодишната правна гаранция.

## Romania

Garanția limitată HP este o garanție comercială furnizată în mod voluntar de către HP. Numele și adresa entității HP răspunzătoare de punerea în aplicare a Garanției limitate HP în țara dumneavoastră sunt următoarele:

**România:** HP Inc Romania SRL, 5 Fabrica de Glucoza Str., Building F, Ground Floor and Floor 8, 2nd District, București

Beneficiile Garanției limitate HP se aplică suplimentar față de orice drepturi privind garanția de doi ani oferită de vânzător pentru neconformitatea bunurilor cu contractul de vânzare; cu toate acestea, diversi factori pot avea impact asupra eligibilității dvs. de a beneficia de aceste drepturi. Drepturile legale ale consumatorului nu sunt limitate sau afectate în vreun fel de Garanția limitată HP. Pentru informații suplimentare consultați următorul link: гаранцията acordată потребителите по закон ([www.hp.com/go/eu-legal](http://www.hp.com/go/eu-legal)) или можете да посетите сайта на Европейския център за потребители ([http://ec.europa.eu/consumers/solving\\_consumer\\_disputes/non-judicial\\_redress/ecc-net/index\\_en.htm](http://ec.europa.eu/consumers/solving_consumer_disputes/non-judicial_redress/ecc-net/index_en.htm)). Потребителите имат правото да изберат дали да претендират за извършване на услуга в рамките на Ограничената гаранция на HP или да потърсят такава от търговеца в рамките на двугодишната правна гаранция.

## Belgium and the Netherlands

De Beperkte Garantie van HP is een commerciële garantie vrijwillig verstrekt door HP. De naam en het adres van de HP-entiteit die verantwoordelijk is voor het uitvoeren van de Beperkte Garantie van HP in uw land is als volgt:

**Nederland:** HP Nederland B.V., Startbaan 16, 1187 XR Amstelveen

**België:** HP Belgium BVBA, Hermeslaan 1A, B-1831 Diegem

De voordelen van de Beperkte Garantie van HP vormen een aanvulling op de wettelijke garantie voor consumenten gedurende twee jaren na de levering te verlenen door de verkoper bij een gebrek aan conformiteit van de goederen met de relevante verkoopsovereenkomst. Niettemin kunnen diverse factoren een impact hebben op uw eventuele aanspraak op deze wettelijke rechten. De wettelijke rechten van de consument worden op geen enkele wijze beperkt of beïnvloed door de Beperkte Garantie van HP. Raadpleeg voor meer informatie de volgende webpagina: Wettelijke garantie van de consument ([www.hp.com/go/eu-legal](http://www.hp.com/go/eu-legal)) of u kan de website van het Europees Consumenten Centrum bezoeken ([http://ec.europa.eu/consumers/solving\\_consumer\\_disputes/non-judicial\\_redress/ecc-net/index\\_en.htm](http://ec.europa.eu/consumers/solving_consumer_disputes/non-judicial_redress/ecc-net/index_en.htm)). Consumenten hebben het recht om te kiezen tussen enerzijds de Beperkte Garantie van HP of anderzijds het aanspreken van de verkoper in toepassing van de wettelijke garantie.

## Finland

HP:n rajoitettu takuu on HP:n vapaaehtoisesti antama kaupallinen takuu. HP:n myöntämästä takuusta maassanne vastaavan HP:n edustajan yhteystiedot ovat:

**Suomi:** HP Finland Oy, Piispankalliontie, FIN - 02200 Espoo

HP:n takuun edut ovat voimassa mahdollisten kuluttajansuojalakiin perustuvien oikeuksien lisäksi sen varalta, että tuote ei vastaa myyntisopimusta. Saat lisätietoja seuraavasta linkistä: Kuluttajansuoja ([www.hp.com/go/eu-legal](http://www.hp.com/go/eu-legal)) tai voit käydä Euroopan kuluttajakeskuksen sivustolla ([http://ec.europa.eu/consumers/solving\\_consumer\\_disputes/non-judicial\\_redress/ecc-net/index\\_en.htm](http://ec.europa.eu/consumers/solving_consumer_disputes/non-judicial_redress/ecc-net/index_en.htm)). Kuluttajilla on oikeus vaatia virheen korjausta HP:n takuun ja kuluttajansuojan perusteella HP:lta tai myyjältä.

## Slovenia

Omejena garancija HP je prostovoljna trgovska garancija, ki jo zagotavlja podjetje HP. Ime in naslov poslovne enote HP, ki je odgovorna za omejeno garancijo HP v vaši državi, sta naslednja:

**Slovenija:** Hewlett-Packard Europe B.V., Amsterdam, Meyrin Branch, Route du Nant-d'Avril 150, 1217 Meyrin, Switzerland

Ugodnosti omejene garancije HP veljajo poleg zakonskih pravic, ki ob sklenitvi kupoprodajne pogodbe izhajajo iz dveletne garancije prodajalca v primeru neskladnosti blaga, vendar lahko na izpolnjevanje pogojev za uveljavitev pravic vplivajo različni dejavniki. Omejena garancija HP nikakor ne omejuje strankinih z zakonom predpisanih pravic in ne vpliva nanje. Za dodatne informacije glejte naslednjo povezavo: Strankino pravno jamstvo ([www.hp.com/go/eu-legal](http://www.hp.com/go/eu-legal)); ali pa obiškite spletno mesto evropskih središč za potrošnike ([http://ec.europa.eu/consumers/solving\\_consumer\\_disputes/non-judicial\\_redress/ecc-net/index\\_en.htm](http://ec.europa.eu/consumers/solving_consumer_disputes/non-judicial_redress/ecc-net/index_en.htm)). Potrošniki imajo pravico izbrati, ali bodo uveljavljali pravice do storitev v skladu z omejeno garancijo HP ali proti prodajalcu v skladu z dvoletno zakonsko garancijo.

## Croatia

HP ograničeno jamstvo komercijalno je dobrovoljno jamstvo koje pruža HP. Ime i adresa HP subjekta odgovornog za HP ograničeno jamstvo u vašoj državi:

**Hrvatska:** HP Computing and Printing d.o.o. za računalne i srodne aktivnosti, Radnička cesta 41, 10000 Zagreb

Pogodnosti HP ograničenog jamstva vrijede zajedno uz sva zakonska prava na dvogodišnje jamstvo kod bilo kojeg prodavača s obzirom na nepodudaranje robe s ugovorom o kupnji. Međutim, razni faktori mogu utjecati na vašu mogućnost ostvarivanja tih prava. HP ograničeno jamstvo ni na koji način ne utječe niti ne ograničava zakonska prava potrošača. Dodatne informacije potražite na ovoj adresi: Zakonsko jamstvo za potrošače ([www.hp.com/go/eu-legal](http://www.hp.com/go/eu-legal)) ili možete posjetiti web-mjesto Europskih potrošačkih centara ([http://ec.europa.eu/consumers/solving\\_consumer\\_disputes/non-judicial\\_redress/ecc-net/index\\_en.htm](http://ec.europa.eu/consumers/solving_consumer_disputes/non-judicial_redress/ecc-net/index_en.htm)). Potrošači imaju pravo odabrati žele li ostvariti svoja potraživanja u sklopu HP ograničenog jamstva ili pravnog jamstva prodavača u trajanju ispod dvije godine.

## Latvia

HP ierobežotā garantija ir komercgarantija, kuru brīvprātīgi nodrošina HP. HP uzņēmums, kas sniedz HP ierobežotās garantijas servisa nodrošinājumu jūsu valstī:

**Latvija:** HP Finland Oy, PO Box 515, 02201 Espoo, Finland

HP ierobežotās garantijas priekšrocības tiek piedāvātas papildus jebkurām likumīgajām tiesībām uz pārdevēja un/vai ražotāju nodrošinātu divu gadu garantiju gadījumā, ja preces neatbilst pirkuma līgumam, tomēr šo tiesību saņemšanu var ietekmēt vairāki faktori. HP ierobežotā garantija nekādā veidā neierobežo un neietekmē patērētāju likumīgās tiesības. Lai iegūtu plašāku informāciju, izmantojiet šo saiti: Patērētāju likumīgā garantija ([www.hp.com/go/eu-legal](http://www.hp.com/go/eu-legal)) vai arī Eiropas Patērētāju tiesību aizsardzības centra tīmekļa vietni ([http://ec.europa.eu/consumers/solving\\_consumer\\_disputes/non-judicial\\_redress/ecc-net/index\\_en.htm](http://ec.europa.eu/consumers/solving_consumer_disputes/non-judicial_redress/ecc-net/index_en.htm)). Patērētājiem ir tiesības izvēlēties, vai pieprasīt servisa nodrošinājumu saskaņā ar HP ierobežoto garantiju, vai arī pārdevēja sniegto divu gadu garantiju.

## Lithuania

HP ribotoji garantija yra HP savanoriškai teikiama komercinė garantija. Toliau pateikiami HP bendrovių, teikiančių HP garantiją (gamintojo garantiją) jūsų šalyje, pavadinimai ir adresai:

**Lietuva:** HP Finland Oy, PO Box 515, 02201 Espoo, Finland

HP ribotoji garantija papildomai taikoma kartu su bet kokiais kitomis įstatymais nustatytomis teisėmis į pardavėjo suteikiamą dviejų metų laikotarpio garantiją dėl prekių atitikties pardavimo sutarčiai, tačiau tai, ar jums ši teisė bus suteikiama, gali priklausyti nuo įvairių aplinkybių. HP ribotoji garantija niekaip neapriboja ir neįtakoja įstatymais nustatytų vartotojo teisių. Daugiau informacijos rasite paspaudę šią nuorodą: Teisinė vartotojo garantija ([www.hp.com/go/eu-legal](http://www.hp.com/go/eu-legal)) arba apsilankę Europos vartotojų centro internetinėje svetainėje ([http://ec.europa.eu/consumers/solving\\_consumer\\_disputes/non-judicial\\_redress/ecc-net/index\\_en.htm](http://ec.europa.eu/consumers/solving_consumer_disputes/non-judicial_redress/ecc-net/index_en.htm)). Vartotojai turi teisę prašyti atlikti techninį aptarnavimą pagal HP ribotąją garantiją arba pardavėjo teikiamą dviejų metų įstatymais nustatytą garantiją.

## Estonia

HP piiratud garantii on HP poolt vabatahtlikult pakutav kaubanduslik garantii. HP piiratud garantii eest vastutab HP üksus aadressil:

**Eesti:** HP Finland Oy, PO Box 515, 02201 Espoo, Finland

HP piiratud garantii rakendub lisaks seaduses ettenähtud müüjapoolsele kaheaastasele garantiile, juhul kui toode ei vasta müügilepingu tingimustele. Siiski võib esineda asjaolusid, mille puhul teie jaoks need õigused ei pruugi kehtida. HP piiratud garantii ei piira ega mõjuta mingil moel tarbija seadusjärgseid õigusi. Lisateavet leiate järgmiselt lingilt: tarbija õiguslik garantii ([www.hp.com/go/eu-legal](http://www.hp.com/go/eu-legal)) või võite külastada Euroopa tarbijakeskuste veebisaiti ([http://ec.europa.eu/consumers/solving\\_consumer\\_disputes/non-judicial\\_redress/ecc-net/index\\_en.htm](http://ec.europa.eu/consumers/solving_consumer_disputes/non-judicial_redress/ecc-net/index_en.htm)). Tarbijal on õigus valida, kas ta soovib kasutada HP piiratud garantiid või seadusega ette nähtud müüjapoolset kaheaastast garantiid.

---

# Index

## A

- address books, e-mail
  - adding addresses 61
  - auto-complete function 63
  - importing 40
  - LDAP support 21
  - recipient lists 61
  - recipient lists, creating 61
- ADF
  - capacity 2
  - clean duplex background 72
  - load paper 52
- Administration menu, control panel 22
- administrator password 32
- Attention light
  - locating 10
- authentication and authorization 45
- auto-shutdown 7

## B

- batteries included 121
- bins
  - locating 4
- blank page suppression 2
- browser requirements
  - Embedded Web Server 39
- buttons, control panel
  - locating 10
  - touch screen 14

## C

- capacity
  - ADF 2
- cartridges
  - recycling 120
- Certificate of Volatility
  - hard disk drive memory 117

- non-volatile memory 117
- volatile memory 117
- certificate revocation list 45
- clean
  - ADF 72
  - rollers 76
  - scanning glass 72
  - scanning strip 72
  - touch screen 72
- configure
  - network folders 33
  - Quick Sets 34
  - save to SharePoint 33
  - USB storage device 34
- configure the product
  - using Administration menu 22
  - using the Embedded Web Server 32, 36
- connectivity 2
- connectivity features 2
- control panel
  - Administration menu 22
  - buttons 10
  - clean touch screen 72
  - e-mail screen 62
  - fax screen 64
  - help 15
  - Home screen 13
  - layout 10
  - lights 10
  - locating 4
  - security 42
  - touch screen buttons 14
- covers, locating 4
- CRL 45
- customer support 113
- cut-off images
  - troubleshoot 108

## D

- Data light
    - locating 10
  - default gateway, setting 29
  - device discovery 19
  - digital sending
    - about 61
    - address books 61
    - control-panel settings 62, 64
    - Embedded Web Server settings 39, 40
    - folders 66
    - LDAP support 21
    - recipient lists 61
    - sending documents 63
    - SMTP support 21
    - USB storage device 66
    - validating gateway addresses 111
    - workflow 69
  - disabling
    - network protocols 30
  - disposal, end-of-life 121
  - document feeder
    - load paper 53
    - tips on loading 52
  - documents
    - tips for mixed-size documents 53
- ## E
- e-mail address books
    - deleting addresses 62
  - electronic hardware recycling 121
  - Embedded Web Server 18
    - assigning a password 43
    - features 39
    - General tab 39
    - Information tab 39



- Networking tab 40
- options 39
- Scan/Digital Send tab 40
- Security tab 40
- end-of-life disposal 121
- environmental features 2
- environmental specifications 116
- environmental stewardship program 119
- Error button, control panel touch screen 14
- error messages
  - control panel 12
- Ethernet cards 2
- EWS
  - features 39
  - General tab 39
  - Information tab 39
  - Networking tab 40
  - options 39
  - Scan/Digital Send tab 40
  - Security tab 40
- Explorer, versions supported
  - Embedded Web Server 39
- e-mail
  - about 61
  - address books 61
  - auto-complete function 63
  - control-panel settings 62
  - Embedded Web Server settings 40
  - LDAP support 21
  - problem solving 111
  - recipient lists 61
  - security 42
  - sending documents 63
  - SMTP support 21
  - validating gateway addresses 111

**F**

- factory settings, restore 113
- fax, settings 64
- features 2
- features, new 58
  - automatic tone 58
  - automatically straighten 58
  - cropping options 58
  - erase edges 58
  - job build 58

- scan to SharePoint site 58
- send document to network printer 58
- feed rollers
  - replace 80
- feeding problems 107
- firmware, upgrading 48
- folders
  - sending to 66
- fragile items, scanning 107
- front panel
  - replace 88
- FTP, sending to 69

**G**

- gateway, setting default 29
- gateways
  - validating addresses 111
- General tab, Embedded Web Server 39
- glass, clean 72
- graphical display, control panel 10

**H**

- hard disks 44
- hard drive, replace 93
- hardware integration pocket 98
- hardware recycling, Brazil 122
- Help button, control panel touch screen 14
- help, control panel 15
- Home button, control panel touch screen 14
- Home screen, control panel 13
- HP Digital Sending Software (HP DSS) 18
- HP Jetdirect server
  - settings 23
- HP Web Jetadmin 18, 41
- humidity specifications 116

**I**

- Image Preview 59
  - use 59
- information pages 38
- Information tab, Embedded Web Server 39
- install a Jetdirect card 96
- install components 79
- installation
  - troubleshoot 104

- interface ports
  - included 2
- Internet Explorer, versions supported
  - Embedded Web Server 39
- IP address 29, 30
- IP addressing 19

**J**

- jams
  - troubleshoot 108
- Jetadmin, HP Web 18, 41
- Jetdirect card, install 96
- Jetdirect server
  - settings 23

**K**

- keyboard 91
- keys, control panel
  - locating 10
  - touch screen 14

**L**

- LAN-connector 2
- LDAP servers
  - connect to 21
  - Embedded Web Server settings 40
  - validating gateway addresses 111
- lights
  - control panel 10
- link speed settings 27
- loading documents
  - tips for mixed-size documents 53
- log in 57

**M**

- maintain the product 71
- maintenance
  - clean rollers 76
- manage
  - EWS 39
- manage temporary job files 43
- managing network 32
- material restrictions 121
- Material Safety Data Sheet (MSDS) 124
- media
  - jams 108
  - misfeeds 107



- not feeding 107
- troubleshoot 107
- memory 2
- memory, hard drive 117
- Menu button 10
- menus, control panel
  - Administration 22
- mercury-free product 121
- misfeeds
  - troubleshoot 107
- multiple-page feeds 107

**N**

- Netscape Navigator, versions supported
  - Embedded Web Server 39
- network
  - settings, changing 32
  - settings, viewing 32
- network folders
  - configure 33
  - scan to 66
- Networking tab, Embedded Web Server 40
- networks
  - configuring 17
  - connectivity features 2
  - default gateway 29
  - device discovery 19
  - disabling protocols 30
  - HP Web Jetadmin 41
  - IP address 19, 29, 30
  - link speed settings 27
  - protocols supported 19
  - SMTP servers 21
  - subnet mask 29
  - TCP/IP settings 23
  - validating gateway addresses 111
- new features 58
  - automatic tone 58
  - automatically straighten 58
  - cropping options 58
  - erase edges 58
  - job build 58
  - scan to SharePoint site 58
  - send document to network printer 58

**O**

- on/off switch, locating 4
- online help, control panel 15
- operating environment specifications 116
- order
  - roller replacement kit 80
  - supplies 72
- output bin
  - locating 4

**P**

- paper
  - jams 108
  - misfeeds 107
  - not feeding 107
  - troubleshoot 107
- paper feeding problems 107
- paper-handling 2
- parts
  - order 80, 91
- password 32
- passwords 42
- ports
  - included 2
- power switch, locating 4
- preview scan 59
- problem-solving
  - Error button, control panel touch screen 14
  - e-mail 111
- product
  - auto-shutdown 7
  - reset 105
  - Sleep Mode 6
  - specifications 116
- product info 1
- product maintenance 71
- product, configure
  - using Administration menu 22
  - using the Embedded Web Server 32, 36
- protocols, network 19

**Q**

- Quick Sets 68
  - configure 34

**R**

- Ready light
  - locating 10

- recipient lists 61
- recycling 120
  - electronic hardware 121
- replace
  - front panel 88
  - rollers 80
  - separation pad 84
- replace and install components 79
- replace keyboard 91
- replace the hard drive 93
- Reset button 10
- reset product 105
- resolution 2
- restore factory settings 113
- rollers
  - clean 76
  - replace 80

**S**

- Save to Folder 66
- Save to Network Folder Setup 33
- Save to SharePoint 33
- save to SharePoint
  - configure 33
- Save to USB 66
- scan
  - feeding problems 107
  - fragile items 107
  - paper originals 53
  - preview 59
  - to e-mail 61
  - to fax 65
  - to network folder 66
  - to USB 66
  - using Quick Sets 68
- Scan/Digital Send tab, Embedded Web Server 40
- scanning
  - features 3
- scanning glass
  - load original 55
- scanning strip, clean 72
- scanning to e-mail
  - about 61
  - address books 61
  - control-panel settings 62
  - Embedded Web Server settings 40
  - LDAP support 21
  - recipient lists 61

- sending documents 63
  - SMTP support 21
  - validating addresses 111
- scanning to folder 66
- scanning to workflow 69
- Secure Disk Erase 44
- Secure Storage Erase 44
- security 42, 43
  - authentication and authorization 45
  - certificates 45
  - Embedded Web Server settings 40
  - encrypted hard disk 44
  - EWS 43
  - load certificate revocation list 45
  - load certificates 45
  - manage certificates 45
  - manage temporary job files 43
  - Secure Disk Erase 44
  - Secure Storage Erase 44
  - software access 42
- security features 2
- Security tab, Embedded Web Server 40
- Send to Workflow 69
- sending to e-mail
  - about 61
  - address books 61
  - Embedded Web Server settings 40
  - LDAP support 21
  - recipient lists 61
  - sending documents 63
  - settings 62
  - SMTP support 21
  - validating gateway addresses 111
- sending to fax 65
- separation pad
  - replace 84
- settings, restore 113
- sign in 57
- Sleep button 10
- Sleep Mode 6
- SMTP servers
  - connect to 21
  - validating gateway addresses 111
- software
  - embedded Web server 18
  - HP Digital Sending Software (HP DSS) 18
  - HP Web Jetadmin 18
  - restricting access 42
  - uninstall and reinstall 110
- solving
  - network problems 112
- specifications
  - document feeder 116
  - environmental 116
  - product 116
- standard output bin
  - locating 4
- Start button 10
- Start button, control panel touch screen 14
- status
  - Home screen, control panel 13
- Stop button 10
- storage specifications 116
- streaks
  - troubleshoot 108
- subnet mask 29
- supplies
  - order 72
  - recycling 120
- support 113
- system requirements
  - Embedded Web Server 39
- T**
  - TCP/IP parameters, manual configuration 29, 30
  - TCP/IP settings 23
  - temperature specifications 116
  - toner cartridges
    - recycling 120
  - touch screen, clean 72
  - troubleshoot
    - basic tips 103
    - check power 105
    - cut-off images 108
    - feeding problems 107
    - fragile items 107
    - installation 104
    - jams 108
    - misfeeds 107
    - paper not feeding 107
  - product has shut down 106
  - reset product 105
  - scanning fragile items 107
  - stops working 110
  - streaks 108
  - “pause” message 106
- troubleshooting
  - auto-shutdown 7
  - control panel messages 12
  - gateway addresses 111
  - network problems 112
- U**
  - upgrading firmware 48
  - USB storage device
    - configure 34
  - USB storage device, save to 66
  - user interface 2
- V**
  - validating gateway addresses 111
- W**
  - Warning button, control panel touch screen 14
  - warranty
    - product 125
  - waste disposal 121
  - Web browser requirements
    - Embedded Web Server 39
  - Web sites
    - HP Web Jetadmin, downloading 41
    - Material Safety Data Sheet (MSDS) 124
    - order supplies 72
    - replacement parts 80, 91
  - workflow, send to 69