



HP Pavilion G6 Notebook PC

Maintenance and Service Guide

SUMMARY

This guide is a troubleshooting reference used for maintaining and servicing the computer. It provides comprehensive information on identifying computer features, components, and spare parts; troubleshooting computer problems; and performing computer disassembly procedures.

© Copyright 2011 Hewlett-Packard
Development Company, L.P.

ATI and ATI Mobility Radeon are trademarks of Advanced Micro Devices, Inc. Bluetooth is a trademark owned by its proprietor and used by Hewlett-Packard Company under license. Intel, Arrandale, and Core are trademarks of Intel corporation in the U.S. and other countries. Microsoft and Windows are U.S. registered trademarks of Microsoft Corporation. SD Logo is a trademark of its proprietor.

The information contained herein is subject to change without notice. The only warranties for HP products and services are set forth in the express warranty statements accompanying such products and services. Nothing herein should be construed as constituting an additional warranty. HP shall not be liable for technical or editorial errors or omissions contained herein.

Second Edition: March 2011

Document Part Number: 649111-002

Safety warning notice

 **WARNING!** To reduce the possibility of heat-related injuries or of overheating the computer, do not place the computer directly on your lap or obstruct the computer air vents. Use the computer only on a hard, flat surface. Do not allow another hard surface, such as an adjoining optional printer, or a soft surface, such as pillows or rugs or clothing, to block airflow. Also, do not allow the AC adapter to contact the skin or a soft surface, such as pillows or rugs or clothing, during operation. The computer and the AC adapter comply with the user-accessible surface temperature limits defined by the International Standard for Safety of Information Technology Equipment (IEC 60950).

Table of contents

1 Product description	1
2 External component identification	7
Top	7
TouchPad	7
Lights	8
Button	9
Keys	10
Front	11
Right side	12
Left side	13
Display	15
Bottom	16
3 Illustrated parts catalog	17
Serial number location	17
Computer major components	18
Display assembly components	24
Mass storage devices	26
Miscellaneous parts	27
Sequential part number listing	29
4 Removal and replacement procedures	36
Preliminary replacement requirements	36
Tools required	36
Service considerations	36
Plastic parts	36
Cables and connectors	37
Drive handling	37
Grounding guidelines	38
Electrostatic discharge damage	38

Packaging and transporting guidelines	39
Workstation guidelines	39
Equipment guidelines	40
Component replacement procedures	41
Serial number	41
Computer feet	42
Battery	43
Service access cover	44
Hard drive	45
Optical drive	47
WLAN module	49
Memory module	51
Keyboard	52
Top cover	55
Power button board	58
TouchPad button board	59
TouchPad LED board	60
Speaker assembly	61
USB board	62
Power connector	63
Display assembly	64
System board	71
RTC battery	74
Heat sink assembly	75
Processor	79
5 Specifications	81
Computer specifications	81
39.6-cm (15.6-in) display specifications	82
Hard drive specifications	83
DVD±RW and CD-RW SuperMulti Double-Layer Combo Drive specifications	84
Blu-ray Disc ROM and DVD±R/RW SuperMulti Double-Layer Drive specifications	85
6 Setup Utility (BIOS)	86
Starting Setup Utility	86
Using Setup Utility	86
Changing the language of Setup Utility	86
Navigating and selecting in Setup Utility	87
Displaying system information	87
Restoring factory default settings in Setup Utility	87
Exiting Setup Utility	87

Updating the BIOS	88
Determining the BIOS version	88
Downloading a BIOS update	89
7 Backup and recovery	90
Restore	91
Creating restore media	91
Performing a system restore	92
Restoring using the dedicated recovery partition (select models only)	92
Restoring using the restore media	92
Changing the computer boot order	94
Backing up and recovering your information	94
Using Windows Backup and Restore	95
Using Windows system restore points	96
When to create restore points	96
Create a system restore point	96
Restore to a previous date and time	96
8 Power cord set requirements	97
Requirements for all countries or regions	97
Requirements for specific countries or regions	98
9 Recycling	99
Battery	99
Display	99
Index	105

1 Product description

Category	Description	Intel® 2nd Generation		Intel® Previous Generation		AMD	AMD
		Discrete	UMA	Discrete	UMA	Discrete	UMA
	HP Pavilion G6 Notebook PC	√	√	√	√	√	√
Processors	Intel® Core™ i7-2620M processor (2.7 GHz, SC turbo up to 3.40 GHz, 4 MB L3), Dual 35 W	√	√				
	Intel Core i5-2540M processor (2.6 GHz, SC turbo up to 3.3 GHz, 3 MB L3), Dual 35 W	√	√				
	Intel Core i5-2520M processor (2.5 GHz, SC turbo up to 3.2 GHz, 3 MB L3), Dual 35 W	√	√				
	Intel Core i5-2410M processor (2.3 GHz, SC turbo up to 2.9 GHz, 3 MB L3), Dual 35 W	√	√				
	Intel Core i3 2310M (2.1 GHz, 3 MB L3) Dual 35 W	√	√				
	Intel Core i5-480M processor (2.66 GHz, SC turbo up to 2.93 GHz, 3 MB L3), Dual 35 W			√	√		
	Intel Core i3-390M processor (2.66 GHz, 3 MB L3), Dual 35 W			√	√		
	Intel Core i3-380M processor (2.53 GHz, 3 MB L3), Dual 35 W			√	√		
	Intel Pentium® P6300 (2.26 GHz, 3 MB L3), Dual 35 W			√	√		
	Intel Pentium P6200 (2.13 GHz, 3 MB L3), Dual 35 W			√	√		
	AMD Phenom™ II N970 (2.2 GHz, 2 MB L2, 1333 MHz, 3.6 GT/s – Quad 35 W					√	√
	AMD Phenom II P960 (1.8 GHz, 2 MB L2, 1066 MHz, 3.6 GT/s – Quad 25 W					√	√
	AMD Phenom II N870 (2.3 GHz, 1.5 MB L2, 1333 MHz, 3.6 GT/s – Triple 35 W					√	√

Category	Description	Intel® 2nd Generation		Intel® Previous Generation		AMD	
		Discrete	UMA	Discrete	UMA	Discrete	UMA
	AMD Phenom II P860 (2.0 GHz, 1.5 MB L2, 1066 MHz, 3.6 GT/s – Triple 25 W					√	√
	AMD Phenom II N850 (2.2 GHz, 1.5 MB L2, 1333 MHz, 3.6GT/s – Triple 35 W					√	√
	AMD Phenom II N660 (3.0 GHz, 2 MB L2, 1333 MHz, 3.6 GT/s – Dual 35 W					√	√
	AMD Phenom II P650 (2.6 GHz, 2 MB L2, 1066 MHz, 3.6 GT/s – Dual 25 W					√	√
	AMD Turion™ II P560 (2.5 GHz, 2 MB L2, 1066 MHz, 3.6 GT/s– Dual 25 W					√	√
	AMD Athlon™ II P360 (2.3 GHz, 1 MB L2, 1066 MHz, 3.6 GT/s– Dual 25 W					√	√
	AMD Athlon II P340 (2.2 GHz, 1 MB L2, 1066 MHz, 3.2 GT/s– Dual 25 W					√	√
	AMD V160™ (2.4 GHz, 512 KB L2, 1066 MHz, 3.2 GT/s) - SC 25 W					√	√
	AMD V140™ (2.3 GHz, 512 KB L2, 1066 MHz, 3.2 GT/s) - SC 25 W					√	√
Chipset	Intel HM'65 Express Chipset	√	√				
	Intel HM'55 Express Chipset			√	√		
	AMD RS880M + SB820M					√	√
Graphics	Intel HD Graphics 3000		√				
	Intel HD Graphics			√	√		
	ATI Radeon™ HD 6470M with 512 MB of dedicated video memory (64Mx16 DDR3, 900 MHzx4 PCs)	√		√		√	
	ATI Radeon HD 6470M with 1 GB of dedicated video memory (128Mx16 DDR3, 900 MHzx4 PCs)	√		√		√	
	ATI Mobility Radeon™ HD 4250 Graphics					√	√
	Support for HD-DVD playback with HD decoder and DX11 and HDMI	√	√	√	√		
	Support for DX11					√	√
Panel	39.6-cm (15.6-in) HD LED BrightView (1366x768)	√	√	√	√	√	√
	16:9 wide aspect ratio	√	√	√	√	√	√
Memory	2 customer-accessible/upgradable SODIMM slots:						

Category	Description	Intel® 2nd Generation		Intel® Previous Generation		AMD	AMD
		Discrete	UMA	Discrete	UMA	Discrete	UMA
	<ul style="list-style-type: none"> DDR3-1333 MHz Dual Channel Support 	√	√			√	√
	<ul style="list-style-type: none"> DDR3-1066 MHz Dual Channel Support (DDR3-1333 downgraded to DDR3-1066) 			√	√		
	Supports up to 8 GB of system memory in the following configurations:						
	<ul style="list-style-type: none"> 6144 MB (4096 MB × 1 + 2048×1) 	√	√	√	√	√	√
	<ul style="list-style-type: none"> 4096 MB (4096 MB × 1) 	√	√	√	√	√	√
	<ul style="list-style-type: none"> 4096 MB (2048 MB × 2) 	√	√	√	√	√	√
	<ul style="list-style-type: none"> 3072 MB (1024 MB × 1 + 2048 MB × 1) 	√	√	√	√	√	√
	<ul style="list-style-type: none"> 2048 MB (2048 MB × 1) 	√	√	√	√	√	√
	<ul style="list-style-type: none"> 2048 MB (1024 MB × 2) 	√	√	√	√	√	√
Hard drives	Supports the following 9.5 mm, 6.35-cm (2.5 in) SATA hard drives:						
	<ul style="list-style-type: none"> 750 GB, 5400 rpm 	√	√	√	√	√	√
	<ul style="list-style-type: none"> 640 GB, 5400 rpm 	√	√	√	√	√	√
	<ul style="list-style-type: none"> 500 GB, 7200 rpm 	√	√	√	√	√	√
	<ul style="list-style-type: none"> 500 GB, 5400 rpm 	√	√	√	√	√	√
	<ul style="list-style-type: none"> 320 GB, 5400 rpm 	√	√	√	√	√	√
	Supports the following 7 mm, 6.3-cm (2.5 in) SATA hard drives:						
	<ul style="list-style-type: none"> 320 GB, 7200 rpm 	√	√	√	√	√	√
	<ul style="list-style-type: none"> 250 GB, 7200 rpm 	√	√	√	√	√	√
	<ul style="list-style-type: none"> 250 GB, 5400 rpm 					√	√
Optical drives	12.7 mm (0.50-in) fixed SATA tray load	√	√	√	√	√	√
	DVD±RW and CD-RW SuperMulti Double-Layer Combo Drive with LightScribe	√	√	√	√	√	√
	DVD±RW and CD-RW SuperMulti Double-Layer Combo (by means of SW Control) Drive	√	√	√	√	√	√
	Blu-ray Disc ROM with DVD±R/RW SuperMulti Double-Layer Drive with LightScribe	√	√	√	√	√	√

Category	Description	Intel® 2nd Generation		Intel® Previous Generation		AMD	AMD
		Discrete	UMA	Discrete	UMA	Discrete	UMA
	Blu-ray Disc ROM with DVD±R/RW SuperMulti Double-Layer (by means of SW Control) Drive	√	√	√	√	√	√
Webcam	VGA camera (640x480 by 24 frames per second), fixed angle, with activity light and single digital microphone	√	√	√	√	√	√
Audio	High-definition audio supports: Microsoft® premium requirements with HP Altec Lansing speakers SRS Premium Sound technology	√	√	√	√	√	√
Ethernet	Integrated 10/100 network interface card (NIC)	√	√	√	√	√	√
	Integrated wireless local area network (WLAN) options by way of wireless module and 2 wireless antennas built into display assembly	√	√	√	√	√	√
	Supports the following WLAN formats:						
	Intel Centrino® Wireless-N 1000 (802.11b/g/n)	√	√	√	√		
	Intel Centrino® Wireless-N 1000 (802.11b/g/n) with WiDi	√	√	√	√		
	Atheros AR9285 802.11b/g/n 1x1 WiFi Adapter	√	√	√	√	√	√
	Ralink 5390GN 802.11b/g/n 1x1 WiFi Adapter	√	√	√	√		
	Broadcom 4313 802.11b/g/n 1x1 WiFi and 2070 Bluetooth 2.1+EDR Combo adapter (BT3.0+HS ready)	√	√	√	√	√	√
	Broadcom 4313GN 802.11b/g/n 1x1 WiFi Adapter					√	√
	Ralink 5390BC8 802.11b/g/n 1x1 WiFi and Bluetooth 3.0+HS Combo Adapter	√	√	√	√		
External media card	Digital Media Slot supporting SD, SDHC, SDXC (UHS104 compliant), and MMC	√	√	√	√	√	√
Internal card	One half-size Mini Card slot for WLAN	√	√	√	√	√	√
Ports	Audio-in (digital microphone)	√	√	√	√	√	√
	Audio-out (stereo headphone)	√	√	√	√	√	√
	High-Definition Multimedia Interface (HDMI) version 1.4 supporting up to 1920x1200 @ 60Hz	√	√	√	√	√	√

Category	Description	Intel® 2nd Generation		Intel® Previous Generation		AMD	AMD
		Discrete	UMA	Discrete	UMA	Discrete	UMA
	Hot plug/unplug with auto-detect for correct output to wide-aspect vs. standard aspect video	√	√	√	√	√	√
	RJ-45 (Ethernet)	√	√	√	√	√	√
	Three USB 2.0 ports	√	√	√	√	√	√
	VGA (Dsub 15-pin) supporting the following: <ul style="list-style-type: none"> • 2048×1056 external resolution @ 75Hz • 1920×1200 external resolution @ 60Hz • HDMI v1.4 supporting: up to 1080p, 1920x1200 @ 60Hz and 1920x1200 @ 60Hz DVI Mode 	√	√	√	√	√	√
	AC Smart Pin adapter	√	√	√	√	√	√
Keyboard/ pointing devices	39.62-cm (15.6-in), full-size keyboard	√	√	√	√	√	√
	TouchPad with 2 buttons (multitouch gestures, 2-finger scrolling, pinch zoom, and taps enabled as default)	√	√	√	√	√	√
Power requirements	6-cell, 2.22 Ah, 47 Wh battery	√	√	√	√	√	√
	6-cell, 2.55 Ah, 55 Wh battery	√	√	√	√		
	Batteries support fast charge	√	√	√	√	√	√
	65-W AC Smart adapter with localized cable plug support		√		√		√
	90-W AC Smart adapter with localized cable plug support	√		√			
Security	Kensington Security Lock	√	√	√	√	√	√
	Intel AT-p Ready						
Operating system	Preinstalled:						
	Windows 7® Home Premium (64 bit)	√	√	√	√	√	√
	Windows 7 Home Basic (64 bit)	√	√	√	√	√	√
	Windows 7 Starter (32-bit)	√	√	√	√	√	√
	FreeDOS	√	√	√	√	√	√
Serviceability	End-user replaceable parts:						
	AC adapter	√	√	√	√	√	√





Category	Description	Intel® 2nd Generation		Intel® Previous Generation		AMD	AMD
		Discrete	UMA	Discrete	UMA	Discrete	UMA
	Battery (system)	√	√	√	√	√	√
	Hard drive	√	√	√	√	√	√
	Memory module	√	√	√	√	√	√
	Optical drive	√	√	√	√	√	√
	WLAN cards	√	√	√	√	√	√

2 External component identification

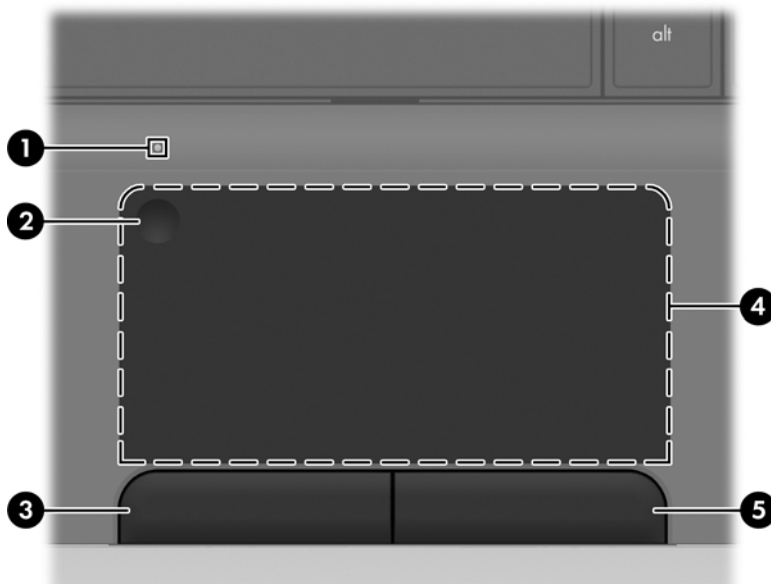
Top



TouchPad

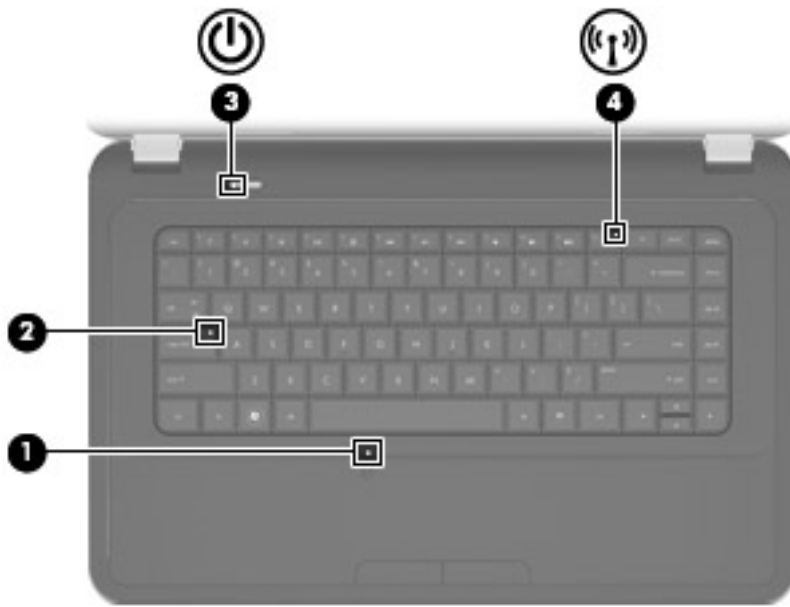

Component	Description
(1)  TouchPad light	<ul style="list-style-type: none">• Off: The TouchPad is on.• Amber: The TouchPad is off.
(2)  TouchPad on/off button	Turns the TouchPad on and off. Quickly double-tap the TouchPad button to turn the TouchPad on and off.
(3)  Left TouchPad button	Functions like the left button on an external mouse
(4)  TouchPad zone	Moves the pointer and selects or activates items on the screen
(5)  Right TouchPad button	Functions like the right button on an external mouse

Lights



Component	Description
(1) TouchPad light	<ul style="list-style-type: none">• Off: The TouchPad is on.• Amber: The TouchPad is off.
(2) Caps lock light	<ul style="list-style-type: none">• White: Caps lock is on.• Off: Caps lock is off.
(3)  Power light	<ul style="list-style-type: none">• On: The computer is on.• Blinking: The computer is in Sleep mode.• Off: The computer is off or in Hibernation mode.
(4)  Wireless light	<ul style="list-style-type: none">• White: An integrated wireless device, such as a wireless local area network (WLAN) device and/or a Bluetooth® device, is on.• Amber: All wireless devices are off.



Button

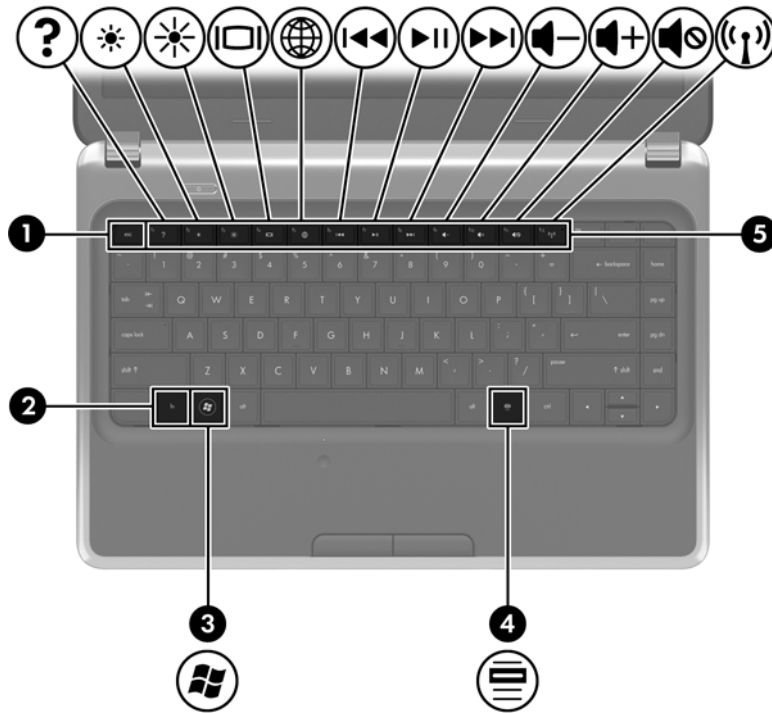

Component	Description
 Power button	<ul style="list-style-type: none">• When the computer is off, press the power button to turn on the computer.• When the computer is on, press the power button briefly to initiate Sleep mode.• When the computer is in Sleep mode, press the power button briefly to exit Sleep mode.• When the computer is in Hibernation mode, press the power button briefly to exit Hibernation mode. <p>If the computer has stopped responding and Windows® shutdown procedures are ineffective, press and hold the power button for at least 5 seconds to turn off the computer.</p> <p>To learn more about your power settings, select Start > Control Panel > System and Security > Power Options, or refer to the <i>HP Notebook Reference Guide</i>.</p>

Keys



Component	Description
(1) <code>esc</code> key	Displays system information when pressed in combination with the <code>fn</code> key
(2) <code>fn</code> key	Displays system information when pressed in combination with the <code>esc</code> key
(3)  Windows logo key	Displays the Windows Start menu
(4)  Windows applications key	Displays a shortcut menu for items beneath the pointer
(5) Action keys	Execute frequently used system functions



Front



Component	Description
Speakers (2)	Produce sound

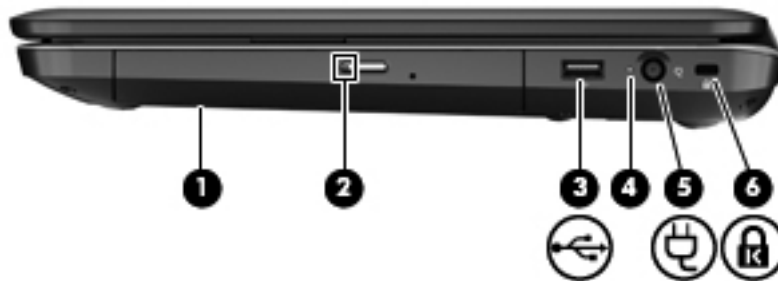





Right side

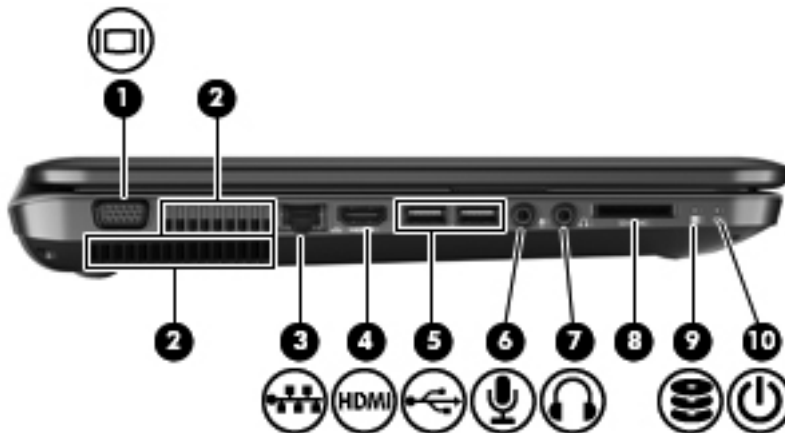



Component	Description
(1) Optical drive	Plays optical discs, such as CDs, DVDs, and Blu-ray discs
(2) Optical drive light	Green: The optical drive is being accessed.
(3)  USB port	Connects an optional USB device
(4) AC adapter light	<ul style="list-style-type: none">Blinking white: The battery is low.Solid white: The computer is connected to external power.Amber: The computer is charging the battery.Off: The computer is not connected to external power.
(5)  Power connector	Connects an AC adapter
(6)  Security cable slot	Attaches an optional security cable to the computer NOTE: The security cable is designed to act as a deterrent, but it may not prevent the computer from being mishandled or stolen.

Left side



Component	Description
(1) 	External monitor port Connects an external VGA monitor or projector
(2)	Vents (2) Enable airflow to cool internal components NOTE: The computer fan starts up automatically to cool internal components and prevent overheating. It is normal for the internal fan to cycle on and off during routine operation.
(3) 	RJ-45 (network) jack Connects a network cable
(4) 	HDMI port Connects an optional video or audio device, such as a high-definition television, or any compatible digital or audio component
(5) 	USB ports (2) Connect optional USB devices
(6) 	Audio-in (microphone) jack Connects an optional computer headset microphone, stereo array microphone, or monaural microphone
(7) 	Audio-out (headphone) jack Produces sound when connected to optional powered stereo speakers, headphones, earbuds, a headset, or television audio WARNING! To reduce the risk of personal injury, adjust the volume before putting on headphones, earbuds, or a headset. For additional safety information, refer to the <i>Regulatory, Safety and Environmental Notices</i> . NOTE: When a device is connected to the jack, the computer speakers are disabled.

Component		Description
(8)	Digital Media Slot	<p>Supports the following optional digital card formats:</p> <ul style="list-style-type: none"> • MultiMedia Card (MMC) • Secure Digital (SD) Memory Card • Secure Digital High Capacity (SDHC) Memory Card • Secure Digital Extended Capacity (SDXC) Memory Card
(9)	 Hard drive light	<ul style="list-style-type: none"> • White: The hard drive is being accessed.
(10)	 Power light	<ul style="list-style-type: none"> • White: The computer is on. • Blinking white: The computer is in Sleep mode.

Display





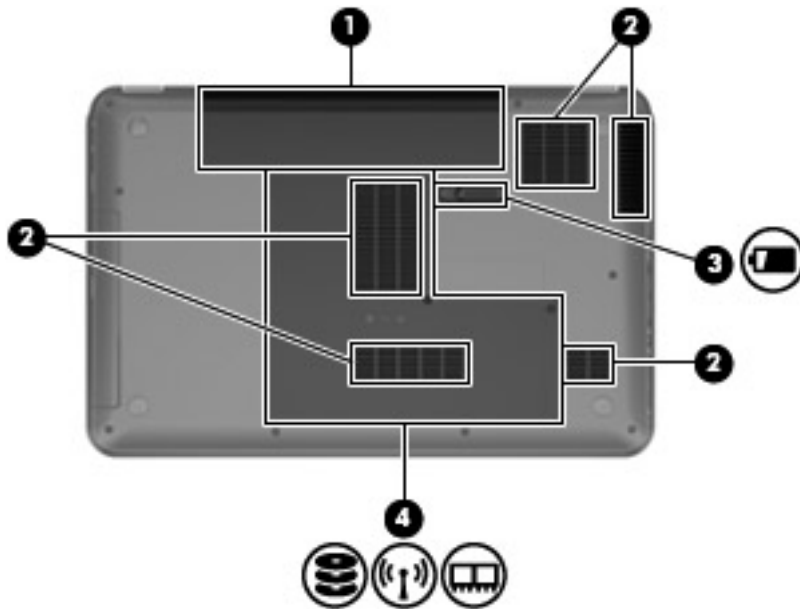

Component	Description
(1) WLAN antennas (2)*	Send and receive wireless signals to communicate with wireless local area networks (WLANs)
(2) Webcam light	On: The webcam is in use.
(3) Webcam	Records video and captures still photographs To use the webcam, select Start > All Programs > Cyberlink YouCam .
(4) Internal microphone	Records sound

*The antennas are not visible from the outside of the computer. For optimal transmission, keep the areas immediately around the antennas free from obstructions. To see wireless regulatory notices, refer to the section of the *Regulatory, Safety and Environmental Notices* that applies to your country or region. These notices are located in Help and Support.

Bottom



Component	Description
(1) Battery bay	Holds the battery
(2) Vents (5)	Enable airflow to cool internal components
(3)  Battery release latch	Releases the battery from the battery bay
(4)  Service cover	Provides access to the hard drive, wireless modules, and memory modules
	
	

3 Illustrated parts catalog

Serial number location

When ordering parts or requesting information, provide the computer serial number and model number located in the battery bay of the computer.

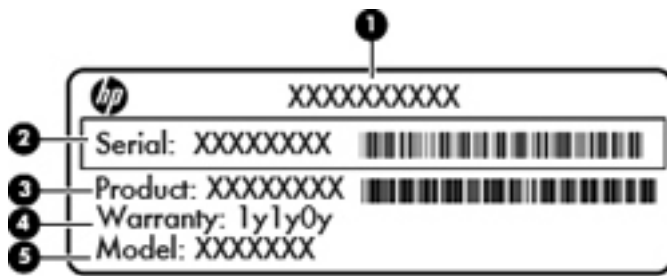

Component	Description
(1) Product name	The name affixed to the front of the computer.
(2) Serial number (s/n)	An alphanumeric identifier that is unique to each product.
(3) Part number/Product number (p/n)	This number provides specific information about the product's hardware components. The part number helps a service technician to determine what components and parts are needed.
(4) Warranty period	The duration of the warranty period for the computer.
(5) Model description	An alphanumeric identifier used to locate documents, drivers, and support for the computer.

Computer major components

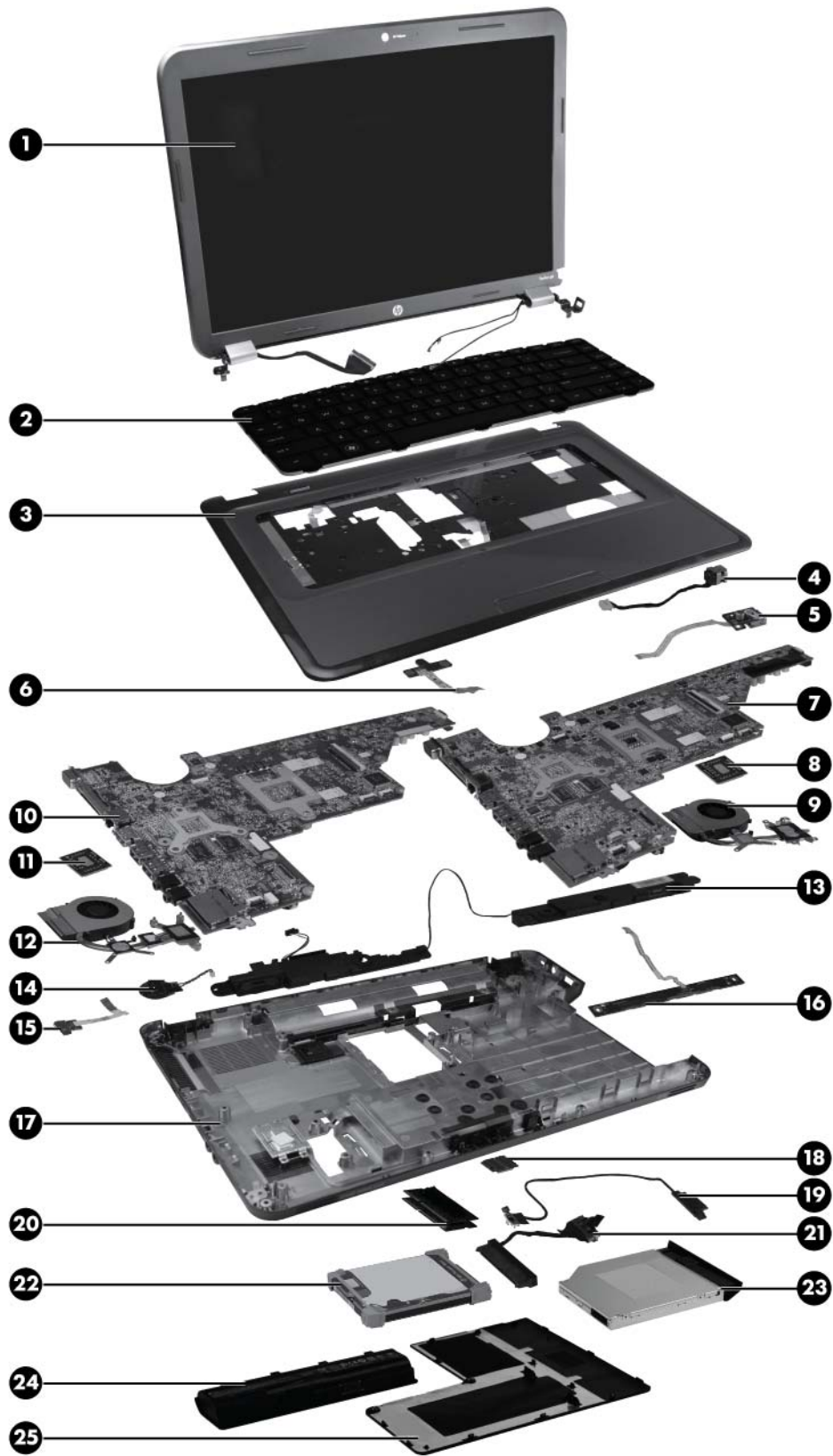

Item	Description	Spare part number
(1)	39.6-cm (15.6-in) High Definition (HD), light-emitting diode (LED), BrightView (1366×768) display assembly:	
	NOTE: For more information on the display assembly internal component spare part information, See Display assembly components on page 24 .	
	• For use in Charcoal Grey computer models	645523-001
	• For use in Ocean Drive computer models	636378-001
	• For use in Sonoma Red computer models	645521-001
	• For use in Luminous Rose computer models	645522-001
	• For use in Pewter computer models	645524-001
	• For use in Pacific Blue computer models	645525-001
	• For use in Pearl Pink computer models	645526-001
	• For use in Sweet Purple computer models	645527-001
	• For use in Butter Gold computer models	645528-001
(2)	Keyboard (includes keyboard cable):	
	• For use in the United States, Black	636376-001
	• For use in French Canada, Black	636376-121
	• For use in the United Kingdom, Black	636376-031
	• For use in Germany, Black	636376-041
	• For use in France, Black	636376-051
	• For use in Italy, Black	636376-061
	• For use in Spain, Black	636376-071
	• For use in Portugal, Black	636376-131
	• For use in Turkey, Black	636376-141
	• For use in Saudi Arabia, Black	636376-171
	• For use in Hungary, Black	636376-211
	• For use in Czechoslovakia, Black	636376-221
	• For use in Russia, Black	636376-251
	• For use in Europe, Black	636376-A41
	• For International use, Black	636376-B31
	• For use in the Adriatics, Black	636376-BA1
	• For use in Israel, Black	636376-BB1
	• For use in Switzerland, Black	636376-BG1
	• For use in the Netherlands, Black	636376-DH1
	• For use in Greece, Black	636376-DJ1
	• For use in the United States, Pink	645893-001

Item	Description	Spare part number
	• For use in French Canada, Pink	645893-121
	• For use in the United Kingdom, Pink 645893-031	645893-031
	• For use in Germany, Pink	645893-041
	• For use in France, Pink	645893-051
	• For use in Italy, Pink	645893-061
	• For use in Spain, Pink	645893-071
	• For use in Portugal, Pink	645893-131
	• For use in Turkey, Pink	645893-141
	• For use in Saudi Arabia, Pink	645893-171
	• For use in Hungary, Pink	645893-211
	• For use in Czechoslovakia, Pink 645893-221	645893-221
	• For use in Czechoslovakia, Pink	645893-221
	• For use in Russia, Pink	645893-251
	• For use in Europe, Pink	645893-A41
	• For International use, Pink	645893-B31
	• For use in the Adriatics, Pink	645893-BA1
	• For use in Switzerland, Pink	645893-BG1
	• For use in the Netherlands, Pink	645893-DH1
	• For use in Greece, Pink	645893-DJ1
(3)	Top cover (includes TouchPad board):	
	• For use in Ocean Drive computer models	637196-001
	• For use in Luminous Rose computer models	641287-001
	• For use in Sweet Purple computer models	641297-001
	• For use in Butter Gold computer models	641299-001
	• For use in Pewter computer models	641291-001
	• For use in Charcoal Grey computer models	641289-001
	• For use in Sonoma Red computer models	641285-001
	• For use in Pacific Blue computer models	641293-001
	• For use in Pearl Pink computer models	641295-001
(4)	Power connector (includes cable)	641137-001
(5)	USB board (includes cable)	641145-001
(6)	Power button board (includes cable)	641144-001
(7 & 10)	System board (includes replacement thermal material):	
	• For use in Intel HM55 UMA computer models	636373-001

Item	Description	Spare part number
	• For use in Intel HM65 UMA computer models	639522-001
	• For use in Intel HM55 discrete, 512 M, computer models	636371-001
	• For use in Intel HM55 discrete, 1 GB, computer models	636372-001
	• For use in Intel HM65 discrete, 512 M, computer models	636374-001
	• For use in Intel HM65 discrete, 6470M 512M BACO, computer models	650198-001
	• For use in Intel HM65 discrete, 6470M 1G BACO, computer models	650199-001
	• For use in Intel HM65 discrete, 1 GB, computer models	636375-001
	• For use in AMD UMA computer models	638856-001
	• For use in AMD discrete, 6470M 512M computer models	638854-001
	• For use in AMD discrete, 6470M 1G computer models	638855-001
(8 & 11)	Processor (includes replacement thermal material)	
	• Intel Core i7-2620M processor (2.7 GHz, SC turbo up to 3.40 GHz, 4 MB L3), Dual 35 W	631252-001
	• Intel Core i5-2540M processor (2.6 GHz, SC turbo up to 3.3 GHz, 3 MB L3), Dual 35 W	631255-001
	• Intel Core i5-2520M processor (2.5 GHz, SC turbo up to 3.2 GHz, 3 MB L3), Dual 35 W	631253-001
	• Intel Core i5-2410M processor (2.3 GHz, SC turbo up to 2.9 GHz, 3 MB L3), Dual 35 W	638039-001
	• Intel Core i3 2310M (2.1 GHz, 3 MB L3) Dual 35 W	638037-001
	• Intel Core i5-480M processor (2.66 GHz, SC turbo up to 2.93 GHz, 3 MB L3), Dual 35 W	634693-001
	• Intel Core i3-390M processor (2.66 GHz, 3 MB L3), Dual 35 W	634692-001
	• Intel Core i3-380M processor (2.53 GHz, 3 MB L3), Dual 35 W	625823-001
	• Intel Pentium P6300 (2.26 GHz, 3 MB L3), Dual 35 W	635500-001
	• Intel Pentium P6200 (2.13 GHz, 3 MB L3), Dual 35 W	625831-001
	• Phenom II N970 (2.2 GHz, 2 MB L2, 1333 MHz, 3.6GT/s –Quad 35 W	635496-001
	• Phenom II P960 (1.8 GHz, 2 MB L2, 1066 MHz, 3.6GT/s – Quad 25 W	634689-001
	• Phenom II N870 (2.3 GHz, 1.5 MB L2, 1333 MHz, 3.6GT/s –Triple 35 W	635495-001
	• Phenom II P860 (2.0 GHz, 1.5 MB L2, 1066 MHz, 3.6GT/s –Triple 25 W	634688-001
	• Phenom II N850 (2.2 GHz, 1.5 MB L2, 1333 MHz, 3.6GT/s –Triple 35 W	616345-001
	• Phenom II N660 (3.0 GHz, 2 MB L2, 1333 MHz, 3.6GT/s –Dual 35 W	635494-001
	• Phenom II P650 (2.6 GHz, 2 MB L2, 1066 MHz, 3.6GT/s – Dual 25 W	634687-001
	• Turion II P560 (2.5 GHz, 2 MB L2, 1066 MHz, 3.6GT/s–Dual 25 W	634691-001
	• Athlon II P360 (2.3 GHz, 1 MB L2, 1066 MHz, 3.6GT/s–Dual 25 W	636635-001
	• Athlon II P340 (2.2 GHz, 1 MB L2, 1066 MHz, 3.2GT/s–Dual 25 W	616343-001

Item	Description	Spare part number
	<ul style="list-style-type: none"> V160 (2.4 GHz, 512 KB L2, 1066 MHz, 3.2 GT/s) – SC 25 W 	636634-001
	<ul style="list-style-type: none"> V140 (2.3 GHz, 512 KB L2, 1066 MHz, 3.2 GT/s) – SC 25 W 	616333-001
(9 & 12)	Heat sink assembly (includes replacement thermal material):	
	<ul style="list-style-type: none"> For use in AMD UMA computer models 	639463-001
	<ul style="list-style-type: none"> For use in AMD discrete computer models 	639462-001
	<ul style="list-style-type: none"> For use in Intel UMA HM55 computer models 	637189-001
	<ul style="list-style-type: none"> For use in Intel discrete HM55 computer models 	637190-001
	<ul style="list-style-type: none"> For use in Intel UMA HM65 computer models 	641140-001
	<ul style="list-style-type: none"> For use in Intel discrete HM65 computer models 	641141-001
	<ul style="list-style-type: none"> For use in Intel discrete HM55 computer models 	637190-001
	Fan (available separately)	639460-001
(13)	Speaker assembly (includes cable)	641396-001
(14)	RTC battery (includes mounting adhesive)	637193-001
(15)	Drive activity light board	640215-001
(16)	TouchPad button board	641143-001
(17)	Base enclosure	637187-001
(18)	Wireless (WLAN) module	
	<ul style="list-style-type: none"> Atheros AR9285 802.11a/b/g/n 2x2 WiFi adapter for use in Canada, the Cayman Islands, Guam, Puerto Rico, the United States, and the US Virgin Islands 	580101-001
	<ul style="list-style-type: none"> Broadcom 4313 802.11b/g/n 1x1 WiFi and 2070 Bluetooth 2.1+EDR Combo adapter (BT3.0+HS ready) 	600370-001
	<ul style="list-style-type: none"> Broadcom 4313GN 802.11b/g/n 1x1 WiFi Adapter 	593836-001
	<ul style="list-style-type: none"> Intel Centrino® Wireless-N 1030 + Bluetooth (802.11b/g/n) 	631956-001
	<ul style="list-style-type: none"> Intel Centrino® Wireless-N 1000 (802.11b/g/n) 	593530-001
	<ul style="list-style-type: none"> Ralink 5390GN 802.11b/g/n 1x1 WiFi Adapter 	630703-001
	<ul style="list-style-type: none"> Ralink 5390BC8 802.11b/g/n 1x1 WiFi and Bluetooth 3.0+HS Combo Adapter 	630705-001
	<ul style="list-style-type: none"> Realtek RTL8191SE 802.11b/g/n 1x1 WiFi Adapter 	640926-001
	<ul style="list-style-type: none"> Realtek 8188BC8 802.11a/b/g/n 2x2 WiFi and Bluetooth 3.0+HS Combo Adapter 	602993-001
	<ul style="list-style-type: none"> Atheros AR9285 802.11b/g/n WiFi + Bluetooth Adapter 	593127-001
(19)	Memory modules (1066 MHz, DDR3)	
	<ul style="list-style-type: none"> 4 GB PC3 10600 1333 MHz shared 	621569-001
	<ul style="list-style-type: none"> 2 GB PC3 10600 1333 MHz shared 	621566-001
	<ul style="list-style-type: none"> 2 GB PC3 10600 1333 MHz shared 	621565-001
	<ul style="list-style-type: none"> 1 GB PC3 10600 1333 MHz shared 	639736-001

Item	Description	Spare part number
	<ul style="list-style-type: none"> 1 GB PC3 10600 1333 MHz shared 	621559-001
(20)	Hard drive connector board	644525-001
(21)	Hard drive	
	Supports the following 9.5 mm, 6.35 cm (2.5 in) SATA hard drives:	
	<ul style="list-style-type: none"> 750 GB, 5400 rpm 	644351-001
	<ul style="list-style-type: none"> 640 GB, 5400 rpm 	637312-001
	<ul style="list-style-type: none"> 500 GB, 7200 rpm 	644685-001
	<ul style="list-style-type: none"> 320 GB, 5400 rpm 	645086-001
	Supports the following 7.0 mm, 6.35 cm (2.5 in) SATA hard drives:	
	<ul style="list-style-type: none"> 320 GB, 7200 rpm 	645089-001
	<ul style="list-style-type: none"> 250 GB, 7200 rpm 	645091-001
	<ul style="list-style-type: none"> Hard Drive Hardware Kit (not illustrated, includes bracket and screws) 	639444-001
(22)	Optical drive (includes optical drive bezel and bracket)	
	DVD±RW and CD-RW SuperMulti Double-Layer Combo Drive with LightScribe	636380-001
	Blu-ray Disc ROM with LightScribe DVD±R/RW SuperMulti Double-Layer Drive	636379-001
(23)	Battery	
	<ul style="list-style-type: none"> 6-cell Li-Ion, 2.20 Ah, 47 Wh 	593553-001
	<ul style="list-style-type: none"> 6-cell Li-Ion, 2.55 Ah, 55 Wh 	593554-001
	Rubber Kit (not illustrated, includes rubber feet)	639455-001
(24)	Plastics Kit (includes service access cover)	637192-001

Display assembly components

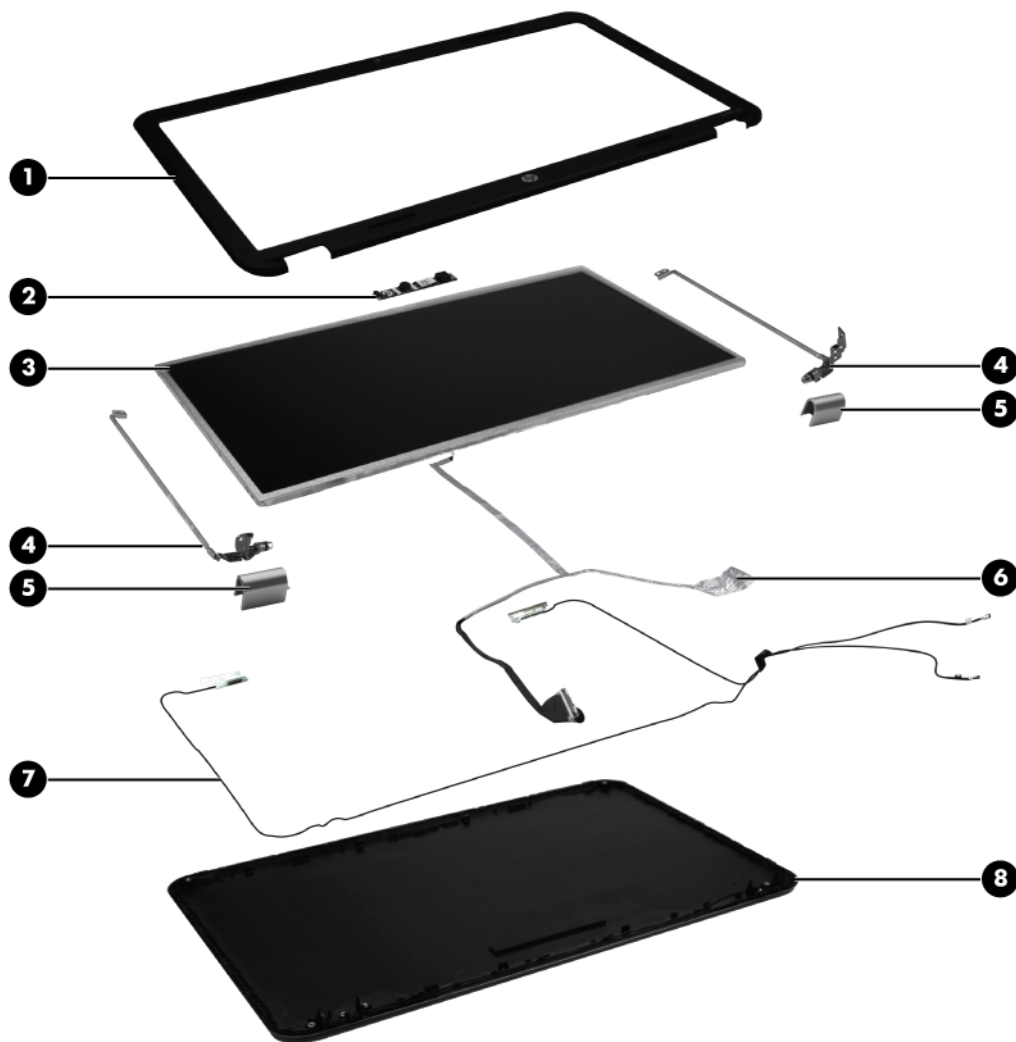

Item	Description	Spare part number
(1)	Display bezel	637188-001
(2)	Webcam module	637197-001
(3)	39.6-cm (15.6-in) high-definition, BrightView LED display panel	647623-001
(4)	Display bracket (with hinges)	637191-001
(5)	Display hinge covers	641142-001
(6)	Display cable (included in the Display Cable Kit)	641136-001
(7)	Wireless antenna (includes wireless antenna transceivers and cable)	637185-001
(8)	Display back cover (includes logo):	
	<ul style="list-style-type: none"> • For use in Ocean Drive computer models 	637186-001
	<ul style="list-style-type: none"> • For use in Sonoma Red computer models 	641284-001
	<ul style="list-style-type: none"> • For use in Luminous Rose computer models 	641286-001

Item	Description	Spare part number
	<ul style="list-style-type: none">• For use in Charcoal Grey computer models	641288-001
	<ul style="list-style-type: none">• For use in Pewter computer models	641290-001
	<ul style="list-style-type: none">• For use in Pacific Blue computer models	641292-001
	<ul style="list-style-type: none">• For use in Pearl Pink computer models	641294-001
	<ul style="list-style-type: none">• For use in Sweet Purple computer models	641296-001
	<ul style="list-style-type: none">• For use in Butter Gold computer models	641298-001

Mass storage devices



Item	Description	Spare part number
(1)	Hard drive	
	Supports the following 9.5 mm, 6.3 cm (2.5 in) SATA hard drives:	
	• 750 GB, 5400 rpm	644351-001
	• 640 GB, 5400 rpm	637312-001
	• 500 GB, 7200 rpm	644685-001
	• 320 GB, 5400 rpm	645086-001
	Supports the following 7 mm, 6.3 cm (2.5 in) SATA hard drives:	
	• 320 GB, 7200 rpm	645089-001
	• 250 GB, 7200 rpm	645091-001
	Hard Drive Hardware Kit (not illustrated, includes bracket and screws)	639444-001
(2)	Optical drive (12.7 mm, SATA, fixed, includes bezel and bracket)	
	DVD±RW and CD-RW SuperMulti Double-Layer Combo Drive	636380-001
	Blu-ray Disc ROM with LightScribe DVD±R/RW Combo Drive	636379-001

Miscellaneous parts

Description	Spare part number
AC adapters	
• 65-W AC adapter	609939-001
• 90-W AC adapter	609940-001
• 65-W AC adapter (EM)	609948-001
• 90-W AC adapter (EM)	609947-001
Power cord, AC, 3 wire, black, 1.83-m	
• For use in North America	490371-001
• For use in Australia	490371-011
• For use in Europe	490371-021
• For use in the United Kingdom and Singapore	490371-031
• For use in Italy	490371-061
• For use in Switzerland	490371-111
• For use in Denmark 490371-081	490371-081
• For use in Thailand	490371-201
• For use in Japan	490371-291
• For use in the People's Republic of China	490371-AA1
• For use in Taiwan	490371-AB1
• For use in South Korea	490371-AD1
• For use in South Africa	490371-AR1
• For use in Israel	490371-BB1
• For use in India	490371-D61
Bluetooth cable	602822-001
Bluetooth module	537921-001
Cable Kit (includes optical drive cable, hard drive cable, and TouchPad cable)	641139-001
Drive activity light board	640215-001
Thermal pad	634433-001

Description	Spare part number
TouchPad LED board	647622-001
Screw kit	637194-001
<ul style="list-style-type: none">• Phillips 2.5x3.0 screw• Phillips 2.5x5 nylon screw• Phillips 3.0x2.0 screw• Phillips 2.5x6.5 screw• Phillips 2.5x10.3 screw• Phillips 4.0x2.5 screw	

Sequential part number listing

Spare part number	Description
490371-001	Power cord, AC, 3 wire, black, 1.83 m for use in North America
490371-021	Power cord, AC, 3 wire, black, 1.83 m for use in Europe
490371-031	Power cord, AC, 3 wire, black, 1.83 m for use in the United Kingdom and Singapore
490371-061	Power cord, AC, 3 wire, black, 1.83 m for use in Italy
490371-081	Power cord, AC, 3 wire, black, 1.83 m for use in Denmark
490371-111	Power cord, AC, 3 wire, black, 1.83 m for use in Switzerland
490371-201	Power cord, AC, 3 wire, black, 1.83 m for use in Thailand
490371-291	Power cord, AC, 3 wire, black, 1.83 m for use in Japan
490371-AA1	Power cord, AC, 3 wire, black, 1.83 m for use in the People's Republic of China
490371-AB1	Power cord, AC, 3 wire, black, 1.83 m for use in Taiwan
490371-AD1	Power cord, AC, 3 wire, black, 1.83 m for use in Korea
490371-AR1	Power cord, AC, 3 wire, black, 1.83 m for use in South Africa
490371-BB1	Power cord, AC, 3 wire, black, 1.83 m for use in Israel
490371-D61	Power cord, AC, 3 wire, black, 1.83 m for use in India
537921-001	Bluetooth module
580101-002	Atheros AR9285 802.11a/b/g/n 2x2 WiFi adapter for use in Canada, the Cayman Islands, Guam, Puerto Rico, the United States, and the US Virgin Islands
593127-001	Atheros AR9285 802.11b/g/n WiFi + Bluetooth Adapter
593530-001	Intel WiFi Link 5100 802.11/b/g/n WLAN module for use in Afghanistan, Albania, Algeria, Andorra, Angola, Antigua and Barbuda, Argentina, Armenia, Aruba, Australia, Austria, Azerbaijan, the Bahamas, Bahrain, Bangladesh, Barbados, Belarus, Belgium, Belize, Benin, Bermuda, Bhutan, Bolivia, Bosnia and Herzegovina, Botswana, Brazil, the British Virgin Islands, Brunei, Bulgaria, Burkina Faso, Burundi, Cameroon, Canada, Cape Verde, the Cayman Islands, the Central African Republic, Chad, Chile, Colombia, Comoros, the Congo, Costa Rica, Croatia, Cyprus, the Czech Republic, Denmark, Djibouti, Dominica, the Dominican Republic, East Timor, Ecuador, Egypt, El Salvador, Equatorial Guinea, Eritrea, Estonia, Ethiopia, Fiji, Finland, France, French Guiana, Gabon, Gambia, Georgia, Germany, Ghana, Gibraltar, Greece, Grenada, Guadeloupe, Guatemala, Guam, Guinea, Guinea-Bissau, Guyana, Haiti, Honduras, Hong Kong, Hungary, Iceland, India, Ireland, Israel, Italy, the Ivory Coast, Jamaica, Jordan, Kazakhstan, Kenya, Kiribati, Kyrgyzstan, Laos, Latvia, Lebanon, Lesotho, Liberia, Liechtenstein, Lithuania, Luxembourg, Macedonia, Madagascar, Malawi, Malaysia, the Maldives, Mali, Malta, the Marshall Islands, Martinique, Mauritania, Mauritius, Mexico, Micronesia, Monaco, Mongolia, Montenegro, Morocco, Mozambique, Namibia, Nauru, Nepal, the Nether Antilles, the Netherlands, New Zealand, Nicaragua, Niger, Nigeria, Norway, Oman, Palau, Panama, Papua New Guinea, Paraguay, the People's Republic of China, Peru, the Philippines, Poland, Portugal, Puerto Rico, the Republic of Moldova, Romania, Rwanda, Samoa, San Marino, Sao Tome and Principe, Saudi Arabia, Senegal, Serbia and Montenegro, the Seychelles, Sierra Leone, Singapore, Slovakia, Slovenia, the Solomon Islands, Somalia, South Africa, South Korea, Spain, Sri Lanka, St. Kitts and Nevis, St. Lucia, St. Vincent and the Grenadines, Suriname, Swaziland, Sweden, Switzerland, Taiwan, Tajikistan, Tanzania, Togo, Tonga, Trinidad and Tobago, Tunisia, Turkey, Turkmenistan, Tuvalu, Uganda, the United Arab Emirates, the United Kingdom, Uruguay, the U.S. Virgin Islands, the United States, Uzbekistan, Vanuatu, Venezuela, Vietnam, Yemen, Zaire, Zambia, and Zimbabwe
593553-001	Battery, 6-cell, 2.20 Ah, 47 Wh

Spare part number	Description
593554-001	Battery, 6-cell, 2.55 Ah, 55 Wh
593836-001	Broadcom 4313GN 802.11b/g/n 1x1 WiFi Adapter
600370-001	Broadcom 4313 802.11b/g/n 1x1 WiFi and 2070 Bluetooth 2.1+EDR Combo adapter (BT3.0+HS ready)
602822-001	Bluetooth cable
605560-005	Atheros AR9285 802.11 a/b/g/n 2x2 WiFi adapter
602993-001	Realtek 8188BC8 802.11a/b/g/n 2x2 WiFi and Bluetooth 3.0+HS Combo Adapter
609939-001	65 W AC adapter
609940-001	90 W AC adapter
609947-001	90-W AC adapter (EM)
609948-001	65-W AC adapter (EM)
616333-001	V140 processor (2.3GHz, 512K L2, 1066MHz, 3.2GT/s), SC 25W
616343-001	Athlon II P340 processor (2.2GHz, 1MB L2, 1066MHz, 3.2GT/s), Dual 25W
616345-001	Phenom II N850 processor (2.2GHz, 1.5MB L2, 1333MHz, 3.6GT/s), Triple 35W
621559-001	1 GB memory module, 10600 1333 MHz shared
621565-001	2 GB memory module, 10600 1333 MHz shared
621566-001	2 GB memory module, 10600 1333 MHz shared
621569-001	4 GB memory module, 10600 1333 MHz shared
625823-001	Intel Core™ i3-380M processor (2.53 GHz, 3 MB L3), Dual 35 W
625831-001	Intel Pentium P6200 processor (2.13 GHz, 3 MB L3), Dual 35 W
630703-001	Ralink 5390GN 802.11b/g/n 1x1 WiFi Adapter
630705-001	Ralink 5390BC8 802.11b/g/n 1x1 WiFi and Bluetooth 3.0+HS Combo Adapter
631252-001	Intel Core™ i7-2620M processor (2.7 GHz, SC turbo up to 3.40 GHz, 4 MB L3), Dual 35 W
631253-001	Intel Core™ i5-2520M processor (2.5 GHz, SC turbo up to 3.2 GHz, 3 MB L3), Dual 35 W
631255-001	Intel Core™ i5-2540M processor (2.6 GHz, SC turbo up to 3.3 GHz, 3 MB L3), Dual 35 W
631956-001	Intel Centrino® Wireless-N 1030 + Bluetooth 802.11 b/g/n adapter
634638-001	500 GB, 5400 rpm 9.5 mm, 6.35 cm (2.5 in) SATA hard drive
634433-001	Thermal pad
634687-001	Phenom II P650 processor (2.6GHz, 2MB L2, 1066MHz, 3.6GT/s), Dual 25W
634688-001	Phenom II P860 processor (2.0GHz, 1.5MB L2, 1066MHz, 3.6GT/s), Triple 25W
634689-001	Phenom II P960 processor (1.8GHz, 2MB L2, 1066MHz, 3.6GT/s), Quad 25W
634691-001	Turion II P560 processor (2.5GHz, 2MB L2, 1066MHz, 3.6GT/s), Dual 25W
634692-001	Intel Core™ i3-390M processor (2.66 GHz, 3 MB L3), Dual 35 W
634693-001	Intel Core™ i5-480M processor (2.66 GHz, SC turbo up to 2.93 GHz, 3 MB L3), Dual 35 W
635494-001	Phenom II N660 processor (3.0GHz, 2MB L2, 1333MHz, 3.6GT/s), Dual 35W

Spare part number	Description
635495-001	Phenom II N870 processor (2.3GHz, 1.5MB L2, 1333MHz, 3.6GT/s), Triple 35W
635496-001	Phenom II N970 processor (2.2GHz, 2MB L2, 1333MHz, 3.6GT/s), Quad 35W
635500-001	Intel Pentium P6300 processor (2.26 GHz, 3 MB L3), Dual 35 W
636370-001	System board for use in Intel HM55 UMA computer models
636371-001	System board (includes replacement thermal material) for use in Intel HM55 discrete, 512 M, computer models
636372-001	System board (includes replacement thermal material) for use in Intel HM55 discrete, 1 GB, computer models
636373-001	System board (includes replacement thermal material) for use in Intel HM55 UMA computer models
636374-001	System board (includes replacement thermal material) for use in Intel HM65 discrete, 512 M, computer models
636375-001	System board (includes replacement thermal material) for use in Intel HM65 discrete, 1 GB, computer models
636376-001	Keyboard, black (includes keyboard cable) for use in the United States, Black
636376-031	Keyboard, black (includes keyboard cable) for use in the United Kingdom
636376-041	Keyboard, black (includes keyboard cable) for use in Germany
636376-051	Keyboard, black (includes keyboard cable) for use in France
636376-061	Keyboard, black (includes keyboard cable) for use in Italy
636376-071	Keyboard, black (includes keyboard cable) for use in Spain
636376-121	Keyboard, black (includes keyboard cable) for use in French Canada, Black
636376-131	Keyboard, black (includes keyboard cable) for use in Portugal
636376-141	Keyboard, black (includes keyboard cable) for use in Turkey
636376-171	Keyboard, black (includes keyboard cable) for use in Saudi Arabia
636376-211	Keyboard, black (includes keyboard cable) for use in Hungary
636376-221	Keyboard, black (includes keyboard cable) for use in Czechoslovakia
636376-251	Keyboard, black (includes keyboard cable) for use in Russia
636376-281	Keyboard, black (includes keyboard cable) for use in Thailand
636376-291	Keyboard, black (includes keyboard cable) for use in Japan
636376-A41	Keyboard, black (includes keyboard cable) for use in Europe
636376-AB1	Keyboard, black (includes keyboard cable) for use in Taiwan
636376-AD1	Keyboard, black (includes keyboard cable) for use in Korea
636376-B31	Keyboard, black (includes keyboard cable) for international use
636376-BA1	Keyboard, black (includes keyboard cable) for use in the Adriatics
636376-BB1	Keyboard, black (includes keyboard cable) for use in Israel
636376-BG1	Keyboard, black (includes keyboard cable) for use in Switzerland

Spare part number	Description
636376-DH1	Keyboard, black (includes keyboard cable) for use in the Netherlands
636376-DJ1	Keyboard, black (includes keyboard cable) for use in Greece
636378-001	39.6 cm (15.6 in) HD LED BrightView (1366×768) display assembly for use in Ocean Drive computer models
636379-001	Blu-ray Disc ROM with LightScribe DVD±R/RW SuperMulti Double-Layer Drive
636380-001	DVD±RW and CD-RW SuperMulti Double-Layer Combo Drive with LightScribe
636634-001	V160 processor (2.4GHz, 512K L2, 1066MHz, 3.2GT/s), SC 25W
636635-001	Athlon II P360 processor (2.3GHz, 1MB L2, 1066MHz, 3.6GT/s), Dual 25W
637185-001	Wireless antenna (includes wireless antenna transceivers and cable)
637186-001	Display back cover (includes logo) for use in Ocean Drive computer models
637187-001	Base enclosure
637188-001	Display bezel
637189-001	Heat sink assembly (includes replacement thermal material) for use in Intel UMA HM55 computer models
637190-001	Heat sink assembly (includes replacement thermal material) for use in Intel discrete HM55 computer models
637191-001	Display bracket (with hinges)
637192-001	Plastics Kit (includes service access cover)
637193-001	RTC battery
637194-001	Screw Kit
637196-001	Top cover for use in Ocean Drive computer models
637197-001	Webcam module
637312-001	640 GB, 5400 rpm 9.5 mm, 6.35 cm (2.5 in) SATA hard drive
638037-001	Intel Core i3 2310M processor (2.1 GHz, 3 MB L3), Dual 35 W
638039-001	Intel Core™ i5-2410M processor (2.3 GHz, SC turbo up to 2.9 GHz, 3 MB L3), Dual 35 W
638854-001	System board (includes replacement thermal material) for use in AMD discrete 6470 512 MB computer models
638855-001	System board (includes replacement thermal material) for use in AMD discrete 6470 1 GB computer models
638856-001	System board (includes replacement thermal material) for use in AMD UMA computer models
639444-001	Hard Drive Hardware Kit (includes bracket and screws)
639455-001	Rubber Kit (includes rubber feet)
639460-001	Heat sink fan
639462-001	Heat sink assembly (includes replacement thermal material) for use in AMD discrete computer models
639463-001	Heat sink assembly (includes replacement thermal material) for use in AMD UMA computer models

Spare part number	Description
639736-001	1 GB PC3 10600 1333 MHz shared [AMD ONLY??]
639511-001	Display hinges
639522-001	System board (includes replacement thermal material) for use in Intel HM65 UMA computer models
639527-001	Top cover (includes TouchPad board) for use in Ocean Drive computer models
640215-001	Drive activity light board
640926-001	Realtek RTL8191SE 802.11b/g/n 1x1 WiFi Adapter
641136-001	Display cable (included in the Display Cable Kit)
641137-001	Power connector (includes cable)
641139-001	Cable Kit (includes optical drive cable, hard drive cable, and TouchPad cable)
641140-001	Heat sink for use in Intel UMA HM65 computer models
641141-001	Heat sink for use in Intel discrete HM65 computer models
641142-001	Display hinge covers
641143-001	TouchPad button board (includes bracket and cable)
641144-001	Power button board (includes cable)
641145-001	USB board (includes cable)
641284-001	Display back cover (includes logo) for use in Sonoma Red computer models
641285-001	Top cover (includes TouchPad board) for use in Sonoma Red computer models
641286-001	Display back cover (includes logo) for use in Luminous Rose computer models
641287-001	Top cover (includes TouchPad board) for use in Luminous Rose computer models
641288-001	Display back cover (includes logo) for use in Charcoal Grey computer models
641289-001	Top cover (includes TouchPad board) for use in Charcoal Grey computer models
641290-001	Display back cover (includes logo) for use in Pewter computer models
641291-001	Top cover (includes TouchPad board) for use in Pewter computer models
641292-001	Display back cover (includes logo) for use in Pacific Blue computer models
641293-001	Top cover (includes TouchPad board) for use in Pacific Blue computer models
641294-001	Display back cover (includes logo) for use in Pearl Pink computer models
641295-001	Top cover (includes TouchPad board) for use in Pearl Pink computer models
641296-001	Display back cover (includes logo) for use in Sweet Purple computer models
641297-001	Top cover (includes TouchPad board) for use in Sweet Purple computer models
641298-001	Display back cover (includes logo) for use in Butter Gold computer models
641299-001	Top cover (includes TouchPad board) for use in Butter Gold computer models
641396-001	Speaker assembly (includes cable)
644351-001	750 GB, 5400 rpm 9.5 mm, 6.35 cm (2.5 in) SATA hard drive
644685-001	500 GB, 7200 rpm 9.5 mm, 6.35 cm (2.5 in) SATA hard drive

Spare part number	Description
645086-001	320 GB, 5400 rpm 9.5 mm, 6.35 cm (2.5 in) SATA hard drive
645089-001	320 GB, 7200 rpm, 7.0 mm, 6.35 cm (2.5 in) SATA hard drive
645091-001	250 GB, 7200 rpm, 7.0 mm, 6.35 cm (2.5 in) SATA hard drive
645521-001	39.6 cm (15.6 in) HD LED BrightView (1366×768) display assembly for use in Sonoma Red computer models
645522-001	39.6 cm (15.6 in) HD LED BrightView (1366×768) display assembly for use in Luminous Rose computer models
645523-001	39.6 cm (15.6 in) HD LED BrightView (1366×768) display assembly for use in Charcoal Grey computer models
645524-001	39.6 cm (15.6 in) HD LED BrightView (1366×768) display assembly for use in Pewter computer models
645525-001	39.6 cm (15.6 in) HD LED BrightView (1366×768) display assembly for use in Pacific Blue computer models
645526-001	39.6 cm (15.6 in) HD LED BrightView (1366×768) display assembly for use in Pearl Pink computer models
645527-001	39.6 cm (15.6 in) HD LED BrightView (1366×768) display assembly for use in Sweet Purple computer models
645528-001	39.6 cm (15.6 in) HD LED BrightView (1366×768) display assembly for use in Butter Gold computer models
645529-001	System board (includes replacement thermal material) for use in AMD E350 UMA computer models
645893-001	Keyboard for use in the United States, Pink
645893-031	Keyboard for use in the United Kingdom, Pink
645893-041	Keyboard for use in Germany, Pink
645893-051	Keyboard for use in France, Pink
645893-061	Keyboard for use in Italy, Pink
645893-071	Keyboard for use in Spain, Pink
645893-121	Keyboard for use in French Canada, Pink
645893-131	Keyboard for use in Portugal, Pink
645893-141	Keyboard for use in Turkey, Pink
645893-171	Keyboard for use in Saudi Arabia, Pink
645893-211	Keyboard for use in Hungary, Pink
645893-221	Keyboard for use in Czechoslovakia, Pink
645893-251	Keyboard for use in Russia, Pink
645893-A41	Keyboard for use in Europe, Pink
645893-B31	Keyboard for international use, Pink
645893-BA1	Keyboard for use in the Adriatics, Pink
645893-BB1	Keyboard for use in Israel, Pink

Spare part number	Description
645893-BG1	Keyboard for use in Switzerland, Pink
645893-DH1	Keyboard for use in the Netherlands, Pink
645893-DJ1	Keyboard for use in Greece, Pink
647622-001	TouchPad LED board
647623-001	39.6-cm (15.6-in) high-definition, BrightView LED display panel
649948-001	System board (includes replacement thermal material) for use in AMD UMA computer models
649949-001	System board (includes replacement thermal material) for use in AMD discrete, 6470M 512M computer models
649950-001	System board (includes replacement thermal material) for use in AMD discrete, 6470M 1G computer models
650198-001	System board (includes replacement thermal material) for use in Intel HM65 discrete, 6470M 512M BACO, computer models -
650199-001	System board (includes replacement thermal material) for use in Intel HM65 discrete, 6470M 1G BACO, computer models -

4 Removal and replacement procedures

Preliminary replacement requirements

Tools required

The following tools are needed to complete the removal and replacement procedures:

- Flat-bladed screwdriver
- Magnetic screwdriver
- Phillips P0 and P1 screwdrivers

Service considerations

Before disassembly or assembly procedures, review and adhere to all service considerations.



NOTE: As you remove each subassembly from the computer, place the subassembly (and all accompanying screws) away from the work area to prevent damage.

Plastic parts

Using excessive force during disassembly and reassembly can damage plastic parts. Use care when handling the plastic parts. Apply pressure only at the points designated in the maintenance instructions.

Cables and connectors

⚠ CAUTION: When servicing the computer, be sure that cables are placed in their proper locations during the reassembly process. Improper cable placement can damage the computer.

Cables must be handled with extreme care to avoid damage. Apply only the tension required to unseat or seat the cables during removal and insertion. Handle cables by the connector whenever possible. In all cases, avoid bending, twisting, or tearing cables. Be sure that cables are routed in such a way that they cannot be caught or snagged by parts being removed or replaced. Handle flex cables with extreme care; these cables tear easily.

Drive handling

⚠ CAUTION: Drives are fragile components that must be handled with care. To prevent damage to the computer, damage to a drive, or loss of information, observe these precautions:

Before removing or inserting a hard drive, shut down the computer. If you are unsure whether the computer is off or in Hibernation, turn the computer on, and then shut it down through the operating system.

Before handling a drive, be sure that you are discharged of static electricity. While handling a drive, avoid touching the connector.

Before removing a diskette drive or optical drive, be sure that a diskette or disc is not in the drive and be sure that the optical drive tray is closed.

Handle drives on surfaces covered with at least one inch of shock-proof foam.

Avoid dropping drives from any height onto any surface.

After removing a hard drive, an optical drive, or a diskette drive, place it in a static-proof bag.

Avoid exposing a hard drive to products that have magnetic fields, such as monitors or speakers.

Avoid exposing a drive to temperature extremes or liquids.

If a drive must be mailed, place the drive in a bubble pack mailer or other suitable form of protective packaging and label the package "FRAGILE."

Grounding guidelines

Electrostatic discharge damage

Electronic components are sensitive to electrostatic discharge (ESD). Circuitry design and structure determine the degree of sensitivity. Networks built into many integrated circuits provide some protection, but in many cases, ESD contains enough power to alter device parameters or melt silicon junctions.

A discharge of static electricity from a finger or other conductor can destroy static-sensitive devices or microcircuitry. Even if the spark is neither felt nor heard, damage might have occurred.

An electronic device exposed to ESD might not be affected at all and can work perfectly throughout a normal cycle. Or the device might function normally for a while, then degrade in the internal layers, reducing its life expectancy.

CAUTION: To prevent damage to the computer when removing or installing internal components, observe these precautions:

Keep components in their electrostatic-safe containers until you are ready to install them.

Use nonmagnetic tools.

Before touching an electronic component, discharge static electricity by using the guidelines described in this section.

Avoid touching pins, leads, and circuitry. Handle electronic components as little as possible.

If you remove a component, place it in an electrostatic-safe container.

The following table shows how humidity affects the electrostatic voltage levels generated by different activities.

CAUTION: A product can be degraded by as little as 700 V.

Typical electrostatic voltage levels			
Event	Relative humidity		
	10%	40%	55%
Walking across carpet	35,000 V	15,000 V	7,500 V
Walking across vinyl floor	12,000 V	5,000 V	3,000 V
Motions of bench worker	6,000 V	800 V	400 V
Removing DIPS from plastic tube	2,000 V	700 V	400 V
Removing DIPS from vinyl tray	11,500 V	4,000 V	2,000 V
Removing DIPS from Styrofoam	14,500 V	5,000 V	3,500 V
Removing bubble pack from PCB	26,500 V	20,000 V	7,000 V
Packing PCBs in foam-lined box	21,000 V	11,000 V	5,000 V

Packaging and transporting guidelines

Follow these grounding guidelines when packaging and transporting equipment:

- To avoid hand contact, transport products in static-safe tubes, bags, or boxes.
- Protect ESD-sensitive parts and assemblies with conductive or approved containers or packaging.
- Keep ESD-sensitive parts in their containers until the parts arrive at static-free workstations.
- Place items on a grounded surface before removing items from their containers.
- Always be properly grounded when touching a component or assembly.
- Store reusable ESD-sensitive parts from assemblies in protective packaging or nonconductive foam.
- Use transporters and conveyors made of antistatic belts and roller bushings. Be sure that mechanized equipment used for moving materials is wired to ground and that proper materials are selected to avoid static charging. When grounding is not possible, use an ionizer to dissipate electric charges.

Workstation guidelines

Follow these grounding workstation guidelines:

- Cover the workstation with approved static-shielding material.
- Use a wrist strap connected to a properly grounded work surface and use properly grounded tools and equipment.
- Use conductive field service tools, such as cutters, screwdrivers, and vacuums.
- When fixtures must directly contact dissipative surfaces, use fixtures made only of static-safe materials.
- Keep the work area free of nonconductive materials, such as ordinary plastic assembly aids and Styrofoam.
- Handle ESD-sensitive components, parts, and assemblies by the case or PCM laminate. Handle these items only at static-free workstations.
- Avoid contact with pins, leads, or circuitry.
- Turn off power and input signals before inserting or removing connectors or test equipment.

Equipment guidelines

Grounding equipment must include either a wrist strap or a foot strap at a grounded workstation.

- When seated, wear a wrist strap connected to a grounded system. Wrist straps are flexible straps with a minimum of one megohm $\pm 10\%$ resistance in the ground cords. To provide proper ground, wear a strap snugly against the skin at all times. On grounded mats with banana-plug connectors, use alligator clips to connect a wrist strap.
- When standing, use foot straps and a grounded floor mat. Foot straps (heel, toe, or boot straps) can be used at standing workstations and are compatible with most types of shoes or boots. On conductive floors or dissipative floor mats, use foot straps on both feet with a minimum of one megohm resistance between the operator and ground. To be effective, the conductive strips must be worn in contact with the skin.

The following grounding equipment is recommended to prevent electrostatic damage:

- Antistatic tape
- Antistatic smocks, aprons, and sleeve protectors
- Conductive bins and other assembly or soldering aids
- Nonconductive foam
- Conductive tabletop workstations with ground cords of one megohm resistance
- Static-dissipative tables or floor mats with hard ties to the ground
- Field service kits
- Static awareness labels
- Material-handling packages
- Nonconductive plastic bags, tubes, or boxes
- Metal tote boxes
- Electrostatic voltage levels and protective materials

The following table lists the shielding protection provided by antistatic bags and floor mats.

Material	Use	Voltage protection level
Antistatic plastic	Bags	1,500 V
Carbon-loaded plastic	Floor mats	7,500 V
Metallized laminate	Floor mats	5,000 V

Component replacement procedures

This chapter provides removal and replacement procedures.

There are as many as 78 screws, in 8 different sizes, that must be removed, replaced, or loosened when servicing the computer. Make special note of each screw size and location during removal and replacement.

Serial number

The serial number label, located in the battery bay of the computer, provides important information that you may need when contacting technical support.

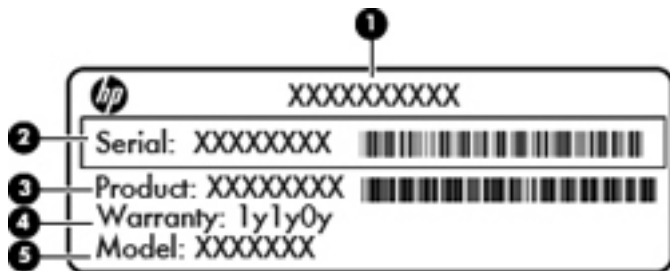

(1) Product name	(4) Warranty period
(2) Serial number	(5) Model description (select models)
(3) Product number	

Computer feet

Description	Spare part number
Rubber Feet Kit	639455-001

The computer feet are adhesive-backed rubber pads. The feet attach to the base enclosure in the locations illustrated below.



Battery

Description	Spare part number
6 cell, 2.20 Ah, 47 Wh	593553-001
6 cell, 2.55 Ah, 55 Wh	593554-001

Before disassembling the computer:

1. Shut down the computer. If you are unsure whether the computer is off or in Hibernation, turn on the computer, and then shut it down through the operating system.
2. Disconnect all external devices connected to the computer.
3. Disconnect the power from the computer by first disconnecting the power cord from the AC outlet and then disconnecting the AC adapter from the computer.

Remove the battery:

1. Position the computer upside down on a flat surface.
2. Slide the battery release latch (1) to release the battery.
3. Pivot the battery (2) upward and lift it out of the computer (3).



To insert the battery, insert the rear edge of the battery into the battery bay and pivot the front edge downward until the battery is seated. The battery release latch automatically locks the battery into place.

Service access cover

Description	Spare part number
Plastics Kit (contains only the service access cover)	637192-001

Before removing the service access cover, remove the battery (see [Battery on page 43](#))

1. Position the computer upside down, with the front toward you.
2. Loosen the two Phillips 4.0×2.0 captive screws (1) that secure the service access cover to the computer.
3. Remove the service access cover (2).

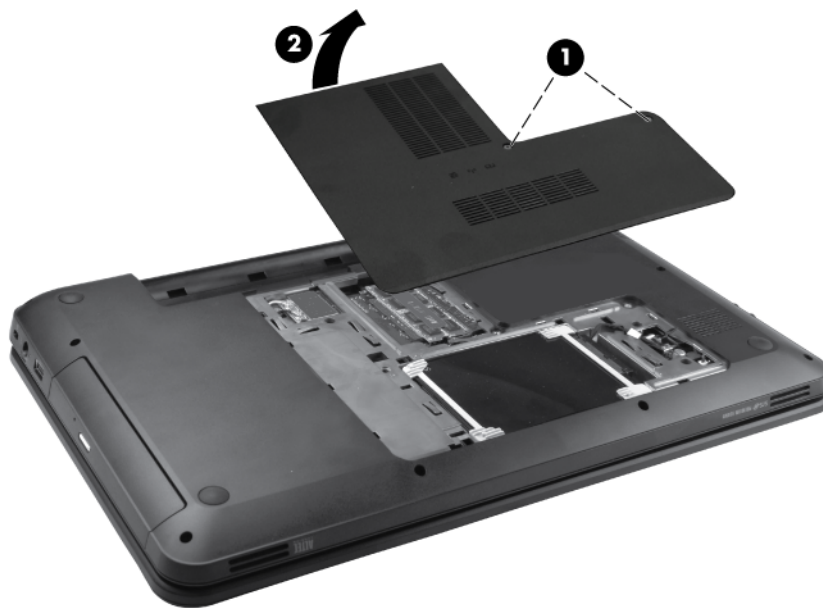

Reverse this procedure to install the service access cover.

Hard drive

 **NOTE:** The hard drive spare part kit includes a hard drive bracket and hard drive connector. The hard drive bracket and hard drive connector, as well as the hard drive bracket screws, are also available in the Hard Drive Hardware Kit.

Description	Spare part number
Supports the following 9.50 mm, 6.35 cm (2.50 in) SATA hard drives:	
750 GB, 5400 rpm	644351-001
640 GB, 5400 rpm	603785-001
500 GB, 7200 rpm	644685-001
320 GB, 5400 rpm	645086
Supports the following 7.00 mm, 6.35 cm (2.50 in) SATA hard drives:	
320 GB, 7200 rpm	645089-001
250 GB, 7200 rpm	645091-001
Hard Drive Hardware Kit (not illustrated, includes connector, bracket, and screws)	639444-001

Before removing the hard drive, remove the following components:

1. Battery (see [Battery on page 43](#))
2. Service access cover (see [Service access cover on page 44](#))

Remove the hard drive:

1. Disconnect the hard drive adapter cable from the system board **(1)** and then pull up on the Mylar tab **(2)** to remove the drive from the hard drive bay.

 **NOTE:** If the rubber hard drive bracket is wedged into the hard drive bay snugly, you may need to gently pry up the hard drive using a thin nonconductive tool.

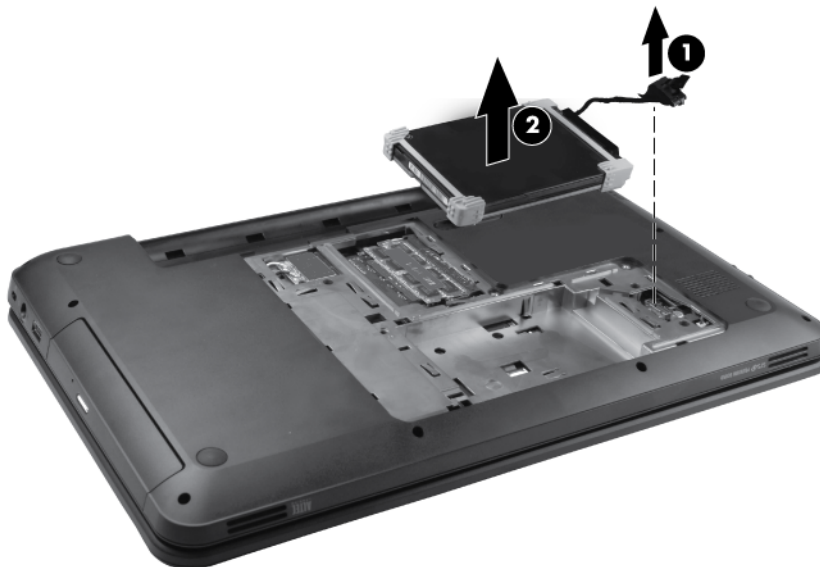

2. Disconnect the hard drive adapter (1). Then remove the hard drive bumpers (2), and the Mylar cover (3).

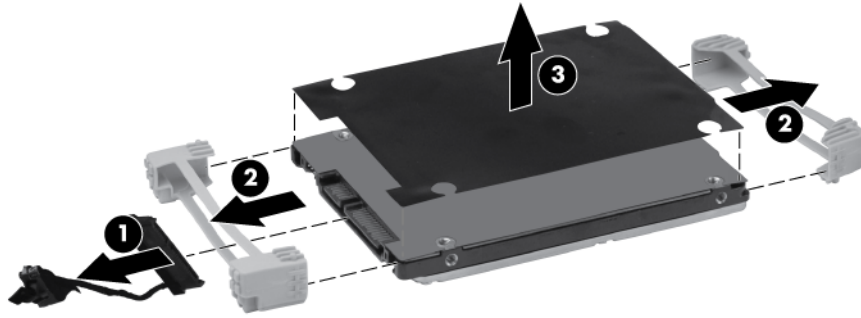

Reverse this procedure to install the hard drive.

Optical drive



NOTE: The optical drive spare part kit includes an optical drive bezel and optical drive bracket.

Description	Spare part number
DVD±RW and CD-RW SuperMulti Double-Layer Combo Drive with LightScribe	636380-001
Blu-ray Disc ROM with LightScribe DVD±R/RW SuperMulti Double-Layer Drive	636379-001

Before removing the optical drive:

1. Battery (see [Battery on page 43](#))
2. Service access cover (see [Service access cover on page 44](#))

Remove the optical drive:

1. Remove the Phillips 3.0×2.5 screw **(1)** that secures the optical drive to the computer.
2. Insert a thin tool, such as a screw driver **(2)**, into the release access slot next to the hard drive bay.
3. Grasp the bezel and slide the optical drive out of the computer **(3)**.



4. To replace the optical drive bracket, position the optical drive with the optical drive bracket toward you.
5. Remove the two Phillips 3.0×2.0 screws **(1)** that secure the optical drive bracket to the optical drive.

6. Remove the optical drive bracket (2).



7. To replace the optical drive bezel, disconnect it from the optical drive.



Reverse this procedure to reassemble and install the optical drive.

WLAN module

Description	Spare part number
Atheros AR9285 802.11 a/b/g/n 2x2 WiFi adapter for use in Canada, the Cayman Islands, Guam, Puerto Rico, the United States, and the US Virgin Islands	580101-001
Atheros AR9285 802.11 a/b/g/n 2x2 WiFi adapter for use in Afghanistan, Albania, Algeria, Andorra, Angola, Antigua and Barbuda, Argentina, Armenia, Aruba, Australia, Austria, Azerbaijan, the Bahamas, Bahrain, Bangladesh, Barbados, Belarus, Belgium, Belize, Benin, Bermuda, Bhutan, Bolivia, Bosnia and Herzegovina, Botswana, Brazil, the British Virgin Islands, Brunei, Bulgaria, Burkina Faso, Burundi, Cameroon, Canada, Cape Verde, the Cayman Islands, the Central African Republic, Chad, Chile, Colombia, Comoros, the Congo, Costa Rica, Croatia, Cyprus, the Czech Republic, Denmark, Djibouti, Dominica, the Dominican Republic, East Timor, Ecuador, Egypt, El Salvador, Equatorial Guinea, Eritrea, Estonia, Ethiopia, Fiji, Finland, France, French Guiana, Gabon, Gambia, Georgia, Germany, Ghana, Gibraltar, Greece, Grenada, Guadeloupe, Guatemala, Guam, Guinea, Guinea-Bissau, Guyana, Haiti, Honduras, Hong Kong, Hungary, Iceland, India, Ireland, Israel, Italy, the Ivory Coast, Jamaica, Jordan, Kazakhstan, Kenya, Kiribati, Kyrgyzstan, Laos, Latvia, Lebanon, Lesotho, Liberia, Liechtenstein, Lithuania, Luxembourg, Macedonia, Madagascar, Malawi, Malaysia, the Maldives, Mali, Malta, the Marshall Islands, Martinique, Mauritania, Mauritius, Mexico, Micronesia, Monaco, Mongolia, Montenegro, Morocco, Mozambique, Namibia, Nauru, Nepal, the Nether Antilles, the Netherlands, New Zealand, Nicaragua, Niger, Nigeria, Norway, Oman, Palau, Panama, Papua New Guinea, Paraguay, the People's Republic of China, Peru, the Philippines, Poland, Portugal, Puerto Rico, the Republic of Moldova, Romania, Rwanda, Samoa, San Marino, Sao Tome and Principe, Saudi Arabia, Senegal, Serbia and Montenegro, the Seychelles, Sierra Leone, Singapore, Slovakia, Slovenia, the Solomon Islands, Somalia, South Africa, South Korea, Spain, Sri Lanka, St. Kitts and Nevis, St. Lucia, St. Vincent and the Grenadines, Suriname, Swaziland, Sweden, Switzerland, Taiwan, Tajikistan, Tanzania, Togo, Tonga, Trinidad and Tobago, Tunisia, Turkey, Turkmenistan, Tuvalu, Uganda, the United Arab Emirates, the United Kingdom, Uruguay, the U.S. Virgin Islands, the United States, Uzbekistan, Vanuatu, Venezuela, Vietnam, Yemen, Zaire, Zambia, and Zimbabwe	605560-005
Broadcom 4313 802.11b/g/n 1x1 WiFi and 2070 Bluetooth 2.1+EDR Combo adapter (BT3.0+HS ready)	600370-001
Broadcom 4313GN 802.11b/g/n 1x1 WiFi Adapter	593836-001
Intel Centrino® Wireless-N 1030 + Bluetooth (802.11 b/g/n)	631956-001
Intel Centrino® Wireless-N 1000 (802.11 b/g/n)	593530-001
Ralink 5390GN 802.11b/g/n 1x1 WiFi Adapter	630703-001
Ralink 5390BC8 802.11b/g/n 1x1 WiFi and Bluetooth 3.0+HS Combo Adapter	630705-001
Realtek RTL8191SE 802.11b/g/n 1x1 WiFi Adapter	640926-001
Realtek 8188BC8 802.11a/b/g/n 2x2 WiFi and Bluetooth 3.0+HS Combo Adapter	602993-001
Atheros AR9285 802.11b/g/n WiFi + Bluetooth Adapter	593127-001

Before removing the WLAN module, remove the following components:

1. Battery (see [Battery on page 43](#))
2. Service access cover (see [Service access cover on page 44](#))

Remove the WLAN module:

1. Disconnect the main antenna cable **(1)** and the auxiliary antenna cable **(2)** from the wireless module.
2. Remove the Phillips 3.0×2.0 screw **(3)** that secures the WLAN module to the computer. (The edge of the module opposite the slot rises away from the computer.)

3. Remove the WLAN module (4) by pulling it away from the slot at an angle.

⚠ CAUTION: To prevent an unresponsive system, replace the wireless module only with a wireless module authorized for use in the computer by the governmental agency that regulates wireless devices in your country or region. If you replace the module and then receive a warning message, remove the module to restore computer functionality, and then contact technical support through Help and Support.

📝 NOTE: WLAN modules are designed with a notch (5) to prevent incorrect insertion into the WLAN module slot.

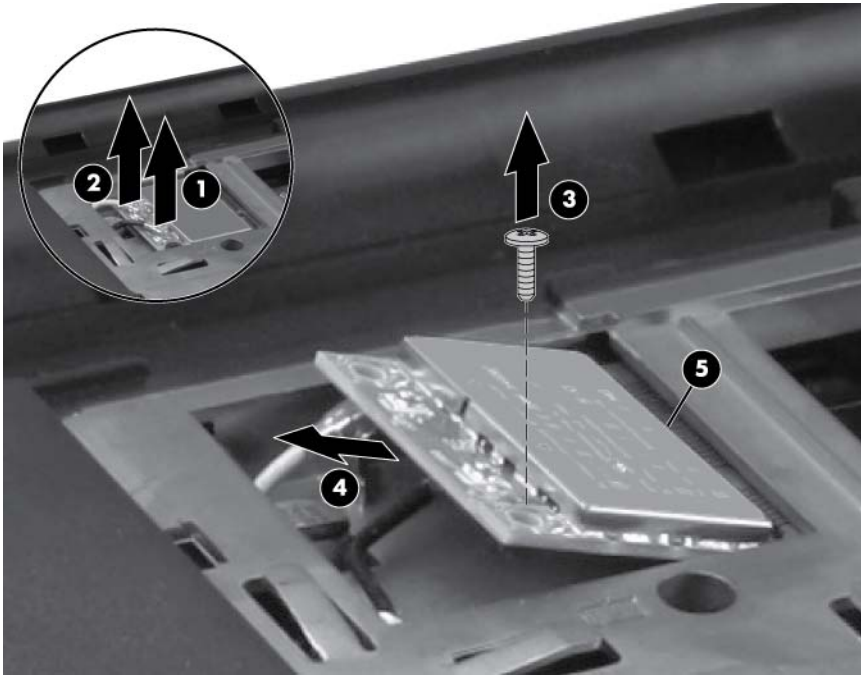

Reverse this procedure to install a WLAN module.

Memory module

Description	Spare part number
4 GB PC3 10600 1333 MHz shared	621569-001
2 GB PC3 10600 MHz	621566-001
2 GB PC3 10600 MHz	621565-001
1 GB PC3 10600 1333 MHz shared	621559-001
1 GB PC3 10600 1333 MHz shared	639736-001

Before removing the memory module, remove the following components:

1. Battery (see [Battery on page 43](#))
2. Service access cover (see [Service access cover on page 44](#))

Remove the memory module:

1. Spread the retaining tabs **(1)** on each side of the memory module slot to release the memory module. (The edge of the module opposite the slot rises away from the computer.)
2. Remove the module **(2)** by pulling it away from the slot at an angle.

 **NOTE:** Memory modules are designed with a notch **(3)** to prevent incorrect insertion into the memory module slot.

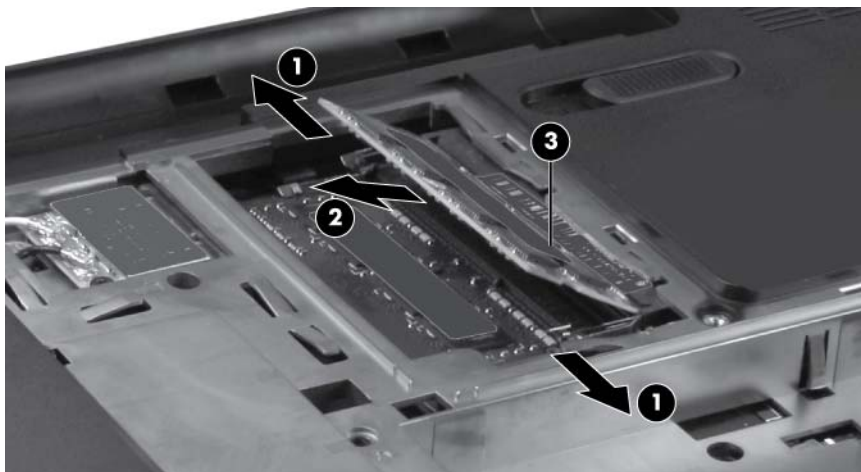

Reverse this procedure to install a memory module.

Keyboard

Description	Spare part number
See Computer major components on page 18 for complete list of available keyboards.	

Before removing the keyboard, remove the following components:

1. Battery (see [Battery on page 43](#))
2. Service access cover (see [Service access cover on page 44](#))

Remove the keyboard:

1. Remove the Phillips 5.0×2.5 screw that secures the keyboard to the computer.



2. Open the display and stand the computer on its side. Insert a small screwdriver through the keyboard access hole in the bottom of the computer. (The keyboard access hole is the same hole from which the keyboard screw was removed.) Push firmly on the bottom of the keyboard until it is disengaged.

 **NOTE:** When the computer is standing on its side, the hard drive assembly may come out of its bay still cabled to the computer. After disengaging the keyboard, reseat the hard drive assembly as necessary prior to the next step.

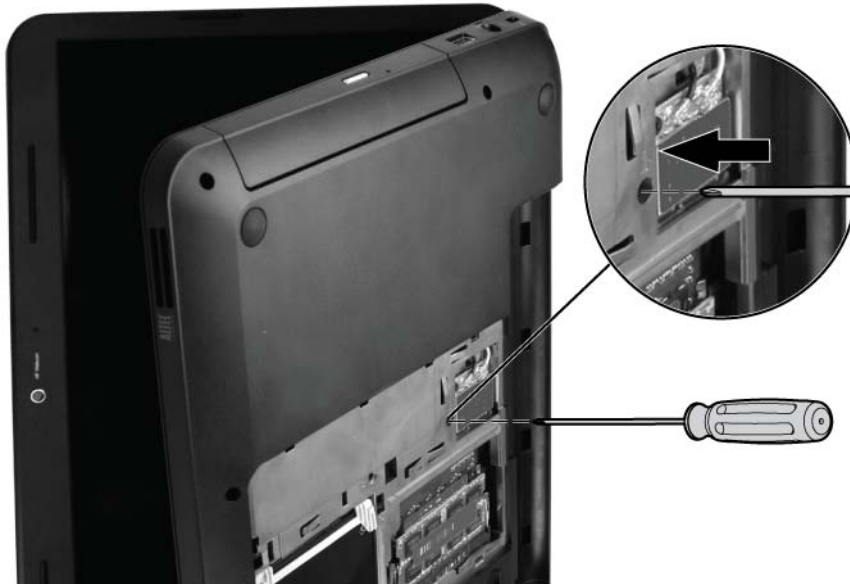

3. Position the computer display-side up, with the front toward you, and open the computer as far as possible. Lift the rear edge of the keyboard and tilt the keyboard forward onto the palm rest.



4. Release the zero insertion force (ZIF) connector (1) to which the keyboard cable is attached, and then disconnect the keyboard cable (2). Remove the keyboard (3).



Reverse this procedure to install the keyboard.

Top cover

Description	Spare part number
For use in Ocean Drive computer models	637196-001
For use in Luminous Rose computer models	641287-001
For use in Sweet Purple computer models	641297-001
For use in Butter Gold computer models	641299-001
For use in Pewter computer models	641291-001
For use in Charcoal Grey computer models	641289-001
For use in Sonoma Red computer models	641285-001
For use in Pacific Blue computer models	641293-001
For use in Pearl Pink computer models	641295-001

Before removing the top cover, remove the following components:

1. Battery (see [Battery on page 43](#))
2. Service access cover (see [Service access cover on page 44](#))
3. Hard drive (See [Hard drive on page 45](#)).
4. Optical drive (see [Optical drive on page 47](#)).
5. WLAN module (see [WLAN module on page 49](#)).
6. Memory module (see [Memory module on page 51](#)).
7. Keyboard (see [Keyboard on page 52](#)).

Remove the top cover:

1. Position the computer display-side up, with the front toward you, and open the computer as far as possible.

2. Release the three zero insertion force (ZIF) connectors (1) to which the ZIF cables are attached. Then disconnect the power button cable (2), the TouchPad cable (3), the TouchPad button cable (4), and USB board cable (5) from the system board.

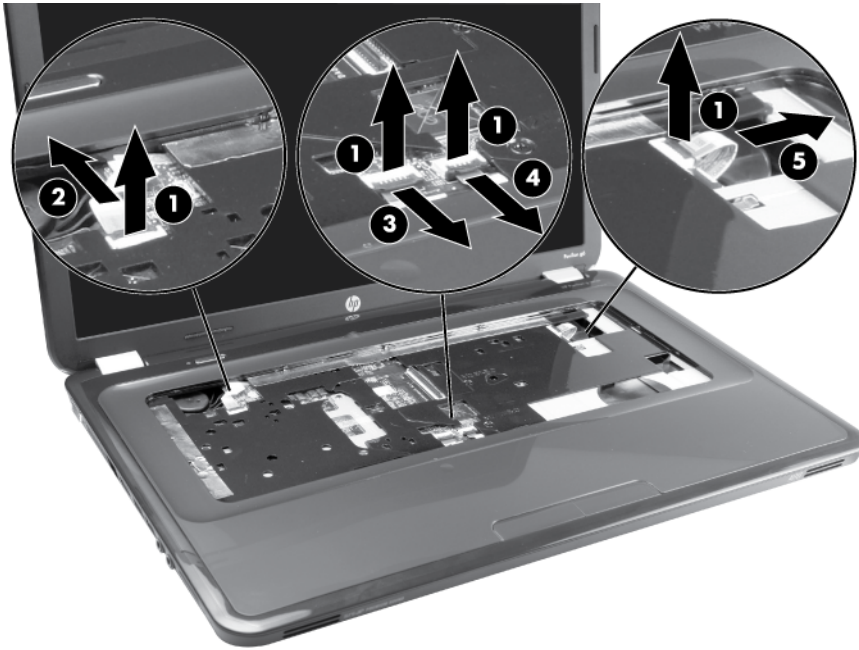

3. Remove the two Phillips 5.0×2.5 screws that secure the top cover to the computer.



4. Turn the computer upside down, with the front toward you.

5. Remove the three Phillips 5.0×2.5 screws in the battery bay, the two Phillips 5.0×2.5 screws near the hard drive connector, and the nine Phillips 6.0×2.5 screws along the edges of the base enclosure.

 **NOTE:** The four screws along the front edge also serve to secure the speakers inside the base enclosure.

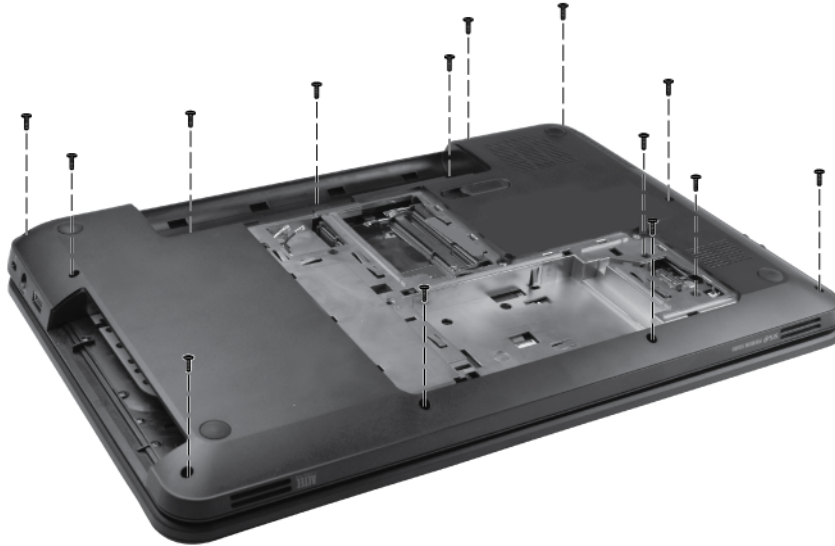

6. Lift the rear edge of the top cover (1) until the top cover disengages from the base enclosure. Remove the top cover (2).

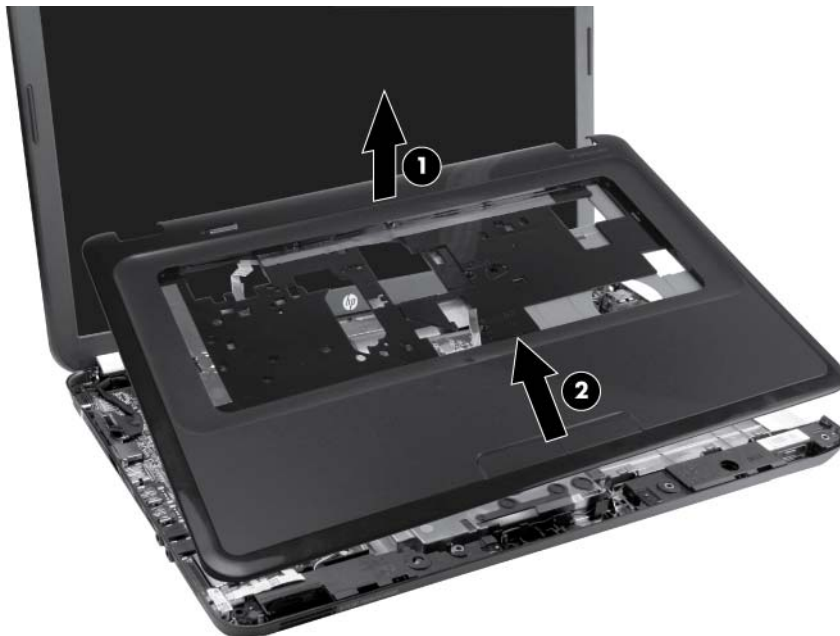

 **NOTE:** The TouchPad is glued to the top cover and is included with the top cover spare part.

Reverse this procedure to install the top cover.

Power button board

Description	Spare part number
Power button board (includes cable)	641144-001

Before removing the power button board, remove the following components:

1. Battery (see [Battery on page 43](#))
2. Service access cover (see [Service access cover on page 44](#))
3. Hard drive (See [Hard drive on page 45](#))
4. Optical drive (see [Optical drive on page 47](#))
5. WLAN module (see [WLAN module on page 49](#)).
6. Memory module (see [Memory module on page 51](#))
7. Keyboard (see [Keyboard on page 52](#))
8. Top cover (see [Top cover on page 55](#))

Remove the power button board:

1. Position the top cover upside down, with the rear edge toward you.
2. Remove the Phillips 3.0×2.0 screw (1) that secures the power button board to the top cover.
3. Lift up and remove the power button board (2).

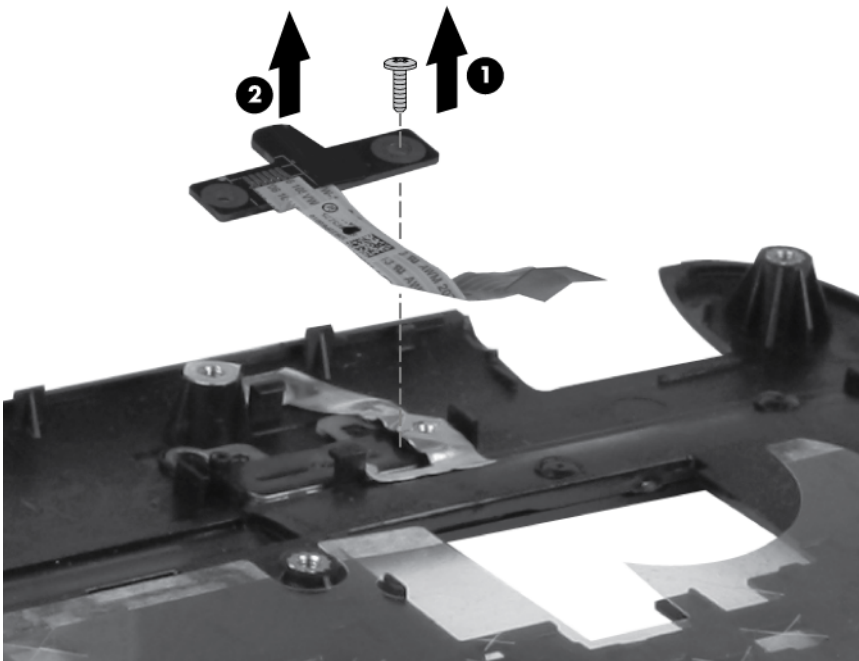

Reverse this procedure to install the power button board.

TouchPad button board

Description	Spare part number
TouchPad button board (includes bracket and cable)	641143-001

Before removing the TouchPad button board, remove the following components:

1. Battery (see [Battery on page 43](#))
2. Service access cover (see [Service access cover on page 44](#))
3. Hard drive (see [Hard drive on page 45](#))
4. Optical drive (see [Optical drive on page 47](#))
5. Keyboard (see [Keyboard on page 52](#))
6. Top cover (see [Top cover on page 55](#))

Remove the TouchPad button board:

1. Position the top cover upside down, with the front toward you.
2. Release the ZIF connector (1), and then disconnect the TouchPad LED ZIF cable (2) from the TouchPad button board.
3. Remove the Phillips PM2.0×3.0 screw (3) that secures the TouchPad bracket to the top cover.
4. Lift up and remove the TouchPad button board bracket (4). The TouchPad button is fused onto the TouchPad button board bracket.

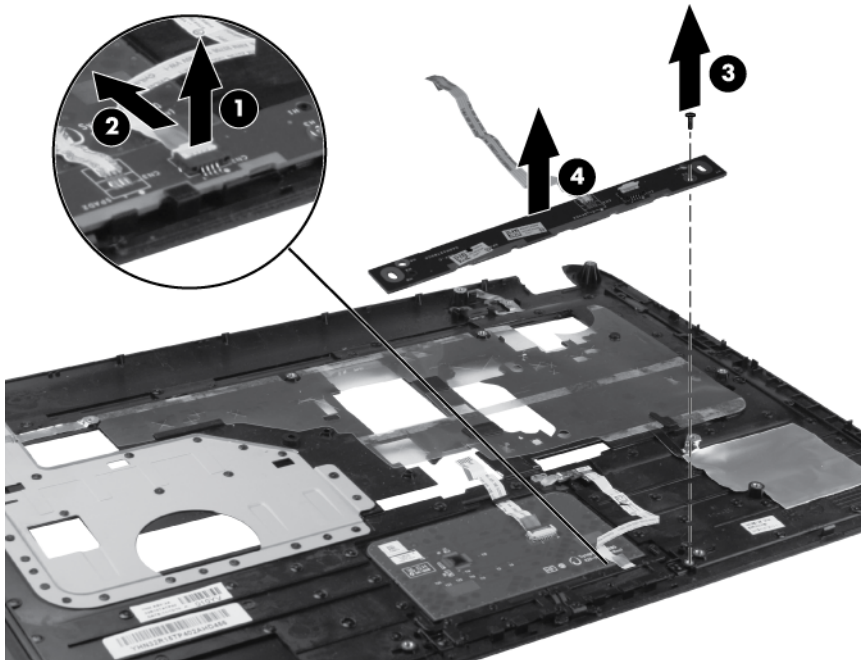

Reverse the above procedure to reassemble and install the TouchPad button board.

TouchPad LED board

 **NOTE:** The security cable lock is included with the base enclosure, spare part number 637187-001.

TouchPad LED board

647622-001

Before removing the TouchPad LED board, remove the following components:

1. Battery (see [Battery on page 43](#))
2. Service access cover (see [Service access cover on page 44](#))
3. Hard drive (see [Hard drive on page 45](#))
4. Optical drive (see [Optical drive on page 47](#))
5. Keyboard (see [Keyboard on page 52](#))
6. Top cover (see [Top cover on page 55](#))

Remove the TouchPad LED board:

1. Position the computer right-side up.
2. Release the zero insertion force (ZIF) connector **(1)**, and disconnect the LED ZIF cable **(2)** from the system board.
3. Remove the LED board **(3)**.



Reverse this procedure to install the TouchPad LED board.

Speaker assembly

Description	Spare part number
Speaker assembly (includes cable)	641396-001

Before removing the speaker assembly, remove the following components:

1. Battery (see [Battery on page 43](#))
2. Service access cover (see [Service access cover on page 44](#))
3. Hard drive (see [Hard drive on page 45](#))
4. Optical drive (see [Optical drive on page 47](#))
5. Keyboard (see [Keyboard on page 52](#))
6. TouchPad top cover (see [Top cover on page 55](#))
7. TouchPad LED board (see [TouchPad LED board on page 60](#))

Remove the speaker assembly:

1. Disconnect the speaker cable (1) from the system board.
2. Gently pry back the tabs on the base enclosure (2) to release the speakers, and then lift up to remove the speakers (3).

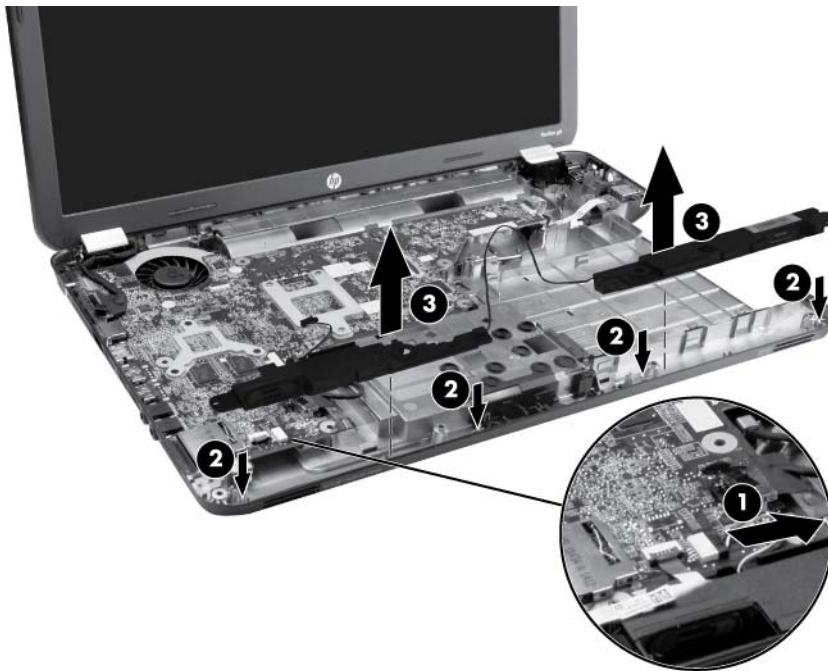

Reverse this procedure to install the speaker assembly.

USB board

Description	Spare part number
USB board (includes cable)	641145-001

Before removing the USB board, remove the following components:

1. Battery (see [Battery on page 43](#))
2. Service access cover (see [Service access cover on page 44](#))
3. Hard drive (see [Hard drive on page 45](#))
4. Optical drive (see [Optical drive on page 47](#))
5. Keyboard (see [Keyboard on page 52](#))
6. Top cover (see [Top cover on page 55](#))

Remove the USB board:

1. Position the computer right-side up.
2. Release the clips (1) that secure the USB board to the base enclosure.
3. Lift the USB board (2) straight up and remove it from the computer.

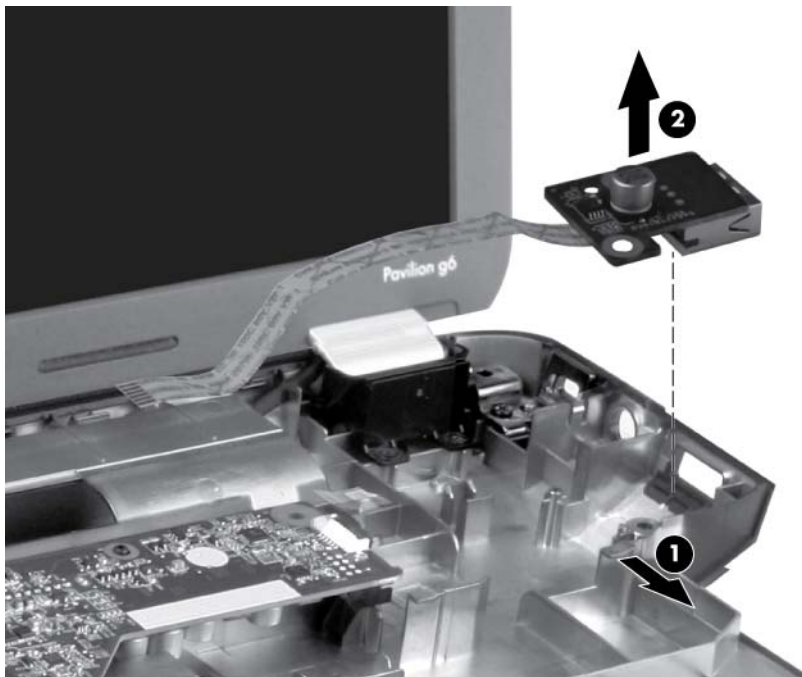

Reverse this procedure to install the USB board.

Power connector

Description	Spare part number
Power connector	641137-001

Before removing the power connector cable, remove the following components:

1. Battery (see [Battery on page 43](#))
2. Service access cover (see [Service access cover on page 44](#))
3. Hard drive (see [Hard drive on page 45](#))
4. Optical drive (see [Optical drive on page 47](#))
5. Keyboard (see [Keyboard on page 52](#))
6. Top cover (see [Top cover on page 55](#))

Remove the power connector:

1. Position the computer right-side up.
2. Disconnect the power connector cable (1) from the system board.
3. Lift the power connector (2) away from the clips built into the base enclosure.

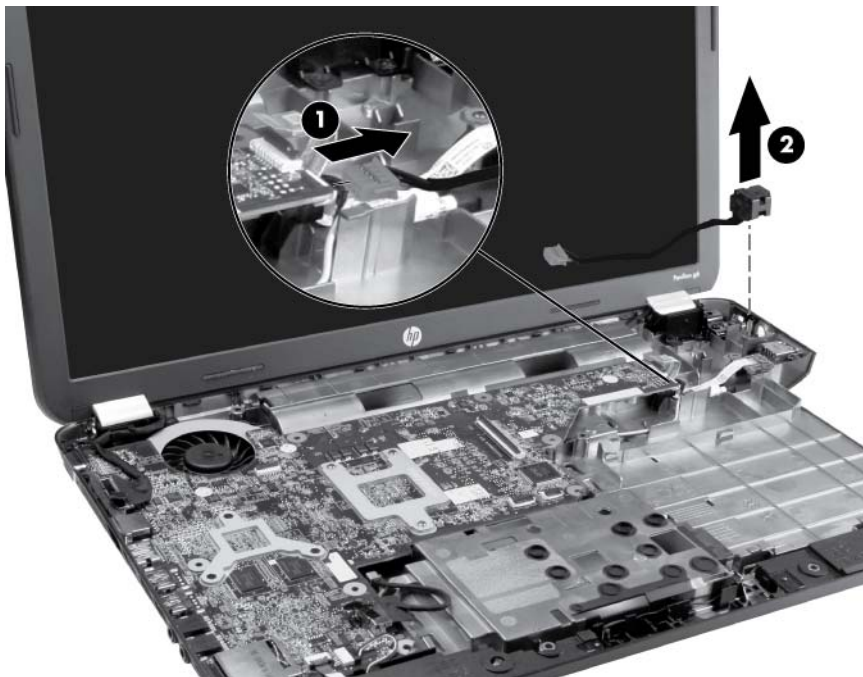

Reverse this procedure to install the power connector.

Display assembly

Description	Spare part number
39.6-cm (15.6-in) High Definition (HD), light-emitting diode (LED) BrightView display assembly:	
• For use in Charcoal Grey computer models	645523-001
• For use in Ocean Drive computer models	636378-001
• For use in Sonoma Red computer models	645521-001
• For use in Luminous Rose computer models	645522-001
• For use in Pewter computer models	645524-001
• For use in Pacific Blue computer models	645525-001
• For use in Pearl Pink computer models	645526-001
• For use in Sweet Purple computer models	645527-001
• For use in Butter Gold computer models	645528-001

Before removing the display assembly, remove the following components:

1. Battery (see [Battery on page 43](#))
2. Service access cover (see [Service access cover on page 44](#))
3. Optical drive (see [Optical drive on page 47](#))
4. WLAN module (see [WLAN module on page 49](#))
5. Keyboard (see [Keyboard on page 52](#))
6. Top cover (see [Top cover on page 55](#))
7. USB board (see [USB board on page 62](#))
8. Power connector (see [Power connector on page 63](#))

Remove the display assembly:

1. Position the computer display-side up, with the front toward you.
2. Open the display as far as possible.
3. Disconnect the display panel cable **(1)** from the system board.
4. Pull the antenna cables through the opening in the base enclosure **(2)**, and then disengage the cables from the clip in the routing channel leading to the display hinge.

 **CAUTION:** Support the display assembly when removing the display screws in the following steps. Failure to support the display assembly can result in damage to the assembly and other components.

5. Remove the two Phillips 6.0×2.5 screws **(3)** that secure the display assembly to the computer.

- Lift the display panel (4) straight up to remove it.

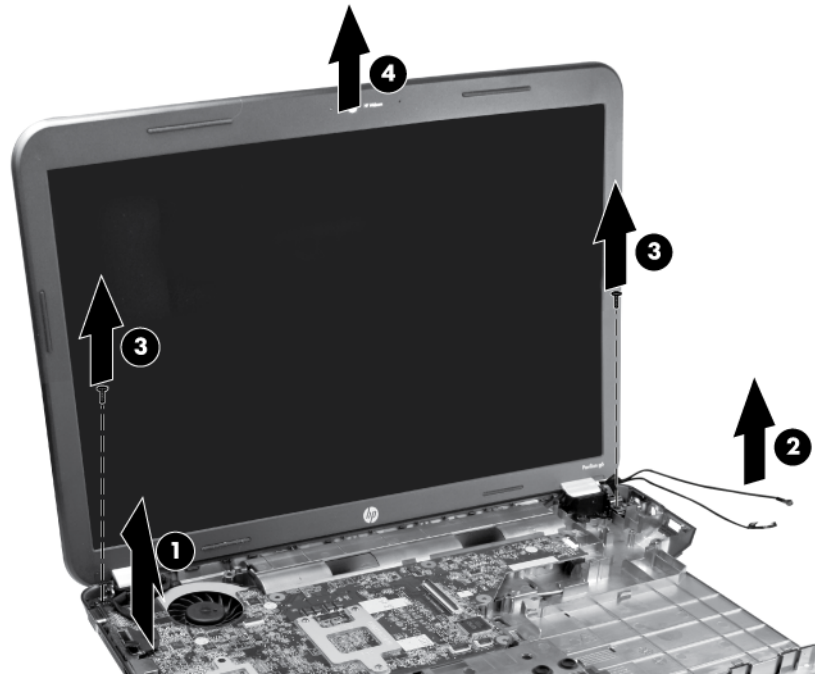

 **NOTE:** The security bracket is part of the right hinge.

Reverse this procedure to install the display assembly.

7. To replace any of the display assembly internal components, remove the following screw covers and screws:

- (1) Two Mylar screw covers on the display bezel bottom edge

- (2) Two Phillips 5.0×2.5 screws

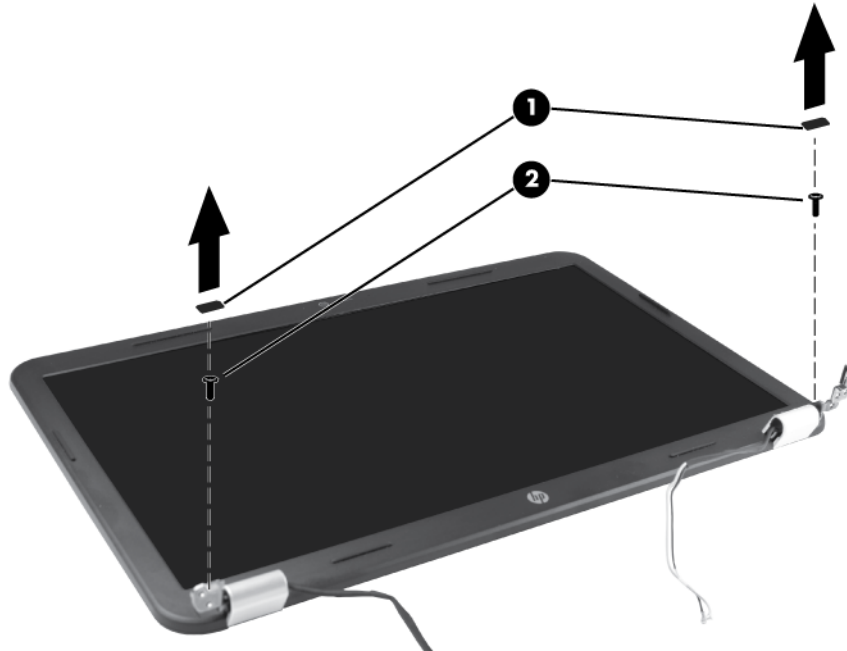

8. Flex the inside edge of the left side (1), the top and bottom sides (2), and the right side (3) of the display bezel until the bezel disengages from the display back cover.

9. Remove the display bezel (4).

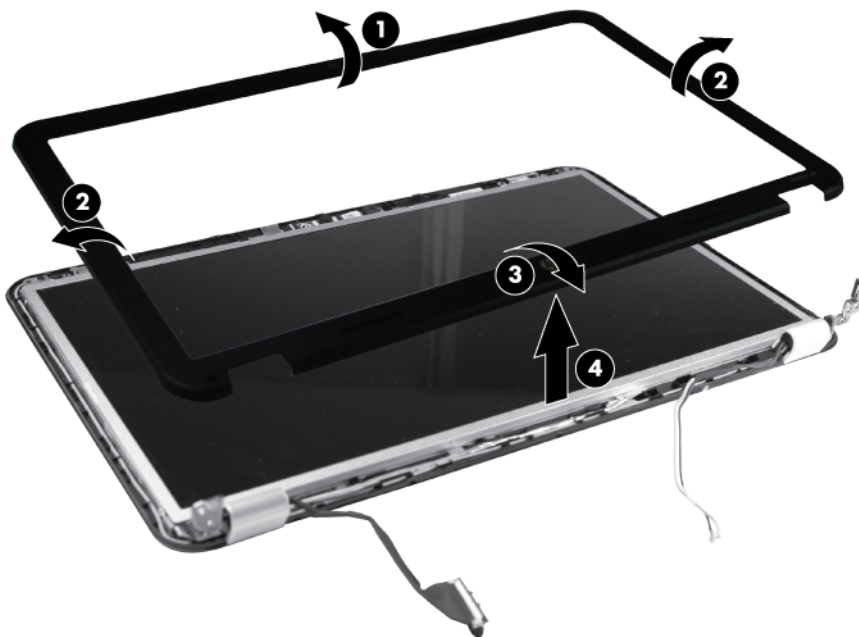

Reverse this procedure to install the display bezel.

10. To replace the webcam module, lift the webcam module as far from the display enclosure as the webcam module cable allows.
11. Disconnect the webcam module cable (1) from the webcam module, and then remove the webcam module (2). The webcam module is available using spare part number 637197-001.



Reverse this procedure to install the webcam module.

12. To replace the display hinge covers, remove the two Phillips 3.0×2.5 screws (1) that secure the covers to the display enclosure.

13. Remove the display hinge covers (2). The display hinge covers are available using spare part number 641142-001.

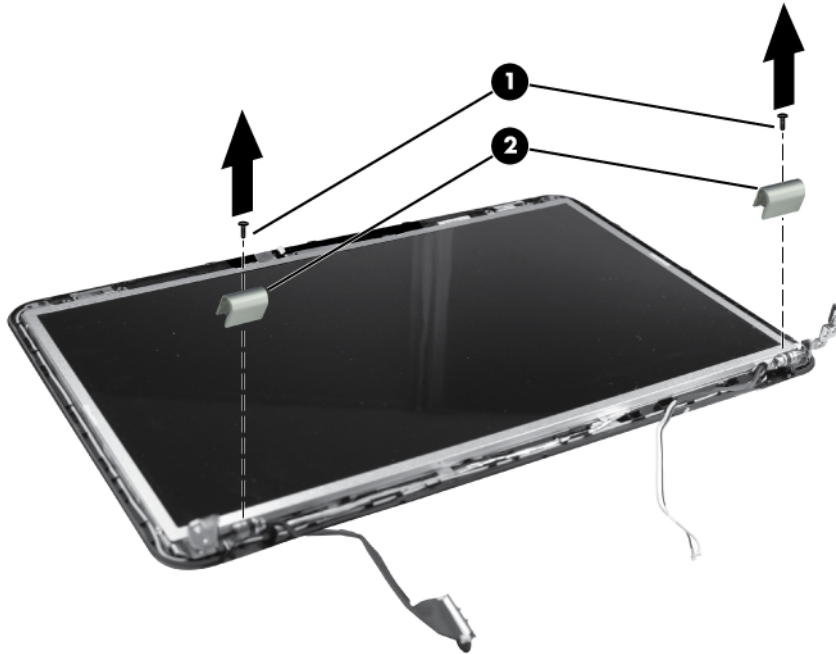

Reverse this procedure to install the display hinge covers.

14. To replace the display panel, remove four Phillips 4.0×2.5 screws that secure the display panel to the display enclosure.

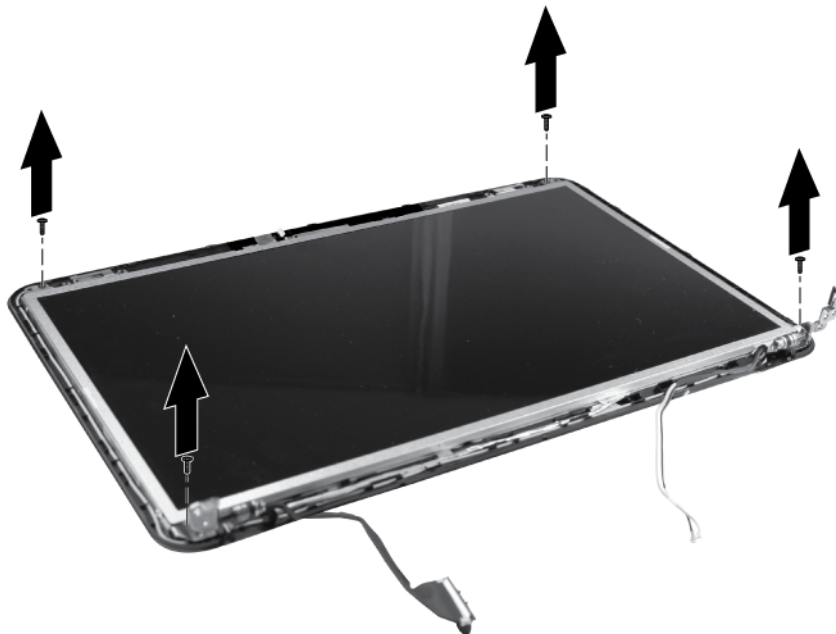

15. Tilt the display (1) up, release the tape (2) holding the display cable to the display panel, and then disconnect the cable (3).

16. Remove the display panel (4) from the display enclosure. The display panel is available using spare part number 647623-001 .

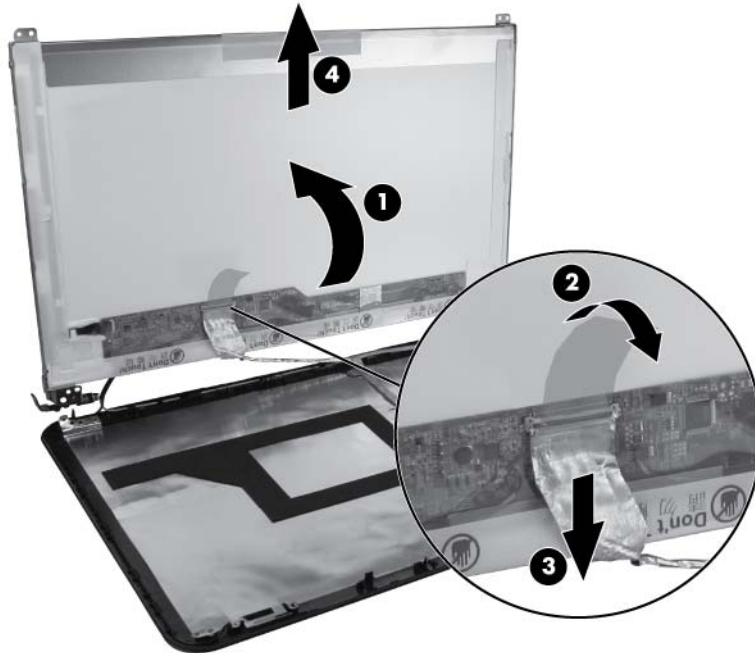

Reverse this procedure to install the display panel.

17. To replace the display panel brackets, remove the two Phillips PM 3.0×2.0 screws (1) that secure each bracket to the display panel.
18. Remove the display brackets (2) from the display panel. The display brackets are available using spare part number 637191-001.

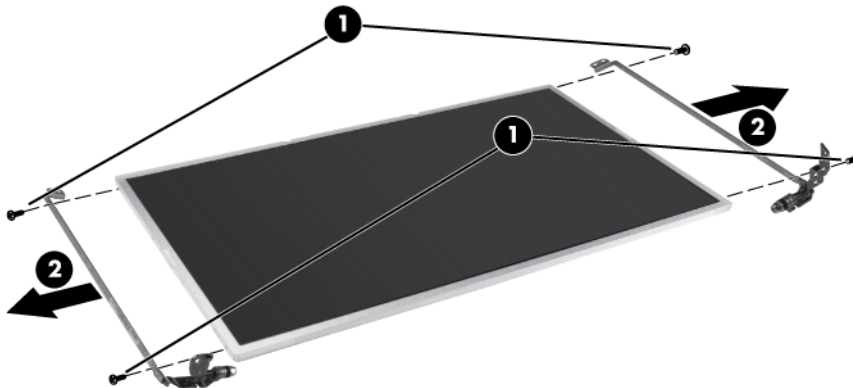

Reverse this procedure to install the display hinges.

19. To replace the wireless transceivers, lift up on the silver transceivers (1), and then release the adhesive material from the display cover.

20. Lift up to remove the transceiver cable(2). The wireless antenna transceivers and cable are available using spare part number 637185-001.

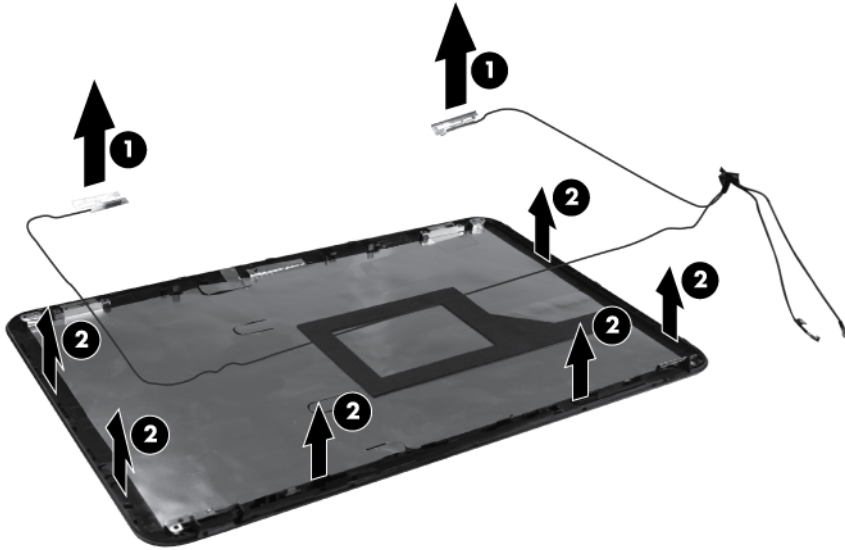

Reverse this procedure to install the display wireless antenna transceivers.

21. To remove the display cable from the display enclosure, lift the adhesive tabs (1) that hold the display cable to the display enclosure. Gently peel the display cable (2) away from the adhesive that holds the cable to the display panel.

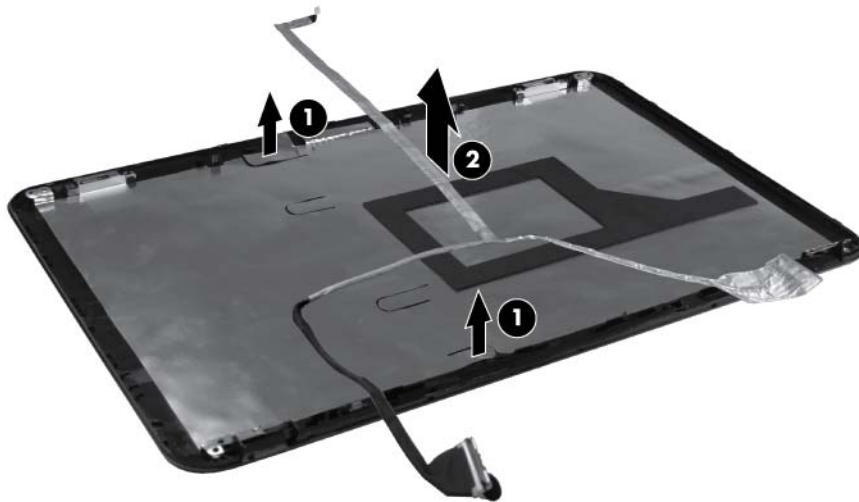

Reverse this procedure to install the display panel.

System board



NOTE: The system board spare part kit includes UMA or discrete graphics subsystem memory and replacement thermal material.

Description	Spare part number
For use in Intel HM55 UMA computer models	636370-001
For use in Intel HM65 UMA computer models	636373-001
For use in Intel HM55 discrete, 512 MB computer models	636371-001
For use in Intel HM55 discrete, 1 GB computer models	636372-001
For use in Intel HM65 discrete, 512 MB computer models	636374-001
For use in Intel HM65 discrete, 1 GB computer models	636375-001
For use in AMD UMA computer models	638856-001
For use in AMD discrete, 6470M, 512 MB computer models	638854-001
For use in AMD discrete, 6470M, 1 GB computer models	638855-001

When replacing the system board, be sure that the following components are removed from the defective system board and installed on the replacement system board:

- Memory modules (see [Memory module on page 51](#))
- WLAN module (see [WLAN module on page 49](#))

Before removing the system board, remove the following components:

1. Battery (see [Battery on page 43](#))
2. Service access cover (see [Service access cover on page 44](#))
3. Hard drive (see [Hard drive on page 45](#))
4. Optical drive (see [Optical drive on page 47](#))
5. WLAN module (see [WLAN module on page 49](#))
6. Memory module (see [Memory module on page 51](#))
7. Keyboard (see [Keyboard on page 52](#))
8. Top cover (see [Top cover on page 55](#))
9. USB board (see [USB board on page 62](#))
10. Display assembly (see [Display assembly on page 64](#))
11. Power connector (see [Power connector on page 63](#))
12. TouchPad LED board (see [TouchPad LED board on page 60](#))

Remove the system board:

1. Disconnect the optical drive connector from the system board (1) .
2. Remove the Phillips 5.0×2.0 screw (2) that secures the system board to the base enclosure.
3. Lift the system board (3) from the right edge and pull it away from the base enclosure at an angle.

For AMD computer models, see the following image.

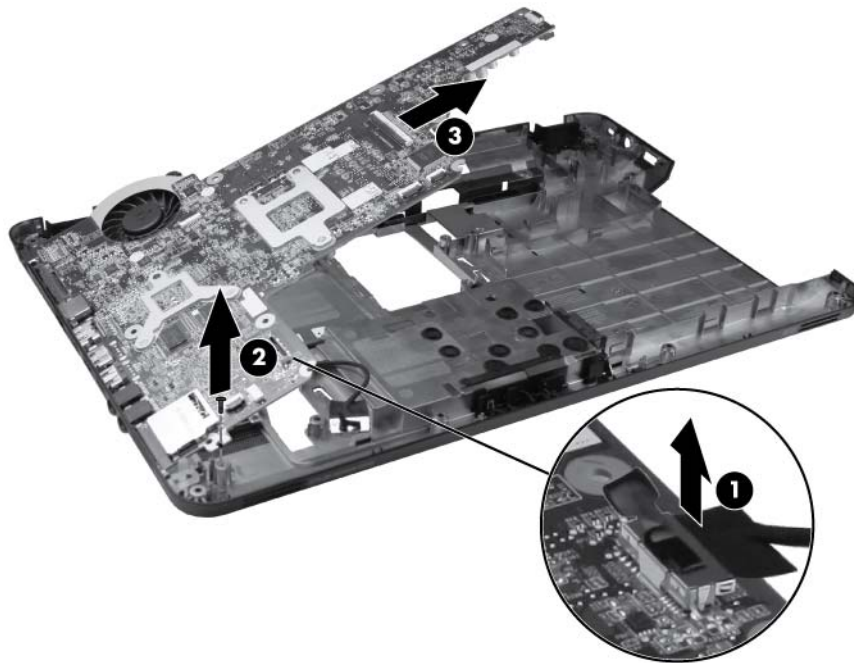

For Intel computer models, see the following image.

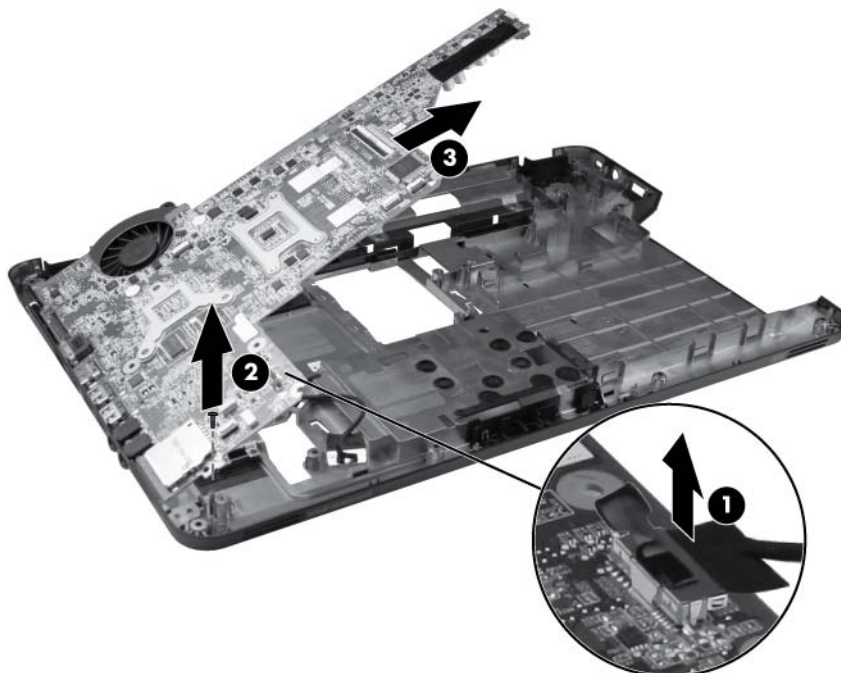

When replacing the system board, be sure that the following components are removed from the defective system board and installed on the replacement system board:

- Heat sink assembly (see [Heat sink assembly on page 75](#))
- Processor (see [Processor on page 79](#))

Reverse this procedure to install the system board.

RTC battery

Description	Spare part number
RTC battery (includes mounting adhesive)	637193-001

Before removing the RTC battery, remove the following components:

1. Battery (see [Battery on page 43](#))
2. Service access cover (see [Service access cover on page 44](#))
3. Hard drive (see [Hard drive on page 45](#))
4. Optical drive (see [Optical drive on page 47](#))
5. WLAN module (see [WLAN module on page 49](#))
6. Memory module (see [Memory module on page 51](#))
7. Keyboard (see [Keyboard on page 52](#))
8. Top cover (see [Top cover on page 55](#))
9. TouchPad LED board (see [TouchPad LED board on page 60](#))
10. USB board (see [USB board on page 62](#))
11. Power connector (see [Power connector on page 63](#))
12. Display assembly (see [USB board on page 62](#))
13. System board (see [System board on page 71](#))

Remove the RTC battery:

1. Position the system board face up, with the front toward you.
2. Disconnect the RTC battery connector from the system board **(1)**.
3. Remove the RTC battery **(2)**.

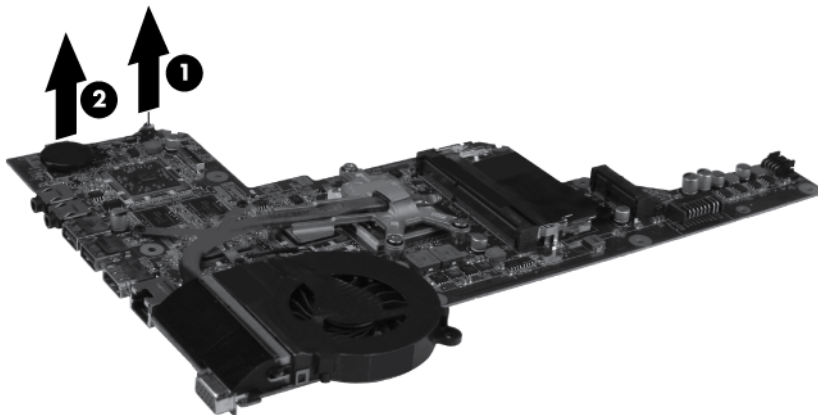

Reverse this procedure to install the RTC battery.

Heat sink assembly

 **NOTE:** The heat sink assembly includes replacement thermal material. The heat sink fan is available separately, using spare part number 639460-001.

Description	Spare part number
For use in AMD UMA computer models	639463-001
For use in Intel UMA HM55 computer models	637189-001
For use in Intel discrete HM55 computer models	637190-001
For use in AMD discrete computer models	639462-001

Before removing the heat sink assembly, remove the following components:

1. Battery (see [Battery on page 43](#))
2. Service access cover (see [Service access cover on page 44](#))
3. Hard drive (See [Hard drive on page 45](#))
4. Optical drive (see [Optical drive on page 47](#))
5. WLAN module (see [WLAN module on page 49](#))
6. Memory module (see [Memory module on page 51](#))
7. Keyboard (see [Keyboard on page 52](#))
8. Top cover (see [Top cover on page 55](#))
9. USB board (see [USB board on page 62](#))
10. Display assembly (see [Display assembly on page 64](#))
11. Power connector (see [Power connector on page 63](#))
12. System board (see [System board on page 71](#))

Remove the heat sink assembly (heat sink appearance may vary):

 **NOTE:** Steps 1 through 5 apply only to computer models equipped with Intel processors.

1. Position the system board right-side up, with the front toward you.
2. Disconnect the fan cable from the system board **(1)**.
3. Follow the sequence embossed on heat sink to loosen the seven Phillips 10.0×2.0 captive screws **(2)** that secure the heat sink assembly to the system board.

 **NOTE:** Due to the adhesive quality of the thermal material located between the heat sink assembly and system board components, it might be necessary to move the heat sink assembly from side to side to detach the assembly.

4. Remove the heat sink assembly (3) by lifting it straight up.

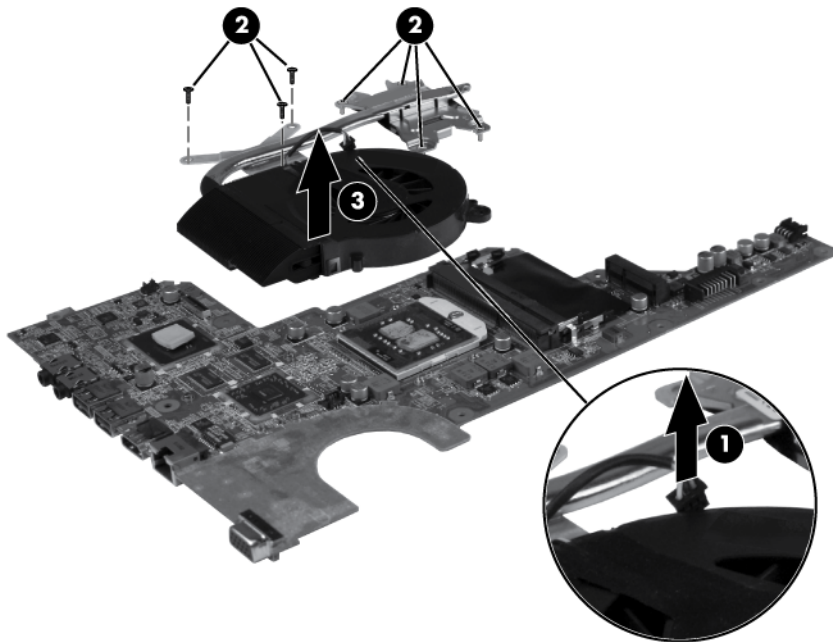

 **NOTE:** Steps 6 through 10 apply only to computer models equipped with AMD processors.

5. Position the system board right-side up, with the front toward you.
6. Disconnect the fan cable from the system board (1).
7. Remove the three Phillips 3.0×2.0 screws (2) that secure the heat sink assembly to the system board.

 **NOTE:** Due to the adhesive quality of the thermal material located between the heat sink assembly and system board components, it might be necessary to move the heat sink assembly from side to side to detach the assembly.

8. Follow the sequence embossed on the heat sink to loosen the three Phillips 10.0×2.0 captive screws (3) that secure the heat sink assembly to the system board.

9. Remove the heat sink assembly (4) by lifting straight up.

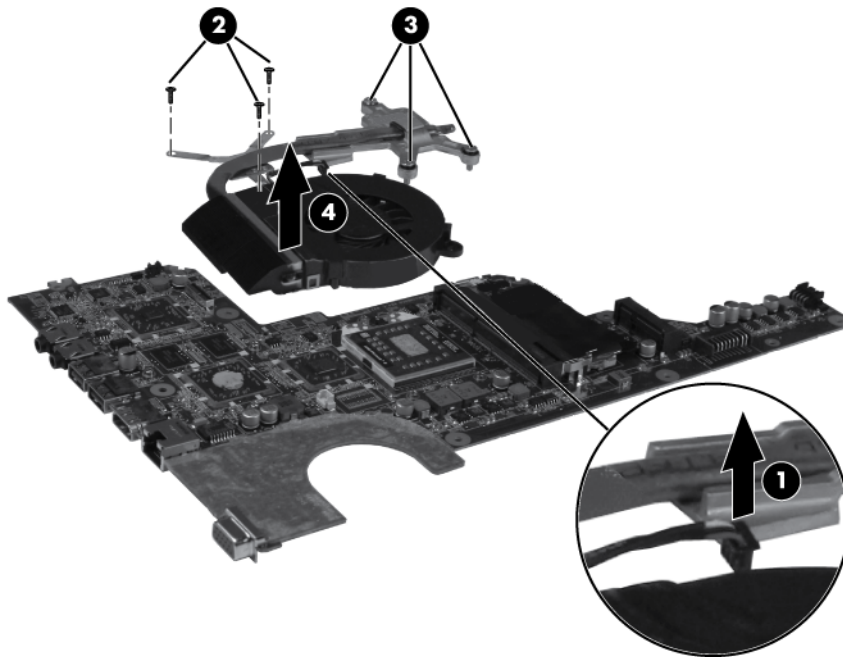

Each time the heat sink assembly is removed, the thermal material must be thoroughly cleaned from the system board at locations (1) and (2), from the heat sink assembly at locations (4) and (5), and from the processor (3). Thermal pads and thermal paste must be installed on all surfaces before the heat sink assembly is reinstalled.

 **NOTE:** Thermal pads and thermal paste are included with all heat sink assembly, system board, and processor spare part kits.

The following illustration shows the locations for thermal material on systems with Intel processors.

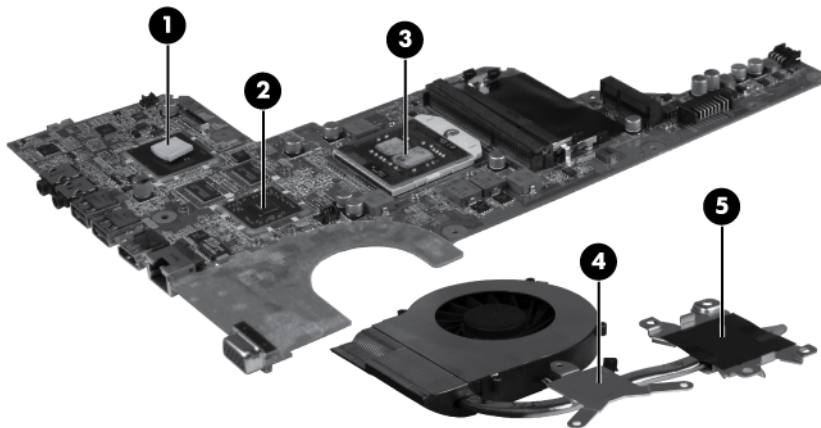

Each time the heat sink assembly is removed, the thermal material must be thoroughly cleaned from the system board at locations (1), (2), and (3), from the heat sink assembly at locations (5), (6), and (7), and from the processor (4). Thermal pads and thermal paste must be installed on all surfaces before the heat sink assembly is reinstalled.

The following illustration shows the locations for thermal material on systems with AMD processors.

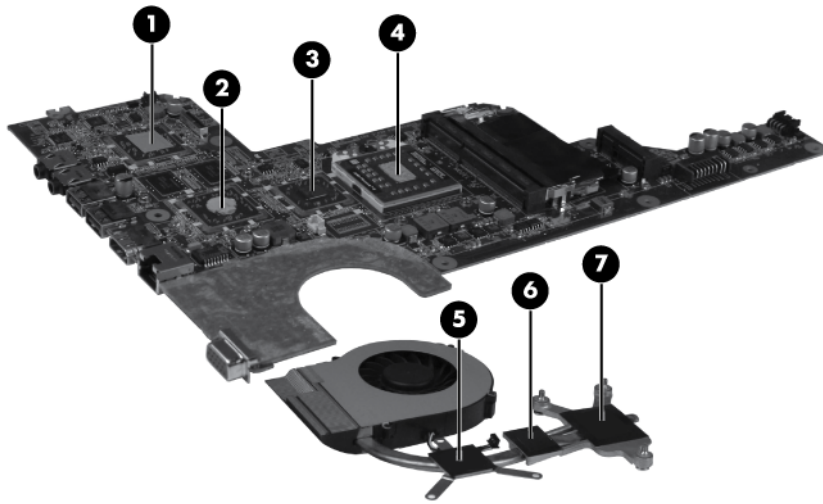

After applying fresh thermal paste to the components, reverse the above procedure to install the heat sink assembly.

Processor



NOTE: All processor spare part kits include thermal material.

Description	Spare part number
Intel Core™ i7-2620M processor (2.7 GHz, SC turbo up to 3.40 GHz, 4 MB L3), Dual 35 W	631252-001
Intel Core™ i5-2540M processor (2.6 GHz, SC turbo up to 3.3 GHz, 3 MB L3), Dual 35 W	631255-001
Intel Core™ i5-2520M processor (2.5 GHz, SC turbo up to 3.2 GHz, 3 MB L3), Dual 35 W	631253-001
Intel Core™ i5-2410M processor (2.3 GHz, SC turbo up to 2.9 GHz, 3 MB L3), Dual 35 W	638039-001
Intel Core i3 2310M (2.1 GHz, 3 MB L3) Dual 35 W	638037-001
Intel Core™ i5-480M processor (2.66 GHz, SC turbo up to 2.93 GHz, 3 MB L3), Dual 35 W	634693-001
Intel Core™ i3-390M processor (2.66 GHz, 3 MB L3), Dual 35 W	634692-001
Intel Core™ i3-380M processor (2.53 GHz, 3 MB L3), Dual 35 W	625823-001
Intel Pentium P6300 (2.26 GHz, 3 MB L3), Dual 35 W	635500-001
Intel Pentium P6200 (2.13 GHz, 3 MB L3), Dual 35 W	625831-001
Phenom II N970 (2.2GHz, 2MB L2, 1333MHz, 3.6GT/s –Quad 35W	635496-001
Phenom II P960 (1.8GHz, 2MB L2, 1066MHz, 3.6GT/s – Quad 25W	634689-001
Phenom II N870 (2.3GHz, 1.5MB L2, 1333MHz, 3.6GT/s –Triple 35W	635495-001
Phenom II P860 (2.0GHz, 1.5MB L2, 1066MHz, 3.6GT/s –Triple 25W	634688-001
Phenom II N850 (2.2GHz, 1.5MB L2, 1333MHz, 3.6GT/s –Triple 35W	616345-001
Phenom II N660 (3.0GHz, 2MB L2, 1333MHz, 3.6GT/s –Dual 35W	635494-001
Phenom II P650 (2.6GHz, 2MB L2, 1066MHz, 3.6GT/s – Dual 25W	634687-001
Turion II P560 (2.5GHz, 2MB L2, 1066MHz, 3.6GT/s–Dual 25W	634691-001
Athlon II P360 (2.3GHz, 1MB L2, 1066MHz, 3.6GT/s–Dual 25W	636635-001
Athlon II P340 (2.2GHz, 1MB L2, 1066MHz, 3.2GT/s–Dual 25W	616343-001
V160 (2.4GHz, 512K L2, 1066MHz, 3.2GT/s) – SC 25W	636634-001
V140 (2.3GHz, 512K L2, 1066MHz, 3.2GT/s) – SC 25W	616333-001

Before removing the processor, remove the following components:

1. Battery (see [Battery on page 43](#))
2. Service access cover (see [Service access cover on page 44](#))
3. Hard drive (See [Hard drive on page 45](#))
4. Optical drive (see [Optical drive on page 47](#))
5. WLAN module (see [WLAN module on page 49](#))
6. Memory module (see [Memory module on page 51](#))

7. Keyboard (see [Keyboard on page 52](#))
8. Top cover (see [Top cover on page 55](#))
9. USB board (see [USB board on page 62](#))
10. Display assembly (see [Display assembly on page 64](#))
11. Power connector (see [Power connector on page 63](#))
12. System board (see [System board on page 71](#))
13. Heat sink assembly (see [Heat sink assembly on page 75](#))

Remove the processor:

1. Turn the processor locking screw (1) one half-turn counterclockwise until you hear a click.
2. Lift the processor (2) straight up and remove it.

 **NOTE:** The gold triangle (3) on the processor must be aligned with the triangle icon (4) embossed on the processor socket when you install the processor.

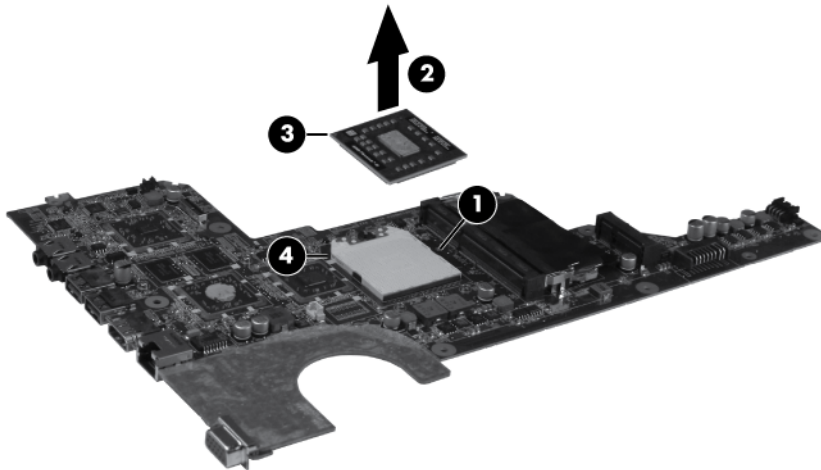

Reverse this procedure to install the processor.

5 Specifications

Computer specifications

Dimensions	
Depth	24.5 cm (9.6 in)
Width	37.4 cm (14.7 in)
Height (front to rear)	3.1 to 3.6 cm (1.2 to 1.4 in)
Weight (lowest weight configuration)	< 2.5 kg (5.5 lbs)
Input power	
Operating voltage	18.5 V dc @ 3.5 A - 65W
Operating current	3.5 A
Temperature	
Operating (not writing to optical disc)	0°C to 35°C (32°F to 95°F)
Operating (writing to optical disc)	5°C to 35°C (41°F to 95°F)
Nonoperating	-20°C to 60°C (-4°F to 140°F)
Relative humidity	
Operating	10% to 90%
Nonoperating	5% to 95%
Maximum altitude (unpressurized)	
Operating	-15 m to 3,048 m (-50 ft to 10,000 ft)
Nonoperating	-15 m to 12,192 m (-50 ft to 40,000 ft)
NOTE: Applicable product safety standards specify thermal limits for plastic surfaces. The computer operates well within this range of temperatures.	

39.6-cm (15.6-in) display specifications

Dimensions	
Height	21.0 cm (8.27 in)
Width	35.9 cm (14.1 in)
Diagonal	39.6 cm (15.6)
Number of colors	Up to 16.8 million
Contrast ratio	300:1 (typical)
Brightness	200 nits (typical)
Pixel resolution	
Pitch	0.259 × 0.259 mm
Format	1280 × 800; HD: 1366 × 768
Configuration	RGB vertical stripe
Backlight	LED
Character display	80 × 25
Total power consumption	4.0 W
Viewing angle	±40° horizontal, +120/-40° vertical (typical)

Hard drive specifications

	750 GB*	640 GB*	500 GB*	320 GB*	250 GB*
Dimensions					
Height	9.5 mm	9.5 mm	9.5 mm	9.5 mm	9.5 mm
Width	70 mm	70 mm	70 mm	70 mm	70 mm
Weight	101 g	101 g	101 g	101 g	101 g
Interface type	SATA	SATA	SATA	SATA	SATA
Transfer rate	100 MB/sec	106 MB/sec	100 MB/sec	100 MB/sec	100 MB/sec
Security	ATA security	ATA security	ATA security	ATA security	ATA security
Seek times (typical read, including setting)					
Single track	1.5 ms	1.0 ms	1.0 ms	1.5 ms	2.0 ms
Average	11.0 ms	14.0 ms	14.0 ms	12.0 ms	12.0 ms
Maximum	22.0 ms	24.0 ms	22.0 ms	22.0 ms	22.0 ms
Logical blocks	312,581,808	1,250,263,728	976,773,168	625,142,448	488,397,168
Disc rotational speed	7200 rpm	5400 rpm	5400 and 7200 rpm	7200 rpm	7200 rpm
Operating temperature	5°C to 55°C (41°F to 131°F)				
*1 GB = 1 billion bytes when referring to hard drive storage capacity. Actual accessible capacity is less. Actual drive specifications may differ slightly.					
NOTE: Certain restrictions and exclusions apply. Contact technical support for details.					

DVD±RW and CD-RW SuperMulti Double-Layer Combo Drive specifications

Applicable disc	
Read	CD-DA, CD+(E)G, CD-MIDI, CD-TEXT, CD-ROM, CD-ROM XA, MIXED MODE CD, CD-I, CD-I Bridge (Photo-CD, Video CD), Multisession CD (Photo-CD, CD-EXTRA, Portfolio, CD-R, CD-RW), CD-R, CD-RW, DVD-ROM (DVD-5, DVD-9, DVD-10, DVD-18), DVD-R, DVD-RW, DVD+R, DVD+RW, DVD-RAM
Write	CD-R and CD-RW, DVD+R, DVD+RW, DVD-R, DVD-RW, DVD-RAM
Random access time	
DVD	< 230 ms
CD	< 175 ms
Cache buffer	2 MB
Data transfer rate	
24X CD-ROM	3,600 KB/sec
8X DVD-ROM	10,800 KB/sec
24X CD-R	3,600 KB/sec
16X CD-RW	2,400 KB/sec
8X DVD+R	10,800 KB/sec
4X DVD+RW	5,400 KB/sec
8X DVD-R	10,800 KB/sec
4X DVD-RW	5,400 KB/sec
2.4X DVD+R(9)	2,700 KB/sec
5X DVD-RAM	6,750 KB/sec
Transfer mode	Multiword DMA Mode

Blu-ray Disc ROM and DVD±R/RW SuperMulti Double-Layer Drive specifications

Applicable disc	
Read	BD-ROM, BD-ROM-DL, BD-R, BD-R-DL, BD-RE, BD-RE-DL, DVD-ROM, DVD+R, DVD+R-DL, DVD+RW, DVD-R, DVD-R-DL, DVD-RW, DVD-RAM (Ver.2), CD-DA, CD-ROM (mode 1 and mode 2), CD-ROM XA (mode 2, form 1 and form 2), Photo CD (single and multiple sessions), CD Extra, CD-R, CD-RW, and CD-TEXT
Write	DVD-RAM (Ver.2), DVD+R, DVD-R, CD-R, and CD-ROM
Random access time	
BD	< 230 ms
DVD	< 180 ms
CD	< 180 ms
Cache buffer	4.5 MB
Data transfer rate	
24X CD-ROM	3,600 KB/sec
8X DVD-ROM	10,800 KB/sec
4X BD	18,000 KB/sec
24X CD-R	3,600 KB/sec
16X CD-RW	2,400 KB/sec
8X DVD+R	10,800 KB/sec
4X DVD+RW	5,400 KB/sec
8X DVD-R	10,800 KB/sec
4X DVD-RW	5,400 KB/sec
2.4X DVD+R(9)	2,700 KB/sec
5X DVD-RAM	6,750 KB/sec
1X BD-ROM	4,500 KB/sec
1X BD-R read	4,500 KB/sec
1X BD-RE read	4,500 KB/sec
Transfer mode	Multiword DMA Mode

6 Setup Utility (BIOS)

Setup Utility, or Basic Input/Output System (BIOS), controls communication between all the input and output devices on the system (such as disk drives, display, keyboard, mouse, and printer). Setup Utility includes settings for the types of peripherals installed, the startup sequence of the computer, and the amount of system and extended memory.

 **CAUTION:** Use extreme care when making changes in Setup Utility. Errors can prevent the computer from operating properly.

Starting Setup Utility

 **NOTE:** The fingerprint reader (select models only) cannot be used to access Setup Utility.

- ▲ Turn on or restart the computer. While the “Press the ESC key for Startup Menu” message is displayed in the lower-left corner of the screen, press **esc**. When the Startup Menu is displayed, press **f10**.

Using Setup Utility

Changing the language of Setup Utility

1. Start Setup Utility.
2. Use the arrow keys to select **System Configuration > Language**, and then press **enter**.
3. Use the arrow keys to select a language, and then press **enter**.
4. When a confirmation prompt with your language selected is displayed, press **enter**.
5. To save your change and exit Setup Utility, use the arrow keys to select **Exit > Exit Saving Changes**, and then press **enter**.

Your change takes effect immediately.

Navigating and selecting in Setup Utility

Because Setup Utility is not Windows based, it does not support the TouchPad. Navigation and selection are by keystroke.

- To choose a menu or a menu item, use the arrow keys.
- To choose an item in a list or to toggle a field—for example an Enable/Disable field—use either the arrow keys or **f5** and **f6**.
- To select an item, press **enter**.
- To close a text box or return to the menu display, press **esc**.
- To display additional navigation and selection information while Setup Utility is open, press **f1**.

Displaying system information

1. Start Setup Utility.
2. Select the **Main** menu. System information such as the system time and date, and identification information about the computer is displayed.
3. To exit Setup Utility without changing any settings, use the arrow keys to select **Exit > Exit Discarding Changes**, and then press **enter**.

Restoring factory default settings in Setup Utility

1. Start Setup Utility.
2. Use the arrow keys to select **Exit > Load Setup Defaults**, and then press **enter**.
3. When the Setup Confirmation is displayed, press **enter**.
4. To save your change and exit Setup Utility, use the arrow keys to select **Exit > Exit Saving Changes**, and then press **enter**.

The Setup Utility factory settings take effect when the computer restarts.



NOTE: Your password, security, and language settings are not changed when you restore the factory settings.

Exiting Setup Utility

- To exit Setup Utility and save your changes from the current session:
If the Setup Utility menus are not visible, press **esc** to return to the menu display. Then use the arrow keys to select **Exit > Exit Saving Changes**, and then press **enter**.
- To exit Setup Utility without saving your changes from the current session:
If the Setup Utility menus are not visible, press **esc** to return to the menu display. Then use the arrow keys to select **Exit > Exit Discarding Changes**, and then press **enter**.

Updating the BIOS

Updated versions of the BIOS may be available on the HP Web site.

Most BIOS updates on the HP Web site are packaged in compressed files called *SoftPaqs*.

Some download packages contain a file named *Readme.txt*, which contains information regarding installing and troubleshooting the file.

Determining the BIOS version

To determine whether available BIOS updates contain later BIOS versions than those currently installed on the computer, you need to know the version of the system BIOS currently installed.

BIOS version information (also known as *ROM date* and *System BIOS*) can be displayed by pressing **fn+esc** (if you are already in Windows) or by using Setup Utility.

1. Start Setup Utility.
2. If the system information is not displayed, use the arrow keys to select the **Main** menu.
BIOS and other system information is displayed.
3. To exit Setup Utility, use the arrow keys to select **Exit > Exit Discarding Changes**, and then press **enter**.

Downloading a BIOS update

 **CAUTION:** To reduce the risk of damage to the computer or an unsuccessful installation, download and install a BIOS update only when the computer is connected to reliable external power using the AC adapter. Do not download or install a BIOS update while the computer is running on battery power, docked in an optional docking device, or connected to an optional power source. During the download and installation, follow these instructions:

Do not disconnect power from the computer by unplugging the power cord from the AC outlet.

Do not shut down the computer or initiate Sleep or Hibernation.

Do not insert, remove, connect, or disconnect any device, cable, or cord.

1. Access the page on the HP Web site that provides software for your computer:

Windows 7—Select **Start > Help and Support > Maintain**.

Windows XP—Select **Start > Help and Support**, and then select the software and drivers update.

2. Follow the on-screen instructions to identify your computer and access the BIOS update you want to download.

3. At the download area, follow these steps:

a. Identify the BIOS update that is later than the BIOS version currently installed on your computer. Make a note of the date, name, or other identifier. You may need this information to locate the update later, after it has been downloaded to your hard drive.

b. Follow the on-screen instructions to download your selection to the hard drive.

Make a note of the path to the location on your hard drive where the BIOS update is downloaded. You will need to access this path when you are ready to install the update.

 **NOTE:** If you connect your computer to a network, consult the network administrator before installing any software updates, especially system BIOS updates.

BIOS installation procedures vary. Follow any instructions that are displayed on the screen after the download is complete. If no instructions are displayed, follow these steps:

1. **Windows 7**—Open Windows Explorer by selecting **Start > Computer**.

Windows XP—Open Windows Explorer by selecting **Start > My Computer**.

2. Double-click your hard drive designation. The hard drive designation is typically Local Disk (C:).

3. Using the hard drive path you recorded earlier, open the folder on your hard drive that contains the update.

4. Double-click the file that has an .exe extension (for example, *filename.exe*).

The BIOS installation begins.

5. Complete the installation by following the on-screen instructions.

 **NOTE:** After a message on the screen reports a successful installation, you can delete the downloaded file from your hard drive.

7 Backup and recovery

- [Restore](#)
- [Creating restore media](#)
- [Performing a system restore](#)
- [Backing up and recovering your information](#)

Your computer includes tools provided by the operating system and HP to help you safeguard your information and restore it if ever needed.

This chapter provides information on the following topics:

- Creating a set of recovery discs or a recovery flash drive (HP Recovery Manager software feature)
- Performing a system restore (from the partition, recovery discs, or a recovery flash drive)
- Backing up your information
- Recovering a program or driver

Restore

In the event of hard drive failure, to restore your system to its factory image you will need a set of recovery discs or a recovery flash drive that you can create using HP Recovery Manager. HP recommends that you use this software to create either a set of recovery discs or a recovery flash drive immediately after software setup.

If for some other reason you need to restore your system, this can be achieved using the HP Recovery partition (select models only), without the need for recovery discs or a recovery flash drive. To check for the presence of a recovery partition, click **Start**, right-click **Computer**, click **Manage**, and then click **Disk Management**. If the recovery partition is present, a Recovery drive is listed in the window.

 **CAUTION:** HP Recovery Manager (partition or discs/flash drive) restores only software that was preinstalled at the factory. Software not provided with this computer must be reinstalled manually.

 **NOTE:** Recovery discs have been included if your computer does not have a recovery partition.

Creating restore media

HP recommends that you create either a set of recovery discs or a recovery flash drive to be sure that you can restore your computer to its original factory state if the hard drive fails, or if for any reason you cannot restore using the recovery partition tools. Create these discs or the flash drive after setting up the computer for the first time.

 **NOTE:** HP Recovery Manager allows the creation of only one set of recovery discs or one recovery flash drive. Handle these discs or flash drive carefully and keep them in a safe place.

 **NOTE:** If your computer does not include an integrated optical drive, you can use an optional external optical drive (purchased separately) to create recovery discs, or you can purchase recovery discs for your computer from the HP Web site. If you use an external optical drive, it must be connected directly to a USB port on the computer, not to a USB port on an external device, such as a USB hub.

Guidelines:

- Purchase high-quality DVD-R, DVD+R, DVD-R DL, or DVD+R DL discs.

 **NOTE:** Read-write discs, such as CD-RW, DVD±RW, double-layer DVD±RW, and BD-RE (rewritable Blu-ray) discs, are not compatible with the HP Recovery Manager software.

- The computer must be connected to AC power during this process.
- Only one set of recovery discs or one recovery flash drive can be created per computer.

 **NOTE:** If you are creating recovery discs, number each disc before inserting it into the optical drive.

- If necessary, you can exit the program before you have finished creating the recovery discs or recovery flash drive. The next time you open HP Recovery Manager, you will be prompted to continue the backup creation process.

To create a set of recovery discs or a recovery flash drive:

1. Select **Start > All Programs > HP > HP Recovery Manager > HP Recovery Media Creation**.
2. Follow the on-screen instructions.

Performing a system restore

HP Recovery Manager software allows you to repair or restore the computer to its original factory state. HP Recovery Manager works from recovery discs, a recovery flash drive, or from a dedicated recovery partition (select models only) on the hard drive.

 **NOTE:** A system restore needs to be performed if the computer hard drive has failed or if all attempts to correct any functional computer issues fail. A system restore should be used as a final attempt to correct computer issues.

Note the following when performing a system restore:

- You can restore only the system that you have previously backed up. HP recommends that you use Recovery Manager to create either a set of recovery discs or a recovery flash drive as soon as you set up the computer.
- Windows has its own built-in repair features, such as System Restore. If you have not already tried these features, try them before using HP Recovery Manager.
- HP Recovery Manager restores only software that was preinstalled at the factory. Software not provided with this computer must be downloaded from the manufacturer's Web site or reinstalled from the disc provided by the manufacturer.

Restoring using the dedicated recovery partition (select models only)

When using the dedicated recovery partition, there is an option to back up pictures, music and other audio, videos and movies, recorded TV shows, documents, spreadsheets and presentations, e-mails, Internet favorites and settings during this process.

To restore the computer from the recovery partition, follow these steps:

1. Access HP Recovery Manager in either of the following ways:
 - Select **Start > All Programs > HP > HP Recovery Manager > HP Recovery Manager**.
 - or –
 - Turn on or restart the computer, and then press **esc** while the “Press the ESC key for Startup Menu” message is displayed at the bottom of the screen. Then, press **f11** while the “F11 (System Recovery)” message is displayed on the screen.
2. Click **System Recovery** in the **HP Recovery Manager** window.
3. Follow the on-screen instructions.

Restoring using the restore media

1. If possible, back up all personal files.
2. Insert the first recovery disc into the optical drive on your computer or an optional external optical drive, and then restart the computer.

– or –

Insert the recovery flash drive into a USB port on your computer, and then restart the computer.

 **NOTE:** If the computer does not automatically restart in the HP Recovery Manager, the computer boot order needs to be changed.

3. Press **f9** at system bootup.
4. Select the optical drive or the flash drive.
5. Follow the on-screen instructions.

Changing the computer boot order

To change the boot order for recovery discs:

1. Restart the computer.
2. Press **esc** while the computer is restarting, and then press **f9** for boot options.
3. Select **Internal CD/DVD ROM Drive** from the boot options window.

To change the boot order for recovery flash drive:

1. Insert the flash drive into a USB port.
2. Restart the computer.
3. Press **esc** while the computer is restarting, and then press **f9** for boot options.
4. Select the flash drive from the boot options window.

Backing up and recovering your information

It is very important to back up your files and keep any new software in a safe place. As you add new software and data files, continue to create backups on a regular basis.

How completely you are able to recover your system depends on how recent your backup is.



NOTE: A recovery from your most recent backup needs to be performed if the computer has a virus attack or if any major system components fail. In order to correct computer issues, a recovery should first be attempted before a system restore is attempted.

You can back up your information to an optional external hard drive, a network drive, or discs. Back up your system at the following times:

- At regularly scheduled times



TIP: Set reminders to back up your information periodically.

- Before the computer is repaired or restored
- Before you add or modify hardware or software

Guidelines:

- Create system restore points using the Windows® System Restore feature, and periodically copy them to an optical disc or an external hard drive. For more information on using system restore points, refer to [Using Windows system restore points on page 96](#).
- Store personal files in the Documents library and back up this folder periodically.
- Save customized settings in a window, toolbar, or menu bar by taking a screen shot of your settings. The screen shot can be a time-saver if you have to re-enter your preferences.

To create a screen shot:

1. Display the screen you want to save.
2. Copy the screen image:

To copy only the active window, press **alt+fn+prt sc**.

To copy the entire screen, press **fn+prt sc**.

3. Open a word-processing document, and then select **Edit > Paste**. The screen image is added to the document.
4. Save and print the document.

Using Windows Backup and Restore

Guidelines:

- Be sure that the computer is connected to AC power before you start the backup process.
- Allow enough time to complete the backup process. Depending on file sizes, it may take over an hour.

To create a backup:

1. Select **Start > Control Panel > System and Security > Backup and Restore**.
2. Follow the on-screen instructions to schedule and create a backup.



NOTE: Windows® includes the User Account Control feature to improve the security of the computer. You may be prompted for your permission or password for tasks such as installing software, running utilities, or changing Windows settings. Refer to Help and Support for more information.

Using Windows system restore points

A system restore point allows you to save and name a snapshot of your hard drive at a specific point in time. You can then recover back to that point if you want to reverse subsequent changes.



NOTE: Recovering to an earlier restore point does not affect data files saved or e-mails created since the last restore point.

You also can create additional restore points to provide increased protection for your files and settings.

When to create restore points

- Before you add or modify software or hardware
- Periodically, whenever the computer is functioning optimally



NOTE: If you revert to a restore point and then change your mind, you can reverse the restoration.

Create a system restore point

1. Select **Start > Control Panel > System and Security > System**.
2. In the left pane, click **System Protection**.
3. Click the **System Protection** tab.
4. Follow the on-screen instructions.

Restore to a previous date and time

To revert to a restore point (created at a previous date and time), when the computer was functioning optimally, follow these steps:

1. Select **Start > Control Panel > System and Security > System**.
2. In the left pane, click **System Protection**.
3. Click the **System Protection** tab.
4. Click **System Restore**.
5. Follow the on-screen instructions.

8 Power cord set requirements

The wide range input feature of the computer permits it to operate from any line voltage from 100 to 120 volts AC or from 220 to 240 volts AC.

The 3-conductor power cord set included with the computer meets the requirements for use in the country or region where the equipment is purchased.

Power cord sets for use in other countries or regions must meet the requirements of the country or region where the computer is used.

Requirements for all countries or regions

The requirements listed below are applicable to all countries or regions:

- The length of the power cord set must be at least **1.5 m** (5.0 ft) and no more than **2.0 m** (6.5 ft).
- All power cord sets must be approved by an acceptable accredited agency responsible for evaluation in the country or region where the power cord set will be used.
- The power cord sets must have a minimum current capacity of 10 amps and a nominal voltage rating of 125 or 250 V AC, as required by each country or region's power system.
- The appliance coupler must meet the mechanical configuration of an EN 60 320/IEC 320 Standard Sheet C13 connector for mating with the appliance inlet on the back of the computer.

Requirements for specific countries or regions

Country/region	Accredited agency	Applicable note number
Australia	EANSW	1
Austria	OVE	1
Belgium	CEBC	1
Canada	CSA	2
Denmark	DEMKO	1
Finland	FIMKO	1
France	UTE	1
Germany	VDE	1
Italy	IMQ	1
Japan	METI	3
The Netherlands	KEMA	1
Norway	NEMKO	1
The People's Republic of China	CCC	5
South Korea	EK	4
Sweden	SEMKO	1
Switzerland	SEV	1
Taiwan	BSMI	4
The United Kingdom	BSI	1
The United States	UL	2

1. The flexible cord must be Type HO5VV-F, 3-conductor, 1.0-mm² conductor size. Power cord set fittings (appliance coupler and wall plug) must bear the certification mark of the agency responsible for evaluation in the country or region where it will be used.
2. The flexible cord must be Type SPT-3 or equivalent, No. 18 AWG, 3-conductor. The wall plug must be a two-pole grounding type with a NEMA 5-15P (15 A, 125 V) or NEMA 6-15P (15 A, 250 V) configuration.
3. The appliance coupler, flexible cord, and wall plug must bear a "T" mark and registration number in accordance with the Japanese Dentori Law. The flexible cord must be Type VCT or VCTF, 3-conductor, 1.00-mm² conductor size. The wall plug must be a two-pole grounding type with a Japanese Industrial Standard C8303 (7 A, 125 V) configuration.
4. The flexible cord must be Type RVV, 3-conductor, 0.75-mm² conductor size. Power cord set fittings (appliance coupler and wall plug) must bear the certification mark of the agency responsible for evaluation in the country or region where it will be used.
5. The flexible cord must be Type VCTF, 3-conductor, 0.75-mm² conductor size. Power cord set fittings (appliance coupler and wall plug) must bear the certification mark of the agency responsible for evaluation in the country or region where it will be used.

9 Recycling

Battery

When a battery has reached the end of its useful life, do not dispose of the battery in general household waste. Follow the local laws and regulations in your area for computer battery disposal.

Display

⚠ WARNING! The backlight contains mercury. Exercise caution when removing and handling the backlight to avoid damaging this component and causing exposure to the mercury.

⚠ CAUTION: The procedures in this chapter can result in damage to display components. The only components intended for recycling purposes are the liquid crystal display (LCD) panel and the backlight. When you remove these components, handle them carefully.

📝 NOTE: Materials Disposal. This HP product contains mercury in the backlight in the display assembly that might require special handling at end-of-life. Disposal of mercury might be regulated because of environmental considerations. For disposal or recycling information, contact your local authorities, or see the Electronic Industries Alliance (EIA) Web site at <http://www.eiae.org>.

This section provides disassembly instructions for the display assembly. The display assembly must be disassembled to gain access to the backlight **(1)** and the liquid crystal display (LCD) panel **(2)**.



📝 NOTE: The procedures provided in this chapter are general disassembly instructions. Specific details, such as screw sizes, quantities, and locations, and component shapes and sizes, can vary from one computer model to another.

Perform the following steps to disassemble the display assembly:

1. Remove all screw covers (1) and screws (2) that secure the display bezel to the display assembly.

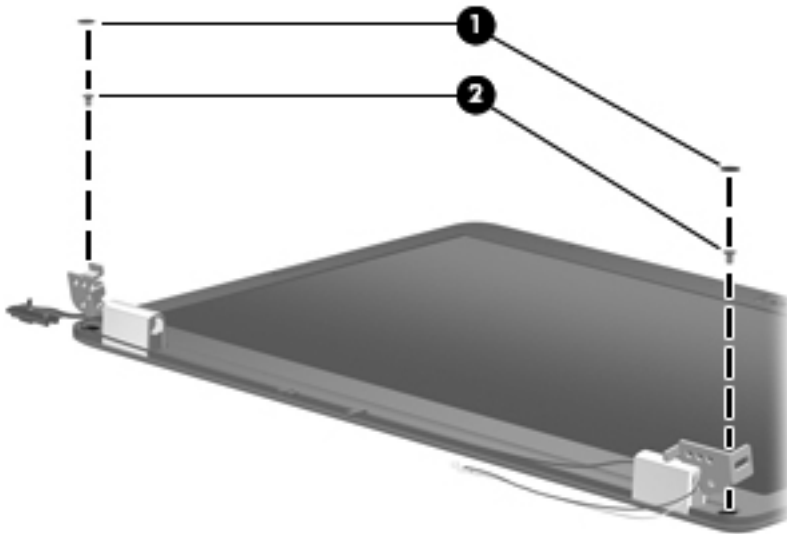

2. Lift up and out on the inside edges of the bezel on the left side (1), the top and bottom (2), and the right side (3) until the bezel disengages from the display assembly.
3. Remove the display bezel (4).

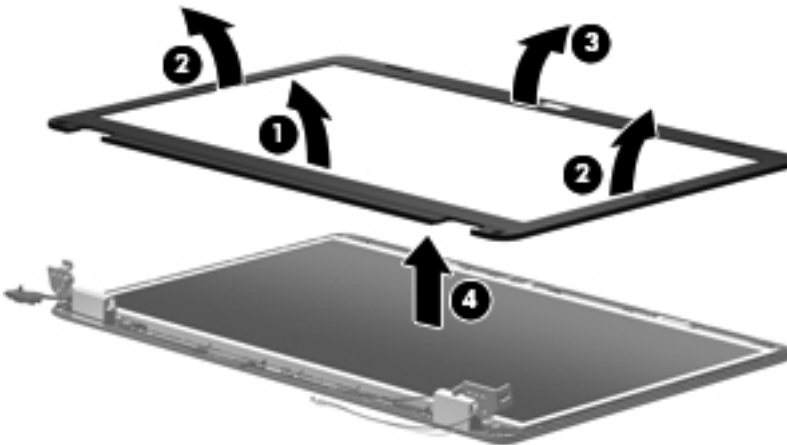

4. Remove the two screws (1) that secure each hinge to the display enclosure and lift up to remove the display hinge covers (2).

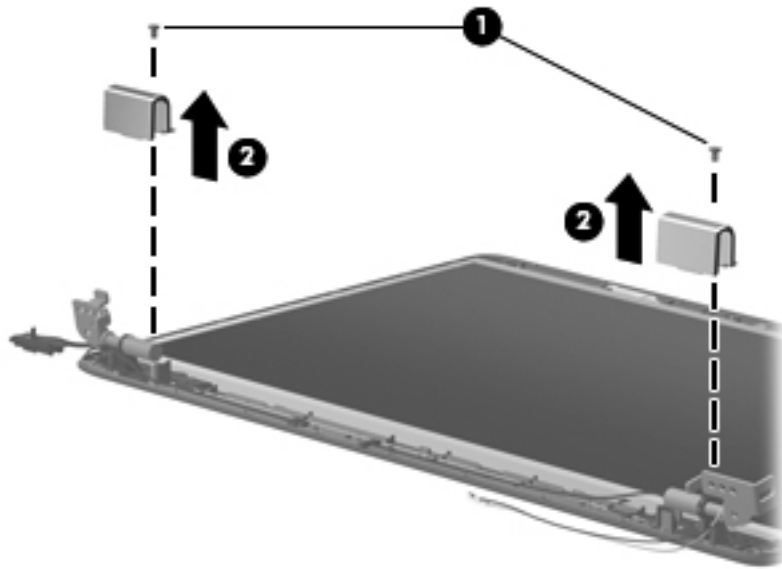

5. Remove all screws (1) that secure the display panel assembly to the display enclosure.
6. Remove the display panel assembly (2) from the display enclosure.

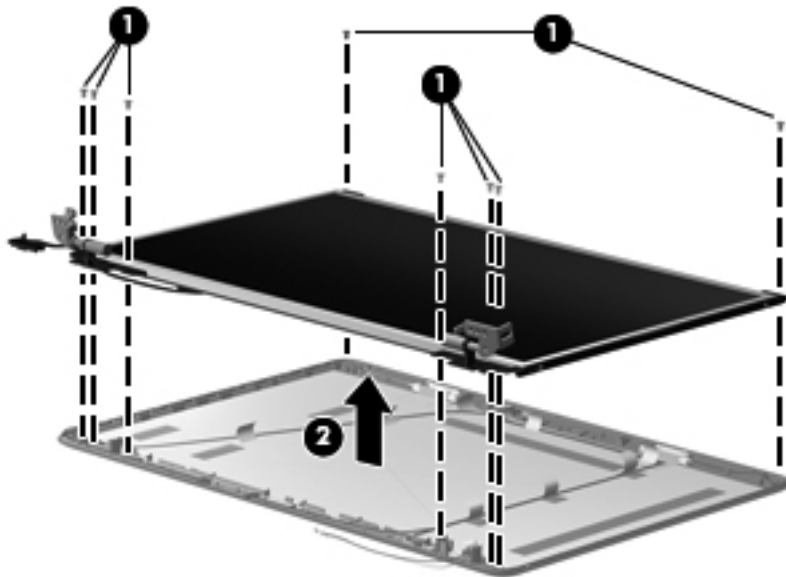

7. Turn the display panel assembly upside down and remove all screws that secure the display panel frame to the display panel.

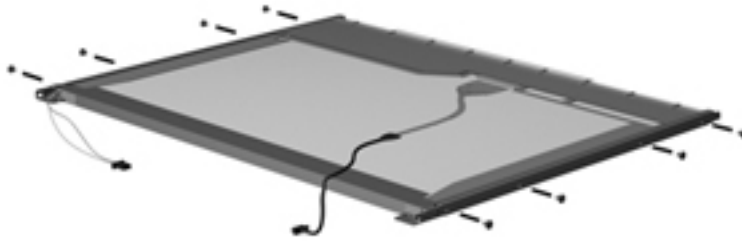

8. Use a sharp-edged tool to cut the tape (1) that secures the sides of the display panel to the display panel frame.
9. Remove the display panel frame (2) from the display panel.

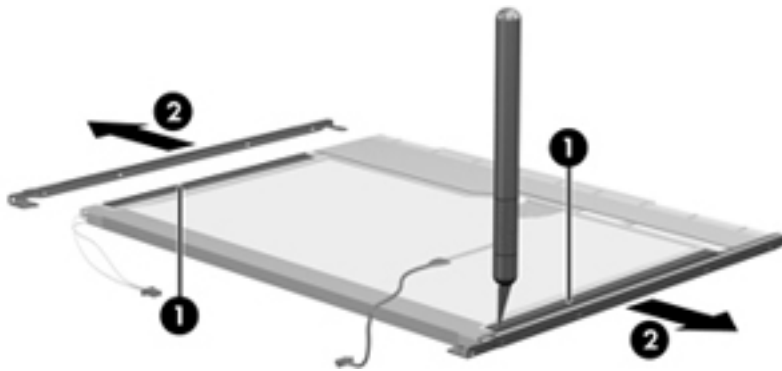

10. Remove the screws (1) that secure the backlight cover to the display panel.
11. Lift the top edge of the backlight cover (2) and swing it outward.

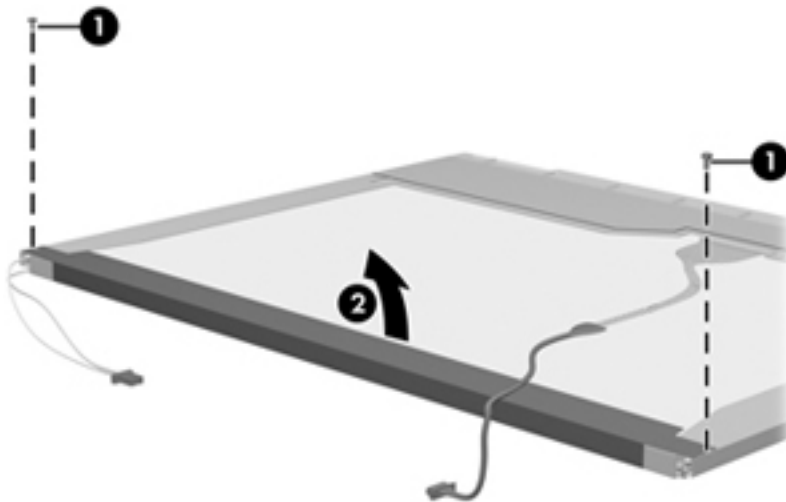

12. Remove the backlight cover.
13. Turn the display panel right-side up.

14. Remove the backlight cables (1) from the clip (2) in the display panel.

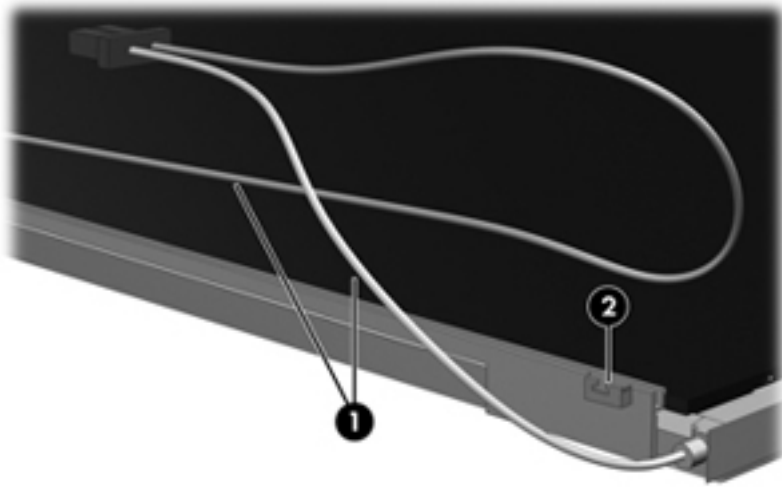

15. Turn the display panel upside down.
16. Remove the backlight frame from the display panel.

⚠ WARNING! The backlight contains mercury. Exercise caution when removing and handling the backlight to avoid damaging this component and causing exposure to the mercury.

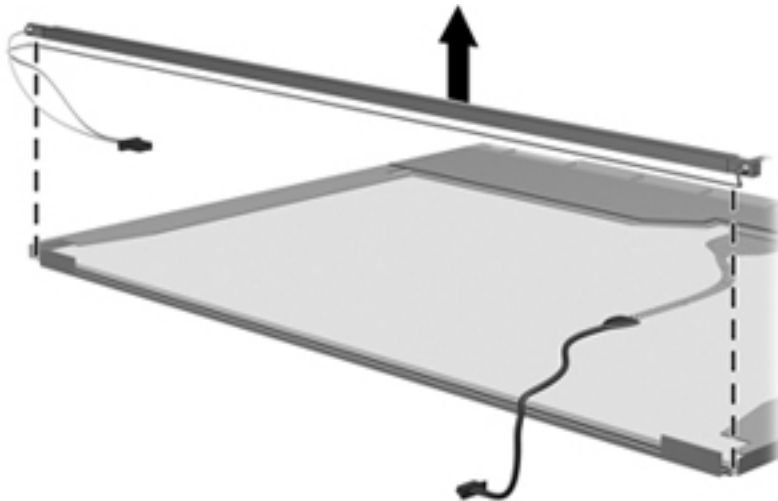

17. Remove the backlight from the backlight frame.

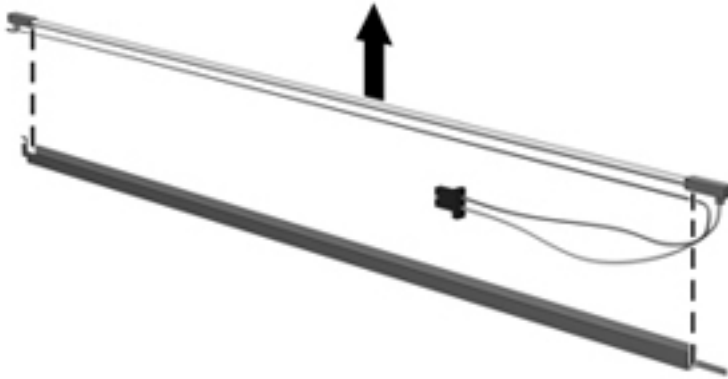

18. Disconnect the display cable (1) from the LCD panel.
19. Remove the screws (2) that secure the LCD panel to the display rear panel.
20. Release the LCD panel (3) from the display rear panel.
21. Release the tape (4) that secures the LCD panel to the display rear panel.

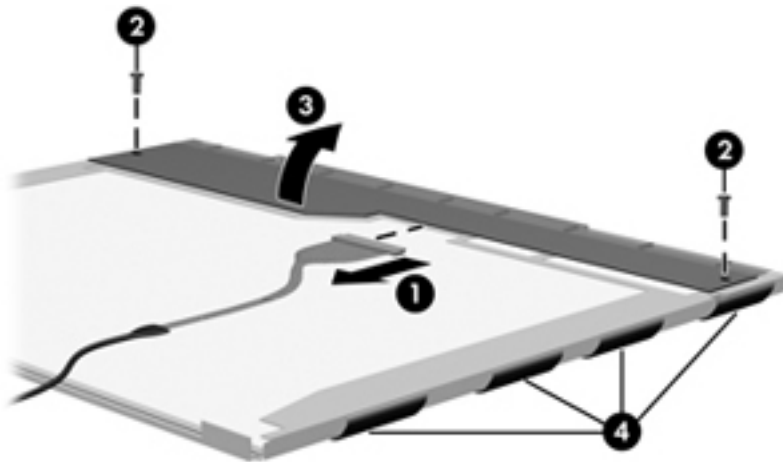

22. Remove the LCD panel.

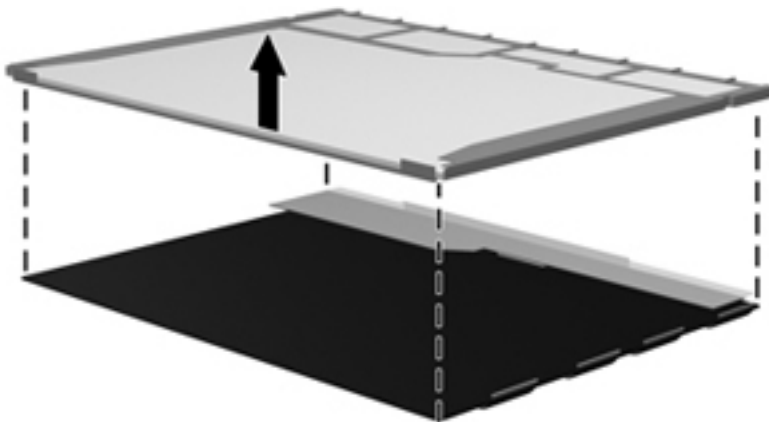

23. Recycle the LCD panel and backlight.

Index

A

- AC adapter light, identifying 12
- AC adapter, spare part numbers 27
- action keys, identifying 10
- antenna
 - removal 69
 - spare part number 24
- audio, product description 4
- audio-in (microphone) jack, identifying 13
- audio-out (headphone) jack, identifying 13

B

- backing up
 - customized window, toolbar, and menu bar settings 94
 - personal files 94
- base enclosure, spare part number 22
- battery
 - removal 43
 - spare part numbers 23, 43
- battery bay 16
- battery release latch 16
- bezel
 - spare part number 24, 66
- BIOS
 - determining version 88
 - downloading an update 89
 - updating 88
- Blu-ray Disc ROM and DVD±R/RW SuperMulti Double-Layer Drive
 - removal 47
 - spare part number 47
 - specifications 85

- Blu-ray ROM and DVD±R/RW SuperMulti Double-Layer Drive
 - spare part number 26
- buttons
 - left TouchPad 7
 - power 9
 - right TouchPad 7

C

- cables, service considerations 37
- camera module
 - removal 67
 - spare part number 67
- camera, product description 4
- caps lock light, identifying 8
- chipset, product description 2
- components
 - bottom 16
 - buttons 9
 - display 15
 - front 7, 11
 - keys 10
 - left side 13
 - lights 8
 - right side 12
 - top 7
- computer feet
 - locations 42
 - spare part number 42
- computer specifications 81
- connector, power 12
- connectors, service considerations 37

D

- default settings, restoring 87

- digital media slot, identifying
 - MultiMedia Card (MMC) 14
 - Secure Digital (SD) Memory Card 14
- diskette drive, precautions 37
- display assembly
 - removal 64
 - spare part number 19, 64
- display back cover, spare part number 24
- display bezel
 - illustrated 24
 - spare part number 24, 66
- display cable, spare part number 24
- display component recycling 99
- display components
 - illustrated 24
 - spare part numbers 24
- display enclosure, illustrated 24
- display hinge kit, spare part number 24
- display hinges
 - removal 69
 - spare part number 69
- display panel
 - illustrated 24
 - product description 2
 - removal 69
 - spare part number 24, 35, 69
- display specifications 82
- drives, preventing damage 37
- DVD±RW and CD-RW Combo Drive
 - removal 47
- DVD±RW and CD-RW SuperMulti Double-Layer Combo Drive
 - precautions 37

- spare part numbers 26, 47
 - specifications 84
- E**
- electrostatic discharge 38
- esc key, identifying 10
- Ethernet, product description 4
- external media cards, product description 4
- external monitor port, identifying 13
- F**
- f11 92
- factory settings, restoring 87
- feet
 - locations 42
 - spare part number 42
- fn key, identifying 10
- front components 7
- G**
- graphics, product description 2
- grounding equipment and methods 40
- H**
- hard drive
 - precautions 37
 - product description 3
 - removal 45
 - spare part numbers 23, 26, 45
 - specifications 83
- Hard Drive Hardware Kit, spare part number 26
- hard drive light, identifying 14
- HDMI port, identifying 13
- headphone (audio-out) jack 13
- heat sink assembly
 - removal 75
 - spare part number 22, 75
- HP Recovery Manager 92
- I**
- integrated webcam light, identifying 15
- internal microphone, identifying 15

- J**
- jacks
 - audio-in (microphone) 13
 - audio-out (headphone) 13
 - RJ-45 (network) 13
- K**
- keyboard
 - product description 5
 - removal 52
 - spare part numbers 19, 52
- keys
 - action keys 10
 - esc 10
 - fn 10
 - Windows applications 10
 - Windows logo 10
- L**
- latch, battery release 16
- lights
 - AC adapter 12
 - caps lock 8
 - hard drive 14
 - power light 14
 - webcam 15
 - wireless 8
- M**
- mass storage devices, spare part numbers 26
- memory module
 - product description 2
 - removal 51
 - spare part numbers 22, 51
- microphone (audio-in) jack, identifying 13
- N**
- network jack, identifying 13
- O**
- operating system, product description 5
- optical drive
 - precautions 37
 - product description 3
 - removal 47
 - spare part numbers 23, 26, 47
 - specifications 84, 85

- P**
- packing guidelines 39
- plastic parts 36
- pointing device, product description 5
- ports
 - HDMI 13
 - product description 4
 - USB 13
- power button board
 - removal 58
 - spare part number 20, 58
- power button, identifying 9
- power connector
 - identifying 12
 - spare part number 20
- power connector cable
 - removal 63
 - spare part number 63
- power cord set requirements 97
- power cord, spare part numbers 27
- power light, identifying 14
- power requirements, product description 5
- processor
 - product description 1
 - removal 79
 - spare part numbers 21, 79
- product description
 - audio 4
 - camera 4
 - chipset 2
 - display panel 2
 - Ethernet 4
 - external media cards 4
 - graphics 2
 - hard drives 3
 - keyboard 5
 - memory module 2
 - operating system 5
 - optical drives 3
 - pointing devices 5
 - ports 4
 - power requirements 5
 - processors 1
 - security 5
 - serviceability 5

R

- recovering from the dedicated recovery partition 92
- recovering from the recovery discs 92
- recovery discs 91
- recovery, system 92
- removal/replacement
 - preliminaries 36
 - procedures 41
- restore points 96
- RJ-45 (network) jack, identifying 13
- RTC battery
 - removal 74
 - spare part number 22, 74
- Rubber Feet Kit, spare part number 42

S

- security cable slot
 - security cable slot, identifying 12
- security, product description 5
- serial number 17, 41
- service access cover
 - removal 44
 - spare part number 44
- service considerations 36
- service cover, identifying 16
- serviceability, product description 5
- Setup Utility
 - changing the language 86
 - displaying system information 87
 - exiting 87
 - navigating 87
 - restoring default settings 87
 - selecting 87
 - starting 86
- speaker assembly
 - removal 61
 - spare part number 22, 61
- specifications
 - Blu-ray Disc ROM and DVD±R/RW SuperMulti Double-Layer Drive 85
 - computer 81
 - display 82

- DVD±RW and CD-RW SuperMulti Double-Layer Combo Drive 84
- hard drive 83
- optical drive 84, 85
- static-shielding materials 40
- supported discs 91
- system board
 - removal 71
 - spare part numbers 20, 35, 71
- system information, displaying 87
- system recovery 92
- system restore points 96

T

- thermal paste, replacement 77
- tools required 36
- top cover
 - removal 55
 - spare part number 20, 55
- TouchPad
 - buttons 7
 - removal 59
- TouchPad button board
 - spare part number 59
- TouchPad LED board
 - removal 60
 - spare part number 60
- TouchPad light 7
- transporting guidelines 39

U

- USB board
 - removal 62
 - spare part number 20, 62
- USB port, identifying 13
- using system restore 96

V

- vents, identifying 13, 16

W

- webcam light, identifying 15
- webcam module, spare part number 24
- webcam, identifying 15
- Windows applications key, identifying 10
- Windows logo key, identifying 10

- wireless antenna
 - removal 69
 - spare part number 24
- wireless light 8
- WLAN antennas, identifying 15
- WLAN module
 - removal 49
 - spare part numbers 22, 49
- workstation guidelines 39