



HP ENVY 14 Notebook PC

Maintenance and Service Guide

© Copyright 2011 Hewlett-Packard
Development Company, L.P.

Bluetooth is a trademark owned by its proprietor and used by Hewlett-Packard Company under license. Intel and Core are trademarks of Intel Corporation in the U.S. and other countries. Microsoft, Windows, and Windows Vista are U.S. registered trademarks of Microsoft Corporation. SD Logo is a trademark of its proprietor.

The information contained herein is subject to change without notice. The only warranties for HP products and services are set forth in the express warranty statements accompanying such products and services. Nothing herein should be construed as constituting an additional warranty. HP shall not be liable for technical or editorial errors or omissions contained herein.

First Edition: June 2011

Document Part Number: 663636-001

Safety warning notice

⚠ WARNING! To reduce the possibility of heat-related injuries or of overheating the device, do not place the device directly on your lap or obstruct the device air vents. Use the device only on a hard, flat surface. Do not allow another hard surface, such as an adjoining optional printer, or a soft surface, such as pillows or rugs or clothing, to block airflow. Also, do not allow the AC adapter to contact the skin or a soft surface, such as pillows or rugs or clothing, during operation. The device and the AC adapter comply with the user-accessible surface temperature limits defined by the International Standard for Safety of Information Technology Equipment (IEC 60950).

Table of contents

| | |
|---|-----------|
| 1 Product description | 1 |
| 2 External component identification | 5 |
| Top | 5 |
| Button | 5 |
| Keys | 6 |
| Lights | 7 |
| TouchPad | 8 |
| Display | 9 |
| Front | 10 |
| Left side | 11 |
| Right side | 12 |
| Bottom components | 14 |
| 3 Illustrated parts catalog | 15 |
| Service tag | 15 |
| Computer major components | 17 |
| Door Kit | 22 |
| Mass storage devices | 23 |
| Miscellaneous parts | 24 |
| Sequential part number listing | 25 |
| 4 Removal and replacement procedures | 30 |
| Preliminary replacement requirements | 30 |
| Tools required | 30 |
| Service considerations | 30 |
| Plastic parts | 30 |
| Cables and connectors | 30 |
| Drive handling | 31 |
| Grounding guidelines | 31 |
| Electrostatic discharge damage | 31 |

| | |
|--|-----------|
| Packaging and transporting guidelines | 33 |
| Component replacement procedures | 35 |
| Service tag | 35 |
| Computer feet | 36 |
| Battery | 36 |
| Mass storage device | 38 |
| WLAN module | 41 |
| RTC battery | 44 |
| Memory module | 46 |
| Battery connector board | 47 |
| Top cover | 49 |
| Keyboard | 52 |
| Audio/USB board | 54 |
| Bluetooth module | 55 |
| Solid-state drive connector board | 56 |
| Optical drive | 58 |
| Power connector cable | 60 |
| System board | 62 |
| Fan/heat sink assembly | 65 |
| Processor | 67 |
| Speakers | 69 |
| Display assembly | 70 |
| 5 Setup Utility (BIOS) | 73 |
| Starting Setup Utility | 73 |
| Using Setup Utility | 73 |
| Changing the language of Setup Utility | 73 |
| Navigating and selecting in Setup Utility | 74 |
| Displaying system information | 74 |
| Restoring factory default settings in Setup Utility | 74 |
| Exiting Setup Utility | 75 |
| Updating the BIOS | 75 |
| Determining the BIOS version | 75 |
| Downloading a BIOS update | 76 |
| 6 Specifications | 78 |
| Computer specifications | 78 |
| 14.5-inch, SVA display specifications | 79 |
| Hard drive specifications | 80 |
| DVD±RW and CD-RW Super Multi Double-Layer Combo Drive specifications | 81 |

| | |
|---|-----------|
| 7 Backup and recovery | 82 |
| Recovery discs | 83 |
| Performing a system recovery | 84 |
| Recovering using the dedicated recovery partition | 84 |
| Recovering using the recovery discs | 84 |
| Backing up your information | 85 |
| Using Windows Backup and Restore | 85 |
| Using system restore points | 86 |
| When to create restore points | 86 |
| Create a system restore point | 86 |
| Restore to a previous date and time | 86 |
| 8 Power cord set requirements | 87 |
| Requirements for all countries | 87 |
| Requirements for specific countries and regions | 88 |
| 9 Recycling | 89 |
| Battery | 89 |
| Display | 89 |
| Index | 95 |

1 Product description

| Category | Description |
|---------------------|--|
| Product Name | HP ENVY 14 Notebook PC |
| Processors | Intel® Core i7-2820QM 2.30-GHz (turbo up to 3.40-GHz) processor (1600-MHz FSB, 8.0-MB L3 cache, Quad Core, 45 W) |
| | Intel Core i7-2720QM 2.20-GHz (turbo up to 3.30-GHz) processor (1600-MHz FSB, 6.0-MB L3 cache, Quad Core, 45 W) |
| | Intel Core i7-2630QM 2.00-GHz (turbo up to 2.90-GHz) processor (1333-MHz FSB, 6.0-MB L3 cache, Quad Core, 45 W) |
| | Intel Core i7-2620M 2.70-GHz (turbo up to 3.40-GHz) processor (1333-MHz FSB, 4.0-MB L3 cache, Dual Core, 35 W) |
| | Intel Core i5-2540M 2.60-GHz (turbo up to 3.30-GHz) processor (1333-MHz FSB, 3.0-MB L3 cache, Dual Core, 35 W) |
| | Intel Core i5-2520M 2.50-GHz (turbo up to 3.20-GHz) processor (1333-MHz FSB, 3.0-MB L3 cache, Dual Core, 35 W) |
| | Intel Core i5-2410M 2.30-GHz (turbo up to 2.90-GHz) processor (1333-MHz FSB, 3.0-MB L3 cache, Dual Core, 35 W) |
| | Intel Core i3-2330M 2.20-GHz processor (1333-MHz FSB, 3.0-MB L3 cache, Dual Core, 35 W) |
| | Intel Core i3-2310M 2.10-GHz processor (1333-MHz FSB, 3.0-MB L3 cache, Dual Core, 35 W) |
| Chipset | Intel 6 Series Express chipset Intel HM65 Platform controller hub (PCH) |
| Graphics | Intel HD unified memory architecture (UMA) graphics (integrated) with shared video memory ATi® Discrete PCI Express x 8 graphics: Radeon® HD6630M with 1024-MB of dedicated video memory (64Mx16, DDR3-900x8 PCs); 128-bit package Intel HD Graphics Support BD playback with muxless switchable graphics, HD decode, bus alive/chip off (BACO), and DX11 |

| Category | Description | |
|---------------|---|--|
| Panel | 14.5-in, (HD), LED, SVA, AntiGlare (1366x768) display; typical brightness: 220 nits | |
| | All display assemblies include 2 wireless local area network (WLAN) antenna cables | |
| | Supports 16:9 ultra wide aspect ratio | |
| | Supports flush glass panel cover | |
| | Lighted logo on top bezel | |
| Memory | 2 customer-accessible/upgradable memory module slots | |
| | Supports dual-channel memory | |
| | Supports up to 8192 GB of system RAM | |
| | DDR3/1333- and 1600-MHz | |
| | Supports the following configurations: | |
| | <ul style="list-style-type: none"> 16384-MB (8192-MB × 2, 1333-MHz; in the United States, configure-to-order only) 12288-MB (8192-MB × 1 + 4096-MB × 1, 1333-MHz; in the United States, configure-to-order only) 8192-MB (8192-MB × 1, 1333-MHz; in the United States, configure-to-order only) 8192-MB (4096-MB × 2, 1600-MHz or 1333-MHz) 6144-MB (4096-MB × 1 + 2048-MB × 1, 1600-MHz or 1333-MHz) 4096-MB (4096-MB × 1 or 2048-MB × 2, 1333-MHz) 3072-MB (2048-MB × 1 + 1024-MB × 1, 1333-MHz) 2048-MB (2048-MB × 1 or 1024-MB × 2, 1333-MHz) | |
| | Hard drives | Supports 6.35-cm (2.5-in) hard drives (HD) and solid-state drives (SSD), in 9.5-mm (.37-in) and 7.0-mm (.28-in) thicknesses |
| | | Customer-accessible |
| | | Serial ATA |
| | | Accelerometer (HP Mobile Data Protection System 3D) |
| | Supports the following single hard drive configurations: | |
| | <ul style="list-style-type: none"> 750-GB (7200-rpm) 640-GB (7200-rpm) 500-GB (7200-rpm) 320-GB (7200-rpm) | |
| | Supports the following single solid-state drive configurations: | |
| | <ul style="list-style-type: none"> 128-GB, mSATA 80-GB, mSATA 160-GB, SATA | |

| Category | Description |
|----------------------------|---|
| Optical drive | Fixed with eject button on the keyboard area |
| | Serial ATA |
| | 9.5-mm slot load |
| | Does not support 8-cm media |
| | Supports a DVD±RW and CD-RW Super Multi Double-Layer Combo Drive |
| Audio and video | 2 dual-array Integrated omnidirectional digital microphones with beam-forming, echo-cancellation, noise-suppression software |
| | IDT92HD80 HD audio |
| | Supports Microsoft Premium Requirements |
| | Beats Audio brand elements for software |
| | 2 ENVY-branded speakers |
| | Low-light HD webcam (fixed, no tilt) with activity LED, 1280×720 by 24 frames per second |
| Ethernet | Integrated Realtek RTL811E 10/100/1000 GB network interface card (NIC) |
| Wireless | Integrated wireless local area network (WLAN) options by way of wireless module |
| | Two WLAN antennas built into display assembly |
| | Support for the following WLAN formats: <ul style="list-style-type: none"> • Intel Centrino Advanced-N 6230 WLAN module • Intel Centrino Ultimate-N 6300 WLAN module |
| External media card | Digital Media Slot supports the following digital card formats: <ul style="list-style-type: none"> • MultiMediaCard • Secure Digital (SD) Memory Card • Secure Digital High Capacity Memory card • Secure Digital Extended Capacity Memory Card |
| Ports | <ul style="list-style-type: none"> • 3-pin AC power • Audio-in (stereo headphone/microphone combo) • Audio-out (stereo headphone), Beats-branded in red • eSATA combo with 3rd USB port • HDMI v1.4 supporting up to 1920×1200 @ 60-Hz with HDCP key (the system automatically switches to discrete mode from UMA mode when an HDMI device is plugged in) • mini-Display Port supporting super high-definition external displays up to 2560×1600 resolution • RJ-45 (Ethernet, includes link and activity lights) • USB 2.0 ports on computer, USB 3.0 port on right side of computer |

| Category | Description |
|---------------------------------------|--|
| Keyboard/ pointing devices | Full-size (14.5 in), backlit, island-style keyboard |
| | f5 control for backlight brightness |
| | TouchPad with gesture support (HP-defined, scroll, pinch, zoom) |
| | Taps enabled by default |
| Power requirements | 90-W (BFR/PFC-free) slim travel AC adapter with localized cable plug support for use in all countries and regions except India (3-wire plug with ground pin, supports 3-pin DC connector) |
| | 90-W (non-BFR/PVC-free) slim travel AC adapter with localized cable plug support for use in all countries and regions except India (3-wire plug with ground pin, supports 3-pin DC connector) |
| | 90-W EM slim travel AC adapter with localized cable plug support for use only in India (3-wire plug with ground pin, supports 3-pin DC connector) |
| | Support for the following batteries: <ul style="list-style-type: none"> • 8-cell, 2.00-Ah (59-Wh) Li-ion battery • 6-cell, 2.80-Ah (62-Wh) Li-ion battery |
| Security | Security cable slot |
| Operating system | Preinstalled: |
| | <ul style="list-style-type: none"> • Windows® 7 Home Premium 64-bit • Windows 7 Home Professional 64-bit • Windows 7 Ultimate 64-bit |
| | |
| | |
| Serviceability | End-user replaceable parts: |
| | <ul style="list-style-type: none"> • AC adapter • Battery • Hard drive • Memory modules (2) • mSATA solid state drive (select computer models only) • RTC battery • WLAN module |
| | |
| | |
| | |
| | |
| | |
| | |

2 External component identification

Top

Button



| Component | Description |
|---------------|---|
| Power button* | <ul style="list-style-type: none"><li data-bbox="948 1228 1474 1287">• When the computer is off, press the button to turn on the computer.<li data-bbox="948 1312 1474 1371">• When the computer is on, press the button briefly to initiate Sleep.<li data-bbox="948 1396 1474 1455">• When the computer is in the Sleep state, press the button briefly to exit Sleep.<li data-bbox="948 1480 1474 1539">• When the computer is in Hibernation, press the button briefly to exit Hibernation. <p data-bbox="948 1564 1474 1675">If the computer has stopped responding and Windows® shutdown procedures are ineffective, press and hold the power button for at least 5 seconds to turn off the computer.</p> <p data-bbox="948 1701 1474 1812">To learn more about your power settings, select Start > Control Panel > System and Security > Power Options, or refer to the <i>HP Notebook Reference Guide</i>.</p> |

Keys

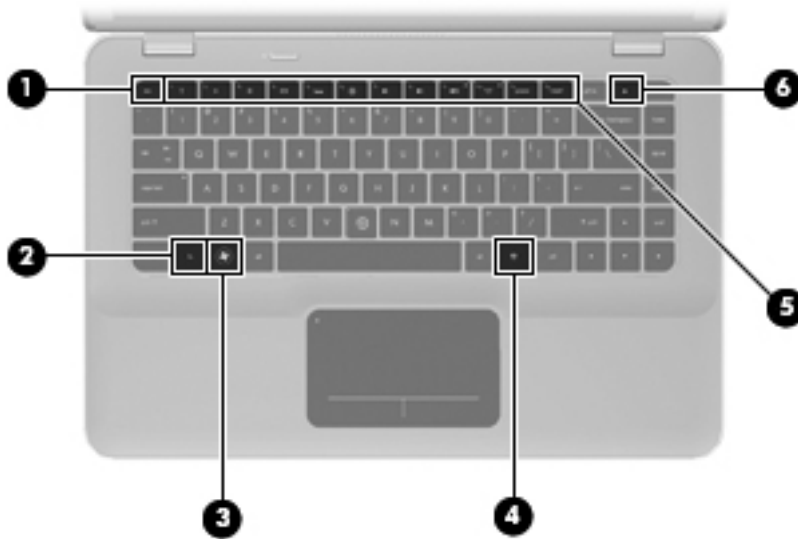

| Item | Component | Description |
|------|--------------------------|--|
| (1) | esc key | Displays system information when pressed in combination with the fn key. |
| (2) | fn key | Executes frequently used system functions when pressed in combination with the b key or the esc key. |
| (3) | Windows logo key | Displays the Windows Start menu. |
| (4) | Windows applications key | Displays a shortcut menu for items beneath the pointer. |
| (5) | Action keys | Execute frequently used functions. |
| (6) | Optical drive eject key | Opens the optical drive. |

Lights

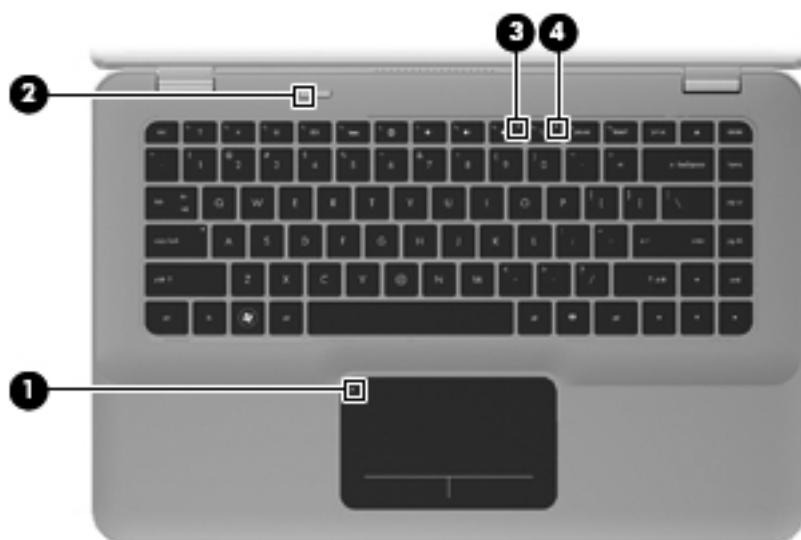

| Item | Component | Description |
|------|----------------|---|
| (1) | TouchPad light | <ul style="list-style-type: none">• Amber: The TouchPad is off.• Off: The TouchPad is on. |
| (2) | Power light | <ul style="list-style-type: none">• White: The computer is on.• Blinking white: The computer is in the Sleep state.• Off: The computer is off or in Hibernation. |
| (3) | Mute light | <ul style="list-style-type: none">• Amber: Computer sound is off.• Off: Computer sound is on. |
| (4) | Wireless light | <ul style="list-style-type: none">• White: An integrated wireless device, such as a WLAN device, is on. <p>NOTE: Wireless devices are enabled at the factory.</p> <ul style="list-style-type: none">• Amber: All wireless devices are off. |

TouchPad

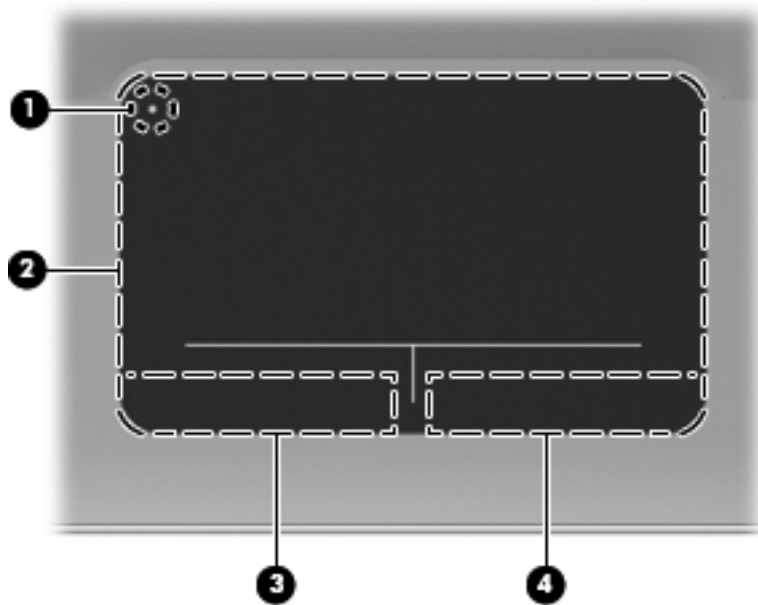

| Item | Component | Description |
|------|-----------------------|---|
| (1) | TouchPad light | Turns the TouchPad on and off. Quickly double-tap the TouchPad light to turn the TouchPad on and off. |
| (2) | TouchPad zone | Moves the pointer and selects or activates items on the screen. |
| (3) | Left TouchPad button | Functions like the left button on an external mouse. |
| (4) | Right TouchPad button | Functions like the right button on an external mouse. |

Display

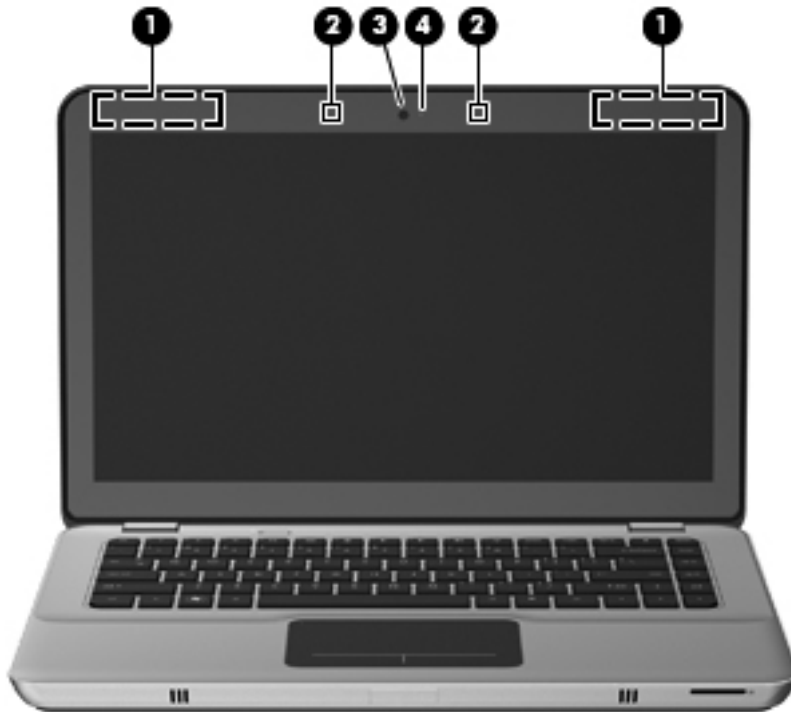

| Item | Component | Description |
|------|--------------------------|--|
| (1) | WLAN antennas (2)* | Send and receive wireless signals to communicate with WLANs. NOTE: Select computer models may have up to 4 WLAN antennas. |
| (2) | Internal microphones (2) | Record sound. |
| (3) | Webcam | Records video and captures still photographs. To access the webcam, select Start > All Programs > CyberLink YouCam . |
| (4) | Webcam light | On: The webcam is in use. |

*The antennas are not visible from the outside of the computer. For optimal transmission, keep the areas immediately around the antennas free from obstructions. To see wireless regulatory notices, refer to the section of the *Regulatory, Safety, and Environmental Notices* that applies to your country or region. These notices are located in Help and Support.

Front

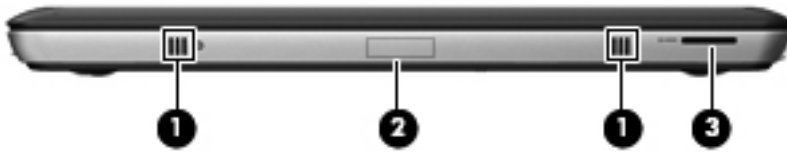

| Item | Component | Description |
|------|-----------------------|---|
| (1) | Speakers (2) | Produce sound. |
| (2) | Bluetooth compartment | Contains a Bluetooth device. |
| (3) | Digital Media Slot | Supports the following digital card formats: <ul style="list-style-type: none">• MultiMediaCard• Secure Digital (SD) Memory Card• Secure Digital High Capacity Memory card• Secure Digital Extended Capacity Memory Card |

Left side



| Item | Component | Description |
|------|---|--|
| (1) | Optical drive | <p>Reads and writes to an optical disc.</p> <p>CAUTION: Do not insert 8-cm optical discs into the optical drive. This can cause damage to the computer.</p> |
| (2) | USB ports (2) | <p>Connect optional USB devices.</p> |
| (3) | Audio-out (headphone) jack/Audio-in (microphone) jack | <p>Produces sound when connected to optional powered stereo speakers, headphones, earbuds, a headset, or television audio. Also connects an optional headset microphone.</p> <p>WARNING! To reduce the risk of personal injury, adjust the volume before putting on headphones, earbuds, or a headset. For additional safety information, refer to the Regulatory, Safety, and Environmental Notices.</p> <p>NOTE: When a device is connected to the jack, the computer speakers are disabled.</p> <p>NOTE: Be sure that the device cable has a 4-conductor connector that supports both audio-out (headphone) and audio-in (microphone).</p> |
| (4) | Audio-out (headphone) jack | <p>Produces sound when connected to optional powered stereo speakers, headphones, ear buds, a headset, or television audio.</p> <p>WARNING! To reduce the risk of personal injury, adjust the volume before putting on headphones, earbuds, or a headset. For additional safety information, refer to the Regulatory, Safety, and Environmental Notices.</p> <p>NOTE: When a device is connected to the jack, the computer speakers are disabled.</p> |

Right side

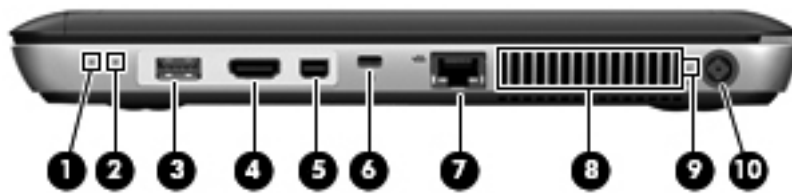

| Item | Component | Description |
|------|--------------------------|--|
| (1) | Power light | <ul style="list-style-type: none">• White: The computer is on.• Blinking white: The computer is in the Sleep state.• Off: The computer is off or in Hibernation. |
| (2) | Drive light | <ul style="list-style-type: none">• Blinking white: The hard drive is being accessed.• Amber: HP ProtectSmart Hard Drive Protection has temporarily parked the hard drive. <p>NOTE: For information on HP ProtectSmart Hard Drive Protection, refer to the <i>HP Notebook Reference Guide</i>.</p> |
| (3) | USB 3.0 port | Connects an optional USB 3.0 device and provides enhanced USB power performance. NOTE: This port is also compatible with USB 1.0 and 2.0 devices. |
| (4) | HDMI port | Connects an optional video or audio device, such as a high-definition television, or any compatible digital or audio component. |
| (5) | Mini DisplayPort | Connects an optional digital display device, such as a highperformance monitor or projector. |
| (6) | Security cable slot | Attaches an optional security cable to the computer. NOTE: The security cable is designed to act as a deterrent, but it may not prevent the computer from being mishandled or stolen. |
| (7) | RJ-45 (network) jack (2) | Connects a network cable. |
| (8) | Vent | Enables airflow to cool internal components. NOTE: The computer fan starts up automatically to cool internal components and prevent overheating. It is normal for the internal fan to cycle on and off during routine operation. |

| Item | Component | Description |
|-------------|------------------|---|
| (9) | Battery light | <ul style="list-style-type: none">• Off: The computer is running on battery power.• Blinking amber: The battery has reached a low battery level, a critical battery level, or there is a battery error.• Amber: A battery is charging.• White: The computer is connected to external power and the battery is fully charged. |
| (10) | Power connector | Connects an AC adapter. |

Bottom components

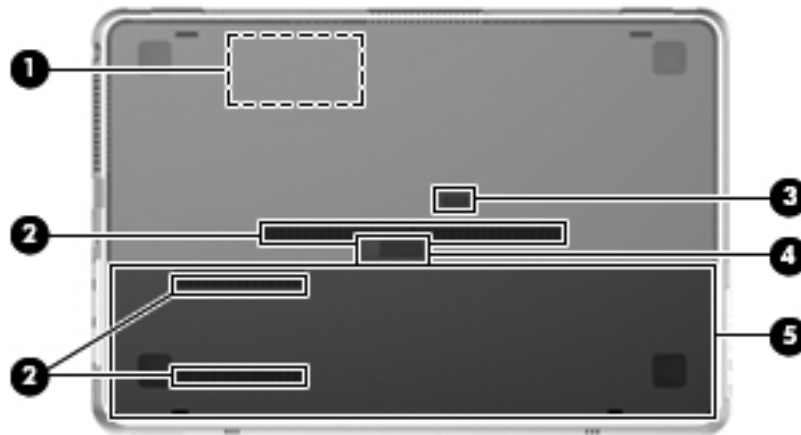

| Item | Component | Description |
|------|---|---|
| (1) | Memory module/wireless module compartment | Contains the memory module slot. |
| (2) | Vents (3) | Enable airflow to cool internal components. NOTE: The computer fan starts up automatically to cool internal components and prevent overheating. It is normal for the internal fan to cycle on and off during routine operation. |
| (3) | Accessory battery connector | Connects an optional accessory battery. |
| (4) | Battery cover release latch | Releases the battery cover. |
| (5) | Battery bay | Holds the battery and the hard drive. NOTE: The battery is preinstalled in the battery bay at the factory. |

3 Illustrated parts catalog

Service tag

When ordering parts or requesting information, provide the computer serial number and model number provided on the service tag.

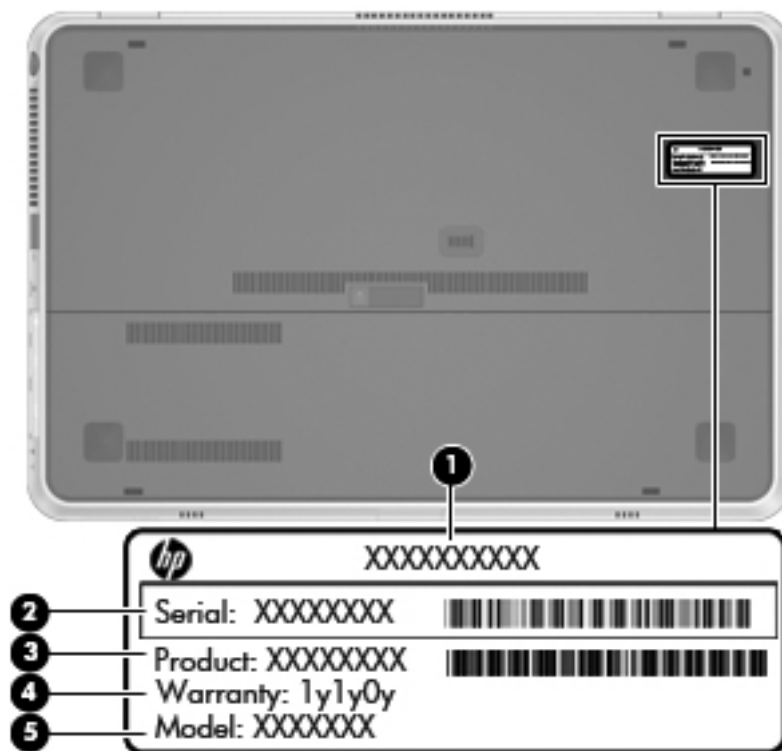

| Item | Component | Description |
|------|----------------------------------|---|
| (1) | Product name | This is the product name affixed to the front of the computer. |
| (2) | Serial number (s/n) | This is an alphanumeric identifier that is unique to each product. |
| (3) | Part number/Product number (p/n) | This number provides specific information about the product's hardware components. The part number helps a service technician determine what components and parts are needed. |

| Item | Component | Description |
|-------------|-------------------|--|
| (4) | Warranty period | This number describes the duration of the warranty period for the computer. |
| (5) | Model description | This is the alphanumeric identifier used to locate documents, drivers, and support for the computer. |

Computer major components

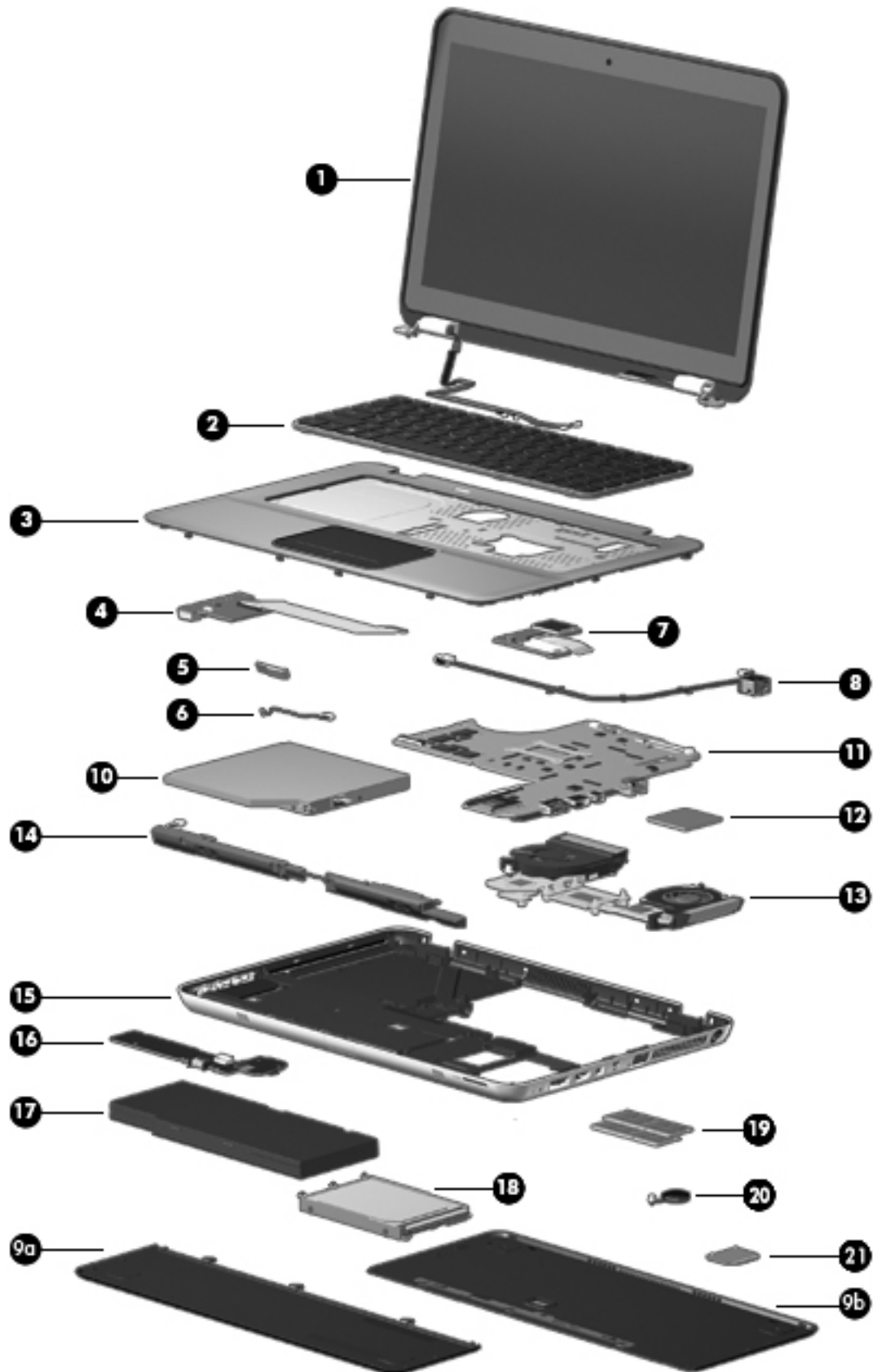

| Item | Description | Spare part number |
|-------------|--|--------------------------|
| (1) | 14.5-in, LED, HD, AntiGlare, flush glass display assembly (includes display panel cable, webcam/microphone module and cable, and 2 WLAN antenna cables and transceivers): | |
| | SVA display assembly for use only with Beats Edition computer models | 654166-001 |
| | SVA display assembly for use only with standard computer models | 654165-001 |
| (2) | Keyboard (includes keyboard cable and keyboard light cable): | |
| | For use only with Beats Edition computer models: | |
| | • For use in Belgium | 619400-A41 |
| | • For use in Brazil | 619400-201 |
| | • For use in Canada | 619400-121 |
| | • For use in Denmark, Finland, and Norway | 619400-DH1 |
| | • For use in France | 619400-051 |
| | • For use in Germany | 619400-041 |
| | • For use in India | 619400-D61 |
| | • For use in Italy | 619400-061 |
| | • For use in Latin America | 619400-161 |
| | • For use in the Netherlands | 619400-B31 |
| | • For use in Portugal | 619400-131 |
| | • For use in Russia | 619400-251 |
| | • For use in Saudi Arabia | 619400-171 |
| | • For use in South Korea | 619400-AD1 |
| | • For use in Spain | 619400-071 |
| | • For use in Switzerland | 619400-BG1 |
| | • For use in Taiwan | 619400-AB1 |
| | • For use in Thailand | 619400-281 |
| | • For use in Turkey | 619400-141 |
| | • For use in the United Kingdom and Singapore | 619400-031 |
| | • For use in the United States | 619400-001 |
| | For use only with standard computer models: | |
| | • For use in Belgium | 608375-A41 |
| | • For use in Brazil | 608375-201 |
| | • For use in Canada | 608375-121 |
| | • For use in Denmark, Finland, and Norway | 608375-DH1 |
| | • For use in France | 608375-051 |

| Item | Description | Spare part number |
|------------|--|-------------------|
| | • For use in Germany | 608375-041 |
| | • For use in India | 608375-D61 |
| | • For use in Italy | 608375-061 |
| | • For use in Latin America | 608375-161 |
| | • For use in the Netherlands | 608375-B31 |
| | • For use in Portugal | 608375-131 |
| | • For use in Russia | 608375-251 |
| | • For use in Saudi Arabia | 608375-171 |
| | • For use in South Korea | 608375-AD1 |
| | • For use in Spain | 608375-071 |
| | • For use in Switzerland | 608375-BG1 |
| | • For use in Taiwan | 608375-AB1 |
| | • For use in Thailand | 608375-281 |
| | • For use in Turkey | 608375-141 |
| | • For use in the United Kingdom and Singapore | 608375-031 |
| | • For use in the United States | 608375-001 |
| (3) | Top cover (includes power button board and cable and TouchPad and TouchPad cable): | |
| | For use only with Beats Edition computer models | 658005-001 |
| | For use only with standard computer models | 658004-001 |
| (4) | Audio/USB board (includes cable) | 654169-001 |
| (5) | Bluetooth module | 537921-001 |
| | NOTE: The Bluetooth module spare part kit does not include a Bluetooth module cable. The Bluetooth module cable is included in the Cable Kit, spare part number 608385-001. | |
| | Cable Kit , includes: | 608385-001 |
| (6) | Bluetooth module cable | |
| (7) | Solid-state drive connector board (includes cable): | |
| | For use only with computer models equipped with an mSATA solid-state drive | 654171-001 |
| | For use only with computer models not equipped with an mSATA solid-state drive | 661706-001 |
| (8) | Power connector cable | 654170-001 |
| | Door Kit: | |
| | For use only with Beats Edition computer models: | 661376-001 |
| | For use only with standard computer models: | 661375-001 |

| Item | Description | Spare part number |
|------|--|-------------------|
| | Includes: | |
| (9a) | Battery cover | |
| (9b) | Memory module/wireless module compartment cover | |
| | NOTE: See Door Kit on page 22 for more Door Kit component information. | |
| (10) | DVD±RW and CD-RW Super Multi Double-Layer Combo Drive with LightScribe (includes cable, connector board, and retention rails) | 657530-001 |
| (11) | System board equipped with Intel 6 series express chipset, Intel HM65 PCH, Radeon HD 6630M graphics subsystem with 1024-MB of discrete video memory (includes replacement thermal material) | 654173-001 |
| | Thermal Material Kit (not illustrated, includes replacement thermal pads and thermal paste) | 634366-001 |
| (12) | Processor (includes replacement thermal material): | |
| | Intel Core i7-2820QM 2.30-GHz (turbo up to 3.40-GHz) processor (1600-MHz FSB, 8.0-MB L3 cache, Quad Core, 45 W) | 634694-001 |
| | Intel Core i7-2720QM 2.20-GHz (turbo up to 3.30-GHz) processor (1600-MHz FSB, 6.0-MB L3 cache, Quad Core, 45 W) | 631254-001 |
| | Intel Core i7-2630QM 2.00-GHz (turbo up to 2.90-GHz) processor (1333-MHz FSB, 6.0-MB L3 cache, Quad Core, 45 W) | 635501-001 |
| | Intel Core i7-2620M 2.70-GHz (turbo up to 3.40-GHz) processor (1333-MHz FSB, 4.0-MB L3 cache, Dual Core, 35 W) | 631252-001 |
| | Intel Core i5-2540M 2.60-GHz (turbo up to 3.30-GHz) processor (1333-MHz FSB, 3.0-MB L3 cache, Dual Core, 35 W) | 631255-001 |
| | Intel Core i5-2520M 2.50-GHz (turbo up to 3.20-GHz) processor (1333-MHz FSB, 3.0-MB L3 cache, Dual Core, 35 W) | 631253-001 |
| | Intel Core i5-2410M 2.30-GHz (turbo up to 2.90-GHz) processor (1333-MHz FSB, 3.0-MB L3 cache, Dual Core, 35 W) | 638039-001 |
| | Intel Core i3-2330M 2.20-GHz processor (1333-MHz FSB, 3.0-MB L3 cache, Dual Core, 35 W) | 653339-001 |
| | Intel Core i3-2310M 2.10-GHz processor (1333-MHz FSB, 3.0-MB L3 cache, Dual Core, 35 W) | 638037-001 |
| | Thermal Material Kit (not illustrated, includes replacement thermal pads and thermal paste) | 634366-001 |
| (13) | Fan/heat sink assembly (includes replacement thermal material) | 657529-001 |
| | Thermal Material Kit (not illustrated, includes replacement thermal pads and thermal paste) | 634366-001 |
| (14) | Speakers (include cable) | 657531-001 |
| (15) | Base enclosure (includes 4 rubber feet): | |
| | For use only with Beats Edition computer models | 654164-001 |
| | For use only with standard computer models | 654163-001 |

| Item | Description | Spare part number |
|-------------|--|--------------------------|
| (16) | Battery connector board (includes cable) | 654172-001 |
| (17) | Battery: | |
| | 8-cell, 59-Wh, 2.00-Ah, Li-ion battery | 593548-001 |
| | 6-cell, 62-Wh, 2.80-Ah, Li-ion battery | 602410-001 |
| (18) | Hard drive (includes hard drive bracket): | |
| | 750-GB, 7200-rpm | 633252-001 |
| | 640-GB, 7200-rpm | 621046-001 |
| | 500-GB, 7200-rpm | 634921-001 |
| | 320-GB, 7200-rpm | 641672-001 |
| | Solid-state drive (includes solid-state drive bracket): | |
| | 128-GB mSATA solid-state drive | 657878-001 |
| | 80-GB mSATA solid-state drive | 657877-001 |
| | 160-GB SATA solid-state drive | 608367-001 |
| | Hard Drive Hardware Kit (not illustrated, includes hard drive bracket and screws) | 608373-001 |
| (19) | Memory modules (2): | |
| | 4096-MB memory module (PC3, 12800, 1600-MHz) | 641369-001 |
| | 8196-MB memory module (PC3, 10600, 1333-MHz) | 634091-001 |
| | 4096-MB memory module (PC3, 10600, 1333-MHz) | 621569-001 |
| | 2048-MB memory module (PC3, 10600, 1333-MHz) | 581096-001 |
| (20) | RTC battery (includes cable and double-sided tape) | 581926-001 |
| (21) | WLAN module: | |
| | Intel Centrino Advanced-N 6230 WLAN module | 636672-001 |
| | Intel Centrino Ultimate-N 6300 WLAN module | 572511-001 |

Door Kit



| Item | Description | Spare part number |
|------------------|--|-------------------|
| Door Kit: | | |
| | For use only with Beats Edition computer models: | 661376-001 |
| | For use only with standard computer models: | 661375-001 |
| | Includes: | |
| (1) | Memory module/wireless module compartment cover | |
| (2) | Battery cover | |

Mass storage devices

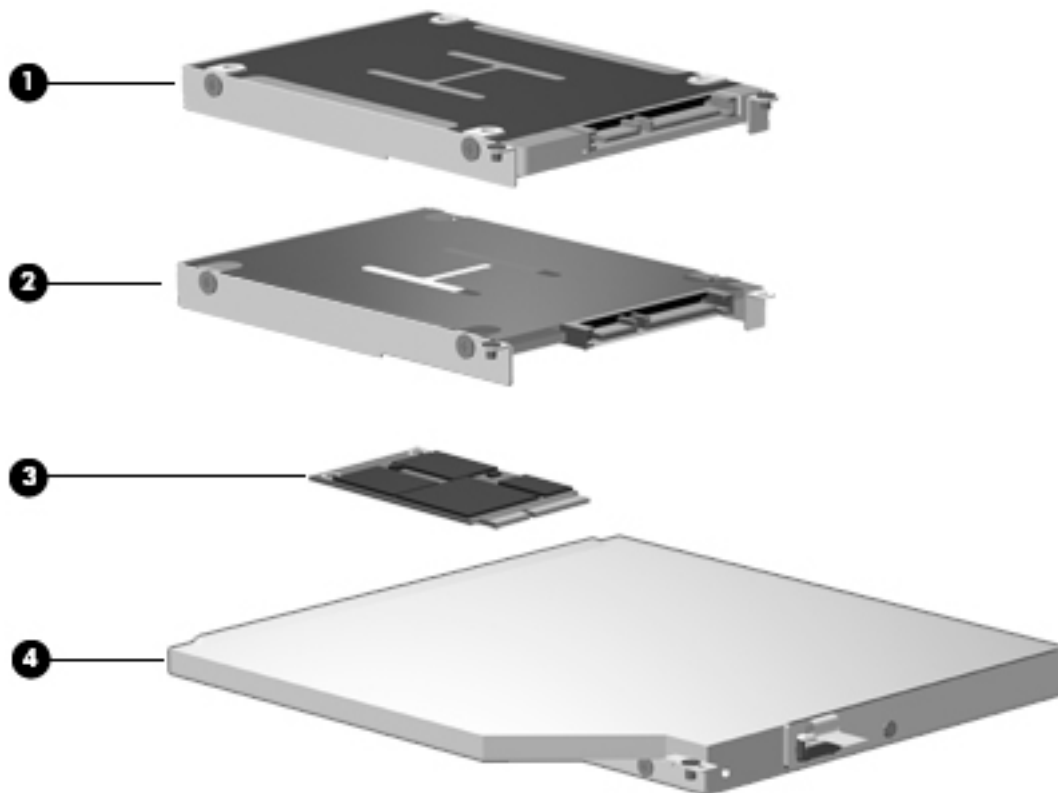

| Item | Description | Spare part number |
|------|--|-------------------|
| (1) | Hard drive (includes hard drive bracket and screws): | |
| | 750-GB, 7200-rpm | 633252-001 |
| | 640-GB, 7200-rpm | 621046-001 |
| | 500-GB, 7200-rpm | 634921-001 |
| | 320-GB, 7200-rpm | 641672-001 |
| (2) | 160-GB SATA solid-state drive (includes solid-state drive bracket) | 608367-001 |
| (3) | mSATA solid-state drive: | |
| | 128-GB mSATA solid-state drive | 657878-001 |
| | 80-GB mSATA solid-state drive | 657877-001 |
| (4) | DVD±RW and CD-RW Super Multi Double-Layer Combo Drive with LightScribe (includes cable, connector board, and retention rails) | 657530-001 |
| | Hard Drive Hardware Kit (not illustrated, includes hard drive bracket and screws) | 608373-001 |

Miscellaneous parts

| Description | Spare part number |
|--|-------------------|
| AC adapter: | |
| 90W PFC RC/V EM HP Smart AC adapter | 609947-001 |
| 90W PFC HP Smart AC adapter | 644240-001 |
| 90W travel AC adapter | 616072-001 |
| HDMI to VGA adapter | 530607-001 |
| Power cord: | |
| For use in Argentina | 490371-D01 |
| For use in Italy | 490371-061 |
| For use in Australia | 490371-011 |
| For use in Thailand | 490371-201 |
| For use in Brazil | 490371-202 |
| For use in Denmark | 490371-081 |
| For use in Europe, the Middle East, and Africa | 490371-021 |
| For use in India | 490371-D61 |
| For use in Japan | 490371-291 |
| For use in North America | 490371-001 |
| For use in the People's Republic of China | 490371-AA1 |
| For use in South Korea | 490371-AD1 |
| For use in Switzerland | 490371-111 |
| For use in Taiwan | 490371-AB1 |
| For use in the United Kingdom and Singapore | 490371-031 |
| Protective cover: | |
| Beats Edition protective cover | 622391-001 |
| Standard protective cover | 623899-001 |
| Screw Kit | 608383-001 |

Sequential part number listing

| Spare part number | Description |
|-------------------|--|
| 490371-001 | Power cord for use in North America |
| 490371-011 | Power cord for use in Australia |
| 490371-021 | Power cord for use in Europe, the Middle East, and Africa |
| 490371-031 | Power cord for use in the United Kingdom and Singapore |
| 490371-061 | Power cord for use in Italy |
| 490371-081 | Power cord for use in Denmark |
| 490371-111 | Power cord for use in Switzerland |
| 490371-201 | Power cord for use in Thailand |
| 490371-202 | Power cord for use in Brazil |
| 490371-291 | Power cord for use in Japan |
| 490371-AA1 | Power cord for use in the People's Republic of China |
| 490371-AB1 | Power cord for use in Taiwan |
| 490371-AD1 | Power cord for use in South Korea |
| 490371-D01 | Power cord for use in Argentina |
| 490371-D61 | Power cord for use in India |
| 530607-001 | HDMI to VGA adapter |
| 537921-001 | Bluetooth module (includes gasket) |
| | NOTE: The Bluetooth module spare part kit does not include a Bluetooth module cable. The Bluetooth module cable is included in the Cable Kit, spare part number 608385-001. |
| 572511-001 | Intel Centrino Ultimate-N 6300 WLAN module |
| 581096-001 | 2048-MB memory module (PC3, 10600, 1333-MHz) |
| 581926-001 | RTC battery (includes cable and double-sided tape) |
| 593548-001 | 8-cell, 59-Wh, 2.00-Ah, Li-ion battery |
| 602410-001 | 6-cell, 62-Wh, 2.80-Ah, Li-ion battery |
| 608367-001 | 160-GB solid-state drive (includes solid-state drive bracket) |
| 608373-001 | Hard Drive Hardware Kit (includes hard drive bracket and screws) |
| 608375-001 | Keyboard for use only with standard computer models in the United States (includes keyboard cable and keyboard light cable) |
| 608375-031 | Keyboard for use only with standard computer models in the United Kingdom and Singapore (includes keyboard cable and keyboard light cable) |
| 608375-041 | Keyboard for use only with standard computer models in Germany (includes keyboard cable and keyboard light cable) |

| Spare part number | Description |
|--------------------------|--|
| 608375-051 | Keyboard for use only with standard computer models in France (includes keyboard cable and keyboard light cable) |
| 608375-061 | Keyboard for use only with standard computer models in Italy (includes keyboard cable and keyboard light cable) |
| 608375-071 | Keyboard for use only with standard computer models in Spain (includes keyboard cable and keyboard light cable) |
| 608375-121 | Keyboard for use only with standard computer models in Canada (includes keyboard cable and keyboard light cable) |
| 608375-131 | Keyboard for use only with standard computer models in Portugal (includes keyboard cable and keyboard light cable) |
| 608375-141 | Keyboard for use only with standard computer models in Turkey (includes keyboard cable and keyboard light cable) |
| 608375-161 | Keyboard for use only with standard computer models in Latin America (includes keyboard cable and keyboard light cable) |
| 608375-171 | Keyboard for use only with standard computer models in Saudi Arabia (includes keyboard cable and keyboard light cable) |
| 608375-201 | Keyboard for use only with standard computer models in Brazil (includes keyboard cable and keyboard light cable) |
| 608375-251 | Keyboard for use only with standard computer models in Russia (includes keyboard cable and keyboard light cable) |
| 608375-281 | Keyboard for use only with standard computer models in Thailand (includes keyboard cable and keyboard light cable) |
| 608375-A41 | Keyboard for use only with standard computer models in Belgium (includes keyboard cable and keyboard light cable) |
| 608375-AB1 | Keyboard for use only with standard computer models in Taiwan (includes keyboard cable and keyboard light cable) |
| 608375-AD1 | Keyboard for use only with standard computer models in South Korea (includes keyboard cable and keyboard light cable) |
| 608375-B31 | Keyboard for use only with standard computer models in the Netherlands (includes keyboard cable and keyboard light cable) |
| 608375-BG1 | Keyboard for use only with standard computer models in Switzerland (includes keyboard cable and keyboard light cable) |
| 608375-D61 | Keyboard for use only with standard computer models in India (includes keyboard cable and keyboard light cable) |
| 608375-DH1 | Keyboard for use only with standard computer models in Denmark, Finland, and Norway (includes keyboard cable and keyboard light cable) |
| 608383-001 | Screw Kit |
| 608385-001 | Cable Kit (includes the Bluetooth module cable) |
| 609947-001 | 90W PFC RC/V EM HP Smart AC adapter |
| 616072-001 | 90W travel AC adapter |

| Spare part number | Description |
|--------------------------|---|
| 619400-001 | Keyboard for use only with Beats Edition computer models in the United States (includes keyboard cable and keyboard light cable) |
| 619400-031 | Keyboard for use only with Beats Edition computer models in the United Kingdom and Singapore (includes keyboard cable and keyboard light cable) |
| 619400-041 | Keyboard for use only with Beats Edition computer models in Germany (includes keyboard cable and keyboard light cable) |
| 619400-051 | Keyboard for use only with Beats Edition computer models in France (includes keyboard cable and keyboard light cable) |
| 619400-061 | Keyboard for use only with Beats Edition computer models in Italy (includes keyboard cable and keyboard light cable) |
| 619400-071 | Keyboard for use only with Beats Edition computer models in Spain (includes keyboard cable and keyboard light cable) |
| 619400-121 | Keyboard for use only with Beats Edition computer models in Canada (includes keyboard cable and keyboard light cable) |
| 619400-131 | Keyboard for use only with Beats Edition computer models in Portugal (includes keyboard cable and keyboard light cable) |
| 619400-141 | Keyboard for use only with Beats Edition computer models in Turkey (includes keyboard cable and keyboard light cable) |
| 619400-161 | Keyboard for use only with Beats Edition computer models in Latin America (includes keyboard cable and keyboard light cable) |
| 619400-171 | Keyboard for use only with Beats Edition computer models in Saudi Arabia (includes keyboard cable and keyboard light cable) |
| 619400-201 | Keyboard for use only with Beats Edition computer models in Brazil (includes keyboard cable and keyboard light cable) |
| 619400-251 | Keyboard for use only with Beats Edition computer models in Russia (includes keyboard cable and keyboard light cable) |
| 619400-281 | Keyboard for use only with Beats Edition computer models in Thailand (includes keyboard cable and keyboard light cable) |
| 619400-A41 | Keyboard for use only with Beats Edition computer models in Belgium (includes keyboard cable and keyboard light cable) |
| 619400-AB1 | Keyboard for use only with Beats Edition computer models in Taiwan (includes keyboard cable and keyboard light cable) |
| 619400-AD1 | Keyboard for use only with Beats Edition computer models in South Korea (includes keyboard cable and keyboard light cable) |
| 619400-B31 | Keyboard for use only with Beats Edition computer models in the Netherlands (includes keyboard cable and keyboard light cable) |
| 619400-BG1 | Keyboard for use only with Beats Edition computer models in Switzerland (includes keyboard cable and keyboard light cable) |
| 619400-D61 | Keyboard for use only with Beats Edition computer models in India (includes keyboard cable and keyboard light cable) |

| Spare part number | Description |
|--------------------------|--|
| 619400-DH1 | Keyboard for use only with Beats Edition computer models in Denmark, Finland, and Norway (includes keyboard cable and keyboard light cable) |
| 621046-001 | 640-GB, 7200-rpm hard drive (includes hard drive bracket) |
| 621569-001 | 4096-MB memory module (PC3, 10600, 1333-MHz) |
| 622391-001 | Beats Edition protective cover |
| 623899-001 | Standard protective cover |
| 631252-001 | Intel Core i7-2620M 2.70-GHz (turbo up to 3.40-GHz) processor (1333-MHz FSB, 4.0-MB L3 cache, Dual Core, 35 W; includes replacement thermal material) |
| 631253-001 | Intel Core i5-2520M 2.50-GHz (turbo up to 3.20-GHz) processor (1333-MHz FSB, 3.0-MB L3 cache, Dual Core, 35 W; includes replacement thermal material) |
| 631254-001 | Intel Core i7-2720QM 2.20-GHz (turbo up to 3.30-GHz) processor (1600-MHz FSB, 6.0-MB L3 cache, Quad Core, 45 W; includes replacement thermal material) |
| 631255-001 | Intel Core i5-2540M 2.60-GHz (turbo up to 3.30-GHz) processor (1333-MHz FSB, 3.0-MB L3 cache, Dual Core, 35 W; includes replacement thermal material) |
| 633252-001 | 750-GB, 7200-rpm hard drive (includes hard drive bracket) |
| 634091-001 | 8192-MB memory module (PC3, 10600, 1333-MHz) |
| 634366-001 | Thermal Material Kit (includes replacement thermal pads and thermal paste) |
| 634366-001 | Thermal Material Kit (includes replacement thermal pads and thermal paste) |
| 634694-001 | Intel Core i7-2820QM 2.30-GHz (turbo up to 3.40-GHz) processor (1600-MHz FSB, 8.0-MB L3 cache, Quad Core, 45 W; includes replacement thermal material) |
| 634921-001 | 500-GB, 7200-rpm hard drive (does not include hard drive bracket) |
| 635501-001 | Intel Core i7-2630QM 2.00-GHz (turbo up to 2.90-GHz) processor (1333-MHz FSB, 6.0-MB L3 cache, Quad Core, 45 W; includes replacement thermal material) |
| 636672-001 | Intel Centrino Advanced-N 6230 WLAN module |
| 638037-001 | Intel Core i3-2310M 2.10-GHz processor (1333-MHz FSB, 3.0-MB L3 cache, Dual Core, 35 W; includes replacement thermal material) |
| 638039-001 | Intel Core i5-2410M 2.30-GHz (turbo up to 2.90-GHz) processor (1333-MHz FSB, 3.0-MB L3 cache, Dual Core, 35 W; includes replacement thermal material) |
| 641369-001 | 4096-MB memory module (PC3, 12800, 1600-MHz) |
| 641672-001 | 320-GB, 7200-rpm hard drive (does not include hard drive bracket) |
| 644240-001 | 90W PFC HP Smart AC adapter |
| 653339-001 | Intel Core i3-2330M 2.20-GHz processor (1333-MHz FSB, 3.0-MB L3 cache, Dual Core, 35 W; includes replacement thermal material) |
| 654163-001 | Base enclosure for use only with standard computer models (includes 4 rubber feet) |
| 654164-001 | Base enclosure for use only with Beats Edition computer models (includes 4 rubber feet) |

| Spare part number | Description |
|--------------------------|--|
| 654165-001 | 14.5-in, LED, HD, AntiGlare, flush glass SVA display assembly for use only with standard computer models (includes display panel cable, webcam/microphone module and cable, and 2 WLAN antenna cables and transceivers) |
| 654166-001 | 14.5-in, LED, HD, AntiGlare, flush glass SVA display assembly for use only with Beats Edition computer models (includes display panel cable, webcam/microphone module and cable, and 2 WLAN antenna cables and transceivers) |
| 654169-001 | Audio/USB board (includes cable) |
| 654170-001 | Power connector cable |
| 654171-001 | Solid-state drive connector board for use only with computer models equipped with an mSATA solid-state drive (includes cable) |
| 654172-001 | Battery connector board |
| 654173-001 | System board equipped with Intel 6 series express chipset, Intel HM65 PCH, Radeon HD 6630M graphics subsystem with 1024-MB of discrete video memory (includes replacement thermal material) |
| 657529-001 | Fan/heat sink assembly (includes replacement thermal material) |
| 657530-001 | DVD±RW and CD-RW Super Multi Double-Layer Combo Drive with LightScribe (includes cable, connector board, and retention rails) |
| 657531-001 | Speakers (include cable) |
| 657877-001 | 80-GB mSATA solid-state drive |
| 657878-001 | 128-GB mSATA solid-state drive |
| 658004-001 | Top cover for use only with standard computer models (includes power button board and cable and TouchPad and TouchPad cable) |
| 658005-001 | Top cover for use only with Beats Edition computer models (includes power button board and cable and TouchPad and TouchPad cable) |
| 661375-001 | Door Kit for use only with standard computer models (includes the battery cover and the memory module/wireless module compartment cover) |
| | NOTE: See Door Kit on page 22 for more Door Kit component information. |
| 661376-001 | Door Kit for use only with Beats Edition computer models (includes the battery cover and the memory module/wireless module compartment cover) |
| | NOTE: See Door Kit on page 22 for more Door Kit component information. |
| 661706-001 | Solid-state drive connector board for use only with computer models not equipped with an mSATA solid-state drive (includes cable) |

4 Removal and replacement procedures

Preliminary replacement requirements

Tools required

You will need the following tools to complete the removal and replacement procedures:

- Flat-bladed screwdriver
- Magnetic screwdriver
- Phillips P0 and P1 screwdrivers

Service considerations

The following sections include some of the considerations that you must keep in mind during disassembly and assembly procedures.

 **NOTE:** As you remove each subassembly from the computer, place the subassembly (and all accompanying screws) away from the work area to prevent damage.

Plastic parts

 **CAUTION:** Using excessive force during disassembly and reassembly can damage plastic parts. Use care when handling the plastic parts. Apply pressure only at the points designated in the maintenance instructions.

Cables and connectors

 **CAUTION:** When servicing the computer, be sure that cables are placed in their proper locations during the reassembly process. Improper cable placement can damage the computer.

Cables must be handled with extreme care to avoid damage. Apply only the tension required to unseat or seat the cables during removal and insertion. Handle cables by the connector whenever possible. In all cases, avoid bending, twisting, or tearing cables. Be sure that cables are routed in such a way that they cannot be caught or snagged by parts being removed or replaced. Handle flex cables with extreme care; these cables tear easily.

Drive handling

⚠ CAUTION: Drives are fragile components that must be handled with care. To prevent damage to the computer, damage to a drive, or loss of information, observe these precautions:

Before removing or inserting a hard drive, shut down the computer. If you are unsure whether the computer is off or in Hibernation, turn the computer on, and then shut it down through the operating system.

Before handling a drive, be sure that you are discharged of static electricity. While handling a drive, avoid touching the connector.

Before removing a diskette drive or optical drive, be sure that a diskette or disc is not in the drive and be sure that the optical drive tray is closed.

Handle drives on surfaces covered with at least one inch of shock-proof foam.

Avoid dropping drives from any height onto any surface.

After removing a hard drive, an optical drive, or a diskette drive, place it in a static-proof bag.

Avoid exposing an internal hard drive to products that have magnetic fields, such as monitors or speakers.

Avoid exposing a drive to temperature extremes or liquids.

If a drive must be mailed, place the drive in a bubble pack mailer or other suitable form of protective packaging and label the package "FRAGILE."

Grounding guidelines

Electrostatic discharge damage

Electronic components are sensitive to electrostatic discharge (ESD). Circuitry design and structure determine the degree of sensitivity. Networks built into many integrated circuits provide some protection, but in many cases, ESD contains enough power to alter device parameters or melt silicon junctions.

A discharge of static electricity from a finger or other conductor can destroy static-sensitive devices or microcircuitry. Even if the spark is neither felt nor heard, damage may have occurred.

An electronic device exposed to ESD may not be affected at all and can work perfectly throughout a normal cycle. Or the device may function normally for a while, then degrade in the internal layers, reducing its life expectancy.

⚠ CAUTION: To prevent damage to the computer when you are removing or installing internal components, observe these precautions:

Keep components in their electrostatic-safe containers until you are ready to install them.

Before touching an electronic component, discharge static electricity by using the guidelines described in this section.

Avoid touching pins, leads, and circuitry. Handle electronic components as little as possible.

If you remove a component, place it in an electrostatic-safe container.

The following table shows how humidity affects the electrostatic voltage levels generated by different activities.

⚠ CAUTION: A product can be degraded by as little as 700 V.

| Typical electrostatic voltage levels | | | |
|--------------------------------------|-------------------|----------|---------|
| Event | Relative humidity | | |
| | 10% | 40% | 55% |
| Walking across carpet | 35,000 V | 15,000 V | 7,500 V |
| Walking across vinyl floor | 12,000 V | 5,000 V | 3,000 V |
| Motions of bench worker | 6,000 V | 800 V | 400 V |
| Removing DIPS from plastic tube | 2,000 V | 700 V | 400 V |
| Removing DIPS from vinyl tray | 11,500 V | 4,000 V | 2,000 V |
| Removing DIPS from Styrofoam | 14,500 V | 5,000 V | 3,500 V |
| Removing bubble pack from PCB | 26,500 V | 20,000 V | 7,000 V |
| Packing PCBs in foam-lined box | 21,000 V | 11,000 V | 5,000 V |

Packaging and transporting guidelines

Follow these grounding guidelines when packaging and transporting equipment:

- To avoid hand contact, transport products in static-safe tubes, bags, or boxes.
- Protect ESD-sensitive parts and assemblies with conductive or approved containers or packaging.
- Keep ESD-sensitive parts in their containers until the parts arrive at static-free workstations.
- Place items on a grounded surface before removing items from their containers.
- Always be properly grounded when touching a component or assembly.
- Store reusable ESD-sensitive parts from assemblies in protective packaging or nonconductive foam.
- Use transporters and conveyors made of antistatic belts and roller bushings. Be sure that mechanized equipment used for moving materials is wired to ground and that proper materials are selected to avoid static charging. When grounding is not possible, use an ionizer to dissipate electric charges.

Workstation guidelines

Follow these grounding workstation guidelines:

- Cover the workstation with approved static-shielding material.
- Use a wrist strap connected to a properly grounded work surface and use properly grounded tools and equipment.
- Use conductive field service tools, such as cutters, screwdrivers, and vacuums.
- When fixtures must directly contact dissipative surfaces, use fixtures made only of static-safe materials.
- Keep the work area free of nonconductive materials, such as ordinary plastic assembly aids and Styrofoam.
- Handle ESD-sensitive components, parts, and assemblies by the case or PCM laminate. Handle these items only at static-free workstations.
- Avoid contact with pins, leads, or circuitry.
- Turn off power and input signals before inserting or removing connectors or test equipment.

Equipment guidelines

Grounding equipment must include either a wrist strap or a foot strap at a grounded workstation.

- When seated, wear a wrist strap connected to a grounded system. Wrist straps are flexible straps with a minimum of one megohm $\pm 10\%$ resistance in the ground cords. To provide proper ground, wear a strap snugly against the skin at all times. On grounded mats with banana-plug connectors, use alligator clips to connect a wrist strap.
- When standing, use foot straps and a grounded floor mat. Foot straps (heel, toe, or boot straps) can be used at standing workstations and are compatible with most types of shoes or boots. On conductive floors or dissipative floor mats, use foot straps on both feet with a minimum of one megohm resistance between the operator and ground. To be effective, the conductive must be worn in contact with the skin.

The following grounding equipment is recommended to prevent electrostatic damage:

- Antistatic tape
- Antistatic smocks, aprons, and sleeve protectors
- Conductive bins and other assembly or soldering aids
- Nonconductive foam
- Conductive tabletop workstations with ground cords of one megohm resistance
- Static-dissipative tables or floor mats with hard ties to the ground
- Field service kits
- Static awareness labels
- Material-handling packages
- Nonconductive plastic bags, tubes, or boxes
- Metal tote boxes
- Electrostatic voltage levels and protective materials

The following table lists the shielding protection provided by antistatic bags and floor mats.

| Material | Use | Voltage protection level |
|-----------------------|------------|---------------------------------|
| Antistatic plastics | Bags | 1,500 V |
| Carbon-loaded plastic | Floor mats | 7,500 V |
| Metallized laminate | Floor mats | 5,000 V |

Component replacement procedures

This chapter provides removal and replacement procedures.

There are as many as 67 screws that must be removed, replaced, or loosened when servicing the computer. Make special note of each screw and screw lock size and location during removal and replacement.

Service tag

When ordering parts or requesting information, provide the computer serial number and model number provided on the service tag.

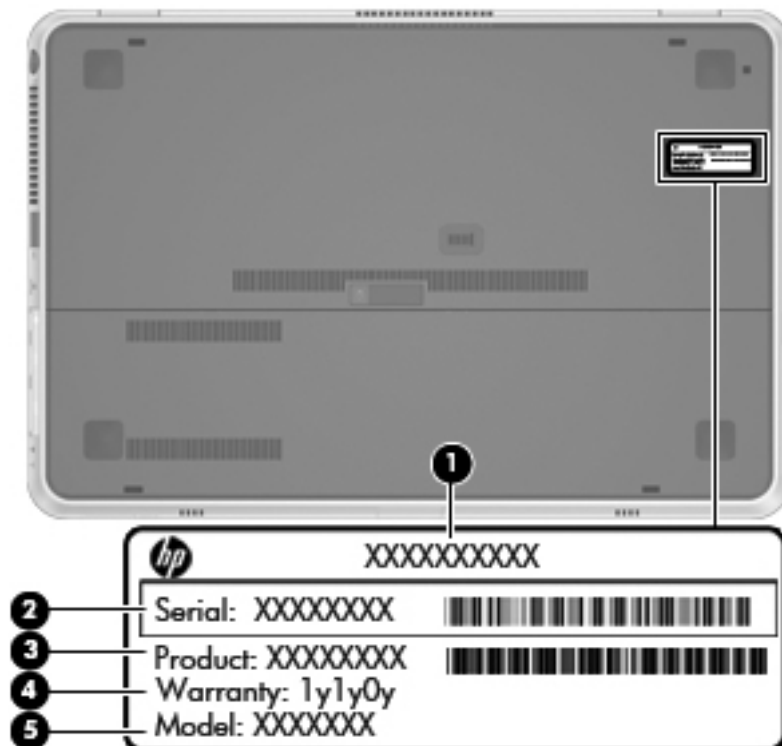

| Item | Component | Description |
|------|----------------------------------|---|
| (1) | Product name | This is the product name affixed to the front of the computer. |
| (2) | Serial number (s/n) | This is an alphanumeric identifier that is unique to each product. |
| (3) | Part number/Product number (p/n) | This number provides specific information about the product's hardware components. The part number helps a service technician determine what components and parts are needed. |
| (4) | Warranty period | This number describes the duration of the warranty period for the computer. |
| (5) | Model description | This is the alphanumeric identifier used to locate documents, drivers, and support for the computer. |

Computer feet

The computer feet are adhesive-backed rubber pads. There are 4 rubber feet that attach to the base enclosure in the locations illustrated below.

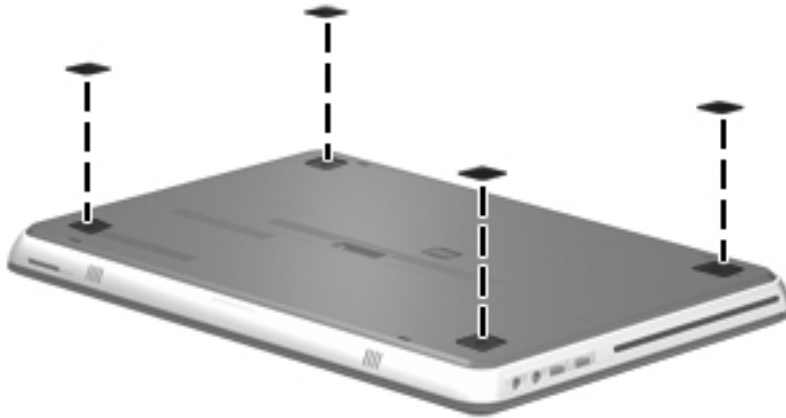

Battery

| Description | Spare part number |
|--|-------------------|
| 8-cell, 59-Wh, 2.00-Ah, Li-ion battery | 593548-001 |
| 6-cell, 62-Wh, 2.80-Ah, Li-ion battery | 602410-001 |

Before disassembling the computer, follow these steps:

1. Shut down the computer. If you are unsure whether the computer is off or in Hibernation, turn the computer on, and then shut it down through the operating system.
2. Disconnect all external devices connected to the computer.
3. Disconnect the power from the computer by first unplugging the power cord from the AC outlet and then unplugging the AC adapter from the computer.

Remove the battery:

1. Slide the battery cover release latch **(1)**. (The battery cover **(2)** releases forward).

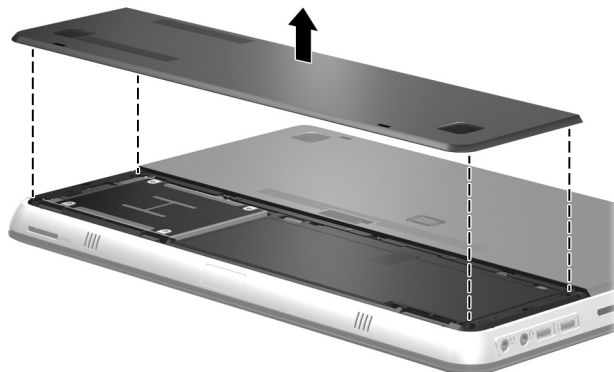

2. Remove the battery cover. The battery cover is included in the Door Kit, spare part numbers 661376-001 (for use only with Beats Edition computer models) and 661375-001 (for use only with standard computer models).

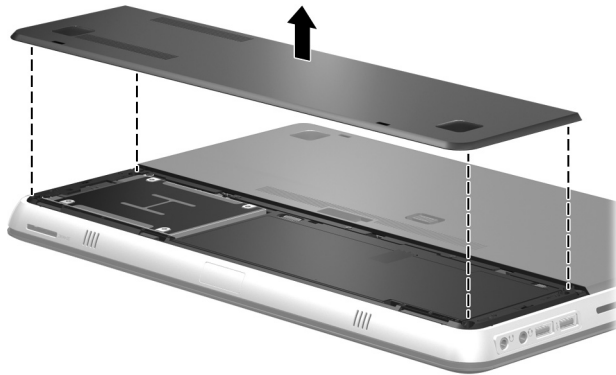

3. Slide the right battery release latch **(1)** to unlock the battery.
4. Slide and hold the left battery release latch **(2)** to release the battery.
5. Pull the battery tab **(3)**, and then remove the battery from the computer.

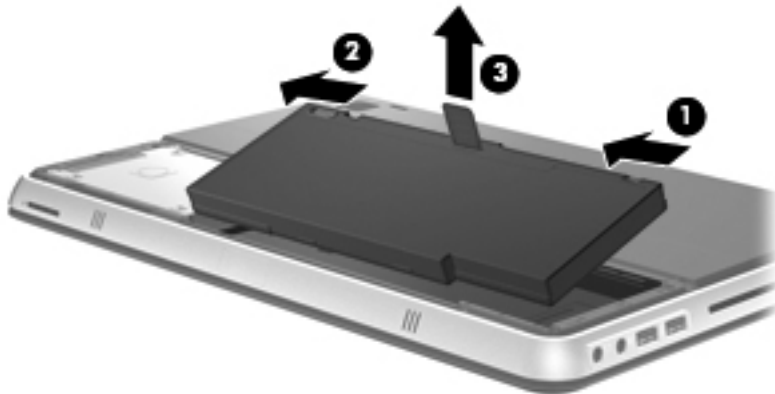

To insert the battery:

1. Align the tabs on the front edge of the battery with the notches on the front edge of the battery bay.
2. Rotate the rear edge of the battery down into the battery bay until it is seated.
3. Slide the right battery release latch to lock the battery into place. (The left battery release latch will automatically lock into place.)
4. Replace the battery cover, and then slide the battery cover back until it is seated. (The battery cover release latch will automatically lock into place.)

Mass storage device



NOTE: The mass storage device spare part kit does not include a bracket or screws.

| Description | Spare part number |
|--|-------------------|
| Hard drive: | |
| 750-GB, 7200-rpm | 633252-001 |
| 640-GB, 7200-rpm | 621046-001 |
| 500-GB, 7200-rpm | 634921-001 |
| 320-GB, 7200-rpm | 641672-001 |
| 160-GB SATA solid-state drive | 608367-001 |
| mSATA solid-state drive: | |
| 128-GB mSATA solid-state drive | 657878-001 |
| 80-GB mSATA solid-state drive | 657877-001 |
| Hard Drive Hardware Kit (includes hard drive bracket and screws) | 608373-001 |

Before removing the mass storage device, follow these steps:

1. Shut down the computer. If you are unsure whether the computer is off or in Hibernation, turn the computer on, and then shut it down through the operating system.
2. Disconnect all external devices connected to the computer.
3. Disconnect the power from the computer by first unplugging the power cord from the AC outlet and then unplugging the AC adapter from the computer.
4. Remove the battery cover and battery (see [Battery on page 36](#)).

Remove the mass storage device:

1. Remove the four Phillips PM2.0×2.83 screws that secure the mass storage device to the computer.

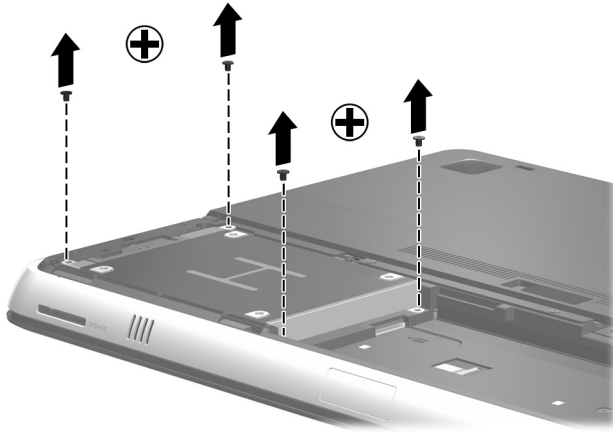

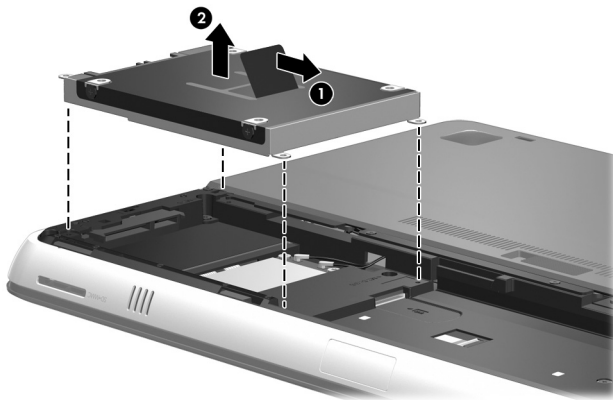

2. Use the tab **(1)** to slide the mass storage device to the right and disconnect it from the system board.
3. Lift the mass storage device **(2)** out of the mass storage device bay.

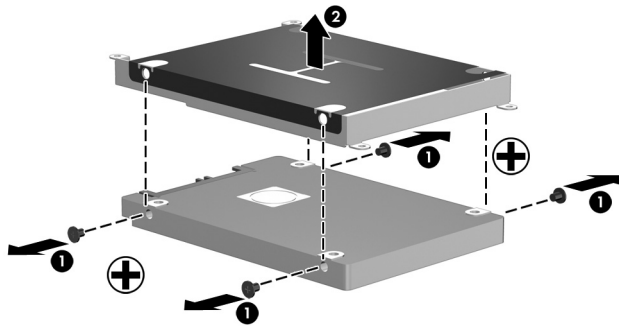

4. If it is necessary to replace the mass storage device bracket, remove the four Phillips PM3.0×3.37 screws **(1)** that secure the bracket to the mass storage device.

5. Remove the mass storage device bracket **(2)**. The mass storage device bracket and screws are included in the Hard Drive Hardware Kit, spare part number 608373-001.



 **NOTE:** Select computer models are equipped with an mSATA solid-state drive. This drive is located beneath the hard drive. If it is necessary to replace the mSATA solid-state drive, follow these steps:

6. Remove the hard drive.
7. Remove the two Phillips PM2.0x2.83 screws that secure the mSATA solid-state drive to the system board. (The mSATA solid-state drive tilts up.)

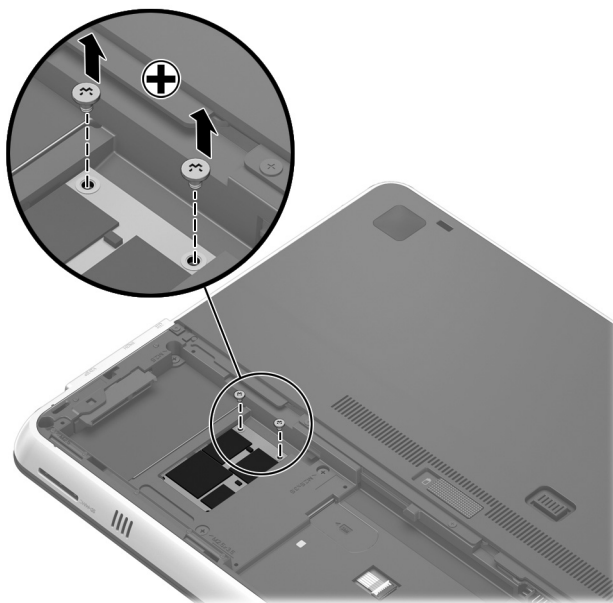

8. Remove the mSATA solid-state drive by pulling the drive away from the slot at an angle.

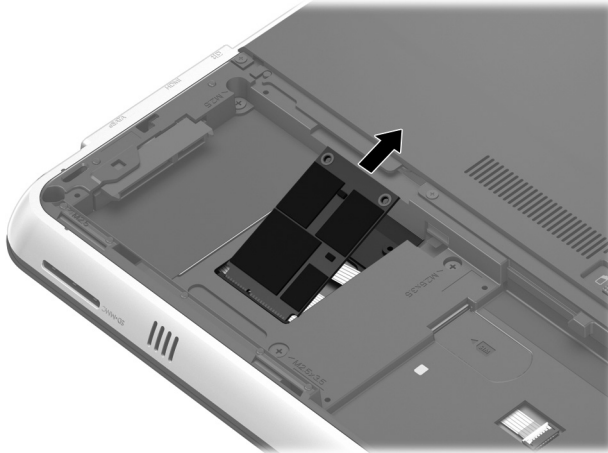

Reverse this procedure to reassemble and install the mass storage device.

WLAN module

| Description | Spare part number |
|--|-------------------|
| Intel Centrino Advanced-N 6230 WLAN module | 636672-001 |
| Intel Centrino Ultimate-N 6300 WLAN module | 572511-001 |

CAUTION: To prevent an unresponsive system, replace the wireless module only with a wireless module authorized for use in the computer by the governmental agency that regulates wireless devices in your country or region. If you replace the module and then receive a warning message, remove the module to restore device functionality, and then contact technical support.

Before removing the WLAN module, follow these steps:

1. Shut down the computer. If you are unsure whether the computer is off or in Hibernation, turn the computer on, and then shut it down through the operating system.
2. Disconnect all external devices connected to the computer.
3. Disconnect the power from the computer by first unplugging the power cord from the AC outlet and then unplugging the AC adapter from the computer.
4. Remove the battery cover and battery (see [Battery on page 36](#)).

Remove the WLAN module:

1. Remove the five Phillips PM2.0×2.83 screws **(1)** that secure the memory module/wireless module compartment cover to the computer.

2. Slide the memory module/wireless module compartment cover **(2)** toward the back of the computer until the tabs on the cover disengage from the slots in the base enclosure.

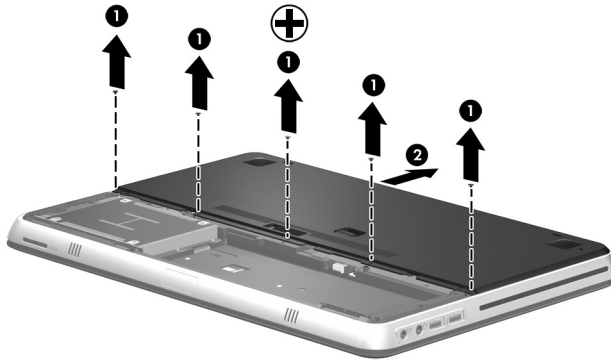

3. Remove the memory module/wireless module compartment cover. The memory module/wireless module compartment cover is included in the Door Kit, spare part numbers 661375-001 (for use only with Beats Edition computer models) and 661376-001 (for use only with standard computer models).

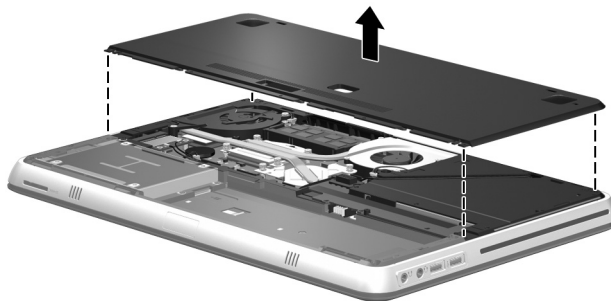

4. Disconnect the WLAN antenna cables from the terminals on the WLAN module.

 **NOTE:** The 1/black WLAN antenna cable is connected to the WLAN module 1/Main/Tr1 terminal. The 2/gray WLAN antenna cable is connected to the WLAN module 2/Aux/Tr2 terminal. If a 3/yellow antenna cable is present, it is connected to the 3/Tr3 terminal.

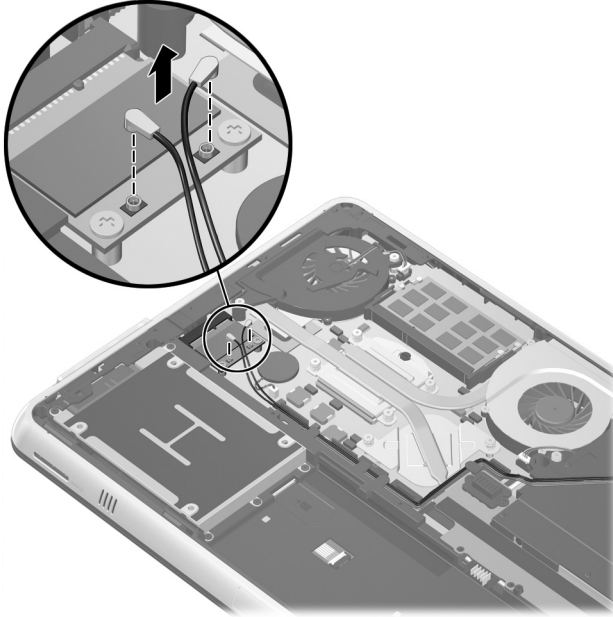

5. Remove the two Phillips PM2.0×2.83 screws that secure the WLAN module to the system board. (The WLAN module tilts up.)

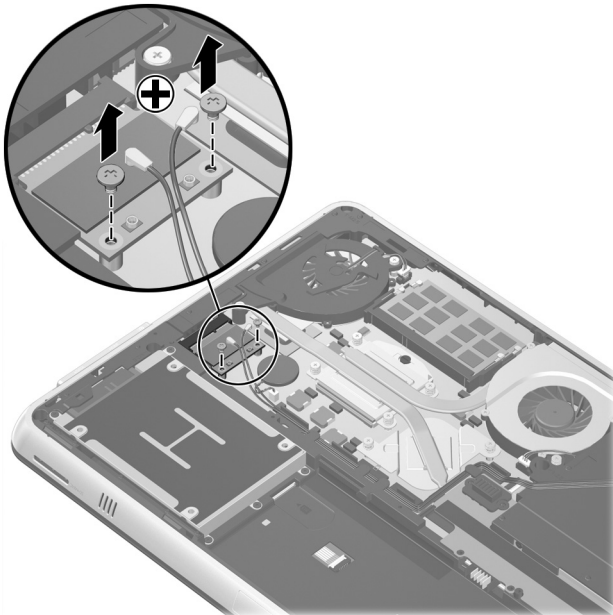

6. Remove the WLAN module by pulling the module away from the slot at an angle.

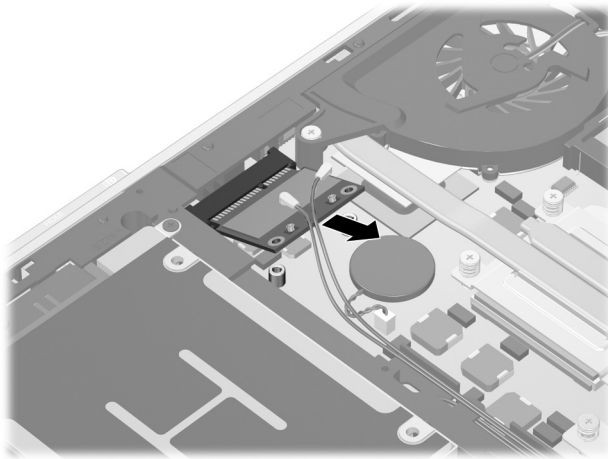

 **NOTE:** If the WLAN antennas are not connected to the terminals on the WLAN module, the protective sleeves must be installed on the antenna connectors, as shown in the following illustration.

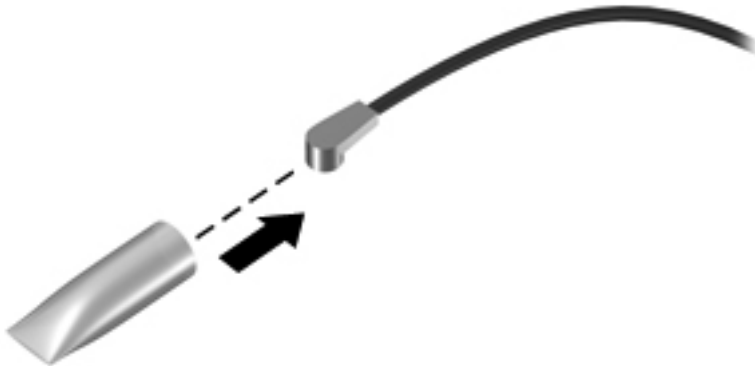

Reverse this procedure to install the WLAN module.

RTC battery

| Description | Spare part number |
|-------------|-------------------|
| RTC battery | 581926-001 |

Before removing the RTC battery, follow these steps:

1. Shut down the computer. If you are unsure whether the computer is off or in Hibernation, turn the computer on, and then shut it down through the operating system.
2. Disconnect all external devices connected to the computer.
3. Disconnect the power from the computer by first unplugging the power cord from the AC outlet and then unplugging the AC adapter from the computer.

4. Remove the battery cover and battery (see [Battery on page 36](#)).
5. Remove the memory module/wireless module compartment cover (see [WLAN module on page 41](#)).

Remove the RTC battery:

1. Disconnect the RTC battery cable from the system board.

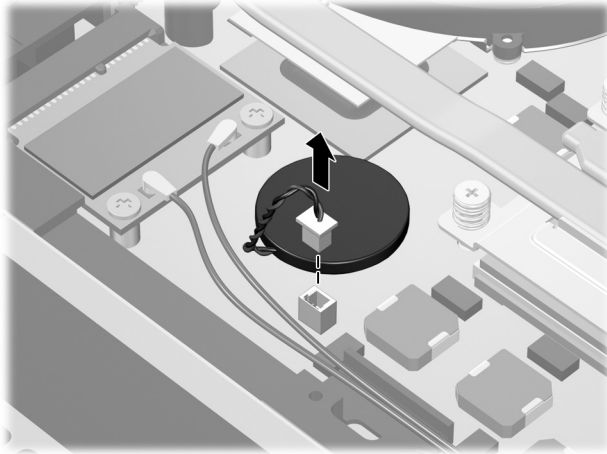

2. Remove the RTC battery from the system board. The RTC battery is attached to the system board with double-sided tape.

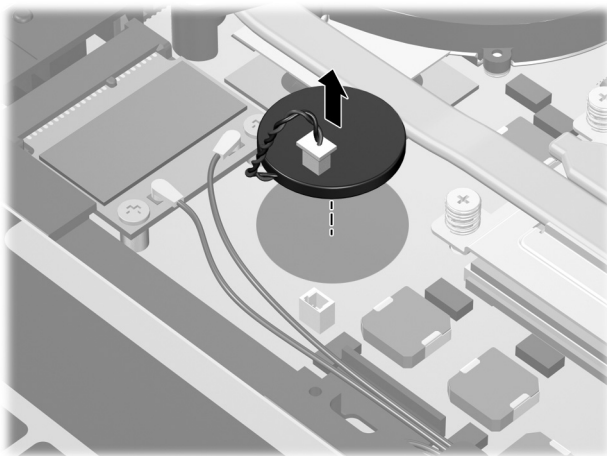

Reverse this procedure to install the RTC battery.

Memory module

| Description | Spare part number |
|--|-------------------|
| 4096-MB memory module (PC3, 12800, 1600-MHz) | 641369-001 |
| 8196-MB memory module (PC3, 10600, 1333-MHz) | 634091-001 |
| 4096-MB memory module (PC3, 10600, 1333-MHz) | 621569-001 |
| 2048-MB memory module (PC3, 10600, 1333-MHz) | 581096-001 |

Before removing a memory module, follow these steps:

1. Shut down the computer. If you are unsure whether the computer is off or in Hibernation, turn the computer on, and then shut it down through the operating system.
2. Disconnect all external devices connected to the computer.
3. Disconnect the power from the computer by first unplugging the power cord from the AC outlet and then unplugging the AC adapter from the computer.
4. Remove the battery cover and battery (see [Battery on page 36](#)).
5. Remove the memory module/wireless module compartment cover (see [WLAN module on page 41](#)).

Remove the memory module:

1. Spread the retaining tabs **(1)** on each side of the memory module slot to release the memory module. (The memory module tilts up.)
2. Remove the memory module **(2)** by pulling it away from the slot at an angle.

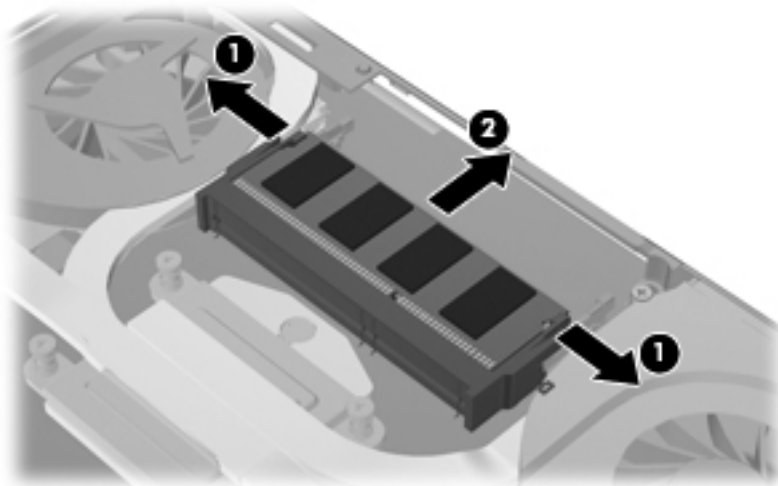

Reverse this procedure to install a memory module.

Battery connector board

| Description | Spare part number |
|--|-------------------|
| Battery connector board (includes cable) | 654172-001 |

Before removing the battery connector board, follow these steps:

1. Shut down the computer. If you are unsure whether the computer is off or in Hibernation, turn the computer on, and then shut it down through the operating system.
2. Disconnect all external devices connected to the computer.
3. Disconnect the power from the computer by first unplugging the power cord from the AC outlet and then unplugging the AC adapter from the computer.
4. Remove the battery cover and battery (see [Battery on page 36](#)).
5. Remove the memory module/wireless module compartment cover (see [WLAN module on page 41](#)).

Remove the battery connector board:

1. Remove the plastic cover **(1)** located at the base of the accessory battery connector.
2. Remove the two Phillips PM2.5×3.86 screws **(2)** and the three Phillips PM2.0×2.83 screws **(3)** that secure the battery charger board to the base enclosure.
3. Release the zero insertion force (ZIF) connector to which the battery charger board cable is connected, and then disconnect the cable **(4)** from the connector.

4. Release the battery charger board **(5)** as far as the power cable allows.

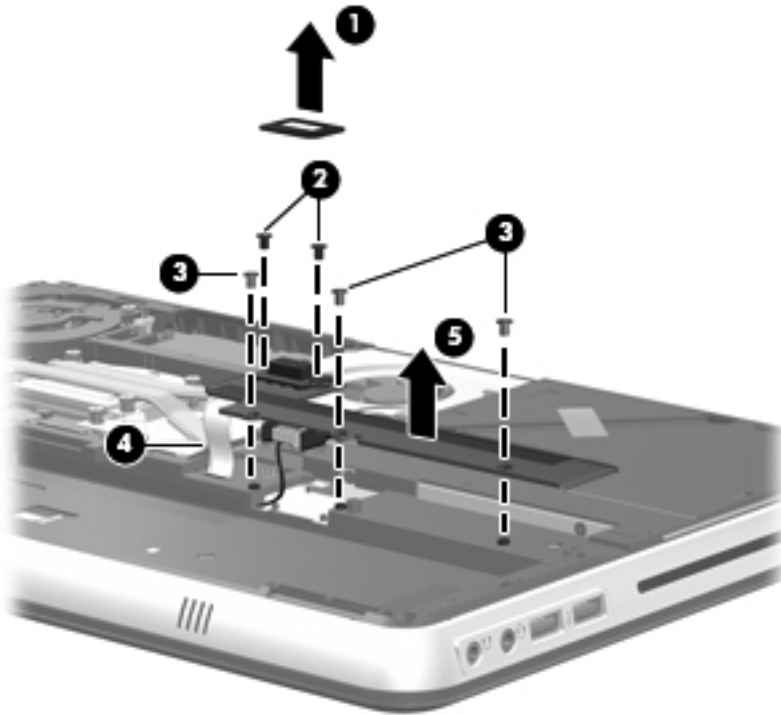

5. Swing the rear edge of the battery charger board **(1)** up and forward until it rests upside down in the battery bay.
6. Disconnect the power extension cable **(2)** from the battery charger board.
7. Remove the battery charger board **(3)**.

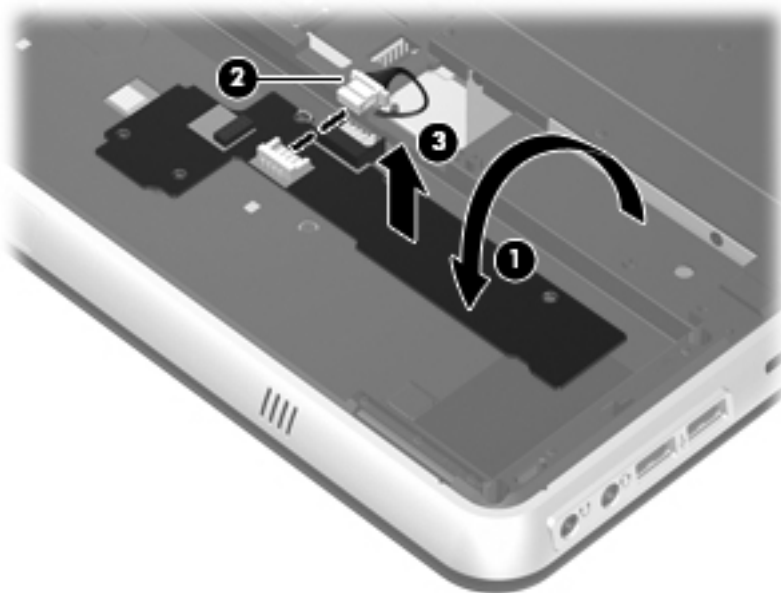

Reverse this procedure to install the battery charger board.

Top cover

 **NOTE:** The top cover spare part kit includes the power button board and cable and TouchPad and cable.

| Description | Spare part number |
|---|-------------------|
| For use only with Beats Edition computer models | 658005-001 |
| For use only with standard computer models | 658004-001 |

Before removing the top cover, follow these steps:

1. Shut down the computer. If you are unsure whether the computer is off or in Hibernation, turn the computer on, and then shut it down through the operating system.
2. Disconnect all external devices connected to the computer.
3. Disconnect the power from the computer by first unplugging the power cord from the AC outlet and then unplugging the AC adapter from the computer.
4. Remove the battery cover and battery (see [Battery on page 36](#)).
5. Remove the memory module/wireless module compartment cover (see [WLAN module on page 41](#)).

Remove the top cover:

1. Remove the eight Phillips PM2.5×6.67 screws that secure the top cover to the computer.

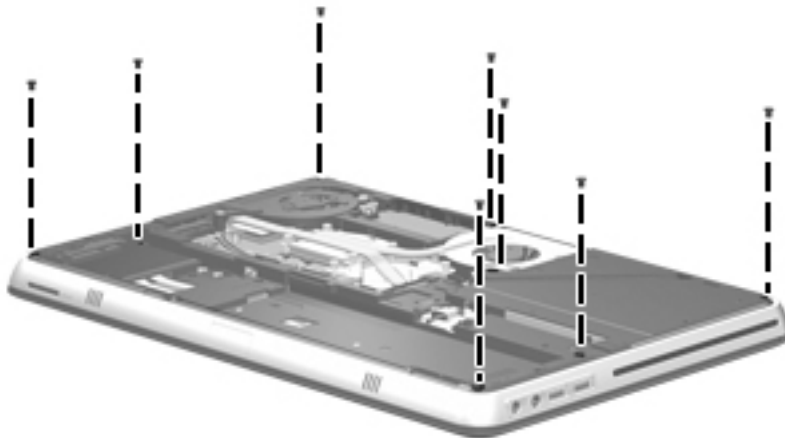

2. Remove the four Phillips PM2.0×3.92 screws that secure the top cover to the computer in the battery bay.



3. Turn the computer right side up, with the front toward you.
4. Open the computer as far as it will open.
5. Lift the front edge of top cover **(1)** until the TouchPad cable is accessible.
6. Release the ZIF connector to which the TouchPad cable is attached, and then disconnect the cable **(2)** from the system board.

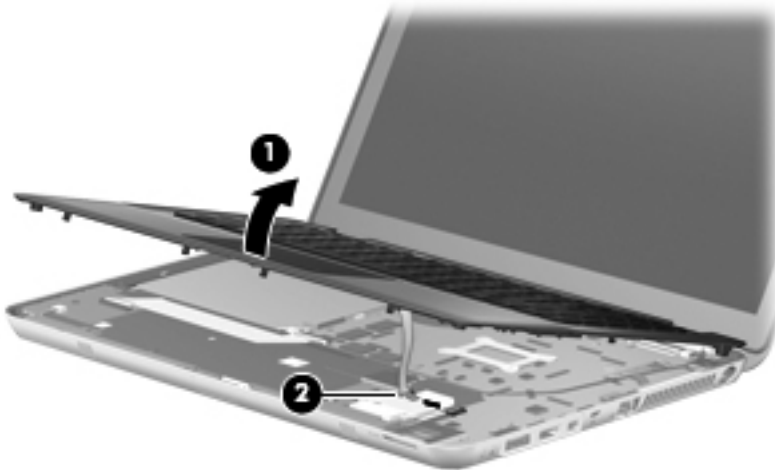

7. Slide the top cover **(1)** forward until the power button board cable, keyboard cable, and keyboard light cable are accessible.
8. Release the power button board cable **(2)** from the fan surface. (The power button board cable is attached to the fan surface with double-sided tape.)
9. Disconnect the power button board cable **(3)** from the system board.
10. Release the ZIF connector to which the keyboard light cable is attached, and then disconnect the cable **(4)** from the system board.

11. Release the ZIF connector to which the keyboard cable is attached, and then disconnect the cable **(5)** from the system board.

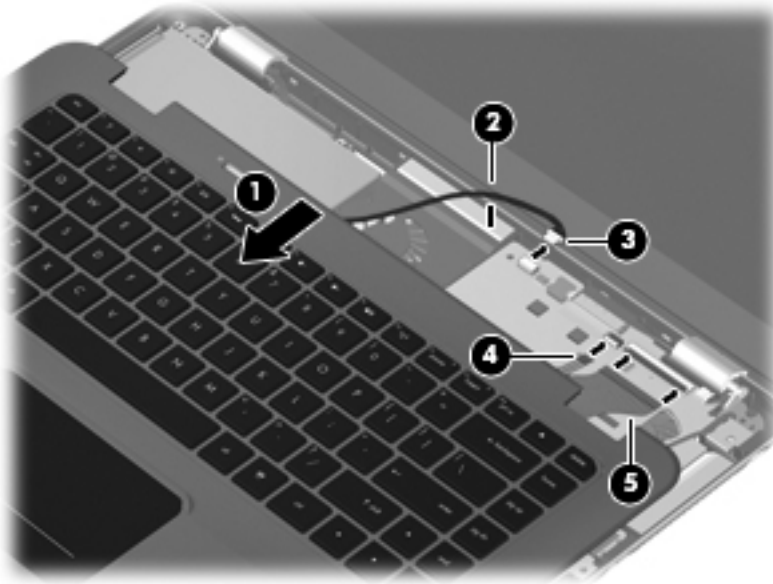

12. Remove the top cover.

Reverse this procedure to install the top cover.

Keyboard



NOTE: The keyboard spare part kit includes a keyboard cable and a keyboard light cable.

| For use in country or region: | Spare part number | For use in country or region: | Spare part number |
|---|--------------------------|---|--------------------------|
| For use only with Beats Edition computer models: | | | |
| • For use in Belgium | 619400-A41 | • For use in Portugal | 619400-131 |
| • For use in Brazil | 619400-201 | • For use in Russia | 619400-251 |
| • For use in Canada | 619400-121 | • For use in Saudi Arabia | 619400-171 |
| • For use in Denmark, Finland, and Norway | 619400-DH1 | • For use in South Korea | 619400-AD1 |
| • For use in France | 619400-051 | • For use in Spain | 619400-071 |
| • For use in Germany | 619400-041 | • For use in Switzerland | 619400-BG1 |
| • For use in India | 619400-D61 | • For use in Taiwan | 619400-AD1 |
| • For use in Italy | 619400-061 | • For use in Thailand | 619400-281 |
| • For use in Japan | 619400-291 | • For use in Turkey | 619400-141 |
| • For use in Latin America | 619400-161 | • For use in the United Kingdom and Singapore | 619400-031 |
| • For use in the Netherlands | 619400-161 | • For use in the United States | 619400-001 |
| For use only with standard computer models: | | | |
| • For use in Belgium | 608375-A41 | • For use in Portugal | 608375-131 |
| • For use in Brazil | 608375-201 | • For use in Russia | 608375-251 |
| • For use in Canada | 608375-121 | • For use in Saudi Arabia | 608375-171 |
| • For use in Denmark, Finland, and Norway | 608375-DH1 | • For use in South Korea | 608375-AD1 |
| • For use in France | 608375-051 | • For use in Spain | 608375-171 |
| • For use in Germany | 608375-041 | • For use in Switzerland | 608375-BG1 |
| • For use in India | 608375-D61 | • For use in Taiwan | 608375-AB1 |
| • For use in Italy | 608375-061 | • For use in Thailand | 608375-281 |
| • For use in Japan | 608375-291 | • For use in Turkey | 608375-141 |
| • For use Latin America | 608375-161 | • For use in the United Kingdom and Singapore | 608375-031 |
| • For use in the Netherlands | 608375-B31 | • For use in the United States | 608375-001 |

Before removing the keyboard, follow these steps:

1. Shut down the computer. If you are unsure whether the computer is off or in Hibernation, turn the computer on, and then shut it down through the operating system.
2. Disconnect all external devices connected to the computer.
3. Disconnect the power from the computer by first unplugging the power cord from the AC outlet and then unplugging the AC adapter from the computer.
4. Remove the battery cover and battery (see [Battery on page 36](#)).
5. Remove the memory module/wireless module compartment cover (see [WLAN module on page 41](#)).
6. Remove the top cover (see [Top cover on page 49](#)).

Remove the keyboard:

1. Turn the top cover upside down, with the front toward you.
2. Press on the back of the keyboard **(1)** through the opening in the top cover until the keyboard disengages from the top cover.
3. Release the keyboard cable **(2)** and the keyboard light cable **(3)** through their respective openings in the top cover.

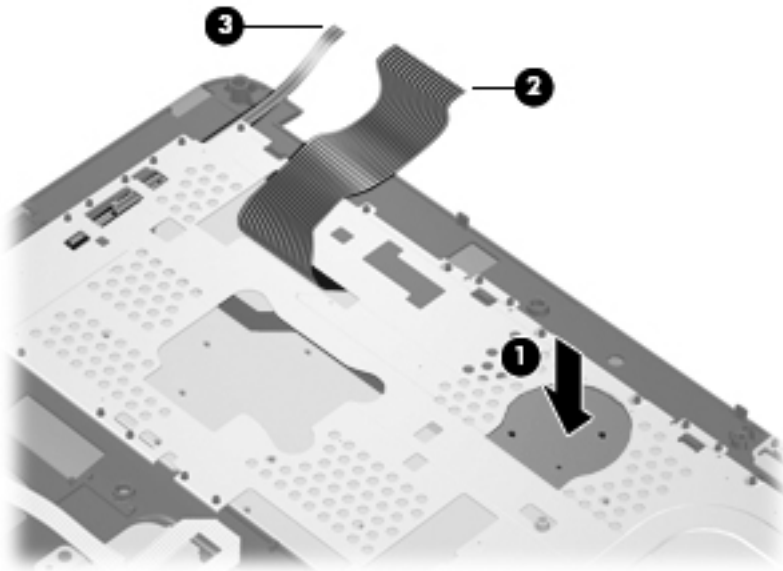

4. Turn the top cover and keyboard right-side up, with the front toward you.
5. Swing the rear edge of the keyboard **(1)** up and forward until it rests at an angle.

- Slide the keyboard **(2)** back at an angle until the tabs on the front edge of keyboard disengage from the slots in the top cover.

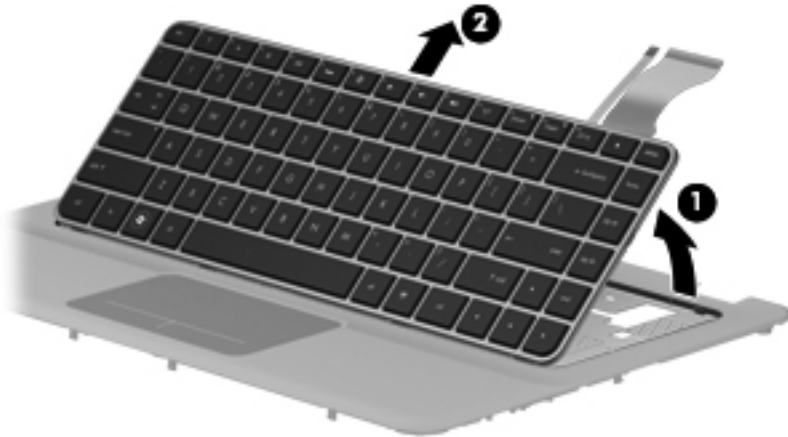

- Remove the keyboard.

Reverse this procedure to install the keyboard.

Audio/USB board

| Description | Spare part number |
|----------------------------------|-------------------|
| Audio/USB board (includes cable) | 654169-001 |

Before removing the audio/USB board, follow these steps:

- Shut down the computer. If you are unsure whether the computer is off or in Hibernation, turn the computer on, and then shut it down through the operating system.
- Disconnect all external devices connected to the computer.
- Disconnect the power from the computer by first unplugging the power cord from the AC outlet and then unplugging the AC adapter from the computer.
- Remove the battery cover and battery (see [Battery on page 36](#)).
- Remove the memory module/wireless module compartment cover (see [WLAN module on page 41](#)).
- Remove the top cover (see [Top cover on page 49](#)).

Remove the audio/USB board:

- Disconnect the speaker cable **(1)** from the audio/USB board.
- Release the ZIF connector to which the audio/USB board cable is attached, and then disconnect the cable **(2)** from the system board.
- Release the grounding tape **(3)** that secures the audio/USB board cable to the base enclosure.

4. Remove the Phillips PM2.5×3.82 screw **(4)** that secures the audio/USB board to the base enclosure.
5. Remove the audio/USB board **(5)** and cable.

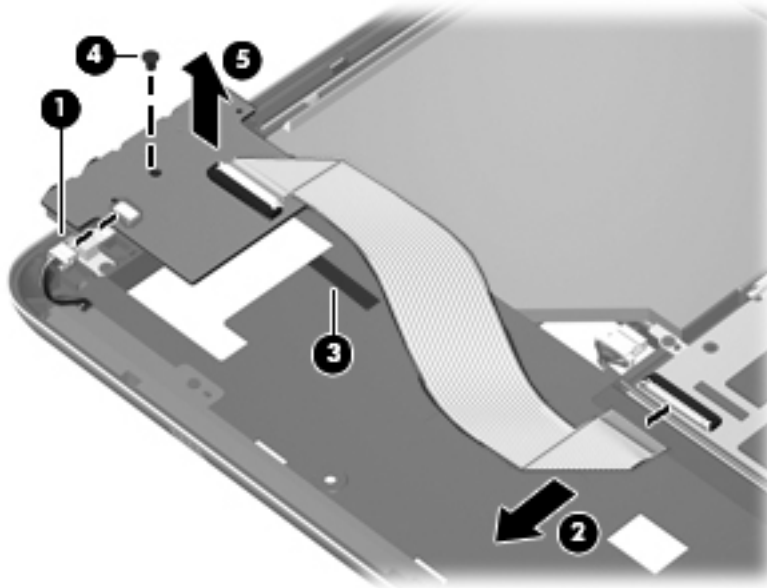

Reverse this procedure to install the audio/USB board and cable.

Bluetooth module

 **NOTE:** The Bluetooth module spare part kit does not include a Bluetooth module cable. The Bluetooth module cable is included in the Cable Kit, spare part number 608385-001.

| Description | Spare part number |
|------------------|-------------------|
| Bluetooth module | 537921-001 |

Before removing the Bluetooth module, follow these steps:

1. Shut down the computer. If you are unsure whether the computer is off or in Hibernation, turn the computer on, and then shut it down through the operating system.
2. Disconnect all external devices connected to the computer.
3. Disconnect the power from the computer by first unplugging the power cord from the AC outlet and then unplugging the AC adapter from the computer.
4. Remove the battery cover and battery (see [Battery on page 36](#)).
5. Remove the memory module/wireless module compartment cover (see [WLAN module on page 41](#)).
6. Remove the top cover (see [Top cover on page 49](#)).

Remove the Bluetooth module:

1. Disconnect the Bluetooth module cable **(1)** from the solid-state drive connector board.
2. Release the grounding tape **(2)** that secures the Bluetooth module to the base enclosure.
3. Release the Bluetooth module cable **(3)** from the routing clips and channel built into the base enclosure.
4. Release the Bluetooth module **(4)** from the retention clip built into the base enclosure.

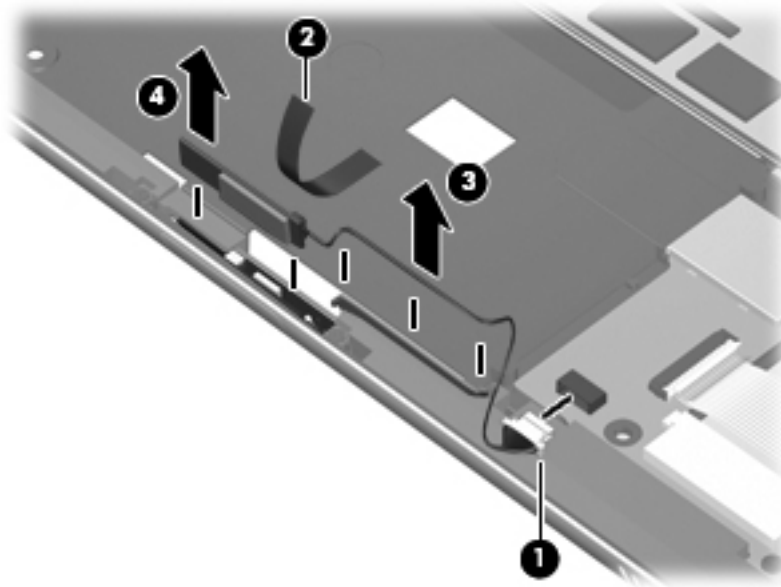

5. Remove the Bluetooth module and cable.

Reverse this procedure to install the Bluetooth module and cable.

Solid-state drive connector board

| Description | Spare part number |
|--|-------------------|
| For use only with computer models equipped with an mSATA solid-state drive | 654171-001 |
| For use only with computer models not equipped with an mSATA solid-state drive | 661706-001 |

Before removing the solid-state drive connector board, follow these steps:

1. Shut down the computer. If you are unsure whether the computer is off or in Hibernation, turn the computer on, and then shut it down through the operating system.
2. Disconnect all external devices connected to the computer.

3. Disconnect the power from the computer by first unplugging the power cord from the AC outlet and then unplugging the AC adapter from the computer.
4. Remove the battery cover and battery (see [Battery on page 36](#)), and then remove the following components:
 - a. Hard drive (see [Mass storage device on page 38](#))
 - b. Memory module/wireless module compartment cover (see [WLAN module on page 41](#))
 - c. Top cover (see [Top cover on page 49](#))

Remove the solid-state drive connector board:

1. Disconnect the Bluetooth module cable **(1)** from the solid-state drive connector board.
2. Release the ZIF connector to which the solid-state drive connector board cable is attached, and then disconnect the cable **(2)** from the system board.
3. Release the grounding tape **(3)** that secures the solid-state drive connector board cable to the base enclosure.
4. Remove the Phillips PM2.0×2.82 screw **(4)** that secures the solid-state drive connector board to the base enclosure.
5. Remove the solid-state drive connector board **(5)** and cable.

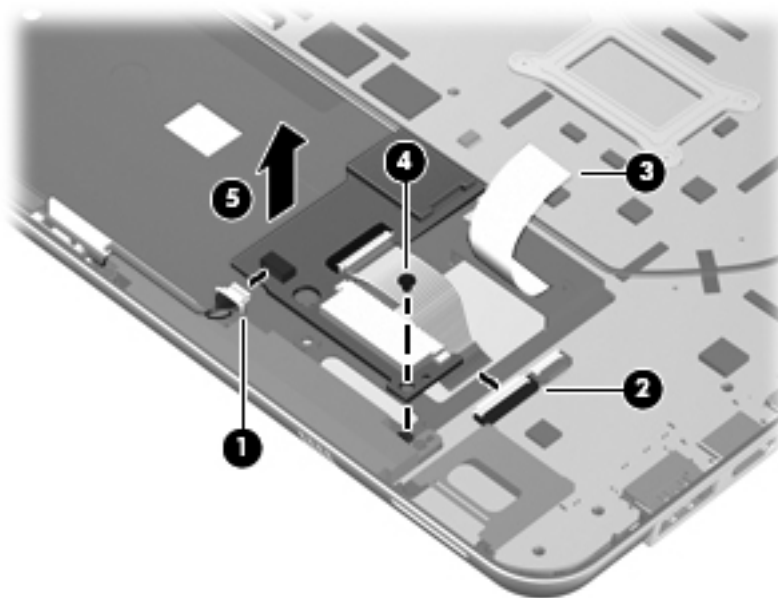

Reverse this procedure to install the solid-state drive connector board and cable.

Optical drive

| Description | Spare part number |
|---|-------------------|
| DVD±RW and CD-RW Super Multi Double-Layer Combo Drive with LightScribe (includes cable, connector board, and retention rails) | 657530-001 |

Before removing the optical drive, follow these steps:

1. Shut down the computer. If you are unsure whether the computer is off or in Hibernation, turn the computer on, and then shut it down through the operating system.
2. Disconnect all external devices connected to the computer.
3. Disconnect the power from the computer by first unplugging the power cord from the AC outlet and then unplugging the AC adapter from the computer.
4. Remove the battery cover and battery (see [Battery on page 36](#)).
5. Remove the memory module/wireless module compartment cover (see [WLAN module on page 41](#)).
6. Remove the top cover (see [Top cover on page 49](#)).

Remove the optical drive:

1. Close the computer.
2. Turn the computer upside down, with the front toward you.
3. Release the ZIF connector **(1)** to which the optical drive cable is attached, and then disconnect the cable **(2)** from the system board.

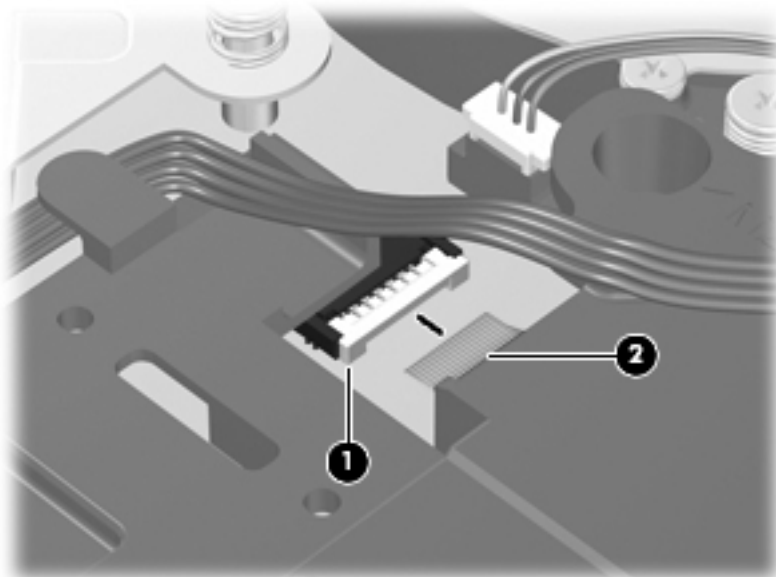

4. Turn the computer right-side up, with the front toward you.

5. Open the computer as far as it will open.
6. Remove the four Phillips PM2.0×2.82 screws **(1)** that secure the optical drive to the base enclosure.
7. Remove the optical drive **(2)**.

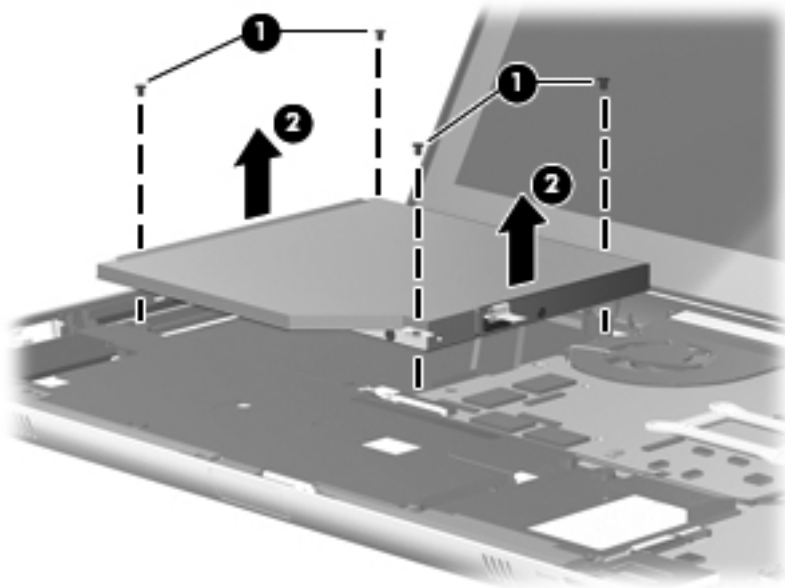

8. If it is necessary to replace the optical drive retention rails:
 - a. Remove the four Phillips PM2.0×2.82 screws **(1)** that secure the retention rails to the optical drive.
 - b. Remove the retention rails **(2)**.

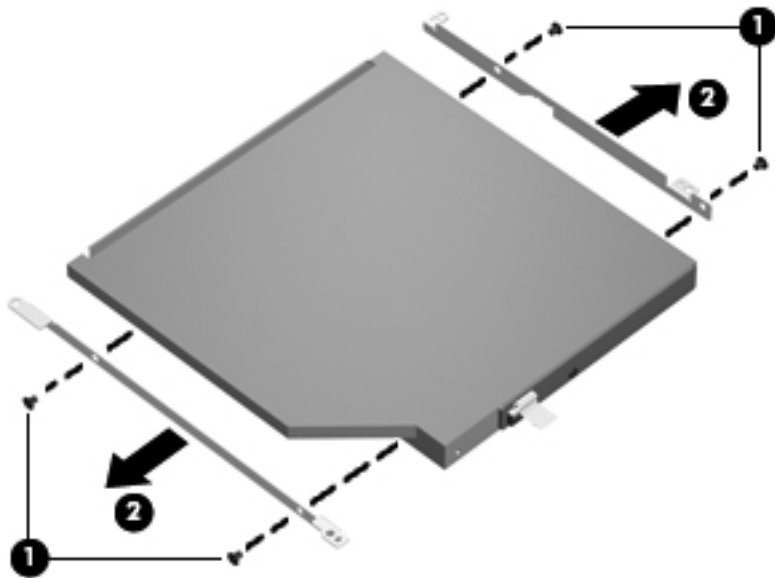

9. If it is necessary to replace the optical drive connector board:
 - a. Remove the Phillips PM2.0×2.82 screw **(1)** that secures the connector board to the optical drive.
 - b. Remove the connector board **(2)**.

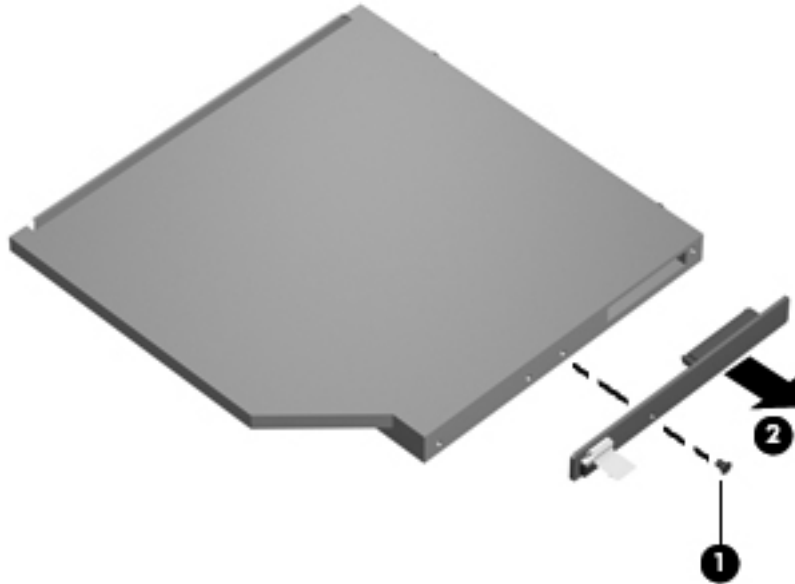

Reverse this procedure to install the optical drive cable.

Power connector cable

| Description | Spare part number |
|-----------------------|-------------------|
| Power connector cable | 654170-001 |

Before removing the power connector cable, follow these steps:

1. Shut down the computer. If you are unsure whether the computer is off or in Hibernation, turn the computer on, and then shut it down through the operating system.
2. Disconnect all external devices connected to the computer.
3. Disconnect the power from the computer by first unplugging the power cord from the AC outlet and then unplugging the AC adapter from the computer.
4. Remove the battery cover and battery (see [Battery on page 36](#)).
5. Remove the memory module/wireless module compartment cover (see [WLAN module on page 41](#)).
6. Remove the top cover (see [Top cover on page 49](#)).

Remove the power connector cable:

1. Disconnect the power extension cable **(1)** from the battery connector board.
2. Release the power extension cord **(2)** from the system board. (The power extension cord is attached to the system board with double-sided tape.)
3. Disconnect the power connector cable **(3)** from the system board.
4. Release the power connector **(4)** from the alignment clip built into the base enclosure.

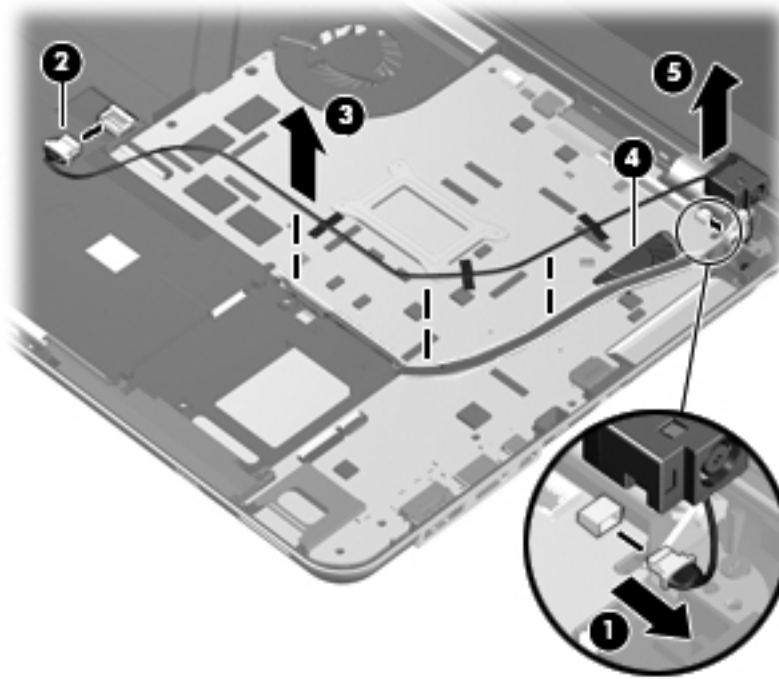

5. Remove the power connector cable.

Reverse this procedure to install the power connector cable.

System board

 **NOTE:** The system board spare part kit includes replacement thermal material. Replacement thermal material is also available in the Thermal Material Kit, spare part number 634366-001.

| Description | Spare part number |
|---|-------------------|
| System board equipped with Intel 6 series express chipset, Intel HM65 PCH, Radeon HD 6630M graphics subsystem with 1024-MB of discrete video memory | 654173-001 |

Before removing the system board, follow these steps:

1. Shut down the computer. If you are unsure whether the computer is off or in Hibernation, turn the computer on, and then shut it down through the operating system.
2. Disconnect all external devices connected to the computer.
3. Disconnect the power from the computer by first unplugging the power cord from the AC outlet and then unplugging the AC adapter from the computer.
4. Remove the battery cover and battery (see [Battery on page 36](#)).
5. Remove the hard drive (see [Mass storage device on page 38](#)).
6. Remove the memory module/wireless module compartment cover (see [WLAN module on page 41](#)).
7. Disconnect the battery charger board ribbon cable from the system board (see [Battery connector board on page 47](#)).
8. Remove the top cover (see [Top cover on page 49](#)).
9. Disconnect the optical drive cable from the system board (see [Optical drive on page 58](#)).

When replacing the system board, be sure that the following components are removed from the defective system board and installed on the replacement system board:

- WLAN module (see [WLAN module on page 41](#))
- RTC battery (see [RTC battery on page 44](#))
- Memory module (see [Memory module on page 46](#))
- Fan/heat sink assembly (see [Fan/heat sink assembly on page 65](#))
- Processor (see [Processor on page 67](#))

Remove the system board:

1. Release the ZIF connector to which the audio/USB board cable is attached, and then disconnect the cable **(1)** from the system board.

2. Release the ZIF connector to which the solid-state drive connector board cable is attached, and then disconnect the cable **(2)** from the system board.

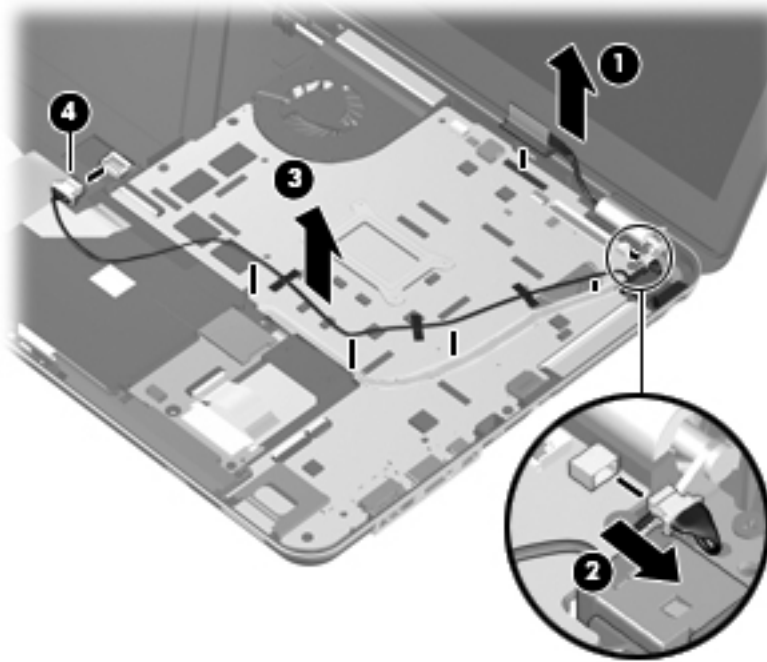

3. Disconnect the display panel cable **(1)** from the system board.
4. Disconnect the power connector cable **(2)** from the system board.
5. Disconnect the power extension cable **(3)** from the battery connector board.

6. Release the power extension cord **(4)** from the system board. (The power extension cord is attached to the system board with double-sided tape.)

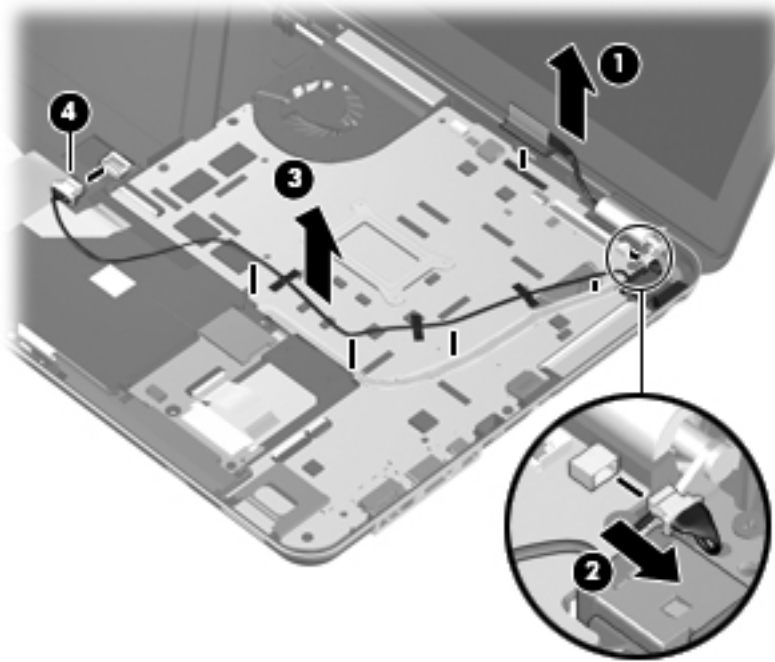

7. Remove the five Phillips PM2.5×3.83 screws that secure the system board to the base enclosure.

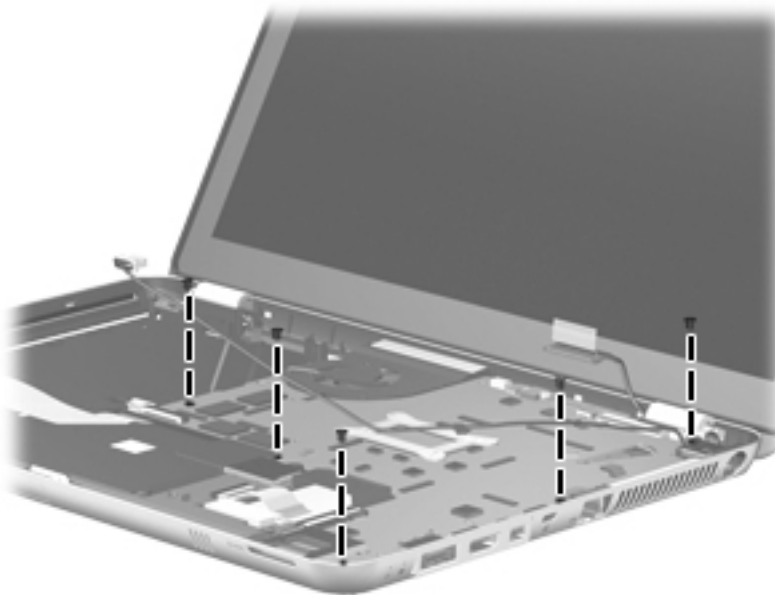

8. Lift the left side of the system board **(1)** until it rests at an angle.

9. Remove the system board **(2)** by sliding it up and to the left at an angle.

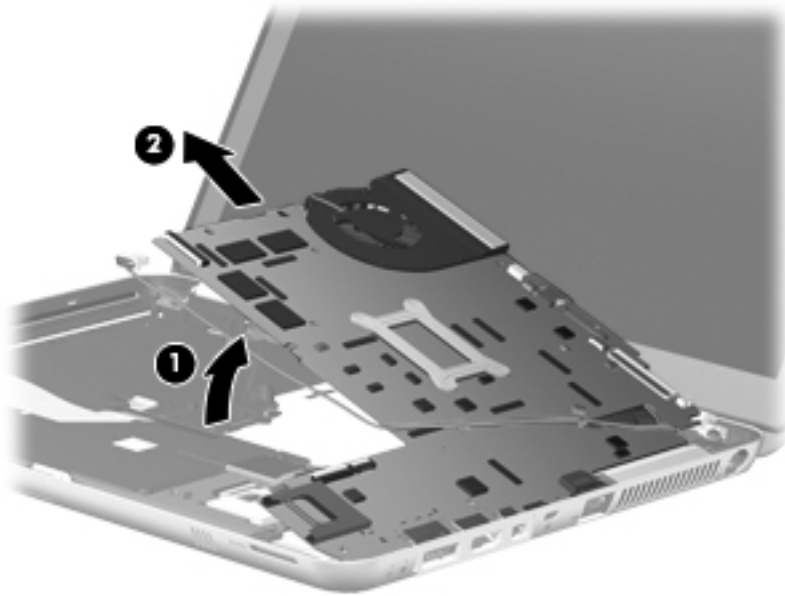

Reverse this procedure to install the system board.

Fan/heat sink assembly

| Description | Spare part number |
|--|-------------------|
| Fan/heat sink assembly (includes replacement thermal material) | 657529-001 |

 **NOTE:** To properly ventilate the computer, allow at least 7.6 cm (3 in) of clearance on the left side of the computer. The computer uses an electric fan for ventilation. The fan is controlled by a temperature sensor and is designed to turn on automatically when high temperature conditions exist. These conditions are affected by high external temperatures, system power consumption, power management/battery conservation configurations, battery fast charging, and software requirements. Exhaust air is displaced through the ventilation grill located on the left side of the computer.

Before removing the fan/heat sink assembly, follow these steps:

1. Shut down the computer. If you are unsure whether the computer is off or in Hibernation, turn the computer on, and then shut it down through the operating system.
2. Disconnect all external devices connected to the computer.
3. Disconnect the power from the computer by first unplugging the power cord from the AC outlet and then unplugging the AC adapter from the computer.
4. Remove the battery cover and battery (see [Battery on page 36](#)).
5. Remove the hard drive (see [Mass storage device on page 38](#)).
6. Remove the memory module/wireless module compartment cover (see [WLAN module on page 41](#)).

7. Disconnect the battery charger board ribbon cable from the system board (see [Battery connector board on page 47](#)).
8. Remove the top cover (see [Top cover on page 49](#)).
9. Disconnect the optical drive cable from the system board (see [Optical drive on page 58](#)).
10. Remove the system board (see [System board on page 62](#)).

Remove the fan/heat sink assembly:

1. Turn the system board upside down with the front toward you.
2. Disconnect the two fan cables **(1)** from the system board.
3. Loosen the nine captive screws **(2)** that secure the fan/heat sink assembly to the system board.
4. Remove the fan/heat sink assembly **(3)**.

 **NOTE:** Due to the adhesive quality of the thermal material located between the fan/heat sink assembly and system board components, it may be necessary to move the fan/heat sink assembly from side to side to detach it.

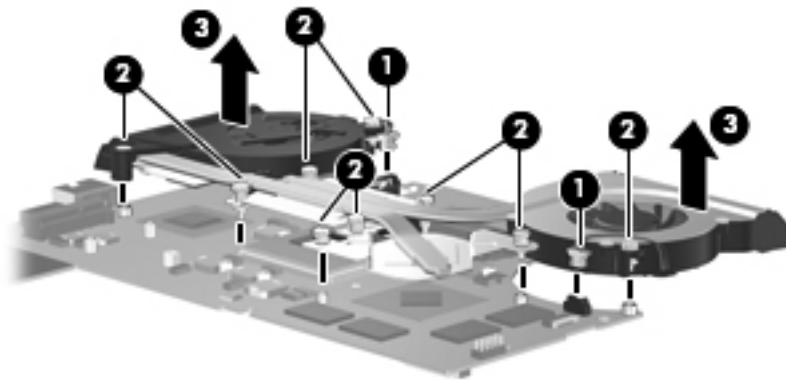

 **NOTE:** The thermal material must be thoroughly cleaned from the surfaces of the fan/heat sink assembly and the processor each time the fan/heat sink assembly is removed.

- Thermal paste is used on the processor **(1)** and the heat sink section **(2)** that services it
- A thermal pad is used on the PCH chip **(3)** and the heat sink section **(4)** that services it
- Thermal paste is used on the graphics subsystem chip **(5)** and the heat sink section **(6)** that services it

Replacement thermal material is included with all fan/heat sink assembly, system board, and processor spare part kits.

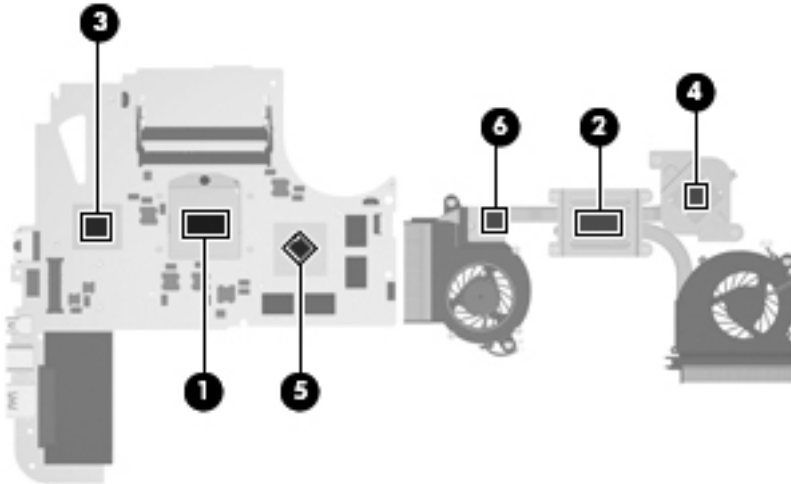

Reverse this procedure to install the fan/heat sink assembly.

Processor

 **NOTE:** The processor spare part kit includes replacement thermal material. Replacement thermal material is also available in the Thermal Material Kit, spare part number 634366-001.

| Description | Spare part number |
|---|-------------------|
| Intel Core i7-2820QM 2.30-GHz (turbo up to 3.40-GHz) processor (1600-MHz FSB, 8.0-MB L3 cache, Quad Core, 45 W) | 634694-001 |
| Intel Core i7-2720QM 2.20-GHz (turbo up to 3.30-GHz) processor (1600-MHz FSB, 6.0-MB L3 cache, Quad Core, 45 W) | 631254-001 |
| Intel Core i7-2630QM 2.00-GHz (turbo up to 2.90-GHz) processor (1333-MHz FSB, 6.0-MB L3 cache, Quad Core, 45 W) | 635501-001 |
| Intel Core i7-2620M 2.70-GHz (turbo up to 3.40-GHz) processor (1333-MHz FSB, 4.0-MB L3 cache, Dual Core, 35 W) | 631252-001 |
| Intel Core i5-2540M 2.60-GHz (turbo up to 3.30-GHz) processor (1333-MHz FSB, 3.0-MB L3 cache, Dual Core, 35 W) | 631255-001 |
| Intel Core i5-2520M 2.50-GHz (turbo up to 3.20-GHz) processor (1333-MHz FSB, 3.0-MB L3 cache, Dual Core, 35 W) | 631253-001 |
| Intel Core i5-2410M 2.30-GHz (turbo up to 2.90-GHz) processor (1333-MHz FSB, 3.0-MB L3 cache, Dual Core, 35 W) | 638039-001 |
| Intel Core i3-2330M 2.20-GHz processor (1333-MHz FSB, 3.0-MB L3 cache, Dual Core, 35 W) | 653339-001 |
| Intel Core i3-2310M 2.10-GHz processor (1333-MHz FSB, 3.0-MB L3 cache, Dual Core, 35 W) | 638037-001 |

Before removing the processor, follow these steps:

1. Shut down the computer. If you are unsure whether the computer is off or in Hibernation, turn the computer on, and then shut it down through the operating system.
2. Disconnect all external devices connected to the computer.
3. Disconnect the power from the computer by first unplugging the power cord from the AC outlet and then unplugging the AC adapter from the computer.
4. Remove the battery cover and battery (see [Battery on page 36](#)).
5. Remove the hard drive (see [Mass storage device on page 38](#)).
6. Remove the memory module/wireless module compartment cover (see [WLAN module on page 41](#)).
7. Disconnect the battery charger board ribbon cable from the system board (see [Battery connector board on page 47](#)).
8. Remove the top cover (see [Top cover on page 49](#)).
9. Disconnect the optical drive cable from the system board (see [Optical drive on page 58](#)).
10. Remove the system board (see [System board on page 62](#)).
11. Remove the fan/heat sink assembly (see [Fan/heat sink assembly on page 65](#)).

Remove the processor:

1. Turn the processor locking screw **(1)** one-half turn counterclockwise, until you hear a click.
2. Lift the processor **(2)** straight up, and remove it.

 **NOTE:** The gold triangle **(3)** on the processor must be aligned with the triangle icon **(4)** embossed on the processor socket when you install the processor.

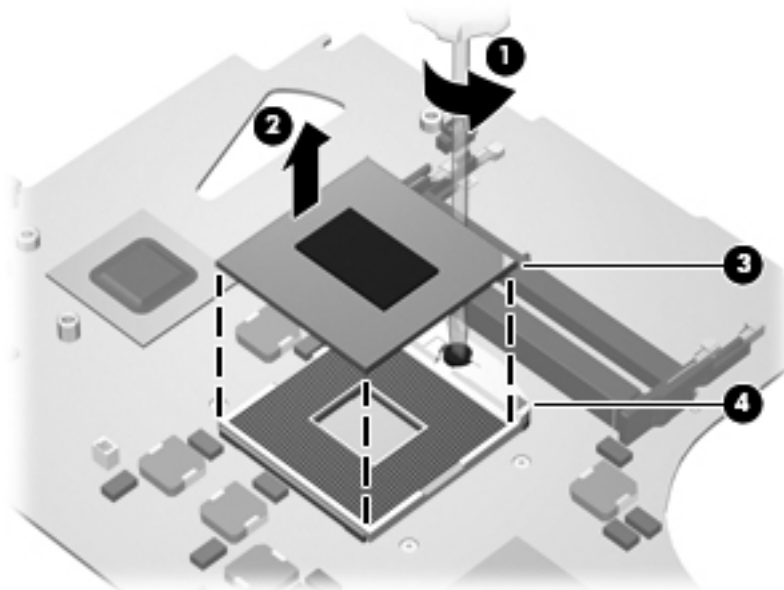

Reverse this procedure to install the processor.

Speakers

| Description | Spare part number |
|--------------------------|-------------------|
| Speakers (include cable) | 657531-001 |

Before removing the speakers, follow these steps:

1. Shut down the computer. If you are unsure whether the computer is off or in Hibernation, turn the computer on, and then shut it down through the operating system.
2. Disconnect all external devices connected to the computer.
3. Disconnect the power from the computer by first unplugging the power cord from the AC outlet and then unplugging the AC adapter from the computer.
4. Remove the battery cover and battery (see [Battery on page 36](#)).
5. Remove the hard drive (see [Mass storage device on page 38](#)).
6. Remove the memory module/wireless module compartment cover (see [WLAN module on page 41](#)).
7. Disconnect the battery charger board ribbon cable from the system board (see [Battery connector board on page 47](#)).
8. Remove the top cover (see [Top cover on page 49](#)).
9. Disconnect the optical drive cable from the system board (see [Optical drive on page 58](#)).
10. Remove the system board (see [System board on page 62](#)).

Remove the speakers:

1. Disconnect the speaker cable **(1)** from the audio/USB board.
2. Remove the four Phillips PM2.0×2.82 screws **(2)** that secure the speakers to the base enclosure.

3. Remove the speakers **(3)**.

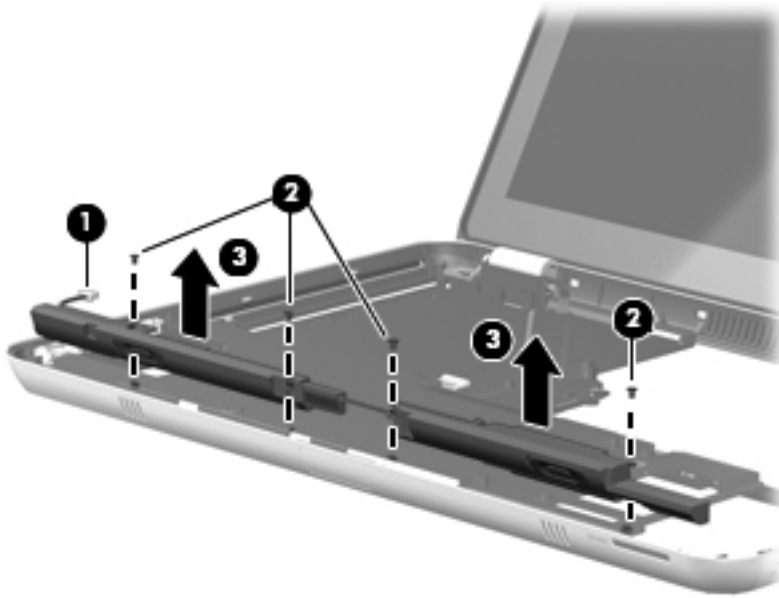

Reverse this procedure to install the speakers.

Display assembly

 **NOTE:** The display assembly spare part kit includes a display panel cable, webcam/microphone module and cable, and 2 WLAN antenna cables and transceivers.

| Description | Spare part number |
|---|-------------------|
| 14.5-in, LED, HD, AntiGlare, flush glass SVA display assembly for use only with Beats Edition computer models | 654166-001 |
| 14.5-in, LED, HD, AntiGlare, flush glass SVA display assembly for use only with standard computer models | 654165-001 |

Before removing the display assembly, follow these steps:

1. Shut down the computer. If you are unsure whether the computer is off or in Hibernation, turn the computer on, and then shut it down through the operating system.
2. Disconnect all external devices connected to the computer.
3. Disconnect the power from the computer by first unplugging the power cord from the AC outlet and then unplugging the AC adapter from the computer.
4. Remove the battery cover and battery (see [Battery on page 36](#)).
5. Remove the memory module/wireless module compartment cover (see [WLAN module on page 41](#)).
6. Remove the top cover (see [Top cover on page 49](#)).

Remove the display assembly:

1. Close the computer.
2. Turn the computer upside down, with the front toward you.
3. Disconnect the wireless antenna cables **(1)** from the WLAN module.
4. Release the wireless antenna cables from the routing clips **(2)** built into the base enclosure.
5. Release the grounding tape **(3)** that secures the WLAN antenna cables to the base enclosure.
6. Detach the wireless antenna cables **(4)** from the routing channel built into the base enclosure. (The wireless antenna cables are attached to the base enclosure with double-sided tape.)

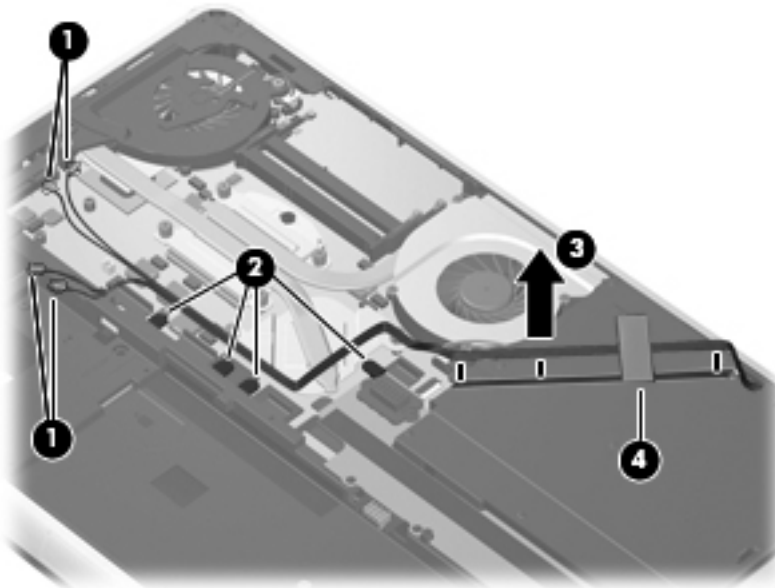

7. Release the wireless antenna cables **(1)** from the opening **(2)** in the base enclosure.
8. Disconnect the display panel cable **(3)** from the system board.

⚠ CAUTION: Support the display assembly when removing the following screws. Failure to support the display assembly can result in damage to the display assembly and other computer components.

9. Remove the four Phillips PM2.5×3.83 screws **(4)** that secure the display assembly to the computer.

10. Remove the display assembly **(5)**.

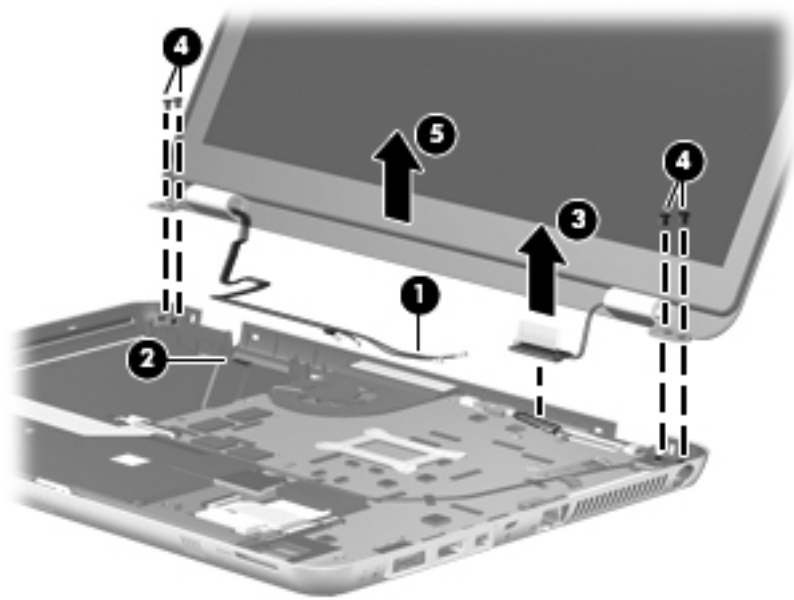

Reverse this procedure to reassemble the display assembly.

5 Setup Utility (BIOS)

Setup Utility, or Basic Input/Output System (BIOS), controls communication between all the input and output devices on the system (such as disk drives, display, keyboard, mouse, and printer). Setup Utility includes settings for the types of peripherals installed, the startup sequence of the computer, and the amount of system and extended memory.

 **CAUTION:** Use extreme care when making changes in Setup Utility. Errors can prevent the computer from operating properly.

Starting Setup Utility

 **NOTE:** The fingerprint reader (select models only) cannot be used to access Setup Utility.

- ▲ Turn on or restart the computer. While the “Press the ESC key for Startup Menu” message is displayed in the lower-left corner of the screen, press `esc`. When the Startup Menu is displayed, press `f10`.

Using Setup Utility

Changing the language of Setup Utility

1. Start Setup Utility.
2. Use the arrow keys to select **System Configuration > Language**, and then press `enter`.
3. Use the arrow keys to select a language, and then press `enter`.
4. When a confirmation prompt with your language selected is displayed, press `enter`.
5. To save your change and exit Setup Utility, use the arrow keys to select **Exit > Exit Saving Changes**, and then press `enter`.

Your change takes effect immediately.

Navigating and selecting in Setup Utility

Because Setup Utility is not Windows based, it does not support the TouchPad. Navigation and selection are by keystroke.

- To choose a menu or a menu item, use the arrow keys.
- To choose an item in a list or to toggle a field—for example an Enable/Disable field—use either the arrow keys or **f5** and **f6**.
- To select an item, press **enter**.
- To close a text box or return to the menu display, press **esc**.
- To display additional navigation and selection information while Setup Utility is open, press **f1**.

Displaying system information

1. Start Setup Utility.
2. Select the **Main** menu. System information such as the system time and date, and identification information about the computer is displayed.
3. To exit Setup Utility without changing any settings, use the arrow keys to select **Exit > Exit Discarding Changes**, and then press **enter**.

Restoring factory default settings in Setup Utility

1. Start Setup Utility.
2. Use the arrow keys to select **Exit > Load Setup Defaults**, and then press **enter**.
3. When the Setup Confirmation is displayed, press **enter**.
4. To save your change and exit Setup Utility, use the arrow keys to select **Exit > Exit Saving Changes**, and then press **enter**.

The Setup Utility factory settings take effect when the computer restarts.



NOTE: Your password, security, and language settings are not changed when you restore the factory settings.

Exiting Setup Utility

- To exit Setup Utility and save your changes from the current session:
If the Setup Utility menus are not visible, press [esc](#) to return to the menu display. Then use the arrow keys to select **Exit > Exit Saving Changes**, and then press [enter](#).
- To exit Setup Utility without saving your changes from the current session:
If the Setup Utility menus are not visible, press [esc](#) to return to the menu display. Then use the arrow keys to select **Exit > Exit Discarding Changes**, and then press [enter](#).

Updating the BIOS

Updated versions of the BIOS may be available on the HP Web site.

Most BIOS updates on the HP Web site are packaged in compressed files called SoftPaqs.

Some download packages contain a file named Readme.txt, which contains information regarding installing and troubleshooting the file.

Determining the BIOS version

To determine whether available BIOS updates contain later BIOS versions than those currently installed on the computer, you need to know the version of the system BIOS currently installed.

BIOS version information (also known as *ROM date* and *System BIOS*) can be displayed by pressing [fn + esc](#) (if you are already in Windows) or by using Setup Utility.

1. Start Setup Utility.
2. If the system information is not displayed, use the arrow keys to select the **Main** menu.
BIOS and other system information is displayed.
3. To exit Setup Utility, use the arrow keys to select **Exit > Exit Discarding Changes**, and then press [enter](#).

Downloading a BIOS update

 **CAUTION:** To reduce the risk of damage to the computer or an unsuccessful installation, download and install a BIOS update only when the computer is connected to reliable external power using the AC adapter. Do not download or install a BIOS update while the computer is running on battery power, docked in an optional docking device, or connected to an optional power source. During the download and installation, follow these instructions:

Do not disconnect power from the computer by unplugging the power cord from the AC outlet.

Do not shut down the computer or initiate Sleep or Hibernation.

Do not insert, remove, connect, or disconnect any device, cable, or cord.

1. Access the page on the HP Web site that provides software for your computer:

Windows 7—Select **Start > Help and Support > Maintain**.

Windows XP—Select **Start > Help and Support**, and then select the software and drivers update.

2. Follow the on-screen instructions to identify your computer and access the BIOS update you want to download.
3. At the download area, follow these steps:
 - a. Identify the BIOS update that is later than the BIOS version currently installed on your computer. Make a note of the date, name, or other identifier. You may need this information to locate the update later, after it has been downloaded to your hard drive.
 - b. Follow the on-screen instructions to download your selection to the hard drive.

Make a note of the path to the location on your hard drive where the BIOS update is downloaded. You will need to access this path when you are ready to install the update.

 **NOTE:** If you connect your computer to a network, consult the network administrator before installing any software updates, especially system BIOS updates.

BIOS installation procedures vary. Follow any instructions that are displayed on the screen after the download is complete. If no instructions are displayed, follow these steps:

1. **Windows 7**—Open Windows Explorer by selecting **Start > Computer**.
Windows XP—Open Windows Explorer by selecting **Start > My Computer**.
2. Double-click your hard drive designation. The hard drive designation is typically Local Disk (C:).
3. Using the hard drive path you recorded earlier, open the folder on your hard drive that contains the update.
4. Double-click the file that has an .exe extension (for example, *filename.exe*).
The BIOS installation begins.
5. Complete the installation by following the on-screen instructions.



NOTE: After a message on the screen reports a successful installation, you can delete the downloaded file from your hard drive.

6 Specifications

Computer specifications

| | Metric | U.S. |
|---|---|---------------------|
| Dimensions: | | |
| Width | 35.6 cm | 14.02 in |
| Depth | 23.70 cm | 9.33 in |
| Height (front to back) | 2.77 cm to 2.82 cm | 1.09 in to 1.11 in |
| Weight: | 2.38 kg | 5.25 lbs |
| Input power | | |
| Operating voltage | 19.0 V dc @ 4.74 A - 90W | |
| Operating current | 4.74 A | |
| Temperature | | |
| Operating (writing to optical disc) | 5°C to 35°C | 41°F to 95°F |
| Nonoperating | -20°C to 60°C | -4°F to 140°F |
| Relative humidity | | |
| Operating | 10% to 90% | |
| Nonoperating | 5% to 90% | |
| Maximum altitude (unpressurized) | | |
| Operating (14.7 to 10.1 psia) | -15 m to 3,048 m | -50 ft to 10,000 ft |
| Nonoperating (14.7 to 4.4 psia) | -15 m to 12,192 m | -50 ft to 40,000 ft |
| Shock | | |
| Operating | 125 g, 2 ms, half-sine | |
| Nonoperating | 200 g, 2 ms, half-sine | |
| Random vibration | | |
| Operating | 0.75 g zero-to-peak, 10 Hz to 500 Hz, 0.25 oct/min sweep rate | |

| | Metric | U.S. |
|---|--|-------------|
| Nonoperating | 1.50 g zero-to-peak, 10 Hz to 500 Hz, 0.5 oct/min sweep rate | |
| NOTE: Applicable product safety standards specify thermal limits for plastic surfaces. The computer operates well within this range of temperatures. | | |

14.5-inch, SVA display specifications

| | Metric | U.S. |
|--------------------------------|---|-------------|
| Dimensions | | |
| Width | 33.2 cm | 13.1 in |
| Height | 18.7 cm | 7.4 in |
| Diagonal | 37.1 cm | 14.6 in |
| Number of colors | Up to 16.8 million | |
| Contrast ratio | 200:1 (typical) | |
| Brightness | 200 nits (typical) | |
| Backlight | LED | |
| Character display | 80 × 25 | |
| Total power consumption | 6.0 W | |
| Viewing angle | +/-65 horizontal, +/-50° vertical (typical) | |

Hard drive specifications

| | 640-GB* | 500-GB* | 320-GB* | 250-GB* |
|---|-----------------------------|--------------|--------------|--------------|
| Dimensions | | | | |
| Height | 9.5 mm | 9.5 mm | 9.5 mm | 9.5 mm |
| Width | 70 mm | 70 mm | 70 mm | 70 mm |
| Weight | 101 g | 101 g | 101 g | 101 g |
| Interface type | | | | |
| | SATA | SATA | SATA | SATA |
| Transfer rate | | | | |
| | 100 MB/sec | 100 MB/sec | 100 MB/sec | 100 MB/sec |
| Security | | | | |
| | ATA security | ATA security | ATA security | ATA security |
| Seek times (typical read, including setting) | | | | |
| Single track | 3 ms | 3 ms | 3 ms | 3 ms |
| Average | 13 ms | 13 ms | 13 ms | 13 ms |
| Maximum | 24 ms | 24 ms | 24 ms | 24 ms |
| Logical blocks | | | | |
| | 1,250,242,867 | 976,752,240 | 625,121.433 | 488,376,120 |
| Disk rotational speed | | | | |
| | 5400 rpm | 7200 rpm | 7200 rpm | 7200 rpm |
| Operating temperature | | | | |
| | 5°C to 55°C (41°F to 131°F) | | | |

*1 GB = 1 billion bytes when referring to hard drive storage capacity. Actual accessible capacity is less. Actual drive specifications may differ slightly.

NOTE: Certain restrictions and exclusions apply. Contact technical support for details.

DVD±RW and CD-RW Super Multi Double-Layer Combo Drive specifications

| Applicable disc | Read: | Write: |
|---------------------------|--|---|
| | CD-DA, CD+(E)G, CD-MIDI, CD-TEXT, CD-ROM, CD-ROM XA, MIXED MODE CD, CD-I, CD-I Bridge (Photo-CD, Video CD), Multisession CD, CD-EXTRA, Portfolio, CD-R, CD-RW), CD-R, CD-RW, DVD-ROM (DVD-5, DVD-9, DVD-10, DVD-18), DVD-R, DVD-RW, DVD+R, DVD+RW, DVD-RAM | CD-R and CD-RW DVD+R, DVD+RW, DVD-R, DVD-RW, DVD-RAM |
| Access time | CD | DVD |
| Random | < 175 ms | < 230 ms |
| Cache buffer | 2.5 MB | |
| Data transfer rate | | |
| 24X CD-ROM | 3,600 KB/sec | |
| 8X DVD | 10,800 KB/sec | |
| 24X CD-R | 3,600 KB/sec | |
| 16X CD-RW | 2,400 KB/sec | |
| 8X DVD+R | 10,800 KB/sec | |
| 4X DVD+RW | 5,400 KB/sec | |
| 8X DVD-R | 10,800 KB/sec | |
| 4X DVD-RW | 5,400 KB/sec | |
| 2.4X DVD+R(9) | 2,700 KB/sec | |
| 5X DVD-RAM | 6,750 KB/sec | |
| Transfer mode | Multiword DMA Mode | |

7 Backup and recovery

Recovery after a system failure is as good as your most recent backup. HP recommends that you create recovery discs immediately after software setup. As you add new software and data files, you should continue to back up your system on a regular basis to maintain a reasonably current backup.

Tools provided by the operating system and HP Recovery Manager software are designed to help you with the following tasks for safeguarding your information and restoring it in case of a computer failure:

- Creating a set of recovery discs (Recovery Manager software feature)
- Backing up your information
- Creating system restore points
- Recovering a program or driver
- Performing a full system recovery (from the partition or recovery discs)



NOTE: Recovery discs have been included if your computer does not have a partition. Use these discs to recover your operating system and software. To check for the presence of a recovery partition, click **Start**, right-click **Computer**, click **Manage**, and then click **Disk Management**. If the partition is present, an HP Recovery drive is listed in the window.

Recovery discs

HP recommends that you create recovery discs to be sure that you can restore your computer to its original factory state if the hard drive fails, or if for any reason you cannot recover using the recovery partition tools. Create these discs after setting up the computer for the first time.

Handle these discs carefully and keep them in a safe place. The software allows the creation of only one set of recovery discs.

 **NOTE:** If your computer does not include an integrated optical drive, you can use an optional external optical drive (purchased separately) to create recovery discs, or you can purchase recovery discs for your computer from the HP Web site. If you use an external optical drive, it must be connected directly to a USB port on the computer, not to a USB port on an external device, such as a USB hub.

Guidelines:

- Purchase high-quality DVD-R, DVD+R, BD-R (writable Blu-ray), or CD-R discs. DVDs and BDs have a much higher storage capacity than CDs. If you use CDs, up to 20 discs may be required, whereas only a few DVDs or BDs are required.

 **NOTE:** Read-write discs, such as CD-RW, DVD±RW, double-layer DVD±RW, and BD-RE (rewritable Blu-ray) discs, are not compatible with the Recovery Manager software.

- The computer must be connected to AC power during this process.
- Only one set of recovery discs can be created per computer.
- Number each disc before inserting it into the optical drive.
- If necessary, you can exit the program before you have finished creating the recovery discs. The next time you open Recovery Manager, you will be prompted to continue the disc creation process.

To create a set of recovery discs:

1. Select **Start > All Programs > Recovery Manager > Recovery Disc Creation**.
2. Follow the on-screen instructions.

Performing a system recovery

Recovery Manager software allows you to repair or restore the computer to its original factory state. Recovery Manager works from recovery discs or from a dedicated recovery partition (select models only) on the hard drive.

Note the following when performing a system recovery:

- You can recover only files that you have previously backed up. HP recommends that you use HP Recovery Manager to create a set of recovery discs (entire drive backup) as soon as you set up the computer.
- Windows has its own built-in repair features, such as System Restore. If you have not already tried these features, try them before using Recovery Manager.
- Recovery Manager recovers only software that was preinstalled at the factory. Software not provided with this computer must be downloaded from the manufacturer's Web site or reinstalled from the disc provided by the manufacturer.

Recovering using the dedicated recovery partition

On some models, you can perform a recovery from the partition on the hard drive, accessed by clicking **Start** or pressing the **f11** key. This type of recovery restores the computer to its factory condition without using recovery discs.

To restore the computer from the partition, follow these steps:

1. Access Recovery Manager in either of the following ways:
 - Select **Start > All Programs > Recovery Manager > Recovery Manager**.
 - or -
 - Turn on or restart the computer, and then press **esc** while the "Press the ESC key for Startup Menu" message is displayed at the bottom of the screen. Then, press **f11** while the "F11 (HP Recovery)" message is displayed on the screen.
2. Click **System Recovery** in the **Recovery Manager** window.
3. Follow the on-screen instructions.

Recovering using the recovery discs

1. If possible, back up all personal files.
2. Insert the first recovery disc into the optical drive on your computer or an optional external optical drive, and then restart the computer.
3. Follow the on-screen instructions.

Backing up your information

You should back up your computer files on a regular schedule to maintain a current backup. You can back up your information to an optional external hard drive, a network drive, or discs. Back up your system at the following times:

- At regularly scheduled times



NOTE: Set reminders to back up your information periodically.

- Before the computer is repaired or restored
- Before you add or modify hardware or software

Guidelines:

- Create system restore points using the Windows System Restore feature, and periodically copy them to an optical disc or an external hard drive. For more information on using system restore points, refer to “Using system restore points”.
- Store personal files in the Documents library and back up this folder periodically.
- Save customized settings in a window, toolbar, or menu bar by taking a screen shot of your settings. The screen shot can be a time-saver if you have to reset your preferences.

Using Windows Backup and Restore

Windows Backup and Restore allows you to back up individual files or back up the entire computer image.

Guidelines:

- Be sure that the computer is connected to AC power before you start the backup process.
- Allow enough time to complete the backup process. Depending on file sizes, it may take over an hour.

To create a backup:

1. Select **Start > Control Panel > System and Security > Backup and Restore**.
2. Follow the on-screen instructions to schedule and create a backup.



NOTE: Windows includes the User Account Control feature to improve the security of the computer. You may be prompted for your permission or password for tasks such as installing software, running utilities, or changing Windows settings. Refer to Help and Support for more information.

Using system restore points

A system restore point allows you to save and name a snapshot of your hard drive at a specific point in time. You can then recover back to that point if you want to reverse subsequent changes.



NOTE: Recovering to an earlier restore point does not affect data files saved or e-mails created since the last restore point.

You also can create additional restore points to provide increased protection for your files and settings.

When to create restore points

- Before you add or extensively modify software or hardware
- Periodically, whenever the computer is functioning optimally



NOTE: If you revert to a restore point and then change your mind, you can reverse the restoration.

Create a system restore point

1. Select **Start > Control Panel > System and Security > System**.
2. In the left pane, click **System Protection**.
3. Click the **System Protection** tab.
4. Follow the on-screen instructions.

Restore to a previous date and time

To revert to a restore point (created at a previous date and time), when the computer was functioning optimally, follow these steps:

1. Select **Start > Control Panel > System and Security > System**.
2. In the left pane, click **System protection**.
3. Click the **System Protection** tab.
4. Click **System Restore**.
5. Follow the on-screen instructions.

8 Power cord set requirements

The wide-range input feature of the computer permits it to operate from any line voltage from 100 to 120 volts AC, or from 220 to 240 volts AC

The 3-conductor power cord set included with the computer meets the requirements for use in the country or region where the equipment is purchased.

Power cord sets for use in other countries and regions must meet the requirements of the country or region where the computer is used.

Requirements for all countries

The following requirements are applicable to all countries and regions:

- The length of the power cord set must be at least **1.5 m** (5.0 ft) and no more than **2.0 m** (6.5 ft).
- All power cord sets must be approved by an acceptable accredited agency responsible for evaluation in the country or region where the power cord set will be used.
- The power cord sets must have a minimum current capacity of 10 amps and a nominal voltage rating of 125 or 250 V AC, as required by the power system of each country or region.
- The appliance coupler must meet the mechanical configuration of an EN 60 320/IEC 320 Standard Sheet C13 connector for mating with the appliance inlet on the back of the computer.

Requirements for specific countries and regions

| Country/region | Accredited agency | Applicable note number |
|--------------------------------|-------------------|------------------------|
| Australia | EANSW | 1 |
| Austria | OVE | 1 |
| Belgium | CEBC | 1 |
| Canada | CSA | 2 |
| Denmark | DEMKO | 1 |
| Finland | FIMKO | 1 |
| France | UTE | 1 |
| Germany | VDE | 1 |
| Italy | IMQ | 1 |
| Japan | METI | 3 |
| The Netherlands | KEMA | 1 |
| Norway | NEMKO | 1 |
| The People's Republic of China | COC | 5 |
| South Korea | EK | 4 |
| Sweden | SEMKO | 1 |
| Switzerland | SEV | 1 |
| Taiwan | BSMI | 4 |
| The United Kingdom | BSI | 1 |
| The United States | UL | 2 |

1. The flexible cord must be Type HO5VV-F, 3-conductor, 1.0-mm² conductor size. Power cord set fittings (appliance coupler and wall plug) must bear the certification mark of the agency responsible for evaluation in the country or region where it will be used.
2. The flexible cord must be Type SPT-3 or equivalent, No. 18 AWG, 3-conductor. The wall plug must be a two-pole grounding type with a NEMA 5-15P (15 A, 125 V) or NEMA 6-15P (15 A, 250 V) configuration.
3. The appliance coupler, flexible cord, and wall plug must bear a "T" mark and registration number in accordance with the Japanese Dentori Law. The flexible cord must be Type VCT or VCTF, 3-conductor, 1.00-mm² conductor size. The wall plug must be a two-pole grounding type with a Japanese Industrial Standard C8303 (7 A, 125 V) configuration.
4. The flexible cord must be Type RVV, 3-conductor, 0.75-mm² conductor size. Power cord set fittings (appliance coupler and wall plug) must bear the certification mark of the agency responsible for evaluation in the country or region where it will be used.
5. The flexible cord must be Type VCTF, 3-conductor, 0.75-mm² conductor size. Power cord set fittings (appliance coupler and wall plug) must bear the certification mark of the agency responsible for evaluation in the country or region where it will be used.

9 Recycling

Battery

When a battery has reached the end of its useful life, do not dispose of the battery in general household waste. Follow the local laws and regulations in your area for computer battery disposal.

Display

⚠ **WARNING!** The backlight contains mercury. Caution must be exercised when removing and handling the backlight to avoid damaging this component and causing exposure to the mercury.

⚠ **CAUTION:** The procedures in this chapter can result in damage to display components. The only components intended for recycling purposes are the liquid crystal display (LCD) panel and the backlight. When you remove these components, handle them carefully.

📄 **NOTE:** Materials Disposal. This HP product contains mercury in the backlight in the display assembly that might require special handling at end-of-life. Disposal of mercury may be regulated because of environmental considerations. For disposal or recycling information, contact your local authorities, or see the Electronic Industries Alliance (EIA) Web site at <http://www.eiai.org>.

This section provides disassembly instructions for the display assembly. The display assembly must be disassembled to gain access to the backlight **(1)** and the liquid crystal display (LCD) panel **(2)**.



📄 **NOTE:** The procedures provided in this chapter are general disassembly instructions. Specific details, such as screw sizes, quantities, and locations, and component shapes and sizes, can vary from one computer model to another.

Perform the following steps:

1. Remove all screw covers **(1)** and screws **(2)** that secure the display bezel to the display assembly.

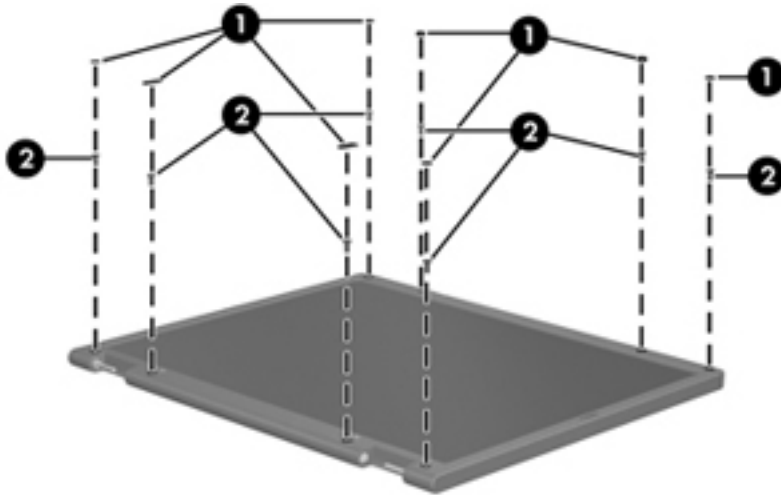

2. Lift up and out on the left and right inside edges **(1)** and the top and bottom inside edges **(2)** of the display bezel until the bezel disengages from the display assembly.
3. Remove the display bezel **(3)**.

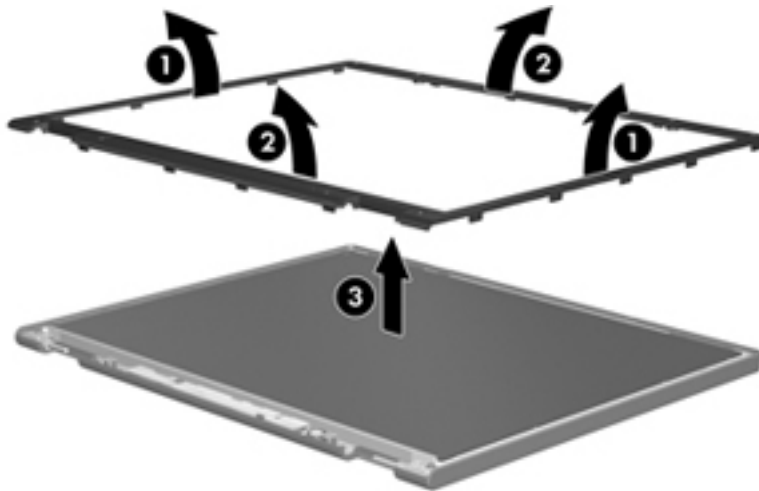

4. Disconnect all display panel cables **(1)** from the display inverter and remove the inverter **(2)**.

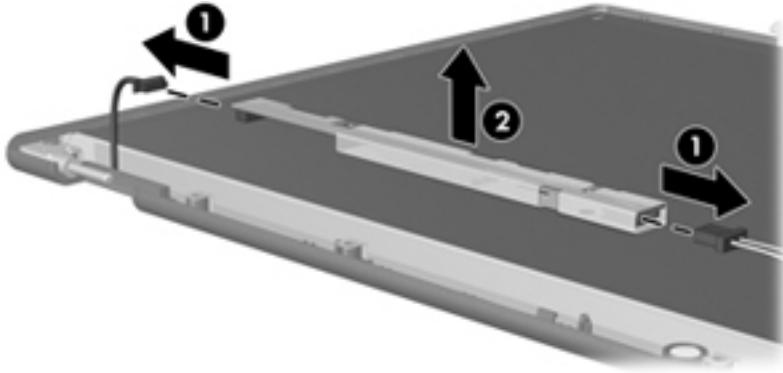

5. Remove all screws **(1)** that secure the display panel assembly to the display enclosure.
6. Remove the display panel assembly **(2)** from the display enclosure.

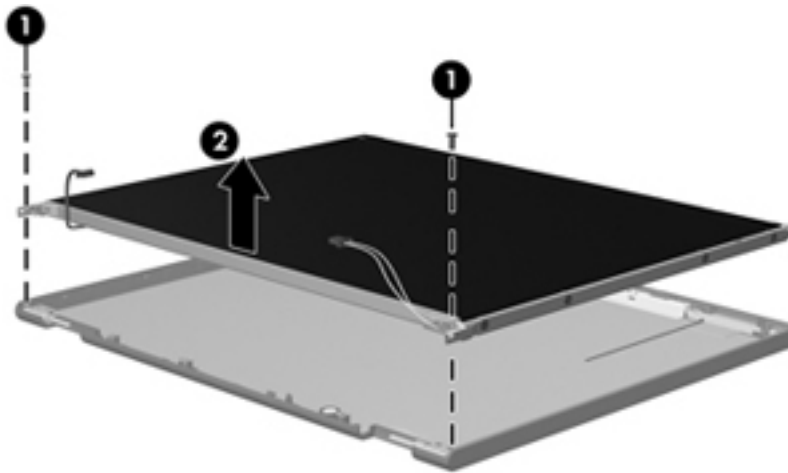

7. Turn the display panel assembly upside down.
8. Remove all screws that secure the display panel frame to the display panel.

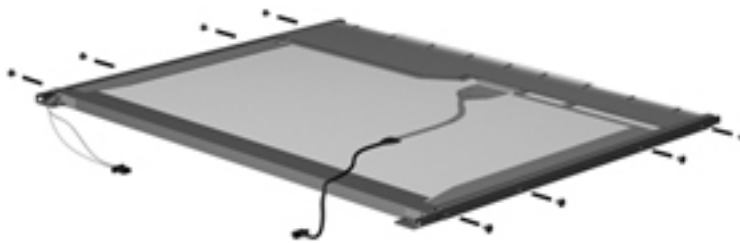

9. Use a sharp-edged tool to cut the tape **(1)** that secures the sides of the display panel to the display panel frame.

10. Remove the display panel frame **(2)** from the display panel.

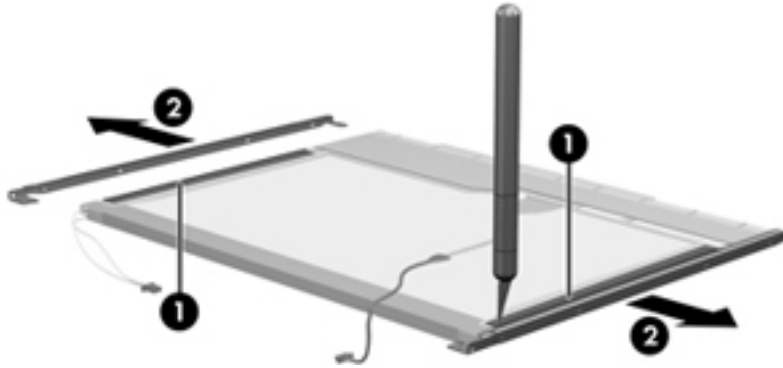

11. Remove the screws **(1)** that secure the backlight cover to the display panel.

12. Lift the top edge of the backlight cover **(2)** and swing it outward.

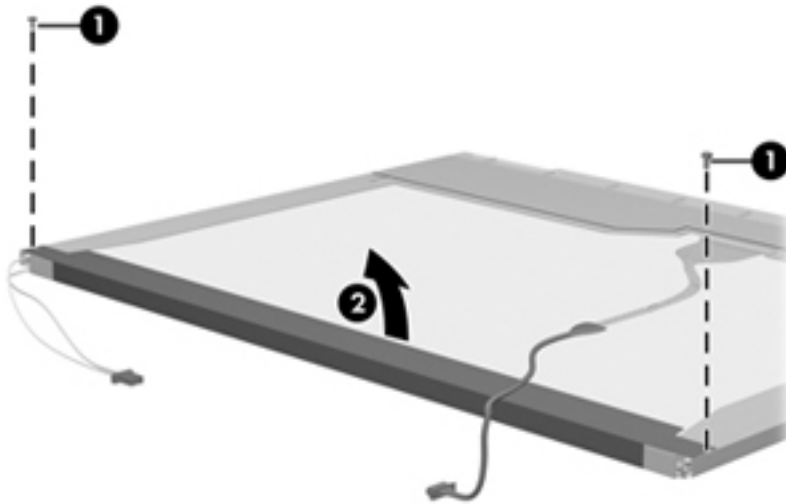

13. Remove the backlight cover.

14. Turn the display panel right-side up.

15. Remove the backlight cables (1) from the clip (2) in the display panel.

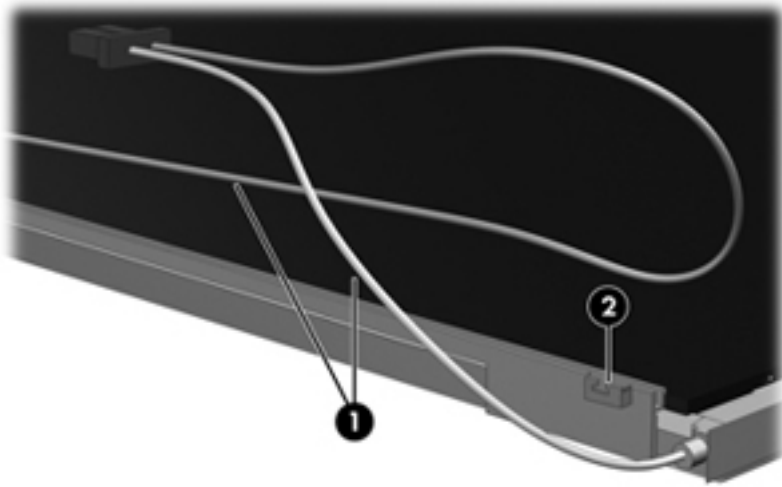

16. Turn the display panel upside down.
17. Remove the backlight frame from the display panel.

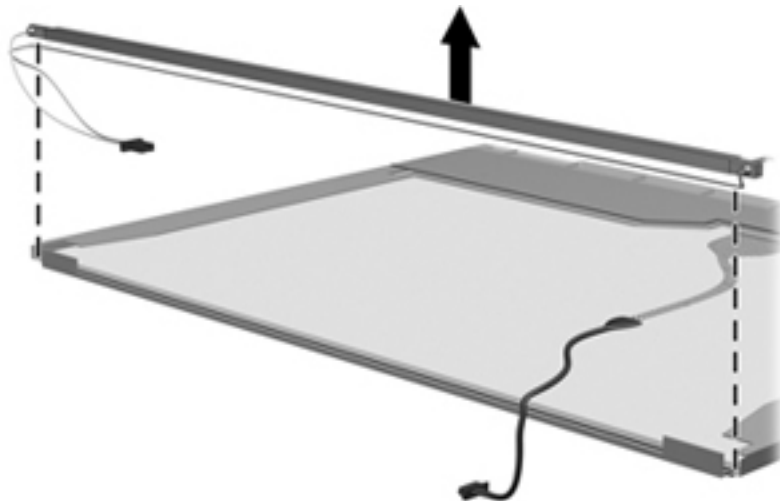

⚠ WARNING! The backlight contains mercury. Exercise caution when removing and handling the backlight to avoid damaging this component and causing exposure to the mercury.

18. Remove the backlight from the backlight frame.

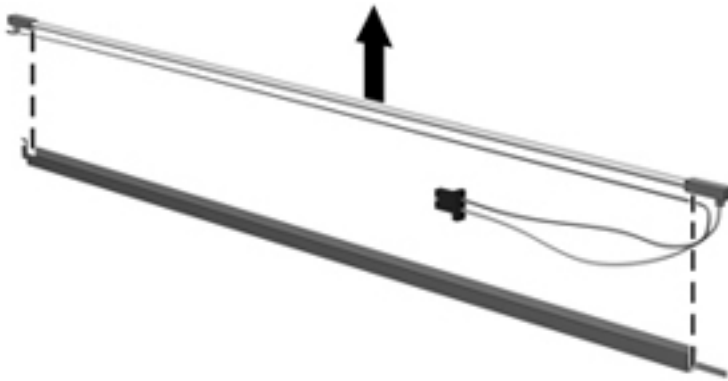

19. Disconnect the display cable **(1)** from the LCD panel.

20. Remove the screws **(2)** that secure the LCD panel to the display rear panel.

21. Release the LCD panel **(3)** from the display rear panel.

22. Release the tape **(4)** that secures the LCD panel to the display rear panel.

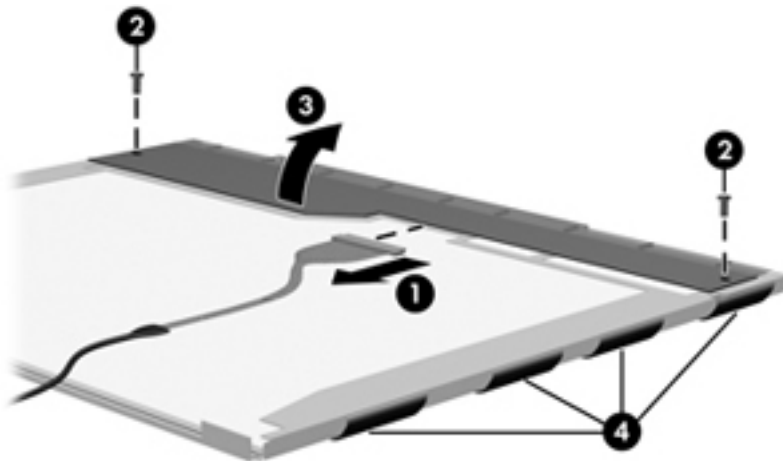

23. Remove the LCD panel.

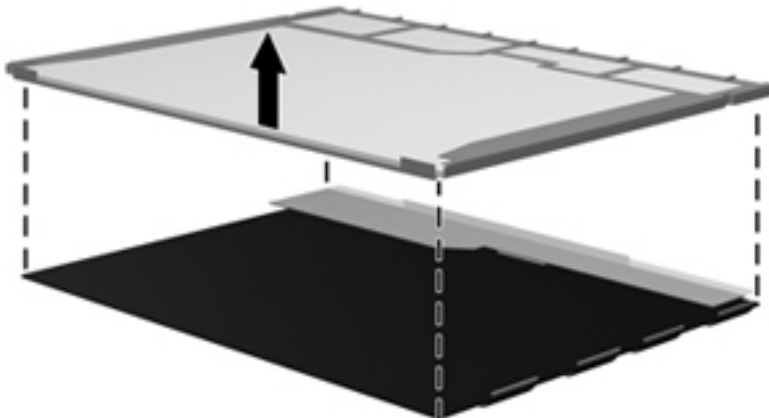

24. Recycle the LCD panel and backlight.

Index

Symbols/Numerics

processor
product description 1
removal 67
spare part numbers 20, 67

A

AC adapter, spare part numbers 24, 26, 28
accessory battery connector 14
action keys 6
antenna, locations 9
audio, product description 3
audio-in jack
location 11
audio-out jack
location 11
audio/USB board
removal 54
spare part number 19, 54
spare part numbers 29

B

base enclosure, spare part numbers 20, 28
battery
removal 36
spare part numbers 21, 25, 36
battery bay 14
battery connector board
removal 47
spare part number 21, 29, 47
battery cover
illustrated 22
removal 36
spare part numbers 37
battery light 13
battery release latch 14

Bluetooth compartment 10
Bluetooth module
removal 55
spare part number 19, 25, 55
bottom components 14
button component 5
buttons
power 5
TouchPad 8

C

Cable Kit, spare part number 19, 26
cables, service considerations 30
chipset, product description 1
components
bottom 14
button 5
display 9
front 10
keys 6
left side 11
lights 7
right side 12
TouchPad 8
computer feet
locations 36
spare part number 36
computer part number 15, 35
computer specifications 78
connectors, service considerations 30

D

Digital Media Slot 10
display assembly
removal 70
spare part numbers 18, 29, 70

display components 9
display panel, product description 2
display specifications 79
Door Kit
components 22
spare part numbers 19, 22, 29
drive light 12
drives, preventing damage 31
DVD±RW and CD-RW Super Multi
Double-Layer Combo Drive
precautions 31
removal 58
spare part number 20, 23, 29, 58
specifications 81

E

electrostatic discharge 31
equipment guidelines 34
eSATA port 12
esc key 6
Ethernet, product description 3
external media cards, product description 3

F

fan/heat sink assembly
removal 65
spare part number 20, 29, 65
feet
locations 36
spare part number 36
fn key 6
front components 10

G

graphics, product description 1

grounding guidelines 31
guidelines

- equipment 34
- grounding 31
- packaging 33
- transporting 33
- workstation 33

H

hard drive

- precautions 31
- product description 2
- removal 38
- spare part numbers 21, 23, 28, 38
- specifications 80

Hard Drive Hardware Kit, spare part number 21, 23, 25, 38

HDMI port

- location 12

HDMI to VGA adapter, spare part number 24, 25

headphone jack

- location 11

J

jacks

- audio-in 11
- audio-out 11
- headphone 11
- microphone 11
- network 12
- RJ-45 12

K

key components 6

keyboard

- product description 4
- removal 52
- spare part numbers 18, 25, 26, 27, 28, 52

keys

- action 6
- esc 6
- fn 6
- optical drive eject 6
- Windows applications 6
- Windows logo 6

L

left-side components 11

light components 7

lights

- battery 13
- drive 12
- mute 7
- power 7, 12
- TouchPad 7, 8
- webcam 9
- wireless 7

M

mass storage device

- removal 38
- spare part numbers 21, 23, 25, 28, 29, 38

memory module

- product description 2
- removal 46
- spare part numbers 21, 25, 28, 46

memory module/wireless module

- compartment 14

memory module/wireless module

- compartment cover
- illustrated 22
- removal 42
- spare part numbers 42

microphone

- location 9
- product description 3

microphone jack

- location 11

MiniDisplay Port 12

model description 16, 35

model name 1

mSATA solid-state drive

- removal 40
- spare part numbers 23, 29

mute light 7

N

network jack

- location 12

O

operating system, product

- description 4

optical drive

- location 11
- precautions 31
- product description 3

- removal 58

- spare part number 20, 23, 58

- spare part numbers 29

- specifications 81

optical drive eject key 6

P

packaging guidelines 33

part number listing, sequential 25

plastic parts, service

- considerations 30

pointing device, product

- description 4

ports

- eSATA 12

- HDMI 12

- Mini DisplayPort 12

- product description 3

- Universal Serial Bus (USB) 11, 12

power button 5

power connector 13

power connector cable

- removal 60
- spare part number 19, 29, 60

power cord

- set requirements 87

- spare part numbers 24, 25

power light 7, 12

power requirements, product

- description 4

processor

- spare part numbers 28

product description

- processors 1

- audio 3

- chipset 1

- display panel 2

- Ethernet 3

- external media cards 3

- graphics 1

- hard drives 2

- keyboard 4

- memory module 2

- microphone 3

- operating system 4

- optical drive 3

- pointing device 4

- ports 3

- power requirements 4

- product name 1
- security 4
- serviceability 4
- video 3
- wireless 3
- product name 1, 15, 35
- product number 15, 35
- protective cover, spare part numbers 24, 28

R

- removal/replacement
 - preliminaries 30
 - procedures 35
- right-side components 12
- RJ-45 jack
 - location 12
- RTC battery
 - removal 44
 - spare part number 21, 25, 44

S

- Screw Kit, spare part number 24, 26
- security cable slot 12
- security, product description 4
- serial number 15, 35
- service considerations
 - cables 30
 - connectors 30
 - plastic parts 30
- service tag 15, 35
- serviceability, product description 4
- solid-state drive
 - removal 38
 - spare part number 23
 - spare part numbers 21, 25, 38
- solid-state drive connector board
 - removal 56
 - spare part numbers 19, 29, 56
- speakers
 - location 10
 - removal 69
 - spare part number 20, 29, 69
- specifications
 - computer 78

- display 79
- DVD±RW and CD-RW Super Multi Double-Layer Combo Drive 81
- hard drive 80
- optical drive 81
- system board
 - removal 62
 - spare part number 20, 29, 62

T

- Thermal Material Kit, spare part number 20
- Thermal Material Kit, spare part numbers 28
- tools required 30
- top cover
 - removal 49
 - spare part numbers 19, 29, 49
- TouchPad 8
- TouchPad button 8
- TouchPad components 8
- TouchPad light 7, 8
- transporting guidelines 33

U

- Universal Serial Bus (USB) port
 - location 11, 12

V

- vent 12
- vents 14
- video, product description 3

W

- warranty period 16, 35
- webcam 9
- webcam light 9
- Windows applications key 6
- Windows logo key 6
- wireless antenna, locations 9
- wireless light 7
- wireless, product description 3
- WLAN module
 - removal 41
 - spare part numbers 21, 25, 28, 41
- workstation guidelines 33