

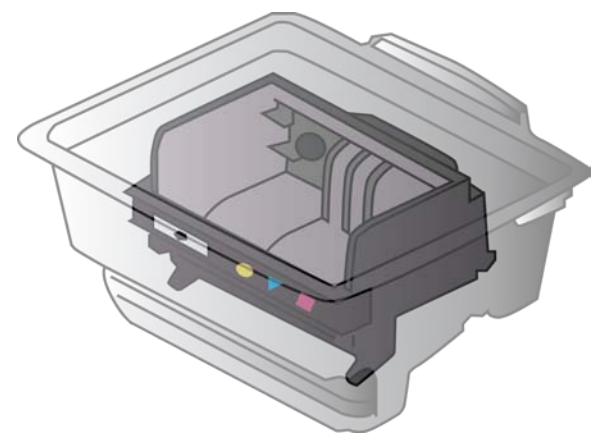

Printer cleaning and printhead replacement

プリンタのクリーニングとプリントヘッドの交換



cleaning wipes
クリーニング
ワイプス

?

www.hp.com/support

1 - remove old parts

1 - 古い部品を取り外します。

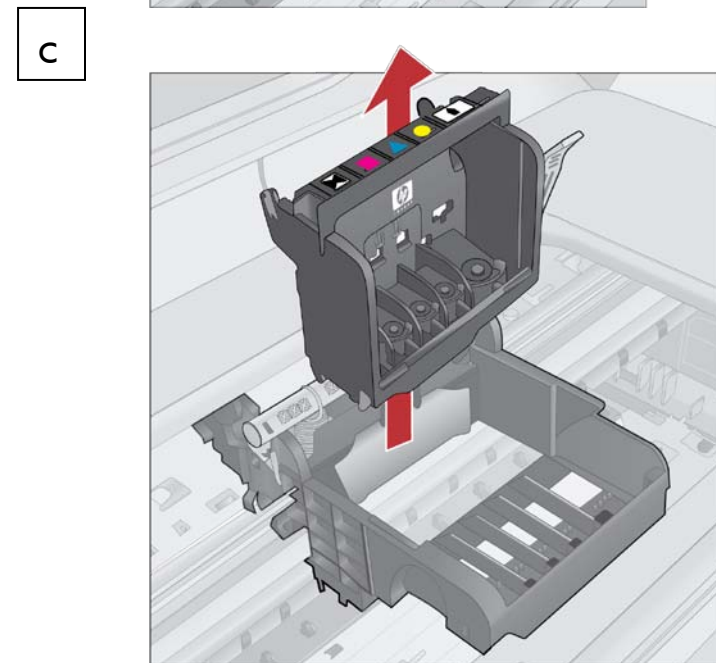
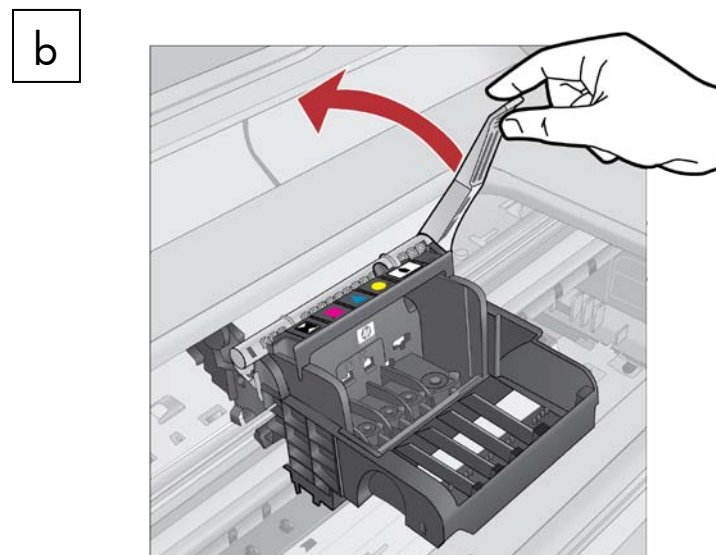
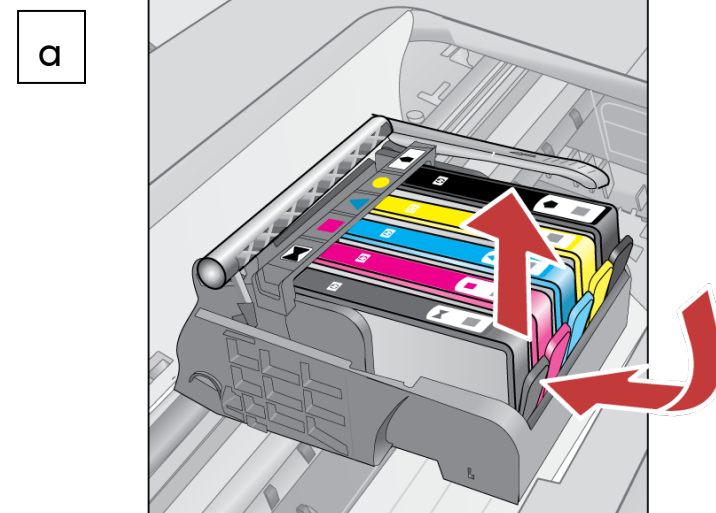

www.hp.com/recycle

2 - clean printer

2 - プリンタをクリーニングします。

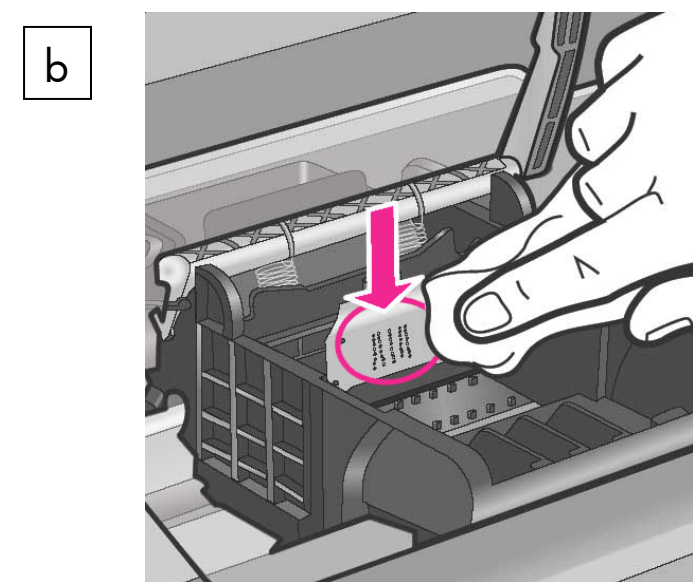
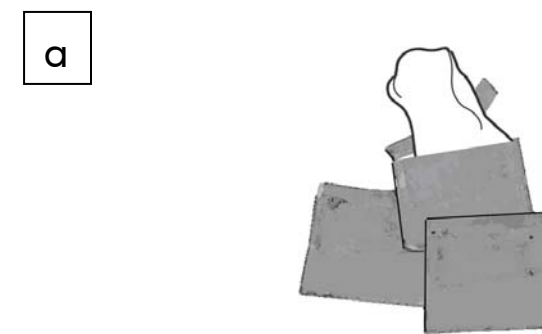

c - clean until no ink appears. Use as many wipes as necessary.

c - インクが付かなくなるまでクリーニングします。必要に応じて何枚でもクリーニングワイプスを使用します。

3 - install new parts

3 - 新しい部品を取り付けます。

