



s300

Digital Camera

Quick Start Guide

For more details about the camera operation and troubleshooting, please read the User Manual located on the CDROM disc included with your camera or visit <http://www.hp.com/support> and download it for the camera support page.

Tour of Your HP Camera

Front View

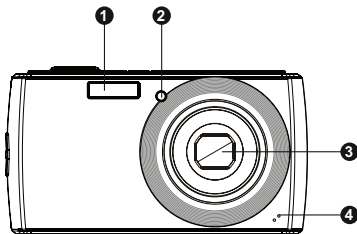

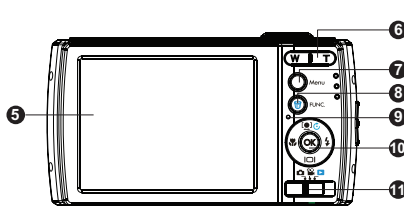

1. Flash
2. Self-timer LED / AF Assist Lamp
3. Lens
4. Microphone

Back View



5. LCD Screen
6. Zoom Toggle
7. Menu Button
8. Function / Delete Button
9. LED Indicator
10. OK Button / 4-way Navigation Control
11. Mode Selector Switch

-  Photo Mode
-  Video Mode
-  Playback Mode

Top View

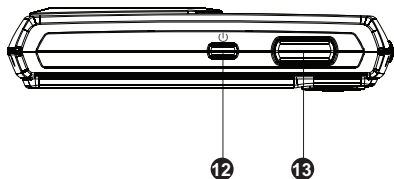

- 12. Power button
- 13. Shutter button

Bottom View

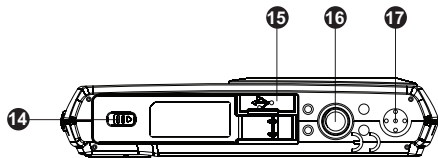

- 14. Battery/Memory card compartment
- 15. USB/TV Out
- 16. Tripod screw hole
- 17. Speaker

Left/Right View

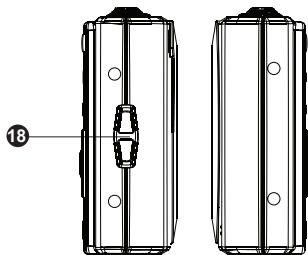

- 18. Strap Ring

1. Getting Started

Attach the Camera Strap

To reduce the risk of dropping the camera, it is strongly recommended to attach and use the provided camera strap

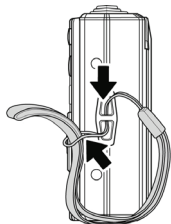

Inserting the Battery

Follow these instructions to insert the battery into the battery/memory card compartment.

1. If the battery are already installed, make sure to power off the camera before removing and inserting recharged or new battery.

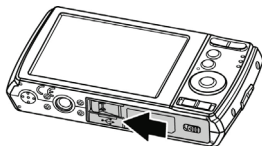

2. Open the battery/memory card compartment at the bottom of the camera as illustrated.

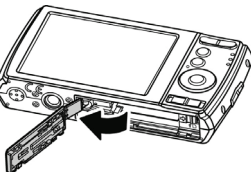

3. Insert the battery into the compartment with correct orientation as illustrated. Be sure to push the battery into position until the battery is locked into place.

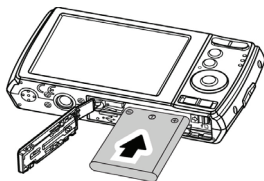

4. Close and secure the battery/memory card compartment by sliding the locking button towards the edge of the camera (as illustrated).

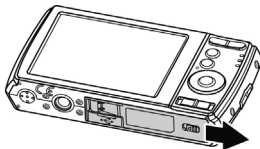
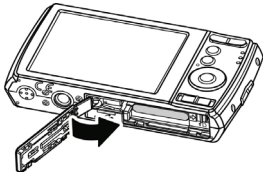

Charging the Battery by USB

The battery that comes along with your package is not fully charged. You need to charge the battery before using the camera.

1. Connect the camera with the USB cable as shown.
 2. Connect the other end with the USB adapter and plug it into a power outlet or with the USB port of PC directly for charging.
- When the battery is charging, the LED indicator lights up.
 - When the battery is fully charged, the LED indicator turns off.
 - When the battery is incorrectly charged, the LED indicator flashes rapidly.
 - When the camera is connected without the battery, the LED indicator will not light up.

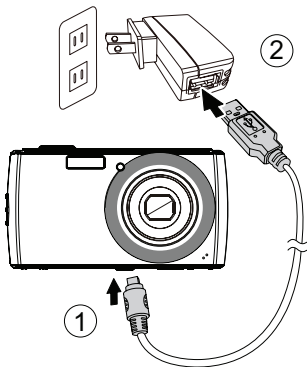

The battery charging time is approximately 2 hours.



It's not recommended to operate the camera when charging.

Inserting an SD/SDHC Memory Card

It is highly recommended that the camera storage is expanded by inserting a SD or SDHC memory card. These memory cards are available at most consumer store and online locations.

1. Make sure to power off the camera before proceeding. Inserting the memory card while powered on may damage the card and camera.
2. Open the battery/memory card compartment at the bottom of the camera.
3. Insert the SD/SDHC card into the memory card slot with the metallic connectors facing the front side of the camera as illustrated below.
4. Push the SD/SDHC card into the memory slot until it clicks into place. If the card does not click into place, repeat the previous step to ensure proper orientation.
5. Close the battery/memory card compartment.

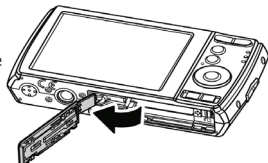

The 720p video recording capability of this camera requires a class 6 (High Speed) SD/SDHC memory card.

- To remove the SD/SDHC card

1. Make sure to power off the camera before proceeding.
Removing the memory card while powered on may damage the card and camera.
2. Open the battery/memory card compartment.
3. Gently push the card until it clicks and pushes out of position.
4. Carefully pull out the card.

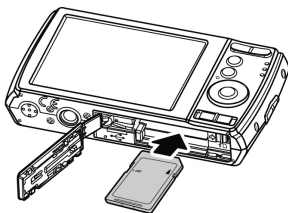



2. Initial Settings

When the camera is powered up for the first time, please set the display language and date & time.

Setting the Language

1. Use the 4-way navigation control to move through the selections.
2. Highlight the desired language and press the **OK button**  to select.

Setting the Date & Time

1. Use the 4-way navigation control to move through the selections and to change the setting values.
2. Press **OK button**  when finished. This will save your date and time settings.
3. If necessary, press **Menu button**  Menu to close the menu.

At this point, the camera settings are set to the default automatic mode and is ready to take photos and videos.

Modes

This camera has a three mode selector switch. The different modes are:



Photo Mode

- Slide the mode switch to [] take photos and record audio clips by selecting Voice REC from scene modes.

Video Mode

- Slide the mode switch to [] record videos.



Playback Mode

- Slide the mode switch to [] view and edit captured images or playback videos and audio clips.



The recording of voice memo attached to images is also available in this mode.

3. Taking Photos

This camera is designed to make the experience of taking photos simple and quick. It's Auto mode feature will optimise the internal settings so that in most situations, it can take photos with ease. This camera also has additional modes and features that extend the capabilities for the more experienced user.

1. Power on the camera by pressing the Power button .
2. Slide the Mode switch to Photo mode [].
3. Frame the shot using the focus bracket on the LCD monitor.



4. Lightly pressing the **Shutter button**  down to the halfway position will start the automatic focus and adjustments to the exposure level. When the camera has successfully completed this automatic routine, the focus bracket will turn green. If the automatic focus and exposure routine is not successful, the bracket will turn red. If this occurs, simply release the shutter and repeat this step until the bracket turns green. In some situations, lighting and contrast may be insufficient for the camera to successfully complete the auto focus and exposure level routine. If this occurs, try better lighting.
5. Pressing the **Shutter button**  down fully will take the photo. If you take the photo when the bracket is red, the focus and exposure may not be correct.



If the shake warning icon  appears, hold the camera steadily, with your arms at your side or use a tripod to stabilize the camera to reduce the risk of blurred photos.

4. Using the Function Menu

The Function Menu is used to quickly adjust basic capture settings while in Photo and Video mode. In Photo mode, the Function menu displays the last 6 scene modes used as well as allow changes to be made in resolution and file compression quality settings, (EV compensation, Auto White Balance (AWB), ISO settings, Metering, and Color mode may be available for different scene modes). In Video mode, the function menu displays and allows changes to be made to Video resolution setting, AWB, Metering, and Color mode.



FUNC.

- Press the **FUNC** button of your camera to launch the Function Menu.
- Press the **FUNC** button again to close the menu.
- The Menu bar displays the current status of the camera settings. Only the available functions for the settings are shown as icon on the menu bar.
- The available options for each item on the menu bar are shown in the Menu options.
- Use the  or  key to move through the menu selections then press the **OK button**  to save and apply the changes.

Menu Options

Menu Bar

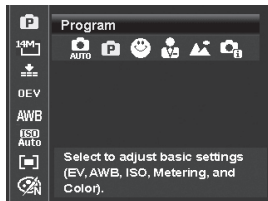

5. Playback

Playback the photos, video and audio clips on the LCD screen.



Viewing in Single Navigation

The Single navigation mode displays the image one by one on the LCD monitor. To view images/videos/audio clips, follow the steps below.

1. Slide the Mode switch to Playback mode .
2. The camera's LCD screen will display an image. To understand the icons and other information on the screen, please see "Photo Mode Screen Layout" in the electronic User Manual on the software CD-ROM.

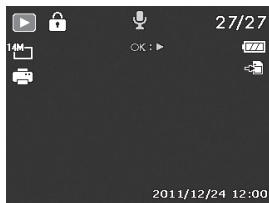
Still Image











3. Use the  or  keys to view next/previous image/video/audio.
4. To play a movie or audio clip, press the **OK button** .

6. Using the Setup Menu

You can access the Setup menu whether you are in Record or Playback mode.

The Setup menu allows to configure general camera settings.

- To enter the Setup Menu:

1. Press **Menu button**  **Menu** to launch the Record/Playback Menu.
2. Use the  or  keys to switch the menu tab to Setup menu.
3. Use the  or  keys to move through the menu selections.
4. To select an item, press the **OK button**  or  key.
5. Change the submenu settings using the 4-way navigation control.
6. Press the OK button  to save and apply settings.

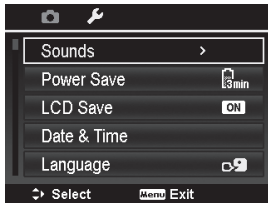

Product Support

Should you have a technical support question or your HP Digital Camera require service within the warranty period, please contact the original point of purchase or an authorized HP reseller in your country. If service is not available at those locations, please contact an HP Branded Product warranty agent from the support contact list provided below. A service agent will work with you to troubleshoot your issue and if necessary, issue a Return Material Authorization (RMA) number in order to replace your HP Branded Product. For warranty claims, you will be required to provide a copy of your original dated sales receipt as proof of purchase and the issued RMA number. You will be responsible for shipping charges when shipping the product to the service center. The service agent will provide you with an address and you will also be responsible for any shipping charges to the warranty service center. Once your product is received by this service center, a replacement unit will be shipped back to you typically within 5 business days.

Contact/phone Support:	
Language	Contact/phone Support:
中文	simp.chinese@hpodd.com
	trad.chinese@hpodd.com
Deutsch	deutsch@hpodd.com
Nederlands	hollands@hpodd.com
English	english@hpodd.com
Español	espanol@hpodd.com
Français	français@hpodd.com
Italiano	italiano@hpodd.com
日本語	nippon@hpodd.com
한국어	korean@hpodd.com
Português	portugues@hpodd.com
Svenska	svensk@hpodd.com

Contact/phone Support:			
Country		Language	Number
Europe Region (EMEA)			
België		Nederlands/ Deutsch	+ 32 2700 1724
Deutschland		Deutsch	+ 49 6950073896
España		Español	+ 34 914533458
France		Français	+ 33 171230454
Ireland		English	+ 353 1850882016
Italia		Italiano	+ 39 269682189
Nederland		Nederlandsk	+ 31 202015093
Schweiz		Deutsch/ Français/ Italiano	+ 41 18009686
UK		English	+ 44 2073652400
North America			
United States		English	1.866.694.7633
Canada		English and Français	1.866.694.7633
Country	Language	City	Number
México	Español	Mexico City	52.55.1204.8185
		Guadalajara	52.33.1031.3872
		Monterrey	52.81.1107.2639
Venezuela	Español	Caracas	58.212.335.4574
Colombia	Español	Bogota	57.1.508.2325
Perú	Español	Lima	51.1.705.6232
Chile	Español	Santiago	55.11.5504.6633
Brasil	Português	Sao Paolo	55.11.5504.6633
Argentina	Español	Buenos Aires	54.11.6091.2399

P/N: 7525C00265A