

Getting Started

HP Notebook

© Copyright 2011 Hewlett-Packard Development Company, L.P.

Bluetooth is a trademark owned by its proprietor and used by Hewlett-Packard Company under license. Microsoft and Windows are U.S. registered trademarks of Microsoft Corporation. SD Logo is a trademark of its proprietor.

The information contained herein is subject to change without notice. The only warranties for HP products and services are set forth in the express warranty statements accompanying such products and services. Nothing herein should be construed as constituting an additional warranty. HP shall not be liable for technical or editorial errors or omissions contained herein.

Second Edition: July 2011

First Edition: March 2011

Document Part Number: 644178-002

Product notice

This guide describes features that are common to most models. Some features may not be available on your computer.

Software terms

By installing, copying, downloading, or otherwise using any software product preinstalled on this computer, you agree to be bound by the terms of the HP End User License Agreement (EULA). If you do not accept these license terms, your sole remedy is to return the entire unused product (hardware and software) within 14 days for a refund subject to the refund policy of your place of purchase.

For any further information or for requesting a full refund of the computer, please contact your local point of sale (the seller).

Safety warning notice

-
- ⚠ **WARNING!** To reduce the possibility of heat-related injuries or of overheating the computer, do not place the computer directly on your lap or obstruct the computer air vents. Use the computer only on a hard, flat surface. Do not allow another hard surface, such as an adjoining optional printer, or a soft surface, such as pillows or rugs or clothing, to block airflow. Also, do not allow the AC adapter to come into contact with the skin or a soft surface, such as pillows or rugs or clothing, during operation. The computer and the AC adapter comply with the user-accessible surface temperature limits defined by the International Standard for Safety of Information Technology Equipment (IEC 60950).
-

Table of contents

1 Welcome

Finding information	2
---------------------------	---

2 Getting to know your computer

Top	4
TouchPad	4
Lights	5
Buttons and fingerprint reader	7
Keys	9
Front	11
Right	13
Left	14
Display	16
Rear	18
Bottom	19

3 Networking

Using an Internet service provider (ISP)	22
Connecting to a wireless network	22
Connecting to an existing WLAN	23
Setting up a new WLAN network	23
Configuring a wireless router	24
Protecting your WLAN	24

4 HP QuickWeb

Getting started	25
Starting HP QuickWeb	26

5 Keyboard and pointing devices

Using the keyboard	28
Identifying the hotkeys	28
Using keypads	29
Using the integrated numeric keypad	29

Using an optional external numeric keypad	30
Using pointing devices	31
Setting pointing device preferences	31
Using the pointing stick	31
Using the TouchPad	31
Turning the TouchPad off and on	32
Navigating	32
Selecting	33
Using TouchPad gestures	33
Scrolling	34
Pinching/Zooming	34
Rotating	35

6 Maintenance

Inserting or removing the battery	36
Removing or replacing the bottom cover	38
Removing the bottom cover	38
Replacing the bottom cover	38
Replacing or upgrading the hard drive	40
Removing the hard drive	40
Installing a hard drive	41
Replacing a drive in the upgrade bay	41
Replacing a hard drive	41
Replacing an optical drive	43
Adding or replacing memory modules	45
Updating programs and drivers	47
Using SoftPaq Download Manager	48
Cleaning your computer	49
Cleaning products	49
Cleaning procedures	49
Cleaning the display	50
Cleaning the sides and cover	50
Cleaning the TouchPad and keyboard	50

7 Backup and recovery

Windows 7	51
Backing up your information	51
Performing a system recovery	52
Using the Windows recovery tools	53
Using f11 recovery tools	53
Using a Windows 7 operating system DVD (purchased separately)	54
Windows Vista	55
Backing up your information	55

Performing a recovery	56
Using the Windows recovery tools	56
Using f11 recovery tools	57
Using a Windows Vista operating system DVD (purchased separately)	58
8 Customer support	
Contacting customer support	60
Labels	61
9 Specifications	
Input power	63
Operating environment	64
Index	65

1 Welcome

- [Finding information](#)

After you set up and register the computer, it is important to take the following steps:

- **Connect to the Internet**—Set up your wired or wireless network so that you can connect to the Internet. For more information, refer to [Networking on page 21](#).
- **Update your antivirus software**—Protect your computer from damage caused by viruses. The software is preinstalled on the computer and includes a limited subscription for free updates. For more information, refer to the *HP Notebook Reference Guide*. For instructions on accessing this guide, refer to [Finding information on page 2](#).
- **Get to know your computer**—Learn about your computer features. Refer to [Getting to know your computer on page 4](#) and [Keyboard and pointing devices on page 27](#) for additional information.
- **Find installed software**—Access a list of the software preinstalled on the computer. Select **Start > All Programs**. For details about using the software included with the computer, refer to the software manufacturer's instructions, which may be provided with the software or on the manufacturer's Web site.

Finding information

The computer comes with several resources to help you perform various tasks.

Resources	For information about
<i>Quick Setup</i> poster	<ul style="list-style-type: none">• How to set up the computer• Help to identify computer components
<i>Getting Started</i> guide	<ul style="list-style-type: none">• Computer features
To access this guide:	<ul style="list-style-type: none">• How to connect to a wireless network
Select Start > Help and Support > User Guides .	<ul style="list-style-type: none">• How to use the keyboard and pointing devices
– or –	<ul style="list-style-type: none">• How to replace or upgrade the hard drive and memory modules
Select Start > All Programs > HP > HP Documentation .	<ul style="list-style-type: none">• How to perform a backup and recovery• How to contact customer support• Computer specifications
<i>HP Notebook Reference Guide</i>	<ul style="list-style-type: none">• Power management features
To access this guide:	<ul style="list-style-type: none">• How to maximize battery life
Select Start > Help and Support > User Guides .	<ul style="list-style-type: none">• How to use the multimedia features of the computer
– or –	<ul style="list-style-type: none">• How to protect the computer
Select Start > All Programs > HP > HP Documentation .	<ul style="list-style-type: none">• How to care for the computer• How to update the software
Help and Support	<ul style="list-style-type: none">• Operating system information
To access Help and Support, select Start > Help and Support .	<ul style="list-style-type: none">• Software, driver, and BIOS updates• Troubleshooting tools
NOTE: For country- or region-specific support, go to http://www.hp.com/support , select your country or region, and follow the on-screen instructions.	<ul style="list-style-type: none">• How to access technical support
<i>Regulatory, Safety and Environmental Notices</i>	<ul style="list-style-type: none">• Regulatory and safety information
To access this guide:	<ul style="list-style-type: none">• Battery disposal information
Select Start > Help and Support > User Guides .	
– or –	
Select Start > All Programs > HP > HP Documentation .	
<i>Safety & Comfort Guide</i>	<ul style="list-style-type: none">• Proper workstation setup, posture, health, and work habits
To access this guide:	<ul style="list-style-type: none">• Electrical and mechanical safety information
Select Start > Help and Support > User Guides .	
– or –	
Select Start > All Programs > HP > HP Documentation .	

Resources	For information about
– or –	
Go to http://www.hp.com/ergo .	
<i>Worldwide Telephone Numbers</i> booklet This booklet is provided with your computer.	HP support telephone numbers
HP Web site To access this Web site, go to http://www.hp.com/support .	<ul style="list-style-type: none"> • Support information • Ordering parts and finding additional help • Accessories available for the device
<i>Limited Warranty*</i> To access the warranty: Select Start > Help and Support > User Guides > View Warranty Information .	Warranty information
– or –	
Select Start > All Programs > HP > HP Documentation > View Warranty Information .	
– or –	
Go to http://www.hp.com/go/orderdocuments .	
*You may find the expressly provided HP Limited Warranty applicable to your product located with the electronic guides on your computer and/or on the CD/DVD provided in the box. Some countries/regions may provide a printed HP Limited Warranty in the box. In countries/regions where the warranty is not provided in printed format, you may request a printed copy at http://www.hp.com/go/orderdocuments or write to:	
<ul style="list-style-type: none"> • North America: Hewlett-Packard, MS POD, 11311 Chinden Blvd, Boise, ID 83714, USA • Europe, Middle East, Africa: Hewlett-Packard, POD, Via G. Di Vittorio, 9, 20063, Cernusco s/Naviglio (MI), Italy • Asia Pacific: Hewlett-Packard, POD, P.O. Box 200, Alexandra Post Office, Singapore 911507 	
Please include your product number, warranty period (found on your serial number label), name, and postal address.	

2 Getting to know your computer

- [Top](#)
- [Front](#)
- [Right](#)
- [Left](#)
- [Display](#)
- [Rear](#)
- [Bottom](#)

Top

TouchPad

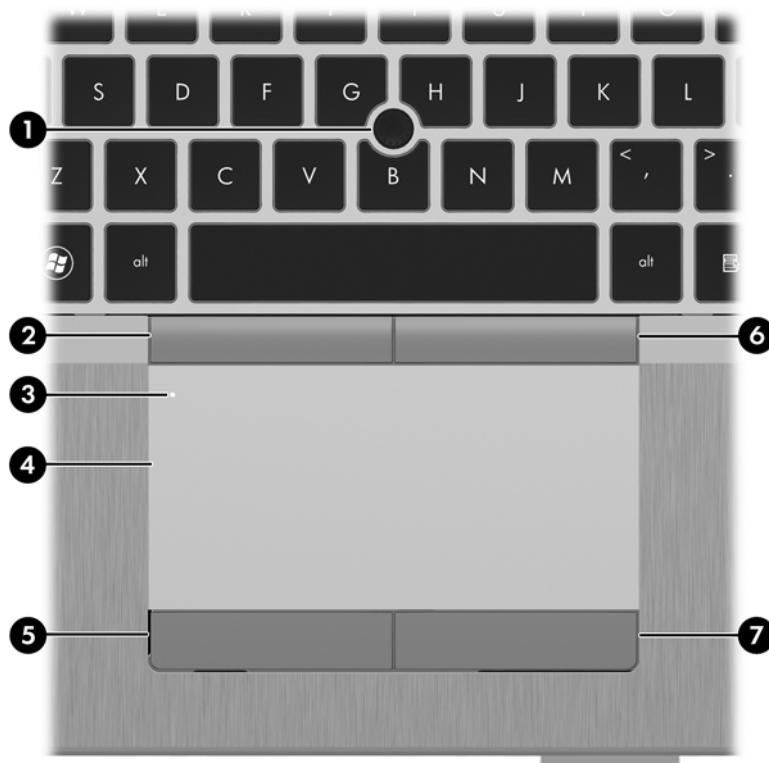



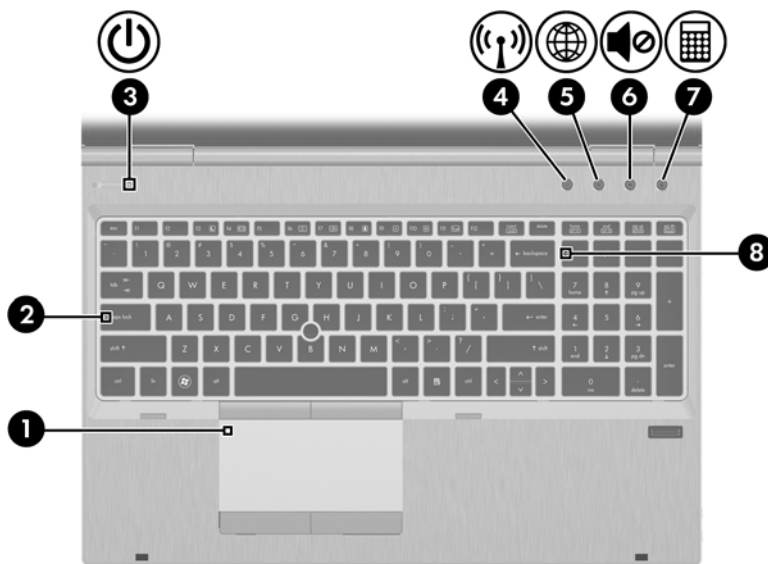

Component	Description
(1) Pointing stick (select models only)	Moves the pointer and selects or activates items on the screen.
(2) Left pointing stick button	Can be used with the pointing stick and functions like the left button on an external mouse.
(3) TouchPad on/off button	Turns the TouchPad on and off.
(4) TouchPad	Moves the pointer and selects or activates items on the screen. NOTE: Vertical scrolling is supported on the right edge of the TouchPad.
(5) Left TouchPad button	Functions like the left button on an external mouse.
(6) Right pointing stick button	Can be used with the pointing stick and functions like the right button on an external mouse.
(7) Right TouchPad button	Functions like the right button on an external mouse.

Lights

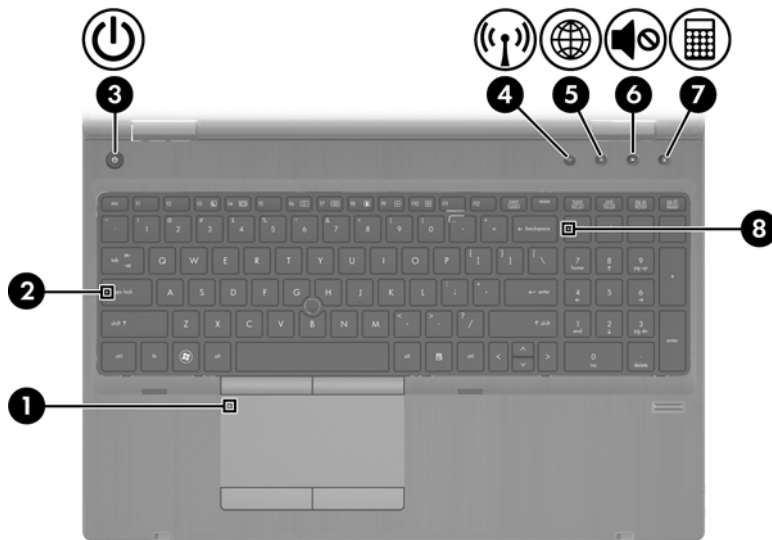
 **NOTE:** Refer to the illustration that most closely matches your computer.









Component	Description
(1) TouchPad on/off light	<ul style="list-style-type: none"> Amber: The TouchPad is off. Off: The TouchPad is on.
(2) Caps lock light	On: Caps lock is on.
(3)  Power light	<ul style="list-style-type: none"> On: The computer is on. Blinking: The computer is in the Sleep state. Off: The computer is off or in Hibernation.
(4)  Wireless light	<ul style="list-style-type: none"> White: An integrated wireless device, such as a wireless local area network (WLAN) device and/or a Bluetooth® device, is on. Amber: All wireless devices are off.
(5)  QuickWeb light	<ul style="list-style-type: none"> On: The computer is on. Off: The computer is off or in Hibernation. <p>NOTE: For more information, refer to “HP QuickWeb” in this guide and to the HP Quickweb software Help</p>
(6)  Mute light	<ul style="list-style-type: none"> Amber: Computer sound is off. Off: Computer sound is on.
(7)  Calculator light	<ul style="list-style-type: none"> On: The Windows® calculator function is on. Blinking: The Windows calculator has been activated.
(8) Num lock light	On: Num lock is on.

Buttons and fingerprint reader

 **NOTE:** Refer to the illustration that most closely matches your computer.



Component	Description
(1)	TouchPad on/off button
(2) 	Power button <ul style="list-style-type: none">• When the computer is off, press the button to turn on the computer.• When the computer is on, press the button briefly to initiate Sleep.• When the computer is in the Sleep state, press the button briefly to exit Sleep.• When the computer is in Hibernation, press the button briefly to exit Hibernation.



Component	Description
	<p>If the computer has stopped responding and Windows® shutdown procedures are ineffective, press and hold the power button for at least 5 seconds to turn off the computer.</p> <p>To learn more about your power settings:</p> <ul style="list-style-type: none"> • Windows 7—Select Start > Control Panel > System and Security > Power Options. • Windows Vista—Select Start > Control Panel > System and Maintenance > Power Options • Or refer to the <i>HP Notebook Reference Guide</i>.
(3)  Wireless button	Turns the wireless feature on or off but does not establish a wireless connection.
(4)  QuickWeb button	<ul style="list-style-type: none"> • When the computer is off or in Hibernation, press the button to open HP QuickWeb. • When the computer is in Microsoft Windows, press the button to open the default Web browser. • When the computer is in HP QuickWeb, press the button to open the default Web browser. <p>NOTE: For more information, refer to “HP QuickWeb” in this guide and to the HP QuickWeb software Help. If your computer does not have HP QuickWeb software, the button does not perform any action or function.</p>
(5)  Volume mute button	Mutes and restores speaker sound.
(6)  Calculator button (select models only)	Opens the Windows calculator function.
(7) Fingerprint reader (select models only)	Allows a fingerprint logon, instead of a password logon.

Keys

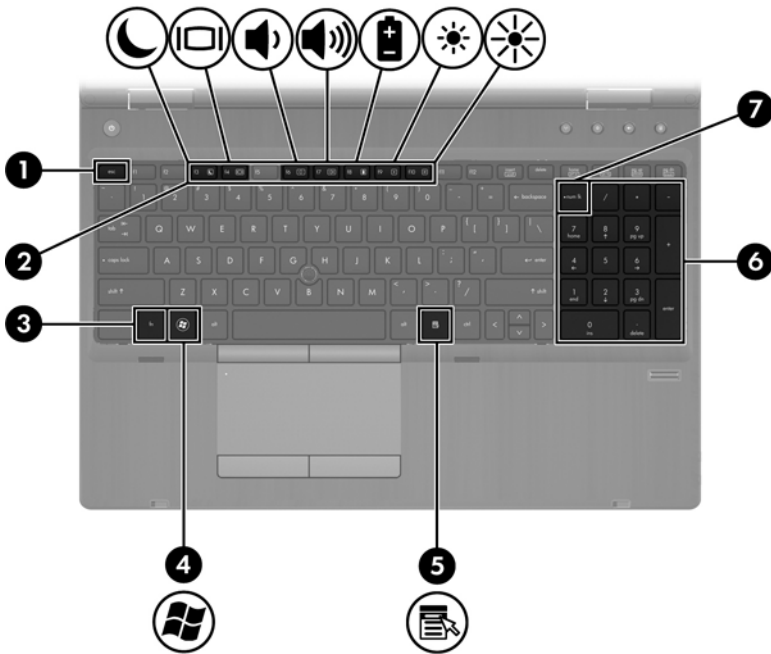
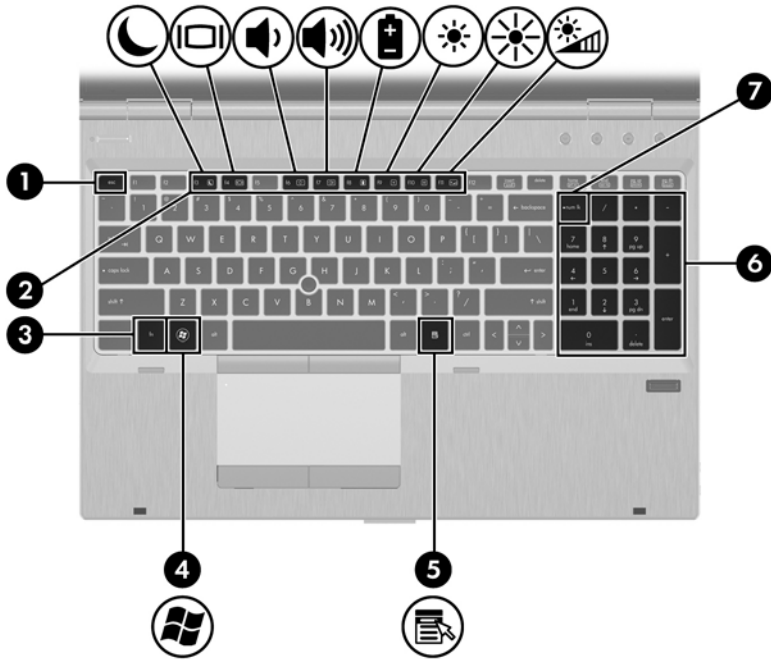
NOTE: Refer to the illustration that most closely matches your computer.



Component	Description
(1) esc key	Displays system information when pressed in combination with the fn key.
(2) Function keys	Execute frequently used system functions when pressed in combination with the fn key.

Component		Description
(3)	<code>fn</code> key	Executes frequently used system functions when pressed in combination with a function key, the <code>num lk</code> key, or the <code>esc</code> key.
(4)	 Start key	Displays the Start menu.
(5)	 Menu key	Displays the active program's shortcut menu (same as right-click menu).
(6)	Integrated numeric keypad	When the keypad has been enabled, the keys can be used like an external numeric keypad.
(7)	<code>num lk</code> key	Enables/disables the embedded numeric keypad when pressed in combination with the <code>fn</code> key.

Front

 **NOTE:** Refer to the illustration that most closely matches your computer.

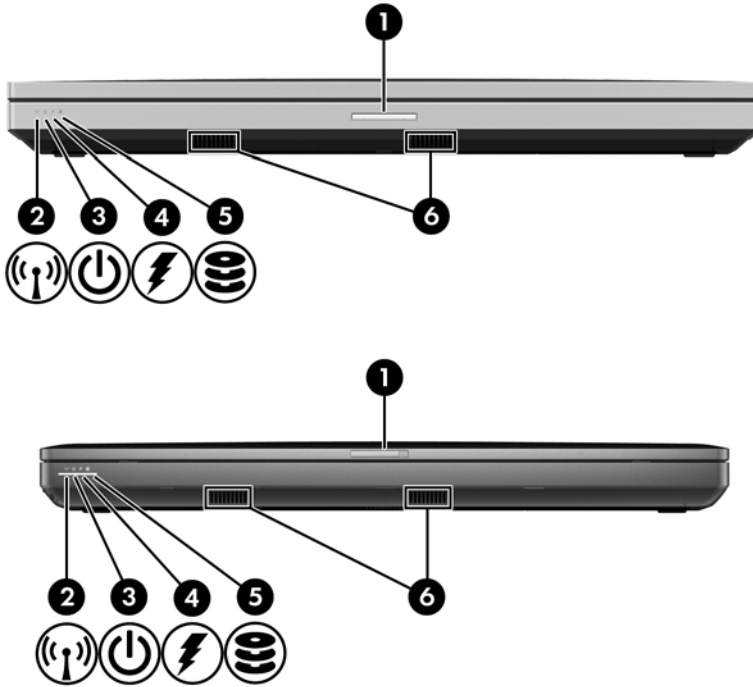





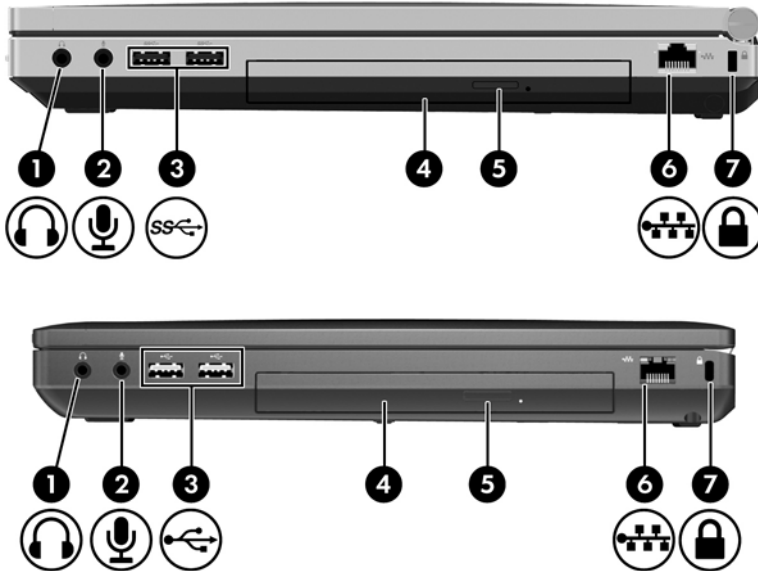

Component	Description
(1) Display release latch	Opens the computer.
(2) Wireless light	<ul style="list-style-type: none"> • White: An integrated wireless device, such as a wireless local area network (WLAN) device and/or a Bluetooth® device, is on. • Amber: All wireless devices are off.
(3) Power light	<ul style="list-style-type: none"> • On: The computer is on. • Blinking: The computer is in the Sleep state. • Off: The computer is off or in Hibernation.
(4) Battery light	<ul style="list-style-type: none"> • Amber: The computer is connected to external power and the battery is charged from 0 – 90%. • White: The computer is connected to external power and the battery is charged from 90 – 99%. • Blinking amber: A battery that is the only available power source has reached a low battery level. When the battery reaches a critical battery level, the battery light begins blinking rapidly. • Off: The battery is fully charged.

Component	Description
(5) Hard drive light	<ul style="list-style-type: none"><li data-bbox="815 226 1414 279">• Blinking turquoise: The hard drive or optical drive is being accessed.<li data-bbox="815 302 1433 354">• Amber: HP 3D DriveGuard has temporarily parked the hard drive.
(6) Speakers (2)	Produce SRS Premium sound (select models only). NOTE: To use the SRS Premium sound software, select Start > All Programs > SRS Premium Sound .

Right

 **NOTE:** Refer to the illustration that most closely matches your computer.







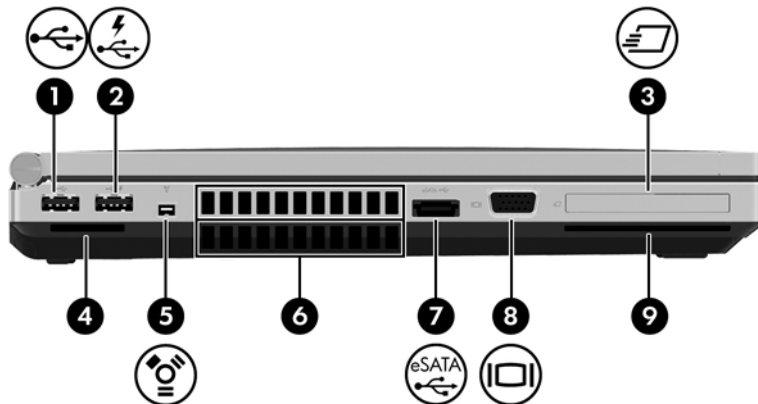

Component	Description
(1)  Audio-out (headphone) jack	Produces sound when connected to optional powered stereo speakers, headphones, ear buds, a headset, or television audio. NOTE: When a device is connected to the headphone jack, the computer speakers are disabled.
(2)  Audio-in (microphone) jack	Connects an optional computer headset microphone, stereo array microphone, or monaural microphone.
(3)  SuperSpeed USB ports (2)	Connect optional USB devices.
 USB ports (2)	Connect optional USB devices.
(4) Optical drive	Reads and writes (select models only) to an optical disc.
(5) Optical drive eject button	Ejects the optical drive.
(6)  RJ-45 (network) jack	Connects a network cable.
(7)  Security cable slot	Attaches an optional security cable to the computer. NOTE: The security cable is designed to act as a deterrent, but it may not prevent the computer from being mishandled or stolen.





Left

 **NOTE:** Refer to the illustration that most closely matches your computer.

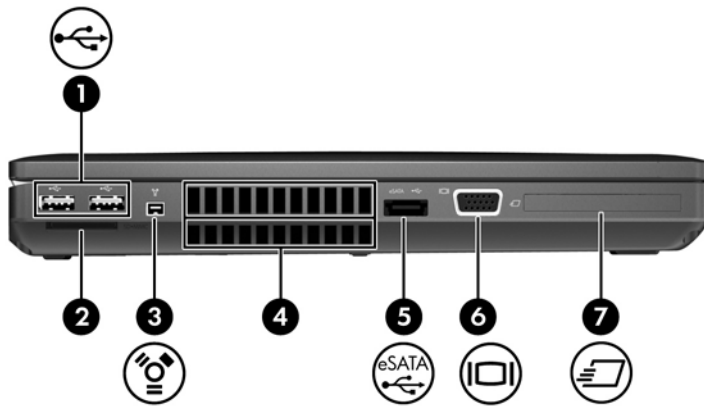

Component	Description
(1)  USB port	Connects an optional USB device.
(2)  USB powered/charging port	Connects an optional USB device.
(3)  ExpressCard slot (select models only)	Supports optional ExpressCards.
(4) Media Card Reader	Supports the following digital card formats: <ul style="list-style-type: none"> Secure Digital (SD) Card MultiMediaCard (MMC)
(5)  1394 port	Connects an optional IEEE 1394 or 1394a device, such as a camcorder.
(6) Vents (2)	Enable airflow to cool internal components. NOTE: The computer fan starts up automatically to cool internal components and prevent overheating. It is normal for the internal fan to cycle on and off during routine operation.
(7)  eSATA/USB port	Connects a high-performance eSATA component, such as an eSATA external hard drive, or connects an optional USB device.
(8)  External monitor port	Connects an external VGA monitor or projector.
(9) Smart Card reader slot (select models only)	Supports optional Smart Cards.



Component	Description
(1)  USB ports (2)	Connects an optional USB device.
(2) Media Card Reader	Supports the following digital card formats: <ul style="list-style-type: none"> Secure Digital (SD) Card MultiMediaCard (MMC)
(3)  1394 port	Connects an optional IEEE 1394 or 1394a device, such as a camcorder.
(4) Vents (2)	Enable airflow to cool internal components. NOTE: The computer fan starts up automatically to cool internal components and prevent overheating. It is normal for the internal fan to cycle on and off during routine operation.
(5)  eSATA/USB port	Connects a high-performance eSATA component, such as an eSATA external hard drive, or connects an optional USB device.
(6)  External monitor port	Connects an external VGA monitor or projector.
(7)  ExpressCard slot or Smart Card reader slot (depending on configuration)	Supports optional ExpressCards or Smart Cards.

Display

 **NOTE:** Refer to the illustration that most closely matches your computer.

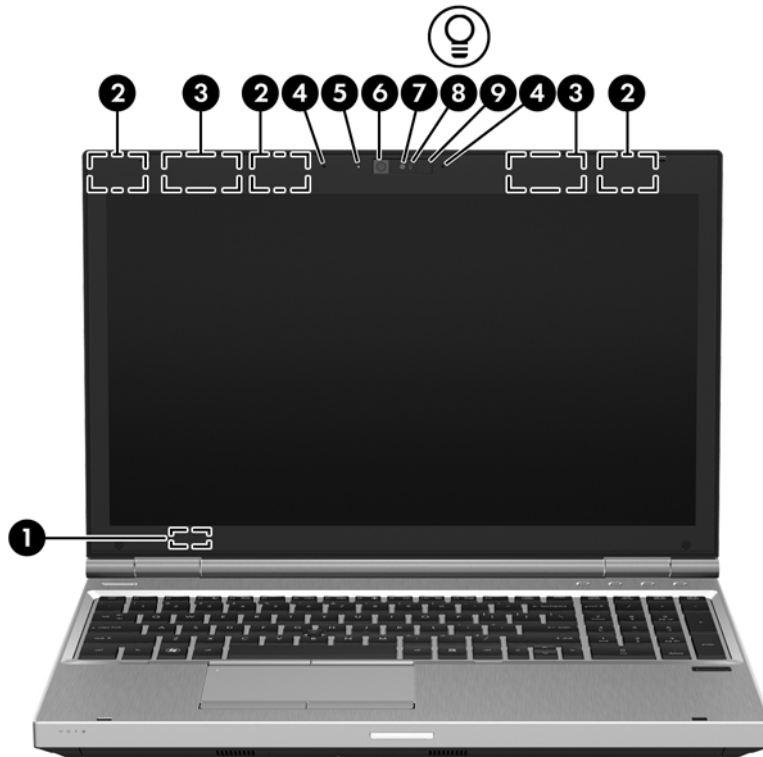

Component	Description
(1) Internal display switch	Turns off the display or initiates Sleep if the display is closed while the power is on. NOTE: The display switch is not visible from the outside of the computer.
(2) WLAN antennas (3)*	Send and receive wireless signals to communicate with wireless local area networks (WLAN).
(3) WWAN antennas (2)* (select models only)	Send and receive wireless signals to communicate with wireless wide-area networks (WWAN).
(4) Internal microphones (2) (select models only)	Record sound.
(5) Webcam light (select models only)	On: The webcam is in use.
(6) Webcam (select models only)	Records video and captures still photographs. To use the webcam, select Start > All Programs > HP > HP Webcam .
(7) Ambient light sensor	When activated, the sensor automatically adjusts the display brightness based on the lighting conditions in your environment.
(8) Keyboard light	On: When the keyboard light is activated.

Component	Description
(9) Keyboard light button	Used to activate the keyboard light.

*The antennas are not visible from the outside of the computer. For optimal transmission, keep the areas immediately around the antennas free from obstructions. To see wireless regulatory notices, refer to the section of the *Regulatory, Safety and Environmental Notices* that applies to your country or region. These notices are located in Help and Support.







Component	Description
(1) Internal display switch	Turns off the display or initiates Sleep if the display is closed while the power is on. NOTE: The display switch is not visible from the outside of the computer.
(2) WLAN antennas (2)*	Send and receive wireless signals to communicate with wireless local area networks (WLAN).
(3) WWAN antennas (2)* (select models only)	Send and receive wireless signals to communicate with wireless wide-area networks (WWAN).
(4) Internal microphone(s) (1 or 2 depending on model)	Record sound.
(5) Webcam light (select models only)	On: The webcam is in use.
(6) Webcam (select models only)	Records video and captures still photographs. To use the webcam, select Start > All Programs > HP > HP Webcam .

*The antennas are not visible from the outside of the computer. For optimal transmission, keep the areas immediately around the antennas free from obstructions. To see wireless regulatory notices, refer to the section of the *Regulatory, Safety and Environmental Notices* that applies to your country or region. These notices are located in Help and Support.

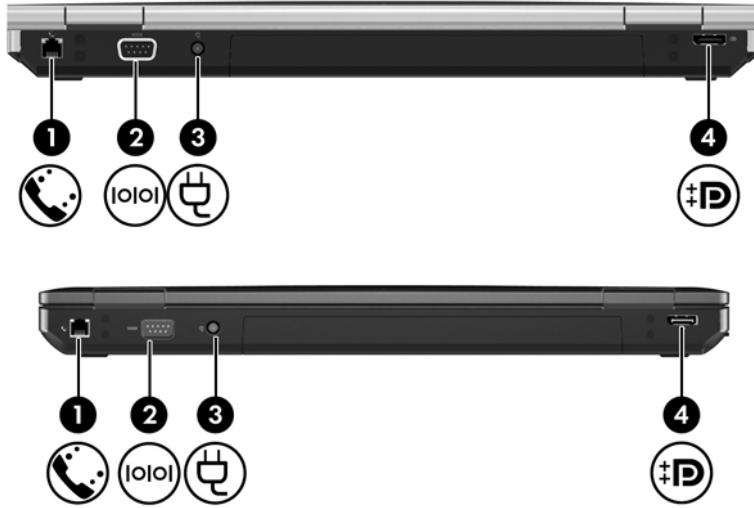
Rear

 **NOTE:** Refer to the illustration that most closely matches your computer.





Component	Description
(1) 	RJ-11 (modem) jack Connects a modem cable.
(2) 	Serial port Connects an optional device such as a serial modem, mouse, or printer.
(3) 	Power connector Connects an AC adapter.
(4) 	DisplayPort Connects an optional digital display device, such as a high-performance monitor or projector.

Bottom

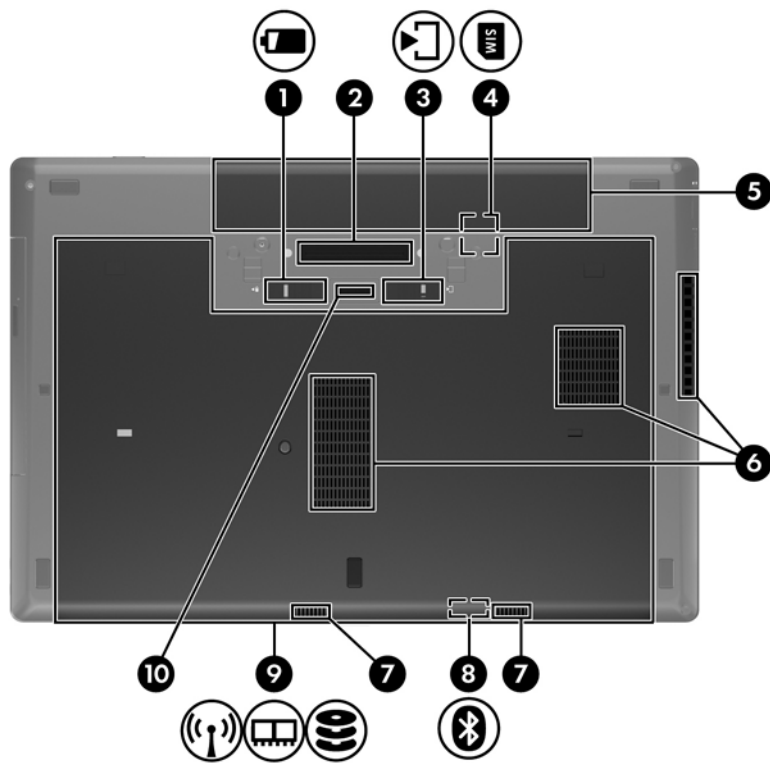
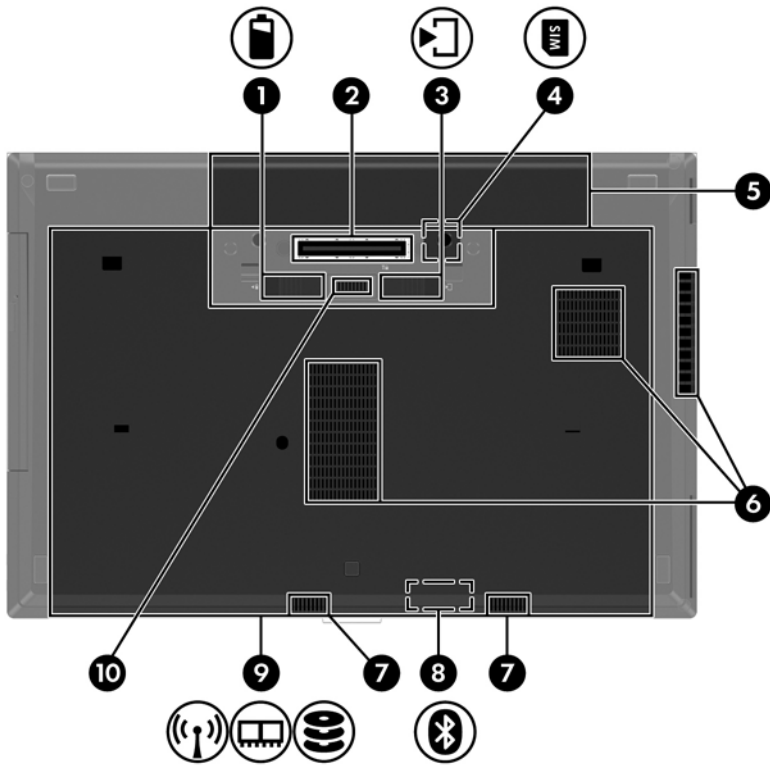
 **NOTE:** Refer to the illustration that most closely matches your computer.



Component		Description
(1)	 Battery release latch	Releases the battery from the battery bay.
(2)	Docking connector	Connects an optional docking device.
(3)	Bottom cover release latch	Releases or locks the bottom cover.
(4)	SIM slot	Contains a wireless subscriber identity module (SIM). The SIM slot is located inside the battery bay.
(5)	Battery bay	Holds the battery.
(6)	Vents (3)	Enable airflow to cool internal components. NOTE: The computer fan starts up automatically to cool internal components and prevent overheating. It is normal for the internal fan to cycle on and off during routine operation.
(7)	Speakers (2)	Produce sound.
(8)	Bluetooth compartment	Contains a Bluetooth device.
(9)	 Wireless and memory module compartments and hard drive bay	Hold an HP Mobile Broadband Module, the memory modules, and the hard drive. NOTE: To prevent an unresponsive system, replace the wireless module only with a wireless module authorized for use in the computer by the governmental agency that regulates wireless devices in your country or region. If you replace the module and then receive a warning message, remove the module to restore computer functionality, and then contact technical support through Help and Support.
(10)	Accessory battery connector	Connects an optional accessory battery.

3 Networking

- [Using an Internet service provider \(ISP\)](#)
- [Connecting to a wireless network](#)

 **NOTE:** Internet hardware and software features vary depending on computer model and your location.

Your computer may support one or both of the following types of Internet access:

- **Wireless**—For mobile Internet access, you can use a wireless connection. Refer to [Connecting to an existing WLAN on page 23](#) or [Setting up a new WLAN network on page 23](#).
- **Wired**—You can access the Internet by connecting to a wired network. For information on connecting to a wired network, refer to the *HP Notebook Reference Guide*.

Using an Internet service provider (ISP)

Before you can connect to the Internet, you must establish an ISP account. Contact a local ISP to purchase Internet service and a modem. The ISP will help set up the modem, install a network cable to connect your wireless computer to the modem, and test the Internet service.

 **NOTE:** Your ISP will give you a user ID and password to access the Internet. Record this information and store it in a safe place.

The following features will help you set up a new Internet account or configure the computer to use an existing account:

- **Internet Services & Offers (available in some locations)**—This utility assists with signing up for a new Internet account and configuring the computer to use an existing account. To access this utility, select **Start > All Programs > Online Services > Get Online**.
- **ISP-provided icons (available in some locations)**—These icons may be displayed either individually on the Windows desktop or grouped in a desktop folder named Online Services. To set up a new Internet account or configure the computer to use an existing account, double-click an icon, and then follow the on-screen instructions.
- **Windows Connect to the Internet Wizard**—You can use the Windows Connect to the Internet Wizard to connect to the Internet in any of these situations:
 - You already have an account with an ISP.
 - You do not have an Internet account and want to select an ISP from the list provided within the wizard. (The list of ISP providers is not available in all regions.)
 - You have selected an unlisted ISP, and the ISP has provided you with information such as a specific IP address and POP3 and SMTP settings.

To access the Windows Connect to the Internet Wizard and instructions for using it, select **Start > Help and Support**, and then type `Connect to the Internet wizard` in the Search box.

 **NOTE:** If you are prompted within the wizard to choose between enabling or disabling Windows Firewall, choose to enable the firewall.

Connecting to a wireless network

Wireless technology transfers data across radio waves instead of wires. Your computer may be equipped with one or more of the following wireless devices:

- Wireless local area network (WLAN) device
- HP Mobile Broadband Module, a wireless wide area network (WWAN) device
- Bluetooth device

For more information on wireless technology and connecting to a wireless network, refer to the *HP Notebook Reference Guide* and information and Web site links provided in Help and Support.

Connecting to an existing WLAN

1. Turn on the computer.
2. Be sure that the WLAN device is on.
3. Click the network icon in the notification area, at the far right of the taskbar.
4. Select a network to connect to.
5. Click **Connect**.
6. If required, enter the security key.

Setting up a new WLAN network

Required equipment:

- A broadband modem (either DSL or cable) **(1)** and high-speed Internet service purchased from an Internet service provider (ISP)
- A wireless router (purchased separately) **(2)**
- Your new wireless computer **(3)**

 **NOTE:** Some modems have a built-in wireless router. Check with your ISP to determine what type of modem you have.

The illustration shows an example of a completed WLAN network installation that is connected to the Internet. As your network grows, additional wireless and wired computers can be connected to the network to access the Internet.

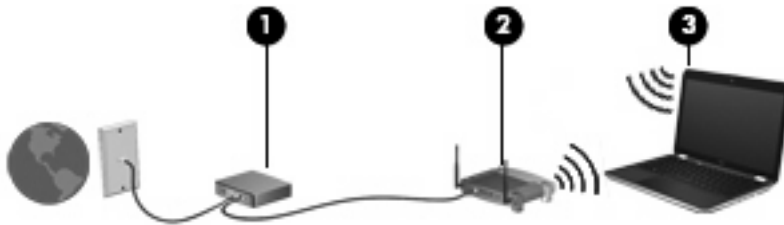

Configuring a wireless router

For help in setting up a WLAN, refer to the information provided by your router manufacturer or your ISP.

The Windows operating system also provides tools to help you set up a new wireless network. To use the Windows tools to set up your network:

- **Windows 7**—Select **Start > Control Panel > Network and Internet > Network and Sharing Center > Set up a new connection or network > Set up a network**. Then follow the on-screen instructions.
- **Windows Vista**—Select **Start > Control Panel > Network and Internet > Network and Sharing Center > Set up a connection or network > Set up a wireless router or access point**. Then follow the on-screen instructions.

 **NOTE:** It is recommended that you initially connect your new wireless computer to the router by using the network cable provided with the router. When the computer successfully connects to the Internet, you can disconnect the cable, and then access the Internet through your wireless network.

Protecting your WLAN

When you set up a WLAN or access an existing WLAN, always turn on security features to protect your network from unauthorized access.

For information on protecting your WLAN, refer to the *HP Notebook Reference Guide*.

4 HP QuickWeb

Getting started

The HP QuickWeb environment provides a fun and engaging way to perform many of your favorite activities. Your computer is ready to go within seconds of turning it on, allowing you to rapidly access the Internet, widgets, and communication programs. Simply press the QuickWeb button on your computer, and then start browsing the Internet, communicating with Skype, and exploring other HP QuickWeb programs.

Your HP QuickWeb Home screen includes the following features:

- Web browser—Search and browse the Internet, and create links to your favorite Web sites.
- Skype—Communicate using Skype, an application that uses voice over Internet protocol (VoIP). Skype lets you make conference calls or have video chats with one or more people at a time. You can also make long-distance phone calls to land lines.
- QuickWeb E-Mail—Read and send e-mail by connecting to Web-based e-mail providers or to your own mail server.
- Widgets—Start using widgets for news, weather, social networking, stocks, a calculator, sticky notes, and more. You can also use Widget Manager to add more widgets to the HP QuickWeb Home screen.



NOTE: For additional information about using HP QuickWeb, refer to the HP QuickWeb software Help.

Starting HP QuickWeb

- To start HP QuickWeb, press the QuickWeb button when the computer is off or in Hibernation.

The following table explains the different behaviors of the QuickWeb button.

Button	Behavior
QuickWeb button	<ul style="list-style-type: none">• When the computer is off or in Hibernation, opens HP QuickWeb.• When the computer is in Microsoft Windows, opens the default Web browser.• When the computer is in HP QuickWeb, opens the default Web browser. <p>NOTE: If your computer does not have HP QuickWeb software, the button does not perform any action or function.</p>

 **NOTE:** For more information, refer to the HP QuickWeb software Help.

5 Keyboard and pointing devices

- [Using the keyboard](#)
- [Using pointing devices](#)

Using the keyboard

Identifying the hotkeys

 **NOTE:** Refer to the illustration that most closely matches your computer.



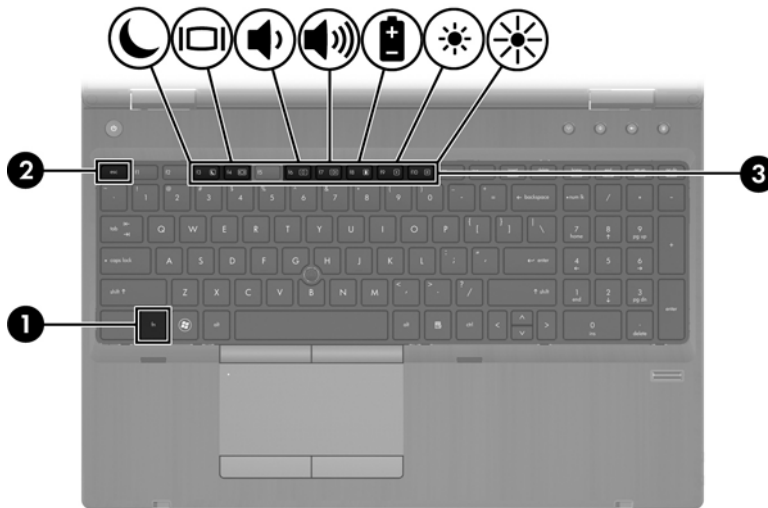



A hotkey is a combination of the **fn** key (1) and either the **esc** key (2) or one of the function keys (3).



To use a hotkey:

- ▲ Briefly press the **fn** key, and then briefly press the second key of the hotkey combination.

Hotkey combination	Description
fn+esc	Displays system information.
 fn+f3	Initiates Sleep, which saves your information in system. The display and other system components turn off and power is conserved. To exit Sleep, briefly press the power button.

Hotkey combination	Description
	<p>CAUTION: To reduce the risk of information loss, save your work before initiating Sleep.</p> <p>NOTE: If a critical battery level occurs while the computer is in the Sleep state, the computer initiates Hibernation and the information stored in memory is saved to the hard drive.</p> <p>The function of the fn+f3 hotkey can be changed. For example, you can set the fn+f3 hotkey to initiate Hibernation instead of Sleep. In all Windows operating system windows, references to the <i>sleep button</i> apply to the fn+f3 hotkey.</p>
	<p>fn+f4 Switches the screen image among display devices connected to the system. For example, if a monitor is connected to the computer, fn+f4 alternates the screen image from computer display to monitor display to simultaneous display on both the computer and the monitor.</p> <p>Most external monitors receive video information from the computer using the external VGA video standard. The fn+f4 hotkey can also alternate images among other devices that are receiving video information from the computer.</p>
	<p>fn+f6 Decreases speaker volume.</p>
	<p>fn+f7 Increases speaker volume.</p>
	<p>fn+f8 Displays charge information for all installed batteries. The display indicates which batteries are charging and reports the amount of charge remaining in each battery.</p>
	<p>fn+f9 Decreases the screen brightness level.</p>
	<p>fn+f10 Increases the screen brightness level.</p>
	<p>fn+f11 Activates and deactivates the ambient light sensor. When activated, the ambient light sensor automatically adjusts the display brightness based on the lighting conditions in your environment.</p>

Using keypads

The computer includes an integrated numeric keypad. The computer also supports an optional external numeric keypad or an optional external keyboard that includes a numeric keypad.

Using the integrated numeric keypad

 **NOTE:** Refer to the illustration that most closely matches your computer.

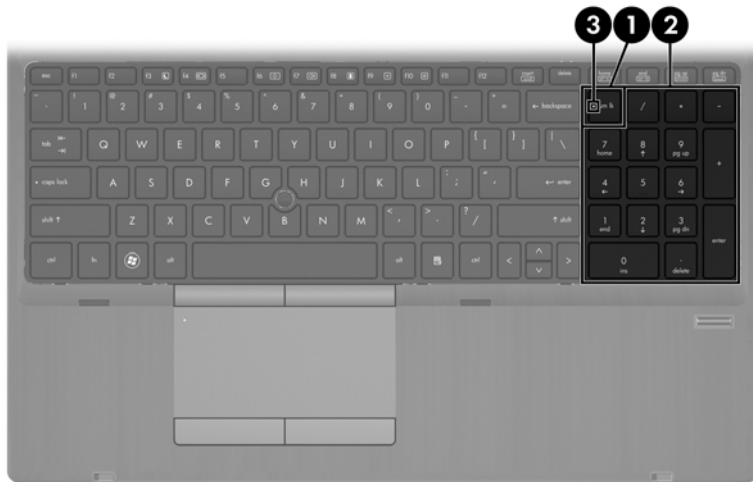
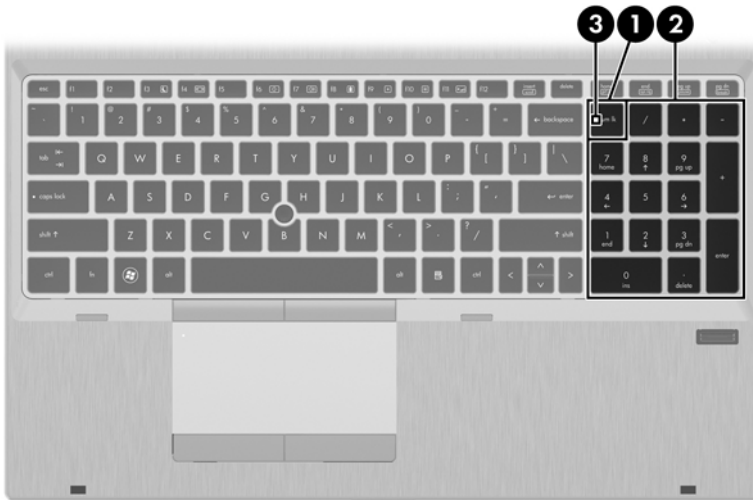

Component	Description
(1) num lk key	<p>Alternates between the navigational and numeric functions on the integrated numeric keypad.</p> <p>NOTE: The keypad function that is active when the computer is turned off remains on when the computer is turned back on.</p>
(2) Integrated numeric keypad	Can be used like an external numeric keypad.
(3) Num lock light	<ul style="list-style-type: none"> On: The keypad function is numeric. Off: The keypad function is navigational.

Using an optional external numeric keypad

Keys on most external numeric keypads function differently according to whether num lock is on or off. (Num lock is turned off at the factory.) For example:

- When num lock is on, most keypad keys type numbers.
- When num lock is off, most keypad keys function like the arrow, page up, or page down keys.

When num lock on an external keypad is turned on, the num lock light on the computer is turned on. When num lock on an external keypad is turned off, the num lock light on the computer is turned off.

To turn num lock on or off on an external keypad as you work:

- ▲ Press the **num lk** key on the external keypad, not on the computer.

Using pointing devices

 **NOTE:** In addition to the pointing devices included with your computer, you can use an external USB mouse (purchased separately) by connecting it to one of the USB ports on the computer.

Setting pointing device preferences

Use Mouse Properties in Windows to customize settings for pointing devices, such as button configuration, click speed, and pointer options.

To access Mouse Properties:

Windows 7—Select **Start > Devices and Printers**. Then right-click the device representing your computer, and select **Mouse settings**.

Windows Vista—Select **Start > Control Panel > Hardware and Sound > Mouse**.

Using the pointing stick

Press the pointing stick in the direction you want to move the pointer on the screen. Use the left and right pointing stick buttons as you would the left and right buttons on an external mouse.

Using the TouchPad

To move the pointer, slide one finger across the TouchPad in the direction you want the pointer to go. Use the left and right TouchPad buttons like the buttons on an external mouse. To scroll up and down using the TouchPad vertical scroll zone, slide your finger up or down over the lines.

 **NOTE:** If you are using the TouchPad to move the pointer, you must lift your finger off the TouchPad before moving it to the scroll zone. Simply sliding your finger from the TouchPad to the scroll zone does not activate the scrolling function.

Turning the TouchPad off and on

To turn the TouchPad off and on, quickly double-tap the TouchPad on/off light.

 **NOTE:** The TouchPad on/off light is off when the TouchPad is on.

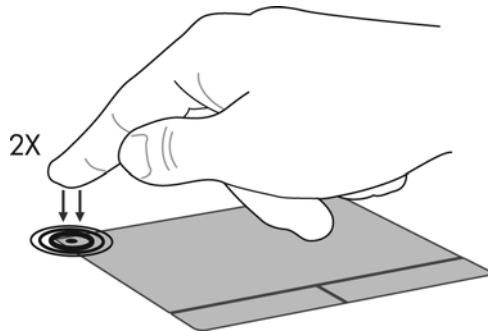

Navigating

To move the pointer, slide one finger across the TouchPad in the direction you want the pointer to go.

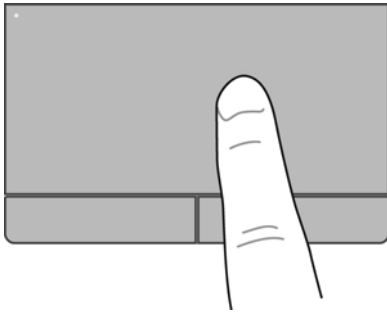

Selecting

Use the left and right TouchPad buttons like the corresponding buttons on an external mouse.

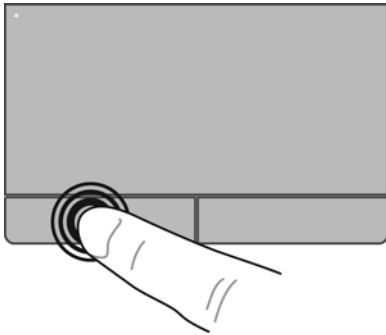

Using TouchPad gestures

The TouchPad supports a variety of gestures. To use TouchPad gestures, place two fingers on the TouchPad at the same time.

 **NOTE:** TouchPad gestures are not supported in all programs.

To view the demonstration of a gesture:

1. Right-click the **Synaptics** icon  in the notification area, at the far right of the taskbar, and then click **TouchPad Properties**.
2. Click a gesture to activate the demonstration.

To turn the gestures on and off:

1. Right-click the **Synaptics** icon  in the notification area, at the far right of the taskbar, and then click **TouchPad Properties**.
2. Select the gesture that you want to turn on or off.
3. Click **Apply**, and then click **OK**.

Scrolling

Scrolling is useful for moving up, down, or sideways on a page or image. To scroll, place two fingers slightly apart on the TouchPad, and then drag them across the TouchPad in an up, down, left, or right motion.

 **NOTE:** Scrolling speed is controlled by finger speed.

NOTE: Two-finger scrolling is enabled at the factory.

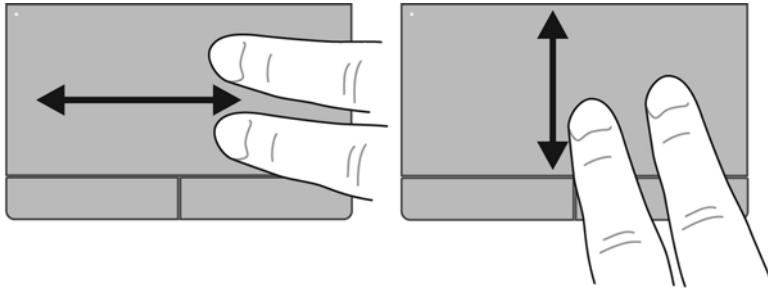

Pinching/Zooming

Pinching allows you to zoom in or out on images or text.

- Zoom in by placing two fingers together on the TouchPad, and then moving them apart.
- Zoom out by placing two fingers apart on the TouchPad, and then moving them together.

 **NOTE:** Pinching/zooming is enabled at the factory.

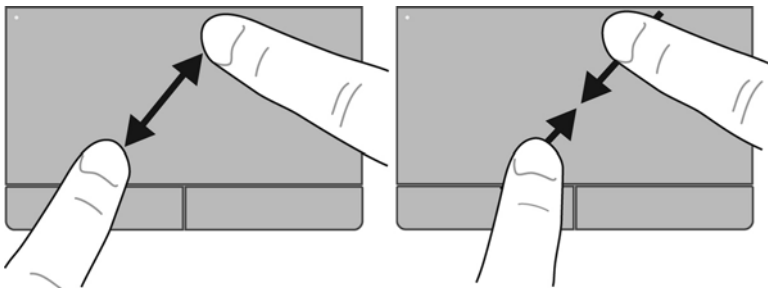

Rotating

Rotating allows you to rotate items such as photos. To rotate, anchor your left forefinger in the TouchPad zone. Move the right forefinger around the anchored finger in a sweeping motion, moving from 12 o'clock to 3 o'clock. To reverse the rotation, move your right forefinger from 3 o'clock to 12 o'clock.

 **NOTE:** Rotating must be done within the TouchPad zone.

NOTE: Rotating is disabled at the factory.

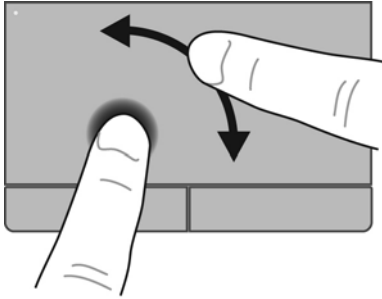

6 Maintenance

- [Inserting or removing the battery](#)
- [Removing or replacing the bottom cover](#)
- [Replacing or upgrading the hard drive](#)
- [Replacing a drive in the upgrade bay](#)
- [Adding or replacing memory modules](#)
- [Updating programs and drivers](#)
- [Using SoftPaq Download Manager](#)
- [Cleaning your computer](#)

Inserting or removing the battery

 **NOTE:** For additional information on using the battery, refer to the *HP Notebook Reference Guide*.

To insert the battery:

1. Turn the computer upside down on a flat surface, with the battery bay toward you.
2. Insert the battery **(1)** into the battery bay until it is seated.

The battery release latch **(2)** automatically locks the battery into place.

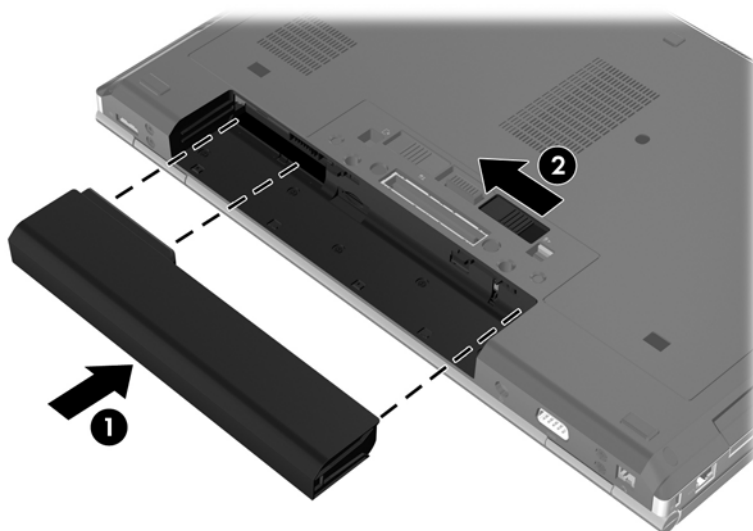

To remove the battery:

△ **CAUTION:** Removing a battery that is the sole power source for the computer can cause loss of information. To prevent loss of information, save your work and initiate Hibernation or shut down the computer through Windows before removing the battery.

1. Turn the computer upside down on a flat surface, with the battery bay toward you.
2. Slide the battery release latch **(1)** to release the battery.
3. Remove the battery from the computer **(2)**.

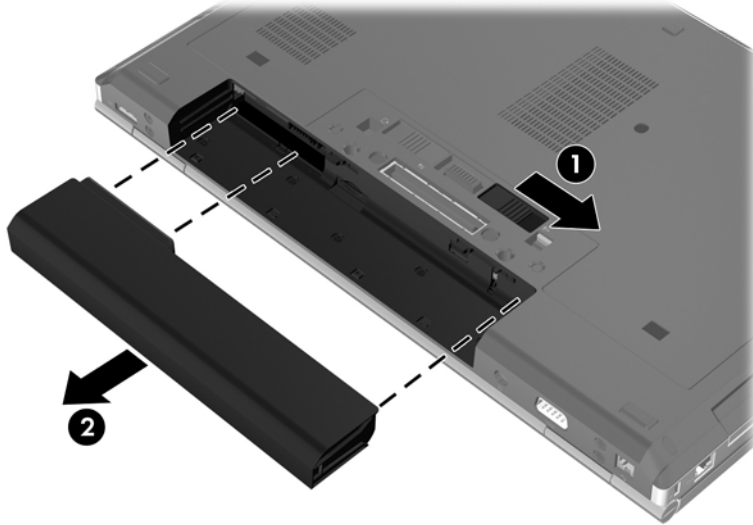

Removing or replacing the bottom cover

△ **CAUTION:** To prevent information loss or an unresponsive system:

Save your work and shut down the computer before adding or replacing a memory module or hard drive.

If you are not sure whether the computer is off or in Hibernation, turn the computer on by pressing the power button. Then shut down the computer through the operating system.

Removing the bottom cover

Remove the bottom cover to access the memory module slot, hard drive, regulatory label, and other components.

To remove the bottom cover:

1. Remove the battery (see [Inserting or removing the battery on page 36](#)).
2. With the battery bay toward you, slide the bottom cover release latch **(1)** to the left, remove the screw (if the optional screw is being used) **(2)**, and then slide the release latch again **(3)** to release the bottom cover.

 **NOTE:** If you want to use the optional screw, it is stored inside the bottom cover.

3. Slide the bottom cover towards the front of the computer **(4)** and lift **(5)** to remove the cover.

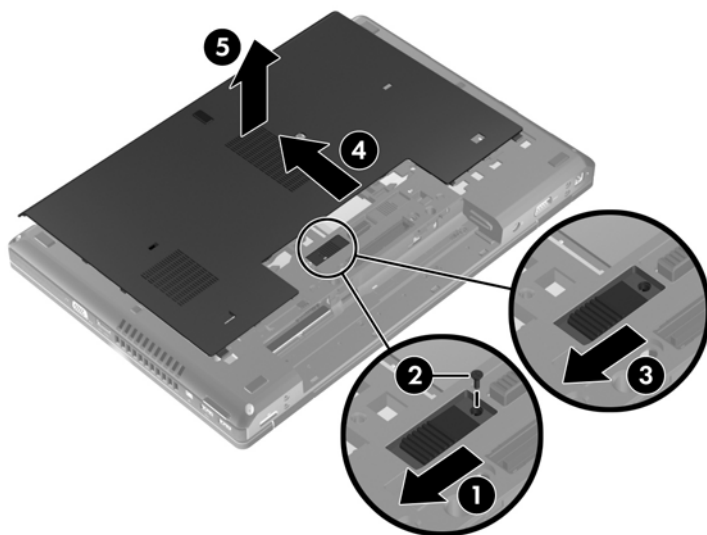

Replacing the bottom cover

Replace the bottom cover after accessing the memory module slot, hard drive, regulatory label, and other components.

To replace the bottom cover:

1. Tilt down the bottom cover to align the front edge of the bottom cover near the front edge of the computer **(1)**.
2. Insert the alignment tabs **(2)** on the rear edge of the bottom cover with the notches on the computer.

3. Slide the bottom cover towards the battery bay until the bottom cover snaps into place.
4. With the battery bay toward you, slide the bottom cover release latch to the left **(3)**, and if you choose to, insert and tighten the optional screw **(4)** to hold the bottom cover in place. Slide the release latch to the right to lock the bottom cover **(5)**.

 **NOTE:** If you want to use the optional screw, it is stored inside the bottom cover.

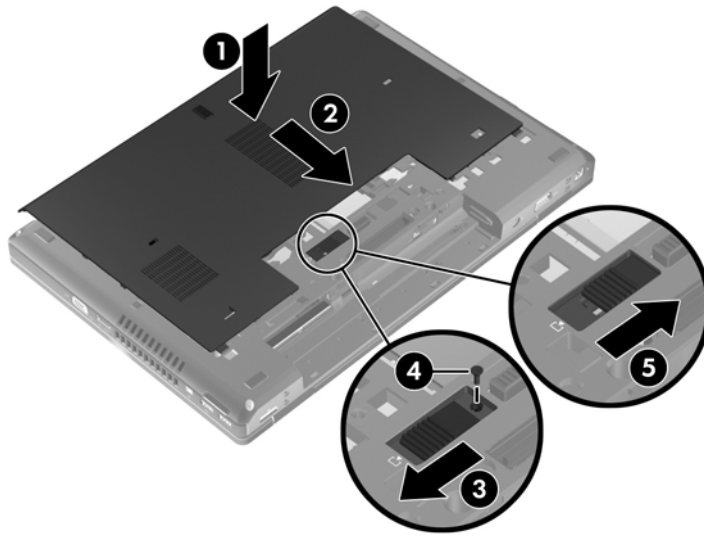

5. Insert the battery (see [Inserting or removing the battery on page 36](#)).

Replacing or upgrading the hard drive

△ **CAUTION:** To prevent information loss or an unresponsive system:

Shut down the computer before removing the hard drive from the hard drive bay. Do not remove the hard drive while the computer is on, in the Sleep state, or in Hibernation.

If you are not sure whether the computer is off or in Hibernation, turn the computer on by pressing the power button. Then shut down the computer through the operating system.

Removing the hard drive

To remove the hard drive:

1. Save your work and shut down the computer.
2. Disconnect AC power and external devices connected to the computer.
3. Remove the battery (see [Inserting or removing the battery on page 36](#)).
4. Remove the bottom cover (see [Removing the bottom cover on page 38](#)).
5. Loosen the 3 hard drive screws (1).
6. Pull the plastic tab on the hard drive (2) towards the side of the computer to disengage the hard drive from the connector.
7. Use the plastic tab to lift the connector side of the hard drive up at an angle (3) and remove the drive (4) from the computer.

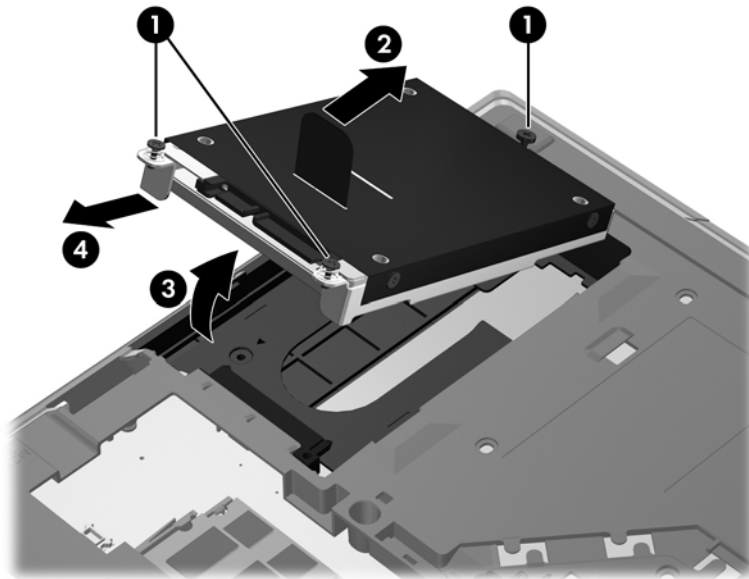

Installing a hard drive

To install the hard drive:

1. Insert the hard drive into the hard drive bay at an angle (1), and then lay the hard drive flat in the hard drive bay (2).
2. Pull the plastic tab (3) towards the center of the computer to engage the hard drive with the connector.
3. Tighten the hard drive screws (4).

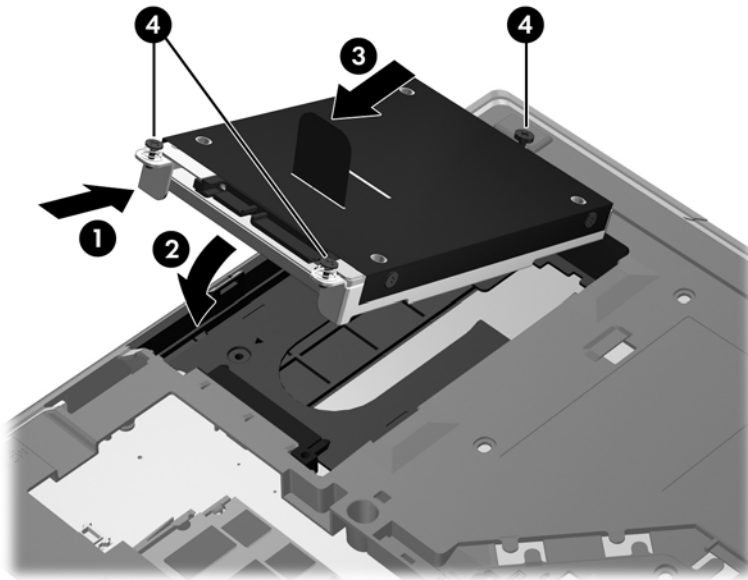

4. Replace the bottom cover (see [Replacing the bottom cover on page 38](#)).
5. Insert the battery (see [Inserting or removing the battery on page 36](#)).
6. Connect AC power and external devices to the computer.
7. Turn on the computer.

Replacing a drive in the upgrade bay

The upgrade bay can hold either a hard drive or an optical drive.

Replacing a hard drive

△ **CAUTION:** To prevent information loss or an unresponsive system:

Shut down the computer before removing the hard drive from the upgrade bay. Do not remove the hard drive while the computer is on, in the Sleep state, or in Hibernation.

If you are not sure whether the computer is off or in Hibernation, turn the computer on by pressing the power button. Then shut down the computer through the operating system.

To remove a hard drive from the upgrade bay:

1. Save your work.
2. Shut down the computer and close the display.
3. Disconnect all external hardware devices connected to the computer.
4. Unplug the power cord from the AC outlet.
5. Turn the computer upside down on a flat surface, with the upgrade bay toward you.
6. Remove the battery (see [Inserting or removing the battery on page 36](#)).
7. Remove the bottom cover (see [Removing the bottom cover on page 38](#)).
8. Remove the hard drive screws from the upgrade bay.

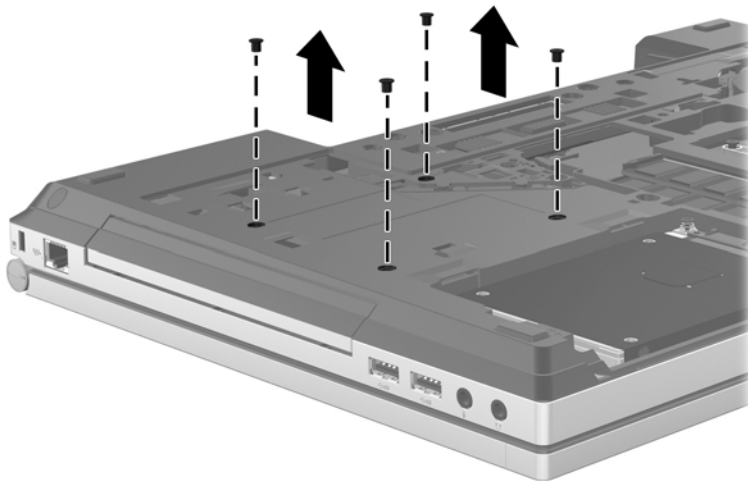

9. Loosen the upgrade bay screw (1).
10. Using a flat-bladed screwdriver, gently push the tab to release the hard drive (2).
11. Remove the hard drive from the upgrade bay (3).

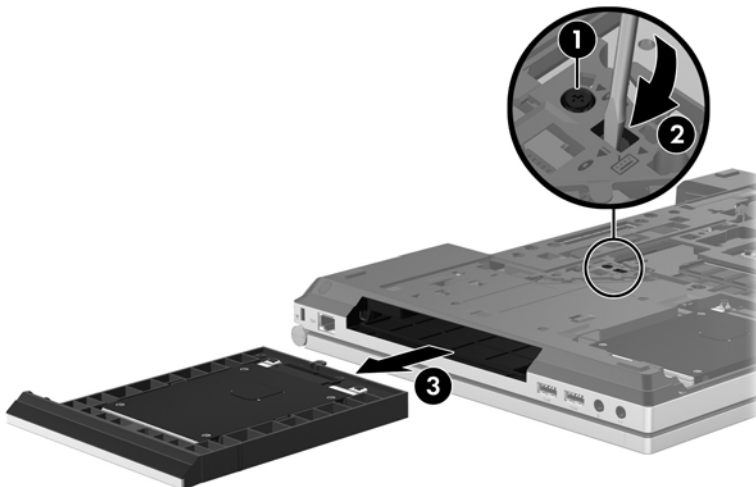

To install a hard drive in the upgrade bay:

1. Insert the hard drive (1) into the upgrade bay, and then tighten the upgrade bay screw (2).

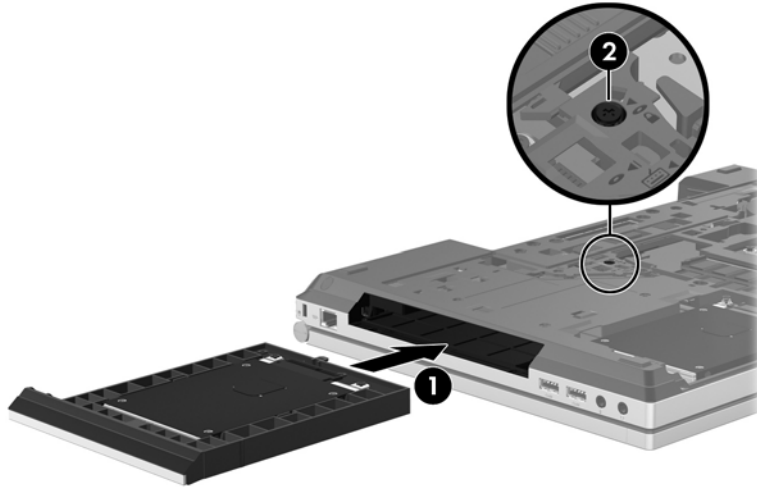

2. Replace the hard drive screws.

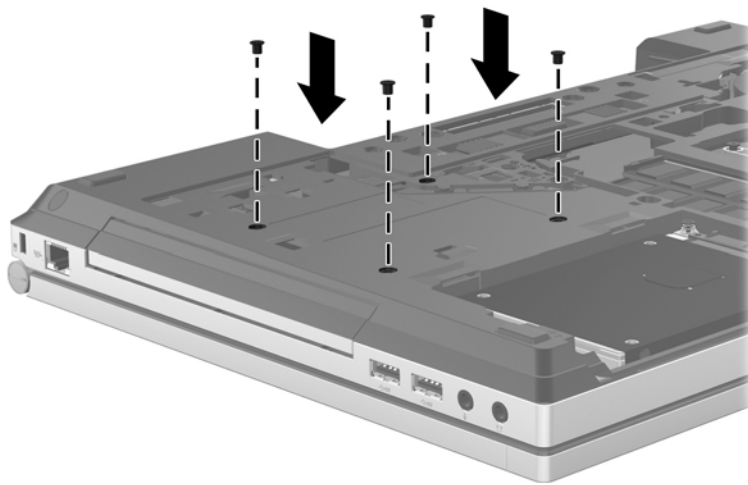

3. Replace the bottom cover (see [Replacing the bottom cover on page 38](#)).
4. Insert the battery (see [Inserting or removing the battery on page 36](#)).
5. Turn the computer right-side up, and then reconnect AC power and external devices to the computer.
6. Turn on the computer.

Replacing an optical drive

△ **CAUTION:** To prevent information loss or an unresponsive system:

Shut down the computer before removing the optical drive from the upgrade bay. Do not remove the optical drive while the computer is on, in the Sleep state, or in Hibernation.

If you are not sure whether the computer is off or in Hibernation, turn the computer on by pressing the power button. Then shut down the computer through the operating system.

To remove an optical drive from the upgrade bay:

1. Save your work.
2. Shut down the computer and close the display.
3. Disconnect all external hardware devices connected to the computer.
4. Unplug the power cord from the AC outlet.
5. Turn the computer upside down on a flat surface, with the upgrade bay toward you.
6. Remove the battery (see [Inserting or removing the battery on page 36](#)).
7. Remove the bottom cover (see [Removing the bottom cover on page 38](#)).
8. Loosen the upgrade bay screw **(1)**.
9. Using a flat-bladed screwdriver, gently push the tab to release the optical drive **(2)**.
10. Remove the optical drive from the upgrade bay **(3)**.

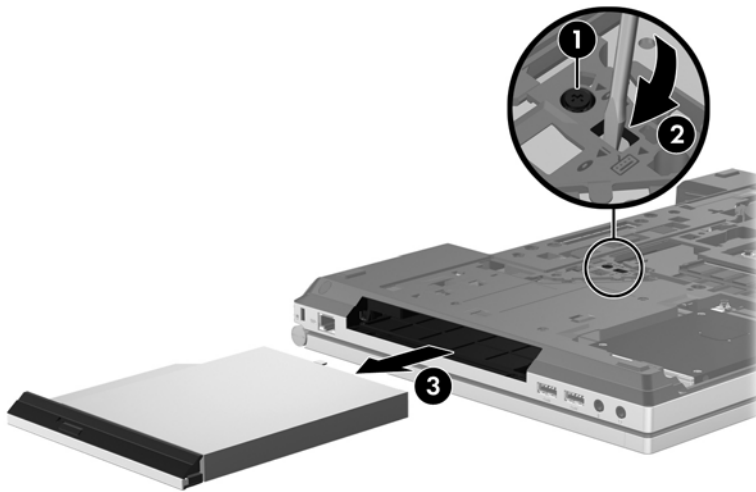

To install an optical drive in the upgrade bay:

1. Insert the optical drive into the upgrade bay **(1)**.

2. Tighten the upgrade bay screw (2).

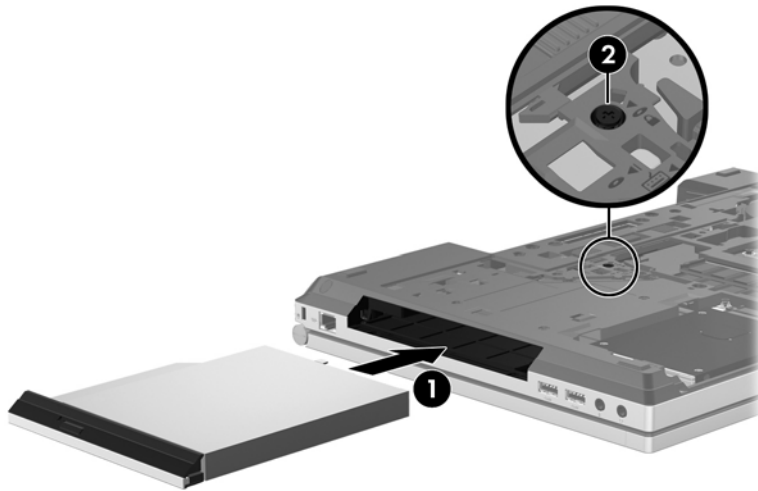

3. Replace the bottom cover (see [Replacing the bottom cover on page 38](#)).
4. Insert the battery (see [Inserting or removing the battery on page 36](#)).
5. Turn the computer right-side up, and then reconnect AC power and external devices to the computer.
6. Turn on the computer.

Adding or replacing memory modules

The computer has one memory module compartment. The capacity of the computer can be upgraded by adding a memory module to the vacant expansion memory module slot or by upgrading the existing memory module in the primary memory module slot.

- ⚠ **WARNING!** To reduce the risk of electric shock and damage to the equipment, unplug the power cord and remove all batteries before installing a memory module.
- ⚠ **CAUTION:** Electrostatic discharge (ESD) can damage electronic components. Before beginning any procedure, ensure that you are discharged of static electricity by touching a grounded metal object.

CAUTION: To prevent information loss or an unresponsive system:

Shut down the computer before adding or replacing memory modules. Do not remove a memory module while the computer is on, in the Sleep state, or in Hibernation.

If you are not sure whether the computer is off or in Hibernation, turn the computer on by pressing the power button. Then shut down the computer through the operating system.

- 📝 **NOTE:** To use a dual-channel configuration when adding a second memory module, be sure that both memory modules are identical.

NOTE: The primary memory is located in the bottom memory slot and the expansion memory is located in the top memory slot.

To add or replace a memory module:

1. Save your work and shut down the computer.
2. Disconnect AC power and external devices connected to the computer.
3. Remove the battery (see [Inserting or removing the battery on page 36](#)).
4. Remove the bottom cover (see [Removing the bottom cover on page 38](#)).
5. If you are replacing a memory module, remove the existing memory module:
 - a. Pull away the retention clips **(1)** on each side of the memory module.
The memory module tilts up.
 - b. Grasp the edge of the memory module **(2)**, and then gently pull the memory module out of the memory module slot.

△ **CAUTION:** To prevent damage to the memory module, hold the memory module by the edges only. Do not touch the components on the memory module.

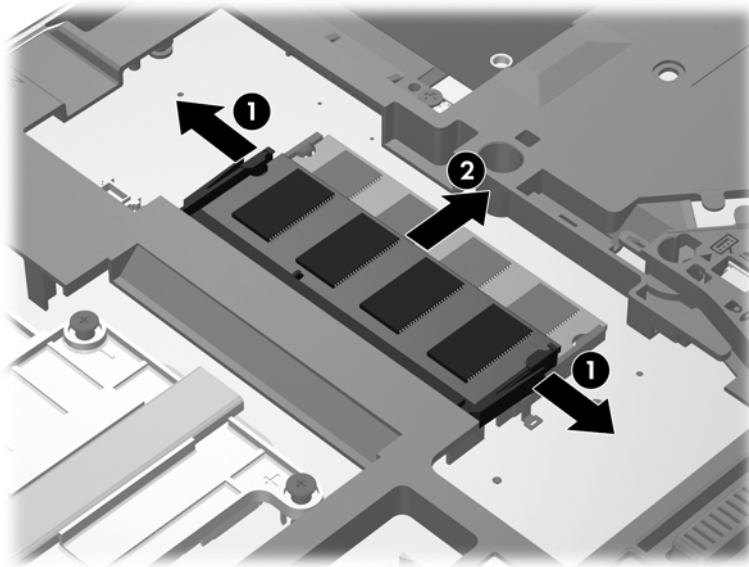

To protect a memory module after removal, place it in an electrostatic-safe container.

6. Insert a new memory module:

△ **CAUTION:** To prevent damage to the memory module, hold the memory module by the edges only. Do not touch the components on the memory module.

- a. Align the notched edge **(1)** of the memory module with the tab in the memory module slot.
- b. With the memory module at a 45-degree angle from the surface of the memory module compartment, press the module **(2)** into the memory module slot until it is seated.

- c. Gently press the memory module **(3)** down, applying pressure to both the left and right edges of the memory module, until the retention clips snap into place.

△ **CAUTION:** To prevent damage to the memory module, be sure that you do not bend the memory module.

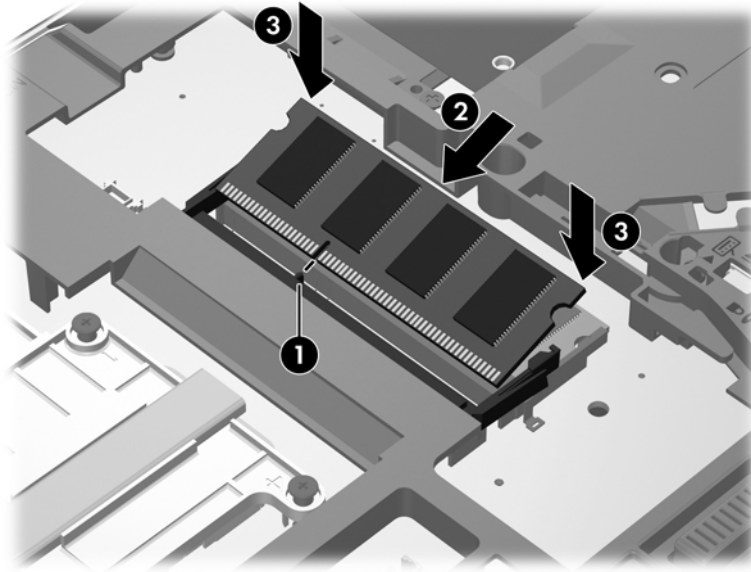

7. Replace the bottom cover (see [Replacing the bottom cover on page 38](#)).
8. Insert the battery (see [Inserting or removing the battery on page 36](#)).
9. Connect AC power and external devices to the computer.
10. Turn on the computer.

Updating programs and drivers

HP recommends that you update your programs and drivers on a regular basis with the latest versions. Go to <http://www.hp.com/support> to download the latest versions. You can also register to receive automatic update notifications when they become available.

Using SoftPaq Download Manager

HP SoftPaq Download Manager (SDM) is a tool that provides quick access to SoftPaq information for HP business computers without requiring the SoftPaq number. Using this tool, you can easily search for SoftPaqs and then download and unpack them.

SoftPaq Download Manager works by reading and downloading, from the HP FTP site, a published database file containing computer model and SoftPaq information. SoftPaq Download Manager allows you to specify one or more computer models to determine which SoftPaqs are available for download.

SoftPaq Download Manager checks the HP FTP site for updates to the database and software. If updates are found, they are downloaded and applied automatically.

SoftPaq Download Manager is available on the HP Web site. To use SoftPaq Download Manager to download SoftPaqs, you must first download and install the program. Go to the HP Web site at <http://www.hp.com/go/sdm>, and follow the instructions to download and install SoftPaq Download Manager.

To download SoftPaqs:

1. Select **Start > All Programs > HP > HP SoftPaq Download Manager**.
2. When the SoftPaq Download Manager opens for the first time, a window is displayed asking if you want to show only software for the computer you are using or to show the software for all supported models. Select **Show software for all supported models**. If you have used HP SoftPaq Download Manager previously, go to Step 3.
 - a. Select your operating system and language filters in the Configuration Options window. The filters limit the number of options that are listed in the Product Catalog pane. For example, if only Windows 7 Professional is selected in the operating system filter, the only operating system that is displayed in the Product Catalog is Windows 7 Professional.
 - b. To add other operating systems, change the filter settings in the Configuration Options window. Refer to the HP SoftPaq Download Manager software Help for more information.
3. In the left pane, click the plus sign (+) to expand the model list, and then select the model or models of the products you want to update.
4. Click **Find Available SoftPaqs** to download a list of available SoftPaqs for the selected computer.
5. Select from the list of available SoftPaqs, and then click **Download Only** if you have many SoftPaqs to download, because the SoftPaq selection and Internet connection speed determine how long the download process will take.

If you want to download only one or two SoftPaqs and have a high-speed Internet connection, click **Download & Unpack**.

6. Right-click **Install SoftPaq** in the SoftPaq Download Manager software to install the selected SoftPaqs on the computer.

Cleaning your computer

- [Cleaning products](#)
- [Cleaning procedures](#)

Cleaning products

Use the following products to safely clean and disinfect your notebook or tablet PC:

- Dimethyl benzyl ammonium chloride 0.3 percent maximum concentration (For example: germicidal disposable wipes. These wipes come in a variety of brand names.)
- Alcohol-free glass cleaning fluid
- Water with mild soap solution
- Dry microfiber cleaning cloth or a chamois (static-free cloth without oil)
- Static-free cloth wipes

△ **CAUTION:** Avoid the following cleaning products:

Strong solvents, such as alcohol, acetone, ammonium chloride, methylene chloride, and hydrocarbons, which can permanently damage the surface of the notebook or the tablet PC.

Fibrous materials, such as paper towels, which can scratch the notebook or tablet PC. Over time, dirt particles and cleaning agents can get trapped in the scratches.

Cleaning procedures

Follow the procedures in this section to safely clean your notebook or tablet PC.

△ **WARNING!** To prevent electric shock or damage to components, do not attempt to clean your notebook or tablet PC while it is turned on:

Turn off the notebook or tablet PC.

Disconnect external power.

Disconnect all powered external devices.

△ **CAUTION:** Do not spray cleaning agents or liquids directly on any notebook or tablet PC surface. Liquids dripped on the surface can permanently damage internal components.

Cleaning the display

Gently wipe the display using a soft, lint-free cloth moistened with an *alcohol-free* glass cleaner. Be sure that the display is dry before closing the display.

Cleaning the sides and cover

To clean and disinfect the sides and cover, use a soft microfiber cloth or chamois moistened with one of the cleaning solutions listed previously or use an acceptable germicidal disposable wipe.

 **NOTE:** When cleaning the cover of the notebook, use a circular motion to aid in removing dirt and debris.

Cleaning the TouchPad and keyboard

 **CAUTION:** When cleaning the TouchPad and keyboard, do not let liquids drip between the keys. This can permanently damage internal components.

- To clean and disinfect the TouchPad and keyboard, use a soft microfiber cloth or chamois moistened with one of the cleaning solutions listed previously or use an acceptable germicidal disposable wipe.
- To prevent keys from sticking and to remove dust, lint, and particles from the keyboard, use a can of compressed air with a straw extension.

 **WARNING!** To reduce the risk of electric shock or damage to internal components, do not use a vacuum cleaner attachment to clean the keyboard. A vacuum cleaner can deposit household debris on the keyboard surface.

7 Backup and recovery

Windows 7

- [Backing up your information](#)
- [Performing a system recovery](#)

To protect your information, use Windows Backup and Restore to back up individual files and folders, back up your entire hard drive (select models only), create system repair discs (select models only) by using the installed optical drive (select models only) or an optional external optical drive, or create system restore points. In case of system failure, you can use the backup files to restore the contents of your computer.

Windows Backup and Restore provides the following options:

- Creating a system repair disc (select models only) by using the installed optical drive (select models only) or an optional external optical drive
- Backing up your information
- Creating a system image (select models only)
- Scheduling automatic backups (select models only)
- Creating system restore points
- Recovering individual files
- Restoring the computer to a previous state
- Recovering information using recovery tools

 **NOTE:** For detailed instructions, perform a search for these topics in Help and Support.

In case of system instability, HP recommends that you print the recovery procedures and save them for later use.

NOTE: Windows includes the User Account Control feature to improve the security of your computer. You may be prompted for your permission or password for tasks such as installing software, running utilities, or changing Windows settings. Refer to Help and Support for more information.

Backing up your information

Recovery after a system failure is as good as your most recent backup. You should create system repair discs (select models only) by using the installed optical drive (select models only) or an optional external optical drive, and your initial backup immediately after software setup. As you add new software and data files, you should continue to back up your system on a regular basis to maintain a reasonably

current backup. The system repair discs (select models only) are used to start up (boot) the computer and repair the operating system in case of system instability or failure. Your initial and subsequent backups allow you to restore your data and settings if a failure occurs.

You can back up your information to an optional external hard drive, a network drive, or discs.

Note the following when backing up:

- Store personal files in the Documents library, and back it up regularly.
 - Back up templates that are stored in their associated programs.
 - Save customized settings that appear in a window, toolbar, or menu bar by taking a screen shot of your settings. The screen shot can be a time-saver if you have to reset your preferences.
 - When backing up to discs, use any of the following types of discs (purchased separately): CD-R, CD-RW, DVD+R, DVD+R DL, DVD-R, DVD-R DL, or DVD±RW. The discs you use will depend on the type of optical drive installed in your computer or the type of external optical drive you are using.
-
-  **NOTE:** DVDs and DVDs with double-layer (DL) support store more information than CDs, so using them for backup reduces the number of recovery discs required.
-
- When backing up to discs, number each disc before inserting it into the optical drive of the computer.

To create a backup using Backup and Restore:

 **NOTE:** Be sure that the computer is connected to AC power before you start the backup process.

NOTE: The backup process may take over an hour, depending on file size and the speed of the computer.

1. Select **Start > All Programs > Maintenance > Backup and Restore**.
2. Follow the on-screen instructions to set up your backup, create a system image (select models only), or create a system repair disc (select models only).

Performing a system recovery

In case of system failure or instability, the computer provides the following tools to recover your files:

- Windows recovery tools: You can use Windows Backup and Restore to recover information you have previously backed up. You can also use Windows Startup Repair to fix problems that might prevent Windows from starting correctly.
- **f11** recovery tools: You can use the **f11** recovery tools to recover your original hard drive image. The image includes the Windows operating system and software programs installed at the factory.

 **NOTE:** If you are unable to boot (start up) your computer and you cannot use the system repair discs you previously created (select models only), you must purchase a Windows 7 operating system DVD to reboot the computer and repair the operating system. For additional information, refer to [Using a Windows 7 operating system DVD \(purchased separately\) on page 54](#).

Using the Windows recovery tools

To recover information you previously backed up:

1. Select **Start > All Programs > Maintenance > Backup and Restore**.
2. Follow the on-screen instructions to recover your system settings, your computer (select models only), or your files.

To recover your information using Startup Repair, follow these steps:

△ **CAUTION:** Using Startup Repair completely erases hard drive contents and reformats the hard drive. All files you have created and any software installed on the computer are permanently removed. When reformatting is complete, the recovery process restores the operating system, as well as the drivers, software, and utilities from the backup used for recovery.

1. If possible, back up all personal files.
2. If possible, check for the presence of the Windows partition and the HP Recovery partition.

To check for the Windows partition, select **Start > Computer**.

To check for the HP Recovery partition, click **Start**, right-click **Computer**, click **Manage**, and then click **Disk Management**.

🔗 **NOTE:** If the Windows partition and the HP Recovery partition are not listed, you must recover your operating system and programs using the Windows 7 operating system DVD and the *Driver Recovery* disc (both purchased separately). For additional information, refer to [Using a Windows 7 operating system DVD \(purchased separately\) on page 54](#).

3. If the Windows partition and the HP Recovery partition are listed, restart the computer, and then press **f8** before the Windows operating system loads.
4. Select **Startup Repair**.
5. Follow the on-screen instructions.

🔗 **NOTE:** For additional information on recovering information using the Windows tools, perform a search for these topics in Help and Support.

Using f11 recovery tools

△ **CAUTION:** Using **f11** completely erases hard drive contents and reformats the hard drive. All files you have created and any software installed on the computer are permanently removed. The **f11** recovery tool reinstalls the operating system and HP programs and drivers that were installed at the factory. Software not installed at the factory must be reinstalled.

To recover the original hard drive image using **f11**:

1. If possible, back up all personal files.
2. If possible, check for the presence of the HP Recovery partition: click **Start**, right-click **Computer**, click **Manage**, and then click **Disk Management**.

🔗 **NOTE:** If the HP Recovery partition is not listed, you must recover your operating system and programs using the Windows 7 operating system DVD and the *Driver Recovery* disc (both purchased separately). For additional information, refer to [Using a Windows 7 operating system DVD \(purchased separately\) on page 54](#).

3. If the HP Recovery partition is listed, restart the computer, and then press **esc** while the “Press the ESC key for Startup Menu” message is displayed at the bottom of the screen.
4. Press **f11** while the “Press <F11> for recovery” message is displayed on the screen.
5. Follow the on-screen instructions.

Using a Windows 7 operating system DVD (purchased separately)

To order a Windows 7 operating system DVD, go to <http://www.hp.com/support>, select your country or region, and follow the on-screen instructions. You can also order the DVD by calling technical support. For contact information, refer to the *Worldwide Telephone Numbers* booklet included with the computer.

△ **CAUTION:** Using a Windows 7 operating system DVD completely erases hard drive contents and reformats the hard drive. All files you have created and any software installed on the computer are permanently removed. When reformatting is complete, the recovery process helps you restore the operating system, as well as drivers, software, and utilities.

To initiate recovery using a Windows 7 operating system DVD:

📝 **NOTE:** This process takes several minutes.

1. If possible, back up all personal files.
2. Restart the computer, and then insert the Windows 7 operating system DVD into the optical drive before the Windows operating system loads.
3. When prompted, press any keyboard key.
4. Follow the on-screen instructions.
5. Click **Next**.
6. Select **Repair your computer**.
7. Follow the on-screen instructions.

Windows Vista

To protect your information, use the Backup and Restore Center to back up individual files and folders, back up your entire hard drive (select models only), or create system restore points. In case of system failure, you can use the backup files to restore the contents of your computer.

The Backup and Restore Center provides the following options:

- Backing up individual files and folders
- Backing up the entire hard drive (select models only)
- Scheduling automatic backups (select models only)
- Creating system restore points
- Recovering individual files
- Restoring the computer to a previous state
- Recovering information using recovery tools

 **NOTE:** For detailed instructions, perform a search for these topics in Help and Support.

NOTE: In case of system instability, HP recommends that you print the recovery procedures and save them for later use.

NOTE: Windows® includes the User Account Control feature to improve the security of your computer. You may be prompted for your permission or password for tasks such as installing software, running utilities, or changing Windows settings. Refer to Help and Support for more information.

Backing up your information

Recovery after a system failure is as complete as your most current backup. You should create your initial backup immediately after software setup. As you add new software and data files, you should continue to back up your system on a regular basis to maintain a reasonably current backup.

You can back up your information to an optional external hard drive, a network drive, or discs.

Note the following when backing up:

- Store personal files in the Documents folder, and back it up regularly.
- Back up templates that are stored in their associated programs.
- Save customized settings that appear in a window, toolbar, or menu bar by taking a screen shot of your settings. The screen shot can be a time-saver if you have to reset your preferences.
- When backing up to discs, use any of the following types of discs (purchased separately): CD-R, CD-RW, DVD+R, DVD+R DL, DVD-R, DVD-R DL, or DVD±RW. The discs you use will depend on the type of optical drive installed in your computer.

 **NOTE:** DVDs and DVDs with double-layer (DL) support store more information than CDs, so using them for backup reduces the number of recovery discs required.

- When backing up to discs, number each disc before inserting it into the optical drive of the computer.

To create a backup using Backup and Restore Center:

 **NOTE:** Be sure that the computer is connected to AC power before you start the backup process.

NOTE: The backup process may take over an hour, depending on file size and the speed of the computer.

1. Select **Start > All Programs > Maintenance > Backup and Restore Center**.
2. Follow the on-screen instructions to back up your entire computer (select models only) or your files.

Performing a recovery

In case of system failure or instability, the computer provides the following tools to recover your files:

- Windows recovery tools: You can use the Backup and Restore Center to recover information you have previously backed up. You can also use Windows Startup Repair to fix problems that might prevent Windows from starting correctly.
- f11 recovery tools: You can use the f11 recovery tools to recover your original hard drive image. The image includes the Windows operating system and software programs installed at the factory.

 **NOTE:** If you are unable to boot (start up) your computer, you must purchase a Windows Vista® operating system DVD to reboot the computer and repair the operating system. For additional information, refer to [Using a Windows Vista operating system DVD \(purchased separately\) on page 58](#).

Using the Windows recovery tools

To recover information you previously backed up:

1. Select **Start > All Programs > Maintenance > Backup and Restore Center**.
2. Follow the on-screen instructions to recover your entire computer (select models only) or your files.

To recover your information using Startup Repair, follow these steps:

 **CAUTION:** Using Startup Repair completely erases hard drive contents and reformats the hard drive. All files you have created and any software installed on the computer are permanently removed. When reformatting is complete, the recovery process restores the operating system, as well as the drivers, software, and utilities from the backup used for recovery.

1. If possible, back up all personal files.
2. If possible, check for the presence of the Windows partition and the HP Recovery partition. To find the partitions, select **Start > Computer**.

 **NOTE:** If the Windows partition and the HP Recovery partition have been deleted, you must recover your operating system and programs using the Windows Vista operating system DVD and the *Driver Recovery* disc (both purchased separately). For additional information, refer to [Using a Windows Vista operating system DVD \(purchased separately\) on page 58](#).

3. Restart the computer, and then press **f8** before the Windows operating system loads.
4. Select **Repair your computer**.
5. Follow the on-screen instructions.

 **NOTE:** For additional information on recovering information using the Windows tools, perform a search for these topics in Help and Support.

Using f11 recovery tools

△ **CAUTION:** Using **f11** completely erases hard drive contents and reformats the hard drive. All files you have created and any software installed on the computer are permanently removed. The **f11** recovery tool reinstalls the operating system and HP programs and drivers that were installed at the factory. Software not installed at the factory must be reinstalled. Personal files must be restored from a backup.

🔧 **NOTE:** If your computer includes a solid-state drive (SSD), you may not have a recovery partition. Recovery discs have been included for computers that do not have a partition. Use these discs to recover your operating system and software. To check for the presence of a recovery partition, select **Start > Computer**. If the partition is present, an HP Recovery drive is listed in the Hard Disk Drives section of the window.

To recover the original hard drive image using **f11**, follow these steps:

1. If possible, back up all personal files.
2. If possible, check for the presence of the HP Recovery partition. To find the partition, select **Start > Computer**.

🔧 **NOTE:** If the HP Recovery partition has been deleted, you must recover your operating system and programs using the Windows Vista operating system DVD and the *Driver Recovery* disc (both purchased separately). For additional information, refer to [Using a Windows Vista operating system DVD \(purchased separately\) on page 58](#).

3. Turn on or restart the computer, and then press **esc** while the “Press the ESC key for Startup Menu” message is displayed at the bottom of the screen.
4. Press **f11** while the “Press <F11> for recovery” message is displayed on the screen.
5. Follow the on-screen instructions.

Using a Windows Vista operating system DVD (purchased separately)

To order a Windows Vista operating system DVD, go to <http://www.hp.com/support>, select your country or region, and follow the on-screen instructions. You can also order the DVD by calling technical support. For contact information, refer to the *Worldwide Telephone Numbers* booklet included with the computer.

△ **CAUTION:** Using a Windows Vista operating system DVD completely erases hard drive contents and reformats the hard drive. All files you have created and any software installed on the computer are permanently removed. When reformatting is complete, the recovery process helps you restore the operating system, as well as drivers, software, and utilities.

To initiate recovery using a Windows Vista operating system DVD:

✎ **NOTE:** This process takes several minutes.

1. If possible, back up all personal files.
2. Restart the computer, and then insert the Windows Vista operating system DVD into the optical drive before the Windows operating system loads.
3. When prompted, press any keyboard key.
4. Follow the on-screen instructions.
5. Click **Next**.
6. Select **Repair your computer**.
7. Follow the on-screen instructions.

8 Customer support

- [Contacting customer support](#)
- [Labels](#)

Contacting customer support

If the information provided in this user guide, in the *HP Notebook Reference Guide*, or in Help and Support does not address your questions, you can contact HP Customer Support at:

<http://www.hp.com/go/contactHP>

 **NOTE:** For worldwide support, click **Contact HP worldwide** on the left side of the page, or go to http://welcome.hp.com/country/us/en/wwcontact_us.html.

Here you can:

- Chat online with an HP technician.

 **NOTE:** When technical support chat is not available in a particular language, it is available in English.

- E-mail HP Customer Support.
- Find HP Customer Support worldwide telephone numbers.
- Locate an HP service center.

Labels

The labels affixed to the computer provide information you may need when you troubleshoot system problems or travel internationally with the computer:

- Serial number label—Provides important information, including the following:

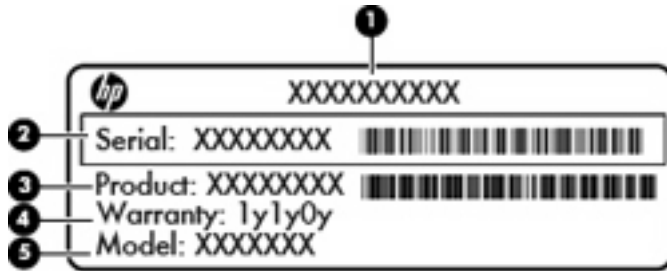

Component	
(1)	Product name
(2)	Serial number (s/n)
(3)	Part number/Product number (p/n)
(4)	Warranty period
(5)	Model description

Have this information available when you contact technical support. The serial number label is affixed to the bottom of the computer.

- Microsoft® Certificate of Authenticity—Contains the Windows Product Key. You may need the Product Key to update or troubleshoot the operating system. The Microsoft Certificate of Authenticity is affixed inside the battery bay.
- Regulatory label—Provides regulatory information about the computer. The regulatory label is located underneath the bottom cover of the computer or inside the battery bay.
- Wireless certification label or labels (select models only)—Provide information about optional wireless devices and the approval markings of some of the countries or regions in which the devices have been approved for use. If your computer model includes one or more wireless devices, one or more certification labels are included with your computer. You may need this information when traveling internationally. Wireless certification labels are located on the bottom cover of the computer or inside the battery bay.
- SIM (subscriber identity module) label (select models only)—Provides the ICCID (Integrated Circuit Card Identifier) of the SIM. This label is located inside the battery bay.
- HP Mobile Broadband Module serial number label (select models only)—Provides the serial number of the HP Mobile Broadband Module. This label is located underneath the bottom cover of the computer or inside the battery bay.

9 Specifications

- [Input power](#)
- [Operating environment](#)

Input power

The power information in this section may be helpful if you plan to travel internationally with the computer.

The computer operates on DC power, which can be supplied by an AC or a DC power source. The AC power source must be rated at 100–240 V, 50–60 Hz. Although the computer can be powered from a standalone DC power source, it should be powered only with an AC adapter or a DC power source supplied and approved by HP for use with this computer.

The computer can operate on DC power within the following specifications.

Input power	Rating
Operating voltage and current	18.5 V dc @ 3.5 A - 65W
	– or –
	19 V dc @ 4.74 A - 90 W

 **NOTE:** This product is designed for IT power systems in Norway with phase-to-phase voltage not exceeding 240 V rms.

NOTE: The computer operating voltage and current can be found on the system regulatory label.

Operating environment

Factor	Metric	U.S.
Temperature		
Operating (writing to optical disc)	5°C to 35°C	41°F to 95°F
Nonoperating	-20°C to 60°C	-4°F to 140°F
Relative humidity (noncondensing)		
Operating	10% to 90%	10% to 90%
Nonoperating	5% to 95%	5% to 95%
Maximum altitude (unpressurized)		
Operating	-15 m to 3,048 m	-50 ft to 10,000 ft
Nonoperating	-15 m to 12,192 m	-50 ft to 40,000 ft

Index

Symbols/Numerics

1394 port, identifying 14, 15

A

accessory battery connector,
identifying 20
ambient light sensor,
identifying 16
ambient light, hotkey 29
audio-in (microphone) jack 13
audio-out (headphone) jack 13

B

Backup and Restore 52
Backup and Restore Center 55
battery bay 20, 61
battery light 11
battery release latch 20
battery, replacing 36
Bluetooth compartment,
identifying 20
Bluetooth label 61
bottom cover release latch,
identifying 20
bottom cover, removing or
replacing 38
buttons
calculator 8
left pointing stick button 5
left TouchPad 5
optical drive eject 13
power 7
QuickWeb 8
right pointing stick button 5
right TouchPad 5
TouchPad 7
TouchPad on/off 5
volume mute 8
wireless 8

C

calculator button, identifying 8
calculator light 6
caps lock light, identifying 6
caring for your computer 49
Certificate of Authenticity label 61
cleaning your computer 49
components
bottom 19
display 16
front 11
left side 14
rear 18
right side 13
top 4
connector, power 18

D

display image, switching 29
display release latch 11
DisplayPort, identifying 18

E

eSATA port, identifying 14, 15
esc key, identifying 9
ExpressCard slot 14, 15
external monitor port 14, 15

F

f11 recovery 53, 57
fingerprint reader, identifying 8
fn key, identifying 10, 28
function keys
identifying 9

H

hard drive
installing 41
removing 40
hard drive light 12

hard drive recovery 53, 57

hotkeys

adjusting volume 29
ambient light 29
battery charge 29
decrease screen
brightness 29
description 28
increase screen brightness 29
Sleep 28
switching screen image 29
using 28
HP QuickWeb 25
HP QuickWeb light 6

I

input power 63
integrated numeric keypad,
identifying 10, 29, 30
integrated webcam light,
identifying 16, 17
internal display switch 16, 17
internal microphones,
identifying 16, 17
Internet connection setup 23
ISP, using 22

J

jacks

audio-in (microphone) 13
audio-out (headphone) 13
network 13
RJ-11 (modem) 18
RJ-45 (network) 13

K

keyboard hotkeys, identifying 28
keypad, external
num lock 31
using 30

keypad, integrated numeric 10
keypads, identifying
 identifying 29
keys
 esc 9
 fn 10
 function 9
 menu 10
 num lk 10
 start 10

L

labels
 Bluetooth 61
 HP Mobile Broadband
 Module 61
 Microsoft Certificate of
 Authenticity 61
 regulatory 61
 serial number 61
 SIM 61
 wireless certification 61
 WLAN 61
latch, battery release 20
light sensor, identifying 16
lights
 battery 11
 calculator 6
 caps lock 6
 hard drive 12
 HP QuickWeb 6
 mute 6
 num lock 6
 power 6, 11
 TouchPad on/off 6
 webcam 16, 17
 wireless 6, 11

M

Media Card Reader,
 identifying 14, 15
memory module
 inserting 46
 removing 46
 replacing 45
memory module compartment,
 identifying 20
menu key, identifying 10
Microsoft Certificate of Authenticity
 label 61

Mobile Broadband Module,
 identifying 20
mouse, external
 setting preferences 31
mute light, identifying 6

N

network jack, identifying 13
num lk key, identifying 10, 30
num lock light 6
num lock, external keypad 31

O

operating environment 64
operating system
 Microsoft Certificate of
 Authenticity label 61
 Product Key 61
optical drive eject button,
 identifying 13
optical drive, identifying 13

P

pinching TouchPad gesture 34
pointing devices, setting
 preferences 31
pointing stick 5
ports
 1394 14, 15
 DisplayPort 18
 eSATA 14, 15
 external monitor 14, 15
 serial 18
 USB 13, 14, 15
power button, identifying 7
power connector, identifying 18
power light 6, 11
Product Key 61
product name and number,
 computer 61

Q

QuickWeb button, identifying 8

R

recovery partition 53, 57
regulatory information
 regulatory label 61
 wireless certification labels 61
restoring the hard drive 53, 57

RJ-11 (modem) jack,
 identifying 18
RJ-45 (network) jack,
 identifying 13
rotating TouchPad gesture 35

S

screen brightness keys 29
screen image, switching 29
scrolling TouchPad gesture 34
security cable slot, identifying 13
serial number 61
serial number, computer 61
serial port, identifying 18
setup of WLAN 23
SIM slot, identifying 20
slots
 ExpressCard 14, 15
 security cable 13
 Smart Card 15
Smart Card slot 15
SoftPaqs, downloading 48
speakers, identifying 12
start key, identifying 10
system repair disc 51
system restore points 51

T

TouchPad
 buttons 5
 using 31
TouchPad gestures
 pinching 34
 rotating 35
 scrolling 34
 zooming 34
TouchPad on/off button 5
TouchPad on/off button,
 identifying 7
TouchPad on/off light 6
TouchPad, identifying 5
traveling with the computer 61

U

upgrade bay
 replacing a hard drive 41
 replacing an optical drive 43
USB port, identifying 14, 15
USB ports, identifying 13, 14

V

vents, identifying 14, 15, 20
volume keys, identifying 29
volume mute button, identifying 8

W

webcam 16, 17
webcam light, identifying 16, 17
webcam, identifying 16, 17
Windows 7 operating system
 DVD 54
Windows Backup and Restore 51
Windows Vista operating system
 DVD 58
wireless antennas, identifying 16,
 17
wireless button, identifying 8
wireless certification label 61
wireless lights 6, 11
wireless network (WLAN),
 equipment needed 23
wireless network, connecting 22
wireless router, configuring 24
wireless set up 23
wireless, identifying 20
WLAN
 connecting 23
 protecting 24
WLAN antennas, identifying 16,
 17
WLAN device 61
WLAN label 61
WWAN antennas, identifying 16,
 17

Z

zooming TouchPad gesture 34