



# HP Pavilion G6 Notebook PC

## Maintenance and Service Guide

### **SUMMARY**

This guide is a troubleshooting reference used for maintaining and servicing the computer. It provides comprehensive information on identifying computer features, components, and spare parts; troubleshooting computer problems; and performing computer disassembly procedures.

© Copyright 2011 Hewlett-Packard  
Development Company, L.P.

ATI and ATI Mobility Radeon are trademarks of Advanced Micro Devices, Inc. Bluetooth is a trademark owned by its proprietor and used by Hewlett-Packard Company under license. Intel, Arrandale, and Core are trademarks of Intel corporation in the U.S. and other countries. Microsoft and Windows are U.S. registered trademarks of Microsoft Corporation. SD Logo is a trademark of its proprietor.

The information contained herein is subject to change without notice. The only warranties for HP products and services are set forth in the express warranty statements accompanying such products and services. Nothing herein should be construed as constituting an additional warranty. HP shall not be liable for technical or editorial errors or omissions contained herein.

First Edition: August 2011

Document Part Number: 665388-001

## Safety warning notice

---

 **WARNING!** To reduce the possibility of heat-related injuries or of overheating the computer, do not place the computer directly on your lap or obstruct the computer air vents. Use the computer only on a hard, flat surface. Do not allow another hard surface, such as an adjoining optional printer, or a soft surface, such as pillows or rugs or clothing, to block airflow. Also, do not allow the AC adapter to contact the skin or a soft surface, such as pillows or rugs or clothing, during operation. The computer and the AC adapter comply with the user-accessible surface temperature limits defined by the International Standard for Safety of Information Technology Equipment (IEC 60950).

---



---

# Table of contents

<b>1 Product description .....</b>	<b>1</b>
<b>2 External component identification .....</b>	<b>8</b>
Top .....	8
TouchPad .....	8
Lights .....	9
Button .....	10
Keys .....	11
Front .....	12
Right side .....	13
Left side .....	14
Display .....	16
Bottom .....	17
<b>3 Illustrated parts catalog .....</b>	<b>18</b>
Serial number location .....	18
Computer major components .....	20
Display assembly components .....	26
Mass storage devices .....	28
Miscellaneous parts .....	30
Sequential part number listing .....	31
<b>4 Removal and replacement procedures .....</b>	<b>36</b>
Preliminary replacement requirements .....	36
Tools required .....	36
Service considerations .....	36
Plastic parts .....	36
Cables and connectors .....	37
Drive handling .....	37
Grounding guidelines .....	38
Electrostatic discharge damage .....	38

Packaging and transporting guidelines .....	39
Workstation guidelines .....	39
Equipment guidelines .....	40
Component replacement procedures .....	41
Serial number .....	41
Computer feet .....	42
Battery .....	43
Service door .....	44
Hard drive .....	45
Optical drive .....	48
WLAN module .....	50
Memory module .....	52
RTC battery .....	53
Keyboard .....	54
Top cover .....	56
Power button board .....	60
Speaker assembly .....	62
TouchPad button board .....	63
USB board .....	64
Security cable lock .....	65
Power connector .....	66
Display assembly .....	67
System board .....	73
Fan/heat sink assembly .....	77
Processor .....	81
<b>5 Specifications .....</b>	<b>84</b>
Computer specifications .....	84
39.6-cm (15.6-in) display specifications .....	85
Hard drive specifications .....	86
DVD±RW and CD-RW SuperMulti Double-Layer Combo Drive specifications .....	87
Blu-ray Disc ROM and DVD±R/RW SuperMulti Double-Layer Drive specifications .....	88
<b>6 Setup Utility (BIOS) .....</b>	<b>89</b>
Starting Setup Utility .....	89
Using Setup Utility .....	89
Changing the language of Setup Utility .....	89
Navigating and selecting in Setup Utility .....	90
Displaying system information .....	90
Restoring factory default settings in Setup Utility .....	90
Exiting Setup Utility .....	90

Updating the BIOS .....	91
Determining the BIOS version .....	91
Downloading a BIOS update .....	92
<b>7 Backup and recovery .....</b>	<b>93</b>
Restore .....	94
Creating restore media .....	94
Performing a system restore .....	95
Restoring using the dedicated recovery partition (select models only) .....	95
Restoring using the restore media .....	96
Changing the computer boot order .....	97
Backing up and recovering your information .....	97
Using Windows Backup and Restore .....	98
Using Windows system restore points .....	99
When to create restore points .....	99
Create a system restore point .....	99
Restore to a previous date and time .....	99
<b>8 Power cord set requirements .....</b>	<b>100</b>
Requirements for all countries .....	100
Requirements for specific countries and regions .....	101
<b>9 Recycling .....</b>	<b>103</b>
<b>Index .....</b>	<b>104</b>





# 1 Product description

Category	Description	Intel® 2nd Generation		Intel® Previous Generation		AMD
		Discrete	UMA	Discrete	UMA	UMA
	<b>HP Pavilion G6 Notebook PC</b>	√	√	√	√	√
<b>Processors</b>	Intel® Core™ i7-2620M processor (2.7 GHz, SC turbo up to 3.40 GHz, 4 MB L3 cache), Dual 35 W	√	√			
	Intel Core i5-2540M processor (2.6 GHz, SC turbo up to 3.3 GHz, 3 MB L3 cache), Dual 35 W	√	√			
	Intel Core i5-2520M processor (2.5 GHz, SC turbo up to 3.2 GHz, 3 MB L3 cache), Dual 35 W	√	√			
	Intel Core i5-2430M processor (2.4 GHz, SC turbo up to 3.0 GHz, 3 MB L3 cache), Dual 35 W	√	√			
	Intel Core i5-2410M processor (2.3 GHz, SC turbo up to 2.9 GHz, 3 MB L3 cache), Dual 35 W	√	√			
	Intel Core i3-2350M processor (2.3 GHz, 3 MB L3 cache), Dual 35 W	√	√			
	Intel Core i3 2330M processor (2.2 GHz, 3 MB L3 cache) Dual 35 W	√	√			
	Intel Core i3 2310M processor (2.1 GHz, 3 MB L3 cache) Dual 35 W	√	√			
	Intel Pentium B960 (2.2 GHz, 2 MB L3 cache), Dual 35 W	√	√			
	Intel Pentium B950 (2.1 GHz, 2 MB L3 cache), Dual 35 W	√	√			
	Intel Core i5-480M processor (2.66 GHz, SC turbo up to 2.93 GHz, 3 MB L3 cache), Dual 35 W			√	√	
	Intel Core i3-390M processor (2.66 GHz, 3 MB L3 cache), Dual 35 W					√

Category	Description	Intel® 2nd Generation		Intel® Previous Generation		AMD
		Discrete	UMA	Discrete	UMA	UMA
	Intel Core i3-380M processor (2.53 GHz, 3 MB L3 cache), Dual 35 W				✓	
	Intel Pentium P6300 (2.26 GHz, 3 MB L3 cache), Dual 35 W			✓	✓	
	Intel Pentium P6200 (2.13 GHz, 3 MB L3 cache), Dual 35 W			✓	✓	
	AMD A8-3500M (2.4 GHz/1.5 GHz, 4 MB L2 cache), Quad 35 W					✓
	AMD A6-3400M (2.3 GHz/1.4 GHz, 4 MB L2 cache), Quad 35W					✓
	AMD A4-3300M (2.5 GHz/1.9 GHz, 2 MB L2 cache), Dual 35 W					✓
	AMD E2-3000M (2.4 GHz/1.8 GHz, 1 MB L2 cache), Dual 35 W					✓
	AMD Phenom™ II N970 (2.2 GHz, 2 MB L2 cache, 1333 MHz, 3.6 GT/s) – Quad 35 W					✓
	AMD Phenom II P960 (1.8 GHz, 2 MB L2 cache, 1066 MHz, 3.6 GT/s) – Quad 25 W					✓
	AMD Phenom II N870 (2.3 GHz, 1.5 MB L2 cache, 1333 MHz, 3.6 GT/s) – Triple 35 W					✓
	AMD Phenom II P860 (2.0 GHz, 1.5 MB L2 cache, 1066 MHz, 3.6 GT/s) – Triple 25 W					✓
	AMD Phenom II N850 (2.2 GHz, 1.5 MB L2 cache, 1333 MHz, 3.6GT/s) – Triple 35 W					✓
	AMD Phenom II N660 (3.0 GHz, 2 MB L2 cache, 1333 MHz, 3.6 GT/s) – Dual 35 W					✓
	AMD Phenom II P650 (2.6 GHz, 2 MB L2 cache, 1066 MHz, 3.6 GT/s) – Dual 25 W					✓
	AMD Turion™ II P560 (2.5 GHz, 2 MB L2 cache, 1066 MHz, 3.6 GT/s) – Dual 25 W					✓
	AMD Athlon™ II P360 (2.3 GHz, 1 MB L2 cache, 1066 MHz, 3.6 GT/s) – Dual 25 W					✓

Category	Description	Intel® 2nd Generation		Intel® Previous Generation		AMD
		Discrete	UMA	Discrete	UMA	UMA
	AMD Athlon II P340 (2.2 GHz, 1 MB L2 cache, 1066 MHz, 3.2 GT/s) – Dual 25 W					✓
	AMD V160™ (2.4 GHz, 512 KB L2 cache, 1066 MHz, 3.2 GT/s) - SC 25 W					✓
	AMD V140™ (2.3 GHz, 512 KB L2 cache, 1066 MHz, 3.2 GT/s) - SC 25 W					✓
	AMD E450 (1.65 GHz, 1 MB L2 cache, 1333 MHz) - Dual 18 W					✓
	AMD E350 (1.6 GHz, 1 MB L2 cache, 1066 MHz), Dual 18 W					✓
<b>Chipset</b>	Intel HM 65 Express Chipset	✓	✓			
	Intel HM 55 Express Chipset			✓	✓	
	AMD A50M FCH					✓
	AMD A60M FCH					✓
	AMD RS880M + SB820M					✓
	AMD RS880 MD + SB820M					✓
<b>Graphics</b>	Intel HD Graphics 3000		✓			
	Intel HD Graphics		✓		✓	
	ATI Radeon™ HD 6470M with 512 MB of dedicated video memory (64Mx16 DDR3, 900 MHz x 4 PCs)	✓		✓		
	ATI Radeon HD 6470M with 1 GB of dedicated video memory (128Mx16 DDR3, 900 MHz x 4 PCs)	✓		✓		
	AMD Radeon HD 6620G					✓
	AMD Radeon HD 6520G					✓
	AMD Radeon HD 6480G					✓
	AMD Radeon HD 6380G					✓
	AMD Radeon HD 6320G					✓
	ATI Mobility Radeon HD 4250 Graphics					✓
	Support for BD and/or HD DVD playback with HD Decode, and DX10/DX11	✓	✓	✓	✓	✓
	Support for Bus Active Chip Off (BACO)	✓				

Category	Description	Intel® 2nd Generation		Intel® Previous Generation		AMD	
		Discrete	UMA	Discrete	UMA	UMA	
<b>Panel</b>	<b>39.6-cm</b> (15.6-in) HD LED BrightView (1366 x 768)	√	√	√	√	√	
	16:9 wide aspect ratio	√	√	√	√	√	
<b>Memory</b>	2 customer-accessible/upgradable SODIMM slots:						
	<ul style="list-style-type: none"> <li>DDR3-1333 MHz Dual Channel Support</li> </ul>	√	√	√	√	√	
	<ul style="list-style-type: none"> <li>DDR3-1066 MHz Dual Channel Support (DDR3-1333 downgraded to DDR3-1066)</li> </ul>			√	√		
	Supports up to 6 GB of system memory in the following configurations:						
	<ul style="list-style-type: none"> <li>6144 MB (4096 MB × 1 + 2048 × 1)</li> </ul>	√	√	√	√	√	
	<ul style="list-style-type: none"> <li>4096 MB (4096 MB × 1)</li> </ul>	√	√	√	√	√	
	<ul style="list-style-type: none"> <li>4096 MB (2048 MB × 2)</li> </ul>	√	√	√	√	√	
	<ul style="list-style-type: none"> <li>3072 MB (1024 MB × 1 + 2048 MB × 1)</li> </ul>	√	√	√	√	√	
	<ul style="list-style-type: none"> <li>2048 MB (2048 MB × 1)</li> </ul>	√	√	√	√	√	
	<ul style="list-style-type: none"> <li>2048 MB (1024 MB × 2)</li> </ul>	√	√	√	√	√	
<b>Hard drives</b>	Supports the following <b>9.5 mm, 6.35-cm</b> (2.5 in) SATA hard drives:						
	<ul style="list-style-type: none"> <li>750 GB, 5400 rpm</li> </ul>	√	√	√	√	√	
	<ul style="list-style-type: none"> <li>640 GB, 5400 rpm</li> </ul>	√	√	√	√	√	
	<ul style="list-style-type: none"> <li>500 GB, 7200 rpm; 5400 rpm</li> </ul>	√	√	√	√	√	
	Supports the following <b>9.5 mm, 6.35-cm/7 mm, 6.35-cm</b> (2.5 in) SATA hard drives:						
	<ul style="list-style-type: none"> <li>320 GB, 7200 rpm; 5400 rpm</li> </ul>	√	√	√	√	√	
	<ul style="list-style-type: none"> <li>250 GB, 7200 rpm</li> </ul>	√	√	√	√	√	
	<b>Optical drives</b>	<b>12.7 mm</b> (0.50-in) fixed SATA tray load	√	√	√	√	√
		DVD±RW and CD-RW SuperMulti Double-Layer Combo Drive	√	√	√	√	√
		Blu-ray Disc ROM with DVD±R/RW SuperMulti Double-Layer Drive	√	√	√	√	√

Category	Description	Intel® 2nd Generation		Intel® Previous Generation		AMD
		Discrete	UMA	Discrete	UMA	UMA
<b>Webcam</b>	VGA camera (640x480 by 24 frames per second), fixed angle, with activity light and single digital microphone	√	√	√	√	√
<b>Audio</b>	High-definition audio supports:  Microsoft® premium requirements with HP Altec Lansing speakers  SRS Premium Sound technology	√	√	√	√	√
<b>Ethernet</b>	Integrated 10/100 network interface card (NIC)	√	√	√	√	√
	Integrated wireless local area network (WLAN) options by way of wireless module and 2 wireless antennas built into display assembly	√	√	√	√	√
	Supports the following WLAN formats:					
	Intel Centrino® Wireless-N 1000 (802.11b/g/n)	√	√	√	√	
	Intel Centrino Wireless-N 1030 + Bluetooth (802.11b/g/n)	√	√	√	√	
	Atheros AR9285 802.11b/g/n 1x1 WiFi Adapter	√	√	√	√	√
	Ralink 5390GN 802.11b/g/n 1x1 WiFi Adapter	√	√	√	√	√
	Broadcom 4313 802.11b/g/n 1x1 WiFi and 2070 Bluetooth 2.1+EDR Combo adapter (BT3.0+HS ready)	√	√	√	√	√
	Ralink 5390BC8 802.11b/g/n 1x1 WiFi and Bluetooth 3.0+HS Combo Adapter	√	√	√	√	√
	Realtek 8188GN 802.11b/g/n 1x1 WiFi Adapter	√	√	√	√	√
	Atheros 9485GN 802.11b/g/n 1x1 WiFi and 3012 Bluetooth 4.0 Combo Adapter	√	√	√	√	√
<b>External media card</b>	Digital Media Slot supporting SD, SDHC, SDXC (UHS104 compliant), and MMC	√	√	√	√	√
<b>Internal card</b>	One half-size Mini Card slot for WLAN	√	√	√	√	√
<b>Ports</b>	Audio-in (digital microphone)	√	√	√	√	√
	Audio-out (stereo headphone)	√	√	√	√	√
	High-Definition Multimedia Interface (HDMI) version 1.4 supporting up to 1920x1200 @ 60 Hz	√	√	√	√	√

Category	Description	Intel® 2nd Generation		Intel® Previous Generation		AMD
		Discrete	UMA	Discrete	UMA	UMA
	Hot plug/unplug with auto-detect for correct output to wide-aspect vs. standard aspect video	✓	✓	✓	✓	✓
	RJ-45 (Ethernet)	✓	✓	✓	✓	✓
	Three USB 2.0 ports	✓	✓	✓	✓	✓
	VGA (Dsub 15-pin) supporting the following: <ul style="list-style-type: none"> <li>• 2048 x 1536 external resolution @ 75 Hz</li> <li>• 2048 x 1536 external resolution @ 85 Hz</li> </ul>	✓	✓	✓	✓	✓
	AC Smart Pin adapter	✓	✓	✓	✓	✓
<b>Keyboard/ pointing devices</b>	<b>39.62-cm</b> (15.6-in), full-size keyboard	✓	✓	✓	✓	✓
	TouchPad with 2 buttons (multitouch gestures, 2-finger scrolling, pinch zoom, and taps enabled as default)	✓	✓	✓	✓	✓
<b>Power requirements</b>	6-cell, 2.22 Ah, 47 Wh battery	✓	✓	✓	✓	✓
	6-cell, 2.55 Ah, 55 Wh battery	✓	✓	✓	✓	✓
	Batteries support fast charge	✓	✓	✓	✓	✓
	65 W AC Smart adapter with localized cable plug support		✓		✓	✓
	90 W AC Smart adapter with localized cable plug support	✓		✓		
<b>Security</b>	Security Lock	✓	✓	✓	✓	✓
<b>Operating system</b>	<b>Preinstalled:</b>					
	Windows 7® Home Premium (64 bit)	✓	✓	✓	✓	✓
<b>Serviceability</b>	<b>End-user replaceable parts:</b>					
	AC adapter	✓	✓	✓	✓	✓
	Battery (system)	✓	✓	✓	✓	✓
	Hard drive	✓	✓	✓	✓	✓
	Memory module	✓	✓	✓	✓	✓





Category	Description	Intel® 2nd Generation		Intel® Previous Generation		AMD
		Discrete	UMA	Discrete	UMA	UMA
	Optical drive	√	√	√	√	√
	WLAN cards	√	√	√	√	√

## 2 External component identification

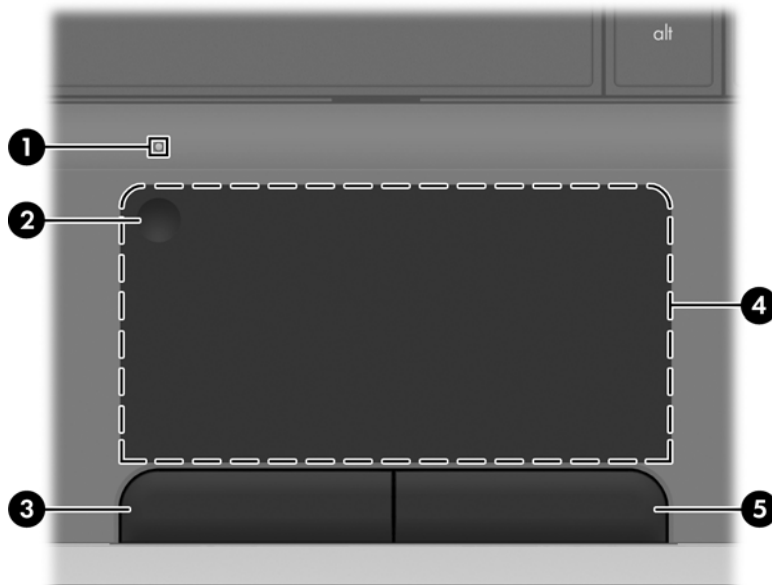
### Top

### TouchPad





Component	Description
(1)  TouchPad light	<ul style="list-style-type: none"><li>• Off: The TouchPad is on.</li><li>• Amber: The TouchPad is off.</li></ul>
(2)  TouchPad on/off button	Turns the TouchPad on and off. Quickly double-tap the TouchPad button to turn the TouchPad on and off.
(3)  Left TouchPad button	Functions like the left button on an external mouse.
(4)  TouchPad zone	Moves the pointer and selects or activates items on the screen.
(5)  Right TouchPad button	Functions like the right button on an external mouse.



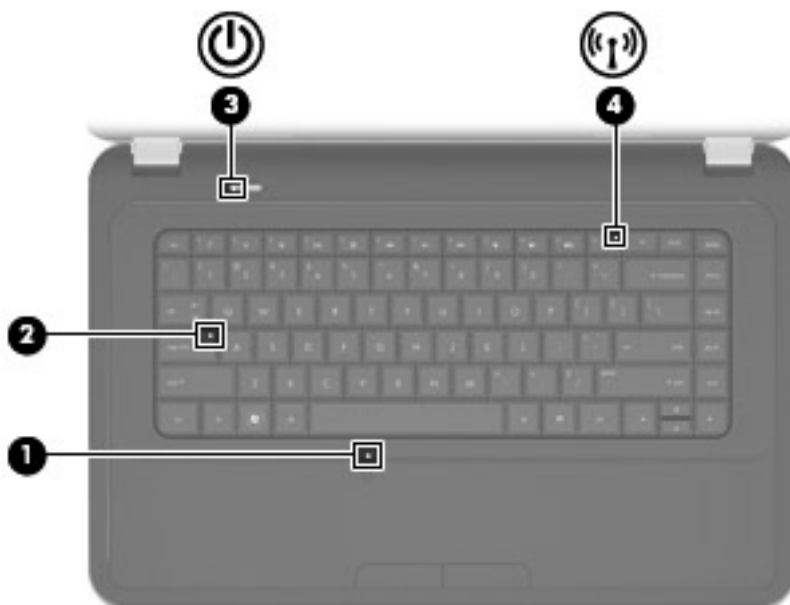

## Lights



Component	Description
(1) TouchPad light	<ul style="list-style-type: none"><li>• Off: The TouchPad is on.</li><li>• Amber: The TouchPad is off.</li></ul>
(2) Caps lock light	<ul style="list-style-type: none"><li>• White: Caps lock is on.</li><li>• Off: Caps lock is off.</li></ul>
(3)  Power light	<ul style="list-style-type: none"><li>• On: The computer is on.</li><li>• Blinking: The computer is in Sleep mode.</li><li>• Off: The computer is off or in Hibernation mode.</li></ul>
(4)  Wireless light	<ul style="list-style-type: none"><li>• White: An integrated wireless device, such as a WLAN device and/or a Bluetooth device, is on.</li><li>• Amber: All wireless devices are off.</li></ul>

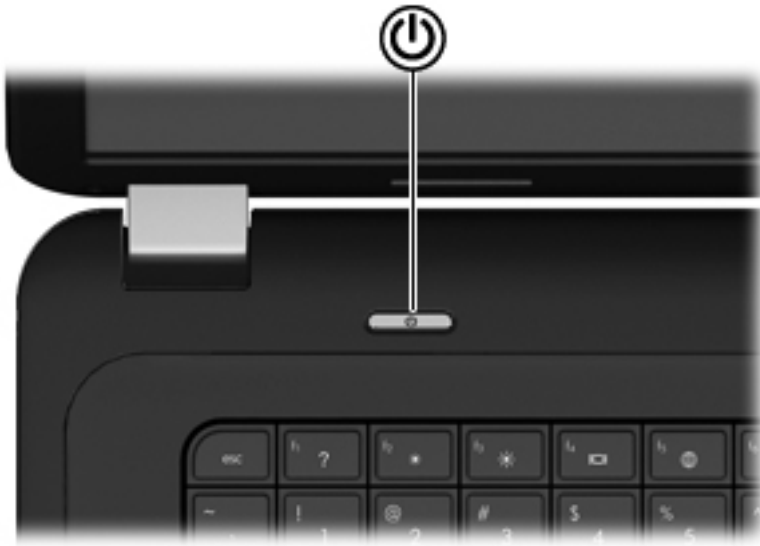

## Button

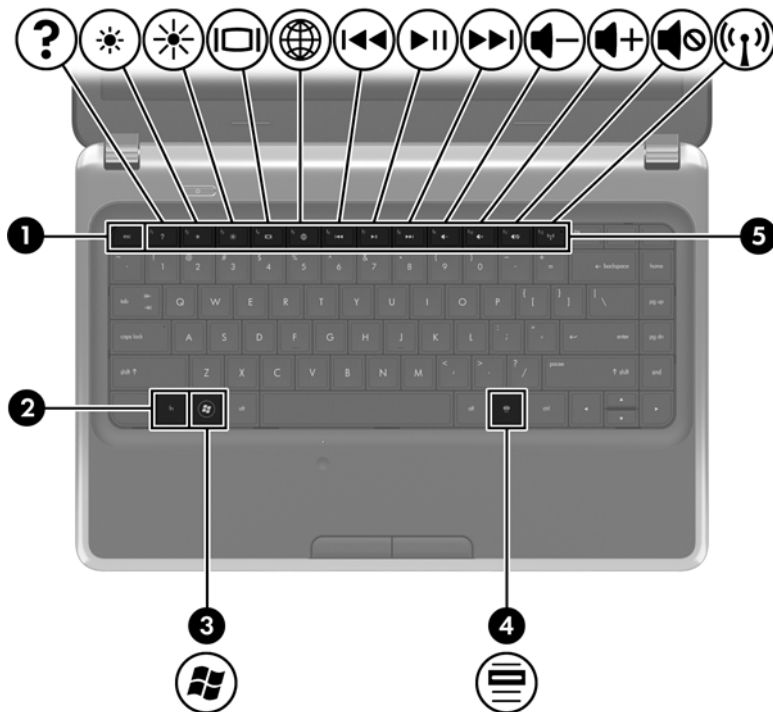

Component	Description
 Power button	<ul style="list-style-type: none"><li>• When the computer is off, press the power button to turn on the computer.</li><li>• When the computer is on, press the power button briefly to initiate Sleep mode.</li><li>• When the computer is in Sleep mode, press the power button briefly to exit Sleep mode.</li><li>• When the computer is in Hibernation mode, press the power button briefly to exit Hibernation mode.</li></ul> <p>If the computer has stopped responding and Windows shutdown procedures are ineffective, press and hold the power button for at least 5 seconds to turn off the computer.</p> <p>To learn more about your power settings, select <b>Start &gt; Control Panel &gt; System and Security &gt; Power Options</b>, or refer to the <i>HP Notebook Reference Guide</i>.</p>

## Keys



Component	Description
(1) <code>esc</code> key	Displays system information when pressed in combination with the <code>fn</code> key.
(2) <code>fn</code> key	Displays system information when pressed in combination with the <code>esc</code> key.
(3)  Windows logo key	Displays the Windows Start menu.
(4)  Windows applications key	Displays a shortcut menu for items beneath the pointer.
(5) Action keys	Execute frequently used system functions.



# Front



<b>Component</b>	<b>Description</b>
Speakers (2)	Produce sound.

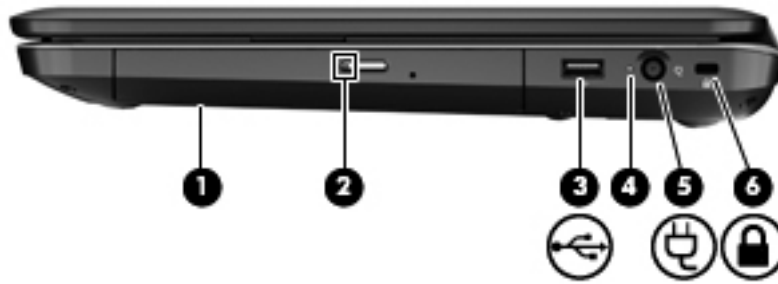





## Right side

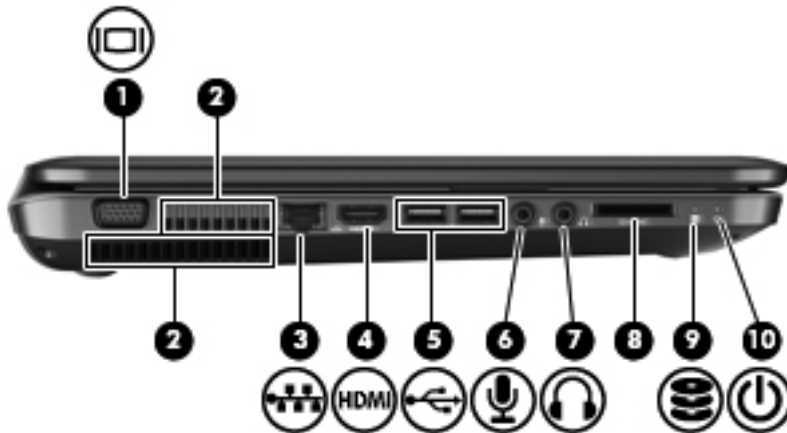



Component	Description
(1) Optical drive (select models only)	Plays optical discs, such as CDs, DVDs, and Blu-ray discs.
(2) Optical drive light	Green: The optical drive is being accessed.
(3)  USB port	Connects an optional USB device.
(4) AC adapter light	<ul style="list-style-type: none"> <li>Blinking white: The battery is low.</li> <li>Solid white: The computer is connected to external power.</li> <li>Amber: The computer is charging the battery.</li> <li>Off: The computer is not connected to external power.</li> </ul>
(5)  Power connector	Connects an AC adapter.
(6)  Security cable slot	Attaches an optional security cable to the computer.  <b>NOTE:</b> The security cable is designed to act as a deterrent, but it may not prevent the computer from being mishandled or stolen.

## Left side



Component	Description
(1)  External monitor port	Connects an external VGA monitor or projector.
(2) Vents (2)	Enable airflow to cool internal components. <b>NOTE:</b> The computer fan starts up automatically to cool internal components and prevent overheating. It is normal for the internal fan to cycle on and off during routine operation.
(3)  RJ-45 (network) jack	Connects a network cable.
(4)  HDMI port	Connects an optional video or audio device, such as a high-definition television, or any compatible digital or audio component.
(5)  USB ports (2)	Connect optional USB devices.
(6)  Audio-in (microphone) jack	Connects an optional computer headset microphone, stereo array microphone, or monaural microphone.
(7)  Audio-out (headphone) jack	Produces sound when connected to optional powered stereo speakers, headphones, earbuds, a headset, or television audio. <b>WARNING!</b> To reduce the risk of personal injury, adjust the volume before putting on headphones, earbuds, or a headset. For additional safety information, refer to the <i>Regulatory, Safety and Environmental Notices</i> . <b>NOTE:</b> When a device is connected to the jack, the computer speakers are disabled.

Component		Description
(8)	Digital Media Slot	<p>Supports the following optional digital card formats:</p> <ul style="list-style-type: none"> <li>• MultiMedia Card (MMC)</li> <li>• Secure Digital (SD) Memory Card</li> <li>• Secure Digital High Capacity (SDHC) Memory Card</li> <li>• Secure Digital Extended Capacity (SDXC) Memory Card</li> </ul>
(9)	 Hard drive light	<ul style="list-style-type: none"> <li>• White: The hard drive is being accessed.</li> </ul>
(10)	 Power light	<ul style="list-style-type: none"> <li>• White: The computer is on.</li> <li>• Blinking white: The computer is in Sleep mode.</li> </ul>

# Display







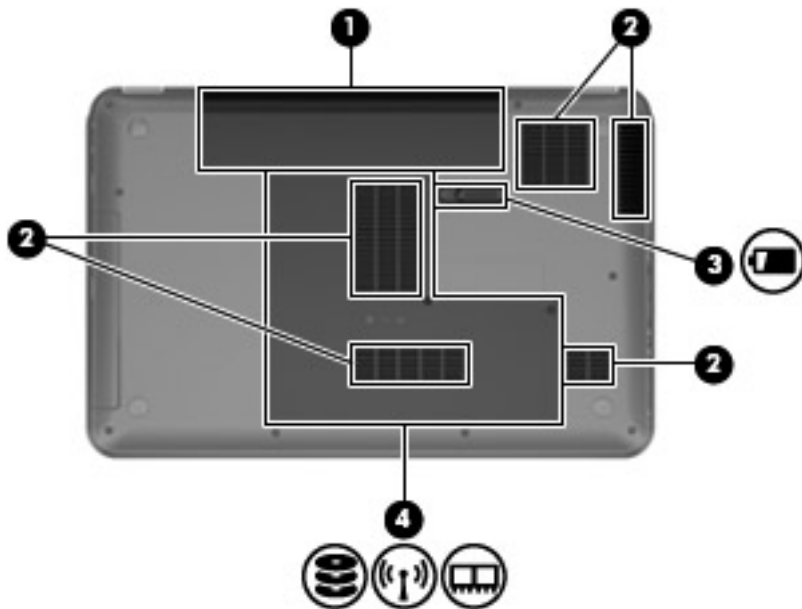

Component	Description
(1) WLAN antennas (2)*	Send and receive wireless signals to communicate with WLANs.
(2) Webcam light	On: The webcam is in use.
(3) Webcam	Records video and captures still photographs. To use the webcam, select <b>Start &gt; All Programs &gt; Cyberlink YouCam</b> .
(4) Internal microphone	Records sound.

\*The antennas are not visible from the outside of the computer. For optimal transmission, keep the areas immediately around the antennas free from obstructions. To see wireless regulatory notices, refer to the section of the *Regulatory, Safety and Environmental Notices* that applies to your country or region. These notices are located in Help and Support.



# Bottom



Component	Description
(1) Battery bay	Holds the battery.
(2) Vents (5)	Enable airflow to cool internal components.  <b>NOTE:</b> The computer fan starts up automatically to cool internal components and prevent overheating. It is normal for the internal fan to cycle on and off during routine operation.
(3)  Battery release latch	Releases the battery from the battery bay.
(4)     Service door	Provides access to the hard drive, wireless modules, and memory modules.

# 3 Illustrated parts catalog

## Serial number location

When ordering parts or requesting information, provide the computer serial number and model number located in the battery bay of the computer.

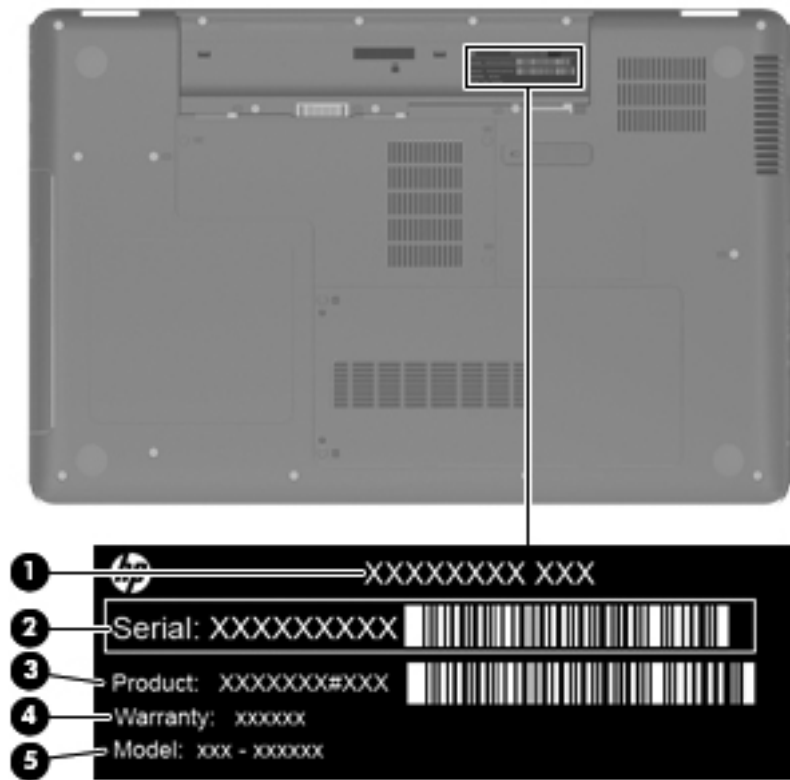

Component	Description
(1) Product name	The name affixed to the front of the computer.
(2) Serial number (s/n)	An alphanumeric identifier that is unique to each product.
(3) Product number (p/n)	This number provides specific information about the product's hardware components. The product number helps a service technician to determine what components and parts are needed.

<b>Component</b>		<b>Description</b>
(4)	Warranty period	The duration of the warranty period for the computer.
(5)	Model description	An alphanumeric identifier used to locate documents, drivers, and support for the computer.

# Computer major components

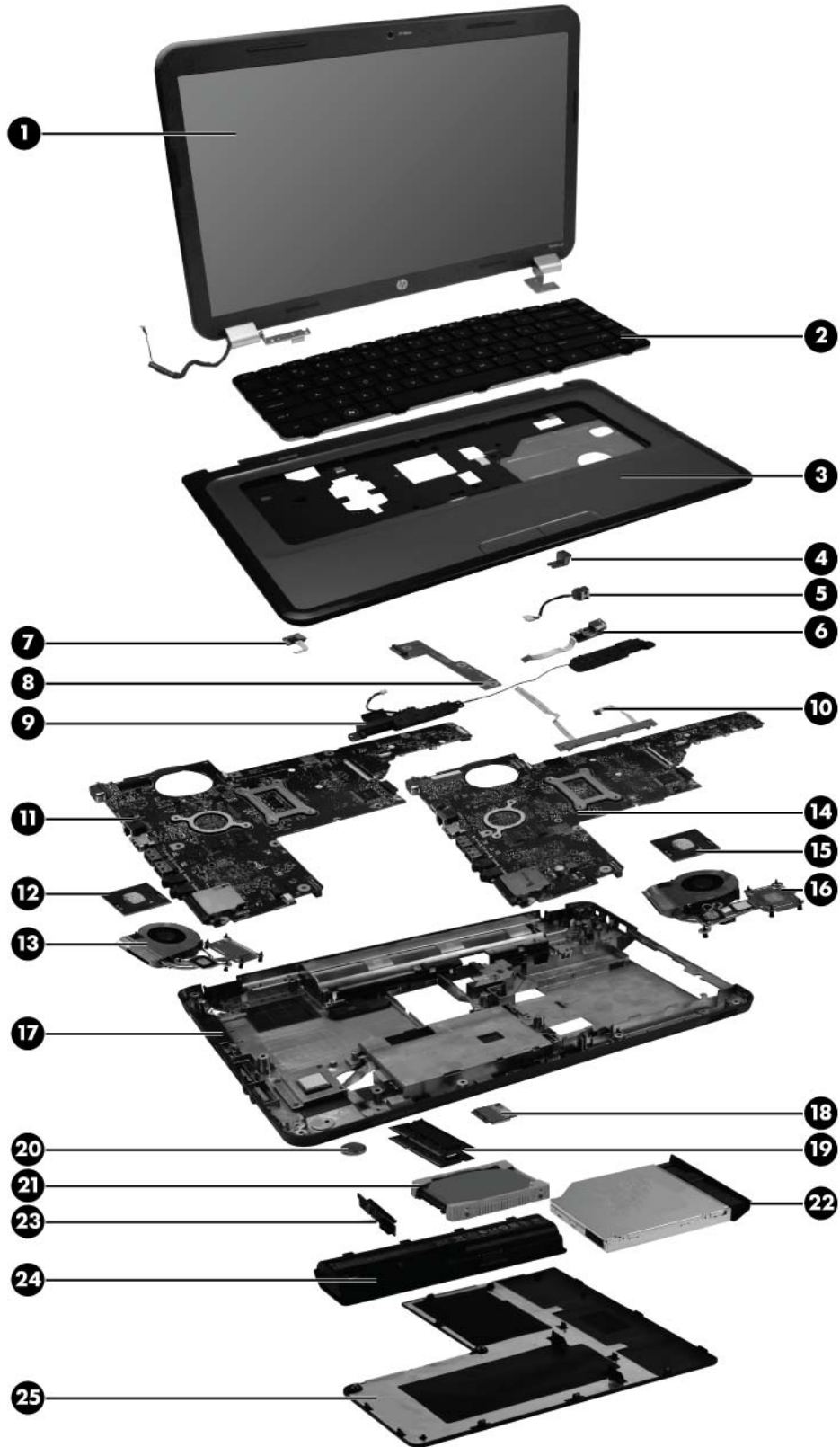

Item	Description	Spare part number
(1)	<b>39.6-cm (15.6-in) HD, LED, BrightView (1366 x 768) display assembly:</b>	
	<b>NOTE:</b> For more information on the display assembly internal component spare part information, see <a href="#">Display assembly components on page 26</a> .	
	• For use in Charcoal Grey computer models	639512-001
	• For use in Sonoma Red computer models	639514-001
	• For use in Luminous Rose computer models	639515-001
	• For use in Pewter computer models	639516-001
	• For use in Pacific Blue computer models	639517-001
	• For use in Sweet Purple computer models	639519-001
	• For use in White computer models	653389-001
(2)	<b>Keyboard</b> (includes keyboard cable):	
	• For use in the United States, Black	640892-001
	• For use in French Canada, Black	640892-121
	• For use in North America, White	653389-001
	• For use in Latin America, White	653390-161
(3)	<b>Top cover</b> (includes TouchPad board):	
	• For use in Luminous Rose computer models	639528-001
	• For use in Sweet Purple computer models	639529-001
	• For use in Pewter computer models	639531-001
	• For use in Charcoal Grey computer models	639532-001
	• For use in Sonoma Red computer models	639533-001
	• For use in Pacific Blue computer models	639534-001
	• For use in White computer models	653391-001
(4)	<b>Security lock bracket</b> (included with base enclosure)	
(5)	<b>Power connector</b> (includes cable)	640891-001
(6)	<b>USB board</b>	640883-001
(7)	<b>Power button board</b>	640884-001
(8)	<b>Optical drive board</b>	640886-001
(9)	<b>Speaker assembly</b> (includes cable)	639573-001
(10)	<b>TouchPad button board</b>	640885-001
(11 & 14)	<b>System board</b> (includes replacement thermal material):	
	• For use in Intel HM55 UMA computer models	639521-001

<b>Item</b>	<b>Description</b>	<b>Spare part number</b>
	• For use in Intel HM65 UMA computer models	639522-001
	• For use in Intel HM55 discrete, 512 MB, computer models	639523-001
	• For use in Intel HM55 discrete, 1 GB, computer models	639524-001
	• For use in Intel HM65 discrete, 512 MB, computer models	639525-001
	• For use in Intel HM65 discrete, 1 GB, computer models	639526-001
	• For use in AMD UMA computer models	640893-001
	• For use in Intel HM55 i3-370M UMA computer models.	653087-001
	• For use in Intel HM65 UMA 1.1 computer models	657459-001
	• For use in Intel HM65 discrete 512 MB computer models	657461-001
	• For use in Intel HM65 discrete 1 GB computer models	657462-001
	• For use in AMD E350 UMA computer models	646738-001
	• For use in AMD A60M UMA computer models	649288-001
	• For use in AMD E450 UMA computer models	657146-001
	• For use in AMD 880M computer models	668360-001
(12 & 15)	<b>Processor</b> (includes replacement thermal material)	
	• Intel Core i7-2620M processor (2.7 GHz, SC turbo up to 3.40 GHz, 4 MB L3 cache), Dual 35 W	631252-001
	• Intel Core i5-2540M processor (2.6 GHz, SC turbo up to 3.3 GHz, 3 MB L3 cache), Dual 35 W	631255-001
	• Intel Core i5-2520M processor (2.5 GHz, SC turbo up to 3.2 GHz, 3 MB L3 cache), Dual 35 W	631253-001
	• Intel Core i5-2430M processor (2.4 GHz, SC turbo up to 3.0 GHz, 3 MB L3 cache), Dual 35 W	653341-001
	• Intel Core i5-2410M processor (2.3 GHz, SC turbo up to 2.9 GHz, 3 MB L3 cache), Dual 35 W	638039-001
	• Intel Core i3-2350M processor (2.3 GHz, 3 MB L3 cache), Dual 35 W	653340-001
	• Intel Core i3 2330M processor (2.2 GHz, 3 MB L3 cache), Dual 35 W	653339-001
	• Intel Core i3 2310M (2.1 GHz, 3 MB L3 cache), Dual 35 W	638037-001
	• Intel Pentium B960 (2.2 GHz, 2 MB L3 cache), Dual 35 W	653337-001
	• Intel Pentium B950 (2.1 GHz, 2 MB L3 cache), Dual 35 W	653338-001
	• Intel Core i5-480M processor (2.66 GHz, SC turbo up to 2.93 GHz, 3 MB L3 cache), Dual 35 W	634693-001
	• Intel Core i3-390M processor (2.66 GHz, 3 MB L3 cache), Dual 35 W	634692-001
	• Intel Core i3-380M processor (2.53 GHz, 3 MB L3 cache), Dual 35 W	625823-001

<b>Item</b>	<b>Description</b>	<b>Spare part number</b>
	• Intel Pentium P6300 (2.26 GHz, 3 MB L3 cache), Dual 35 W	635500-001
	• Intel Pentium P6200 (2.13 GHz, 3 MB L3 cache), Dual 35 W	625831-001
	• AMD A8-3500M (2.4 GHz/1.5 GHz, 4 MB L2 cache), Quad 35 W	653350-001
	• AMD A6-3400M (2.3 GHz/1.4 GHz, 4 MB L2 cache), Quad 35 W	653349-001
	• AMD A4-3300M (2.5 GHz/1.9 GHz, 2 MB L2 cache), Dual 35 W	653348-001
	• AMD E2-3000M (2.4 GHz/1.8 GHz, 1 MB L2 cache), Dual 35 W	653351-001
	• AMD Phenom II N970 (2.2 GHz, 2 MB L2 cache, 1333 MHz, 3.6 GT/s) – Quad 35 W	635496-001
	• AMD Phenom II P960 (1.8 GHz, 2 MB L2 cache, 1066 MHz, 3.6 GT/s) – Quad 25 W	634689-001
	• AMD Phenom II N870 (2.3 GHz, 1.5 MB L2 cache, 1333 MHz, 3.6 GT/s) – Triple 35 W	635495-001
	• AMD Phenom II P860 (2.0 GHz, 1.5 MB L2 cache, 1066 MHz, 3.6 GT/s) – Triple 25 W	634688-001
	• AMD Phenom II N850 (2.2 GHz, 1.5 MB L2 cache, 1333 MHz, 3.6 GT/s) – Triple 35 W	616345-001
	• AMD Phenom II N660 (3.0 GHz, 2 MB L2 cache, 1333 MHz, 3.6 GT/s) – Dual 35 W	635494-001
	• AMD Phenom II P650 (2.6 GHz, 2 MB L2 cache, 1066 MHz, 3.6 GT/s) – Dual 25 W	634687-000
	• AMD Turion II P560 (2.5 GHz, 2 MB L2 cache, 1066 MHz, 3.6 GT/s) – Dual 25 W	634691-001
	• AMD Athlon II P360 (2.3 GHz, 1 MB L2 cache, 1066 MHz, 3.6 GT/s) – Dual 25 W	636635-001
	• AMD Athlon II P340 (2.2 GHz, 1 MB L2 cache, 1066 MHz, 3.2 GT/s) – Dual 25 W	616343-001
	• AMD V160 (2.4 GHz, 512 KB L2 cache, 1066 MHz, 3.2 GT/s) – SC 25 W	636634-001
	• AMD V140 (2.3 GHz, 512 kB L2 cache, 1066 MHz, 3.2 GT/s) – SC 25 W	616333-001
(13 & 16)	<b>Fan/heat sink assembly</b> (includes replacement thermal material):	
	• For use in AMD UMA computer models	640896-001
	• For use in Intel UMA computer models	641024-001
	• For use in Intel discrete computer models	641025-001
	• For use in AMD A60M UMA computer models	657143-001
	• For use in AMD A50M UMA computer models	657145-001
(17)	<b>Base enclosure</b>	639569-001
(18)	<b>WLAN module</b>	
	• Atheros 9285G 802.11b/g/n WiFi Adapter	580101-001

Item	Description	Spare part number
	<ul style="list-style-type: none"> <li>Broadcom 4313 802.11b/g/n 1x1 WiFi and 2070 Bluetooth 2.1+EDR Combo adapter (BT3.0+HS ready)</li> </ul>	600370-001
	<ul style="list-style-type: none"> <li>Intel Centrino Wireless-N 1030 + Bluetooth (802.11b/g/n)</li> </ul>	631956-001
	<ul style="list-style-type: none"> <li>Intel Centrino Wireless-N 1000 (802.11b/g/n)</li> </ul>	593530-001
	<ul style="list-style-type: none"> <li>Ralink 5390GN 802.11b/g/n 1x1 WiFi Adapter</li> </ul>	630703-001
	<ul style="list-style-type: none"> <li>Ralink 5390BC8 802.11b/g/n 1x1 WiFi and Bluetooth 3.0+HS Combo Adapter</li> </ul>	630705-001
	<ul style="list-style-type: none"> <li>Realtek 8188GN 802.11b/g/n 1x1 WiFi Adapter</li> </ul>	640926-001
	<ul style="list-style-type: none"> <li>Realtek 8188BC8 802.11a/b/g/n 2x2 WiFi and Bluetooth 3.0+HS Combo Adapter</li> </ul>	602993-001
	<ul style="list-style-type: none"> <li>Atheros AR9002WB-1NGB 802.11b/g/n 1x1 WiFi and Bluetooth 2.1+EDR Combo Adapter</li> </ul>	593127-001
	<ul style="list-style-type: none"> <li>Atheros 9485GN 802.11b/g/n 1x1 WiFi and 3012 Bluetooth 4.0 Combo Adapter</li> </ul>	655795-001
	<ul style="list-style-type: none"> <li>Broadcom 4313GN 802.11b/g/n 1x1 WiFi and 20702 Bluetooth 4.0 Combo Adapter</li> </ul>	657325-001
(19)	<b>Memory modules</b> (1066 MHz, DDR3)	
	<ul style="list-style-type: none"> <li>4 GB PC3 10600 1333 MHz shared</li> </ul>	621569-001
	<ul style="list-style-type: none"> <li>2 GB PC3-10600 MHz</li> </ul>	581096-001
	<ul style="list-style-type: none"> <li>1 GB PC3 10600 1333 MHz shared</li> </ul>	639738-001
(20)	<b>RTC battery</b> (includes mounting adhesive)	449137-001
(21)	<b>Hard drive</b>	
	Supports the following <b>9.5 mm, 6.35 cm</b> (2.5 in) SATA hard drives:	
	<ul style="list-style-type: none"> <li>750 GB, 5400 rpm</li> </ul>	634250-001
	<ul style="list-style-type: none"> <li>640 GB, 5400 rpm</li> </ul>	603785-001
	<ul style="list-style-type: none"> <li>500 GB, 7200 rpm</li> </ul>	634925-001
	<ul style="list-style-type: none"> <li>500 GB, 5400 rpm</li> </ul>	634638-001
	Supports the following <b>9.5 mm / 7.0 mm, 6.35 cm</b> (2.5 in) SATA hard drives:	
	<ul style="list-style-type: none"> <li>320 GB, 7200 rpm</li> </ul>	634862-001
	<ul style="list-style-type: none"> <li>250 GB, 7200 rpm</li> </ul>	634861-001
	<ul style="list-style-type: none"> <li>Hard Drive Hardware Kit (not illustrated, includes bracket and screws)</li> </ul>	640878-001
(22)	<b>Optical drive (select models only)</b> (includes optical drive bezel and bracket)	
	Blu-ray Disc ROM DVD±R/RW SuperMulti Double-Layer Drive	663683-001
	DVD±RW and CD-RW SuperMulti Double-Layer Combo Drive	660833-001
	Optical Disc Drive protective insert	659360-001
(23)	<b>Hard drive connector board</b>	644525-001



<b>Item</b>	<b>Description</b>	<b>Spare part number</b>
(24)	<b>Battery</b>	
	<ul style="list-style-type: none"> <li>• 6-cell Li-Ion, 2.20 Ah, 47 Wh</li> </ul>	593553-001
	<ul style="list-style-type: none"> <li>• 6-cell Li-Ion, 2.55 Ah, 55 Wh</li> </ul>	593554-001
(25)	<b>Service door</b> (included in plastics kit)	640889-001
	<b>Rubber Kit</b> (not illustrated, includes bumper and rubber feet)	639572-001

# Display assembly components

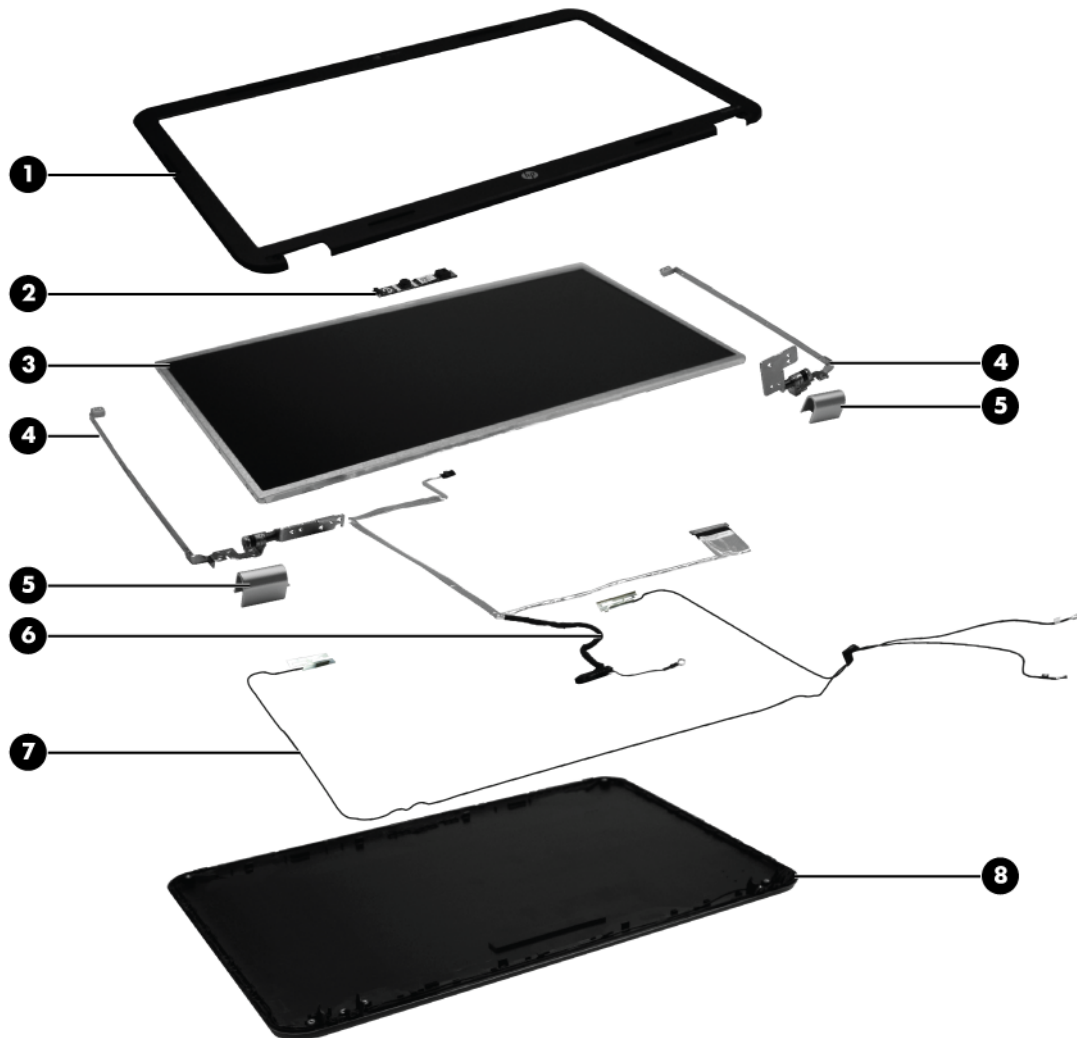

Item	Description	Spare part number
(1)	<b>Display bezel</b>	
	<ul style="list-style-type: none"> <li>• <b>Black</b></li> </ul>	639509-001
	<ul style="list-style-type: none"> <li>• <b>White</b></li> </ul>	657305-001
(2)	<b>Webcam module</b>	640880-001
(3)	<b>39.6-cm (15.6-in)</b> high-definition, BrightView LED display panel	641663-001
(4)	<b>Display hinges</b>	639511-001
(5)	<b>Display hinge covers</b>	640887-001
(6)	<b>Display cable</b>	639510-001
(7)	<b>Wireless antenna</b> (includes wireless antenna transceivers and cable)	639499-001
(8)	<b>Display back cover</b> (includes logo):	

<b>Item</b>	<b>Description</b>	<b>Spare part number</b>
	<ul style="list-style-type: none"> <li>• For use in Pewter computer models</li> </ul>	639500-001
	<ul style="list-style-type: none"> <li>• For use in Charcoal Grey computer models</li> </ul>	639501-001
	<ul style="list-style-type: none"> <li>• For use in Sonoma Red computer models</li> </ul>	639502-001
	<ul style="list-style-type: none"> <li>• For use in Pacific Blue computer models</li> </ul>	639503-001
	<ul style="list-style-type: none"> <li>• For use in Luminous Rose computer models</li> </ul>	639506-001
	<ul style="list-style-type: none"> <li>• For use in Sweet Purple computer models</li> </ul>	639507-001
	<ul style="list-style-type: none"> <li>• For use in White computer models</li> </ul>	653388-001
	<b>Display Screw Kit</b> (not illustrated)	640881-001
	<b>Display Rubber Kit</b> (not illustrated, includes display bumper strips)	640882-001
	<ul style="list-style-type: none"> <li>• Black</li> </ul>	640882-001
	<ul style="list-style-type: none"> <li>• White</li> </ul>	657304-001

## Mass storage devices

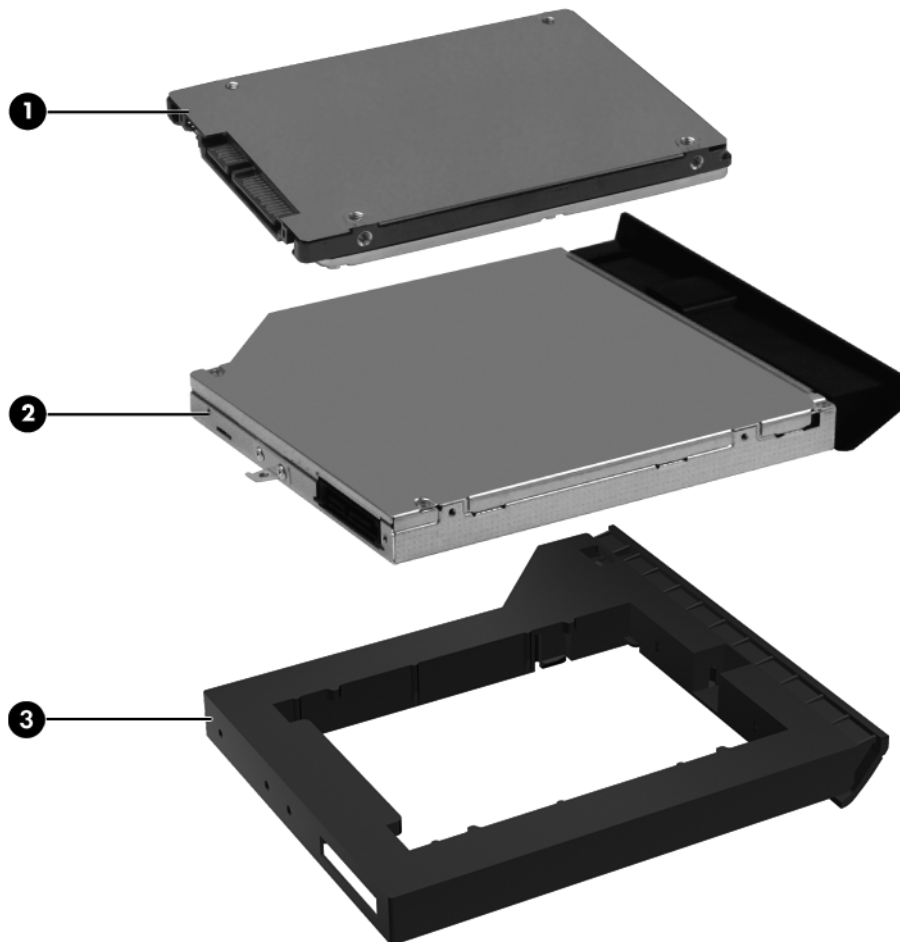

Item	Description	Spare part number
(1)	<b>Hard drive</b>	
	Supports the following <b>9.5 mm, 6.3 cm</b> (2.5 in) SATA hard drives:	
	• 750 GB, 5400 rpm	634250-001
	• 640 GB, 5400 rpm	603785-001
	• 500 GB, 7200 rpm	634925-001
	• 500 GB, 5400 rpm	634638-001
	Supports the following <b>9.5 mm / 7.0 mm, 6.35 cm</b> (2.5 in) SATA hard drives:	
	• 320 GB, 7200 rpm	634862-001
	• 250 GB, 7200 rpm	634861-001
	<b>Hard Drive Hardware Kit</b> (not illustrated, includes bracket and screws)	640878-001
(2)	<b>Optical drive</b> (select models only), (12.7 mm, SATA, fixed, includes bezel and bracket)	
	DVD±RW and CD-RW SuperMulti Double-Layer Combo Drive	660833-001

<b>Item</b>	<b>Description</b>	<b>Spare part number</b>
	Blu-ray Disc ROM DVD±R/RW SuperMulti Double-Layer Drive	663683-001
(3)	<b>Optical Drive protective insert</b>	659360-001

# Miscellaneous parts

Description	Spare part number
<b>AC adapters</b>	
<ul style="list-style-type: none"><li>65 W AC adapter</li></ul>	609939-001
<ul style="list-style-type: none"><li>90 W AC adapter (select models only)</li></ul>	620656-001
<b>Power cord, AC, 3 wire, black, 1.83-m</b>	490371-001
<b>Thermal pads kit</b>	634366-001
<b>Screw kit</b>	640879-001
<ul style="list-style-type: none"><li>Phillips 2.0 x 2.0 (pan head) screw</li><li>Phillips 3.0 x 1.5 screw</li><li>Phillips 3.0 x 2.0 screw</li><li>Phillips 3.0 x 3.0 screw</li><li>Phillips 4.0 x 2.0 (captive) screw</li><li>Phillips 6.0 x 2.5 screw</li><li>Phillips 10.0 x 2.0 (captive) screw</li></ul>	

## Sequential part number listing

Spare part number	Description
449137-001	RTC battery (includes mounting adhesive)
490371-001	Power cord, AC, 3 wire, black, 1.83-m
580101-001	Atheros 9285G 802.11b/g/n WiFi Adapter
581096-001	2 GB memory module, 1066 MHz, DDR3
593127-001	Atheros AR9002WB-1NGB 802.11b/g/n 1x1 WiFi and Bluetooth 2.1+EDR Combo Adapter
593530-001	Intel Centrino Wireless-N 1000 (802.11b/g/n)
593553-001	Battery, 6-cell, 2.20 Ah, 47 Wh
593554-001	Battery, 6-cell, 2.55 Ah, 55 Wh
600370-001	Broadcom 4313GN 802.11b/g/n 1x1 WiFi and 2070 Bluetooth 2.1+EDR Combo Adapter
602993-001	Realtek 8188BC8 802.11a/b/g/n 2x2 WiFi and Bluetooth 3.0+HS Combo Adapter
603785-001	640 GB, 5400 rpm <b>9.5 mm, 6.35 cm</b> (2.5 in) SATA hard drive
609939-001	65 W AC adapter
616333-001	AMD V140 processor (2.3 GHz, 512 K L2 cache, 1066 MHz, 3.2 GT/s), SC 25 W
616343-001	AMD Athlon II P340 processor (2.2 GHz, 1 MB L2 cache, 1066 MHz, 3.2 GT/s), Dual 25 W
616345-001	AMD Phenom II N850 processor (2.2 GHz, 1.5 MB L2 cache, 1333 MHz, 3.6 GT/s), Triple 35 W
620656-001	90 W AC adapter
621569-001	4 GB memory module, 10600 1333 MHz shared
625823-001	Intel Core i3-380M processor (2.53 GHz, 3 MB L3 cache), Dual 35 W
625831-001	Intel Pentium P6200 processor (2.13 GHz, 3 MB L3 cache), Dual 35 W
630703-001	Ralink 5390GN 802.11b/g/n 1x1 WiFi Adapter
630705-001	Ralink 5390BC8 802.11b/g/n 1x1 WiFi and Bluetooth 3.0+HS Combo Adapter
631252-001	Intel Core i7-2620M processor (2.7 GHz, SC turbo up to 3.40 GHz, 4 MB L3 cache), Dual 35 W
631253-001	Intel Core i5-2520M processor (2.5 GHz, SC turbo up to 3.2 GHz, 3 MB L3 cache), Dual 35 W
631255-001	Intel Core i5-2540M processor (2.6 GHz, SC turbo up to 3.3 GHz, 3 MB L3 cache), Dual 35 W
631956-001	Intel Centrino Wireless-N 1030 + Bluetooth 802.11 b/g/n adapter
634250-001	750 GB, 5400 rpm <b>9.5 mm, 6.35 cm</b> (2.5 in) SATA hard drive
634366-001	Thermal pads kit
634638-001	500 GB, 5400 rpm <b>9.5 mm, 6.35 cm</b> (2.5 in) SATA hard drive
634687-001	AMD Phenom II P650 processor (2.6 GHz, 2 MB L2 cache, 1066 MHz, 3.6 GT/s), Dual 25 W

Spare part number	Description
634688-001	AMD Phenom II P860 processor (2.0 GHz, 1.5 MB L2 cache, 1066 MHz, 3.6 GT/s), Triple 25 W
634689-001	AMD Phenom II P960 processor (1.8 GHz, 2 MB L2 cache, 1066 MHz, 3.6 GT/s), Quad 25 W
634691-001	AMD Turion II P560 processor (2.5 GHz, 2 MB L2 cache, 1066 MHz, 3.6 GT/s), Dual 25 W
634692-001	Intel Core i3-390M processor (2.66 GHz, 3 MB L3 cache), Dual 35 W
634693-001	Intel Core i5-480M processor (2.66 GHz, SC turbo up to 2.93 GHz, 3 MB L3 cache), Dual 35 W
634861-001	250 GB, 7200 rpm, <b>7.0 mm, 6.35 cm</b> (2.5 in) SATA hard drive
634862-001	320 GB, 7200 rpm, <b>7.0 mm, 6.35 cm</b> (2.5 in) SATA hard drive
634925-001	500 GB, 7200 rpm <b>9.5 mm, 6.35 cm</b> (2.5 in) SATA hard drive
635494-001	AMD Phenom II N660 processor (3.0 GHz, 2 MB L2 cache, 1333 MHz, 3.6 GT/s), Dual 35 W
635495-001	AMD Phenom II N870 processor (2.3 GHz, 1.5 MB L2 cache, 1333 MHz, 3.6 GT/s), Triple 35 W
635496-001	AMD Phenom II N970 processor (2.2 GHz, 2 MB L2 cache, 1333 MHz, 3.6 GT/s), Quad 35 W
635500-001	Intel Pentium P6300 processor (2.26 GHz, 3 MB L3 cache), Dual 35 W
636634-001	AMD V160 processor (2.4 GHz, 512 K L2 cache, 1066 MHz, 3.2 GT/s), SC 25 W
636635-001	AMD Athlon II P360 processor (2.3 GHz, 1 MB L2 cache, 1066 MHz, 3.6 GT/s), Dual 25 W
638037-001	Intel Core i3 2310M processor (2.1 GHz, 3 MB L3 cache), Dual 35 W
638039-001	Intel Core i5-2410M processor (2.3 GHz, SC turbo up to 2.9 GHz, 3 MB L3 cache), Dual 35 W
639499-001	Wireless antenna (includes wireless antenna transceivers and cable)
639500-001	Display back cover (includes logo) for use in Pewter computer models
639501-001	Display back cover (includes logo) for use in Charcoal Grey computer models
639502-001	Display back cover (includes logo) for use in Sonoma Red computer models
639503-001	Display back cover (includes logo) for use in Pacific Blue computer models
639506-001	Display back cover (includes logo) for use in Luminous Rose computer models
639507-001	Display back cover (includes logo) for use in Sweet Purple computer models
639509-001	Display bezel, Black
639510-001	Display cable
639511-001	Display hinges
639512-001	<b>39.6 cm</b> (15.6 in) HD LED BrightView (1366 x 768) display assembly for use in Charcoal Grey computer models
639514-001	<b>39.6 cm</b> (15.6 in) HD LED BrightView (1366 x 768) display assembly for use in Sonoma Red computer models



<b>Spare part number</b>	<b>Description</b>
639515-001	<b>39.6 cm</b> (15.6 in) HD LED BrightView (1366 x 768) display assembly for use in Luminous Rose computer models
639516-001	<b>39.6 cm</b> (15.6 in) HD LED BrightView (1366 x 768) display assembly for use in Pewter computer models
639517-001	<b>39.6 cm</b> (15.6 in) HD LED BrightView (1366 x 768) display assembly for use in Pacific Blue computer models
639519-001	<b>39.6 cm</b> (15.6 in) HD LED BrightView (1366 x 768) display assembly for use in Sweet Purple computer models
639521-001	System board (includes replacement thermal material) for use in Intel HM55 UMA computer models
639522-001	System board (includes replacement thermal material) for use in Intel HM65 UMA computer models
639523-001	System board (includes replacement thermal material) for use in Intel HM55 discrete, 512 MB, computer models
639524-001	System board (includes replacement thermal material) for use in Intel HM55 discrete, 1 GB, computer models
639525-001	System board (includes replacement thermal material) for use in Intel HM65 discrete, 512 MB, computer models
639526-001	System board (includes replacement thermal material) for use in Intel HM65 discrete, 1 GB, computer models
639528-001	Top cover (includes TouchPad board) for use in Luminous Rose computer models
639529-001	Top cover (includes TouchPad board) for use in Sweet Purple computer models
639531-001	Top cover (includes TouchPad board) for use in Pewter computer models
639532-001	Top cover (includes TouchPad board) for use in Charcoal Grey computer models
639533-001	Top cover (includes TouchPad board) for use in Sonoma Red computer models
639534-001	Top cover (includes TouchPad board) for use in Pacific Blue computer models
639569-001	Base enclosure
639572-001	Rubber Kit (includes bumper and rubber feet)
639573-001	Speaker assembly (includes cable)
639738-001	1 GB Memory module PC3 10600 1333 MHz shared
640878-001	Hard Drive Hardware Kit (includes bracket and screws)
640879-001	Screw Kit
640880-001	Webcam module
640881-001	Display Screw Kit
640882-001	Display Rubber Kit, Black (includes display bumper strips)
640883-001	USB board
640884-001	Power button board

Spare part number	Description
640885-001	TouchPad button board (includes bracket and cable)
640886-001	Optical drive board
640887-001	Display hinge covers
640889-001	Plastics Kit (includes service door)
640891-001	Power connector (includes cable)
640892-001	Keyboard (includes keyboard cable) for use in the United States, Black
640892-121	Keyboard (includes keyboard cable) for use in French Canada, Black
640893-001	System board (includes replacement thermal material) for use in AMD UMA computer models
640896-001	Fan/heat sink assembly (includes replacement thermal material) for use in AMD computer models
640926-001	Realtek 8188GN 802.11b/g/n 1x1 WiFi Adapter
641024-001	Fan/heat sink assembly (includes replacement thermal material) for use in Intel UMA computer models
641025-001	Fan/heat sink assembly (includes replacement thermal material) for use in Intel discrete computer models
641663-001	<b>39.6 cm</b> (15.6-in) high-definition, BrightView LED display panel
644525-001	Hard drive connector board
646738-001	System board (includes replacement thermal material) for use in AMD E350 UMA computer models
649288-001	System board (includes replacement thermal material) for use in AMD A60M UMA computer models
653087-001	System board (includes replacement thermal material) for use in Intel HM55 i3-370M UMA computer models
653338-001	Intel Pentium B950 processor (2.1 GHz, 2 MB L3 cache), Dual 35 W
653339-001	Intel Core i3-2330M processor (2.2 GHz, 3 MB L3 cache), Dual 35 W
653340-001	Intel Core i3-2350M processor (2.3 GHz, 3 MB L3 cache), Dual 35 W
653341-001	Intel Core i5-2430M processor (2.4 GHz, SC turbo up to 3.0 GHz, 3 MB L3 cache), Dual 35 W
653348-001	AMD A4-3300M processor (2.5 GHz/1.9 GHz, 2 MB L2 cache), Dual 35 W
653349-001	AMD A6-3400M processor (2.3 GHz/1.4 GHz, 4 MB L2 cache), Quad 35 W
653350-001	AMD A8-3500M processor (2.4 GHz/1.5 GHz, 4 MB L2 cache), Quad 35 W
6533651-001	AMD E2-3000M processor (2.4 GHz/1.8 GHz, 1 MB L2 cache), Dual 35 W
653388-001	Display back cover (includes logo) for use in White computer models
653389-001	<b>39.6 cm</b> (15.6 in) HD LED BrightView (1366 x 768) display assembly for use in White computer models
653390-001	Keyboard (includes keyboard cable) for use in the United States, White
653390-161	Keyboard (includes keyboard cable) for use in the Latin America, White

<b>Spare part number</b>	<b>Description</b>
653391-001	Top cover (includes TouchPad board) for use in White computer models
655795-001	Atheros 9485GN 802.11b/g/n 1x1 WiFi and 3012 Bluetooth 4.0 Combo Adapter
657143-001	Fan/heat sink assembly (includes replacement thermal material) for use in AMD A60M UMA computer models
657145-001	Fan/heat sink assembly (includes replacement thermal material) for use in AMD A50M UMA computer models
657146-001	System board (includes replacement thermal material) for use in AMD E450 UMA computer models
657304-001	Display Rubber Kit, White (includes display bumper strips)
657305-001	Display bezel, White
657325-001	Broadcom 4313GN 802.11b/g/n 1x1 WiFi and 20702 Bluetooth 4.0 Combo Adapter
657459-001	System board (includes replacement thermal material) for use in HM65 UMA 1.1 computer models
657461-001	System board (includes replacement thermal material) for use in HM65 discrete 512MB computer models
657462-001	System board (includes replacement thermal material) for use in HM65 discrete 1GB computer models
659360-001	Optical Drive protective insert
660833-001	DVD±RW and CD-RW SuperMulti Double-Layer Combo Drive
663683-001	Blu-ray Disc ROM DVD±R/RW SuperMulti Double-Layer Drive
664662-001	Intel Pentium B960 (2.2 GHz, 2 M L3 cache), Dual 35 W
668360-001	System board (includes replacement thermal material) for use in AMD 880M UMA computer models

---

# 4 Removal and replacement procedures

## Preliminary replacement requirements

### Tools required

The following tools are needed to complete the removal and replacement procedures:

- Flat-bladed screwdriver
- Magnetic screwdriver
- Phillips P0 and P1 screwdrivers

### Service considerations

Before disassembly or assembly procedures, review and adhere to all service considerations.



**NOTE:** As you remove each subassembly from the computer, place the subassembly (and all accompanying screws) away from the work area to prevent damage.

---

### Plastic parts

Using excessive force during disassembly and reassembly can damage plastic parts. Use care when handling the plastic parts. Apply pressure only at the points designated in the maintenance instructions.

## Cables and connectors

---

**⚠ CAUTION:** When servicing the computer, be sure that cables are placed in their proper locations during the reassembly process. Improper cable placement can damage the computer.

---

Cables must be handled with extreme care to avoid damage. Apply only the tension required to unseat or seat the cables during removal and insertion. Handle cables by the connector whenever possible. In all cases, avoid bending, twisting, or tearing cables. Be sure that cables are routed in such a way that they cannot be caught or snagged by parts being removed or replaced. Handle flex cables with extreme care; these cables tear easily.

## Drive handling

---

**⚠ CAUTION:** Drives are fragile components that must be handled with care. To prevent damage to the computer, damage to a drive, or loss of information, observe these precautions:

---

Before removing or inserting a hard drive, shut down the computer. If you are unsure whether the computer is off or in Hibernation, turn the computer on, and then shut it down through the operating system.

Before handling a drive, be sure that you are discharged of static electricity. While handling a drive, avoid touching the connector.

Before removing a diskette drive or optical drive, be sure that a diskette or disc is not in the drive and be sure that the optical drive tray is closed.

Handle drives on surfaces covered with at least one inch of shock-proof foam.

Avoid dropping drives from any height onto any surface.

After removing a hard drive, an optical drive, or a diskette drive, place it in a static-proof bag.

Avoid exposing a hard drive to products that have magnetic fields, such as monitors or speakers.

Avoid exposing a drive to temperature extremes or liquids.

If a drive must be mailed, place the drive in a bubble pack mailer or other suitable form of protective packaging and label the package "FRAGILE."

---

# Grounding guidelines

## Electrostatic discharge damage

Electronic components are sensitive to electrostatic discharge (ESD). Circuitry design and structure determine the degree of sensitivity. Networks built into many integrated circuits provide some protection, but in many cases, ESD contains enough power to alter device parameters or melt silicon junctions.

A discharge of static electricity from a finger or other conductor can destroy static-sensitive devices or microcircuitry. Even if the spark is neither felt nor heard, damage might have occurred.

An electronic device exposed to ESD might not be affected at all and can work perfectly throughout a normal cycle. Or the device might function normally for a while, then degrade in the internal layers, reducing its life expectancy.

**⚠ CAUTION:** To prevent damage to the computer when removing or installing internal components, observe these precautions:

Keep components in their electrostatic-safe containers until you are ready to install them.

Use nonmagnetic tools.

Before touching an electronic component, discharge static electricity by using the guidelines described in this section.

Avoid touching pins, leads, and circuitry. Handle electronic components as little as possible.

If you remove a component, place it in an electrostatic-safe container.

The following table shows how humidity affects the electrostatic voltage levels generated by different activities.

**⚠ CAUTION:** A product can be degraded by as little as 700 V.

Typical electrostatic voltage levels			
Event	Relative humidity		
	10%	40%	55%
Walking across carpet	35,000 V	15,000 V	7,500 V
Walking across vinyl floor	12,000 V	5,000 V	3,000 V
Motions of bench worker	6,000 V	800 V	400 V
Removing DIPS from plastic tube	2,000 V	700 V	400 V
Removing DIPS from vinyl tray	11,500 V	4,000 V	2,000 V
Removing DIPS from Styrofoam	14,500 V	5,000 V	3,500 V
Removing bubble pack from PCB	26,500 V	20,000 V	7,000 V
Packing PCBs in foam-lined box	21,000 V	11,000 V	5,000 V

## Packaging and transporting guidelines

Follow these grounding guidelines when packaging and transporting equipment:

- To avoid hand contact, transport products in static-safe tubes, bags, or boxes.
- Protect ESD-sensitive parts and assemblies with conductive or approved containers or packaging.
- Keep ESD-sensitive parts in their containers until the parts arrive at static-free workstations.
- Place items on a grounded surface before removing items from their containers.
- Always be properly grounded when touching a component or assembly.
- Store reusable ESD-sensitive parts from assemblies in protective packaging or nonconductive foam.
- Use transporters and conveyors made of antistatic belts and roller bushings. Be sure that mechanized equipment used for moving materials is wired to ground and that proper materials are selected to avoid static charging. When grounding is not possible, use an ionizer to dissipate electric charges.

## Workstation guidelines

Follow these grounding workstation guidelines:

- Cover the workstation with approved static-shielding material.
- Use a wrist strap connected to a properly grounded work surface and use properly grounded tools and equipment.
- Use conductive field service tools, such as cutters, screwdrivers, and vacuums.
- When fixtures must directly contact dissipative surfaces, use fixtures made only of static-safe materials.
- Keep the work area free of nonconductive materials, such as ordinary plastic assembly aids and Styrofoam.
- Handle ESD-sensitive components, parts, and assemblies by the case or PCM laminate. Handle these items only at static-free workstations.
- Avoid contact with pins, leads, or circuitry.
- Turn off power and input signals before inserting or removing connectors or test equipment.

## Equipment guidelines

Grounding equipment must include either a wrist strap or a foot strap at a grounded workstation.

- When seated, wear a wrist strap connected to a grounded system. Wrist straps are flexible straps with a minimum of one megohm  $\pm 10\%$  resistance in the ground cords. To provide proper ground, wear a strap snugly against the skin at all times. On grounded mats with banana-plug connectors, use alligator clips to connect a wrist strap.
- When standing, use foot straps and a grounded floor mat. Foot straps (heel, toe, or boot straps) can be used at standing workstations and are compatible with most types of shoes or boots. On conductive floors or dissipative floor mats, use foot straps on both feet with a minimum of one megohm resistance between the operator and ground. To be effective, the conductive strips must be worn in contact with the skin.

The following grounding equipment is recommended to prevent electrostatic damage:

- Antistatic tape
- Antistatic smocks, aprons, and sleeve protectors
- Conductive bins and other assembly or soldering aids
- Nonconductive foam
- Conductive tabletop workstations with ground cords of one megohm resistance
- Static-dissipative tables or floor mats with hard ties to the ground
- Field service kits
- Static awareness labels
- Material-handling packages
- Nonconductive plastic bags, tubes, or boxes
- Metal tote boxes
- Electrostatic voltage levels and protective materials

The following table lists the shielding protection provided by antistatic bags and floor mats.

<b>Material</b>	<b>Use</b>	<b>Voltage protection level</b>
Antistatic plastic	Bags	1,500 V
Carbon-loaded plastic	Floor mats	7,500 V
Metallized laminate	Floor mats	5,000 V



# Component replacement procedures

This chapter provides removal and replacement procedures.

There are as many as 78 screws, in 8 different sizes, that must be removed, replaced, or loosened when servicing the computer. Make special note of each screw size and location during removal and replacement.

## Serial number

The serial number label, located in the battery bay of the computer, provides important information that you may need when contacting technical support.

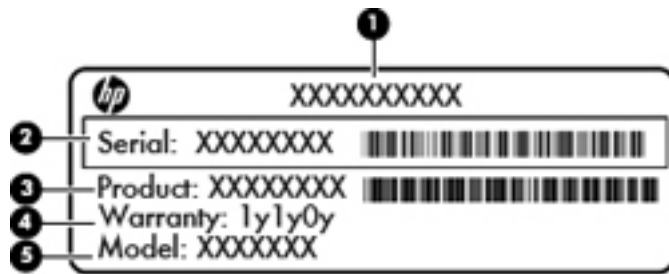

---

(1) Product name	(4) Warranty period
(2) Serial number	(5) Model description
(3) Product number	

---

## Computer feet

Description	Spare part number
Rubber Feet Kit	639572-001

The computer feet are adhesive-backed rubber pads. The feet attach to the base enclosure in the locations illustrated below.



## Battery

Description	Spare part number
6 cell, 2.20 Ah, 47 Wh	593553-001
6 cell, 2.55 Ah, 55 Wh	593554-001

Before disassembling the computer:

1. Shut down the computer. If you are unsure whether the computer is off or in Hibernation, turn on the computer, and then shut it down through the operating system.
2. Disconnect all external devices connected to the computer.
3. Disconnect the power from the computer by first disconnecting the power cord from the AC outlet and then disconnecting the AC adapter from the computer.

Remove the battery:

1. Turn the computer upside down on a flat surface.
2. Slide the battery release latch **(1)** to release the battery.
3. Pivot the battery **(2)** upward and lift it out of the computer **(3)**.



To insert the battery, insert the rear edge of the battery into the battery bay and pivot the front edge downward until the battery is seated. The battery release latch automatically locks the battery into place.

## Service door

Description	Spare part number
Plastics Kit (contains only the service door)	640889-001

Before removing the service door, remove the battery (see [Battery on page 43](#)).

1. Position the computer upside down, with the front toward you.
2. Loosen the two Phillips 4.0 x 2.0 captive screws **(1)** that secure the service door to the computer.
3. Remove the service door **(2)**.

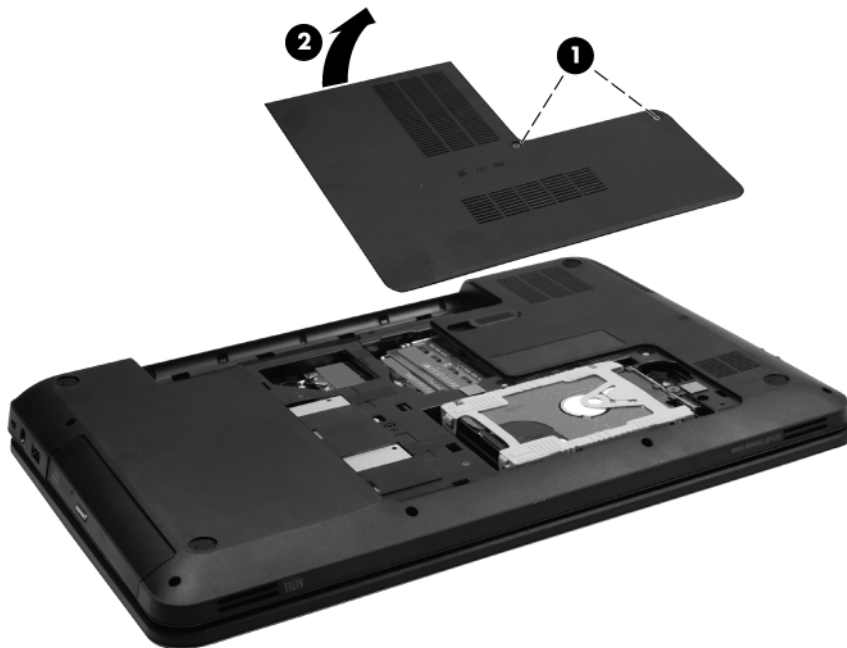

Reverse this procedure to install the service door.

## Hard drive

 **NOTE:** The hard drive spare part kit includes a hard drive bracket and hard drive connector. The hard drive bracket and hard drive connector, as well as the hard drive bracket screws, are also available in the Hard Drive Hardware Kit.

Description	Spare part number
Supports the following <b>9.50 mm, 6.35 cm</b> (2.5 in) SATA hard drives:	
750 GB, 5400 rpm	634250-001
640 GB, 5400 rpm	603785-001
500 GB, 7200 rpm	634925-001
500 GB, 5400 rpm	634638-001
Supports the following <b>9.5 mm / 7.0 mm, 6.35 cm</b> (2.5 in) SATA hard drives:	
320 GB, 7200 rpm	634862-001
250 GB, 7200 rpm	634861-001
Hard Drive Hardware Kit (not illustrated, includes connector, bracket, and screws)	640878-001

Before removing the hard drive, remove the following components:

1. Battery (see [Battery on page 43](#))
2. Service door (see [Service door on page 44](#))

Remove the hard drive:

1. Use the rubber tab on the hard drive bracket **(1)** to move the hard drive to the left and disconnect it from the hard drive adapter.

2. Lift the hard drive **(2)** out of the hard drive bay.

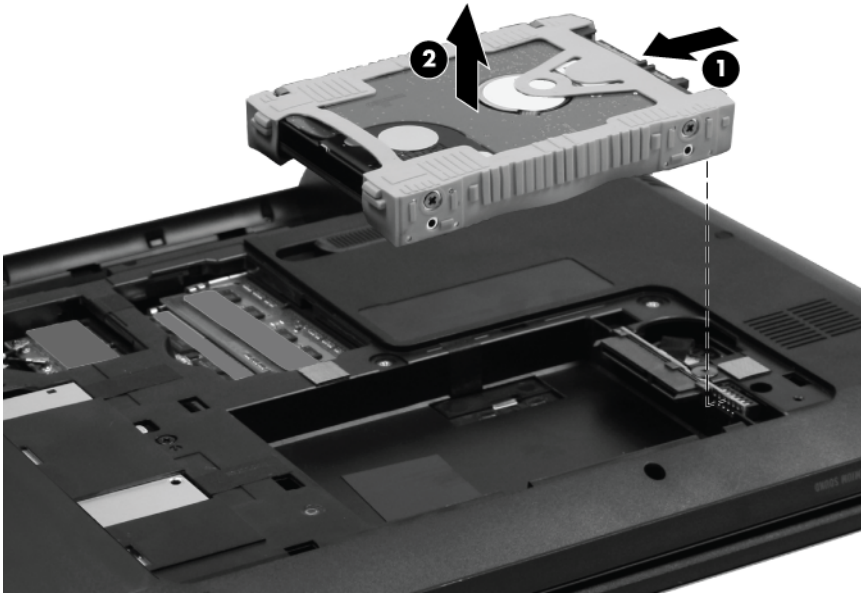

3. To replace the hard drive bracket, remove the four Phillips 3.0x3.0 screws **(1)** that secure the hard drive bracket to the hard drive.
4. Pull the bracket **(2)** straight up to remove it from the hard drive.

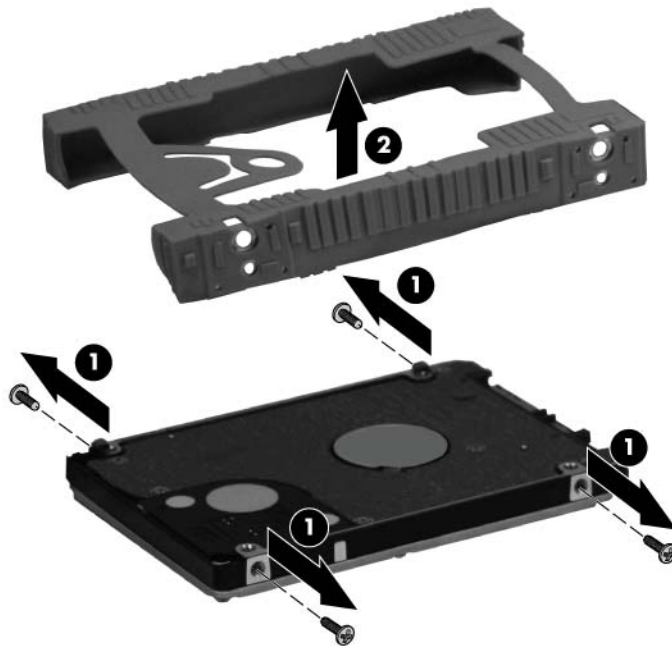

5. To replace the hard drive adapter, remove the Phillips pan head 2.0 x 2.0 screw **(1)**, and then disconnect the adapter from the system board at the outside edge **(2)**.

6. Then lift the adapter out at a 45-degree angle **(3)**.

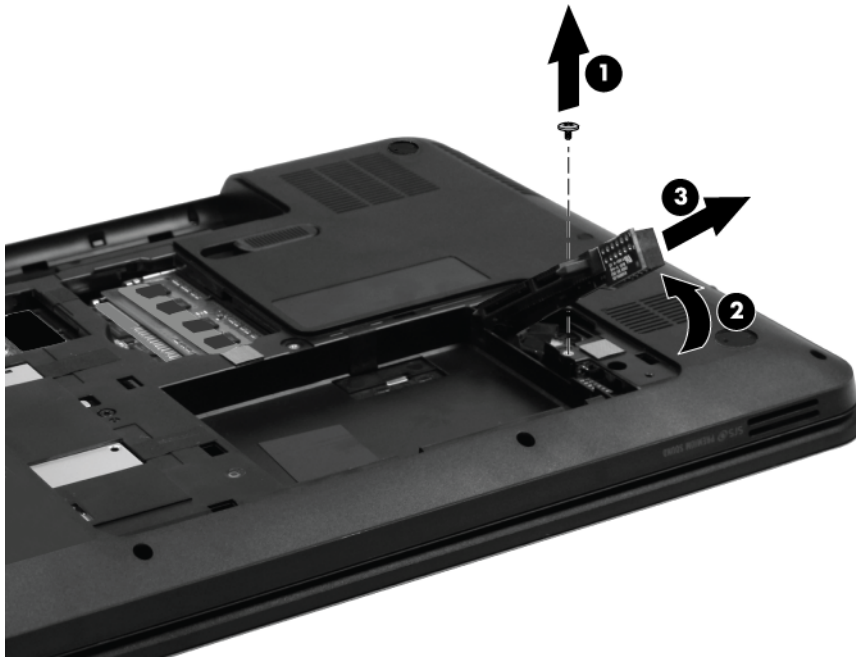

Reverse this procedure to install the hard drive.

## Optical drive

 **NOTE:** The optical drive spare part kit includes an optical drive bezel and optical drive bracket.

Description	Spare part number
DVD±RW and CD-RW SuperMulti Double-Layer Combo Drive	660833-001
Blu-ray Disc ROM DVD±R/RW SuperMulti Double-Layer Drive	663683-001
Optical Drive protective insert	659360-001

Before removing the optical drive:

1. Battery (see [Battery on page 43](#))
2. Service door (see [Service door on page 44](#))

Remove the optical drive:

1. Remove the Phillips 6.0 x 2.5 screw **(1)** that secures the optical drive to the computer.
2. Insert a straightened paper clip **(2)**, into the release access opening in the bezel, and then press inward.
3. Grasp the bezel and slide the optical drive out of the computer **(3)**.



4. To replace the optical drive bracket, position the optical drive with the optical drive bracket toward you.
5. Remove the two Phillips 3.0 x 2.0 screws **(1)** that secure the optical drive bracket to the optical drive.



6. Remove the optical drive bracket **(2)**.



Reverse the above procedure to reassemble and install the optical drive.

## WLAN module

Description	Spare part number
Atheros 9285G 802.11b/g/n WiFi Adapter	580101-001
Broadcom 4313GN 802.11b/g/n 1x1 WiFi and 2070 Bluetooth 2.1+EDR Combo Adapter	600370-001
Intel Centrino Wireless-N 1030 + Bluetooth (802.11 b/g/n)	631956-001
Intel Centrino Wireless-N 1000 (802.11 b/g/n)	593530-001
Ralink 5390GN 802.11b/g/n 1x1 WiFi Adapter	630703-001
Ralink 5390BC8 802.11b/g/n 1x1 WiFi and Bluetooth 3.0+HS Combo Adapter	630705-001
Realtek 8188GN 802.11b/g/n 1x1 WiFi Adapter	640926-001
Realtek 8188BC8 802.11a/b/g/n 2x2 WiFi and Bluetooth 3.0+HS Combo Adapter	602993-001
Atheros AR9002WB-1NGB 802.11b/g/n 1x1 WiFi and Bluetooth 2.1+EDR Combo Adapter	593127-001
Atheros 9485GN 802.11b/g/n 1x1 WiFi and 3012 Bluetooth 4.0 Combo Adapter	655795-001
Broadcom 4313GN 802.11b/g/n 1x1 WiFi and 20702 Bluetooth 4.0 Combo Adapter	657325-001

Before removing the WLAN module, remove the following components:

1. Battery (see [Battery on page 43](#))
2. Service door (see [Service door on page 44](#))

Remove the WLAN module:

1. Disconnect the main antenna cable **(1)** and the auxiliary antenna cable **(2)** from the wireless module.
2. Remove the two Phillips 3.0 x 2.0 screws **(3)** that secure the WLAN module to the computer. (The edge of the module opposite the slot rises away from the computer.)

3. Remove the WLAN module **(4)** by pulling it away from the slot at an angle.

**⚠ CAUTION:** To prevent an unresponsive system, replace the wireless module only with a wireless module authorized for use in the computer by the governmental agency that regulates wireless devices in your country or region. If you replace the module and then receive a warning message, remove the module to restore computer functionality, and then contact technical support through Help and Support.

**📝 NOTE:** WLAN modules are designed with a notch **(5)** to prevent incorrect insertion into the WLAN module slot.

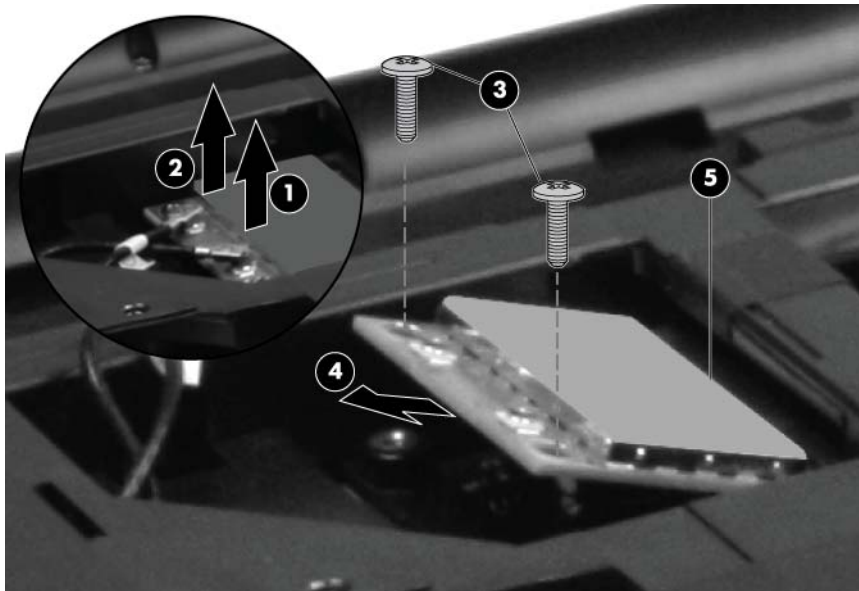

Reverse this procedure to install a WLAN module.

## Memory module

Description	Spare part number
4 GB PC3 10600 1333 MHz shared	621569-001
2 GB PC3 10600 MHz	581096-001
1 GB PC3 10600 1333 MHz shared	639738-001

Before removing the memory module, remove the following components:

1. Battery (see [Battery on page 43](#))
2. Service door (see [Service door on page 44](#))

Remove the memory module:

1. Spread the retaining tabs **(1)** on each side of the memory module slot to release the memory module. (The edge of the module opposite the slot rises away from the computer.)
2. Remove the module **(2)** by pulling it away from the slot at an angle.

 **NOTE:** Memory modules are designed with a notch **(3)** to prevent incorrect insertion into the memory module slot.

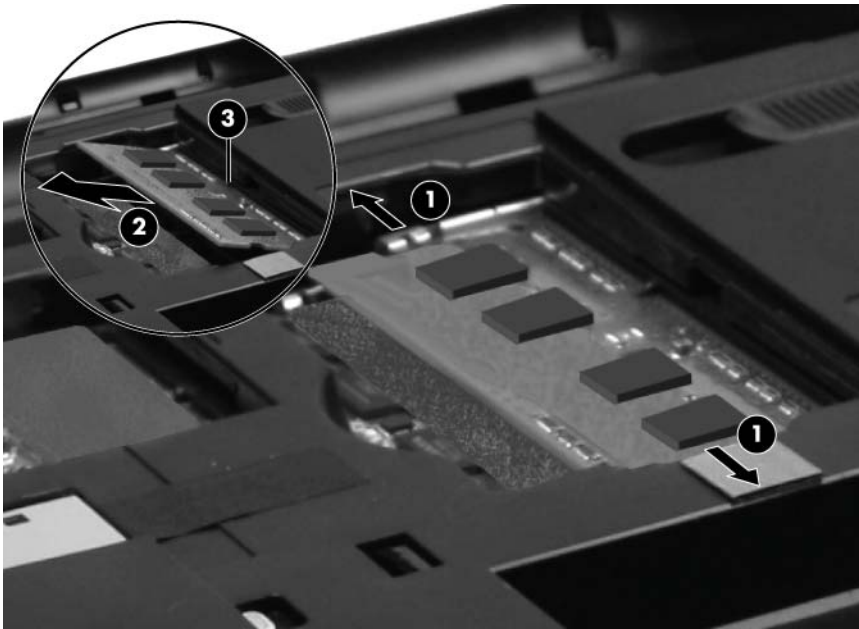

Reverse this procedure to install a memory module.

## RTC battery

Description	Spare part number
RTC battery (includes mounting adhesive)	449137-001

Before removing the RTC battery, remove the following components:

1. Battery (see [Battery on page 43](#))
2. Service door (see [Service door on page 44](#))

Remove the RTC battery:

1. Use a sharp, nonconductive tool to release the clip **(1)** that secures the battery to the system board.
2. Lift the battery **(2)** out of the computer.

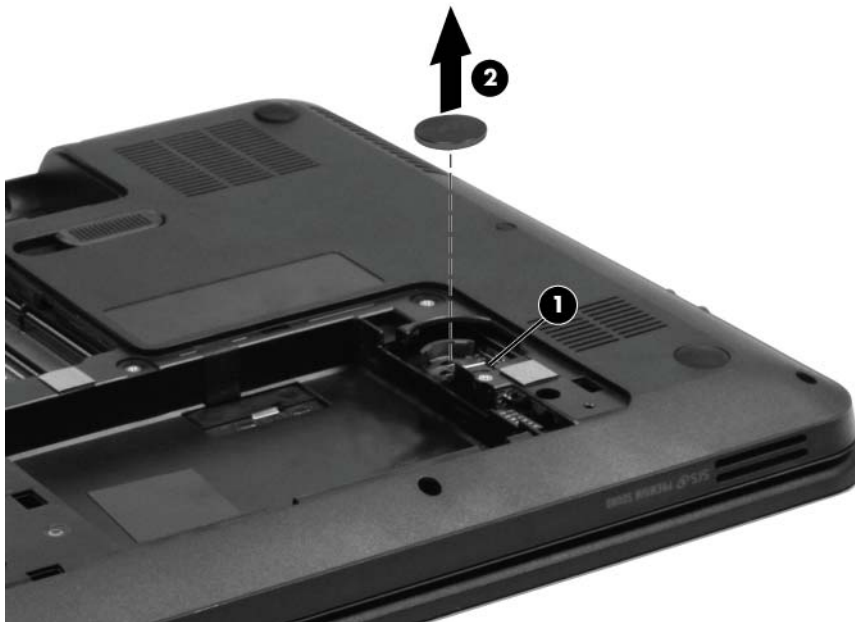

Reverse this procedure to install the RTC battery.

# Keyboard

Description	Spare part number
For use in the United States, Black	640892-001
For use in French Canada, Black	640892-121
For use in the United States, White	653390-001
For use in Latin America, White	653390-161

Before removing the keyboard, remove the following components:

1. Battery (see [Battery on page 43](#))
2. Service door (see [Service door on page 44](#))

Remove the keyboard:

1. Remove the Phillips 4.0 x 2.5 screw **(1)** in the WLAN module bay that secures the keyboard to the computer.
2. Using a thin, flat-bladed screwdriver, gently pry loose the three snaps **(2)** inside the battery bay to release the top edge keyboard tabs.

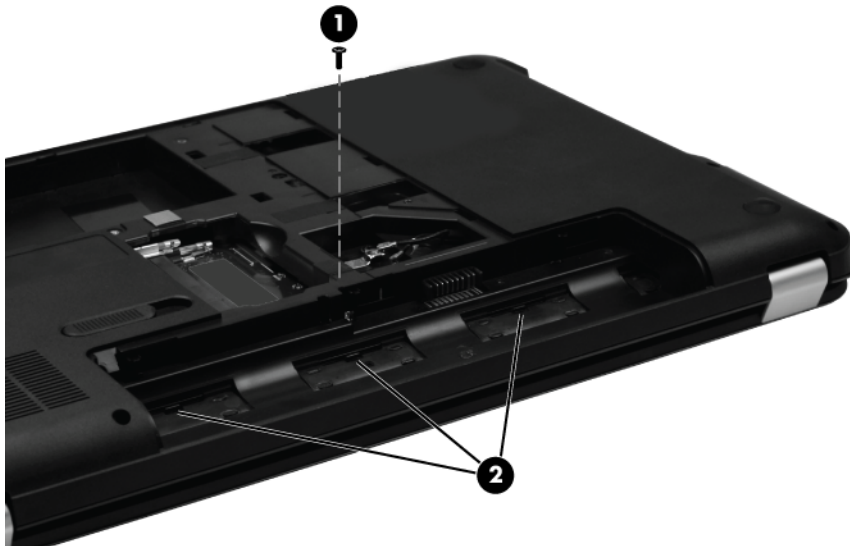

3. Turn the computer right-side up, with the front toward you.
4. Open the computer as far as possible.
5. Lift the rear edge of the keyboard, and then tilt the keyboard forward onto the palm rest **(1)**.
6. Release the zero insertion force (ZIF) connector **(2)** to which the keyboard cable is attached, and then disconnect the keyboard cable **(3)** from the system board.

7. Remove the keyboard **(4)**.



Reverse this procedure to install the keyboard.

## Top cover

Description	Spare part number
For use in Luminous Rose computer models	639528-001
For use in Sweet Purple computer models	639529-001
For use in Pewter computer models	639531-001
For use in Charcoal Grey computer models	639532-001
For use in Sonoma Red computer models	639533-001
For use in Pacific Blue computer models	639534-001
For use in White computer models	653391-001

Before removing the top cover, remove the following components:

1. Battery (see [Battery on page 43](#))
2. Service door (see [Service door on page 44](#))
3. Hard drive (see [Hard drive on page 45](#)).
4. Optical drive (see [Optical drive on page 48](#)).
5. WLAN module (see [WLAN module on page 50](#)).
6. Memory module (see [Memory module on page 52](#)).
7. Keyboard (see [Keyboard on page 54](#)).

Remove the top cover:

1. Turn the computer right-side up, with the front toward you, and open the computer as far as possible.



2. Release the three ZIF connectors **(1)** to which the ZIF cables are attached and disconnect the USB cable **(2)**, TouchPad cable **(3)**, and power button cable **(4)** from the system board.



3. Remove the six Phillips 4.0 x 2.5 screws that secure the top cover to the computer.



4. Close the computer and turn it upside down, with the front toward you.

5. Remove the three Phillips 3.0 x 2.0 screws in the battery bay, two Phillips 3.0 x 2.0 screws in the optical drive bay, and ten Phillips 6.0 x 2.5 on the base enclosure.

 **NOTE:** The four screws along the front edge also serve to secure the speakers inside the base enclosure.

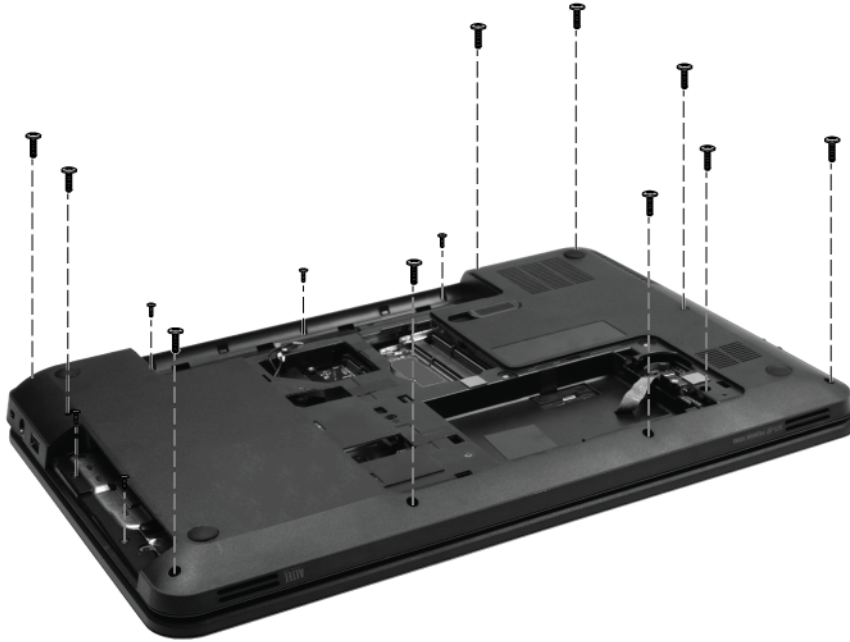

6. Lift the rear edge of the top cover **(1)** until the top cover disengages from the base enclosure. Remove the top cover **(2)**.



 **NOTE:** The TouchPad is glued to the top cover and is included with the top cover spare part.

Reverse this procedure to install the top cover.

## Power button board

Description	Spare part number
Power button board	640884-001

Before removing the power button board, remove the following components:

1. Battery (see [Battery on page 43](#))
2. Service door (see [Service door on page 44](#))
3. Hard drive (see [Hard drive on page 45](#))
4. Optical drive (see [Optical drive on page 48](#))
5. WLAN module (see [WLAN module on page 50](#)).
6. Memory module (see [Memory module on page 52](#))
7. Keyboard (see [Keyboard on page 54](#))
8. Top cover (see [Top cover on page 56](#))

Remove the power button board:

1. Turn the top cover upside down with the rear edge toward you.
2. Remove the Phillips 3.0 x 2.0 screw **(1)** that secures the power button board to the top cover.
3. Lift up and remove the power button board **(2)**.

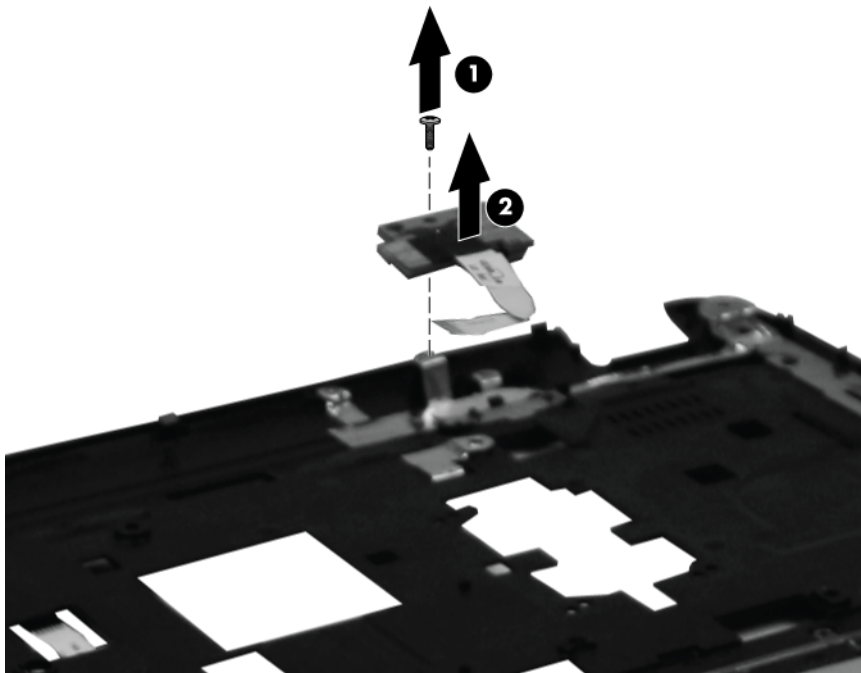

Reverse this procedure to install the power button board.

## Speaker assembly

Description	Spare part number
Speaker assembly (includes cable)	639573-001

Before removing the speaker assembly, remove the following components:

1. Battery (see [Battery on page 43](#))
2. Service door (see [Service door on page 44](#))
3. Hard drive (see [Hard drive on page 45](#))
4. Optical drive (see [Optical drive on page 48](#))
5. Keyboard (see [Keyboard on page 54](#))
6. Top cover (see [Top cover on page 56](#))

Remove the speaker assembly:

1. Disconnect the speaker cable **(1)** from the system board.
2. Lift up and remove the speakers **(2)**.

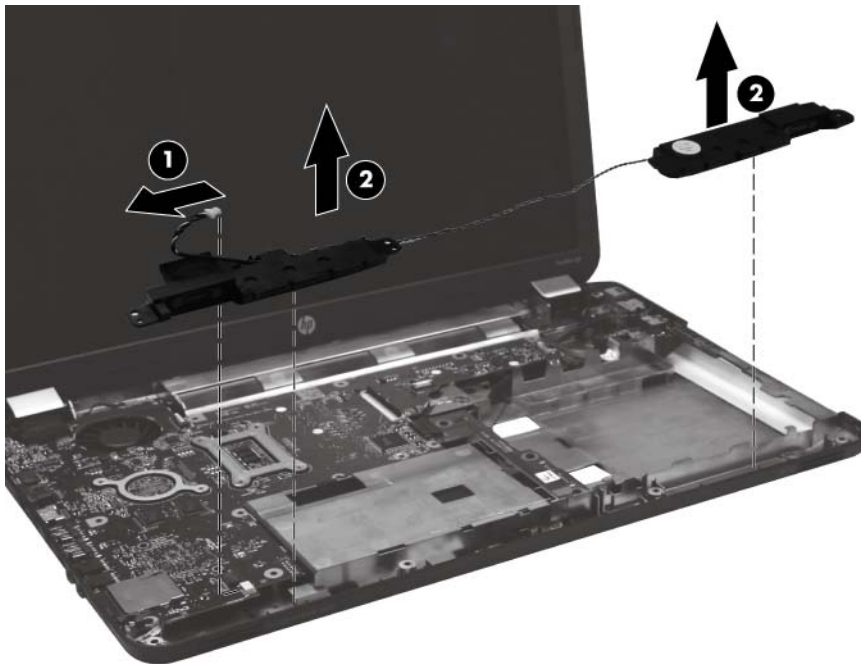

Reverse this procedure to install the speaker assembly.

## TouchPad button board

Description	Spare part number
TouchPad button board (includes bracket and cable)	640885-001

Before removing the TouchPad button board, remove the following components:

1. Battery (see [Battery on page 43](#))
2. Service door (see [Service door on page 44](#))
3. Hard drive (see [Hard drive on page 45](#))
4. Optical drive (see [Optical drive on page 48](#))
5. Keyboard (see [Keyboard on page 54](#))
6. Top cover (see [Top cover on page 56](#))

Remove the TouchPad button board:

1. Release the ZIF connector **(1)** to which the TouchPad button board cable is attached, and then disconnect the cable **(2)** from the TouchPad.
2. Slide the TouchPad bracket to the left **(3)** and then remove it.
3. Remove the TouchPad button board **(4)**.

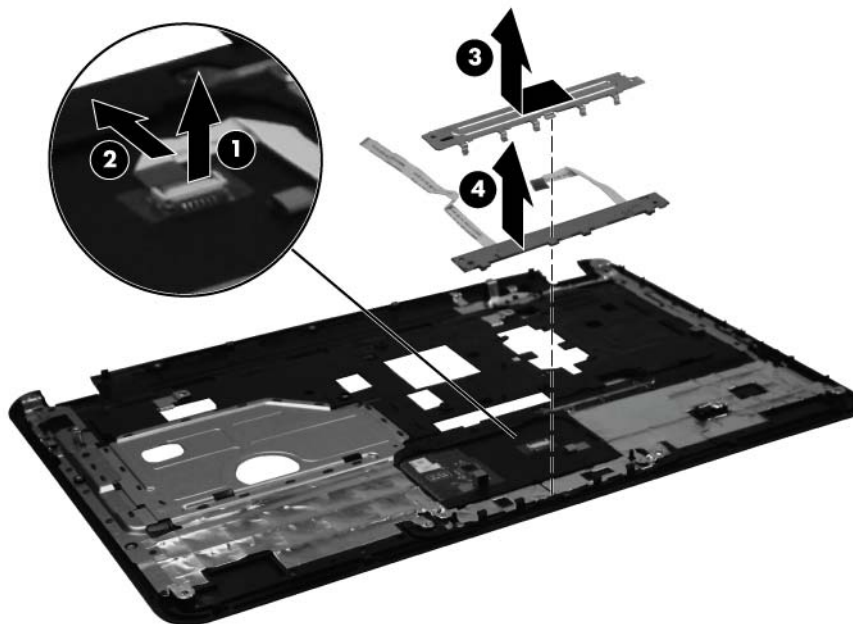

Reverse the above procedure to reassemble and install the TouchPad button board.

## USB board

Description	Spare part number
USB board	640883-001

Before removing the USB board, remove the following components:

1. Battery (see [Battery on page 43](#))
2. Service door (see [Service door on page 44](#))
3. Hard drive (see [Hard drive on page 45](#))
4. Optical drive (see [Optical drive on page 48](#))
5. Keyboard (see [Keyboard on page 54](#))
6. Top cover (see [Top cover on page 56](#))

Remove the USB board:

1. Position the computer right-side up, with the right side toward you.
2. Release the clips **(1)** that secure the USB board to the base enclosure.
3. Lift the USB board **(2)** straight up to remove it from the computer.

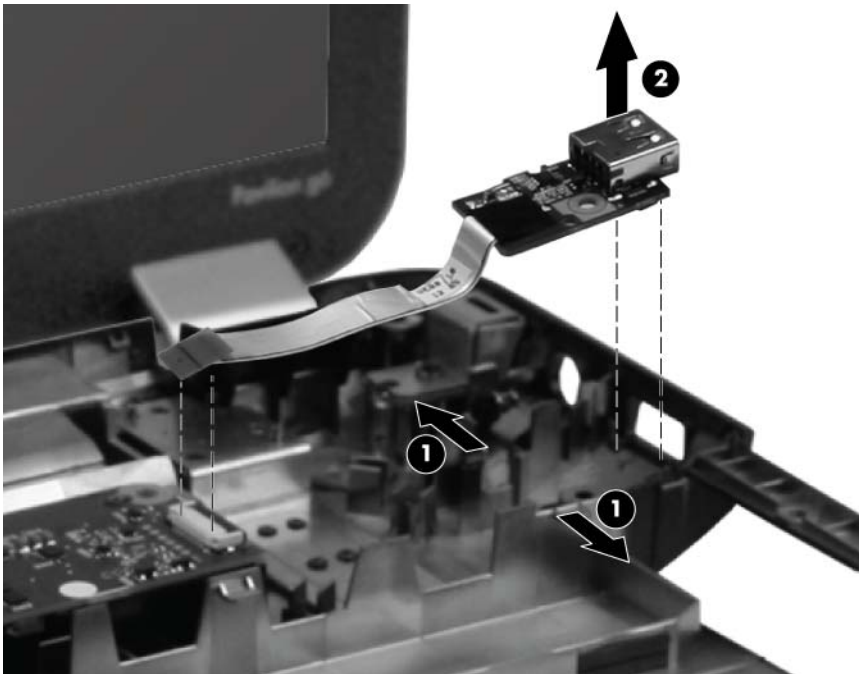

Reverse this procedure to install the USB board.



## Security cable lock

 **NOTE:** The security cable lock is included with the base enclosure, spare part number 639569-001.

Before removing the security cable lock, remove the following components:

1. Battery (see [Battery on page 43](#))
2. Service door (see [Service door on page 44](#))
3. Hard drive (see [Hard drive on page 45](#))
4. Optical drive (see [Optical drive on page 48](#))
5. Keyboard (see [Keyboard on page 54](#))
6. Top cover (see [Top cover on page 56](#))

Remove the security cable lock:

1. Remove the two Phillips 4.0 x 2.5 screws that secure the security lock to the base enclosure.
2. Lift the security lock straight up to remove it from the computer.

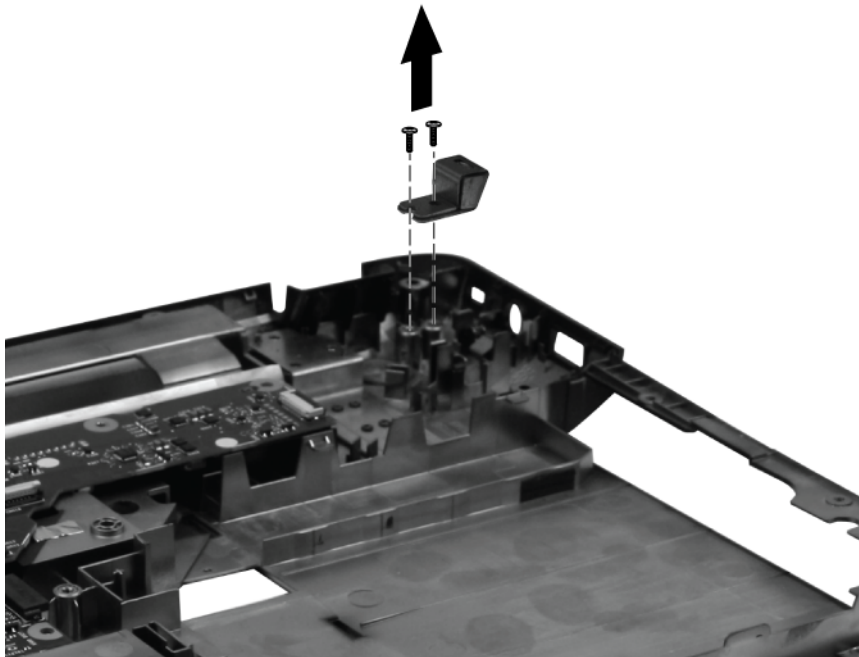

Reverse this procedure to install the security cable lock.

## Power connector

Description	Spare part number
Power connector (includes cable)	640891-001

Before removing the power connector cable, remove the following components:

1. Battery (see [Battery on page 43](#))
2. Service door (see [Service door on page 44](#))
3. Hard drive (see [Hard drive on page 45](#))
4. Optical drive (see [Optical drive on page 48](#))
5. Keyboard (see [Keyboard on page 54](#))
6. Top cover (see [Top cover on page 56](#))

Remove the power connector:

1. Turn the computer right-side up, with the right side toward you.
2. Disconnect the power connector cable **(1)** from the system board.
3. Lift the power connector **(2)** from the clips built into the base enclosure.

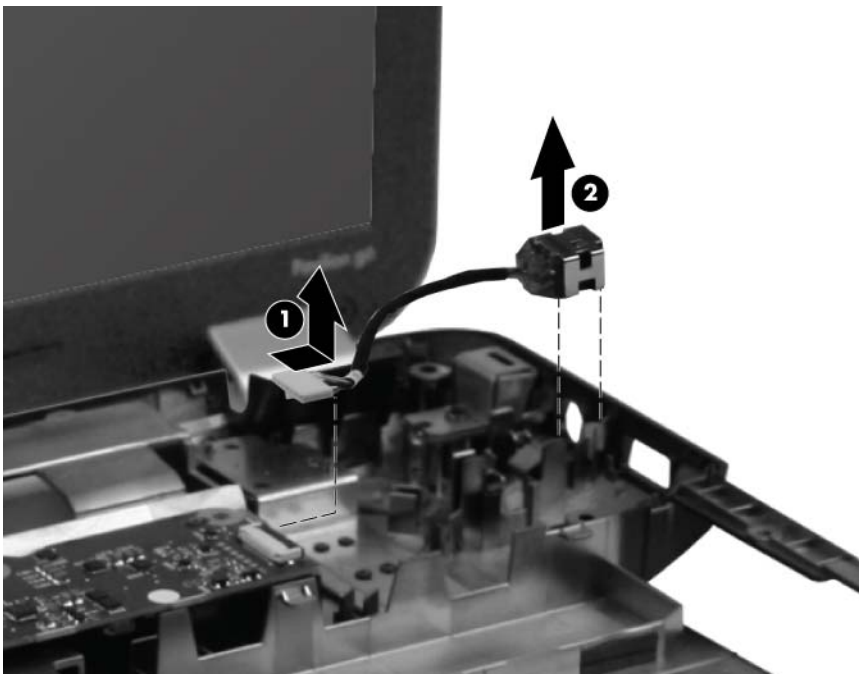

Reverse this procedure to install the power connector.

## Display assembly

Description	Spare part number
<b>39.6-cm</b> (15.6-in) High Definition (HD), LED BrightView display assembly:	
• For use in Charcoal Grey computer models	639512-001
• For use in Sonoma Red computer models	639514-001
• For use in Luminous Rose computer models	639515-001
• For use in Pewter computer models	639516-001
• For use in Pacific Blue computer models	639517-001
• For use in Sweet Purple computer models	639519-001
• For use in White computer models	653389-001

Before removing the display assembly, remove the following components:

1. Battery (see [Battery on page 43](#))
2. Service door (see [Service door on page 44](#))
3. Optical drive (see [Optical drive on page 48](#))
4. WLAN module (see [WLAN module on page 50](#))
5. Keyboard (see [Keyboard on page 54](#))
6. Top cover (see [Top cover on page 56](#))
7. USB board (see [USB board on page 64](#))

Remove the display assembly:

1. Turn the computer right-side up, with the front toward you.
2. Open the computer as far as possible.
3. Disconnect the display panel cable **(1)** from the system board and remove it from its routing channel.
4. Pull the antenna cables through the opening in the base enclosure **(2)**, and then disengage the cables from the clip in the routing channel leading to the display hinge.

 **CAUTION:** Support the display assembly when removing the display screws in the following steps. Failure to support the display assembly can result in damage to the assembly and other components.

5. Remove the five Phillips 6.0 x 2.5 screws **(3)** that secure the display assembly to the computer.

6. Lift the display panel **(4)** straight up to remove it.

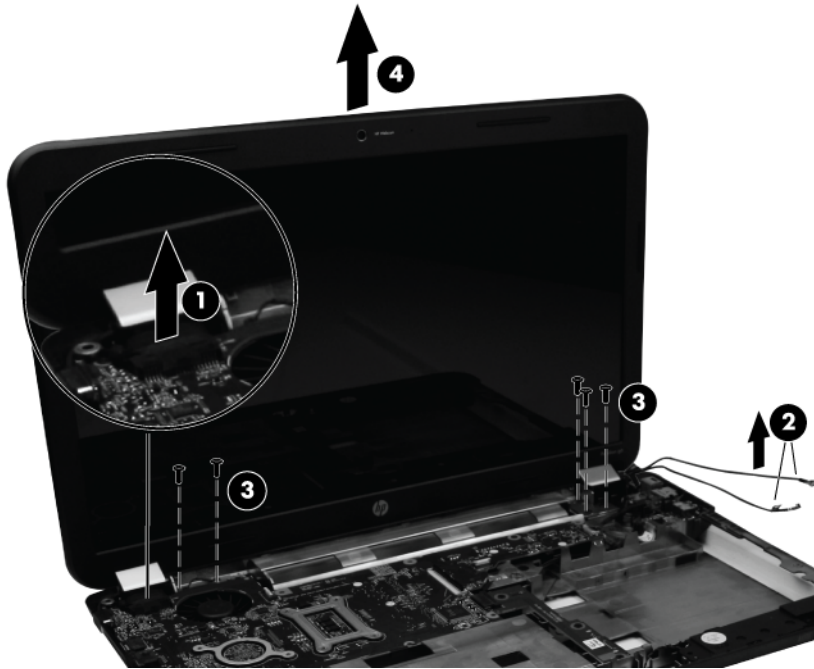

Reverse this procedure to install the display assembly.

7. To replace any of the display assembly internal components, remove the following screw covers and screws:

**(1)** Two Mylar screw covers on the display bezel bottom edge

**(2)** Two Phillips 4.0 x 2.5 screws

The display screw covers are included in the Display Rubber Kit, spare part number 640882-001.

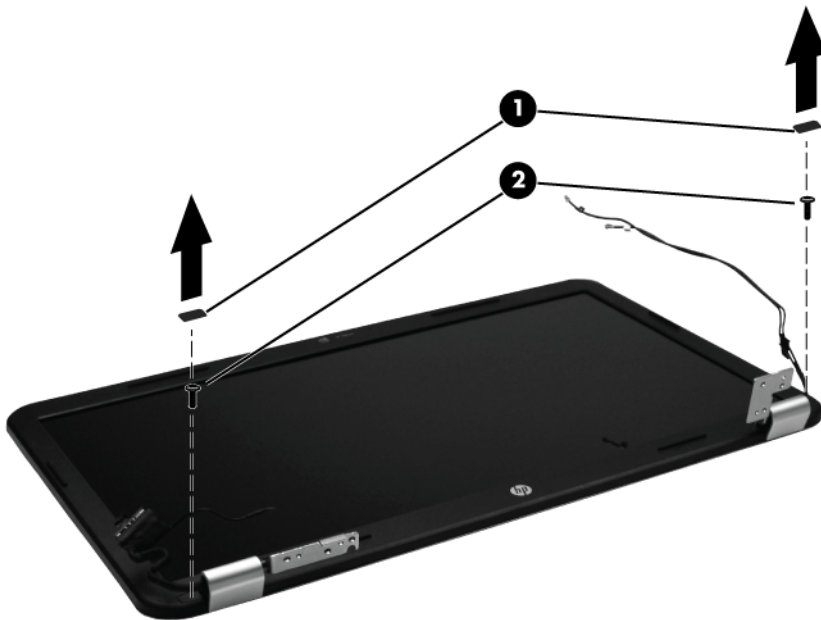

8. Flex and lift up on the inside edges of the bezel on the left side **(1)**, the top and bottom **(2)**, and the right side **(3)** until the bezel disengages from the display back cover.
9. Remove the display bezel **(4)**.

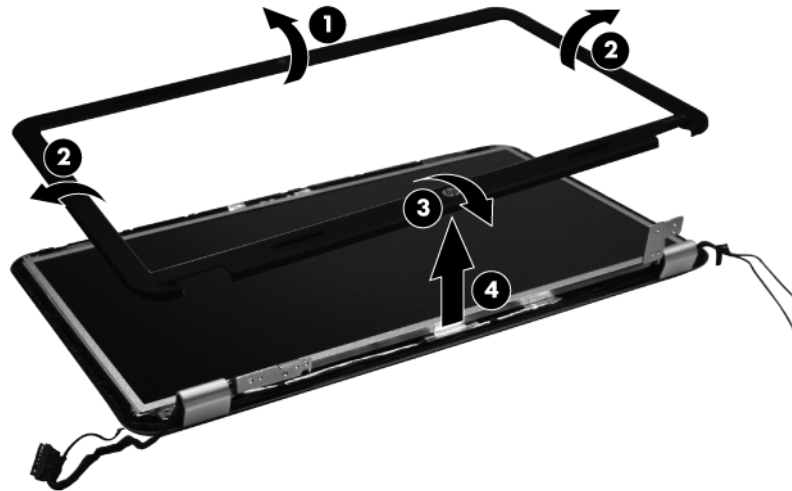

Reverse this procedure to install the display bezel.

10. To replace the webcam module, lift the webcam module as far from the display enclosure as the webcam module cable allows.
11. Disconnect the webcam module cable **(1)** from the webcam module, and then remove the webcam module **(2)**. The webcam module is available using spare part number 640880-001.



Reverse this procedure to install the webcam module.

12. To replace the display hinge covers, remove the three Phillips 4.0 x 2.5 screws **(1)** that secure the covers to the display enclosure.
13. Remove the display hinge covers **(2)**. The display hinge covers are available using spare part number 640887-001.

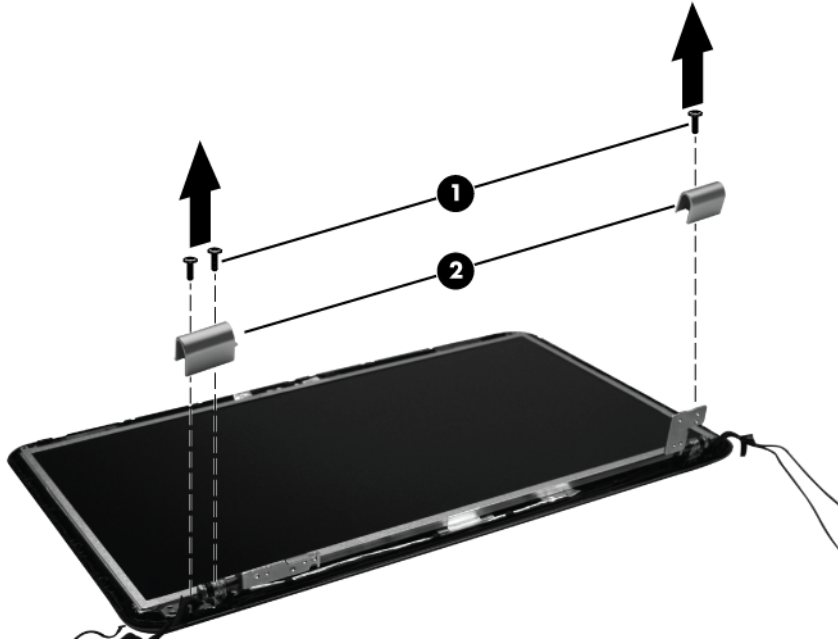

Reverse this procedure to install the display hinge covers.

14. To replace the display panel, remove five Phillips 4.0 x 2.5 screws **(1)** that secure the display panel to the display enclosure.

15. Remove the display panel **(2)** from the display enclosure. The display panel is available using the spare part number 641663-001.

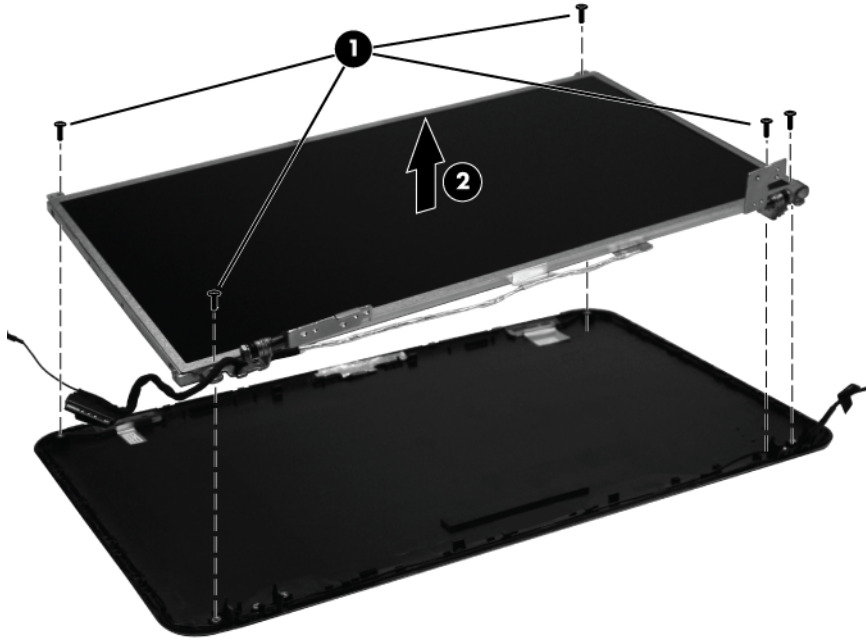

Reverse this procedure to install the display panel.

16. To replace the display hinges, remove the two Phillips PM 3.0 x 2.0 screws **(1)** that secure each hinge to the display panel.
17. Remove the display hinges **(2)** from the display panel. The display hinges are available using spare part number 639511-001.

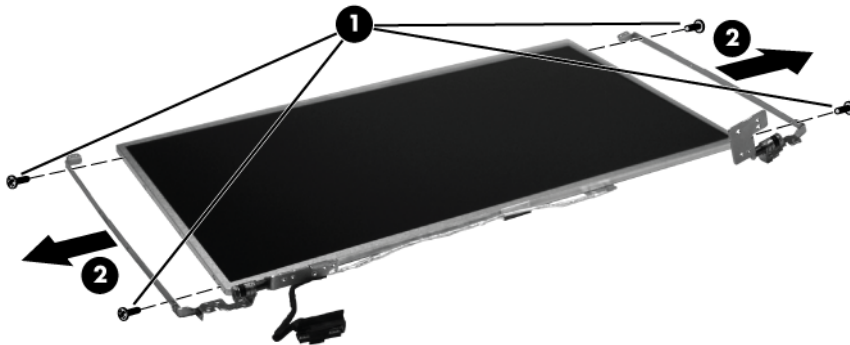

Reverse this procedure to install the display hinges.

18. To replace the wireless antenna transceivers, lift up on the silver transceiver **(1)**, and then release the adhesive material from the display cover.

- 19.** Lift up to remove the antenna transceivers **(2)**. The wireless antenna transceivers and cable are available using spare part number 639499-001.

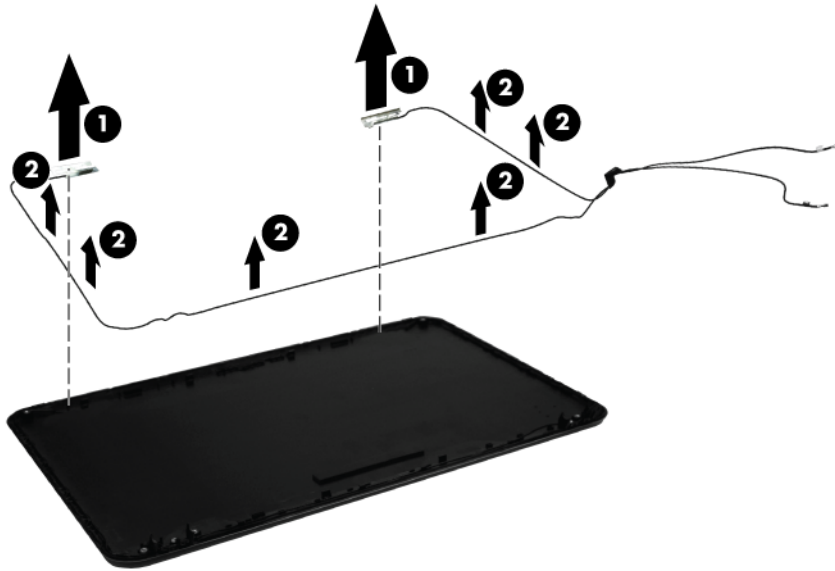

Reverse this procedure to install the display wireless antenna transceivers.

- 20.** To remove the display cable from the display panel, lift the tape **(1)**, and disconnect the cable **(2)**. Then, gently peel the cable away from the display panel **(3)**.

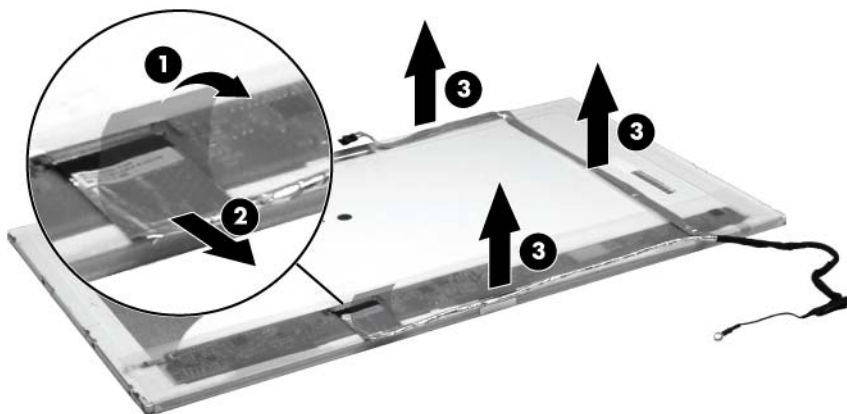

Reverse this procedure to install the display panel.



## System board



**NOTE:** The system board spare part kit includes UMA or discrete graphics subsystem memory and replacement thermal material.

Description	Spare part number
For use in Intel HM55 UMA computer models	639521-001
For use in Intel HM65 UMA computer models	639522-001
For use in Intel HM55 discrete, 512 MB, computer models	639523-001
For use in Intel HM55 discrete, 1 GB, computer models	639524-001
For use in Intel HM65 discrete, 512 MB, computer models	639525-001
For use in Intel HM65 discrete, 1 GB, computer models	639526-001
For use in AMD UMA computer models	640893-001
For use in AMD E350 UMA computer models	646738-001
For use in AMD A60M UMA computer models	649288-001
For use in Intel HM55 i3-370M UMA computer models.	653087-001
For use in AMD E450 UMA computer models	657146-001
For use in Intel HM65 UMA 1.1 computer models	657459-001
For use in Intel HM65 discrete 512MB computer models	657461-001
For use in Intel HM65 discrete 1GB computer models	657462-001
For use in AMD 880M computer models	668360-001

When replacing the system board, be sure that the following components are removed from the defective system board and installed on the replacement system board:

- Memory modules (see [Memory module on page 52](#))
- WLAN module (see [WLAN module on page 50](#))

Before removing the system board, remove the following components:

1. Battery (see [Battery on page 43](#))
2. Service door (see [Service door on page 44](#))
3. Hard drive (see [Hard drive on page 45](#))
4. Optical drive (see [Optical drive on page 48](#))
5. WLAN module (see [WLAN module on page 50](#))
6. Memory module (see [Memory module on page 52](#))
7. Keyboard (see [Keyboard on page 54](#))

8. Top cover (see [Top cover on page 56](#))
9. USB board (see [USB board on page 64](#))
10. Display assembly (see [Display assembly on page 67](#))
11. Power connector (see [Power connector on page 66](#))

Remove the optical drive connector board:

1. Turn the computer right-side up, with the front toward you.
2. Remove the three Phillips 4.0 x 2.5 screws **(1)** that secure the optical drive connector board to the computer.
3. Move the optical drive connector board **(2)** to the right, and then lift it up to disconnect it from the system board.

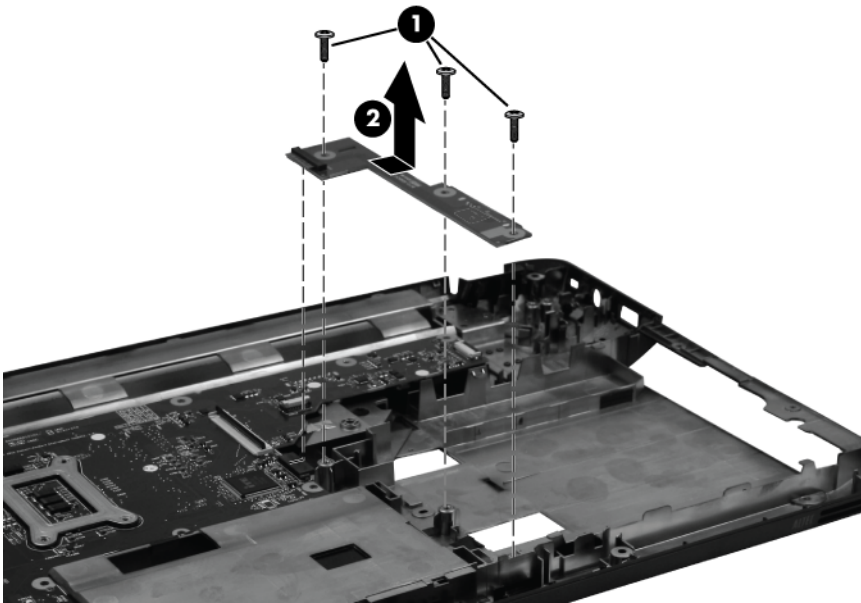

Reverse this procedure to install the optical drive connector board.

4. Remove the three Phillips 3.0 x 2.0 screws **(1)** that secure the system board to the computer.

5. Lift the system board **(2)** from the right edge and pull it away from the base enclosure at an angle.  
For AMD computer models, see the following image.

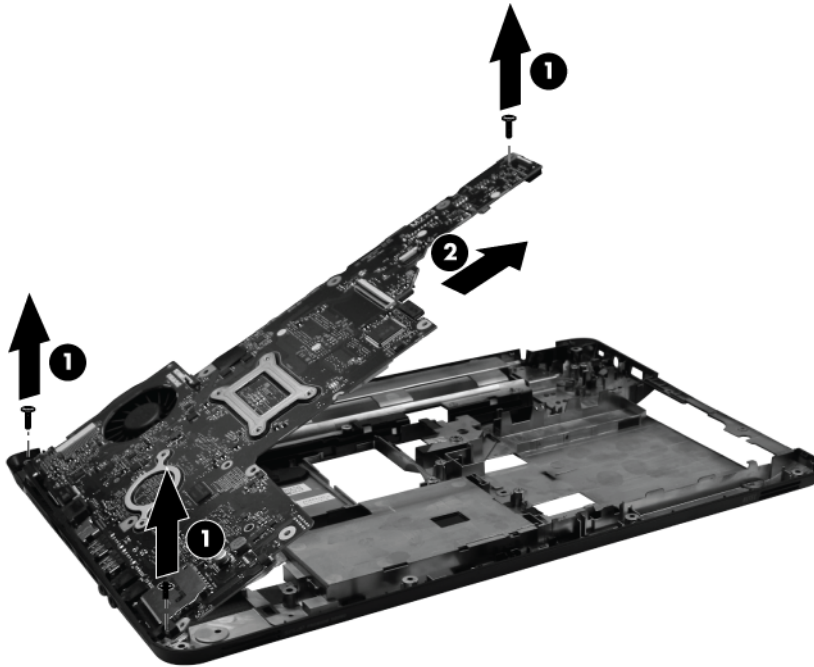

For Intel computer models, see the following image.

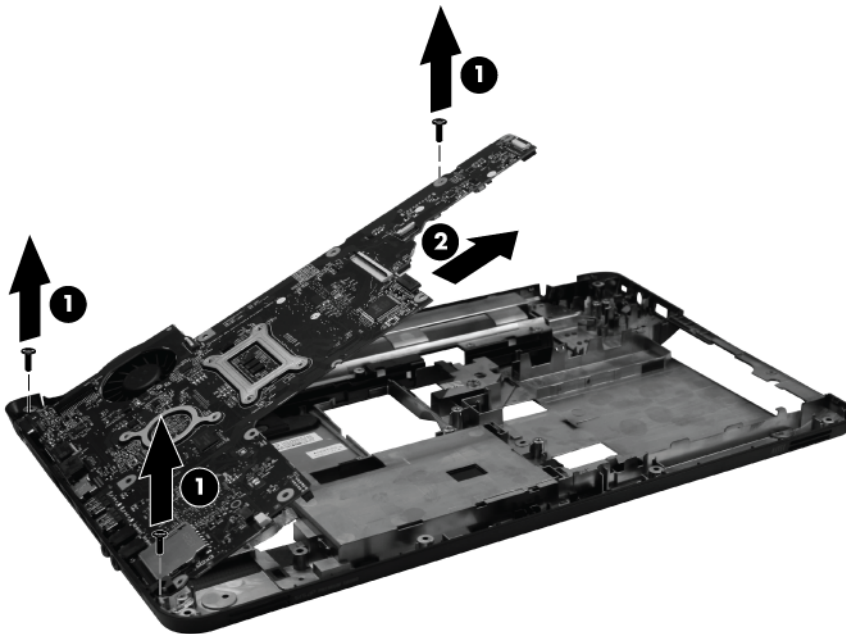

When replacing the system board, be sure that the following components are removed from the defective system board and installed on the replacement system board:

- Fan/heat sink assembly (see [Fan/heat sink assembly on page 77](#))
- Processor (see [Processor on page 81](#))

Reverse the disassembly procedure to install the system board.

## Fan/heat sink assembly



**NOTE:** The fan/heat sink assembly includes replacement thermal material.

Description	Spare part number
For use in AMD UMA computer models	640896-001
For use in Intel UMA computer models	641024-001
For use in Intel discrete computer models	641025-001
For use in AMD A60M UMA computer models	657143-001
For use in AMD A50M UMA computer models	657145-001

Before removing the fan/heat sink assembly, remove the following components:

1. Battery (see [Battery on page 43](#))
2. Service door (see [Service door on page 44](#))
3. Hard drive (see [Hard drive on page 45](#))
4. Optical drive (see [Optical drive on page 48](#))
5. WLAN module (see [WLAN module on page 50](#))
6. Memory module (see [Memory module on page 52](#))
7. Keyboard (see [Keyboard on page 54](#))
8. Top cover (see [Top cover on page 56](#))
9. USB board (see [USB board on page 64](#))
10. Display assembly (see [Display assembly on page 67](#))
11. Power connector (see [Power connector on page 66](#))
12. System board (see [System board on page 73](#))

Remove the fan/heat assembly (fan/heat sink appearance may vary):



**NOTE:** Steps 1 through 5 apply only to computer models equipped with Intel processors.

1. Turn the system board right-side up, with the front toward you.
2. Disconnect the fan cable from the system board **(1)**.
3. Remove the Phillips 3.0 x 2.0 screw **(2)** that secures the fan/heat sink assembly to the system board.

4. Follow the sequence embossed on heat sink to loosen the six Phillips 10.0 x 2.0 captive screws **(3)** that secure the fan/heat sink assembly to the system board.

 **NOTE:** Due to the adhesive quality of the thermal material located between the fan/heat sink assembly and system board components, it might be necessary to move the fan/heat sink assembly from side to side to detach the assembly.

5. Remove the fan/heat sink assembly **(4)** by lifting it straight up.

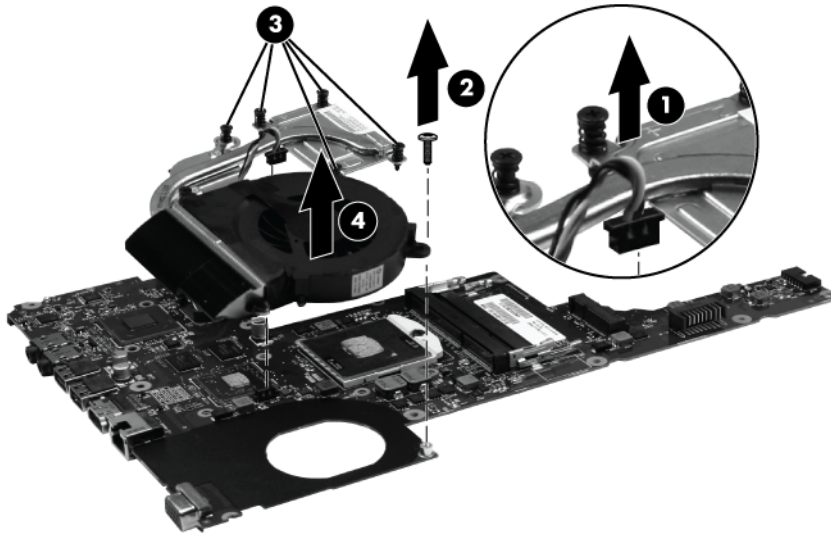

 **NOTE:** Steps 6 through 10 apply only to computer models equipped with AMD processors.

6. Turn the system board right-side up, with the front toward you.
7. Disconnect the fan cable from the system board **(1)**.
8. Remove the Phillips 3.0 x 2.0 screw **(2)** that secures the fan/heat sink assembly to the system board.

 **NOTE:** Due to the adhesive quality of the thermal material located between the fan/heat sink assembly and system board components, it might be necessary to move the fan/heat sink assembly from side to side to detach the assembly.

9. Follow the sequence embossed on the heat sink to loosen the six Phillips 10.0 x 2.0 captive screws **(3)** that secure the fan/heat sink assembly to the system board.

10. Remove the fan/heat sink assembly (4) by lifting straight up.

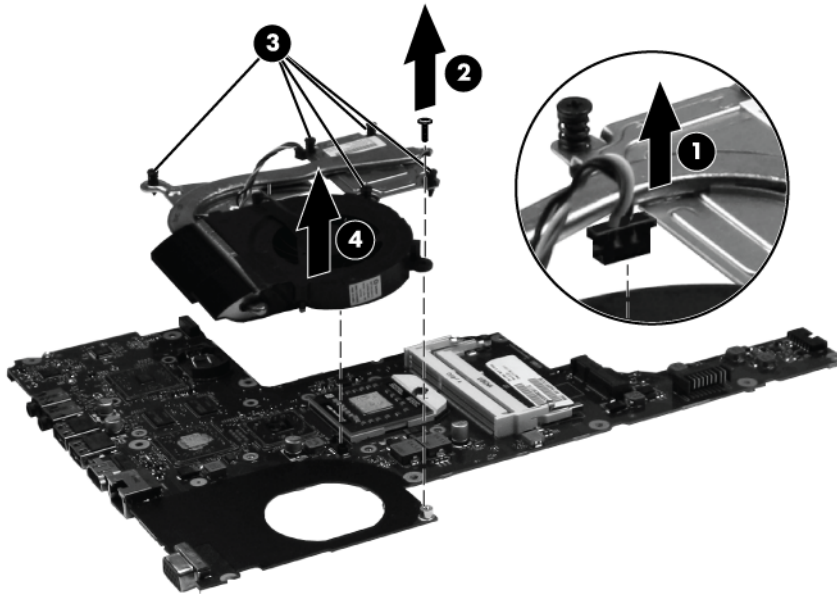

Each time the fan/heat sink assembly is removed, the thermal material must be thoroughly cleaned from the system board at locations (1) and (2), from the fan/heat sink assembly at locations (3) and (5), and from the processor (4). Thermal pads and thermal paste must be installed on all surfaces before the fan/heat sink assembly is reinstalled.

 **NOTE:** Thermal pads and thermal paste are included with all fan/heat sink assembly, system board, and processor spare part kits.

The following illustration shows the locations for thermal material on systems with Intel processors.

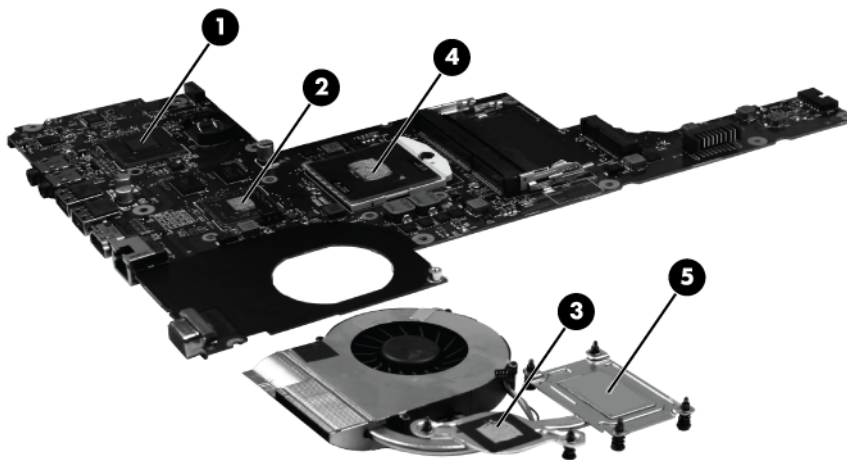

Each time the fan/heat sink assembly is removed, the thermal material must be thoroughly cleaned from the system board at locations (1), (2), and (4), from the fan/heat sink assembly at locations (3), (5), and (7), and from the processor (6). Thermal pads and thermal paste must be installed on all surfaces before the fan/heat sink assembly is reinstalled.

The following illustration shows the locations for thermal material on systems with AMD processors.

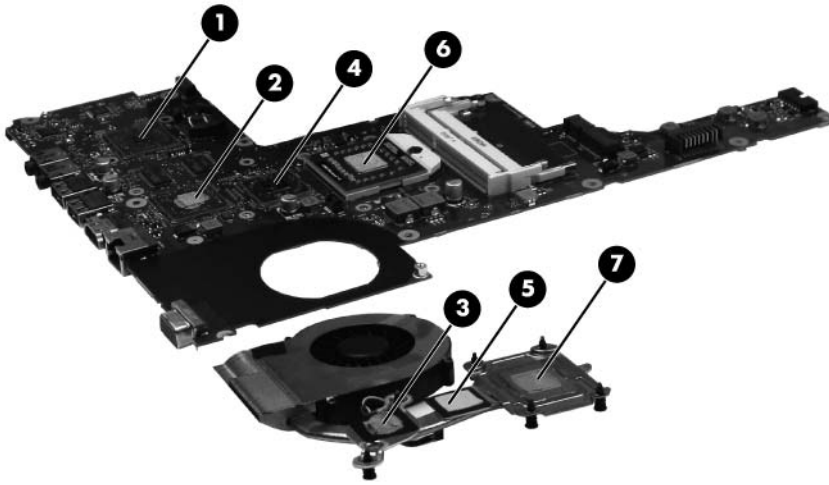

After applying fresh thermal paste to the components, reverse the above procedure to install the fan/heat sink assembly.



## Processor



**NOTE:** All processor spare part kits include thermal material.

Description	Spare part number
Intel Core i7-2620M processor (2.7 GHz, SC turbo up to 3.40 GHz, 4 MB L3 cache), Dual 35 W	631252-001
Intel Core i5-2540M processor (2.6 GHz, SC turbo up to 3.3 GHz, 3 MB L3 cache), Dual 35 W	631255-001
Intel Core i5-2520M processor (2.5 GHz, SC turbo up to 3.2 GHz, 3 MB L3 cache), Dual 35 W	631253-001
Intel Core i5-2430M processor (2.4 GHz, SC turbo up to 3.0 GHz, 3 MB L3 cache), Dual 35 W	653341-001
Intel Core i5-2410M processor (2.3 GHz, SC turbo up to 2.9 GHz, 3 MB L3 cache), Dual 35 W	638039-001
Intel Core i3-2350M processor (2.3 GHz, 3 MB L3 cache), Dual 35 W	653340-001
Intel Core i3-2330M processor (2.2 GHz, 3 MB L3 cache), Dual 35 W	653339-001
Intel Core i3 2310M (2.1 GHz, 3 MB L3 cache) Dual 35 W	638037-001
Intel Pentium B960 (2.2 GHz, 2 MB L3 cache), Dual 35 W	664662-001
Intel Pentium B950 (2.1 GHz, 2MB L3 cache), Dual 35 W	653338-001
Intel Core i5-480M processor (2.66 GHz, SC turbo up to 2.93 GHz, 3 MB L3 cache), Dual 35 W	634693-001
Intel Core i3-390M processor (2.66 GHz, 3 MB L3 cache), Dual 35 W	634692-001
Intel Core i3-380M processor (2.53 GHz, 3 MB L3 cache), Dual 35 W	625823-001
Intel Pentium P6300 (2.26 GHz, 3 MB L3 cache), Dual 35 W	635500-001
Intel Pentium P6200 (2.13 GHz, 3 MB L3 cache), Dual 35 W	625831-001
AMD A8-3500M (2.4 GHz/1.5 GHz, 4 MB L2 cache), Quad 35 W	653350-001
AMD A6-3400M (2.3 GHz/1.4 GHz, 4 MB L2 cache), Quad 35 W	653349-001
AMD A4-3300M (2.5 GHz/1.9 GHz, 2 MB L2 cache), Dual 35 W	653348-001
AMD E2-3000M (2.4 GHz/1.8 GHz, 1 MB L2 cache), Dual 35 W	653351-001
AMD Phenom II N970 (2.2 GHz, 2 MB L2 cache, 1333 MHz, 3.6 GT/s) –Quad 35 W	635496-001
AMD Phenom II P960 (1.8 GHz, 2 MB L2 cache, 1066 MHz, 3.6 GT/s) – Quad 25 W	634689-001
AMD Phenom II N870 (2.3 GHz, 1.5 MB L2 cache, 1333 MHz, 3.6 GT/s) –Triple 35 W	635495-001
AMD Phenom II P860 (2.0 GHz, 1.5 MB L2 cache, 1066 MHz, 3.6 GT/s) –Triple 25 W	634688-001
AMD Phenom II N850 (2.2 GHz, 1.5 MB L2 cache, 1333 MHz, 3.6 GT/s) –Triple 35 W	616345-001
AMD Phenom II N660 (3.0 GHz, 2 MB L2 cache, 1333 MHz, 3.6 GT/s) –Dual 35 W	635494-001
AMD Phenom II P650 (2.6 GHz, 2 MB L2 cache, 1066 MHz, 3.6 GT/s) – Dual 25 W	634687-001
AMD Turion II P560 (2.5 GHz, 2 MB L2 cache, 1066 MHz, 3.6 GT/s) – Dual 25 W	634691-001
AMD Athlon II P360 (2.3 GHz, 1 MB L2 cache, 1066 MHz, 3.6 GT/s) – Dual 25 W	636635-001
AMD Athlon II P340 (2.2 GHz, 1 MB L2 cache, 1066 MHz, 3.2 GT/s) – Dual 25 W	616343-001

Description	Spare part number
AMD V160 (2.4 GHz, 512 K L2 cache, 1066 MHz, 3.2 GT/s) – SC 25 W	636634-001
AMD V140 (2.3 GHz, 512 K L2 cache, 1066 MHz, 3.2 GT/s) – SC 25 W	616333-001

Before removing the processor, remove the following components:

1. Battery (see [Battery on page 43](#))
2. Service door (see [Service door on page 44](#))
3. Hard drive (see [Hard drive on page 45](#))
4. Optical drive (see [Optical drive on page 48](#))
5. WLAN module (see [WLAN module on page 50](#))
6. Memory module (see [Memory module on page 52](#))
7. Keyboard (see [Keyboard on page 54](#))
8. Top cover (see [Top cover on page 56](#))
9. USB board (see [USB board on page 64](#))
10. Display assembly (see [Display assembly on page 67](#))
11. Power connector (see [Power connector on page 66](#))
12. System board (see [System board on page 73](#))
13. Fan/heat sink assembly (see [Fan/heat sink assembly on page 77](#))

Remove the processor:

1. Turn the processor locking screw **(1)** one half-turn counterclockwise until you hear a click.

2. Lift the processor **(2)** straight up and remove it.

 **NOTE:** The gold triangle **(3)** on the processor must be aligned with the triangle icon **(4)** embossed on the processor socket when you install the processor.

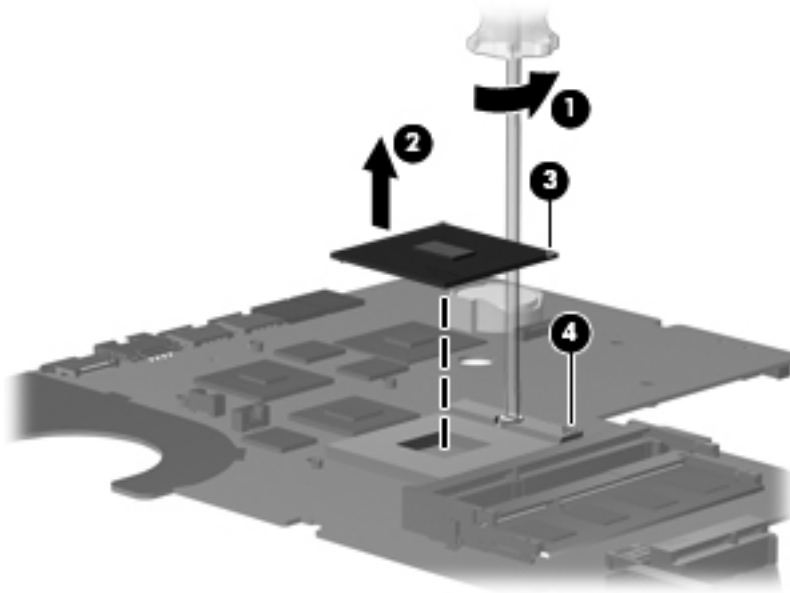

Reverse this procedure to install the processor.

# 5 Specifications

## Computer specifications

<b>Dimensions</b>	
Depth	<b>24.5 cm</b> (9.6 in)
Width	<b>37.4 cm</b> (14.7 in)
Height (front to rear)	<b>3.1 to 3.6 cm</b> (1.2 to 1.4 in)
<b>Weight</b> (lowest weight configuration)	< <b>2.5 kg</b> (5.5 lbs)
<b>Input power</b>	
Operating voltage	18.5 V dc @ 3.5 A - 65W
Operating current	3.5 A
<b>Temperature</b>	
Operating	<b>5°C to 35°C</b> (41°F to 95°F)
Nonoperating	<b>-20°C to 60°C</b> (-4°F to 140°F)
<b>Relative humidity</b>	
Operating	10% to 90%
Nonoperating	5% to 95%
<b>Maximum altitude</b> (unpressurized)	
Operating	<b>-15 m to 3,048 m</b> (-50 ft to 10,000 ft)
Nonoperating	<b>-15 m to 12,192 m</b> (-50 ft to 40,000 ft)
<b>NOTE:</b> Applicable product safety standards specify thermal limits for plastic surfaces. The computer operates well within this range of temperatures.	

## 39.6-cm (15.6-in) display specifications

<b>Dimensions</b>	
Height	<b>21.0 cm</b> (8.27 in)
Width	<b>35.9 cm</b> (14.1 in)
Diagonal	<b>39.6 cm</b> (15.6)
<b>Number of colors</b>	Up to 16.8 million
<b>Contrast ratio</b>	300:1 (typical)
<b>Brightness</b>	200 nits (typical)
<b>Pixel resolution</b>	
Pitch	0.259 × 0.259 mm
Format	1280 × 800; HD: 1366 × 768
Configuration	RGB vertical stripe
<b>Backlight</b>	LED
<b>Character display</b>	80 × 25
<b>Total power consumption</b>	4.0 W
<b>Viewing angle</b>	±40° horizontal, +120°/-40° vertical (typical)

## Hard drive specifications

	750 GB*	640 GB*	500 GB*	320 GB*	250 GB*
<b>Dimensions</b>					
Height	9.5 mm	9.5 mm	9.5 mm	9.5 mm / 7 mm	9.5 mm / 7 mm
Width	70 mm	70 mm	70 mm	70 mm	70 mm
Weight	101 g	101 g	101 g	101 g	101 g
<b>Interface type</b>	SATA	SATA	SATA	SATA	SATA
<b>Transfer rate</b>	100 MB/sec	106 MB/sec	100 MB/sec	100 MB/sec	100 MB/sec
<b>Security</b>	ATA security	ATA security	ATA security	ATA security	ATA security
<b>Seek times</b> (typical read, including setting)					
Single track	1.5 ms	1.0 ms	1.0 ms	1.5 ms	2.0 ms
Average	11.0 ms	14.0 ms	14.0 ms	12.0 ms	12.0 ms
Maximum	22.0 ms	24.0 ms	22.0 ms	22.0 ms	22.0 ms
<b>Logical blocks</b>	312,581,808	1,250,263,728	976,773,168	625,142,448	488,397,168
<b>Disc rotational speed</b>	7200 rpm	5400 rpm	5400 and 7200 rpm	7200 rpm	7200 rpm
<b>Operating temperature</b>	<b>5°C to 55°C</b> (41°F to 131°F)				
*1 GB = 1 billion bytes when referring to hard drive storage capacity. Actual accessible capacity is less. Actual drive specifications may differ slightly.					
<b>NOTE:</b> Certain restrictions and exclusions apply. Contact technical support for details.					

# DVD±RW and CD-RW SuperMulti Double-Layer Combo Drive specifications

<b>Applicable disc</b>	
Read	CD-DA, CD+(E)G, CD-MIDI, CD-TEXT, CD-ROM, CD-ROM XA, MIXED MODE CD, CD-I, CD-I Bridge (Photo-CD, Video CD), Multisession CD (Photo-CD, CD-EXTRA, Portfolio, CD-R, CD-RW), CD-R, CD-RW, DVD-ROM (DVD-5, DVD-9, DVD-10, DVD-18), DVD-R, DVD-RW, DVD+R, DVD+RW, DVD-RAM
Write	CD-R and CD-RW, DVD+R, DVD+RW, DVD-R, DVD-RW, DVD-RAM
<b>Random access time</b>	
DVD	< 230 ms
CD	< 175 ms
<b>Cache buffer</b>	
	2 MB
<b>Data transfer rate</b>	
24X CD-ROM	3,600 KB/sec
8X DVD-ROM	10,800 KB/sec
24X CD-R	3,600 KB/sec
16X CD-RW	2,400 KB/sec
8X DVD+R	10,800 KB/sec
4X DVD+RW	5,400 KB/sec
8X DVD-R	10,800 KB/sec
4X DVD-RW	5,400 KB/sec
2.4X DVD+R(9)	2,700 KB/sec
5X DVD-RAM	6,750 KB/sec
<b>Transfer mode</b>	
	Multiword DMA Mode

# Blu-ray Disc ROM and DVD±R/RW SuperMulti Double-Layer Drive specifications

<b>Applicable disc</b>	
Read	BD-ROM, BD-ROM-DL, BD-R, BD-R-DL, BD-RE, BD-RE-DL, DVD-ROM, DVD+R, DVD+R-DL, DVD+RW, DVD-R, DVD-R-DL, DVD-RW, DVD-RAM (Ver.2), CD-DA, CD-ROM (mode 1 and mode 2), CD-ROM XA (mode 2, form 1 and form 2), Photo CD (single and multiple sessions), CD Extra, CD-R, CD-RW, and CD-TEXT
Write	DVD-RAM (Ver.2), DVD+R, DVD-R, CD-R, and CD-ROM
<b>Random access time</b>	
BD	< 230 ms
DVD	< 180 ms
CD	< 180 ms
<b>Cache buffer</b>	
	4.5 MB
<b>Data transfer rate</b>	
24X CD-ROM	3,600 KB/sec
8X DVD-ROM	10,800 KB/sec
4X BD	18,000 KB/sec
24X CD-R	3,600 KB/sec
16X CD-RW	2,400 KB/sec
8X DVD+R	10,800 KB/sec
4X DVD+RW	5,400 KB/sec
8X DVD-R	10,800 KB/sec
4X DVD-RW	5,400 KB/sec
2.4X DVD+R(9)	2,700 KB/sec
5X DVD-RAM	6,750 KB/sec
1X BD-ROM	4,500 KB/sec
1X BD-R read	4,500 KB/sec
1X BD-RE read	4,500 KB/sec
<b>Transfer mode</b>	
	Multiword DMA Mode



---

# 6 Setup Utility (BIOS)

Setup Utility, or Basic Input/Output System (BIOS), controls communication between all the input and output devices on the system (such as disk drives, display, keyboard, mouse, and printer). Setup Utility includes settings for the types of peripherals installed, the startup sequence of the computer, and the amount of system and extended memory.

---

 **CAUTION:** Use extreme care when making changes in Setup Utility. Errors can prevent the computer from operating properly.

---

## Starting Setup Utility

---

 **NOTE:** The fingerprint reader (select models only) cannot be used to access Setup Utility.

---

- ▲ Turn on or restart the computer. While the “Press the ESC key for Startup Menu” message is displayed in the lower-left corner of the screen, press **esc**. When the Startup Menu is displayed, press **f10**.

## Using Setup Utility

### Changing the language of Setup Utility

1. Start Setup Utility.
2. Use the arrow keys to select **System Configuration > Language**, and then press **enter**.
3. Use the arrow keys to select a language, and then press **enter**.
4. When a confirmation prompt with your language selected is displayed, press **enter**.
5. To save your change and exit Setup Utility, use the arrow keys to select **Exit > Exit Saving Changes**, and then press **enter**.

Your change takes effect immediately.

## Navigating and selecting in Setup Utility

Because Setup Utility is not Windows based, it does not support the TouchPad. Navigation and selection are by keystroke.

- To choose a menu or a menu item, use the arrow keys.
- To choose an item in a list or to toggle a field—for example an Enable/Disable field—use either the arrow keys or **f5** and **f6**.
- To select an item, press **enter**.
- To close a text box or return to the menu display, press **esc**.
- To display additional navigation and selection information while Setup Utility is open, press **f1**.

## Displaying system information

1. Start Setup Utility.
2. Select the **Main** menu. System information such as the system time and date, and identification information about the computer is displayed.
3. To exit Setup Utility without changing any settings, use the arrow keys to select **Exit > Exit Discarding Changes**, and then press **enter**.

## Restoring factory default settings in Setup Utility

1. Start Setup Utility.
2. Use the arrow keys to select **Exit > Load Setup Defaults**, and then press **enter**.
3. When the Setup Confirmation is displayed, press **enter**.
4. To save your change and exit Setup Utility, use the arrow keys to select **Exit > Exit Saving Changes**, and then press **enter**.

The Setup Utility factory settings take effect when the computer restarts.

---

 **NOTE:** Your password, security, and language settings are not changed when you restore the factory settings.

---

## Exiting Setup Utility

- To exit Setup Utility and save your changes from the current session:  
If the Setup Utility menus are not visible, press **esc** to return to the menu display. Then use the arrow keys to select **Exit > Exit Saving Changes**, and then press **enter**.
- To exit Setup Utility without saving your changes from the current session:  
If the Setup Utility menus are not visible, press **esc** to return to the menu display. Then use the arrow keys to select **Exit > Exit Discarding Changes**, and then press **enter**.

# Updating the BIOS

Updated versions of the BIOS may be available on the HP Web site.

Most BIOS updates on the HP Web site are packaged in compressed files called *SoftPaqs*.

Some download packages contain a file named *Readme.txt*, which contains information regarding installing and troubleshooting the file.

## Determining the BIOS version

To determine whether available BIOS updates contain later BIOS versions than those currently installed on the computer, you need to know the version of the system BIOS currently installed.

BIOS version information (also known as *ROM date* and *System BIOS*) can be displayed by pressing **fn + esc** (if you are already in Windows) or by using Setup Utility.

1. Start Setup Utility.
2. If the system information is not displayed, use the arrow keys to select the **Main** menu.  
BIOS and other system information is displayed.
3. To exit Setup Utility, use the arrow keys to select **Exit > Exit Discarding Changes**, and then press **enter**.

## Downloading a BIOS update

 **CAUTION:** To reduce the risk of damage to the computer or an unsuccessful installation, download and install a BIOS update only when the computer is connected to reliable external power using the AC adapter. Do not download or install a BIOS update while the computer is running on battery power, docked in an optional docking device, or connected to an optional power source. During the download and installation, follow these instructions:

Do not disconnect power from the computer by unplugging the power cord from the AC outlet.

Do not shut down the computer or initiate Sleep or Hibernation.

Do not insert, remove, connect, or disconnect any device, cable, or cord.

1. Access the page on the HP Web site that provides software for your computer:

**Windows 7**—Select **Start > Help and Support > Maintain**.

2. Follow the on-screen instructions to identify your computer and access the BIOS update you want to download.

3. At the download area, follow these steps:

a. Identify the BIOS update that is later than the BIOS version currently installed on your computer. Make a note of the date, name, or other identifier. You may need this information to locate the update later, after it has been downloaded to your hard drive.

b. Follow the on-screen instructions to download your selection to the hard drive.

Make a note of the path to the location on your hard drive where the BIOS update is downloaded. You will need to access this path when you are ready to install the update.

 **NOTE:** If you connect your computer to a network, consult the network administrator before installing any software updates, especially system BIOS updates.

BIOS installation procedures vary. Follow any instructions that are displayed on the screen after the download is complete. If no instructions are displayed, follow these steps:

1. **Windows 7**—Open Windows Explorer by selecting **Start > Computer**.

2. Double-click your hard drive designation. The hard drive designation is typically Local Disk (C:).

3. Using the hard drive path you recorded earlier, open the folder on your hard drive that contains the update.

4. Double-click the file that has an .exe extension (for example, *filename.exe*).

The BIOS installation begins.

5. Complete the installation by following the on-screen instructions.

 **NOTE:** After a message on the screen reports a successful installation, you can delete the downloaded file from your hard drive.

---

# 7 Backup and recovery

- [Restore](#)
- [Creating restore media](#)
- [Performing a system restore](#)
- [Backing up and recovering your information](#)

Your computer includes tools provided by the operating system and HP to help you safeguard your information and restore it if ever needed.

This chapter provides information on the following topics:

- Creating a set of recovery discs or a recovery flash drive (HP Recovery Manager software feature)
- Performing a system restore (from the partition, recovery discs, or a recovery flash drive)
- Backing up your information
- Recovering a program or driver

# Restore

In the event of hard drive failure, to restore your system to its factory image you will need a set of recovery discs or a recovery flash drive that you can create using HP Recovery Manager. HP recommends that you use this software to create either a set of recovery discs or a recovery flash drive immediately after software setup.

If for some other reason you need to restore your system, this can be achieved using the HP Recovery partition (select models only), without the need for recovery discs or a recovery flash drive. To check for the presence of a recovery partition, click **Start**, right-click **Computer**, click **Manage**, and then click **Disk Management**. If the recovery partition is present, a Recovery drive is listed in the window.

---

 **CAUTION:** HP Recovery Manager (partition or discs/flash drive) restores only software that was preinstalled at the factory. Software not provided with this computer must be reinstalled manually.

 **NOTE:** Recovery discs have been included if your computer does not have a recovery partition.

---

## Creating restore media

HP recommends that you create either a set of recovery discs or a recovery flash drive to be sure that you can restore your computer to its original factory state if the hard drive fails, or if for any reason you cannot restore using the recovery partition tools. Create these discs or the flash drive after setting up the computer for the first time.

---

 **NOTE:** HP Recovery Manager allows the creation of only one set of recovery discs or one recovery flash drive. Handle these discs or flash drive carefully and keep them in a safe place.

 **NOTE:** If your computer does not include an integrated optical drive, you can use an optional external optical drive (purchased separately) to create recovery discs, or you can purchase recovery discs for your computer from the HP Web site. If you use an external optical drive, it must be connected directly to a USB port on the computer, not to a USB port on an external device, such as a USB hub.

---

Guidelines:

- Purchase high-quality DVD-R, DVD+R, DVD-R DL, or DVD+R DL discs.

---

 **NOTE:** Read-write discs, such as CD-RW, DVD±RW, double-layer DVD±RW, and BD-RE (rewritable Blu-ray) discs, are not compatible with the HP Recovery Manager software.

---

- The computer must be connected to AC power during this process.
- Only one set of recovery discs or one recovery flash drive can be created per computer.

---

 **NOTE:** If you are creating recovery discs, number each disc before inserting it into the optical drive.

---

- If necessary, you can exit the program before you have finished creating the recovery discs or recovery flash drive. The next time you open HP Recovery Manager, you will be prompted to continue the backup creation process.

To create a set of recovery discs or a recovery flash drive:

1. Select **Start > All Programs > HP > HP Recovery Manager > HP Recovery Media Creation**.
2. Follow the on-screen instructions.

## Performing a system restore

HP Recovery Manager software allows you to repair or restore the computer to its original factory state. HP Recovery Manager works from recovery discs, a recovery flash drive, or from a dedicated recovery partition (select models only) on the hard drive.

 **NOTE:** A system restore needs to be performed if the computer hard drive has failed or if all attempts to correct any functional computer issues fail. A system restore should be used as a final attempt to correct computer issues.

Note the following when performing a system restore:

- You can restore only the system that you have previously backed up. HP recommends that you use Recovery Manager to create either a set of recovery discs or a recovery flash drive as soon as you set up the computer.
- Windows has its own built-in repair features, such as System Restore. If you have not already tried these features, try them before using HP Recovery Manager.
- HP Recovery Manager restores only software that was preinstalled at the factory. Software not provided with this computer must be downloaded from the manufacturer's Web site or reinstalled from the disc provided by the manufacturer.

## Restoring using the dedicated recovery partition (select models only)

When using the dedicated recovery partition, there is an option to back up pictures, music and other audio, videos and movies, recorded TV shows, documents, spreadsheets and presentations, e-mails, Internet favorites and settings during this process.

To restore the computer from the recovery partition, follow these steps:

1. Access HP Recovery Manager in either of the following ways:
  - Select **Start > All Programs > HP > HP Recovery Manager > HP Recovery Manager**.
  - or –
  - Turn on or restart the computer, and then press **esc** while the “Press the ESC key for Startup Menu” message is displayed at the bottom of the screen. Then, press **f11** while the “F11 (System Recovery)” message is displayed on the screen.
2. Click **System Recovery** in the **HP Recovery Manager** window.
3. Follow the on-screen instructions.

## Restoring using the restore media

1. If possible, back up all personal files.
2. Insert the first recovery disc into the optical drive on your computer or an optional external optical drive, and then restart the computer.

– or –

Insert the recovery flash drive into a USB port on your computer, and then restart the computer.



---

**NOTE:** If the computer does not automatically restart in the HP Recovery Manager, the computer boot order needs to be changed.

---

3. Press **F9** at system bootup.
4. Select the optical drive or the flash drive.
5. Follow the on-screen instructions.



## Changing the computer boot order

To change the boot order for recovery discs:

1. Restart the computer.
2. Press **esc** while the computer is restarting, and then press **f9** for boot options.
3. Select **Internal CD/DVD ROM Drive** from the boot options window.

To change the boot order for recovery flash drive:

1. Insert the flash drive into a USB port.
2. Restart the computer.
3. Press **esc** while the computer is restarting, and then press **f9** for boot options.
4. Select the flash drive from the boot options window.

## Backing up and recovering your information

It is very important to back up your files and keep any new software in a safe place. As you add new software and data files, continue to create backups on a regular basis.

How completely you are able to recover your system depends on how recent your backup is.

---

 **NOTE:** A recovery from your most recent backup needs to be performed if the computer has a virus attack or if any major system components fail. In order to correct computer issues, a recovery should first be attempted before a system restore is attempted.

---

You can back up your information to an optional external hard drive, a network drive, or discs. Back up your system at the following times:

- At regularly scheduled times

---

 **TIP:** Set reminders to back up your information periodically.

---

- Before the computer is repaired or restored
- Before you add or modify hardware or software

Guidelines:

- Create system restore points using the Windows System Restore feature, and periodically copy them to an optical disc or an external hard drive. For more information on using system restore points, refer to [Using Windows system restore points on page 99](#).
- Store personal files in the Documents library and back up this folder periodically.
- Save customized settings in a window, toolbar, or menu bar by taking a screen shot of your settings. The screen shot can be a time-saver if you have to re-enter your preferences.

To create a screen shot:

1. Display the screen you want to save.
2. Copy the screen image:

To copy only the active window, press **alt+fn+prt sc**.

To copy the entire screen, press **fn+prt sc**.

3. Open a word-processing document, and then select **Edit > Paste**. The screen image is added to the document.
4. Save and print the document.

## Using Windows Backup and Restore

Guidelines:

- Be sure that the computer is connected to AC power before you start the backup process.
- Allow enough time to complete the backup process. Depending on file sizes, it may take over an hour.

To create a backup:

1. Select **Start > Control Panel > System and Security > Backup and Restore**.
2. Follow the on-screen instructions to schedule and create a backup.



---

**NOTE:** Windows includes the User Account Control feature to improve the security of the computer. You may be prompted for your permission or password for tasks such as installing software, running utilities, or changing Windows settings. Refer to Help and Support for more information.

---

## Using Windows system restore points

A system restore point allows you to save and name a snapshot of your hard drive at a specific point in time. You can then recover back to that point if you want to reverse subsequent changes.

---

 **NOTE:** Recovering to an earlier restore point does not affect data files saved or e-mails created since the last restore point.

---

You also can create additional restore points to provide increased protection for your files and settings.

### When to create restore points

- Before you add or modify software or hardware
- Periodically, whenever the computer is functioning optimally

---

 **NOTE:** If you revert to a restore point and then change your mind, you can reverse the restoration.

---

### Create a system restore point

1. Select **Start > Control Panel > System and Security > System**.
2. In the left pane, click **System Protection**.
3. Click the **System Protection** tab.
4. Follow the on-screen instructions.

### Restore to a previous date and time

To revert to a restore point (created at a previous date and time), when the computer was functioning optimally, follow these steps:

1. Select **Start > Control Panel > System and Security > System**.
2. In the left pane, click **System Protection**.
3. Click the **System Protection** tab.
4. Click **System Restore**.
5. Follow the on-screen instructions.

---

## 8 Power cord set requirements

The wide-range input feature of the computer permits it to operate from any line voltage from 100 to 120 V ac, or from 220 to 240 V ac.

The 3-conductor power cord set included with the computer meets the requirements for use in the country or region where the equipment is purchased.

Power cord sets for use in other countries or regions must meet the requirements of the country and region where the computer is used.

### Requirements for all countries

The following requirements are applicable to all countries and regions:

- The length of the power cord set must be at least **1.5 m** (5.0 ft) and no more than **2.0 m** (6.5 ft).
- All power cord sets must be approved by an acceptable accredited agency responsible for evaluation in the country or region where the power cord set will be used.
- The power cord sets must have a minimum current capacity of 10 A and a nominal voltage rating of 125 or 250 V ac, as required by the power system of each country or region.
- The appliance coupler must meet the mechanical configuration of an EN 60 320/IEC 320 Standard Sheet C13 connector for mating with the appliance inlet on the back of the computer.

## Requirements for specific countries and regions

Country/region	Accredited agency	Applicable note number
Argentina	IRAM	1
Australia	SAA	1
Austria	OVE	1
Belgium	CEBEC	1
Brazil	ABNT	1
Canada	CSA	2
Chile	IMQ	1
Denmark	DEMKO	1
Finland	FIMKO	1
France	UTE	1
Germany	VDE	1
India	ISI	1
Israel	SII	1
Italy	IMQ	1
Japan	JIS	3
The Netherlands	KEMA	1
New Zealand	SANZ	1
Norway	NEMKO	1
The People's Republic of China	CCC	4
Saudi Arabia	SASO	7
Singapore	PSB	1
South Africa	SABS	1
South Korea	KTL	5
Sweden	SEMKO	1
Switzerland	SEV	1
Taiwan	BSMI	6
Thailand	TISI	1
The United Kingdom	ASTA	1

Country/region	Accredited agency	Applicable note number
The United States	UL	2
<ol style="list-style-type: none"> <li>1. The flexible cord must be Type HO5VV-F, 3-conductor, 0.75 mm<sup>2</sup> conductor size. Power cord set fittings (appliance coupler and wall plug) must bear the certification mark of the agency responsible for evaluation in the country or region where it will be used.</li> <li>2. The flexible cord must be Type SVT/SJT or equivalent, No. 18 AWG, 3-conductor. The wall plug must be a two-pole grounding type with a NEMA 5-15P (15 A, 125 V ac) or NEMA 6-15P (15 A, 250 V ac) configuration. CSA or C-UL mark. UL file number must be on each element.</li> <li>3. The appliance coupler, flexible cord, and wall plug must bear a "T" mark and registration number in accordance with the Japanese Dentori Law. The flexible cord must be Type VCTF, 3-conductor, 0.75 mm<sup>2</sup> or 1.25 mm<sup>2</sup> conductor size. The wall plug must be a two-pole grounding type with a Japanese Industrial Standard C8303 (7 A, 125 V ac) configuration.</li> <li>4. The flexible cord must be Type RVV, 3-conductor, 0.75 mm<sup>2</sup> conductor size. Power cord set fittings (appliance coupler and wall plug) must bear the CCC certification mark.</li> <li>5. The flexible cord must be Type H05VV-F 3-conductor, 0.75 mm<sup>2</sup> conductor size. KTL logo and individual approval number must be on each element. Corset approval number and logo must be printed on a flag label.</li> <li>6. The flexible cord must be Type HVCTF 3-conductor, 1.25 mm<sup>2</sup> conductor size. Power cord set fittings (appliance coupler, cable, and wall plug) must bear the BSMI certification mark.</li> <li>7. For 127 V ac, the flexible cord must be Type SVT or SJT 3-conductor, 18 AWG, with plug NEMA 5-15P (15 A, 125 V ac), with UL and CSA or C-UL marks. For 240 V ac, the flexible cord must be Type HO5VV-F 3-conductor, 0.75 mm<sup>2</sup> or 1.00 mm<sup>2</sup> conductor size, with plug BS 1363/A with BSI or ASTA marks.</li> </ol>		

---

## 9 Recycling

When a battery has reached the end of its useful life, do not dispose of the battery in general household waste. Follow the local laws and regulations in your area for battery disposal. HP encourages customers to recycle used electronic hardware, HP original print cartridges, and rechargeable batteries.

For more information about recycling programs, see the HP website at [www.hp.com/recycle](http://www.hp.com/recycle).

---

# Index

- A**
- AC adapter light, identifying 13
- AC adapter, spare part numbers 30
- action keys, identifying 11
- antenna
  - removal 71
  - spare part number 26
- audio, product description 5
- audio-in (microphone) jack, identifying 14
- audio-out (headphone) jack, identifying 14
- B**
- backing up
  - customized window, toolbar, and menu bar settings 97
  - personal files 97
- base enclosure, spare part number 23
- battery
  - removal 43
  - spare part numbers 25, 43
- battery bay 17
- battery release latch 17
- bezel
  - spare part number 26, 69
- BIOS
  - determining version 91
  - downloading an update 92
  - updating 91
- Blu-ray Disc ROM and DVD±R/RW SuperMulti Double-Layer Drive
  - removal 48
  - spare part number 48
  - specifications 88
- Blu-ray ROM and DVD±R/RW SuperMulti Double-Layer Drive
  - spare part number 29
- buttons
  - left TouchPad 8
  - power 10
  - right TouchPad 8
- C**
- cables, service considerations 37
- camera module
  - removal 69
  - spare part number 69
- camera, product description 5
- caps lock light, identifying 9
- chipset, product description 3
- components
  - bottom 17
  - buttons 10
  - display 16
  - front 8, 12
  - keys 11
  - left side 14
  - lights 9
  - right side 13
  - top 8
- computer feet
  - locations 42
  - spare part number 42
- computer specifications 84
- connector, power 13
- connectors, service considerations 37
- D**
- default settings, restoring 90
- digital media slot, identifying
  - MultiMedia Card (MMC) 15
  - Secure Digital (SD) Memory Card 15
- diskette drive, precautions 37
- display assembly
  - removal 67
  - spare part number 21, 67
- display back cover, spare part number 26
- display bezel
  - illustrated 26
  - spare part number 26, 69
- display cable, spare part number 26
- display components
  - illustrated 26
  - spare part numbers 26
- display enclosure, illustrated 26
- display hinge kit, spare part number 26
- display hinges
  - removal 71
  - spare part number 71
- display panel
  - illustrated 26
  - product description 4
  - removal 71
  - spare part number 26, 71
- Display Rubber Kit, spare part number 27
- Display Screw Kit, spare part number 27
- display specifications 85
- drives, preventing damage 37
- DVD±RW and CD-RW Combo Drive
  - removal 48



DVD±RW and CD-RW SuperMulti  
Double-Layer Combo Drive  
precautions 37  
spare part numbers 28, 48  
specifications 87

**E**  
electrostatic discharge 38  
esc key, identifying 11  
Ethernet, product description 5  
external media cards, product  
description 5  
external monitor port, identifying  
14

**F**  
f11 95  
factory settings, restoring 90  
fan/heat sink assembly  
removal 77  
spare part number 23, 77  
feet  
locations 42  
spare part number 42  
fn key, identifying 11  
front components 8

**G**  
graphics, product description 3  
grounding equipment and  
methods 40

**H**  
hard drive  
precautions 37  
product description 4  
removal 45  
spare part numbers 24, 28,  
45  
specifications 86  
Hard Drive Hardware Kit, spare  
part number 28  
hard drive light, identifying 15  
HDMI port, identifying 14  
headphone (audio-out) jack 14  
HP Recovery Manager 95

**I**  
integrated webcam light,  
identifying 16

internal microphone, identifying  
16

**J**  
jacks  
audio-in (microphone) 14  
audio-out (headphone) 14  
RJ-45 (network) 14

**K**  
keyboard  
product description 6  
removal 54  
spare part numbers 21, 54  
keys  
action keys 11  
esc 11  
fn 11  
Windows applications 11  
Windows logo 11

**L**  
latch, battery release 17  
lights  
AC adapter 13  
caps lock 9  
hard drive 15  
power light 15  
webcam 16  
wireless 9

**M**  
mass storage devices, spare part  
numbers 28  
memory module  
product description 4  
removal 52  
spare part numbers 24, 52  
microphone (audio-in) jack,  
identifying 14

**N**  
network jack, identifying 14

**O**  
operating system, product  
description 6  
optical drive  
precautions 37  
product description 4  
removal 48

spare part numbers 24, 28,  
48  
specifications 87, 88  
optical drive board  
spare part number 21

**P**  
packing guidelines 39  
plastic parts 36  
pointing device, product  
description 6  
ports  
HDMI 14  
product description 5  
USB 14  
power button board  
removal 60  
spare part number 21, 60  
power button, identifying 10  
power connector  
identifying 13  
spare part number 21  
power connector cable  
removal 66  
spare part number 66  
power cord  
requirements for all countries  
100  
requirements for specific  
countries and regions 101  
set requirements 100  
power cord, spare part numbers  
30  
Power light 9  
power light, identifying 15  
power requirements, product  
description 6  
processor  
product description 1  
removal 81  
spare part numbers 22, 81  
product description  
audio 5  
camera 5  
chipset 3  
display panel 4  
Ethernet 5  
external media cards 5  
graphics 3  
hard drives 4

- keyboard 6
- memory module 4
- operating system 6
- optical drives 4
- pointing devices 6
- ports 5
- power requirements 6
- processors 1
- security 6
- serviceability 6

## R

- recovering from the dedicated recovery partition 95
- recovering from the recovery discs 96
- recovery discs 94
- recovery, system 95
- removal/replacement
  - preliminaries 36
  - procedures 41
- restore points 99
- RJ-45 (network) jack, identifying 14
- RTC battery
  - removal 53
  - spare part number 24, 53
- Rubber Feet Kit, spare part number 42

## S

- security cable lock
  - removal 65
  - spare part number 65
- security cable slot
  - security cable slot, identifying 13
- security, product description 6
- serial number 18, 41
- service considerations 36
- service door
  - removal 44
  - spare part number 44
- service door, identifying 17
- serviceability, product description 6
- Setup Utility
  - changing the language 89
  - displaying system information 90

- exiting 90
- navigating 90
- restoring default settings 90
- selecting 90
- starting 89
- speaker assembly
  - removal 62
  - spare part number 21, 62
- specifications
  - Blu-ray Disc ROM and DVD±R/RW SuperMulti Double-Layer Drive 88
  - computer 84
  - display 85
  - DVD±RW and CD-RW SuperMulti Double-Layer Combo Drive 87
  - hard drive 86
  - optical drive 87, 88
- static-shielding materials 40
- supported discs 94
- system board
  - removal 73
  - spare part numbers 21, 73
- system information, displaying 90
- system recovery 95
- system restore points 99

## T

- thermal paste, replacement 79
- tools required 36
- top cover
  - removal 56
  - spare part number 21, 56
- TouchPad
  - buttons 8
  - removal 63
- TouchPad button board
  - spare part number 63
- TouchPad light 8, 9
- TouchPad on/off button 8
- TouchPad zone 8
- transporting guidelines 39

## U

- USB board
  - removal 64
  - spare part number 21, 64
- USB port, identifying 14
- using system restore 99

## V

- vents, identifying 14, 17

## W

- webcam light, identifying 16
- webcam module, spare part number 26
- webcam, identifying 16
- Windows applications key, identifying 11
- Windows logo key, identifying 11
- wireless antenna
  - removal 71
  - spare part number 26
- wireless light 9
- WLAN antennas, identifying 16
- WLAN module
  - removal 50
  - spare part numbers 23, 50
- workstation guidelines 39