



# Getting Started

HP Notebook

© Copyright 2011 Hewlett-Packard Development Company, L.P.

Bluetooth is a trademark owned by its proprietor and used by Hewlett-Packard Company under license. Microsoft and Windows are U.S. registered trademarks of Microsoft Corporation. SD Logo is a trademark of its proprietor.

The information contained herein is subject to change without notice. The only warranties for HP products and services are set forth in the express warranty statements accompanying such products and services. Nothing herein should be construed as constituting an additional warranty. HP shall not be liable for technical or editorial errors or omissions contained herein.

First Edition: August 2011

Document Part Number: 665386-001

### **Product notice**

This guide describes features that are common to most models. Some features may not be available on your computer.

### **Software terms**

By installing, copying, downloading, or otherwise using any software product preinstalled on this computer, you agree to be bound by the terms of the HP End User License Agreement (EULA). If you do not accept these license terms, your sole remedy is to return the entire unused product (hardware and software) within 14 days for a refund subject to the refund policy of your place of purchase.

For any further information or for requesting a full refund of the computer, please contact your local point of sale (the seller).

## Safety warning notice

---

 **WARNING!** To reduce the possibility of heat-related injuries or of overheating the computer, do not place the computer directly on your lap or obstruct the computer air vents. Use the computer only on a hard, flat surface. Do not allow another hard surface, such as an adjoining optional printer, or a soft surface, such as pillows or rugs or clothing, to block airflow. Also, do not allow the AC adapter to come into contact with the skin or a soft surface, such as pillows or rugs or clothing, during operation. The computer and the AC adapter comply with the user-accessible surface temperature limits defined by the International Standard for Safety of Information Technology Equipment (IEC 60950).

---



---

# Table of contents

<b>1 Welcome</b> .....	<b>1</b>
Finding information .....	1
<b>2 Getting to know your computer</b> .....	<b>3</b>
Top .....	3
TouchPad .....	3
Lights .....	4
Buttons .....	5
Keys .....	6
Front .....	6
Right side .....	7
Left side .....	8
Display .....	9
Bottom .....	10
<b>3 HP QuickWeb (select models only)</b> .....	<b>11</b>
Getting started .....	11
Starting HP QuickWeb .....	12
<b>4 Networking</b> .....	<b>13</b>
Using an Internet service provider .....	13
Connecting to a wireless network .....	14
Connecting to an existing WLAN .....	14
Setting up a new WLAN network .....	14
Configuring a wireless router .....	15
Protecting your WLAN .....	15
<b>5 Keyboard and pointing devices</b> .....	<b>16</b>
Using the keyboard .....	16
Using the action keys .....	16
Using pointing devices .....	17
Setting pointing device preferences .....	17
Using the TouchPad .....	17
Turning the TouchPad off or on .....	18
Navigating .....	18
Selecting .....	19

Using TouchPad gestures .....	19
Scrolling .....	20
Pinching/Zooming .....	20
Rotating .....	21
<b>6 Maintenance .....</b>	<b>22</b>
Inserting or removing the battery .....	22
Inserting the battery .....	22
Removing the battery .....	22
Adding or replacing a hard drive .....	23
Removing the hard drive .....	23
Installing a hard drive .....	25
Adding or replacing memory modules .....	26
<b>7 Backup and recovery .....</b>	<b>29</b>
Restore .....	29
Creating restore media .....	29
Performing a system restore .....	31
Restoring using the dedicated recovery partition (select models only) .....	31
Restoring using the restore media .....	31
Changing the computer boot order .....	32
Backing up and recovering your information .....	32
Using Windows Backup and Restore .....	33
Using Windows system restore points .....	33
When to create restore points .....	34
Create a system restore point .....	34
Restore to a previous date and time .....	34
<b>8 Customer support .....</b>	<b>35</b>
Contacting customer support .....	35
Labels .....	36
<b>9 Specifications .....</b>	<b>37</b>
Input power .....	37
DC plug of external HP power supply .....	37
Operating environment .....	37
<b>Index .....</b>	<b>38</b>

---

# 1 Welcome

After you set up and register the computer, it is important to take the following steps:

1. Set up your wired or wireless network. For more information, refer to [Networking on page 13](#).
2. Update your antivirus software. For more information, refer to the **HP Notebook Reference Guide**. For information on finding this guide, refer to [Finding information on page 1](#).
3. Create recovery discs or a recovery flash drive. For more information, refer to [Backup and recovery on page 29](#).
4. Get to know your computer. For more information, refer to [Getting to know your computer on page 3](#) and [Keyboard and pointing devices on page 16](#) for additional information.
5. Discover the software that is already loaded on the computer by selecting **Start > All Programs**.

## Finding information

The computer comes with several resources to help you perform various tasks.

Resource	Contents
Instructions for setting up the computer	<ul style="list-style-type: none"><li>• How to set up the computer</li><li>• Identification of computer components</li></ul>
<i>Getting Started</i> To access this guide: Select <b>Start &gt; Help and Support &gt; User Guides</b> .	<ul style="list-style-type: none"><li>• Computer features</li><li>• Instructions for the following:<ul style="list-style-type: none"><li>◦ Connecting to a wireless network</li><li>◦ Using the keyboard and pointing devices</li><li>◦ Replacing or upgrading the hard drive and memory modules</li><li>◦ Performing a backup and a recovery</li><li>◦ Contacting customer support</li></ul></li><li>• Computer specifications</li></ul>
<i>HP Notebook Reference Guide</i> To access this guide: Select <b>Start &gt; Help and Support &gt; User Guides</b> .	<ul style="list-style-type: none"><li>• Power management features</li><li>• Instructions for the following:<ul style="list-style-type: none"><li>◦ Maximizing battery life</li><li>◦ Using the multimedia features of the computer</li><li>◦ Protecting the computer</li><li>◦ Caring for the computer</li><li>◦ Updating the software</li></ul></li></ul>

Resource	Contents
<p>Help and Support</p> <p>To access Help and Support, select <b>Start &gt; Help and Support</b>.</p> <p><b>NOTE:</b> For country- or region-specific support, go to <a href="http://www.hp.com/support">http://www.hp.com/support</a>, select your country or region, and follow the on-screen instructions.</p>	<ul style="list-style-type: none"> <li>• Operating system information</li> <li>• Software, driver, and BIOS updates</li> <li>• Troubleshooting tools</li> <li>• Instructions for contacting customer support</li> </ul>
<p><i>Regulatory, Safety and Environmental Notices</i></p> <p>To access this guide:</p> <p>Select <b>Start &gt; Help and Support &gt; User Guides</b>.</p>	<ul style="list-style-type: none"> <li>• Regulatory and safety information</li> <li>• Battery disposal information</li> </ul>
<p><i>Safety &amp; Comfort Guide</i></p> <p>To access this guide:</p> <p>Select <b>Start &gt; Help and Support &gt; User Guides</b>.</p> <p>– or –</p> <p>Go to <a href="http://www.hp.com/ergo">http://www.hp.com/ergo</a>.</p>	<ul style="list-style-type: none"> <li>• Proper workstation setup</li> <li>• Guidelines for posture and work habits that maximize your comfort and decrease your risk of injury</li> <li>• Electrical and mechanical safety information</li> </ul>
<p><i>Worldwide Telephone Numbers</i> booklet</p> <p>This booklet is provided with your computer.</p>	<p>HP customer support telephone numbers</p>
<p>HP Web site</p> <p>To access this Web site, go to <a href="http://www.hp.com/support">http://www.hp.com/support</a>.</p>	<ul style="list-style-type: none"> <li>• Customer support information</li> <li>• Information for ordering parts</li> <li>• Software, driver, and BIOS updates</li> <li>• Information about accessories for the computer</li> </ul>
<p><i>Limited Warranty*</i></p> <p>To access the warranty:</p> <p>Select <b>Start &gt; Help and Support &gt; User Guides</b>.</p> <p>– or –</p> <p>Go to <a href="http://www.hp.com/go/orderdocuments">http://www.hp.com/go/orderdocuments</a>.</p>	<p>Warranty information</p>
<p>*You can find the expressly provided HP Limited Warranty applicable to your product located with the electronic guides on your computer and/or on the CD/DVD provided in the box. In some countries/regions, HP may provide a printed HP Limited Warranty in the box. For some countries/regions where the warranty is not provided in printed format, you may request a printed copy from <a href="http://www.hp.com/go/orderdocuments">http://www.hp.com/go/orderdocuments</a> or write to:</p> <ul style="list-style-type: none"> <li>• <b>North America:</b> Hewlett-Packard, MS POD, 11311 Chinden Blvd, Boise, ID 83714, USA</li> <li>• <b>Europe, Middle East, Africa:</b> Hewlett-Packard, POD, Via G. Di Vittorio, 9, 20063, Cernusco s/Naviglio (MI), Italy</li> <li>• <b>Asia Pacific:</b> Hewlett-Packard, POD, P.O. Box 200, Alexandra Post Office, Singapore 911507</li> </ul> <p>Please include your product number, warranty period (found on your serial number label), name, and postal address.</p> <p><b>IMPORTANT:</b> Do NOT return your HP product to the addresses above. For product support, refer to your product home page at <a href="http://www.hp.com/go/contactHP">http://www.hp.com/go/contactHP</a>.</p>	



## 2 Getting to know your computer

### Top

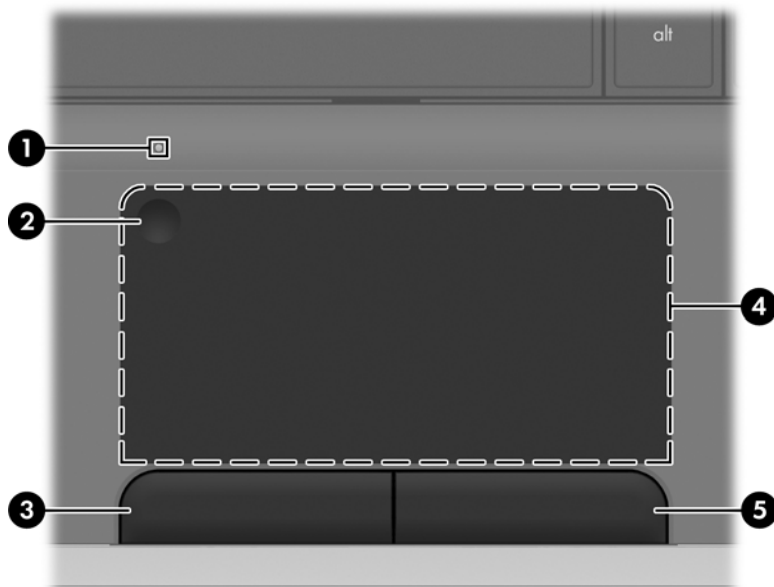

#### TouchPad

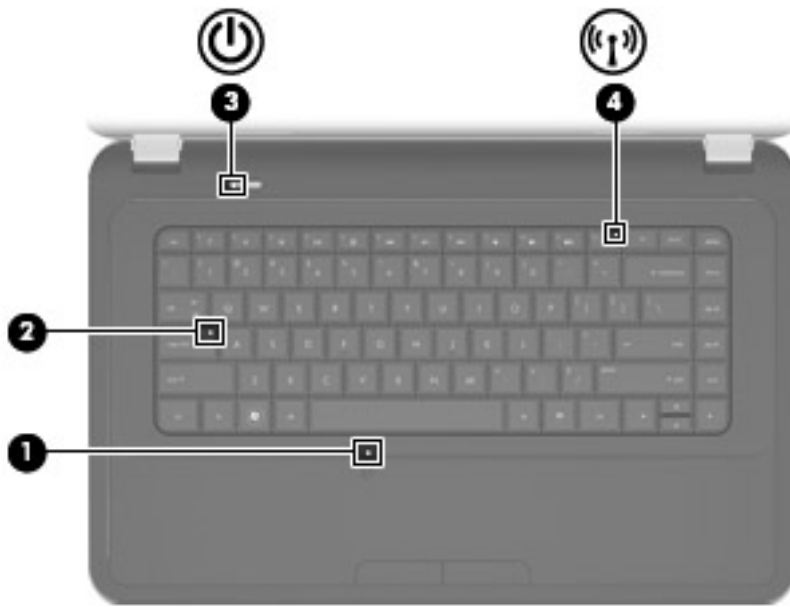

Component	Description
(1)  TouchPad light	<ul style="list-style-type: none"><li>• On: The TouchPad is off.</li><li>• Off: The TouchPad is on.</li></ul>
(2) TouchPad on/off button	Turns the TouchPad on and off. Quickly double-tap the TouchPad on/off button to turn the TouchPad on and off.
(3) Left TouchPad button	Functions like the left button on an external mouse.
(4) TouchPad zone	Moves the pointer and selects or activates items on the screen.
(5) Right TouchPad button	Functions like the right button on an external mouse.

## Lights



Component	Description
(1) TouchPad light	<ul style="list-style-type: none"><li>On: The TouchPad is off.</li><li>Off: The TouchPad is on.</li></ul>
(2) Caps lock light	On: Caps lock is on.
(3)  Power light	<ul style="list-style-type: none"><li>On: The computer is on.</li><li>Blinking: The computer is in Sleep state.</li><li>Off: The computer is off or in Hibernation.</li></ul>
(4)  Wireless light	<ul style="list-style-type: none"><li>White: An integrated wireless device, such as a wireless local area network (WLAN) device and/or a Bluetooth® device, is on.</li><li>Amber: All wireless devices are off.</li></ul>



## Buttons

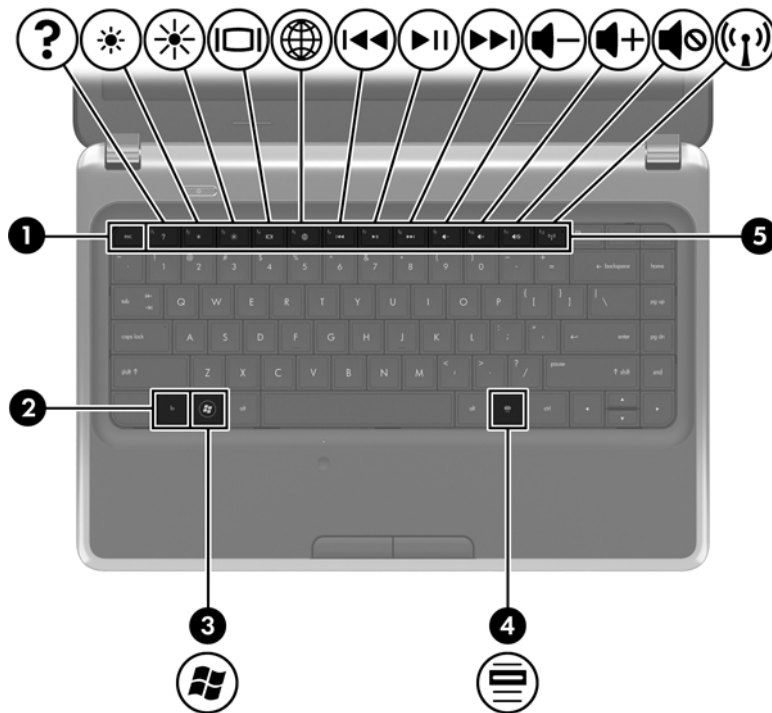

Component	Description
 Power button	<ul style="list-style-type: none"><li>• When the computer is off, press the button to turn on the computer.</li><li>• When the computer is on, press the button briefly to initiate Sleep.</li><li>• When the computer is in the Sleep state, press the button briefly to exit Sleep.</li><li>• When the computer is in Hibernation, press the button briefly to exit Hibernation.</li></ul> <p>If the computer has stopped responding and Windows® shutdown procedures are ineffective, press and hold the power button for at least 5 seconds to turn off the computer.</p> <p>To learn more about your power settings, select <b>Start &gt; Control Panel &gt; System and Security &gt; Power Options</b>, or refer to the <i>HP Notebook Reference Guide</i>.</p>

## Keys



Component	Description
(1) <code>esc</code> key	Displays system information when pressed in combination with the <code>fn</code> key.
(2) <code>fn</code> key	Executes frequently used system functions when pressed in combination with a function key, the <code>num lk</code> key, or the <code>esc</code> key.
(3)  Windows logo key	Displays the Windows Start menu.
(4)  Windows applications key	Displays a shortcut menu for items beneath the pointer.
(5) Action keys	Execute frequently used system functions.



## Front



Component	Description
Speakers (2)	Produce sound

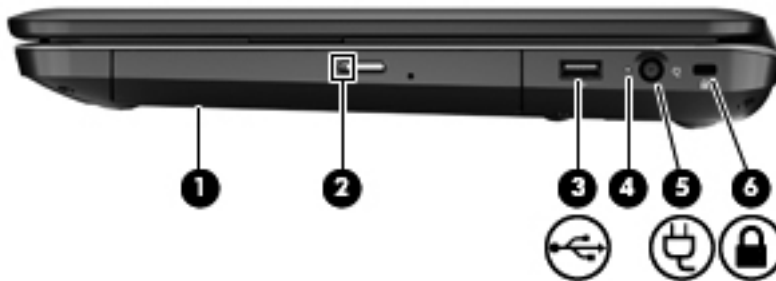





## Right side

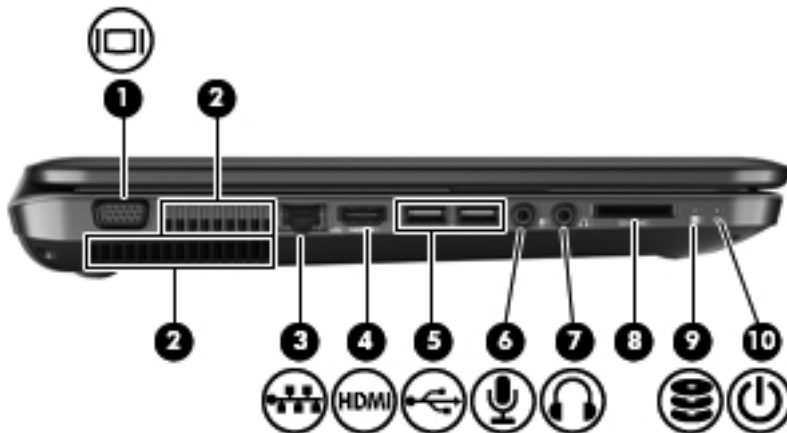



Component	Description
(1) Optical drive (select models only)	Reads and writes to an optical disc.
(2) Optical drive light	<ul style="list-style-type: none"><li>• Green: The optical drive is being accessed.</li><li>• Off: The optical drive is idle.</li></ul>
(3)  USB port	Connects an optional USB device.
(4) AC adapter light	<ul style="list-style-type: none"><li>• White: The computer is connected to external power and the battery is fully charged.</li><li>• Amber: The computer is connected to external power and the battery is charging.</li><li>• Off: The computer is not connected to external power.</li></ul>
(5)  Power connector	Connects an AC adapter.
(6)  Security cable slot	Attaches an optional security cable to the computer. <b>NOTE:</b> The security cable is designed to act as a deterrent, but it may not prevent the computer from being mishandled or stolen.

## Left side



Component	Description
(1)  External monitor port	Connects an external VGA monitor or projector.
(2) Vents (2)	Enable airflow to cool internal components. <b>NOTE:</b> The computer fan starts up automatically to cool internal components and prevent overheating. It is normal for the internal fan to cycle on and off during routine operation.
(3)  RJ-45 (network) jack	Connects a network cable.
(4)  HDMI port	Connects an optional video or audio device, such as a high-definition television, or any compatible digital or audio component.
(5)  USB ports (2)	Connect optional USB devices.
(6)  Audio-in (microphone) jack	Connects an optional computer headset microphone, stereo array microphone, or monaural microphone.
(7)  Audio-out (headphone) jack	Produces sound when connected to optional powered stereo speakers, headphones, earbuds, a headset, or television audio. <b>WARNING!</b> To reduce the risk of personal injury, adjust the volume before putting on headphones, earbuds, or a headset. For additional safety information, refer to the <i>Regulatory, Safety and Environmental Notices</i> . <b>NOTE:</b> When a device is connected to the jack, the computer speakers are disabled.
(8) Digital media slot	Supports the following optional digital card formats: <ul style="list-style-type: none"> <li>• MultiMedia Card (MMC)</li> <li>• Secure Digital (SD) Memory Card</li> </ul>

Component	Description
(9)  Hard drive light	<ul style="list-style-type: none"> <li>Blinking white: The hard drive is being accessed.</li> </ul>
(10)  Power light	<ul style="list-style-type: none"> <li>White: The computer is on.</li> <li>Blinking white: The computer is in the Sleep state.</li> <li>Off: The computer is off or in Hibernation.</li> </ul>

## Display





Component	Description
(1) WLAN antennas (2)*	Send and receive wireless signals to communicate with wireless local area networks (WLAN).
(2) Webcam light	On: The webcam is in use.
(3) Webcam	Records video and captures still photographs. To use the webcam, select <b>Start &gt; All Programs &gt; Communication and Chat &gt; CyberLink YouCam</b> .
(4) Internal microphone	Records sound.

\*The antennas are not visible from the outside of the computer. For optimal transmission, keep the areas immediately around the antennas free from obstructions. To see wireless regulatory notices, refer to the section of the *Regulatory, Safety and Environmental Notices* that applies to your country or region. These notices are located in HP Help and Support.

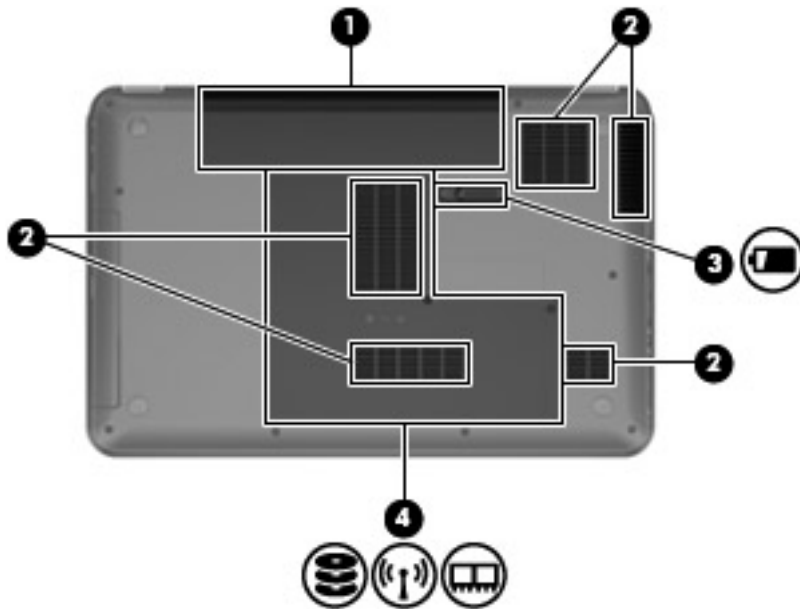
# Bottom



Component		Description
(1)	Battery bay	Holds the battery.
(2)	Vents (5)	Enable airflow to cool internal components.  <b>NOTE:</b> The computer fan starts up automatically to cool internal components and prevent overheating. It is normal for the internal fan to cycle on and off during routine operation.
(3)	 Battery release latch	Releases the battery from the battery bay.
(4)	 Hard drive bay, WLAN, and memory module compartments	Holds the hard drive, and contains the wireless LAN (WLAN) device and the memory module slots.  <b>CAUTION:</b> To prevent an unresponsive system, replace the wireless module only with a wireless module authorized for use in the computer by the governmental agency that regulates wireless devices in your country or region. If you replace the module and then receive a warning message, remove the module to restore computer functionality, and then contact technical support through Help and Support.



---

## 3 HP QuickWeb (select models only)

### Getting started

The HP QuickWeb environment provides a fun and engaging way to perform many of your favorite activities. Your computer is ready to go within seconds of starting HP QuickWeb, allowing you to rapidly access the Internet, widgets, and communication programs. To use QuickWeb, press the QuickWeb key, and then start browsing the Web, communicating with others using Skype, and exploring other HP QuickWeb widgets.

Your HP QuickWeb home screen includes the following features:

- Web browser—Search and browse the Web, and create links to your favorite Web sites.
- Skype—Communicate using Skype, an application that uses voice over Internet protocol (VoIP). Skype lets you make conference calls or have video chats with one or more people at a time. You can also make long-distance phone calls to land lines.
- Widgets—Start using widgets for news, weather, social networking, stocks, a calculator, sticky notes, and more. You can also use Widget Manager to add more widgets to the HP QuickWeb Home screen.



**NOTE:** For additional information about using HP QuickWeb, refer to the HP QuickWeb software Help.

---

## Starting HP QuickWeb

▲ To start HP QuickWeb, press the QuickWeb key when the computer is off or in Hibernation.

The following table explains the different behaviors of the QuickWeb key.

Key	Behavior
QuickWeb key	<ul style="list-style-type: none"><li>• When the computer is off or in Hibernation, press the key to open HP QuickWeb.</li><li>• When the computer is in Microsoft Windows, press the key to open the default Web browser.</li><li>• When the computer is in HP QuickWeb, press the key to open the Web browser.</li></ul> <p><b>NOTE:</b> If your computer does not have HP QuickWeb software, the key does not start QuickWeb or perform any action or function in QuickWeb.</p>



**NOTE:** For more information, refer to the HP QuickWeb software Help.

---

# 4 Networking

 **NOTE:** Internet hardware and software features vary depending on computer model and your location.

Your computer may support one or both of the following types of Internet access:

- **Wireless**—For mobile Internet access, you can use a wireless connection. Refer to [Connecting to an existing WLAN on page 14](#) or [Setting up a new WLAN network on page 14](#).
- **Wired**—You can access the Internet by connecting to a wired network. For information on connecting to a wired network, refer to the *HP Notebook Reference Guide*.

## Using an Internet service provider

Before you can connect to the Internet, you must establish an account with an Internet service provider (ISP). To purchase Internet service and a modem, contact a local ISP. The ISP will help set up the modem, install a network cable to connect your wireless computer to the modem, and test the Internet service.

 **NOTE:** Your ISP will give you a user ID and password to access the Internet. Record this information and store it in a safe place.

The following features will help you set up a new Internet account or configure the computer to use an existing account:

- **Internet Services & Offers (available in some locations)**—This utility assists with signing up for a new Internet account and configuring the computer to use an existing account. To access this utility, select **Start > All Programs > Online Services > Get Online**.
- **ISP-provided icons (available in some locations)**—These icons may be displayed either individually on the Windows desktop or grouped in a desktop folder named Online Services. To set up a new Internet account or configure the computer to use an existing account, double-click an icon, and then follow the on-screen instructions.
- **Windows Connect to the Internet Wizard**—This wizard allows you to connect to the Internet in any of the following situations:
  - You already have an account with an ISP.
  - You do not have an Internet account and want to select an ISP from the list provided within the wizard. (The list of ISP providers is not available in all regions.)
  - You have selected an unlisted ISP, and the ISP has provided you with information such as a specific IP address and POP3 and SMTP settings.

To access the Windows Connect to the Internet Wizard and instructions for using it, select **Start > Control Panel > Network and Internet > Network and Sharing Center**.

 **NOTE:** If you are prompted within the wizard to choose between enabling or disabling Windows Firewall, choose to enable the firewall.

## Connecting to a wireless network

Wireless technology transfers data across radio waves instead of wires. Your computer may be equipped with one or more of the following wireless devices:

- Wireless local area network (WLAN) device
- HP Mobile Broadband Module, a wireless wide area network (WWAN) device
- Bluetooth device

For more information on wireless technology and connecting to a wireless network, refer to the *HP Notebook Reference Guide* and the information and Web site links provided in Help and Support.

### Connecting to an existing WLAN

1. Turn on the computer.
2. Be sure that the WLAN device is on.
3. Click the network icon in the notification area, at the far right of the taskbar.
4. Select a network to connect to.
5. Click **Connect**.
6. If prompted, enter the security key.

### Setting up a new WLAN network

Required equipment:

- A broadband modem (either DSL or cable) **(1)** and high-speed Internet service purchased from an Internet service provider (ISP)
- A wireless router (purchased separately) **(2)**
- Your new wireless computer **(3)**

 **NOTE:** Some modems have a built-in wireless router. Check with your ISP to determine what type of modem you have.

The illustration shows an example of a completed WLAN network installation that is connected to the Internet. As your network grows, additional wireless and wired computers can be connected to the network to access the Internet.



## Configuring a wireless router

For help in setting up a WLAN, refer to the information provided by your router manufacturer or your ISP.

The Windows operating system also provides tools to help you set up a new wireless network. To use the Windows tools to set up your network, select **Start > Control Panel > Network and Internet > Network and Sharing Center > Set up a new connection or network > Set up a new network**. Then follow the on-screen instructions.



---

**NOTE:** It is recommended that you initially connect your new wireless computer to the router by using the network cable provided with the router. When the computer successfully connects to the Internet, you can disconnect the cable, and then access the Internet through your wireless network.

---

## Protecting your WLAN

When you set up a WLAN or access an existing WLAN, always turn on security features to protect your network from unauthorized access.

For information on protecting your WLAN, refer to the *HP Notebook Reference Guide*.

# 5 Keyboard and pointing devices

## Using the keyboard

### Using the action keys







An action key performs an assigned function. The icon on each of the **f1** through **f12** keys illustrates the assigned function for that key.







To use an action key function, press and hold the key.

The action key feature is enabled at the factory. You can disable this feature in Setup Utility (BIOS) and revert back to standard settings by pressing the **fn** key and one of the function keys to activate the assigned function. Refer to the “Setup Utility (BIOS) and System Diagnostics” chapter in the *HP Notebook Reference Guide* for instructions.

**CAUTION:** Use extreme care when making changes in Setup Utility. Errors can prevent the computer from operating properly.



Icon	Key	Description
	<b>f1</b>	Opens Help and Support, which provides information about your Windows operating system and computer, answers to questions and tutorials, and updates to your computer.  Help and Support also provides automated troubleshooting tools and access to customer support.
	<b>f2</b>	Decreases the screen brightness level incrementally as long as you hold down the key.
	<b>f3</b>	Increases the screen brightness level incrementally as long as you hold down the key.
	<b>f4</b>	Switches the screen image among display devices connected to the system. For example, if a monitor is connected to the computer, pressing this key alternates the screen image from the computer display to the monitor display to a simultaneous display on both the computer and the monitor.  Most external monitors receive video information from the computer using the external VGA video standard. This action key can also alternate images among other devices that are receiving video information from the computer.
	<b>f5</b>	<ul style="list-style-type: none"><li>When the computer is off or in Hibernation, press the key to open HP QuickWeb.</li><li>When the computer is in HP QuickWeb, press the key to open the default Web browser.</li></ul> <p><b>NOTE:</b> If your computer does not have HP QuickWeb software, the key does not perform any action or function.</p>
	<b>f6</b>	Plays the previous track of an audio CD or the previous section of a DVD or a BD.

Icon	Key	Description
	f7	Plays, pauses, or resumes a track of an audio CD or a section of a DVD or a BD.
	f8	Plays the next track of an audio CD or the next section of a DVD or a BD.
	f9	Decreases speaker volume incrementally as long as you hold down the key.
	f10	Increases speaker volume incrementally as long as you hold down the key.
	f11	Mutes or restores speaker sound.
	f12	Turns the wireless feature on or off.

**NOTE:** A wireless network must be set up before a wireless connection is possible.

## Using pointing devices

 **NOTE:** In addition to the pointing devices included with your computer, you can use an external USB mouse (purchased separately) by connecting it to one of the USB ports on the computer.

### Setting pointing device preferences

Use Mouse Properties in Windows® to customize pointing device settings, button configuration, click speed, and pointer options.

To access Mouse Properties, select **Start > Devices and Printers**. Then right-click the listing that represents your computer, and select **Mouse settings**.

### Using the TouchPad

 **NOTE:** The TouchPad on your computer may look slightly different from the illustrations in this section. Refer to [Getting to know your computer on page 3](#) for specific information about the TouchPad on your computer.

To move the pointer, slide one finger across the TouchPad in the direction you want the pointer to go. Use the left and right TouchPad buttons as you would use the buttons on an external mouse.



## Turning the TouchPad off or on

To turn the TouchPad off or on, quickly double-tap the TouchPad on/off button.

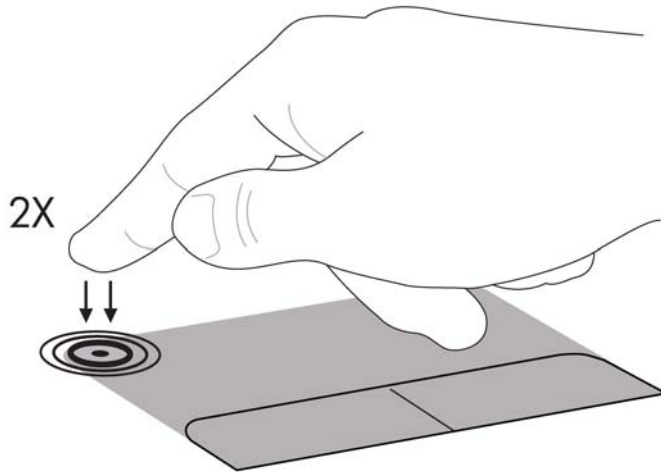
 **NOTE:** The TouchPad light is off when the TouchPad is on.



The TouchPad light and on-screen display icons indicate the TouchPad status when the TouchPad is turned off or on. The following table shows and describes the TouchPad display icons.

TouchPad light	Icon	Description
Amber		Indicates that the TouchPad is off.
Off		Indicates that the TouchPad is on.

## Navigating

To move the pointer, slide one finger across the TouchPad in the direction you want the pointer to go.

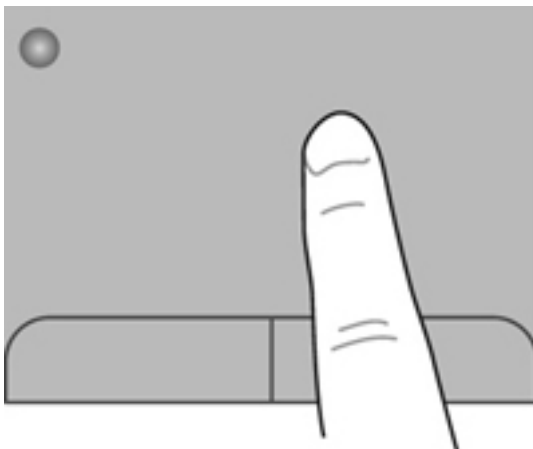



## Selecting

Use the left and right TouchPad buttons as you would use the corresponding buttons on an external mouse.

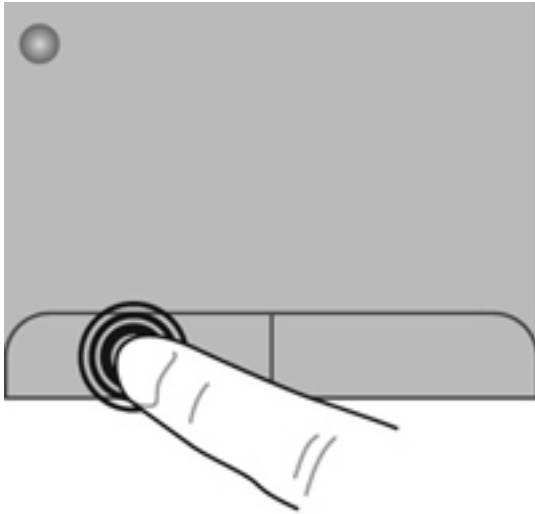

## Using TouchPad gestures

The TouchPad supports a variety of gestures. To use TouchPad gestures, place two fingers on the TouchPad at the same time.



---

**NOTE:** TouchPad gestures are not supported in all programs.

---

To view the demonstration of a gesture:

1. Select **Start > Control Panel > Hardware and Sound > Synaptics > Settings**.
2. Click a gesture to activate the demonstration.

To turn the gestures on or off:

1. Select **Start > Control Panel > Hardware and Sound > Synaptics > Settings**.
2. Select the check box next to the gesture that you want to turn on or off.
3. Click **Apply**, and then click **OK**.

## Scrolling

Scrolling is useful for moving up, down, or sideways on a page or image. To scroll, place two fingers slightly apart on the TouchPad, and then drag them across the TouchPad in an up, down, left, or right motion.

 **NOTE:** Scrolling speed is controlled by finger speed.

---

 **NOTE:** Two-finger scrolling is enabled at the factory.

---

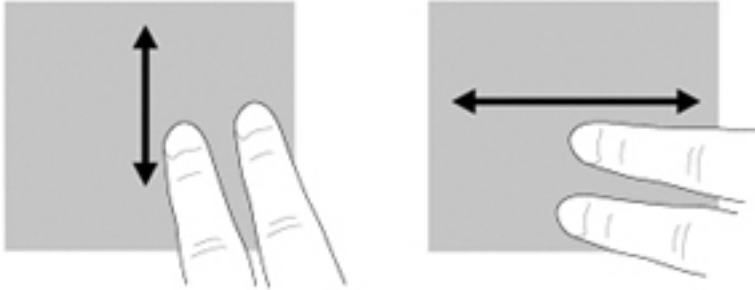

## Pinching/Zooming

Pinching allows you to zoom in or out on images or text.

- Zoom in by placing two fingers together on the TouchPad, and then moving them apart.
- Zoom out by placing two fingers apart on the TouchPad, and then moving them together.

 **NOTE:** Pinching/zooming is enabled at the factory.

---

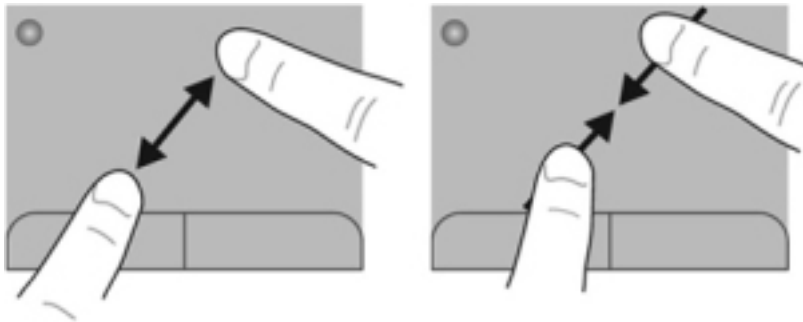

## Rotating

Rotating allows you to rotate items such as photos. To rotate, anchor your left forefinger in the TouchPad zone. Move the right forefinger around the anchored finger in a sweeping motion, moving from 12 o'clock to 3 o'clock. To reverse the rotation, move your right forefinger from 3 o'clock to 12 o'clock.

 **NOTE:** Rotating is disabled at the factory.

---

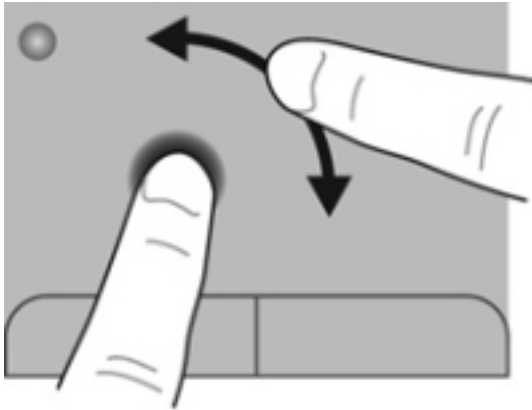

---

## 6 Maintenance

### Inserting or removing the battery

 **NOTE:** For additional information on using the battery, refer to the *HP Notebook Reference Guide*.

---

#### Inserting the battery

- ▲ Insert the battery (1) into the battery bay and rotate it downward (2) until it is firmly seated.

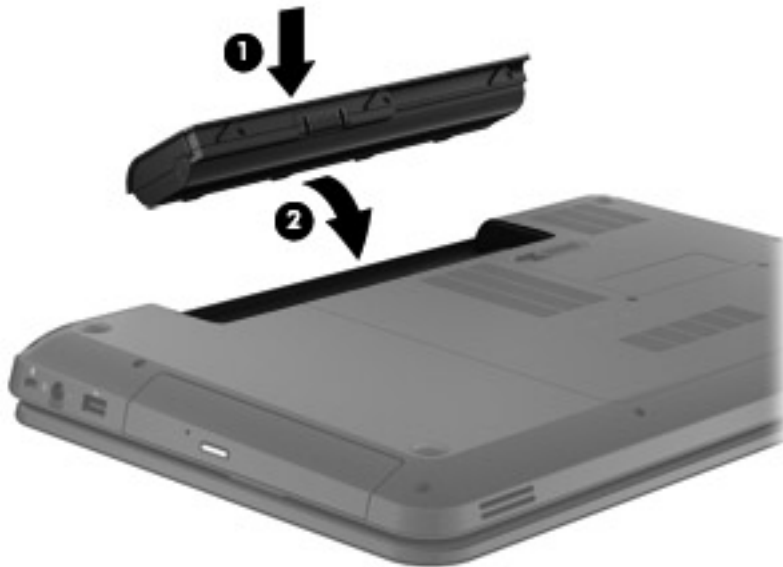

#### Removing the battery

 **CAUTION:** Removing a battery that is the sole power source for the computer can cause loss of information. To prevent loss of information, save your work and initiate Hibernation or shut down the computer through Windows before removing the battery.

---

1. Slide the battery release latch (1) to release the battery.

2. Remove the battery from the computer (2).



## Adding or replacing a hard drive

**⚠ CAUTION:** To prevent information loss or an unresponsive system:

Shut down the computer before removing the hard drive from the hard drive bay. Do not remove the hard drive while the computer is on, in the Sleep state, or in Hibernation.

If you are not sure whether the computer is off or in Hibernation, turn the computer on by pressing the power button. Then shut down the computer through the operating system.

### Removing the hard drive

1. Save your work and shut down the computer.
2. Disconnect all external devices connected to the computer.
3. Unplug the power cord from the AC outlet and remove the battery.
4. Loosen the 2 screws (1) on the service door.

5. Remove the service door (2).

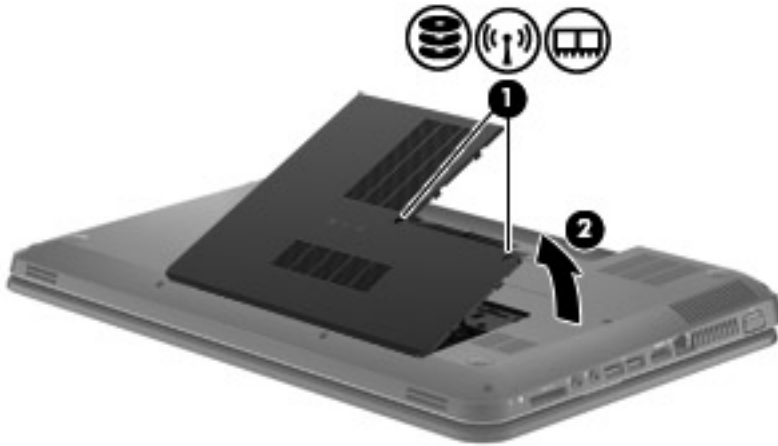

6. Disconnect the hard drive cable from the system board (1), and then lift the hard drive out of the hard drive bay (2).

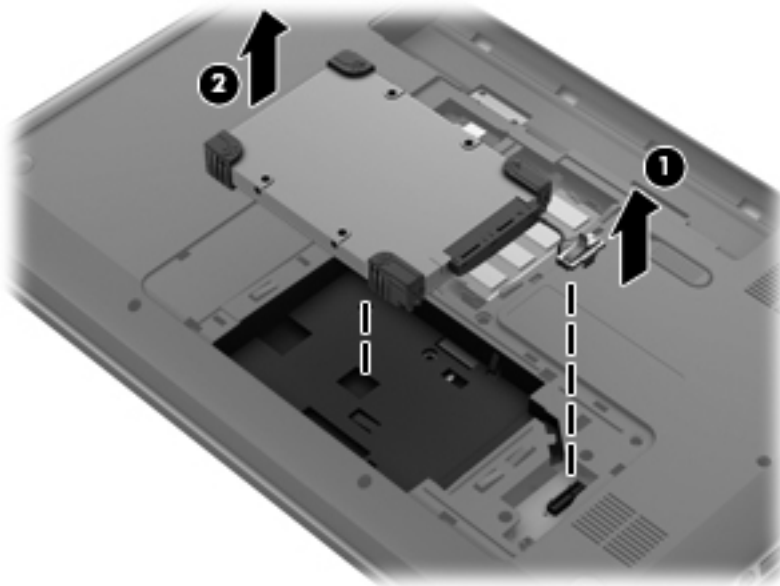

## Installing a hard drive

1. Insert the hard drive into the hard drive bay (1), and then connect the hard drive cable to the system board (2).

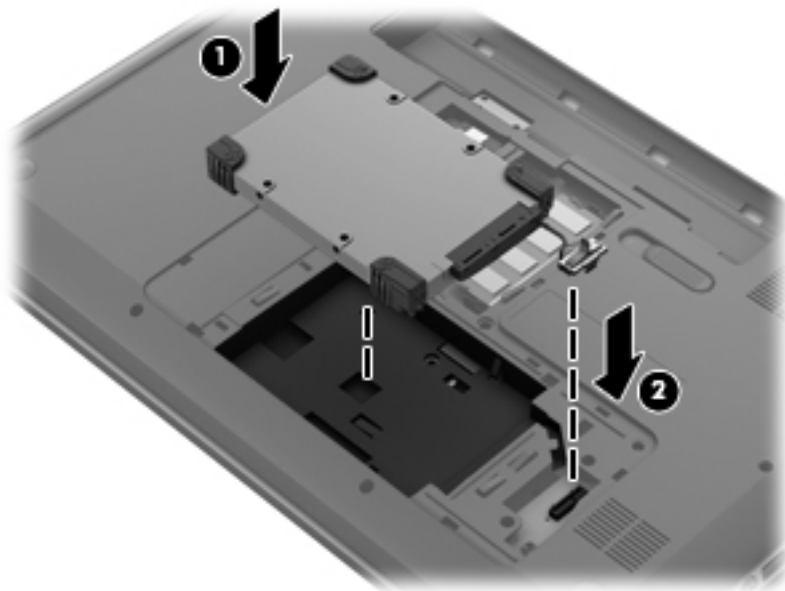

2. Align the tabs (1) on the service door with the notches on the computer.
3. Close the service door (2).
4. Tighten the 2 screws (3) on the service door.

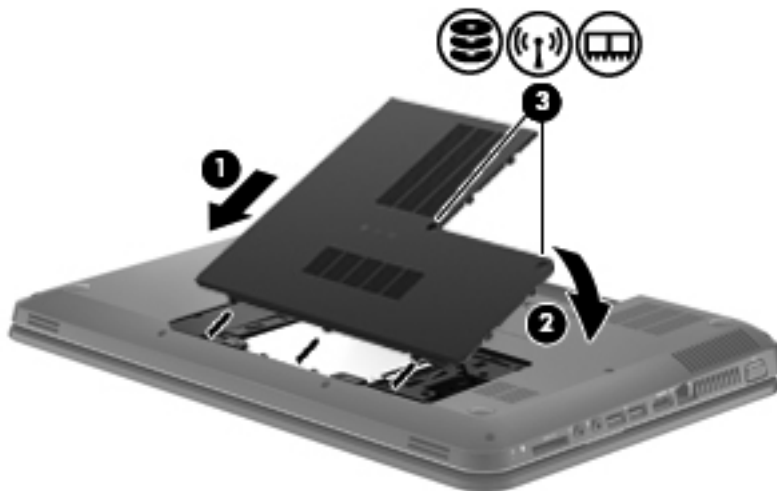

5. Replace the battery.
6. Reconnect external power and external devices.
7. Turn on the computer.

## Adding or replacing memory modules

The capacity of the computer can be upgraded by adding a memory module to the vacant expansion memory module slot or by upgrading the existing memory module in the primary memory module slot.

**WARNING!** To reduce the risk of electric shock and damage to the equipment, unplug the power cord and remove all batteries before installing a memory module.

**CAUTION:** Electrostatic discharge (ESD) can damage electronic components. Before beginning any procedure, ensure that you are discharged of static electricity by touching a grounded metal object.

**NOTE:** To use a dual-channel configuration with a second memory module, be sure that both memory modules are identical.

To add or replace a memory module:

**CAUTION:** To prevent information loss or an unresponsive system:

Shut down the computer before adding or replacing memory modules. Do not remove a memory module while the computer is on, in the Sleep state, or in Hibernation.

If you are not sure whether the computer is off or in Hibernation, turn the computer on by pressing the power button. Then shut down the computer through the operating system.

1. Save your work and shut down the computer.
2. Disconnect all external devices connected to the computer.
3. Unplug the power cord from the AC outlet and remove the battery.
4. Loosen the 2 screws (1) on the service door.
5. Remove the service door (2).

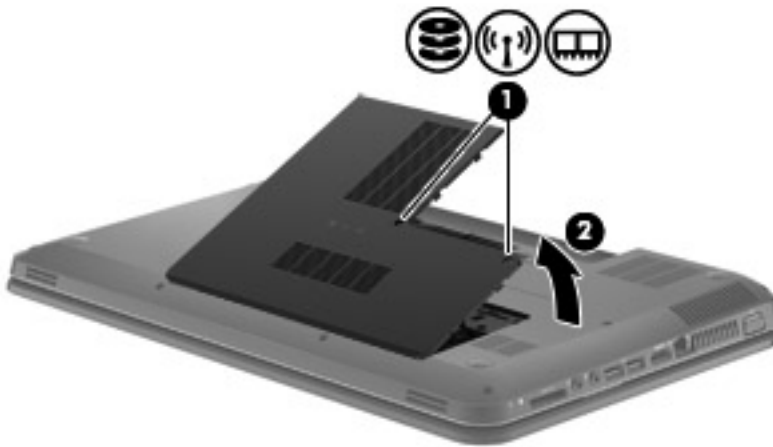



6. If you are replacing a memory module, remove the existing memory module:
  - a. Pull away the retention clips (1) on each side of the memory module. The memory module tilts up.



- b. Grasp the edge of the memory module, and then gently pull the memory module out of the memory module slot **(2)**.

---

 **NOTE:** Memory modules are designed with a notch **(3)** to prevent incorrect insertion into the memory module slot.

 **CAUTION:** To prevent damage to the memory module, hold the memory module by the edges only. Do not touch the components on the memory module.

---

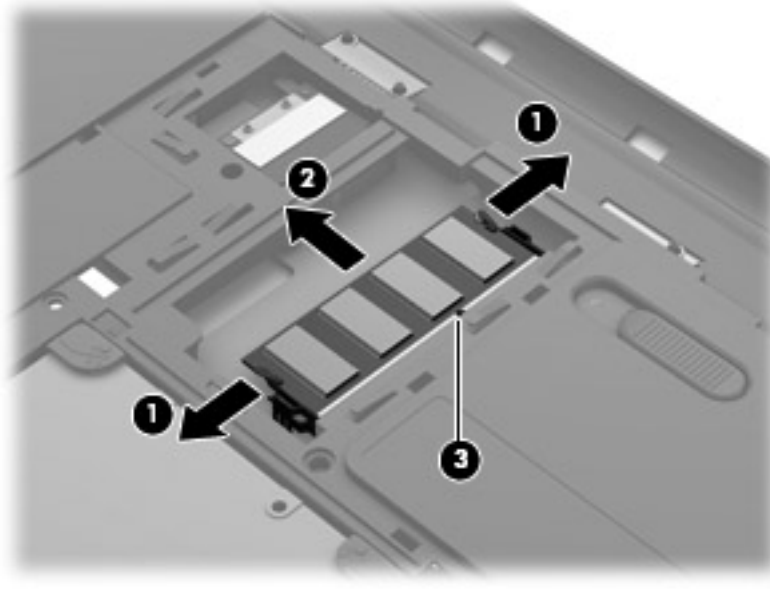

To protect a memory module after removal, place it in an electrostatic-safe container.

**7.** Insert a new memory module:

---

 **CAUTION:** To prevent damage to the memory module, hold the memory module by the edges only. Do not touch the components on the memory module.

---

- a. Align the notched edge **(1)** of the memory module with the tab in the memory module slot.
- b. With the memory module at a 45-degree angle from the surface of the memory module compartment, press the module into the memory module slot **(2)** until it is seated.

- c. Gently press the memory module (3) down, applying pressure to both the left and right edges of the module, until the retention clips snap into place.

**CAUTION:** To prevent damage to the memory module, be sure that you do not bend the module.

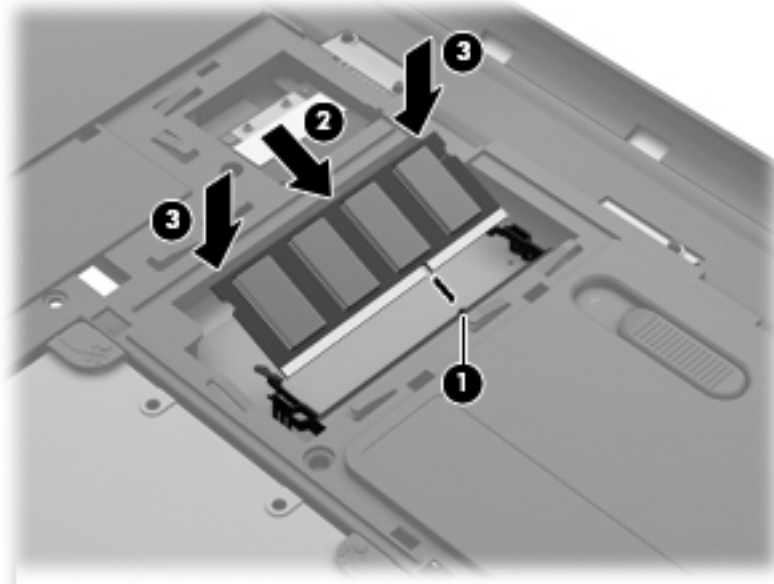

8. Align the tabs (1) on the service door with the notches on the computer.
9. Close the service door (2).
10. Tighten the 2 screws (3) on the service door.

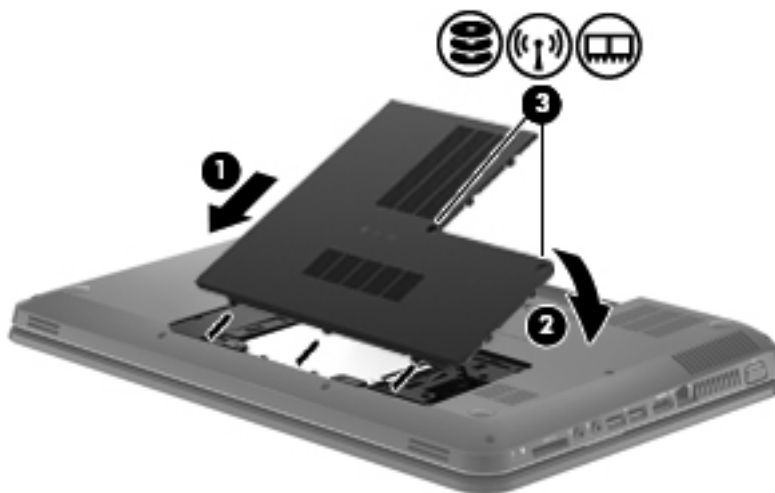

11. Replace the battery.
12. Reconnect external power and external devices.
13. Turn on the computer.

---

# 7 Backup and recovery

Your computer includes tools provided by the operating system and HP to help you safeguard your information and restore it if ever needed.

This chapter provides information on the following topics:

- Creating a set of recovery discs or a recovery flash drive (HP Recovery Manager software feature)
- Performing a system restore (from the partition, recovery discs, or a recovery flash drive)
- Backing up your information
- Recovering a program or driver

## Restore

In the event of hard drive failure, to restore your system to its factory image you will need a set of recovery discs or a recovery flash drive that you can create using HP Recovery Manager. HP recommends that you use this software to create either a set of recovery discs or a recovery flash drive immediately after software setup.

If for some other reason you need to restore your system, this can be achieved using the HP Recovery partition (select models only), without the need for recovery discs or a recovery flash drive. To check for the presence of a recovery partition, click **Start**, right-click **Computer**, click **Manage**, and then click **Disk Management**. If the recovery partition is present, a Recovery drive is listed in the window.

---

 **CAUTION:** HP Recovery Manager (partition or discs/flash drive) restores only software that was preinstalled at the factory. Software not provided with this computer must be reinstalled manually.

 **NOTE:** Recovery discs have been included if your computer does not have a recovery partition.

---

## Creating restore media

HP recommends that you create either a set of recovery discs or a recovery flash drive to be sure that you can restore your computer to its original factory state if the hard drive fails, or if for any reason you cannot restore using the recovery partition tools. Create these discs or the flash drive after setting up the computer for the first time.

---

 **NOTE:** HP Recovery Manager allows the creation of only one set of recovery discs or one recovery flash drive. Handle these discs or flash drive carefully and keep them in a safe place.

 **NOTE:** If your computer does not include an integrated optical drive, you can use an optional external optical drive (purchased separately) to create recovery discs, or you can purchase recovery discs for your computer from the HP Web site. If you use an external optical drive, it must be connected directly to a USB port on the computer, not to a USB port on an external device, such as a USB hub.

---

Guidelines:

- Purchase high-quality DVD-R, DVD+R, DVD-R DL, or DVD+R DL discs.



---

**NOTE:** Read-write discs, such as CD-RW, DVD±RW, double-layer DVD±RW, and BD-RE (rewritable Blu-ray) discs, are not compatible with the HP Recovery Manager software.

---

- The computer must be connected to AC power during this process.
- Only one set of recovery discs or one recovery flash drive can be created per computer.



---

**NOTE:** If you are creating recovery discs, number each disc before inserting it into the optical drive.

---

- If necessary, you can exit the program before you have finished creating the recovery discs or recovery flash drive. The next time you open HP Recovery Manager, you will be prompted to continue the backup creation process.

To create a set of recovery discs or a recovery flash drive:

1. Select **Start > All Programs > Security and Protection > HP Recovery Manager > HP Recovery Media Creation**.
2. Follow the on-screen instructions.

## Performing a system restore

HP Recovery Manager software allows you to repair or restore the computer to its original factory state. HP Recovery Manager works from recovery discs, a recovery flash drive, or from a dedicated recovery partition (select models only) on the hard drive.

---

 **NOTE:** A system restore needs to be performed if the computer hard drive has failed or if all attempts to correct any functional computer issues fail. A system restore should be used as a final attempt to correct computer issues.

---

Note the following when performing a system restore:

- You can restore only the system that you have previously backed up. HP recommends that you use HP Recovery Manager to create either a set of recovery discs or a recovery flash drive as soon as you set up the computer.
- Windows has its own built-in repair features, such as System Restore. If you have not already tried these features, try them before using HP Recovery Manager.
- HP Recovery Manager restores only software that was preinstalled at the factory. Software not provided with this computer must be downloaded from the manufacturer's Web site or reinstalled from the disc provided by the manufacturer.

### Restoring using the dedicated recovery partition (select models only)

When using the dedicated recovery partition, there is an option to back up pictures, music and other audio, videos and movies, recorded TV shows, documents, spreadsheets and presentations, e-mails, Internet favorites and settings during this process.

To restore the computer from the recovery partition, follow these steps:

1. Access HP Recovery Manager in either of the following ways:
  - Select **Start > All Programs > Security and Protection > HP Recovery Manager > HP Recovery Manager**.
  - or –
  - Turn on or restart the computer, and then press **esc** while the “Press the ESC key for Startup Menu” message is displayed at the bottom of the screen. Then, press **f11** while the “F11 (System Recovery)” message is displayed on the screen.
2. Click **System Recovery** in the **HP Recovery Manager** window.
3. Follow the on-screen instructions.

### Restoring using the restore media

1. If possible, back up all personal files.
2. Insert the first recovery disc into the optical drive on your computer or an optional external optical drive, and then restart the computer.

– or –

Insert the recovery flash drive into a USB port on your computer, and then restart the computer.

---

 **NOTE:** If the computer does not automatically restart in the HP Recovery Manager, the computer boot order needs to be changed.

---

3. Press **f9** at system bootup.

4. Select the optical drive or the flash drive.
5. Follow the on-screen instructions.

## Changing the computer boot order

To change the boot order for recovery discs:

1. Restart the computer.
2. Press **esc** while the computer is restarting, and then press **f9** for boot options.
3. Select **Internal CD/DVD ROM Drive** from the boot options window.

To change the boot order for recovery flash drive:

1. Insert the flash drive into a USB port.
2. Restart the computer.
3. Press **esc** while the computer is restarting, and then press **f9** for boot options.
4. Select the flash drive from the boot options window.

## Backing up and recovering your information

It is very important to back up your files and keep any new software in a safe place. As you add new software and data files, continue to create backups on a regular basis.

How completely you are able to recover your system depends on how recent your backup is.



---

**NOTE:** A recovery from your most recent backup needs to be performed if the computer has a virus attack or if any major system components fail. In order to correct computer issues, a recovery should first be attempted before a system restore is attempted.

---

You can back up your information to an optional external hard drive, a network drive, or discs. Back up your system at the following times:

- At regularly scheduled times



---

**TIP:** Set reminders to back up your information periodically.

---

- Before the computer is repaired or restored
- Before you add or modify hardware or software

Guidelines:

- Create system restore points using the Windows® System Restore feature, and periodically copy them to an optical disc or an external hard drive. For more information on using system restore points, refer to [Using Windows system restore points on page 33](#).
- Store personal files in the Documents library and back up this folder periodically.
- Save customized settings in a window, toolbar, or menu bar by taking a screen shot of your settings. The screen shot can be a time-saver if you have to re-enter your preferences.

To create a screen shot:

1. Display the screen you want to save.
2. Copy the screen image:  
To copy only the active window, press **alt+prt sc**.  
To copy the entire screen, press **prt sc**.
3. Open a word-processing document, and then select **Edit > Paste**. The screen image is added to the document.
4. Save and print the document.

## Using Windows Backup and Restore

Guidelines:

- Be sure that the computer is connected to AC power before you start the backup process.
- Allow enough time to complete the backup process. Depending on file sizes, it may take over an hour.

To create a backup:

1. Select **Start > Control Panel > System and Security > Backup and Restore**.
2. Follow the on-screen instructions to schedule and create a backup.



---

**NOTE:** Windows® includes the User Account Control feature to improve the security of the computer. You may be prompted for your permission or password for tasks such as installing software, running utilities, or changing Windows settings. Refer to Help and Support for more information.

---

## Using Windows system restore points

A system restore point allows you to save and name a snapshot of your hard drive at a specific point in time. You can then recover back to that point if you want to reverse subsequent changes.



---

**NOTE:** Recovering to an earlier restore point does not affect data files saved or e-mails created since the last restore point.

---

You also can create additional restore points to provide increased protection for your files and settings.

## When to create restore points

- Before you add or modify software or hardware
- Periodically, whenever the computer is functioning optimally



**NOTE:** If you revert to a restore point and then change your mind, you can reverse the restoration.

---

## Create a system restore point

1. Select **Start > Control Panel > System and Security > System**.
2. In the left pane, click **System Protection**.
3. Click the **System Protection** tab.
4. Follow the on-screen instructions.

## Restore to a previous date and time

To revert to a restore point (created at a previous date and time), when the computer was functioning optimally, follow these steps:

1. Select **Start > Control Panel > System and Security > System**.
2. In the left pane, click **System Protection**.
3. Click the **System Protection** tab.
4. Click **System Restore**.
5. Follow the on-screen instructions.



---

# 8 Customer support

## Contacting customer support

If the information provided in this user guide, in the *HP Notebook Reference Guide*, or in Help and Support does not address your questions, you can contact HP Customer Support at:

<http://www.hp.com/go/contactHP>

---

 **NOTE:** For worldwide support, click **Contact HP worldwide** on the left side of the page, or go to [http://welcome.hp.com/country/us/en/wwcontact\\_us.html](http://welcome.hp.com/country/us/en/wwcontact_us.html).

---

Here you can:

- Chat online with an HP technician.

---

 **NOTE:** When technical support chat is not available in a particular language, it is available in English.

---

- E-mail HP Customer Support.
- Find HP Customer Support worldwide telephone numbers.
- Locate an HP service center.

# Labels

The labels that are affixed to the computer provide information that you may need when troubleshooting system problems or traveling internationally with the computer:

- Service tag—Provides important information, including the following:

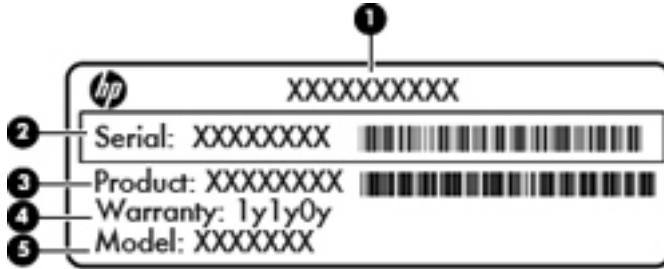

---

### Component

---

(1)	Product name
(2)	Serial number (s/n)
(3)	Part number/Product number (p/n)
(4)	Warranty period
(5)	Model description

---

Have this information available when you contact technical support. The service tag is affixed to the inside of the battery bay.

- Microsoft® Certificate of Authenticity—Contains the Windows Product Key. You may need the Product Key to update or troubleshoot the operating system. The Microsoft Certificate of Authenticity is located on the bottom of the computer.
- Regulatory label—Provides regulatory information about the computer. The regulatory label is affixed to the inside of the battery bay.
- Wireless certification label or labels (select models only)—Provide information about optional wireless devices and the approval markings of some of the countries or regions in which the devices have been approved for use. If your computer model includes one or more wireless devices, one or more certification labels are included with your computer. You may need this information when traveling internationally. Wireless certification labels are affixed to the inside of the battery bay.

# 9 Specifications

## Input power

The power information in this section may be helpful if you plan to travel internationally with the computer.

The computer operates on DC power, which can be supplied by an AC or a DC power source. The AC power source must be rated at 100–240 V, 50–60 Hz. Although the computer can be powered from a standalone DC power source, it should be powered only with an AC adapter or a DC power source supplied and approved by HP for use with this computer.

The computer can operate on DC power within the following specifications.

Input power	Rating
Operating voltage and current	18.5 V dc @ 3.5 A - 65W

## DC plug of external HP power supply



 **NOTE:** This product is designed for IT power systems in Norway with phase-to-phase voltage not exceeding 240 V rms.

 **NOTE:** The computer operating voltage and current can be found on the system regulatory label.

## Operating environment

Factor	Metric	U.S.
<b>Temperature</b>		
Operating	5°C to 35°C	41°F to 95°F
Nonoperating	-20°C to 60°C	-4°F to 140°F
<b>Relative humidity (noncondensing)</b>		
Operating	10% to 90%	10% to 90%
Nonoperating	5% to 95%	5% to 95%
<b>Maximum altitude (unpressurized)</b>		
Operating	-15 m to 3,048 m	-50 ft to 10,000 ft
Nonoperating	-15 m to 12,192 m	-50 ft to 40,000 ft

---

# Index

- A**
  - AC adapter light, identifying 7
  - action keys
    - decrease screen brightness 16
    - Help and Support 16
    - HP QuickWeb 16
    - increase screen brightness 16
    - next track 17
    - play, pause, resume 17
    - previous track 16
    - switch screen image 16
    - volume down 17
    - volume mute 17
    - volume up 17
    - wireless 17
  - Action keys, identifying 6
  - audio-in (microphone) jack, identifying 8
  - audio-out (headphone) jack, identifying 8
- B**
  - backing up
    - customized window, toolbar, and menu bar settings 32
    - personal files 32
  - battery bay 10, 36
  - battery release latch 10
  - battery, inserting 22
  - battery, removing 22
  - Bluetooth label 36
  - buttons
    - left TouchPad 3
    - power 5
    - right TouchPad 3
- C**
  - caps lock light, identifying 4
  - Certificate of Authenticity label 36
  - components
    - bottom 10
    - buttons 5
    - display 9
    - front 6
    - keys 6
    - left side 8
    - lights 4
    - right side 7
    - top 3
  - connector, power 7
- D**
  - DC plug of external HP power supply 37
  - digital media slot, identifying
    - MultiMedia Card (MMC) 8
    - Secure Digital (SD) Memory Card 8
- E**
  - esc key, identifying 6
  - external monitor port, identifying 8
- F**
  - f11 31
  - fn key, identifying 6
- H**
  - hard drive
    - installing 25
    - removing 23
  - hard drive light, identifying 9
  - HDMI port, identifying 8
  - headphone (audio-out) jack 8
  - HP Recovery Manager 31
- I**
  - input power 37
  - integrated webcam light, identifying 9
  - internal microphone, identifying 9
  - Internet connection setup 14
  - ISP, using 13
- J**
  - jacks
    - audio-in (microphone) 8
    - audio-out (headphone) 8
    - network 8
    - RJ-45 (network) 8
- K**
  - keys
    - Action keys 6
    - esc 6
    - fn 6
    - Windows applications 6
    - Windows logo 6
- L**
  - labels
    - Bluetooth 36
    - Microsoft Certificate of Authenticity 36
    - regulatory 36
    - serial number 36
    - wireless certification 36
    - WLAN 36
  - latch, battery release 10
  - lights
    - AC adapter 7
    - caps lock 4
    - hard drive 9
    - power light 9
    - webcam 9
    - wireless 4
- M**
  - memory module
    - inserting 27
    - removing 26
    - replacing 26
  - memory module compartment cover
    - removing 26
    - replacing 28
  - microphone (audio-in) jack, identifying 8
  - Microsoft Certificate of Authenticity label 36
  - mouse, external
    - setting preferences 17

- N**
- network jack, identifying 8
- O**
- operating environment 37
- operating system
  - Microsoft Certificate of Authenticity label 36
  - Product Key 36
- P**
- pinching TouchPad gesture 20
- pointing devices, setting preferences 17
- ports
  - HDMI 8
  - USB 8
- power button, identifying 5
- power connector, identifying 7
- power light, identifying 9
- Product Key 36
- product name and number, computer 36
- Q**
- QuickWeb
  - Home Screen 12
  - starting 12
- QuickWeb software 11
- R**
- recovering from the dedicated recovery partition 31
- recovering from the recovery discs 31
- recovery discs 29
- recovery, system 31
- regulatory information
  - regulatory label 36
  - wireless certification labels 36
- restore points 33
- RJ-45 (network) jack, identifying 8
- rotating TouchPad gesture 21
- S**
- scrolling TouchPad gesture 20
- security cable slot
  - security cable slot, identifying 7
- serial number 36
- serial number, computer 36
- service door, identifying 10
- setup of WLAN 14
- supported discs 30
- system recovery 31
- system restore points 33
- T**
- TouchPad
  - buttons 3
  - using 17
- TouchPad gestures
  - pinching 20
  - rotating 21
  - scrolling 20
  - zooming 20
- TouchPad light 3
- traveling with the computer 36
- U**
- USB port, identifying 8
- using system restore 33
- V**
- vents, identifying 8, 10
- W**
- webcam light, identifying 9
- webcam, identifying 9
- Windows applications key, identifying 6
- Windows logo key, identifying 6
- wireless certification label 36
- wireless light 4
- wireless network (WLAN), equipment needed 14
- wireless network, connecting 14
- wireless router, configuring 15
- wireless set up 14
- WLAN
  - connecting 14
  - protecting 15
- WLAN antennas, identifying 9
- WLAN device 36
- WLAN label 36
- Z**
- zooming TouchPad gesture 20