



HP Photosmart 6510 series



---

# Contents

<b>1</b>	<b>HP Photosmart 6510 series Help</b>	<b>3</b>
<b>2</b>	<b>Get to know the HP Photosmart</b>	
	Printer parts	6
	Control panel features	8
	Apps Manager	9
<b>3</b>	<b>How do I?</b>	<b>11</b>
<b>4</b>	<b>Paper basics</b>	
	Load media	13
<b>5</b>	<b>Print</b>	
	Print photos from a memory card	19
	Print from anywhere	20
	Tips for print success	20
<b>6</b>	<b>Copy and scan</b>	
	Scan to a computer	23
	Copy text or mixed documents	24
	Tips for copy and scan success	27
<b>7</b>	<b>Work with cartridges</b>	
	Check the estimated ink levels	29
	Clean printhead automatically	29
	Clean ink smear	30
	Replace the cartridges	30
	Align printer	32
	Order ink supplies	33
	Cartridge warranty information	33
	Tips for working with cartridges	34
<b>8</b>	<b>Connectivity</b>	
	Add the HP Photosmart to a network	35
	Change from a USB connection to a wireless network	37
	Connect a new printer	38
	Change network settings	38
	Tips for setting up and using a networked printer	38
	Advanced printer management tools (for networked printers)	39
<b>9</b>	<b>Solve a problem</b>	
	Get more help	41
	Solve print problem	41
	Solve copy and scan problem	41
	Solve networking problem	42
	HP support	44

**10 Technical information**

Notice.....47

Cartridge chip information.....47

Specifications.....48

Environmental product stewardship program.....49

Set the Energy Save mode.....53

Set Auto Power-off.....53

Regulatory notices.....53

Regulatory wireless statements.....56

**Index.....61**

---

# 1 HP Photosmart 6510 series Help

For information about the HP Photosmart, see:

- [Get to know the HP Photosmart](#)
- [How do I?](#)
- [Print](#)
- [Copy and scan](#)
- [Work with cartridges](#)
- [Connectivity](#)
- [Solve a problem](#)
- [Technical information](#)



---

## 2 Get to know the HP Photosmart

- [Printer parts](#)
- [Control panel features](#)
- [Apps Manager](#)

## Printer parts

- Front view of the HP Photosmart

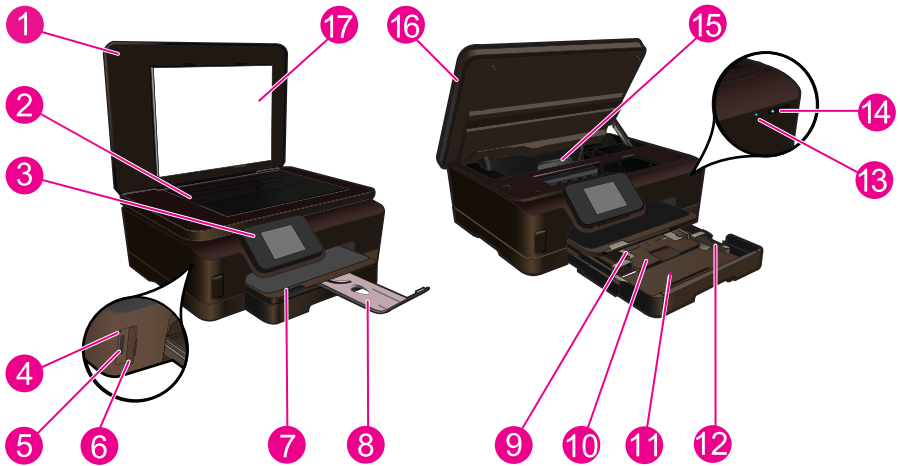

1	Lid
2	Glass
3	Color graphics display (also referred to as the display)
4	Photo light
5	Secure Digital (SD) memory card slot
6	Memory Stick slot
7	Output tray
8	Paper tray extender (also referred to as the tray extender)
9	Paper-width guide for the photo tray
10	Photo tray
11	Main tray
12	Paper-width guide for the main tray
13	Wireless LED
14	Power On/Off button
15	Printhead assembly and cartridge access area
16	Cartridge access door
17	Lid Backing



- Top and rear views of the HP Photosmart

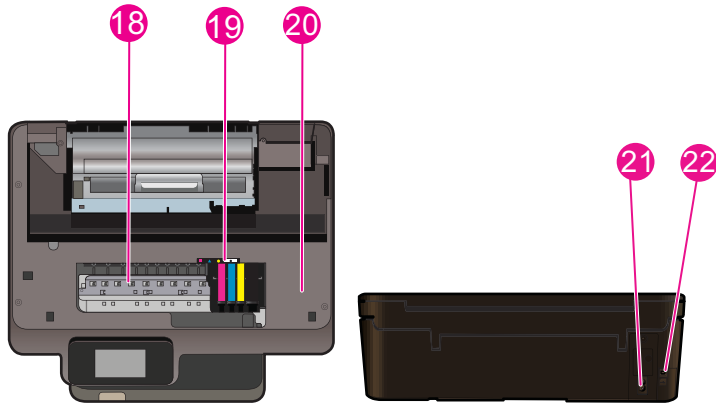

18	Printhead assembly
19	Cartridge access area
20	Model number location
21	Power connection (Use only with the power cord supplied by HP.)
22	Rear USB port

## Control panel features

Figure 2-1 Control panel features

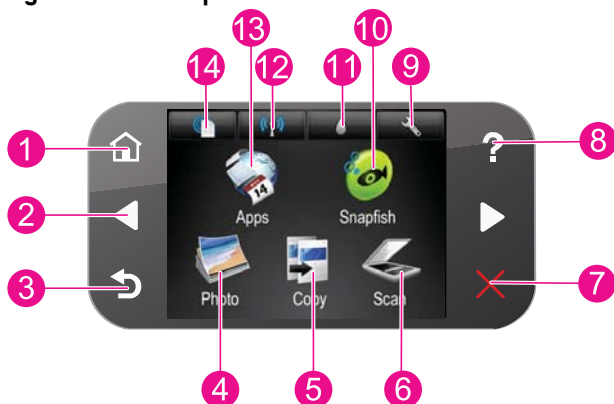

1	<b>Home:</b> Returns to the Homescreen (the default screen when you turn on the product).
2	<b>Directional keys:</b> Allow you to navigate through photos and menu options. Touch the right arrow button to access the secondary Home screen.
3	<b>Back:</b> Returns to the previous screen on the display.
4	<b>Photo:</b> Opens the <b>Photo</b> menu.
5	<b>Copy:</b> Opens the <b>Copy</b> menu where you can select a copy type or change the copy settings.
6	<b>Scan:</b> Opens the <b>Scan To</b> menu where you can select a destination for your scan.
7	<b>Cancel:</b> Stops the current operation.
8	<b>Help:</b> Opens the <b>Help</b> menu on the display where you can select a topic to learn more about it. From the Home screen, touching <b>Help</b> lists the topics for which help is available. Depending on the topic you select, the topic will appear on the display or on your computer screen. When viewing screens other than the Home screen, the <b>Help</b> button provides help applicable to the current screen.
9	<b>Setup:</b> Opens the Setup menu where you can change product settings and perform maintenance functions.
10	<b>Snapfish:</b> Opens <b>Snapfish</b> where you can upload, edit, and share your photos. <b>Snapfish</b> may not be available depending on your country/region.
11	<b>Ink:</b> Shows estimated ink levels by cartridge. Displays a warning symbol if the ink level is less than the minimum expected ink level.
12	<b>Wireless:</b> Opens the wireless menu where you can change the wireless settings.
13	<b>Apps:</b> Apps Manager provides a quick and easy way to access and print information from the Web, such as maps, coupons, coloring pages, and puzzles.
14	<b>ePrint:</b> Opens the ePrint menu where you can turn the service on or off, display the printer email address, and print an information page.

# Apps Manager

The **Apps** Manager can be used to add new **Apps** or to remove **Apps**.

## Manage Apps

- ▲ Add new **Apps**.
  - a. Touch **Apps** on the home screen.
  - b. Press the directional keys to scroll to the More menu option. Press **OK**. Check desired **Apps**. Press **OK**. Follow prompts.



---

# 3 How do I?

This section contains links to commonly performed tasks, such as printing photos, scanning, and making copies.

[Apps Manager](#)

[Replace the cartridges](#)

[Load media](#)

[Scan to a computer](#)

[Copy text or mixed documents](#)

[Clear paper jam](#)



---

# 4 Paper basics

## Load media

- ▲ Do one of the following:

### Load 10 x 15 cm (4 x 6 inch) paper

- a. Pull out paper tray.
  - Pull out photo tray and slide paper-width guide outwards.

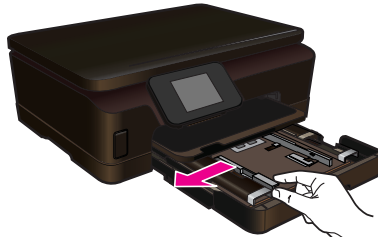

- b. Load paper.
  - Insert stack of photo paper into photo tray with short edge forward and print side down.



- ❑ Slide stack of paper forward until it stops.

---

 **NOTE:** If the photo paper you are using has perforated tabs, load photo paper so that tabs are closest to you.

---

- ❑ Slide paper-width guide inward until it stops at edge of paper.

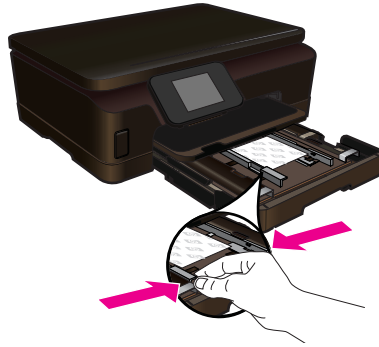

- c. Close the paper tray.

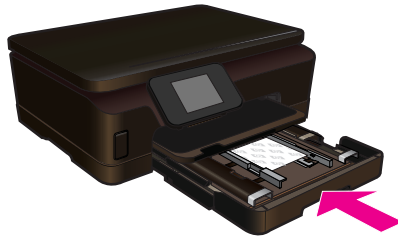



## Load A4 or 8.5 x 11 inch paper

- a. Pull out paper tray.
  - If open, close photo tray.
  - In main tray, slide paper-width guide outwards.
  - Remove any other media previously loaded.

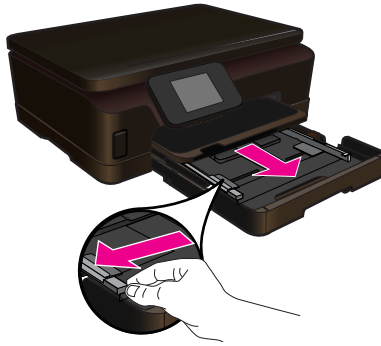

- b. Load paper.
  - Insert stack of paper into main input tray with short edge forward and print side down.



- ❑ Slide stack of paper forward until it stops.
- ❑ Slide paper-width guide inward until it stops at edge of paper.

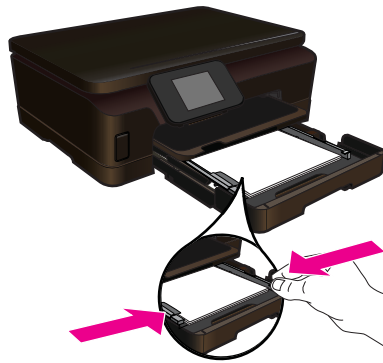

- c. Close paper tray.
- ❑ Close paper tray and pull tray extender towards you, as far as it will go. Flip paper catch at end of tray extender.



---

 **NOTE:** When you use legal-size paper, leave the paper catch closed.

---

## Load envelopes

- a. Pull out paper tray.
  - If open, close photo tray.
  - Slide paper-width guide outwards.
  - Remove all paper from the main input tray.

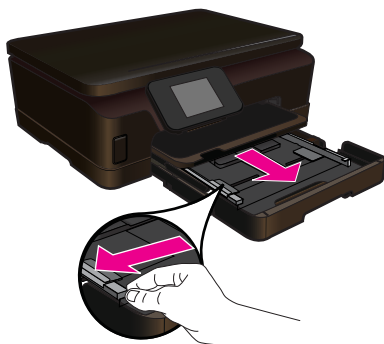

- b. Load envelopes.
  - Insert one or more envelopes into far-right side of main input tray, with envelope flaps on left and facing up.

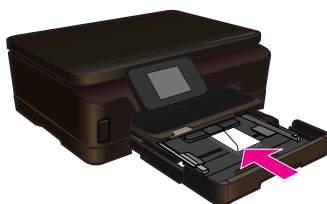

- ❑ Slide stack of envelopes forward until it stops.
- ❑ Slide paper-width guide inward against stack of envelopes until it stops.

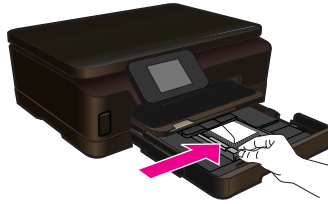

- c. Close paper tray.



# 5 Print



[Print photos from a memory card](#)



[Print from anywhere](#)

## Related topics

[Load media](#)

[Print from anywhere](#)

[Tips for print success](#)

## Print photos from a memory card

### To print photos from a memory card

1. Load photo paper into the paper tray.
2. Make sure the paper tray extender is open.
3. Insert a memory card into the memory card slot.

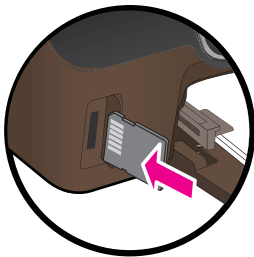

4. From the Home screen, touch **Photo** to display the **Photo** menu.
5. On the **Photo** menu, touch **View & Print** to display photos.
6. Touch a photo that you want to print.
7. Touch the up or down arrow to specify the number of photos to print.
8. Touch **Edit** to select options to edit the selected photos. You can rotate, crop a photo, or turn **Photo Fix** on and off.
9. Touch **Preview** to preview the selected photo. If you wish to adjust layout, paper type, red eye removal, or date stamp, touch **Settings**, and then touch your selection. You can also save any new settings as defaults.
10. Touch **Print** to begin printing.

**Related topics**[Load media](#)[Tips for print success](#)

## Print from anywhere

The HP ePrint feature on your product provides convenience printing that allows you to print from anywhere. Once enabled, ePrint assigns an email address to your product. To print, simply send an email containing your document to that address. You can print images, Word, PowerPoint, and PDF documents. It's easy!

---

 **NOTE:** Documents printed with ePrint may appear different from the original. Style, formatting, and text flow may differ from the original document. For documents that need to be printed with a higher quality (such as legal documents), we recommend that you print from the software application on your computer, where you will have more control over what your printout looks like.

---

**To print a document from anywhere**

1. Find your ePrint email address.

- a. Touch the Web Service icon on the Home screen.
- b. Touch Display Email Address.

---

 **TIP:** To print the email address or registration url, touch Print Info Sheet on the Web Services Settings menu.

---

2. Compose and send email.

- a. Create a new email and type the product email address in the **To** box.
- b. Type text in the body of the email and attach the documents or images that you want to print.
- c. Send the email.  
The product prints your email.

---

 **NOTE:** To use ePrint, you first need to have your printer connected wirelessly to a network and Web Services enabled. You also need to create an ePrintCenter account if you do not already have one. Your email will print as soon as it is received. As with any email, there is no guarantee when or if it will be received. When you register online with ePrint, you can check the status of your jobs.

---

## Tips for print success

Use the following tips to print successfully.

### Tips for printing from computer

If you want to print documents, photos, or envelopes from computer, click the following links. They will direct you to online instructions according to the operating system you are using.

- Learn how to print documents from computer. [Click here to go online for more information.](#)
- Learn how to print photos saved on your computer. Learn information about print resolution and how to enable maximum dpi resolution. [Click here to go online for more information.](#)
- Learn how to print envelopes from computer. [Click here to go online for more information.](#)

### Tips for ink and paper

- Use genuine HP cartridges. Genuine HP cartridges are designed for and tested with HP printers to help you produce great results, time after time.
- Make sure the cartridges have sufficient ink. To view the estimated ink levels, touch the **Ink** icon from the Home screen.
- To learn more tips about working with cartridges, see [Tips for working with cartridges](#) for more information.
- Load a stack of paper, not just one page. Use clean and flat paper of the same size. Make sure only one type of paper is loaded at a time.
- Adjust the paper-width guides in the paper tray to fit snugly against all paper. Make sure the paper-width guides do not bend the paper in the paper tray.
- Set the print quality and paper size settings according to the type and size of paper loaded in the paper tray.
- To clear paper jam, see [Clear paper jam](#) for more information.

### Tips for printing apps and using ePrint

- Learn how to share your photos online and order prints. [Click here to go online for more information.](#)
- Learn about apps for printing recipes, coupons, and other content from the web, simply and easily. [Click here to go online for more information.](#)
- Learn how to print from anywhere by sending an email and attachments to your printer. [Click here to go online for more information.](#)
- If you have enabled **Auto Power-Off**, you should disable **Auto Power-Off** to use ePrint. See [Set Auto Power-off](#) for more information.





---

# 6 Copy and scan

- [Scan to a computer](#)
- [Copy text or mixed documents](#)
- [Tips for copy and scan success](#)

## Scan to a computer

### To scan to a computer

1. Load original.
  - a. Lift lid on product.



- b. Load original print side down on right front corner of glass.

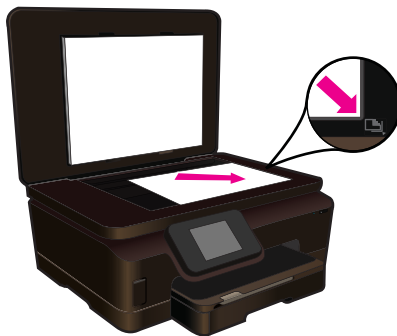

- c. Close lid.
2. Start scan.
  - a. Touch **Scan** on Home screen.  
The **Scan To** menu appears.
  - b. Touch **Computer**.  
If product is network-connected, a list of available computers appears. Select computer to which you want to transfer to start the scan.
3. Touch job shortcut you want to use.
4. Touch Start Scan.

### Related topics

[Tips for copy and scan success](#)

## Copy text or mixed documents

- ▲ Do one of the following:

### Make a black and white copy

- a. Load paper.
  - Load full-size paper in main input tray.

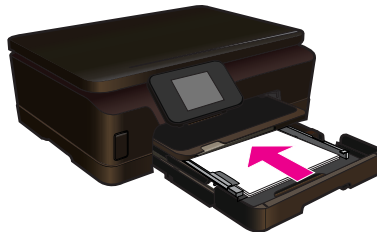

- b. Load original.
  - Lift lid on product.



- Load original print side down on right front corner of glass.

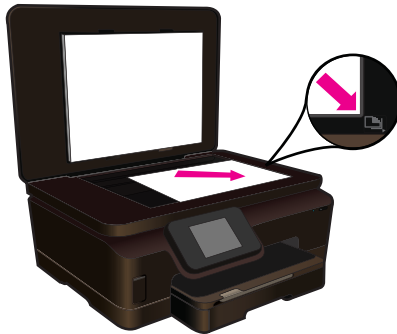

- Close lid.
- c. Select Copy.
- Touch **Copy** on Home screen.  
The **Copy** menu appears.
  - Touch up arrow to increase number of copies.
  - Touch **Settings**.  
The **Copy Settings** menu appears.
  - To change default copy settings, specify desired paper size, paper type, quality and other settings.
- d. Start copy.
- Touch **Black Copy**.

**Make a color copy**

- a. Load paper.
  - Load full-size paper in main input tray.



- b. Load original.
  - Lift lid on product.



---

 **TIP:** To make copies of thick originals, such as books, you can remove the lid.

---

- Load original print side down on right front corner of glass.

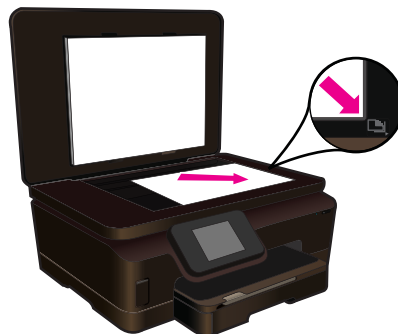

- Close lid.

- c. Select Copy.
  - Touch **Copy** on Home screen.  
The **Copy** menu appears.
  - Touch up arrow to increase number of copies.
  - Touch **Settings**.  
The **Copy Settings** menu appears.
  - To change default copy settings, specify desired paper size, paper type, quality and other settings.
- d. Start copy.
  - Touch **Color Copy**.

#### Related topics

- [Load media](#)
- [Tips for copy and scan success](#)

## Tips for copy and scan success

Use the following tips to copy and scan successfully:

- Learn how to scan when your printer is on a wireless network and not nearby your computer.  [Click here to go online for more information.](#)
- Keep the glass and the back of the lid clean. The scanner interprets anything it detects on the glass as part of the image.
- Load your original, print side down, on the right front corner of the glass.
- To copy or scan a book or other thick originals, remove the lid.
- To make a large copy of a small original, scan the original into the computer, resize the image in the scanning software, and then print a copy of the enlarged image.
- To avoid incorrect or missing scanned text, make sure the brightness is set appropriately in the software.
- If the scanned image is incorrectly cropped, turn off the autocropping feature in the software and crop the scanned image manually.



---

# 7 Work with cartridges

- [Check the estimated ink levels](#)
- [Clean printhead automatically](#)
- [Clean ink smear](#)
- [Replace the cartridges](#)
- [Align printer](#)
- [Order ink supplies](#)
- [Cartridge warranty information](#)
- [Tips for working with cartridges](#)

## Check the estimated ink levels

From the Home screen, touch the right directional key, and then touch the **Ink** icon to display the estimated ink levels.

---

 **NOTE:** If you have installed a refilled or remanufactured cartridge, or a cartridge that has been used in another printer, the ink level indicator might be inaccurate or unavailable.

**NOTE:** Ink level warnings and indicators provide estimates for planning purposes only. When you receive a low-ink warning message, consider having a replacement cartridge available to avoid possible printing delays. You do not have to replace the cartridges until the print quality is unacceptable.

**NOTE:** Ink from the cartridges is used in the printing process in a number of different ways, including in the initialization process, which prepares the product and cartridges for printing, and in printhead servicing, which keeps print nozzles clear and ink flowing smoothly. In addition, some residual ink is left in the cartridge after it is used. For more information, see [www.hp.com/go/inkusage](http://www.hp.com/go/inkusage).

---

### Related topics

[Order ink supplies](#)

[Tips for working with cartridges](#)

## Clean printhead automatically

If print quality is unacceptable, and the problem is not low ink levels or non-HP ink, try cleaning the printhead from the printer display. Full-size paper needs to be loaded and an information page will be printed out at the end.

### To clean printhead from the printer display

1. From the Home screen, touch the right directional key. Touch the **Setup** icon, and then touch **Tools**.
2. On the **Tools** menu, touch the down arrow to scroll through the options, and then touch **Clean Printhead**.

### Related topics

[Order ink supplies](#)

[Tips for working with cartridges](#)

## Clean ink smear

If printouts shows smears of ink, try cleaning ink smear from the printer display. This process takes several minutes to complete. Full-size plain paper needs to be loaded and will be moved back and forth during the cleaning. Mechanical noises are normal at this time.

### To clean ink smear from the printer display

1. From the Home screen, touch the right directional key. Touch the **Setup** icon, and then touch **Tools**.
2. On the **Tools** menu, touch the down arrow to scroll through the options, and then touch **Clean Ink Smear**.

### Related topics

[Order ink supplies](#)

[Tips for working with cartridges](#)

## Replace the cartridges

### To replace the cartridges

1. Check that power is on.
2. Remove cartridge.
  - a. Open the cartridge access door.

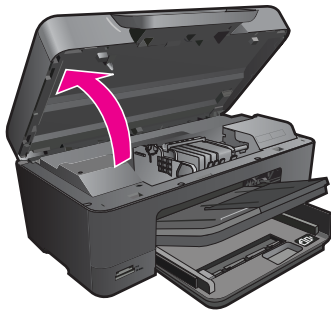



Wait for print carriage to move to the ink label part of the product.

- b. Press tab on cartridge, then remove it from slot.

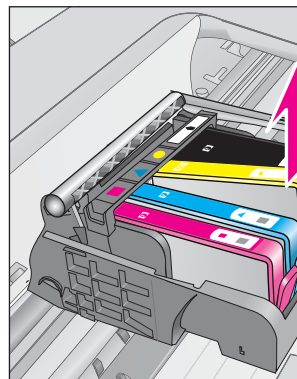
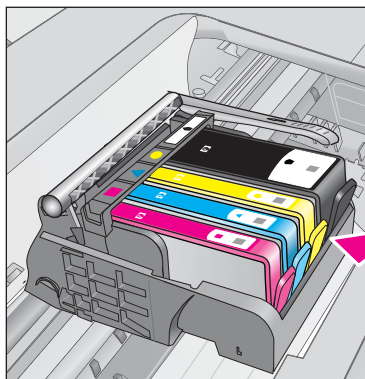

- 3. Insert new cartridge.

- a. Remove cartridge from packaging.

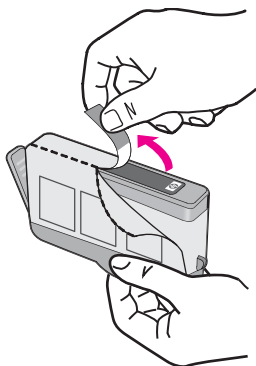

- b. Twist orange cap to snap it off. A forceful twist may be required to remove cap.

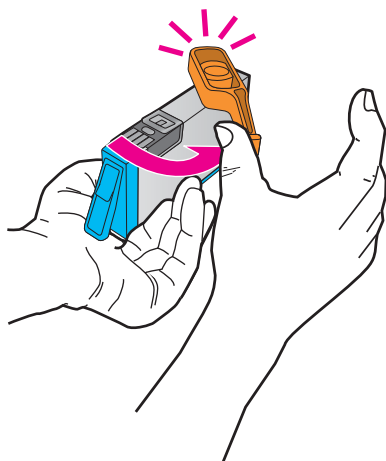

- c. Match color icons, then slide cartridge into slot until it clicks into place.

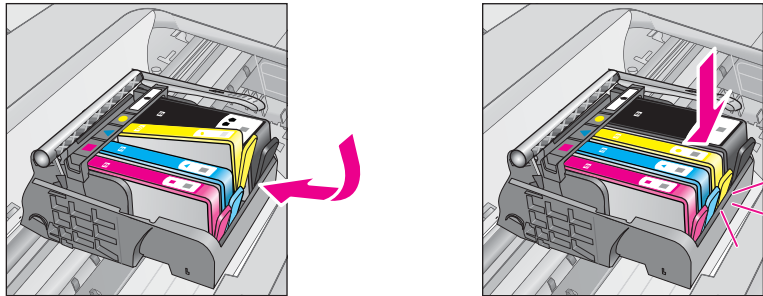

- d. Close the cartridge access door.

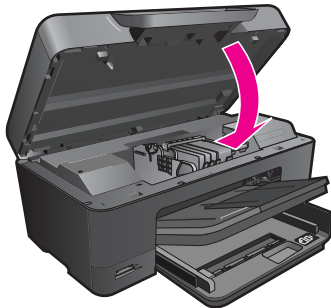

**Related topics**

[Order ink supplies](#)

[Tips for working with cartridges](#)

## Align printer

After you insert new cartridges, align the printer for best print quality. You can align printer either from the printer display or from the printer software.

**To align printer from the printer display**

1. From the Home screen, touch the right directional key. Touch the **Setup** icon, and then touch **Tools**.
2. On the **Tools** menu, touch the down arrow to scroll through the options, and then touch **Align Printer**.
3. Follow the instruction on the screen.

## To align printer from the printer software

Do one of the following according to the operating system you are using.

1. On Windows:
  - a. From the **Start** menu on your computer, click **All Programs**, click **HP**.
  - b. Click the **HP Photosmart 6510 series** folder, click **HP Photosmart 6510 series**.
  - c. Double-click **Printer Preferences**, and then double-click **Maintenance Tasks**.
  - d. Click the **Device Services** tab, and then click the **Align Ink Cartridges** button.
2. On Mac:
  - ▲ Open **HP Utility**, click **Align**, and then click **Align** again.

### Related topics

[Order ink supplies](#)

[Tips for working with cartridges](#)

## Order ink supplies

To find the correct model number for replacement cartridges, open the printer cartridge access door and check the label.

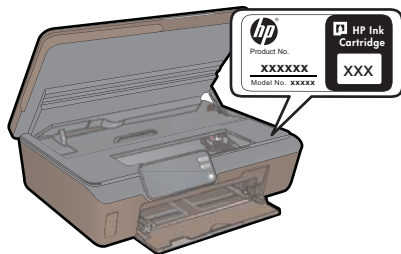

Cartridge information and links to online shopping also appear on ink alert messages. In addition, you can find cartridge information and order online by visiting [www.hp.com/buy/supplies](http://www.hp.com/buy/supplies).

 **NOTE:** Ordering cartridges online is not supported in all countries/regions. If it is not supported in your country/region, contact a local HP reseller for information about purchasing cartridges.

## Cartridge warranty information

The HP cartridge warranty is applicable when the product is used in its designated HP printing device. This warranty does not cover HP ink products that have been refilled, remanufactured, refurbished, misused, or tampered with.

During the warranty period the product is covered as long as the HP ink is not depleted and the end of warranty date has not been reached. The end of warranty date, in YYYY/MM format, may be found on the product as indicated:

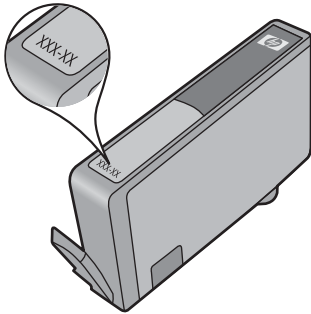

For a copy of the HP Limited Warranty Statement, see the printed documentation that came with the product.

## Tips for working with cartridges

Use the following tips to work with cartridges:

- Use the correct cartridges for your printer. For a list of compatible cartridges, see the printed documentation that came with the printer.
- Insert the cartridges into the correct slots. Match the color and icon of each cartridge to the color and icon for each slot. Make sure all cartridges snap down into place.
- After you insert new cartridges, align the printer for best print quality. See [Align printer](#) for more information.
- Make sure the printhead is clean. See [Clean printhead automatically](#) for more information.
- When you receive a low ink alert message, consider getting replacement cartridges. This avoids possible printing delays. You do not need to replace the cartridges until print quality becomes unacceptable. See [Replace the cartridges](#) for more information.
- If you receive a carriage stalled error, try clearing carriage jam. See [Clear the print carriage](#) for more information.

# 8 Connectivity

- [Add the HP Photosmart to a network](#)
- [Change from a USB connection to a wireless network](#)
- [Connect a new printer](#)
- [Change network settings](#)
- [Tips for setting up and using a networked printer](#)
- [Advanced printer management tools \(for networked printers\)](#)

## Add the HP Photosmart to a network

- [WiFi Protected Setup \(WPS\)](#)
- [Wireless with a router \(infrastructure network\)](#)

### WiFi Protected Setup (WPS)

To connect the HP Photosmart to a wireless network using WiFi Protected Setup (WPS), you will need the following:

- ❑ A wireless 802.11b/g/n network that includes a WPS-enabled wireless router or access point.

---

 **NOTE:** 802.11n will only support 2.4Ghz.

---

- ❑ A desktop computer or laptop with either wireless networking support, or a network interface card (NIC). The computer must be connected to the wireless network that you intend to install the HP Photosmart on.

### To connect the HP Photosmart using WiFi Protected Setup (WPS)

- ▲ Do one of the following:

#### Use Push Button Configuration (PBC) method

- a. Select setup method. Make sure your WPS-enabled wireless router supports PBC method.
  - ❑ From the Home screen, touch the right directional key, and then touch the **Wireless** icon.
  - ❑ Touch **WiFi Protected Setup**.
  - ❑ Touch **Push Button**.
- b. Set up wireless connection.
  - ❑ Turn on wireless radio if it is off.
  - ❑ Touch **Start**.

- ❑ Press and hold the button on WPS-enabled router or other networking device to activate WPS.

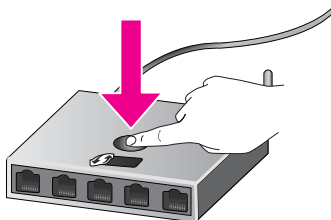

---

 **NOTE:** The product begins a timer for approximately two minutes in which the corresponding button on the networking device needs to be pressed.

---

- ❑ Touch **OK**.
- c. Install software.

### Use PIN method

- a. Select setup method. Make sure your WPS-enabled wireless router supports PIN method.
- ❑ From the Home screen, touch the right directional key, and then touch the **Wireless** icon.
  - ❑ Touch **WiFi Protected Setup**.
  - ❑ Touch **PIN**.
- b. Set up wireless connection.
- ❑ Touch **Start**.
  - ❑ Turn on wireless radio if it is off.

---

 **NOTE:** The product begins a timer for approximately five minutes in which the PIN needs to be entered on the networking device.

---

- ❑ Touch **OK**.
- c. Install software.

### Related topics

[Tips for setting up and using a networked printer](#)

## Wireless with a router (infrastructure network)

To connect the HP Photosmart to an integrated wireless WLAN 802.11 network, you will need the following:

- ❑ A wireless 802.11b/g/n network that includes a wireless router or access point.

---

 **NOTE:** 802.11n will only support 2.4Ghz.

---

- ❑ A desktop computer or laptop with either wireless networking support, or a network interface card (NIC). The computer must be connected to the wireless network that you intend to install the HP Photosmart on.

- ❑ Broadband Internet access (recommended) such as cable or DSL.  
If you connect the HP Photosmart on a wireless network that has Internet access, HP recommends that you use a wireless router (access point or base station) that uses Dynamic Host Configuration Protocol (DHCP).
- ❑ Network name (SSID).
- ❑ WEP key or WPA Passphrase (if needed).

### To connect the product with the Wireless Setup Wizard

1. Write down your network name (SSID) and WEP key or WPA passphrase.
2. Start Wireless Setup Wizard.
  - a. From the Home screen, touch the right directional key, and then touch the **Wireless** icon.
  - b. Touch **Wireless Setup Wizard**.
3. Connect to wireless network.
  - ▲ Select your network from the list of detected networks.
4. Follow prompts.
5. Install software.

### Related topics

[Tips for setting up and using a networked printer](#)

## Change from a USB connection to a wireless network

If you first setup your printer and installed the software with a USB cable, directly connecting the printer to your computer, you can easily change to a wireless network connection. You will need a wireless 802.11b/g/n network that includes a wireless router or access point.

---

 **NOTE:** 802.11n will only support 2.4Ghz.

---

### To change from a USB connection to a wireless network

Do one of the following according to your operating system.

1. On Windows:
  - a. From the **Start** menu on your computer, click **All Programs**, and then click **HP**.
  - b. Click **HP Photosmart 6510 series**, click **Printer Setup & Software Selection**, and then click **Convert a USB connected printer to wireless**.
  - c. Follow the instructions on the screen.
2. On Mac:
  - a. From the Home screen on the printer display, touch the right directional key.
  - b. Touch the **Wireless** icon, and then touch **Wireless Setup Wizard**.
  - c. Follow the instructions on the screen to connect the printer.
  - d. Use **HP Setup Assistant** in Applications/Hewlett-Packard/Device Utilities to change the software connection to this printer to wireless.

## Connect a new printer

### To connect a new printer from the printer software

If you haven't finished connecting the printer to your computer, you need to connect it from the printer software. If you want to connect another new printer of the same model to your computer, you don't need to install the printer software once again. Do one of following according to your operating system:

1. On Windows:
  - a. From the **Start** menu on your computer, click **All Programs**, and then click **HP**.
  - b. Click **HP Photosmart 6510 series**, click **Printer Connections and Software**, and then click **Connect a new printer**
  - c. Follow the instructions on the screen.
2. On Mac:
  - a. From the Home screen on the printer display, touch the right directional key.
  - b. Touch the **Wireless** icon, and then touch **Wireless Setup Wizard**.
  - c. Follow the instructions on the screen to connect the printer.
  - d. Use **HP Setup Assistant** in Applications/Hewlett-Packard/Device Utilities to change the software connection to this printer to wireless.

## Change network settings

If you want to change the wireless settings that you previously configured to a network, you need to run the Wireless Setup Wizard from the printer display.

### To run Wireless Setup Wizard to change network settings

1. From the Home screen on the printer display, touch the right directional key, and then touch the **Wireless** icon.
2. On the wireless menu, touch **Wireless Setup Wizard**.
3. Follow the instructions on the screen to change the network settings.

## Tips for setting up and using a networked printer

Use the following tips to set up and use a networked printer:

- When setting up the wireless networked printer, make sure your wireless router is powered on. The printer searches for wireless routers, then lists the detected network names on the display.
- To verify the wireless connection, touch the **Wireless** button on the control panel. If it shows **Wireless Off**, touch **Turn On**.
- If your computer is connected to a Virtual Private Network (VPN), you need to disconnect from the VPN before you can access any other device on your network, including the printer.
- Learn more about configuring your network and the printer for wireless printing. [Click here to go online for more information.](#)



- Learn how to find your network security settings. [Click here to go online for more information.](#)
- Learn about the Network Diagnostic Utility (Windows only) and other troubleshooting tips. [Click here to go online for more information.](#)
- Learn how to change from a USB to wireless connection. See [Change from a USB connection to a wireless network](#) for more information.
- Learn how to work with your firewall and anti-virus programs during printer setup. [Click here to go online for more information.](#)

## Advanced printer management tools (for networked printers)

When the printer is connected to a network, you can use the embedded Web server to view status information, change settings, and manage the printer from your computer.

---

 **NOTE:** To view or change some settings, you might need a password.

You can open and use the embedded Web server without being connected to the Internet. However, some features are not available.

- 
- [To open the embedded Web server](#)
  - [About cookies](#)

### To open the embedded Web server

---

 **NOTE:** The printer must be on a network and must have an IP address. The IP address for the printer can be found by touching the **Wireless** button on the control panel or by printing a network configuration page.

In a supported Web browser on your computer, type the IP address or hostname that has been assigned to the printer.

For example, if the IP address is 192.168.0.12, type the following address into a Web browser such as Internet Explorer: <http://192.168.0.12>.

### About cookies

The embedded Web server (EWS) places very small text files (cookies) on your hard drive when you are browsing. These files let the EWS recognize your computer the next time you visit. For example, if you have configured the EWS language, a cookie helps remember which language you have selected so that the next time you access the EWS, the pages are displayed in that language. Though some cookies are cleared at the end of each session (such as the cookie that stores the selected language), others (such as the cookie that stores customer-specific preferences) are stored on the computer until you clear them manually.

You can configure your browser to accept all cookies, or you can configure it to alert you every time a cookie is offered, which allows you to decide which cookies to accept or refuse. You can also use your browser to remove unwanted cookies.

---

 **NOTE:** Depending on your printer, if you disable cookies, you also disable one or more of the following features:

---

- Starting where you left the application (especially useful when using setup wizards).
- Remembering the EWS browser language setting.
- Personalizing the EWS Home page.

For information about how to change your privacy and cookie settings and how to view or delete cookies, see the documentation available with your Web browser.

---

# 9 Solve a problem

This section contains the following topics:

- [Get more help](#)
- [Solve print problem](#)
- [Solve copy and scan problem](#)
- [Solve networking problem](#)
- [HP support](#)

## Get more help

You can find more information and help about your HP Photosmart by entering a keyword in the **Search** field in the top left of the help viewer. Titles of related topics – for both local and online topics – will be listed.



[Click here to go online for more information.](#)

## Solve print problem

Make sure that the printer is turned on and that there is paper in the paper tray. If you are still unable to print, HP provides a Print Diagnostic Utility (Windows only) that can help solve many common “Unable to Print” issues.



[Click here to go online for more information.](#)

If print quality is not acceptable, try the following to improve print quality:

- Use printer status and print quality report to diagnose printer and print quality issues. From the Home screen, touch the right directional key, touch **Setup**, and then touch **Tools**. Touch the down arrow to scroll through options, and then touch **Printer Status Report** or **Print Quality Report**. [Click here to go online for more information](#)
- If printouts show misaligned colors or lines, try aligning printer. See [Align printer](#) for more information.
- If ink smears on the printouts, try clearing ink smear from the print display. See [Clean ink smear](#) for more information.

## Solve copy and scan problem

HP provides a Scan Diagnostic Utility (Windows only) that can help solve many common “Unable to scan” issues.

Learn more about how to solve scan issues. [Click here to go online for more information](#)

Learn how to solve copy issues. [Click here to go online for more information.](#)

## Solve networking problem

Check network configuration or print wireless test report to assist in diagnosing network connection issues.

### To check network configuration or print wireless test report

1. From the Home screen, touch the right directional key, and then touch the **Wireless** icon.
2. On the **Wireless Settings** menu, use the down arrow to scroll through options, and then touch **Display Network Configuration** or **Print Wireless Test Report**.

Click the links below to find more online information to solve networking issues.

- Learn more about wireless printing. [Click here to go online for more information.](#)
- Learn how to find your network security settings. [Click here to go online for more information.](#)
- Learn about the Network Diagnostic Utility (Windows only) and other troubleshooting tips. [Click here to go online for more information.](#)
- Learn how to work with your firewall and anti-virus programs during printer setup. [Click here to go online for more information.](#)

## Clear the print carriage

Remove any objects, such as paper, that are blocking the print carriage.

---

 **NOTE:** Do not use any tools or other devices to remove jammed paper. Always use caution when removing jammed paper from inside the product.

---



[Click here to go online for more information.](#)

## Clear paper jam

### To clear a paper jam

1. Open the cartridge access door.

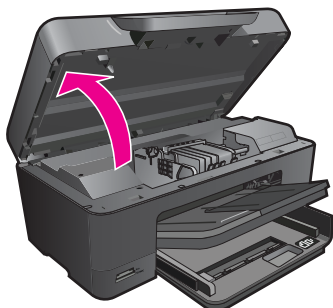

2. Open the paper path cover.

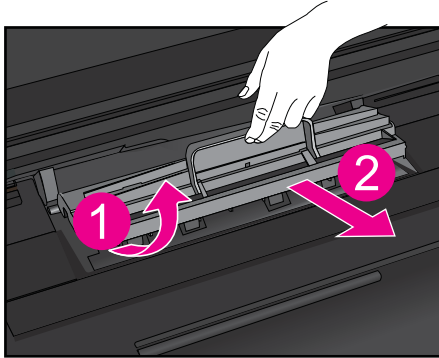

3. Remove jammed paper.
4. Close the paper path cover.

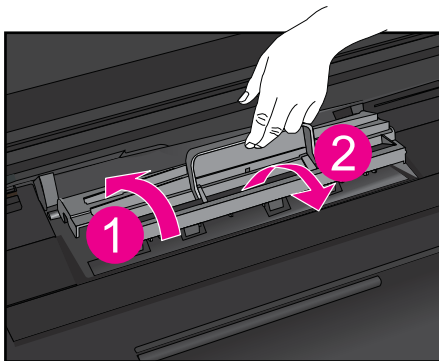

5. Close the cartridge access door.

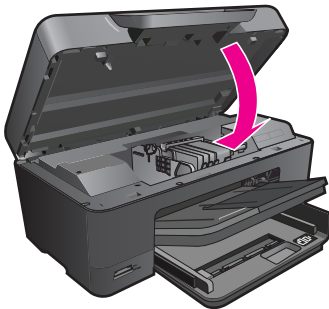

6. Try printing again.

## HP support

- [Register the product](#)
- [HP support by phone](#)
- [Additional warranty options](#)

### Register the product

By taking just a few quick minutes to register, you can enjoy quicker service, more efficient support, and product support alerts. If you did not register your printer while installing the software, you can register now at <http://www.register.hp.com>.

### HP support by phone

Phone support options and availability vary by product, country/region, and language.

This section contains the following topics:

- [Phone support period](#)
- [Placing a call](#)
- [After the phone support period](#)

#### Phone support period

One year of phone support is available in North America, Asia Pacific, and Latin America (including Mexico). To determine the duration of phone support in Europe, the Middle East, and Africa, go to [www.hp.com/support](http://www.hp.com/support). Standard phone company charges apply.

#### Placing a call

Call HP support while you are in front of the computer and the product. Be prepared to provide the following information:

- Product name (HP Photosmart 6510 series)
- Serial number (located on the back or bottom of the product)
- Messages that appear when the situation occurs
- Answers to these questions:
  - Has this situation happened before?
  - Can you re-create it?
  - Did you add any new hardware or software to your computer at about the time that this situation began?
  - Did anything else occur prior to this situation (such as a thunderstorm, product was moved, etc.)?

For the list of support phone numbers, visit [www.hp.com/support](http://www.hp.com/support).

#### After the phone support period

After the phone support period, help is available from HP at an additional cost. Help may also be available at the HP online support Web site: [www.hp.com/support](http://www.hp.com/support).

Contact your HP dealer or call the support phone number for your country/region to learn more about support options.

### **Additional warranty options**

Extended service plans are available for the HP Photosmart at additional costs. Go to [www.hp.com/support](http://www.hp.com/support), select your country/region and language, then explore the services and warranty area for information about the extended service plans.





# 10 Technical information

The technical specifications and international regulatory information for the HP Photosmart are provided in this section.

For additional specifications, see the printed documentation that came with the HP Photosmart.

This section contains the following topics:

- [Notice](#)
- [Cartridge chip information](#)
- [Specifications](#)
- [Environmental product stewardship program](#)
- [Set the Energy Save mode](#)
- [Set Auto Power-off](#)
- [Regulatory notices](#)
- [Regulatory wireless statements](#)

## Notice

### Hewlett-Packard Company notices

The information contained in this document is subject to change without notice.

All rights reserved. Reproduction, adaptation, or translation of this material is prohibited without prior written permission of Hewlett-Packard, except as allowed under copyright laws. The only warranties for HP products and services are set forth in the express warranty statements accompanying such products and services. Nothing herein should be construed as constituting an additional warranty. HP shall not be liable for technical or editorial errors or omissions contained herein.

© 2011 Hewlett-Packard Development Company, L.P.

Microsoft, Windows, Windows XP, and Windows Vista are U.S. registered trademarks of Microsoft Corporation.

Windows 7 is either a registered trademark or trademark of Microsoft Corporation in the United States and/or other countries.

Intel and Pentium are trademarks or registered trademarks of Intel Corporation or its subsidiaries in the United States and other countries.

Adobe® is a trademark of Adobe Systems Incorporated.

## Cartridge chip information

The HP cartridges used with this product contain a memory chip that assists in the operation of the product. In addition, this memory chip collects a limited set of information about the usage of the product, which might include the following: the date when the cartridge was first installed, the date when the cartridge was last used, the number of pages printed using the cartridge, the page coverage, the printing modes used, any printing errors that might have occurred, and the product model. This information helps HP design future products to meet our customers printing needs.

The data collected from the cartridge memory chip does not contain information that can be used to identify a customer or user of the cartridge or their product.

HP collects a sampling of the memory chips from cartridges returned to HP's free return and recycling program (HP Planet Partners: [www.hp.com/hpinfo/globalcitizenship/environment/recycle/](http://www.hp.com/hpinfo/globalcitizenship/environment/recycle/)). The memory chips from this sampling are read and studied in order to improve future HP products. HP partners who assist in recycling this cartridge might have access to this data, as well.

Any third party possessing the cartridge might have access to the anonymous information on the memory chip. If you prefer to not allow access to this information, you can render the chip inoperable. However, after you render the memory chip inoperable, the cartridge cannot be used in an HP product.

If you are concerned about providing this anonymous information, you can make this information inaccessible by turning off the memory chip's ability to collect the product's usage information.

**To disable the usage information function**

1. Touch the **Setup** icon on the Home screen.  
The **Setup** menu appears.
2. Touch **Preferences**.
3. Touch **Cartridge Chip Info**.
4. Touch **OK**.



**NOTE:** To re-enable the usage information function, restore the factory defaults.



**NOTE:** You can continue to use the cartridge in the HP product if you turn off the memory chip's ability to collect the product's usage information.

## Specifications

Technical specifications for the HP Photosmart are provided in this section. For complete product specifications, see the Product Data Sheet at [www.hp.com/support](http://www.hp.com/support).

**System requirements**

Software and system requirements are located in the Readme file.

For information about future operating system releases and support, visit the HP online support Web site at [www.hp.com/support](http://www.hp.com/support).

**Environmental specifications**

- Recommended operating temperature range: 15 °C to 32 °C (59 °F to 90 °F)
- Allowable operating temperature range: 5 °C to 40 °C (41 °F to 104 °F)
- Humidity: 20% to 80% RH non-condensing (recommended); 25 °C maximum dewpoint
- Non-operating (Storage) temperature range: -40 °C to 60 °C (-40 °F to 140 °F)
- In the presence of high electromagnetic fields, it is possible the output from the HP Photosmart may be slightly distorted
- HP recommends using a USB cable less than or equal to 3 m (10 feet) in length to minimize injected noise due to potential high electromagnetic fields

**Print specifications**

- Print speeds vary according to the complexity of the document
- Panorama-size printing
- Method: drop-on-demand thermal inkjet
- Language: PCL3 GUI

**Scan specifications**

- Image editor included
- Resolution: up to 1200 x 1200 ppi optical; 19200 ppi enhanced (software)  
For more information about ppi resolution, see the scanner software.
- Color: 48-bit color, 8-bit grayscale (256 levels of gray)
- Maximum scan size from glass: 21.6 x 29.7 cm (8.5 x 11.7 inches)

**Copy specifications**

- Digital image processing
- Maximum number of copies varies by model
- Copy speeds vary according to the complexity of the document and model
- Maximum copy enlargement ranging from 200-400% (depends on model)
- Maximum copy reduction ranging from 25-50% (depends on model)

### Cartridge yield

Visit [www.hp.com/go/learnaboutsupplies](http://www.hp.com/go/learnaboutsupplies) for more information on estimated cartridge yields.

### Print resolution

To find out about the printer resolution, see the printer software.

## Environmental product stewardship program

Hewlett-Packard is committed to providing quality products in an environmentally sound manner. Design for recycling has been incorporated into this product. The number of materials has been kept to a minimum while ensuring proper functionality and reliability. Dissimilar materials have been designed to separate easily. Fasteners and other connections are easy to locate, access, and remove using common tools. High priority parts have been designed to access quickly for efficient disassembly and repair.

For more information, visit HP's Commitment to the Environment Web site at:

[www.hp.com/hpinfo/globalcitizenship/environment/index.html](http://www.hp.com/hpinfo/globalcitizenship/environment/index.html)

This section contains the following topics:

- [Eco-Tips](#)
- [Paper use](#)
- [Plastics](#)
- [Material safety data sheets](#)
- [Power consumption](#)
- [Recycling program](#)
- [HP inkjet supplies recycling program](#)
- [Chemical Substances](#)
- [Toxic and hazardous substance table](#)
- [Battery disposal in the Netherlands](#)
- [Battery disposal in Taiwan](#)
- [Attention California users](#)
- [EU battery directive](#)

### Eco-Tips

HP is committed to helping customers reduce their environmental footprint. HP has provided the Eco-Tips below to help you focus on ways to assess and reduce the impact of your printing choices. In addition to specific features in this product, please visit the HP Eco Solutions web site for more information on HP's environmental initiatives.

[www.hp.com/hpinfo/globalcitizenship/environment/](http://www.hp.com/hpinfo/globalcitizenship/environment/)

#### Your product's Eco features

- **Energy Savings information:** To determine the ENERGY STAR® qualification status for this product, see [Power consumption](#).
- **Recycled Materials:** For more information regarding recycling of HP products, please visit: [www.hp.com/hpinfo/globalcitizenship/environment/recycle/](http://www.hp.com/hpinfo/globalcitizenship/environment/recycle/)

### Paper use

This product is suited for the use of recycled paper according to DIN 19309 and EN 12281:2002.

### Plastics

Plastic parts over 25 grams are marked according to international standards that enhance the ability to identify plastics for recycling purposes at the end of product life.

### Material safety data sheets

Material safety data sheets (MSDS) can be obtained from the HP Web site at:  
[www.hp.com/go/msds](http://www.hp.com/go/msds)

### Power consumption

Hewlett-Packard printing and imaging equipment marked with the ENERGY STAR® logo is qualified to the U.S. Environmental Protection Agency's ENERGY STAR specifications for imaging equipment. The following mark will appear on ENERGY STAR qualified imaging products:



Additional ENERGY STAR qualified imaging product model information is listed at: [www.hp.com/go/energystar](http://www.hp.com/go/energystar)

### Recycling program

HP offers an increasing number of product return and recycling programs in many countries/regions, and partners with some of the largest electronic recycling centers throughout the world. HP conserves resources by reselling some of its most popular products. For more information regarding recycling of HP products, please visit:

[www.hp.com/hpinfo/globalcitizenship/environment/recycle/](http://www.hp.com/hpinfo/globalcitizenship/environment/recycle/)

### HP inkjet supplies recycling program

HP is committed to protecting the environment. The HP Inkjet Supplies Recycling Program is available in many countries/regions, and lets you recycle used print cartridges and ink cartridges free of charge. For more information, go to the following Web site:

[www.hp.com/hpinfo/globalcitizenship/environment/recycle/](http://www.hp.com/hpinfo/globalcitizenship/environment/recycle/)

### Chemical Substances

HP is committed to providing our customers with information about the chemical substances in our products as needed to comply with legal requirements such as REACH (*Regulation EC No 1907/2006 of the European Parliament and the Council*). A chemical information report for this product can be found at: [www.hp.com/go/reach](http://www.hp.com/go/reach).

## Toxic and hazardous substance table

有毒有害物质表						
根据中国《电子信息产品污染控制管理办法》						
零件描述	有毒有害物质和元素					
	铅	汞	镉	六价铬	多溴联苯	多溴联苯醚
外壳和托盘*	0	0	0	0	0	0
电线*	0	0	0	0	0	0
印刷电路板*	X	0	0	0	0	0
打印系统*	X	0	0	0	0	0
显示器*	X	0	0	0	0	0
喷墨打印机墨盒*	0	0	0	0	0	0
驱动光盘*	X	0	0	0	0	0
扫描仪*	X	X	0	0	0	0
网络配件*	X	0	0	0	0	0
电池板*	X	0	0	0	0	0
自动双面打印系统*	0	0	0	0	0	0
外部电源*	X	0	0	0	0	0

0: 指此部件的所有均一材质中包含的这种有毒有害物质, 含量低于SJ/T11363-2006 的限制  
X: 指此部件使用的均一材质中至少有一种包含的这种有毒有害物质, 含量高于SJ/T11363-2006 的限制  
注: 环保使用期限的参考标识取决于产品正常工作的温度和湿度等条件  
\*以上只适用于使用这些部件的产品

### Battery disposal in the Netherlands

Batterij niet weggooien, maar inleveren als KCA.

Dit HP Product bevat een lithium-manganees-dioxide batterij. Deze bevindt zich op de hoofdprintplaat. Wanneer deze batterij leeg is, moet deze volgens de geldende regels worden afgevoerd.

### Battery disposal in Taiwan

廢電池請回收

Please recycle waste batteries.

### Attention California users

The battery supplied with this product may contain perchlorate material. Special handling may apply. For more information, go to the following Web site:

[www.dtsc.ca.gov/hazardouswaste/perchlorate](http://www.dtsc.ca.gov/hazardouswaste/perchlorate)

## EU battery directive



English	<b>European Union Battery Directive</b> This product contains a battery that is used to maintain data integrity of real time clock or product settings and is designed to last the life of the product. Any attempt to service or replace this battery should be performed by a qualified service technician.
Français	<b>Directive sur les batteries de l'Union Européenne</b> Ce produit contient une batterie qui permet de maintenir l'intégrité des données pour les paramètres du produit ou l'horloge en temps réel et qui a été conçue pour durer aussi longtemps que le produit. Toute tentative de réparation ou de remplacement de cette batterie doit être effectuée par un technicien qualifié.
Deutsch	<b>Batterie-Richtlinie der Europäischen Union</b> Dieses Produkt enthält eine Batterie, die dazu dient, die Datenintegrität der Echtzeituhr sowie der Produkteinstellungen zu erhalten, und die für die Lebensdauer des Produkts ausreicht. Im Bedarfsfall sollte das Instandhalten bzw. Austauschen der Batterie von einem qualifizierten Service-Techniker durchgeführt werden.
Italiano	<b>Direttiva dell'Unione Europea relativa alla raccolta, al trattamento e allo smaltimento di batterie e accumulatori</b> Questo prodotto contiene una batteria utilizzata per preservare l'integrità dei dati dell'orologio in tempo reale o delle impostazioni del prodotto e la sua durata si intende pari a quella del prodotto. Eventuali interventi di riparazione o sostituzione della batteria devono essere eseguiti da un tecnico dell'assistenza qualificato.
Español	<b>Directiva sobre baterías de la Unión Europea</b> Este producto contiene una batería que se utiliza para conservar la integridad de los datos del reloj de tiempo real o la configuración del producto y está diseñada para durar toda la vida útil del producto. El mantenimiento o la sustitución de dicha batería deberá realizarla un técnico de mantenimiento cualificado.
Čeština	<b>Směrnice Evropské unie pro nakládání s bateriemi</b> Tento výrobek obsahuje baterii, která slouží k uchování správných dat hodin reálného času nebo nastavení výrobku. Baterie je navržena tak, aby vydržela celou životnost výrobku. Jakýkoliv pokus o opravu nebo výměnu baterie by měl provést kvalifikovaný servisní technik.
Dansk	<b>EU's batteridirektiv</b> Produktet indeholder et batteri, som bruges til at vedligeholde dataintegriteten for realtidsur- eller produktindstillinger og er beregnet til at holde i hele produktets levetid. Service på batteriet eller udskiftning bør foretages af en uddannet servicetekniker.
Nederlands	<b>Richtlijn batterijen voor de Europese Unie</b> Dit product bevat een batterij die wordt gebruikt voor een juiste tijdsaanduiding van de klok en het behoud van de productinstellingen. Bovendien is deze ontworpen om gedurende de levensduur van het product mee te gaan. Het onderhoud of de vervanging van deze batterij moet door een gekwalificeerde onderhoudstechnicus worden uitgevoerd.
Eesti	<b>Euroopa Liidu aku direktiiv</b> Toode sisaldab akut, mida kasutatakse reaalaja kella andmeühitsuse või toote sätete säilitamiseks. Aku on valmistatud kestma terve toote kasutusaja. Akut tohib hooldada või vahetada ainult kvalifitseeritud hooldustehnik.
Suomi	<b>Euroopan unionin paristodirektiivi</b> Tämä laite sisältää pariston, jota käytetään reaaliaikaisen kellon tietojen ja laitteen asetusten säilyttämiseen. Pariston on suunniteltu kestävänsä laitteen koko käyttöajan ajan. Pariston mahdollinen korjaus tai vaihto on jätettävä pätevänsä huoltohenkilön tehtäväksi.
Ελληνικά	<b>Οδηγία της Ευρωπαϊκής Ένωσης για τις ηλεκτρικές στήλες</b> Αυτό το προϊόν περιλαμβάνει μία μπαταρία, η οποία χρησιμοποιείται για τη διατήρηση της ακεραιότητας των δεδομένων ρολογιού πραγματικού χρόνου ή των ρυθμιζόμενων προϊόντος και έχει σχεδιαστεί έτσι ώστε να διαρκέσει όσο και το προϊόν. Τυχόν απόπειρες επιδιόρθωσης ή αντικατάστασης από της μπαταρίας θα πρέπει να πραγματοποιούνται από κατάλληλα εκπαιδευμένο τεχνικό.
Magyar	<b>Az Európai unió telepek és akkumulátorok direktívája</b> A termék tartalmaz egy elemet, melynek feladata az, hogy biztosítsa a valós idejű óra vagy a termék beállításainak adatintegritását. Az elem úgy van tervezve, hogy végig kitartsa a termék használatá során. Az elem bármilyen javítását vagy cseréjét csak képzett szakember végezheti el.
Latviski	<b>Eiropas Savienības Bateriju direktīva</b> Produktam ir baterija, ko izmanto reāla laika pulksteņa vai produkta iestatījumu datu integritātes saglabāšanai, un tā ir paredzēta visam produkta dzīves ciklam. Jebkura ārkope vai baterijas nomaiņa ir jāveic atbilstoši kvalificētam darbiniekam.
Lietuvaiškai	<b>Eiropos Sąjungos baterijų ir akumuliatorių direktyva</b> Šiame gaminyje yra baterija, kuri naudojama, kad būtų galima prižiūrėti realaus laiko laikrodžio veikimą arba gaminio nuostatas; ji skirta veikti visą gaminio eksploataavimo laiką. Bet kokius šios baterijos aptarnavimo arba keitimo darbus turi atlikti kvalifikuotas aptarnavimo technikas.
Polski	<b>Dyrektywa Unii Europejskiej w sprawie baterii i akumulatorów</b> Produkt zawiera baterię wykorzystywaną do zachowania integralności danych zegara czasu rzeczywistego lub ustawień produktu, która podtrzymuje działanie produktu. Przegląd lub wymiana baterii powinny być wykonywane wyłącznie przez uprawnionego technika serwisu.
Português	<b>Directiva sobre baterías da União Européia</b> Este produto contém uma bateria que é usada para manter a integridade dos dados do relógio em tempo real ou das configurações do produto e é projetada para ter a mesma duração que este. Qualquer tentativa de consertar ou substituir essa bateria deve ser realizada por um técnico qualificado.
Slovenščina	<b>Smernica Európskej unie pre zaobchádzanie s batériami</b> Tento výrobok obsahuje bateriu, ktorá slúži na uchovanie správnych údajov hodin reálneho času alebo nastavení výrobku. Batéria je skonštruovaná tak, aby vydržala celú životnosť výrobku. Akýkoľvek pokus o opravu alebo výmenu baterie by mal vykonať kvalifikovaný servisný technik.
Slovenščina	<b>Directiva Evropske unije o baterijah in akumulatorjih</b> V tem izdelku je baterija, ki zagotavlja natančnost podatkov ure v realnem času ali nastavitev izdelka v celotni življenjski dobi izdelka. Kakršno koli popravilo ali zamenjavo te baterije lahko izvede le pooblaščen tehnik.
Svenska	<b>EU:s batteridirektiv</b> Produkten innehåller ett batteri som används för att upprätthålla data i realtidsklockan och produktinställningarna. Batteriet ska räkna produktens hela livslängd. Endast kvalificerade servicetekniker får utföra service på batteriet och byta ut det.
Български	<b>Директива за батерии на Европейския съюз</b> Този продукт съдържа батерия, която се използва за поддържане на целостта на данните на часовника в реално време или настройките за продукта, създадена на издръжки през целия живот на продукта. Сервизът или замнаната на батерията трябва да се извършва от квалифициран техник.
Română	<b>Directiva Uniunii Europene referitoare la baterii</b> Acest produs conține o baterie care este utilizată pentru a menține integritatea datelor ceasului de timp real sau setărilor produsului și care este proiectată să funcționeze pe întreaga durată de viață a produsului. Orice lucrare de service sau de înlocuire a acestei baterii trebuie efectuată de un tehnician de service calificat.

## Set the Energy Save mode

When you turn off the HP Photosmart product, it goes into the Energy Save mode by default. This makes the product more energy efficient, but also means it can take longer than expected to turn the product on. Additionally, when turned off the Energy Save mode, the HP Photosmart product might not be able to complete some automated maintenance tasks. If you routinely see messages on the display about a real-time clock failure or if you want to reduce the start-up time, you can turn off the Energy Save mode.

---

 **NOTE:** This feature is on by default.

---

### To set the Energy Save mode time or turn off the Energy Save mode

1. Touch the **Setup** icon on the Home screen.



2. Touch **Preferences**.
3. Touch the down arrow to scroll through the options, and then touch **Energy Save Mode**.
4. Touch **After 15 minutes**, or **After 5 minutes**, or **Off**.

## Set Auto Power-off

When the Auto Power-off feature is on, your printer will be automatically turned off after two hours' inactivity. This helps save energy. However, print jobs coming from network will be lost when the printer is turned off.

---

 **NOTE:** This feature is on by default, but when the printer is connected successfully to the network, it will be automatically disabled. You need to turn it on manually. Once you have turned it on manually, it will keep on and will not be automatically disabled by any event.

---

### To turn Auto Power-off on or off

1. Touch the **Setup** icon on the Home screen.



2. Touch **Preferences**.
3. Touch the down arrow to scroll through the options, and then touch **Auto Power-off**.
4. Touch **On** or **Off**.

## Regulatory notices

The HP Photosmart meets product requirements from regulatory agencies in your country/region. This section contains the following topics:

- [Regulatory model identification number](#)
- [FCC statement](#)
- [VCCI \(Class B\) compliance statement for users in Japan](#)
- [Notice to users in Japan about the power cord](#)
- [European Union Regulatory Notice](#)

- [Notice to users in Korea](#)
- [Noise emission statement for Germany](#)

### Regulatory model identification number

For regulatory identification purposes, your product is assigned a Regulatory Model Number. The Regulatory Model Number for your product is SNPRB-1101-01. This regulatory number should not be confused with the marketing name (HP Photosmart 6510 series, etc.) or product numbers (CQ761, etc.).

### FCC statement

#### FCC statement

The United States Federal Communications Commission (in 47 CFR 15.105) has specified that the following notice be brought to the attention of users of this product.

This equipment has been tested and found to comply with the limits for a Class B digital device, pursuant to Part 15 of the FCC Rules. These limits are designed to provide reasonable protection against harmful interference in a residential installation. This equipment generates, uses and can radiate radio frequency energy and, if not installed and used in accordance with the instructions, may cause harmful interference to radio communications. However, there is no guarantee that interference will not occur in a particular installation. If this equipment does cause harmful interference to radio or television reception, which can be determined by turning the equipment off and on, the user is encouraged to try to correct the interference by one or more of the following measures:

- Reorient the receiving antenna.
- Increase the separation between the equipment and the receiver.
- Connect the equipment into an outlet on a circuit different from that to which the receiver is connected.
- Consult the dealer or an experienced radio/TV technician for help.

For further information, contact:

Manager of Corporate Product Regulations  
Hewlett-Packard Company  
3000 Hanover Street  
Palo Alto, Ca 94304  
(650) 857-1501

Modifications (part 15.21)

The FCC requires the user to be notified that any changes or modifications made to this device that are not expressly approved by HP may void the user's authority to operate the equipment.

This device complies with Part 15 of the FCC Rules. Operation is subject to the following two conditions: (1) this device may not cause harmful interference, and (2) this device must accept any interference received, including interference that may cause undesired operation.

### VCCI (Class B) compliance statement for users in Japan

この装置は、クラスB情報技術装置です。この装置は、家庭環境で使用することを目的としていますが、この装置がラジオやテレビジョン受信機に近接して使用されると、受信障害を引き起こすことがあります。取扱説明書に従って正しい取り扱いをして下さい。

VCCI-B



## Notice to users in Japan about the power cord

製品には、同梱された電源コードをお使い下さい。  
同梱された電源コードは、他の製品では使用出来ません。

### European Union Regulatory Notice

Products bearing the CE marking comply with the following EU Directives:

- Low Voltage Directive 2006/95/EC
- EMC Directive 2004/108/EC
- Ecodesign Directive 2009/125/EC, where applicable



CE compliance of this product is valid only if powered with the correct CE-marked AC adapter provided by HP.

If this product has telecommunications functionality, it also complies with the essential requirements of the following EU Directive:

R&TTE Directive 1999/5/EC

Compliance with these directives implies conformity to applicable harmonized European standards (European Norms) that are listed in the EU Declaration of Conformity issued by HP for this product or product family and available (in English only) either within the product documentation or at the following web site: [www.hp.com/go/certificates](http://www.hp.com/go/certificates) (type the product number in the search field).

The compliance is indicated by one of the following conformity markings placed on the product:

	For non-telecommunications products and for EU harmonized telecommunications products, such as Bluetooth® within power class below 10mW.
	For EU non-harmonized telecommunications products (If applicable, a 4-digit notified body number is inserted between CE and !).

Please refer to the regulatory label provided on the product.

The telecommunications functionality of this product may be used in the following EU and EFTA countries: Austria, Belgium, Bulgaria, Cyprus, Czech Republic, Denmark, Estonia, Finland, France, Germany, Greece, Hungary, Iceland, Ireland, Italy, Latvia, Liechtenstein, Lithuania, Luxembourg, Malta, Netherlands, Norway, Poland, Portugal, Romania, Slovak Republic, Slovenia, Spain, Sweden, Switzerland, and United Kingdom.

The telephone connector (not available for all products) is intended for connection to analogue telephone networks.

#### Products with wireless LAN devices

Some countries may have specific obligations or special requirements about the operation of Wireless LAN networks such as indoor use only or restrictions of the channels available. Please make sure that the country settings of the wireless network are correct.

#### France

For 2.4-GHz Wireless LAN operation of this product, certain restrictions apply: This product may be used indoors for the entire 2400-MHz to 2483.5-MHz frequency band (channels 1 to 13). For

outdoor use, only the 2400-MHz to 2454-MHz frequency band (channels 1 to 7) may be used. For the latest requirements, see [www.arcep.fr](http://www.arcep.fr).

The point of contact for regulatory matters is:

Hewlett-Packard GmbH, Dept./MS: HQ-TRE, Herrenberger Strasse 140, 71034 Boeblingen, GERMANY

### Notice to users in Korea

B급 기기 (가정용 방송통신기기)	이 기기는 가정용(B급)으로 전자파적합등록을 한 기기로서 주로 가정에서 사용하는 것을 목적으로 하며, 모든 지역에서 사용할 수 있습니다.
-----------------------	--

### Noise emission statement for Germany

#### Geräuschemission

LpA < 70 dB am Arbeitsplatz im Normalbetrieb nach DIN 45635 T. 19

## Regulatory wireless statements

This section contains the following regulatory information pertaining to wireless products:

- [Exposure to radio frequency radiation](#)
- [Notice to users in Brazil](#)
- [Notice to users in Canada](#)
- [European Union regulatory notice](#)
- [Notice to users in Taiwan](#)

### Exposure to radio frequency radiation

#### Exposure to radio frequency radiation



**Caution** The radiated output power of this device is far below the FCC radio frequency exposure limits. Nevertheless, the device shall be used in such a manner that the potential for human contact during normal operation is minimized. This product and any attached external antenna, if supported, shall be placed in such a manner to minimize the potential for human contact during normal operation. In order to avoid the possibility of exceeding the FCC radio frequency exposure limits, human proximity to the antenna shall not be less than 20 cm (8 inches) during normal operation.

## Notice to users in Brazil

### **Aviso aos usuários no Brasil**

Este equipamento opera em caráter secundário, isto é, não tem direito à proteção contra interferência prejudicial, mesmo de estações do mesmo tipo, e não pode causar interferência a sistemas operando em caráter primário. (Res.ANATEL 282/2001).

## Notice to users in Canada

### **Notice to users in Canada/Note à l'attention des utilisateurs canadiens**

**For Indoor Use.** This digital apparatus does not exceed the Class B limits for radio noise emissions from the digital apparatus set out in the Radio Interference Regulations of the Canadian Department of Communications. The internal wireless radio complies with RSS 210 and RSS GEN of Industry Canada.

**Utiliser à l'intérieur.** Le présent appareil numérique n'émet pas de bruit radioélectrique dépassant les limites applicables aux appareils numériques de la classe B prescrites dans le Règlement sur le brouillage radioélectrique édicté par le ministère des Communications du Canada. Le composant RF interne est conforme à la norme RSS-210 and RSS GEN d'Industrie Canada.

## European Union regulatory notice

### Products with 2.4-GHz wireless LAN devices

#### France

L'utilisation de cet équipement (2.4 GHz Wireless LAN) est soumise a certaines restrictions: Cet équipement peut être utilisé à l'intérieur d'un bâtiment en utilisant toutes les fréquences de 2400 à 2483.5 MHz (Chaîne 1-13). Pour une utilisation en environnement extérieur, vous devez utiliser les fréquences comprises entre 2400-2454 MHz (Chaîne 1-9). Pour les dernières restrictions, voir <http://www.arcep.fr>

#### Italia

E' necessaria una concessione ministeriale anche per l'uso del prodotto. Verifici per favore con il proprio distributore o direttamente presso la Direzione Generale Pianificazione e Gestione Frequenze.

## 低功率電波輻射性電機管理辦法

### 第十二條

經型式認證合格之低功率射頻電機，非經許可，公司、商號或使用者均不得擅自變更頻率、加大功率或變更設計之特性及功能。

### 第十四條

低功率射頻電機之使用不得影響飛航安全及干擾合法通信；經發現有干擾現象時，應立即停用，並改善至無干擾時方得繼續使用。

前項合法通信，指依電信法規定作業之無線電通信。低功率射頻電機須忍受合法通信或工業、科學及醫藥用電波輻射性電機設備之干擾。



---

# Index

## A

after the support period 44

## B

buttons, control panel 8

## C

control panel  
  buttons 8  
  features 8  
copy  
  specifications 48  
customer support  
  warranty 45

## E

environment  
  Environmental product  
    stewardship program 49  
  environmental  
    specifications 48

## I

interface card 35, 36

## N

network  
  interface card 35, 36

## P

phone support 44  
phone support period  
  period for support 44  
print  
  specifications 48

## R

recycle  
  ink cartridges 50  
regulatory notices  
  regulatory model  
    identification number 54  
  wireless statements 56

## S

scan  
  scan specifications 48  
  system requirements 48

## T

technical information  
  copy specifications 48  
  environmental  
    specifications 48  
  print specifications 48  
  scan specifications 48  
  system requirements 48

## W

warranty 45

