

Compaq Presario CQ60 Notebook PC

HP G60 Notebook PC

Maintenance and Service Guide

Document Part Number: 488764-003

August 2011

This guide is a troubleshooting reference used for maintaining and servicing the computer. It provides comprehensive information on identifying computer features, components, and spare parts; and performing computer disassembly procedures.

© Copyright 2011 Hewlett-Packard Development Company, L.P.

AMD Athlon, AMD Sempron, and AMD Turion are trademarks of Advanced Micro Devices, Inc.. Bluetooth is a trademark owned by its proprietor and used by Hewlett-Packard Company under license. Intel, Celeron, Core, and Pentium are trademarks of Intel Corporation in the U.S. and other countries. Microsoft, Windows, and Windows Vista are U.S. registered trademarks of Microsoft Corporation. SD Logo is a trademark of its proprietor.

The information contained herein is subject to change without notice. The only warranties for HP products and services are set forth in the express warranty statements accompanying such products and services. Nothing herein should be construed as constituting an additional warranty. HP shall not be liable for technical or editorial errors or omissions contained herein.

Third Edition: August 2011

First Edition: October 2008

Document Part Number: 488764-003

Safety warning notice



WARNING: To reduce the possibility of heat-related injuries or of overheating the computer, do not place the computer directly on your lap or obstruct the computer air vents. Use the computer only on a hard, flat surface. Do not allow another hard surface, such as an adjoining optional printer, or a soft surface, such as pillows or rugs or clothing, to block airflow. Also, do not allow the AC adapter to contact the skin or a soft surface, such as pillows or rugs or clothing, during operation. The computer and the AC adapter comply with the user-accessible surface temperature limits defined by the International Standard for Safety of Information Technology Equipment (IEC 60950).

1 Product description

2 External component identification

Top components	2-1
Display components	2-1
Lights	2-2
Buttons and speakers.	2-3
Keys	2-4
TouchPad	2-5
Front components	2-6
Rear components	2-6
Left-side components	2-7
Right-side components	2-7
Bottom components	2-8

3 Illustrated parts catalog

Serial number location	3-1
Computer major components	3-2
Display assembly components	3-9
Plastics Kit	3-11
Mass storage devices	3-12
Miscellaneous parts	3-13
Sequential part number listing	3-14

4 Removal and replacement procedures

Preliminary replacement requirements	4-1
Tools required	4-1
Service considerations	4-1
Grounding guidelines	4-2
Unknown user password	4-4
Component replacement procedures	4-5
Serial number	4-5
Computer feet	4-6
Battery	4-7
Optical drive	4-8
Hard drive	4-10
RTC battery	4-12
Memory module	4-13
WLAN module	4-15
Keyboard	4-17
Keyboard cover	4-20

Power button board	4-22
Display assembly	4-23
Top cover	4-30
TouchPad on/off button board and board bracket.	4-32
Audio board.	4-34
Bluetooth module	4-35
Speakers	4-36
USB board.	4-37
System board.	4-38
Fan/heat sink assembly	4-41
Processor	4-44
Power connector cable	4-46

5 Setup Utility

Starting the Setup Utility	5-1
Changing the language of the Setup Utility	5-1
Navigating and selecting in the Setup Utility	5-2
Displaying system information	5-2
Restoring default settings in the Setup Utility	5-2
Exiting the Setup Utility.	5-3
Setup Utility menus	5-3
Main menu	5-3
Security menu	5-3
System Configuration menu	5-4
Diagnostics menu	5-4

6 Specifications

Computer specifications.	6-1
16 and 15.6-inch WXGA display specifications	6-2
Hard drive specifications	6-2
DVD±RW and CD-RW SuperMulti Double-Layer Combo Drive specifications.	6-3
DVD±RW and CD-RW SuperMulti Double-Layer Combo Drive with LightScribe specifications.	6-4
Blu-ray ROM DVD±RW SuperMulti DL Drive specifications	6-4
System DMA specifications.	6-5
System interrupt specifications	6-5
System I/O address specifications	6-6
System memory map specifications.	6-7

7 Screw listing

Phillips PM2.5x6.0 screw	7-1
Phillips PM2.5x5.0 screw	7-3
Phillips PM2.5x6.0 captive screw	7-4
Phillips PM3.0x4.0 screw	7-5
Phillips PM2.0x4.0 screw	7-6
Phillips PM2.5x9.0 screw	7-10
Phillips PM2.5x7.0 screw	7-12
Phillips PM2.0x6.0 screw	7-13
Phillips PM2.0x3.0 screw	7-14
Phillips PM2.0x10.0 captive screw	7-15
Phillips PM2.5x11.0 captive screw	7-16

8 Backup and recovery

Creating recovery discs	8-1
When to back up	8-2
Backup suggestions.	8-2
Using system restore points	8-2
Performing a recovery	8-3
Recovering from the recovery discs	8-4
Recovering from the dedicated recovery partition (select models only)	8-4

9 Connector pin assignments

Audio-in (microphone).	9-1
Audio-out (headphone)	9-1
External monitor.	9-2
HDMI.	9-3
RJ-11 (modem).	9-4
RJ-45 (network)	9-4
Universal Serial Bus.	9-5

10 Power cord set requirements

Requirements for all countries and regions	10-1
Requirements for specific countries and regions	10-2

11 Recycling

Battery	11-1
Display	11-1

Index

Product description

Category	Description	Presario CQ60 Intel UMA	Presario CQ60 Intel Discrete	HP G60 Intel UMA	HP G60 Intel Discrete	Presario CQ60 AMD UMA	HP G60 AMD UMA
Product name	Compaq Presario CQ60 Notebook PC	X	X			X	
	HP G60 Notebook PC			X	X		X
Processors	Intel® Core™2 Duo processors (6-MB L2 cache, 1066-MHz front side bus (FSB)):						
	■ T9400 2.53-GHz processor	X	X	X	X		
	■ T9600 2.8-GHz processor	X	X	X	X		
	Intel Core2 Duo processors (3-MB L2 cache, 1066-MHz FSB):						
	■ P8600 2.4-GHz processor	X	X	X	X		
	■ P8400 2.26-GHz processor	X	X	X	X		
	■ P7350 2.0-GHz processor	X	X	X	X		
	Intel Core2 Duo processors (2-MB L2 cache, 800-MHz FSB):						
	■ T5900 2.2-GHz processor	X	X	X	X		
	■ T5800 2.0-GHz processor	X	X	X	X		
	Intel Pentium® Dual-Core processors (1-MB L2 cache, 667-MHz FSB):						
	■ T3400 2.16-GHz processor	X	X	X	X		
	■ T3200 2.0-GHz processor	X	X	X	X		
	Intel Celeron®-M processors (1-MB L2 cache, 667-MHz FSB):						
	■ 585 2.16-GHz processor	X		X			
	■ 575 2.0-GHz processor	X		X			
	Intel Celeron-T processors (1-MB L2 cache, 667-MHz FSB):						
	■ T1700 1.86-GHz processor	X		X			
	■ T1600 1.66-GHz processor	X		X			
	AMD Turion™ Ultra Dual-Core (2-MB L2 cache):						
■ ZM-80 2.1-GHz processor					X	X	
■ ZM-82 2.2-GHz processor					X	X	

(Continued)

Category	Description	Presario CQ60 Intel UMA	Presario CQ60 Intel Discrete	HP G60 Intel UMA	HP G60 Intel Discrete	Presario CQ60 AMD UMA	HP G60 AMD UMA
Processors <i>(cont)</i>	AMD Turion Dual-Core (1-MB L2 cache)						
	■ RM-70 20-GHz processor					X	X
	■ RM-72 2.1-GHz processor					X	X
	AMD Athlon™ X2 Dual-Core (1-MB L2 cache)						
	■ QL-60 1.9-GHz processor					X	X
	■ QL-62 2.0-GHz processor					X	X
	AMD Sempron™ Single-Core (512-KB L2 cache)						
	■ SI-42 2.1-GHz processor					X	X
	■ SI-40 2.0-GHz processor					X	X
	Chipset	Intel GM45	X		X		
	Intel GL40	X		X			
	Intel PM45		X		X		
	NVIDIA MCP77MV = GeForce 8200M G					X	X
Graphics	Intel Graphics Media Accelerator 4500MHD (Shared)	X		X			
	Unified Memory Architecture (UMA) graphics subsystem integrated with shared system memory (dynamically allocated):	X		X		X	X
	■ up to 96 MB of total available graphics subsystem memory when computer system memory equals or is greater than 512 MB	X		X			
	■ up to 270 MB of total available graphics subsystem memory when computer system memory equals or is greater than 1024 MB	X		X			
	■ up to 781 MB of total available graphics subsystem memory when computer system memory equals or is greater than 2048 MB	X		X			
	■ up to 1294 MB of total available graphics subsystem memory when computer system memory equals or is greater than 3 GB	X		X			
	■ up to 128 MB of total available graphics subsystem memory when computer system memory equals or is greater than 512 MB					X	X

(Continued)

Category	Description	Presario CQ60 Intel UMA	Presario CQ60 Intel Discrete	HP G60 Intel UMA	HP G60 Intel Discrete	Presario CQ60 AMD UMA	HP G60 AMD UMA
Graphics (cont.)	■ up to 319 MB of total available graphics subsystem memory when computer system memory equals or is greater than 1024 MB					X	X
	■ up to 895 MB of total available graphics subsystem memory when computer system memory equals or is greater than 2048 MB					X	X
	■ up to 1407 MB of total available graphics subsystem memory when computer system memory equals or is greater than 3072 MB					X	X
	NVIDIA GeForce 9200M GE with 256 MB of dedicated video memory		X		X		
Panel	16-inch single-channel low-voltage differential signaling HD BrightView display panel (1366 x 768)	X	X	X	X	X	X
	15.6-inch single-channel low-voltage differential signaling HD BrightView display panel (1366 x 768)	X	X	X	X	X	X
	16:10 Wide Aspect Ratio	X	X	X	X	X	X
Memory	2 customer-accessible/upgradable memory module slots	X	X	X	X	X	X
	Supports dual-channel memory	X	X	X	X	X	X
	Supports up to 4 GB of system memory	X	X	X	X	X	X
	Supports the following configurations:						
	■ 3072-MB total system memory (2048 + 1024)	X	X	X	X	X	X
	■ 2048-MB total system memory (2048 x 1, 1024 x 2, dual-channel)	X	X	X	X	X	X
	■ 1536-MB total system memory (1024 + 512)	X	X	X	X		
	■ 1024-MB total system memory (1024 x 1, 512 x 2, dual-channel)	X	X	X	X	X	X
■ 512-MB total system memory (512 x 1, only on computer models equipped with FreeDOS, RedFlag Linux, and Windows Vista® Basic)	X	X	X	X	X	X	
■ 4096-MB total system memory (2048 x 2)					X	X	

(Continued)

Category	Description	Presario CQ60 Intel UMA	Presario CQ60 Intel Discrete	HP G60 Intel UMA	HP G60 Intel Discrete	Presario CQ60 AMD UMA	HP G60 AMD UMA	
Hard drives	Supports all 9.5-mm, 6.35-cm (2.50-in) SATA hard drives	X	X	X	X	X	X	
	Customer accessible	X	X	X	X	X	X	
	Single hard drive configurations:							
	120-GB, 5400-rpm	X	X	X	X	X	X	
	160-GB, 5400-rpm	X	X	X	X	X	X	
	200-GB, 5400-rpm	X	X	X	X			
	250-GB, 5400-rpm	X	X	X	X	X	X	
	320-GB, 5400-rpm	X	X	X	X	X	X	
Optical drives	12.7-mm tray load - SATA - Fixed	X	X	X	X	X	X	
	DVD±RW and CD-RW SuperMulti Double-Layer Combo Drive	X	X	X	X	X	X	
	DVD±RW and CD-RW SuperMulti Double-Layer Combo Drive with LightScribe	X	X	X	X	X	X	
	Blu-ray ROM DVD±RW SuperMulti DL Drive (not supported with Intel GM45 Chipset and 512-MB memory)	X	X	X	X	X	X	
Webcam	VGA camera, 640 x 480 resolution, 22.5 frames per second, fixed angle with activity light	X	X	X	X	X	X	
Microphone	Integrated single analog microphone	X	X	X	X	X	X	
Audio	High-definition audio supports Microsoft premium requirements	X	X	X	X	X	X	
Modem	56K V.92 1.5-inch data/fax modem	X	X	X	X	X	X	
	Computer models not equipped with a modem will have a cover on the RJ-11 jack opening	X	X	X	X	X	X	
	Supports all worldwide certification requirements	X	X	X	X	X	X	
Ethernet	Integrated 10/100 network interface card (NIC)	X	X	X	X	X	X	
	Realtek 8102E	X	X	X	X			
Wireless	Integrated WLAN options by way of wireless module:							
	2 wireless antennae built into display assembly	X	X	X	X	X	X	
	Support for no-WLAN option	X	X	X	X	X	X	

(Continued)

Category	Description	Presario CQ60 Intel UMA	Presario CQ60 Intel Discrete	HP G60 Intel UMA	HP G60 Intel Discrete	Presario CQ60 AMD UMA	HP G60 AMD UMA
Wireless (cont.)	Support for the following WLAN formats:						
	■ Atheros AR9280 802.11a/b/g/n	X	X	X	X	X	X
	■ Atheros AR2425 802.11b/g	X	X	X	X	X	X
	■ Broadcom BCM4312 802.11b/g	X	X	X	X	X	X
	■ Intel Wi-Fi Link 5100 802.11a/b/g	X	X	X	X	X	X
	■ Intel Wi-Fi Link 5100 802.11a/b/g/n	X	X	X	X	X	X
External media cards	Digital Media Slot supporting SD, MMC, MS, MSPro, xD cards. With adapter (not included), supports mini versions of SD, MMC, MS Duo.	X	X	X	X	X	X
Ports	Audio-in (stereo microphone)	X	X	X	X	X	X
	Audio-out (stereo headphone)	X	X	X	X	X	X
	High-definition Multimedia Interface (HDMI) version 1.3 supporting 1080p with High-bandwidth Digital Content Protection (HDCP) key	X	X	X	X	X	X
	RJ-11 (modem)	X	X	X	X	X	X
	RJ-45 (Ethernet, includes link and activity lights)	X	X	X	X	X	X
	USB (3)	X	X	X	X		
	USB (2)					X	X
	VGA (Dsub 15-pin) supporting 1920 × 1200 external resolution at 75 Hz, 1600 × 1200 external resolution at 75 Hz (hot plug/unplug with autodetect)	X	X	X	X	X	X
	Multi-pin AC power	X	X	X	X	X	X
Docking	None	X	X	X	X	X	X
Keyboard/ TouchPad	Full-size keyboard, 40.64-cm (16.00-in) with numeric keypad	X	X	X	X	X	X
	TouchPad with 2 TouchPad buttons	X	X	X	X	X	X
	Supports 2-way scroll with legend	X	X	X	X	X	X
	Taps enabled as default	X	X	X	X	X	X
	Full-size keyboard (silver), 40.64-cm (16.00-in) with numeric keypad					X	X
Power requirements	65-W AC adapter with localized cable plug support	X		X		X	X
	90-W AC adapter with localized cable plug support		X		X		
	6-cell, 2.20-Ah, 47-Wh battery	X	X	X	X	X	X
Security	Security cable slot	X	X	X	X	X	X

(Continued)

Category	Description	Presario CQ60 Intel UMA	Presario CQ60 Intel Discrete	HP G60 Intel UMA	HP G60 Intel Discrete	Presario CQ60 AMD UMA	HP G60 AMD UMA
Operating system	Preinstalled:						
	Windows Vista Business 32	X	X	X	X	X	X
	Windows Vista Premium 32	X	X	X	X	X	X
	Windows Vista Home Basic 32	X	X	X	X	X	X
	FreeDOS	X	X	X	X	X	X
	RedFlag Linux	X	X	X	X		
Serviceability	End-user replaceable parts:						
	AC adapter	X	X	X	X	X	X
	Battery (system)	X	X	X	X	X	X
	Hard drive	X	X	X	X	X	X
	Memory module	X	X	X	X	X	X
	Optical drive	X	X	X	X	X	X
	WLAN module	X	X	X	X	X	X

External component identification

Top components

Display components

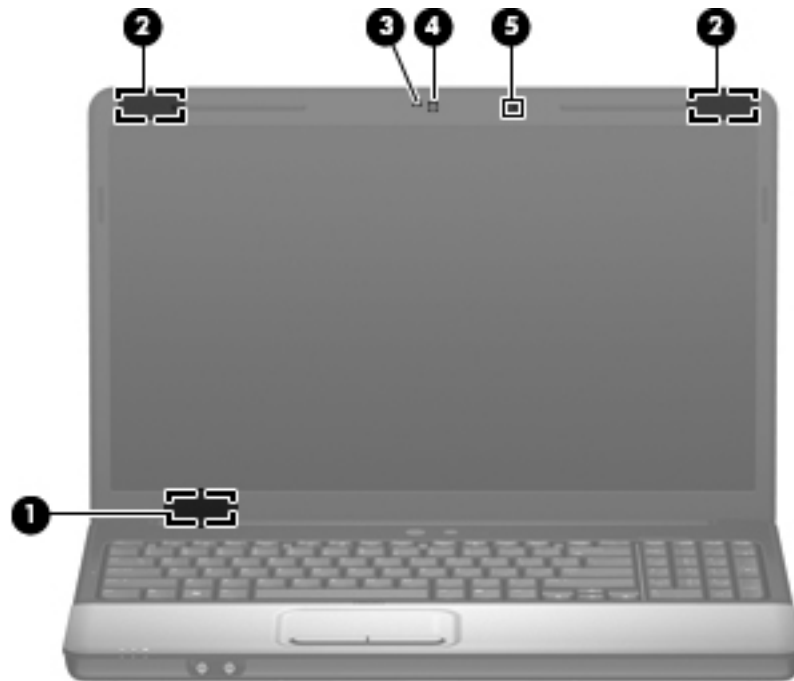

Item	Component	Description
❶	Internal display switch	Turns off the display and initiates Sleep if the display is closed while the power is on.
❷	Wireless antennae (2) (select models only)	Send and receive signals from one or more wireless devices.  The antennae are not visible from the outside of the computer. For optimal transmission, keep the areas immediately around the antennae free from obstructions.
❸	Integrated webcam light (select models only)	On: The integrated webcam is in use.
❹	Integrated webcam (select models only)	Records audio and video and captures still photographs.
❺	Internal microphone	Records sound.

To see wireless regulatory notices, refer to the section of the *Regulatory, Safety and Environmental Notices* that applies to your country or region. These notices are located in Help and Support.

Lights

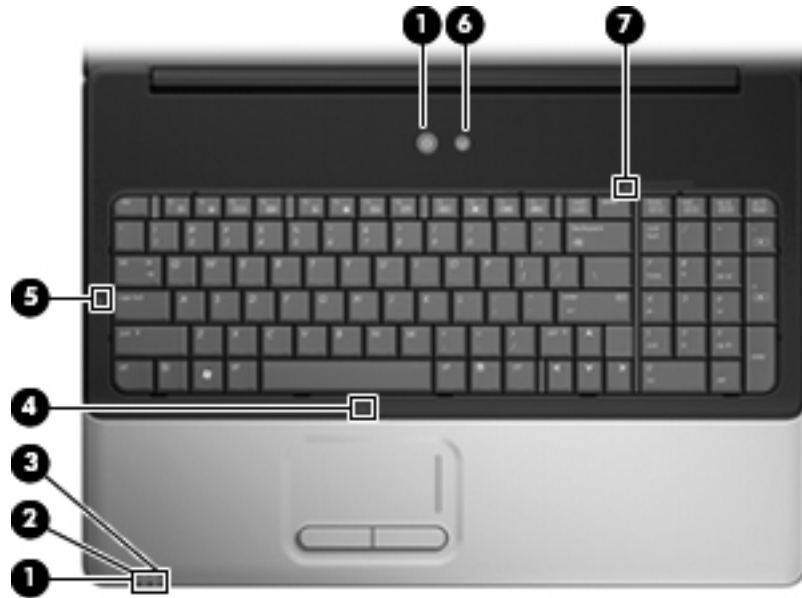

Item	Component	Description
❶	Power lights* (2)	<ul style="list-style-type: none"> ■ On: The computer is on. ■ Blinking: The computer is in the Sleep state. ■ Off: The computer is off or in Hibernation.
❷	Battery light	<ul style="list-style-type: none"> ■ On: A battery is charging. ■ Blinking: A battery that is the only available power source has reached a low battery level. When the battery reaches a critical battery level, the battery light begins blinking rapidly. ■ Off: If the computer is plugged into an external power source, the light is turned off when all batteries in the computer are fully charged. If the computer is not plugged into an external power source, the light stays off until the battery reaches a low battery level.
❸	Drive light	Blinking: The hard drive or optical drive is being accessed.
❹	TouchPad light	White: TouchPad is enabled.
❺	Caps lock light	On: Caps lock is on.
❻	Wireless light	<ul style="list-style-type: none"> ■ Blue: An integrated wireless device, such as a wireless local area network (WLAN) device and/or a Bluetooth® device, is turned on. ■ Amber: All wireless devices are turned off.
❼	Num lock light	On: Num lock is on or the integrated numeric keypad is enabled.

*The 2 power lights display the same information. The light on the power button is visible only when the computer is open. The power light on the front of the computer is visible whether the computer is open or closed.

Buttons and speakers



Item	Component	Description
❶	Speakers (2)	Produce sound.
❷	Power button*	<ul style="list-style-type: none"> ■ When the computer is off, press the button to turn on the computer. ■ When the computer is on, press the button briefly to initiate Sleep. ■ When the computer is in the Sleep state, press the button briefly to exit Sleep. ■ When the computer is in Hibernation, press the button briefly to exit Hibernation. <p>If the computer has stopped responding and Windows® shutdown procedures are ineffective, press and hold the power button for at least 5 seconds to turn off the computer.</p> <p>To learn more about your power settings, select Start > Control Panel > System and Maintenance > Power Options.</p>
❸	Wireless button	<p>Turns the wireless feature on or off, but does not create a wireless connection.</p> <p> A wireless network must be set up in order to establish a wireless connection.</p>

*This table describes factory settings. For information about changing factory settings, refer to the user guides located in Help and Support.

Keys



Item	Component	Description
❶	esc key	Displays system information about your computer when pressed in combination with the fn key.
❷	fn key	Executes frequently used system functions when pressed in combination with a function key or the esc key.
❸	Windows logo key	Displays the Windows Start menu.
❹	Windows applications key	Displays a shortcut menu for items beneath the pointer.
❺	Integrated numeric keypad	Can be used like the keys on an external numeric keypad.
❻	Volume keys	Adjust system volume when pressed in combination with the fn key.
❼	Function keys	Execute frequently used system functions when pressed in combination with the fn key.

TouchPad



Item	Component	Function
①	TouchPad light	■ White: TouchPad is enabled. ■ Amber: TouchPad is disabled.
②	TouchPad*	Moves the pointer and selects or activates items on the screen.
③	Left TouchPad button*	Functions like the left button on an external mouse.
④	TouchPad on/off button	Enables/disables the TouchPad.
⑤	TouchPad vertical scroll zone	Scrolls up or down.
⑥	Right TouchPad button*	Functions like the right button on an external mouse.

*This table describes factory settings. To view and change TouchPad preferences, select **Start > Control Panel > Hardware and Sound > Mouse**.

Front components



Item	Component	Description
①	Power light	<ul style="list-style-type: none"> ■ On: The computer is on. ■ Blinking: The computer is in the Sleep state. ■ Off: The computer is off or in Hibernation.
②	Battery light	<ul style="list-style-type: none"> ■ On: A battery is charging. ■ Blinking: A battery that is the only available power source has reached a low battery level. When the battery reaches a critical battery level, the battery light begins blinking rapidly. ■ Off: If the computer is plugged into an external power source, the light is turned off when all batteries in the computer are fully charged. If the computer is not plugged into an external power source, the light stays off until the battery reaches a low battery level.
③	Drive light	Blinking: The hard drive or optical drive is being accessed.
④	Audio-in (microphone) jack	Connects an optional computer headset microphone, stereo array microphone, or monaural microphone.
⑤	Audio-out (headphone) jack	Produces sound when connected to optional powered stereo speakers, headphones, ear buds, a headset, or television audio.

Rear components



Component	Function
Vents (2)	<p>Enable airflow to cool internal components.</p> <p> The computer fan starts up automatically to cool internal components and prevent overheating. It is normal for the internal fan to cycle on and off during routine operation.</p>

Left-side components



Item	Component	Function
❶	Power connector	Connects an AC adapter.
❷	AC adapter light	<ul style="list-style-type: none"> ■ On: The computer is connected to external power. ■ Off: The computer is not connected to external power.
❸	External monitor port	Connects an external VGA monitor or projector.
❹	RJ-45 (network) jack	Connects a network cable.
❺	HDMI port (select models only)	Connects an optional video or audio device, such as a high-definition television, or any compatible digital or audio component.
❻	USB port	Connects an optional USB device.
❼	Digital Media Slot (select models only)	Supports the following optional digital card formats: <ul style="list-style-type: none"> ■ Memory Stick (MS) ■ Memory Stick Pro (MSP) ■ MultiMediaCard (MMC) ■ Secure Digital (SD) Memory Card ■ xD-Picture Card (XD) ■ xD-Picture Card (XD) Type H ■ xD-Picture Card (XD) Type M
❽	Digital Media Slot light (select models only)	On: The Digital Media Slot is in use.

Right-side components

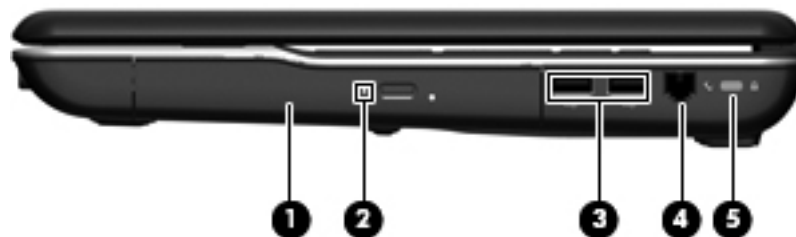

Item	Component	Function
❶	Optical drive	Reads optical discs and, on select models, also writes to optical discs.
❷	Optical drive light	Blinking: The optical drive is being accessed.
❸	USB ports (2)	Connect optional USB devices.
❹	RJ-11 (modem) jack (select models only)	Connects a modem cable.
❺	Security cable slot	Attaches an optional security cable to the computer.  The security cable is designed to act as a deterrent, but it may not prevent the computer from being mishandled or stolen.

Bottom components

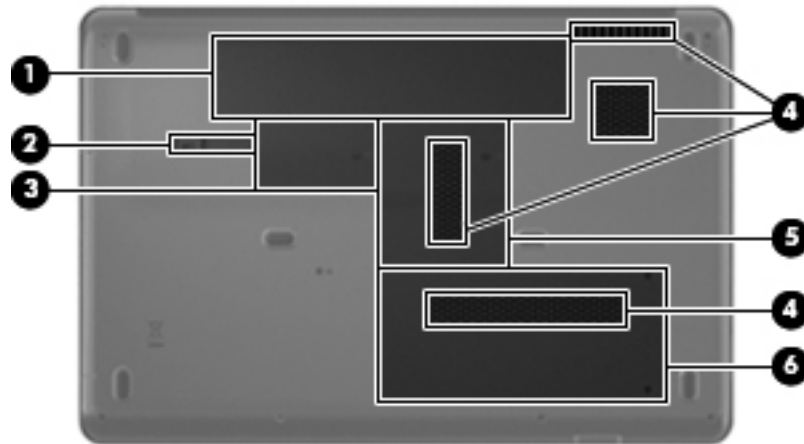

Item	Component	Function
❶	Battery bay	Holds the battery.
❷	Battery release latch	Releases the battery from the battery bay.
❸	WLAN module compartment	<p>Holds the WLAN module.</p> <p>⚠ To prevent an unresponsive system, replace the wireless module with only a wireless module authorized for use in the computer by the governmental agency that regulates wireless devices in your country or region. If you replace the module and then receive a warning message, remove the module to restore computer functionality, and then contact technical support through Help and Support.</p>
❹	Vents (4)	<p>Enable airflow to cool internal components.</p> <p>📝 The computer fan starts up automatically to cool internal components and prevent overheating. It is normal for the internal fan to cycle on and off during routine operation.</p>
❺	Memory module compartment	Contains the memory module slots.
❻	Hard drive bay	Holds the hard drive.

Serial number location

The service tag, affixed to the bottom of the computer, provides information that may be needed when troubleshooting system problems. The service tag provides the following information:

When ordering parts or requesting information, provide the computer serial number and model number located on the bottom of the computer.

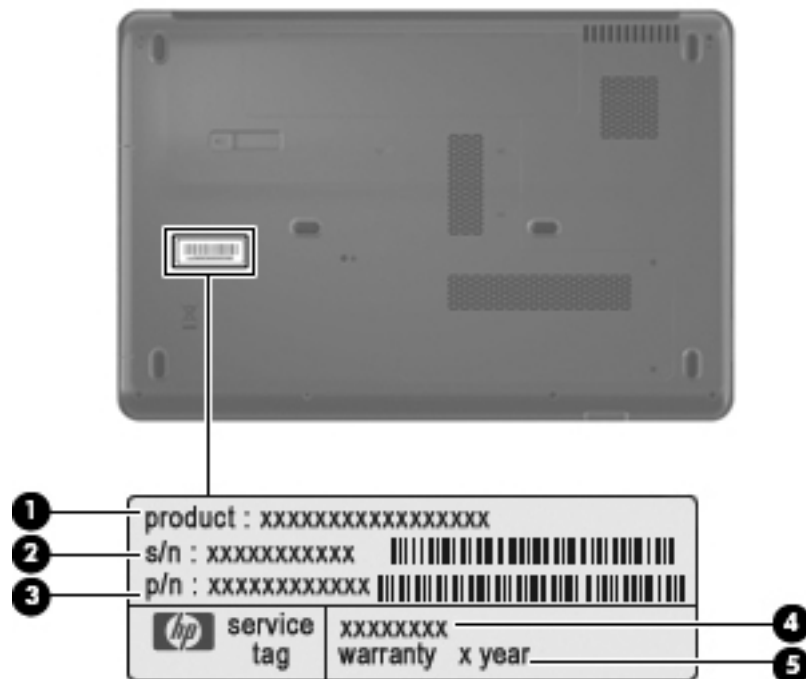

Item	Component	Description
1	Product name	This is the product name affixed to the front of the computer.
2	Serial number (s/n)	This is an alphanumeric identifier that is unique to each product.
3	Part number/Product number (p/n)	This number provides specific information about the product's hardware components. The part number helps a service technician to determine what components and parts are needed.
4	Model description	This is the number used to locate documents, drivers, and support for the computer.
5	Warranty period	This number describes the duration of the warranty period for the computer. When ordering parts or requesting information, provide the computer serial number and model description provided on the service tag.

Computer major components

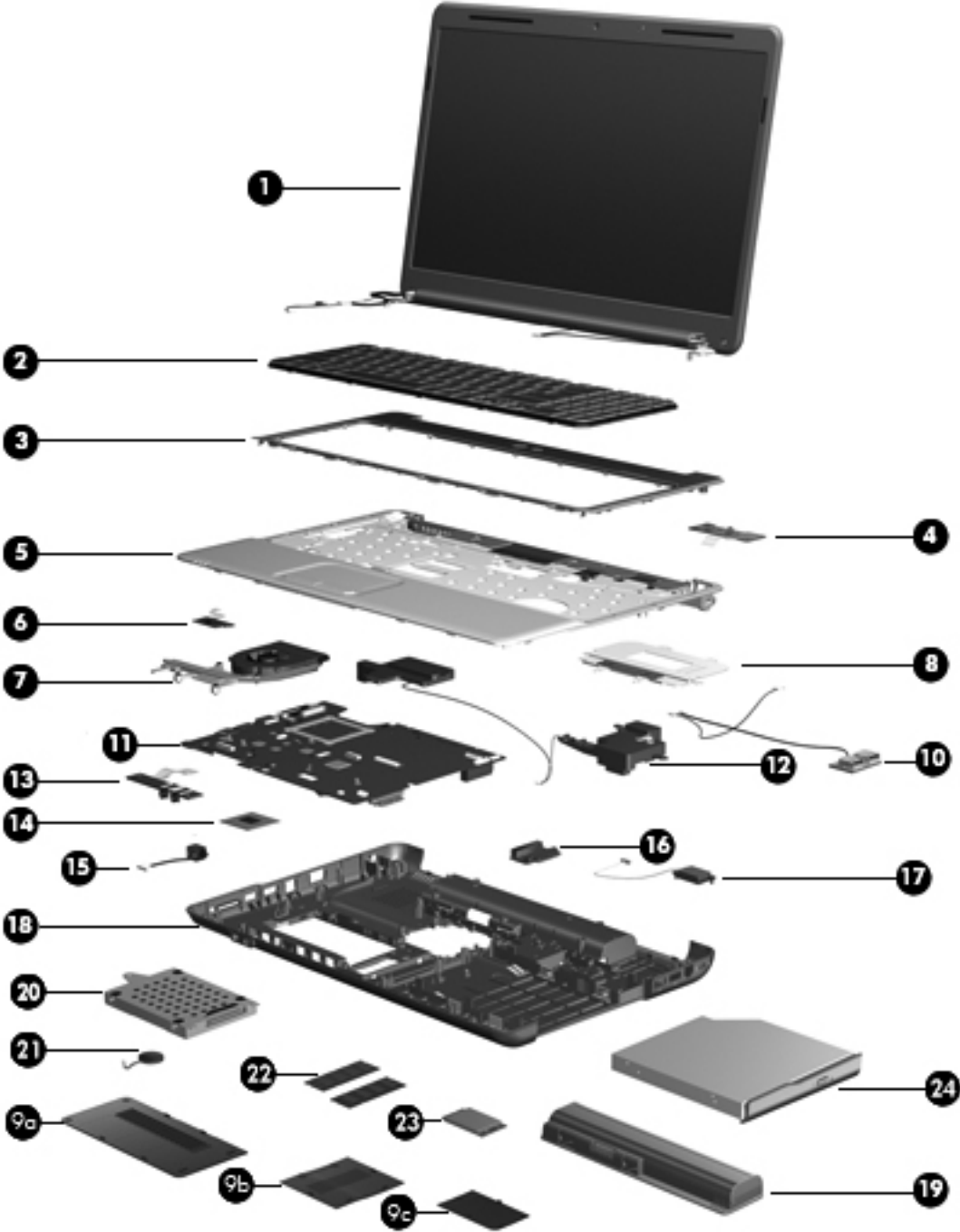

Item	Description	Spare Part Number
(1)	16-inch WXGA BrightView display assembly	
	16-inch WXGA BrightView display assembly for HP G60 computer models (includes webcam module and cable, 2 WLAN antenna transceivers and cables, microphone and cable, and logo)	496762-001
	16-inch WXGA BrightView display assembly for HP G60 computer models (includes microphone and cable and logo)	496761-001
	16-inch WXGA BrightView silver display assembly for HP G60 computer models (includes webcam module and cable, 2 WLAN antenna transceivers and cables, microphone and cable, and logo)	502950-001
	16-inch WXGA BrightView silver display assembly for HP G60 computer models (includes microphone and cable and logo)	502949-001
	16-inch WXGA BrightView display assembly for Presario CQ60 computer models (includes microphone and cable and logo)	496765-001
	16-inch WXGA BrightView display assembly for Presario CQ60 computer models (includes webcam module and cable, 2 WLAN antenna transceivers and cables, microphone and cable, and logo)	496766-001
	15.6-inch WXGA BrightView display assembly	
	15.6-inch WXGA BrightView display assembly for Presario CQ60 computer models (includes microphone and cable, and logo)	496767-001
	15.6-inch WXGA BrightView display assembly for Presario CQ60 computer models (includes webcam module and cable, 2 WLAN antenna transceivers and cables, microphone and cable, and logo)	496768-001
	15.6-inch WXGA BrightView display assembly for HP G60 computer models (includes microphone and cable, and logo)	496763-001
	15.6-inch WXGA BrightView display assembly for HP G60 computer models (includes webcam module and cable, 2 WLAN antenna transceivers and cables, microphone and cable, and logo)	496764-001
	15.6-inch WXGA BrightView silver display assembly for HP G60 computer models (includes microphone and cable, and logo)	502951-001
	15.6-inch WXGA BrightView silver display assembly for HP G60 computer models (includes webcam module and cable, 2 WLAN antenna transceivers and cables, microphone and cable, and logo)	502952-001
(2)	Keyboard (includes keyboard cable)	
	For use in Belgium	496771-181
	For use in Canada	496771-121
	For use in Canada (silver)	502958-121
	For use in the Czech Republic	496771-221
	For use in France	496771-051
	For use in Germany	496771-041
	For use in Greece	496771-151
	For use in Israel	496771-BB1
	For use in Italy	496771-061
	For international use	496771-B31
	For use in Latin America	496771-161
	For us in Japan	49671-AA1
	For used in Norway	496771-091

(Continued)

Item	Description	Spare Part Number
	For use in Portugal	496771-131
	For use in Russia	496771-251
	For use in Saudi Arabia	496771-171
	For use in South Korea	496771-AD1
	For use in Spain	496771-071
	For use in Switzerland	496771-111
	For use in Thailand	496771-281
	For use in Turkey	496771-141
	For use in Taiwan	496771-AB1
	For use in the United Kingdom	496771-031
	For use in the United States	496771-001
	For use in the United States (silver)	502958-001
(3)	Keyboard cover	506848-001
(4)	Power button board (includes power button board cable)	496830-001
(5)	Top cover (includes TouchPad board)	506849-001
(6)	TouchPad on/off button board (includes cables)	496832-001
(7)	Fan/heat sink assembly for use with UMA systems (includes replacement thermal material)	489126-001
	Fan/heat sink assembly for use with Discrete systems (includes replacement thermal material)	489154-001
(8)	TouchPad board bracket	489119-001
	Plastics Kit (see Plastics Kit on page 3-9 for more Plastics Kit spare part information)	486621-001
(9a)	Hard drive cover	
(9b)	Memory module compartment cover	
(9c)	WLAN module compartment cover	
(10)	USB board (does not include USB board cable)	486633-001
	USB board cable (not illustrated, includes num lock LED)	496837-001
(11)	System board	
	UMA system board, GM45 (includes built-in modem, Digital Media Slot, HDMI port, and replacement thermal material)	485218-001
	UMA system board, GM45 (includes built-in modem, Digital Media Slot, and replacement thermal material)	494281-001
	UMA system board, GL40 (includes built-in modem, Digital Media Slot, and replacement thermal material)	494282-001
	UMA system board, GL40 (includes built-in modem, Digital Media Slot, HDMI port, and replacement thermal material)	485219-001
	UMA system board, GL40 (for Presario CQ60 computer models only; includes built-in modem and replacement thermal material)	501266-001
	Discrete system board, PM45 (includes built-in modem, Digital Media Slot, HDMI port, and replacement thermal material)	488338-001
	Discrete system board, PM45 (includes built-in modem, Digital Media Slot, and replacement thermal material)	494283-001

(Continued)

Item	Description	Spare Part Number
	UMA system board, NVIDIA (includes built-in modem, Digital Media Slot, HDMI port, and replacement thermal material)	498460-001
	UMA system board, NVIDIA (for Presario CQ60 use only; includes built-in modem, Digital Media Slot, and replacement thermal material)	498462-001
	UMA system board, NVIDIA (for Presario CQ60 use only; includes built-in modem, HDMI port, and replacement thermal material)	498463-001
	UMA system board, NVIDIA (for Presario CQ60 use only; includes built-in modem and replacement thermal material)	498464-001
(12)	Speakers (include left and right speakers and cables)	496829-001
(13)	Audio board (includes audio board cable)	486634-001
(14)	Processor (includes replacement thermal material)	
	Intel Core2 Duo processor (6-MB L2 cache, 1066-MHz FSB):	
	■ T9400 2.53-GHz processor	490113-001
	Intel Core2 Duo processors (3-MB L2 cache, 1066-MHz FSB):	
	■ P8600 2.4-GHz processor	490112-001
	■ P8400 2.26-GHz processor	490111-001
	■ P7350 2.0-GHz processor	501520-003
	Intel Core2 Duo processors (2-MB L2 cache, 800-MHz FSB):	
	■ T5900 2.2-GHz processor	501522-003
	■ T5800 2.0-GHz processor	501521-003
	Intel Pentium Dual-Core processors (1-MB L2 cache, 667-MHz FSB):	
	■ T3400 2.16-GHz processor	501523-003
	■ T3200 2.0-GHz processor	490115-001
	Intel Celeron-M processors (1-MB L2 cache, 667-MHz FSB):	
	■ 585 2.16-GHz processor	490117-001
	■ 575 2.0-GHz processor	490116-001
	Intel Celeron-T processors (1-MB L2 cache, 667-MHz FSB):	
	■ T1700 1.86-GHz processor	501525-003
	■ T1600 1.66-GHz processor	501524-003
	AMD Turion Ultra Dual-Core (2-MB L2 cache):	
	■ ZM-80 2.1-GHz processor	498465-001
	■ ZM-82 2.2-GHz processor	498466-001
	AMD Turion Dual-Core (1-MB L2 cache):	
	■ RM-70 2.0-GHz processor	498467-001
	■ RM-72 2.1-GHz processor	498468-001
	AMD Athlon X2 Dual-Core (1-MB L2 cache):	
	■ QL-60 1.9-GHz processor	498469-001
	■ QL-62 2.0-GHz processor	498470-001
	AMD Sempron Single-Core (512-KB L2 cache):	
	■ SI-42 2.1-GHz processor	498471-001
	■ SI-40 2.0-GHz processor	498472-001

(Continued)

Item	Description	Spare Part Number
(15)	Power connector cable	496835-001
(16)	Optical extension board	506951-001
(17)	Bluetooth® module (does not include Bluetooth cable)	483113-001
	Bluetooth cable (not illustrated)	496836-001
(18)	Base enclosure (includes rubber feet)	
	For use only with computer models equipped with a built-in modem, Digital Media Slot, and an HDMI port (includes card reader, not illustrated)	496825-001
	For use only with computer models equipped with a built-in modem and Digital Media Slot, without an HDMI port	492826-001
	For use only with computer models equipped with a built-in modem, without Digital Media Slot and HDMI port	496827-001
	For use only with computer models equipped with a built-in modem, HDMI port, without Digital Media Slot	504740-001
	Rubber Feet Kit (not illustrated, includes 6 rubber feet)	486623-001
(19)	Battery , 6-cell, 2.20-Ah, 47-Wh	485041-001
(20)	Hard drive (includes hard drive bracket and connector)	
	320-GB, 5400-rpm	504072-001
	250-GB, 5400-rpm	498478-001
	200-GB, 5400-rpm	505971-001
	160-GB, 5400-rpm	498477-001
	120-GB, 5400-rpm	498476-001
	Hard Drive Hardware Kit (not illustrated, includes connector, bracket, and screws)	504059-001
(21)	RTC battery	501587-001
(22)	Memory modules	
	PC2-6400, 667-MHz, DDR2	
	2-GB	485033-005
	1-GB	485032-005
	512-MB	485031-005
	PC2-5300, 667-MHz, DDR2	
	2-GB	498475-001
	1-GB	498474-001
	512-MB	498473-001

(Continued)

Item	Description	Spare Part Number
(23)	WLAN module	
	Atheros AR9280 802.11a/g/n WLAN modules:	
	■ For use in Canada, the Cayman Islands, Guam, Puerto Rico, the U.S. Virgin Islands, and the United States	482260-001
	■ For use in Afghanistan, Albania, Algeria, Andorra, Angola, Antigua and Barbuda, Argentina, Armenia, Aruba, Australia, Austria, Azerbaijan, the Bahamas, Bahrain, Bangladesh, Barbados, Belarus, Belgium, Belize, Benin, Bermuda, Bhutan, Bolivia, Bosnia and Herzegovina, Botswana, Brazil, the British Virgin Islands, Brunei, Bulgaria, Burkina Faso, Burundi, Cameroon, Cape Verde, the Central African Republic, Chad, Chile, Colombia, Comoros, the Congo, Costa Rica, Croatia, Cyprus, the Czech Republic, Denmark, Djibouti, Dominica, the Dominican Republic, East Timor, Ecuador, Egypt, El Salvador, Equatorial Guinea, Eritrea, Estonia, Ethiopia, Fiji, Finland, France, French Guiana, Gabon, Gambia, Georgia, Germany, Ghana, Gibraltar, Greece, Grenada, Guadeloupe, Guatemala, Guinea, Guinea-Bissau, Guyana, Haiti, Honduras, Hong Kong, Hungary, Iceland, India, Ireland, Israel, Italy, the Ivory Coast, Jamaica, Jordan, Kazakhstan, Kenya, Kiribati, Kyrgyzstan, Laos, Latvia, Lebanon, Lesotho, Liberia, Liechtenstein, Lithuania, Luxembourg, Macedonia, Madagascar, Malawi, Malaysia, the Maldives, Mali, Malta, the Marshall Islands, Martinique, Mauritania, Mauritius, Mexico, Micronesia, Monaco, Mongolia, Montenegro, Morocco, Mozambique, Namibia, Nauru, Nepal, the Nether Antilles, the Netherlands, New Zealand, Nicaragua, Niger, Nigeria, Norway, Oman, Pakistan, Palau, Panama, Papua New Guinea, Paraguay, the People's Republic of China, Peru, the Philippines, Poland, Portugal, the Republic of Moldova, Romania, Russia, Rwanda, Samoa, San Marino, Sao Tome and Principe, Saudi Arabia, Senegal, Serbia and Montenegro, the Seychelles, Sierra Leone, Singapore, Slovakia, Slovenia, the Solomon Islands, Somalia, South Africa, South Korea, Spain, Sri Lanka, St. Kitts and Nevis, St. Lucia, St. Vincent and the Grenadines, Suriname, Swaziland, Sweden, Switzerland, Taiwan, Tajikistan, Tanzania, Togo, Tonga, Trinidad and Tobago, Tunisia, Turkey, Turkmenistan, Tuvalu, Uganda, Ukraine, the United Arab Emirates, the United Kingdom, Uruguay, Uzbekistan, Vanuatu, Venezuela, Vietnam, Yemen, Zaire, Zambia, and Zimbabwe	482260-002
	Atheros AR2425 802.11b/g WLAN modules:	
	■ For use in Canada, the Cayman Islands, Guam, Puerto Rico, the U.S. Virgin Islands, and the United States	459339-001
	■ For use in Afghanistan, Albania, Algeria, Andorra, Angola, Antigua and Barbuda, Argentina, Armenia, Aruba, Australia, Austria, Azerbaijan, the Bahamas, Bahrain, Bangladesh, Barbados, Belarus, Belgium, Belize, Benin, Bermuda, Bhutan, Bolivia, Bosnia and Herzegovina, Botswana, Brazil, the British Virgin Islands, Brunei, Bulgaria, Burkina Faso, Burundi, Cambodia, Cameroon, Cape Verde, the Central African Republic, Chad, Chile, Colombia, Comoros, Congo, Costa Rica, Croatia, Cyprus, the Czech Republic, Denmark, Djibouti, Dominica, the Dominican Republic, East Timor, Ecuador, Egypt, El Salvador, Equatorial Guinea, Eritrea, Estonia, Ethiopia, Fiji, Finland, France, French Guiana, Gabon, Gambia, Georgia, Germany, Ghana, Gibraltar, Greece, Grenada, Guadeloupe, Guatemala, Guinea, Guinea-Bissau, Guyana, Haiti, Honduras, Hong Kong, Hungary, Iceland, India, Indonesia, Ireland, Israel, Italy, the Ivory Coast, Jamaica, Japan, Jordan, Kazakhstan, Kenya, Kiribati, Kuwait, Kyrgyzstan, Laos, Latvia, Lebanon, Lesotho, Liberia, Liechtenstein, Lithuania, Luxembourg, Macedonia, Madagascar, Malawi, Malaysia, the Maldives, Mali, Malta, the Marshall Islands, Martinique, Mauritania, Mauritius, Mexico, Micronesia, Monaco, Mongolia, Montenegro, Morocco, Mozambique, Namibia, Nauru, Nepal, the Nether Antilles, the Netherlands, New Zealand, Nicaragua, Niger, Nigeria, Norway, Oman, Pakistan, Palau, Panama, Papua New Guinea, Paraguay, the People's Republic of China, Peru, the Philippines, Poland, Portugal, Qatar, the Republic of Moldova, Romania, Russia, Rwanda, Samoa, San Marino, Sao Tome and Principe, Saudi Arabia, Senegal, Serbia and Montenegro, Seychelles, Sierra Leone, Singapore, Slovakia, Slovenia, the Solomon Islands, Somalia, South Africa, South Korea, Spain, Sri Lanka, St. Kitts and Nevis, St. Lucia, St. Vincent and the Grenadines, Suriname, Swaziland, Sweden, Switzerland, Syria, Taiwan, Tajikistan, Tanzania, Thailand, Togo, Tonga, Trinidad and Tobago, Tunisia, Turkey, Turkmenistan, Tuvalu, Uganda, Ukraine, the United Arab Emirates, the United Kingdom, Uruguay, Uzbekistan, Vanuatu, Venezuela, Vietnam, Yemen, Zaire, Zambia, and Zimbabwe	459339-002

(Continued)

Item	Description	Spare Part Number
	Broadcom BCM4312 802.11b/g WLAN modules:	
	■ For use in Canada, the Cayman Islands, Guam, Puerto Rico, the U.S. Virgin Islands, and the United States	459263-001
	■ For use in Afghanistan, Albania, Algeria, Andorra, Angola, Antigua and Barbuda, Argentina, Armenia, Aruba, Australia, Austria, Azerbaijan, the Bahamas, Bahrain, Bangladesh, Barbados, Belarus, Belgium, Belize, Benin, Bermuda, Bhutan, Bolivia, Bosnia and Herzegovina, Botswana, Brazil, the British Virgin Islands, Brunei, Bulgaria, Burkina Faso, Burundi, Cameroon, Cape Verde, the Central African Republic, Chad, Chile, Colombia, Comoros, the Congo, Costa Rica, Croatia, Cyprus, the Czech Republic, Denmark, Djibouti, Dominica, the Dominican Republic, East Timor, Ecuador, Egypt, El Salvador, Equatorial Guinea, Eritrea, Estonia, Ethiopia, Fiji, Finland, France, French Guiana, Gabon, Gambia, Georgia, Germany, Ghana, Gibraltar, Greece, Grenada, Guadeloupe, Guatemala, Guinea, Guinea-Bissau, Guyana, Haiti, Honduras, Hong Kong, Hungary, Iceland, India, Ireland, Israel, Italy, the Ivory Coast, Jamaica, Jordan, Kazakhstan, Kenya, Kiribati, Kyrgyzstan, Laos, Latvia, Lebanon, Lesotho, Liberia, Liechtenstein, Lithuania, Luxembourg, Macedonia, Madagascar, Malawi, Malaysia, the Maldives, Mali, Malta, the Marshall Islands, Martinique, Mauritania, Mauritius, Mexico, Micronesia, Monaco, Mongolia, Montenegro, Morocco, Mozambique, Namibia, Nauru, Nepal, the Nether Antilles, the Netherlands, New Zealand, Nicaragua, Niger, Nigeria, Norway, Oman, Pakistan, Palau, Panama, Papua New Guinea, Paraguay, the People's Republic of China, Peru, the Philippines, Poland, Portugal, the Republic of Moldova, Romania, Russia, Rwanda, Samoa, San Marino, Sao Tome and Principe, Saudi Arabia, Senegal, Serbia and Montenegro, the Seychelles, Sierra Leone, Singapore, Slovakia, Slovenia, the Solomon Islands, Somalia, South Africa, South Korea, Spain, Sri Lanka, St. Kitts and Nevis, St. Lucia, St. Vincent and the Grenadines, Suriname, Swaziland, Sweden, Switzerland, Taiwan, Tajikistan, Tanzania, Togo, Tonga, Trinidad and Tobago, Tunisia, Turkey, Turkmenistan, Tuvalu, Uganda, Ukraine, the United Arab Emirates, the United Kingdom, Uruguay, Uzbekistan, Vanuatu, Venezuela, Vietnam, Yemen, Zaire, Zambia, and Zimbabwe	459263-002
(24)	Optical drive (includes optical drive bezel and bracket)	
	DVD±RW and CD-RW SuperMulti Double-Layer Combo Drive	498479-001
	DVD±RW and CD-RW SuperMulti Double-Layer Combo Drive with LightScribe	498480-001
	Blu-ray ROM DVD±RW SuperMulti DL Drive	498481-001

Display assembly components

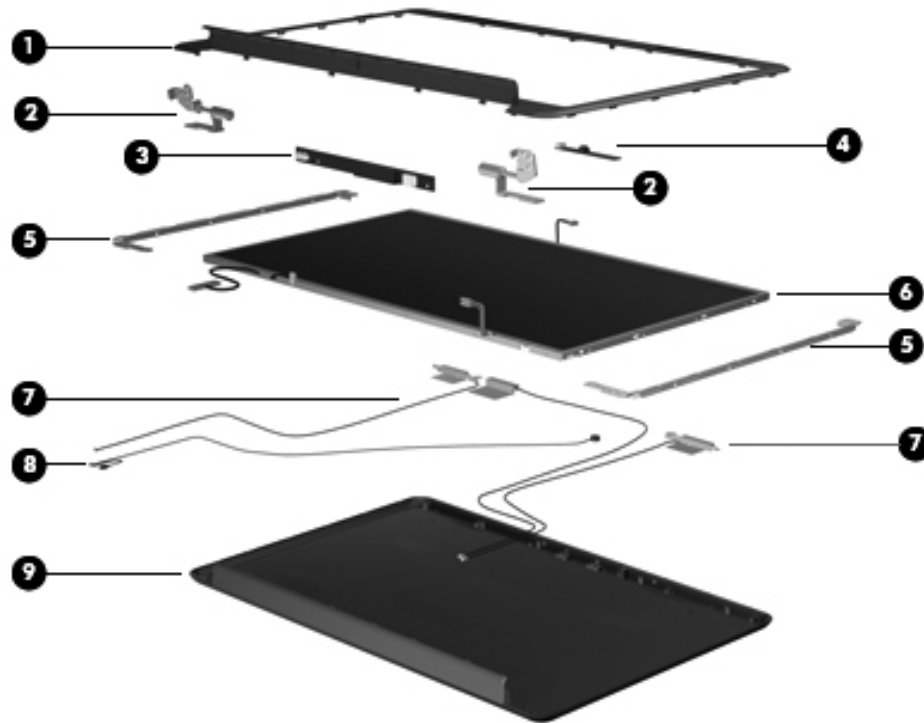

Item	Description	Spare Part Number
(1)	Display bezel	
	For use only with 16-inch HP G60 display bezels (includes microphone)	497097-001
	For use only with 16-inch HP G60 display bezels (includes microphone and webcam)	497098-001
	For use only with 16-inch silver HP G60 display bezels (includes microphone)	502954-001
	For use only with 16-inch silver HP G60 display bezels (includes microphone and webcam)	502955-001
	For use only with 15.6-inch HP G60 display bezels (includes microphone)	497101-001
	For use only with 15.6-inch HP G60 display bezels (includes microphone and webcam)	497102-001
	For use only with 15.6-inch silver HP G60 display bezels (includes microphone)	502956-001
	For use only with 15.6-inch silver HP G60 display bezels (includes microphone and webcam)	502957-001
	For use only with 16-inch CQ60 display bezels (includes microphone)	497095-001
	For use only with 16-inch CQ60 display bezels (includes microphone and webcam)	497096-001
	For use only with 15.6-inch CQ60 display bezels (includes microphone)	497099-001
	For use only with 15.6-inch CQ60 display bezels (includes microphone and webcam)	497100-001
(2)	Display Hinge Kit (includes left and right display hinges)	486558-001
(3)	Webcam module (does not include webcam module cable)	488385-001
	Webcam Cable Kit (not illustrated)	496842-001
(4)	Display inverter	486556-001
(5)	Display panel brackets (include left and right brackets)	
	For use with 16-inch display panels	496843-001
	For use with 15.6-inch display panels	496844-001

(Continued)

Item	Description	Spare Part Number
(6)	WXGA BrightView display panel (include display panel and backlight cables)	
	For use only with 16-inch display	496769-001
	For use only with 15.6-inch display	496770-001
	Display panel cable kit with webcam cable (not illustrated)	496841-001
(7)	Wireless Antenna Kit (includes wireless antenna transceivers and cable)	
	Wireless antenna cable (shown attached to transceivers)	486562-001
(8)	Microphone and caps lock cable (includes receiver and cable)	496840-001
(9)	Display enclosure (includes logo)	
	For use only with HP G60 computer models	497094-001
	For use only with silver HP G60 computer models	502953-001
	For use only with Presario CQ60 computer models	497093-001
	Display Rubber Kit (not illustrated, includes display bezel rubber screw covers)	486584-001
	Display Screw Kit (not illustrated, included in the display assembly)	

Plastics Kit



Item	Description	Spare part number
	Plastics Kit:	486621-001
❶	WLAN module compartment cover (includes 1 captive screw, secured by a C-clip)	
❷	Memory module compartment cover (includes 2 captive screws, secured by C-clips)	
❸	Hard drive cover (includes 2 captive screws, secured by C-clips)	

Mass storage devices



Item	Description	Spare part number
①	Hard drive (includes connector and bracket)	
	320-GB, 5400-rpm	504072-001
	250-GB, 5400-rpm	498478-001
	200-GB, 5400-rpm	505971-001
	160-GB, 5400-rpm	498477-001
	120-GB, 5400-rpm	498476-001
	Hard Drive Hardware Kit (includes connector, bracket, and screws)	504059-001
②	Optical drive (includes bezel and bracket)	
	DVD±RW and CD-RW SuperMulti Double-Layer Combo Drive	498479-001
	DVD±RW and CD-RW SuperMulti Double-Layer Combo Drive with LightScribe	498480-001
	Blu-ray ROM DVD±RW SuperMulti DL Drive	498481-001

Miscellaneous parts

Description	Spare part number
AC adapters:	
65-W AC adapter	463958-001
Power cords:	
For use in Argentina	490371-D01
For use in Australia	490371-011
For use in Brazil	490371-021
For use in Denmark	490371-081
For use in Europe	490371-021
For use in India	490371-D61
For use in Israel	490371-BB1
For use in Italy	490371-061
For use in South Africa	490371-AR1
For use in South Korea	490371-AD1
For use in Switzerland	490371-111
For use in Taiwan	490371-AB1
For use in the United Kingdom and Singapore	490371-031
For use in the United States	490371-001
Screw Kit	
■ Phillips PM2.5x6.0 screw	
■ Phillips PM2.5x6.0 captive screw	
■ Phillips PM2.5x4.0 screw	
■ Phillips PM3.0x4.0 screw	
■ Phillips PM2.0x3.0 screw	
■ Phillips PM2.5x9.0 screw	
■ Phillips PM2.0x3.0 screw	
■ Phillips PM2.5x5.0 screw	
■ Phillips PM2.5x7.0 screw	
■ Phillips PM2.5x10.0 captive screw	
■ Phillips PM2.5x11.0 captive screw	

Sequential part number listing

Spare part number	Description
459263-001	Broadcom BCM4312 802.11b/g WLAN module for use in Canada, the Cayman Islands, Guam, Puerto Rico, the U.S. Virgin Islands, and the United States
459263-002	Broadcom BCM4312 802.11b/g WLAN module for use in Afghanistan, Albania, Algeria, Andorra, Angola, Antigua and Barbuda, Argentina, Armenia, Aruba, Australia, Austria, Azerbaijan, the Bahamas, Bahrain, Bangladesh, Barbados, Belarus, Belgium, Belize, Benin, Bermuda, Bhutan, Bolivia, Bosnia and Herzegovina, Botswana, Brazil, the British Virgin Islands, Brunei, Bulgaria, Burkina Faso, Burundi, Cameroon, Cape Verde, the Central African Republic, Chad, Chile, Colombia, Comoros, the Congo, Costa Rica, Croatia, Cyprus, the Czech Republic, Denmark, Djibouti, Dominica, the Dominican Republic, East Timor, Ecuador, Egypt, El Salvador, Equatorial Guinea, Eritrea, Estonia, Ethiopia, Fiji, Finland, France, French Guiana, Gabon, Gambia, Georgia, Germany, Ghana, Gibraltar, Greece, Grenada, Guadeloupe, Guatemala, Guinea, Guinea- Bissau, Guyana, Haiti, Honduras, Hong Kong, Hungary, Iceland, India, Ireland, Israel, Italy, the Ivory Coast, Jamaica, Jordan, Kazakhstan, Kenya, Kiribati, Kyrgyzstan, Laos, Latvia, Lebanon, Lesotho, Liberia, Liechtenstein, Lithuania, Luxembourg, Macedonia, Madagascar, Malawi, Malaysia, the Maldives, Mali, Malta, the Marshall Islands, Martinique, Mauritania, Mauritius, Mexico, Micronesia, Monaco, Mongolia, Montenegro, Morocco, Mozambique, Namibia, Nauru, Nepal, the Nether Antilles, the Netherlands, New Zealand, Nicaragua, Niger, Nigeria, Norway, Oman, Pakistan, Palau, Panama, Papua New Guinea, Paraguay, the People's Republic of China, Peru, the Philippines, Poland, Portugal, the Republic of Moldova, Romania, Russia, Rwanda, Samoa, San Marino, Sao Tome and Principe, Saudi Arabia, Senegal, Serbia and Montenegro, the Seychelles, Sierra Leone, Singapore, Slovakia, Slovenia, the Solomon Islands, Somalia, South Africa, South Korea, Spain, Sri Lanka, St. Kitts and Nevis, St. Lucia, St. Vincent and the Grenadines, Suriname, Swaziland, Sweden, Switzerland, Taiwan, Tajikistan, Tanzania, Togo, Tonga, Trinidad and Tobago, Tunisia, Turkey, Turkmenistan, Tuvalu, Uganda, Ukraine, the United Arab Emirates, the United Kingdom, Uruguay, Uzbekistan, Vanuatu, Venezuela, Vietnam, Yemen, Zaire, Zambia, and Zimbabwe
459339-001	Atheros AR2425 802.11b/g WLAN module for use in Canada, the Cayman Islands, Guam, Puerto Rico, the U.S. Virgin Islands, and the United States
459339-002	Atheros AR2425 802.11b/g WLAN module for use in Afghanistan, Albania, Algeria, Andorra, Angola, Antigua and Barbuda, Argentina, Armenia, Aruba, Australia, Austria, Azerbaijan, the Bahamas, Bahrain, Bangladesh, Barbados, Belarus, Belgium, Belize, Benin, Bermuda, Bhutan, Bolivia, Bosnia and Herzegovina, Botswana, Brazil, the British Virgin Islands, Brunei, Bulgaria, Burkina Faso, Burundi, Cameroon, Cape Verde, the Central African Republic, Chad, Chile, Colombia, Comoros, the Congo, Costa Rica, Croatia, Cyprus, the Czech Republic, Denmark, Djibouti, Dominica, the Dominican Republic, East Timor, Ecuador, Egypt, El Salvador, Equatorial Guinea, Eritrea, Estonia, Ethiopia, Fiji, Finland, France, French Guiana, Gabon, Gambia, Georgia, Germany, Ghana, Gibraltar, Greece, Grenada, Guadeloupe, Guatemala, Guinea, Guinea- Bissau, Guyana, Haiti, Honduras, Hong Kong, Hungary, Iceland, India, Ireland, Israel, Italy, the Ivory Coast, Jamaica, Jordan, Kazakhstan, Kenya, Kiribati, Kyrgyzstan, Laos, Latvia, Lebanon, Lesotho, Liberia, Liechtenstein, Lithuania, Luxembourg, Macedonia, Madagascar, Malawi, Malaysia, the Maldives, Mali, Malta, the Marshall Islands, Martinique, Mauritania, Mauritius, Mexico, Micronesia, Monaco, Mongolia, Montenegro, Morocco, Mozambique, Namibia, Nauru, Nepal, the Nether Antilles, the Netherlands, New Zealand, Nicaragua, Niger, Nigeria, Norway, Oman, Pakistan, Palau, Panama, Papua New Guinea, Paraguay, the People's Republic of China, Peru, the Philippines, Poland, Portugal, the Republic of Moldova, Romania, Russia, Rwanda, Samoa, San Marino, Sao Tome and Principe, Saudi Arabia, Senegal, Serbia and Montenegro, the Seychelles, Sierra Leone, Singapore, Slovakia, Slovenia, the Solomon Islands, Somalia, South Africa, South Korea, Spain, Sri Lanka, St. Kitts and Nevis, St. Lucia, St. Vincent and the Grenadines, Suriname, Swaziland, Sweden, Switzerland, Taiwan, Tajikistan, Tanzania, Togo, Tonga, Trinidad and Tobago, Tunisia, Turkey, Turkmenistan, Tuvalu, Uganda, Ukraine, the United Arab Emirates, the United Kingdom, Uruguay, Uzbekistan, Vanuatu, Venezuela, Vietnam, Yemen, Zaire, Zambia, and Zimbabwe
463598-001	65-W AC adapter
482260-001	Atheros AR9280 802.11a/b/g/n WLAN module for use in Canada, the Cayman Islands, Guam, Puerto Rico, the U.S. Virgin Islands, and the United States

(Continued)

Spare part number	Description
482260-002	Atheros AR9280 802.11a/b/g/n WLAN module for use in Afghanistan, Albania, Algeria, Andorra, Angola, Antigua and Barbuda, Argentina, Armenia, Aruba, Australia, Austria, Azerbaijan, the Bahamas, Bahrain, Bangladesh, Barbados, Belarus, Belgium, Belize, Benin, Bermuda, Bhutan, Bolivia, Bosnia and Herzegovina, Botswana, Brazil, the British Virgin Islands, Brunei, Bulgaria, Burkina Faso, Burundi, Cameroon, Cape Verde, the Central African Republic, Chad, Chile, Colombia, Comoros, the Congo, Costa Rica, Croatia, Cyprus, the Czech Republic, Denmark, Djibouti, Dominica, the Dominican Republic, East Timor, Ecuador, Egypt, El Salvador, Equatorial Guinea, Eritrea, Estonia, Ethiopia, Fiji, Finland, France, French Guiana, Gabon, Gambia, Georgia, Germany, Ghana, Gibraltar, Greece, Grenada, Guadeloupe, Guatemala, Guinea, Guinea-Bissau, Guyana, Haiti, Honduras, Hong Kong, Hungary, Iceland, India, Ireland, Israel, Italy, the Ivory Coast, Jamaica, Jordan, Kazakhstan, Kenya, Kiribati, Kyrgyzstan, Laos, Latvia, Lebanon, Lesotho, Liberia, Liechtenstein, Lithuania, Luxembourg, Macedonia, Madagascar, Malawi, Malaysia, the Maldives, Mali, Malta, the Marshall Islands, Martinique, Mauritania, Mauritius, Mexico, Micronesia, Monaco, Mongolia, Montenegro, Morocco, Mozambique, Namibia, Nauru, Nepal, the Nether Antilles, the Netherlands, New Zealand, Nicaragua, Niger, Nigeria, Norway, Oman, Palau, Panama, Papua New Guinea, Paraguay, the People's Republic of China, Peru, the Philippines, Poland, Portugal, the Republic of Moldova, Romania, Rwanda, Samoa, San Marino, Sao Tome and Principe, Saudi Arabia, Senegal, Serbia and Montenegro, the Seychelles, Sierra Leone, Singapore, Slovakia, Slovenia, the Solomon Islands, Somalia, South Africa, South Korea, Spain, Sri Lanka, St. Kitts and Nevis, St. Lucia, St. Vincent and the Grenadines, Suriname, Swaziland, Sweden, Switzerland, Taiwan, Tajikistan, Tanzania, Togo, Tonga, Trinidad and Tobago, Tunisia, Turkey, Turkmenistan, Tuvalu, Uganda, the United Arab Emirates, the United Kingdom, Uruguay, Uzbekistan, Vanuatu, Venezuela, Vietnam, Yemen, Zaire, Zambia, and Zimbabwe
483113-001	Bluetooth module (does not include Bluetooth cable)
485031-005	512-MB memory module (PC2-6400, 667-MHz, DDR2)
485032-005	1-GB memory module (PC2-6400, 667-MHz, DDR2)
485033-005	2-GB memory module (PC2-6400, 667-MHz, DDR2)
485041-001	Battery, 6-cell, 2.20-Ah, 47-Wh
485218-001	UMA system board, GM45 (includes built-in modem, Digital Media Slot, HDMI port, and replacement thermal material)
485219-001	UMA system board, GL40 (includes built-in modem, Digital Media Slot, HDMI port, and replacement thermal material)
486556-001	Display inverter
486558-001	Display Hinge Kit (includes left and right display hinges)
486562-001	Display antenna cable
486584-001	Display Rubber Kit (includes display bezel rubber screw covers)
486621-001	Plastics Kit
486622-001	Screw Kit
486623-001	Rubber Feet Kit (includes 6 rubber feet)
486633-001	USB board
486634-001	Audio board
488338-001	Discrete system board, PM45 (includes built-in modem, Digital Media Slot, HDMI port, and replacement thermal material)
488385-001	Webcam
489119-001	TouchPad board bracket
489126-001	Fan/heat sink for use with UMA systems (includes replacement thermal material)
489149-001	Audio board (includes audio board cable)
489154-001	Fan/heat sink for use with discrete systems (includes replacement thermal material)
<i>(Continued)</i>	
490111-001	Intel Core2 Duo P8400 2.26-GHz processor (3-MB L2 cache, 1066-MHz FSB)

Spare part number	Description
490112-001	Intel Core2 Duo P8600 2.4-GHz processor (3-MB L2 cache, 1066-MHz FSB)
490113-001	Intel Core2 Duo T9400 2.53-GHz processor (6-MB L2 cache, 1066-MHz FSB)
490115-001	Intel Pentium Dual-Core T3200 2.0-GHz processor (1-MB L2 cache, 667-MHz FSB)
490116-001	Intel Celeron-M 575 2.0-GHz processor (1-MB L2 cache, 667-MHz FSB)
490117-001	Intel Celeron-M 585 2.16-GHz processor (1-MB L2 cache, 667-MHz FSB)
490371-001	Power cord for use in the United States
490371-011	Power cord for use in Australia
490371-021	Power cord for use in Europe
490371-031	Power cord for use in the United Kingdom and Singapore
490371-061	Power cord for use in Italy
490371-081	Power cord for use in Denmark
490371-111	Power cord for use in Sweden
490371-201	Power cord for use in Brazil
490371-AB1	Power cord for use in Taiwan
490371-AD1	Power cord for use in South Korea
490371-AR1	Power cord for use in South Africa
490371-BB1	Power cord for use in Israel
490371-D01	Power cord for use in Argentina
490371-D61	Power cord for use in India
494281-001	UMA system board, GM45 (includes built-in modem, Digital Media Slot, and replacement thermal material)
494282-001	UMA system board, GL40 (includes built-in modem, Digital Media Slot, and replacement thermal material)
494283-001	Discrete system board, PM45 (includes built-in modem, Digital Media Slot, and replacement thermal material)
496761-001	16-inch WXGA BrightView display assembly for HP G60 computer models (includes microphone)
496762-001	16-inch WXGA BrightView display assembly for HP G60 computer models (includes webcam module and cable, microphone and cable, and logo)
496763-001	15.6-inch WXGA BrightView display assembly for HP G60 computer models (includes microphone and cable, and logo)
496764-001	15.6-inch WXGA BrightView display assembly for HP G60 computer models (includes webcam module and cable, 2 WLAN antenna transceivers and cables, microphone and cable, and logo)
496765-001	16-inch WXGA BrightView display assembly for Presario CQ60 computer models (includes microphone and cable and logo)
496766-001	16-inch WXGA BrightView display assembly for Presario CQ60 computer models (includes webcam module and cable, 2 WLAN antenna transceivers and cables, microphone and cable, and logo)
496767-001	15.6-inch WXGA BrightView display assembly for Presario CQ60 computer models (includes microphone and cable, and logo)
496768-001	15.6-inch WXGA BrightView display assembly for Presario CQ60 computer models (includes webcam module and cable, 2 WLAN antenna transceivers and cables, microphone and cable, and logo)
<i>(Continued)</i>	
496769-001	16-inch WXGA BrightView display panel

Spare part number	Description
496770-001	15.6-inch WXGA BrightView display panel
496771-001	Keyboard for use in the United States (includes keyboard cable)
496771-031	Keyboard for use in the United Kingdom (includes keyboard cable)
496771-041	Keyboard for use in Germany (includes keyboard cable)
496771-051	Keyboard for use in France (includes keyboard cable)
496771-061	Keyboard for use in Italy (includes keyboard cable)
496771-071	Keyboard for use in Spain (includes keyboard cable)
496771-091	Keyboard for use in Norway (includes keyboard cable)
496771-111	Keyboard for use in Switzerland (includes keyboard cable)
496771-121	Keyboard for use in Canada (includes keyboard cable)
496771-131	Keyboard for use in Portugal (includes keyboard cable)
496771-141	Keyboard for use Turkey (includes keyboard cable)
496771-151	Keyboard for use in Greece (includes keyboard cable)
496771-161	Keyboard for use in Latin America (includes keyboard cable)
496771-171	Keyboard for use in Saudi Arabia (includes keyboard cable)
496771-181	Keyboard for use in Belgium (includes keyboard cable)
496771-221	Keyboard for use in the Czech Republic (includes keyboard cable)
496771-251	Keyboard for use in Russia (includes keyboard cable)
496771-281	Keyboard for use in Thailand (includes keyboard cable)
496771-291	Keyboard for use in Japan (includes keyboard cable)
496771-AB1	Keyboard for use in Taiwan (includes keyboard cable)
496771-AD1	Keyboard for use in South Korea (includes keyboard cable)
496771-B31	Keyboard for international use (includes keyboard cable)
496771-BB1	Keyboard for use in Israel (includes keyboard cable)
496825-001	Base enclosure for use only with computer models equipped with a built-in modem, Digital Media Slot, and an HDMI port (includes card reader, not illustrated)
492826-001	Base enclosure for use only with computer models equipped with a built-in modem and Digital Media Slot, without an HDMI port
496827-001	Base enclosure for use only with computer models equipped with a built-in modem
496829-001	Speakers (include left and right speakers and cables)
496830-001	Power button board
496832-001	TouchPad on/off button board
496835-001	Power connector cable
496836-001	Bluetooth cable
496837-001	USB cable (includes num lock cable)
496838-001	Modem with connector cable
496840-001	Microphone cable (includes caps lock cable)
496841-001	Display Cable Kit
496842-001	Display Webcam Cable Kit
<i>(Continued)</i>	
496843-001	16-inch display bracket

Spare part number	Description
496844-001	15.6-inch display bracket
497093-001	Display cover for use with Presario CQ60 computer models
497094-001	Display cover for use with HP G60 computer models
497095-001	16-inch display bezel for use with Presario CQ60 computer models (includes microphone)
497096-001	16-inch display bezel for use with Presario CQ60 computer models (includes microphone and webcam)
497097-001	16-inch display bezel for use with HP G60 computer models (includes microphone)
497098-001	16-inch display bezel for use with HP G60 computer models (includes microphone and webcam)
497099-001	15.6-inch display bezel for use with Presario CQ60 computer models (includes microphone)
497100-001	15.6-inch display bezel for use with Presario CQ60 computer models (includes microphone and webcam)
497101-001	15.6-inch display bezel for use with HP G60 computer models (includes microphone)
497102-001	15.6-inch display bezel for use with HP G60 computer models (includes microphone and webcam)
498460-001	UMA system board, NVIDIA (includes built-in modem, Digital Media Slot, HDMI port, and replacement thermal material)
498462-001	UMA system board, NVIDIA (for Presario CQ60 use only; includes built-in modem, Digital Media Slot, and replacement thermal material)
498463-001	UMA system board, NVIDIA (for Presario CQ60 use only; includes built-in modem, HDMI port, and replacement thermal material)
498464-001	UMA system board, NVIDIA (for Presario CQ60 use only; includes built-in modem and replacement thermal material)
498465-001	AMD Turion Ultra Dual-Core ZM-80 2.1-GHz processor (2-MB L2 cache)
498466-001	AMD Turion Ultra Dual-Core ZM-82 2.2-GHz processor (2-MB L2 cache)
498467-001	AMD Turion Dual-Core RM-70 2.0-GHz processor (1-MB L2 cache)
498468-001	AMD Turion Dual-Core RM-72 2.1-GHz processor (1-MB L2 cache)
498469-001	AMD Athlon X2 dual-Core QL-60 1.9-GHz processor (1-MB L2 cache)
498470-001	AMD Athlon X2 dual-Core QL-62 2.0-GHz processor (1-MB L2 cache)
498471-001	AMD Sempron Single Core SI-42 2.1-GHz processor (512-KB L2 cache)
498472-001	AMD Sempron Single Core SI-40 2.0-GHz processor (512-KB L2 cache)
498473-001	512-MB memory module (PC2-5300, 667-MHz, DDR)
498474-001	1-GB memory module (PC2-5300, 667-MHz, DDR)
498475-001	2-GB memory module (PC2-5300, 667-MHz, DDR)
498476-001	120-GB hard drive
498477-001	160-GB hard drive
498478-001	250-GB hard drive
498479-001	DVD±RW and CD-RW SuperMulti Double-Layer Combo Drive
498480-001	DVD±RW and CD-RW SuperMulti Double-Layer Combo Drive with LightScribe
498481-001	Blu-ray ROM DVD±RW SuperMulti DL Drive
501266-001	UMA system board, GL40 (for Presario CQ60 computer models only; includes built-in modem and replacement thermal material)
<i>(Continued)</i>	
501520-001	Intel Core2 Duo P7350 2.0-GHz processor (3-MB L2 cache, 1066-MHz FSB)

Spare part number	Description
501521-001	Intel Core2 Duo T5800 2.0-GHz processor (2-MB L2 cache, 800-MHz FSB)
501522-001	Intel Core2 Duo T5900 2.2-GHz processor (2-MB L2 cache, 800-MHz FSB)
501523-001	Intel Pentium Dual-Core T3400 2.16-GHz processor (1-MB L2 cache, 667-MHz FSB)
501524-001	Intel Celeron-T T1600 1.66-GHz processor (1-MB L2 cache, 667-MHz FSB)
501525-001	Intel Celeron-T T1700 1.86-GHz processor (1-MB L2 cache, 667-MHz FSB)
501587-001	RTC battery
502072-001	320-GB hard drive
502949-001	16-inch WXGA BrightView silver display assembly for HP G60 computer models (includes microphone and cable and logo)
502950-001	16-inch WXGA BrightView silver display assembly for HP G60 computer models (includes webcam module and cable, 2 WLAN antenna transceivers and cables, microphone and cable, and logo)
502951-001	15.6-inch WXGA BrightView silver display assembly for HP G60 computer models (includes microphone and cable, and logo)
502952-001	15.6-inch WXGA BrightView silver display assembly for HP G60 computer models (includes webcam module and cable, 2 WLAN antenna transceivers and cables, microphone and cable, and logo)
502953-001	Silver display
502958-001	Silver keyboard for use in the United States (includes keyboard cables)
502958-121	Silver keyboard for us in Canada (includes keyboard cables)
504059-001	Hard Drive Hardware Kit (includes hard drive bracket, connector, and screws)
504740-001	Base enclosure (includes built-in-modem, HDMI port, without a card reader)
505971-001	200-GB hard drive
506848-001	Keyboard cover
506849-001	Top cover
506951-001	Optical extension board

Removal and replacement procedures

Preliminary replacement requirements

Tools required

You will need the following tools to complete the removal and replacement procedures:

- Flat-bladed screwdriver
- Magnetic screwdriver
- Phillips P0 and P1 screwdrivers

Service considerations

The following sections include some of the considerations that you must keep in mind during disassembly and assembly procedures.



As you remove each subassembly from the computer, place the subassembly (and all accompanying screws) away from the work area to prevent damage.

Plastic parts



CAUTION: Using excessive force during disassembly and reassembly can damage plastic parts. Use care when handling the plastic parts. Apply pressure only at the points designated in the maintenance instructions.

Cables and connectors



CAUTION: When servicing the computer, be sure that cables are placed in their proper locations during the reassembly process. Improper cable placement can damage the computer.

Cables must be handled with extreme care to avoid damage. Apply only the tension required to unseat or seat the cables during removal and insertion. Handle cables by the connector whenever possible. In all cases, avoid bending, twisting, or tearing cables. Be sure that cables are routed in such a way that they cannot be caught or snagged by parts being removed or replaced. Handle flex cables with extreme care; these cables tear easily.

Drive handling



CAUTION: Drives are fragile components that must be handled with care. To prevent damage to the computer, damage to a drive, or loss of information, observe these precautions:

- Before removing or inserting a hard drive, shut down the computer. If you are unsure whether the computer is off or in Hibernation, turn the computer on, and then shut it down through the operating system.
- Before handling a drive, be sure that you are discharged of static electricity. While handling a drive, avoid touching the connector.
- Before removing a diskette drive or optical drive, be sure that a diskette or disc is not in the drive and be sure that the optical drive tray is closed.
- Handle drives on surfaces covered with at least one inch of shock-proof foam.
- Avoid dropping drives from any height onto any surface.
- After removing a hard drive, an optical drive, or a diskette drive, place it in a static-proof bag.
- Avoid exposing a hard drive to products that have magnetic fields, such as monitors or speakers.
- Avoid exposing a drive to temperature extremes or liquids.
- If a drive must be mailed, place the drive in a bubble pack mailer or other suitable form of protective packaging and label the package "FRAGILE."

Grounding guidelines

Electrostatic discharge damage

Electronic components are sensitive to electrostatic discharge (ESD). Circuitry design and structure determine the degree of sensitivity. Networks built into many integrated circuits provide some protection, but in many cases, ESD contains enough power to alter device parameters or melt silicon junctions.

A discharge of static electricity from a finger or other conductor can destroy static-sensitive devices or microcircuitry. Even if the spark is neither felt nor heard, damage may have occurred.

An electronic device exposed to ESD may not be affected at all and can work perfectly throughout a normal cycle. Or the device may function normally for a while, then degrade in the internal layers, reducing its life expectancy.



CAUTION: To prevent damage to the computer when you are removing or installing internal components, observe these precautions:

- Keep components in their electrostatic-safe containers until you are ready to install them.
- Use nonmagnetic tools.
- Before touching an electronic component, discharge static electricity by using the guidelines described in this section.
- Avoid touching pins, leads, and circuitry. Handle electronic components as little as possible.
- If you remove a component, place it in an electrostatic-safe container.

The following table shows how humidity affects the electrostatic voltage levels generated by different activities.



CAUTION: A product can be degraded by as little as 700 V.

Typical electrostatic voltage levels			
Event	Relative humidity		
	10%	40%	55%
Walking across carpet	35,000 V	15,000 V	7,500 V
Walking across vinyl floor	12,000 V	5,000 V	3,000 V
Motions of bench worker	6,000 V	800 V	400 V
Removing DIPS from plastic tube	2,000 V	700 V	400 V
Removing DIPS from vinyl tray	11,500 V	4,000 V	2,000 V
Removing DIPS from Styrofoam	14,500 V	5,000 V	3,500 V
Removing bubble pack from PCB	26,500 V	20,000 V	7,000 V
Packing PCBs in foam-lined box	21,000 V	11,000 V	5,000 V

Packaging and transporting guidelines

Follow these grounding guidelines when packaging and transporting equipment:

- To avoid hand contact, transport products in static-safe tubes, bags, or boxes.
- Protect ESD-sensitive parts and assemblies with conductive or approved containers or packaging.
- Keep ESD-sensitive parts in their containers until the parts arrive at static-free workstations.
- Place items on a grounded surface before removing items from their containers.
- Always be properly grounded when touching a component or assembly.
- Store reusable ESD-sensitive parts from assemblies in protective packaging or nonconductive foam.
- Use transporters and conveyors made of antistatic belts and roller bushings. Be sure that mechanized equipment used for moving materials is wired to ground and that proper materials are selected to avoid static charging. When grounding is not possible, use an ionizer to dissipate electric charges.

Workstation guidelines

Follow these grounding workstation guidelines:

- Cover the workstation with approved static-shielding material.
- Use a wrist strap connected to a properly grounded work surface and use properly grounded tools and equipment.
- Use conductive field service tools, such as cutters, screwdrivers, and vacuums.
- When fixtures must directly contact dissipative surfaces, use fixtures made only of static-safe materials.
- Keep the work area free of nonconductive materials, such as ordinary plastic assembly aids and Styrofoam.
- Handle ESD-sensitive components, parts, and assemblies by the case or PCM laminate. Handle these items only at static-free workstations.
- Avoid contact with pins, leads, or circuitry.
- Turn off power and input signals before inserting or removing connectors or test equipment.

Equipment guidelines

Grounding equipment must include either a wrist strap or a foot strap at a grounded workstation.

- When seated, wear a wrist strap connected to a grounded system. Wrist straps are flexible straps with a minimum of one megohm $\pm 10\%$ resistance in the ground cords. To provide proper ground, wear a strap snugly against the skin at all times. On grounded mats with banana-plug connectors, use alligator clips to connect a wrist strap.
- When standing, use foot straps and a grounded floor mat. Foot straps (heel, toe, or boot straps) can be used at standing workstations and are compatible with most types of shoes or boots. On conductive floors or dissipative floor mats, use foot straps on both feet with a minimum of one megohm resistance between the operator and ground. To be effective, the conductive strips must be worn in contact with the skin.

The following grounding equipment is recommended to prevent electrostatic damage:

- Antistatic tape
- Antistatic smocks, aprons, and sleeve protectors
- Conductive bins and other assembly or soldering aids
- Nonconductive foam
- Conductive tabletop workstations with ground cords of one megohm resistance
- Static-dissipative tables or floor mats with hard ties to the ground
- Field service kits
- Static awareness labels
- Material-handling packages
- Nonconductive plastic bags, tubes, or boxes
- Metal tote boxes
- Electrostatic voltage levels and protective materials

The following table lists the shielding protection provided by antistatic bags and floor mats.

Material	Use	Voltage protection level
Antistatic plastic	Bags	1,500 V
Carbon-loaded plastic	Floor mats	7,500 V
Metallized laminate	Floor mats	5,000 V

Unknown user password

If the computer you are servicing has an unknown user password, follow these steps to clear the password:



These steps also clear CMOS.

1. Shut down the computer. If you are unsure whether the computer is off or in Hibernation, turn the computer on, and then shut it down through the operating system.
2. Disconnect all external devices connected to the computer.
3. Disconnect the power from the computer by first unplugging the power cord from the AC outlet and then unplugging the AC adapter from the computer.
4. Remove the battery (see [“Battery” on page 4-7](#)).
5. Remove the real-time clock (RTC) battery (see [“RTC battery” on page 4-12](#)).
6. Wait approximately 5 minutes.

7. Replace the RTC battery and reassemble the computer.
8. Connect AC power to the computer. Do not reinsert any batteries at this time.
9. Turn on the computer.

All passwords and all CMOS settings have been cleared.

Component replacement procedures

This chapter provides removal and replacement procedures.

There are as many as 72 screws, in 9 different sizes, that must be removed, replaced, or loosened when servicing the computer. Make special note of each screw and standoff size and location during removal and replacement.

Serial number

The service tag, affixed to the bottom of the computer, provides information that may be needed when troubleshooting system problems. The service tag provides the following information:

When ordering parts or requesting information, provide the computer serial number and model number located on the bottom of the computer.

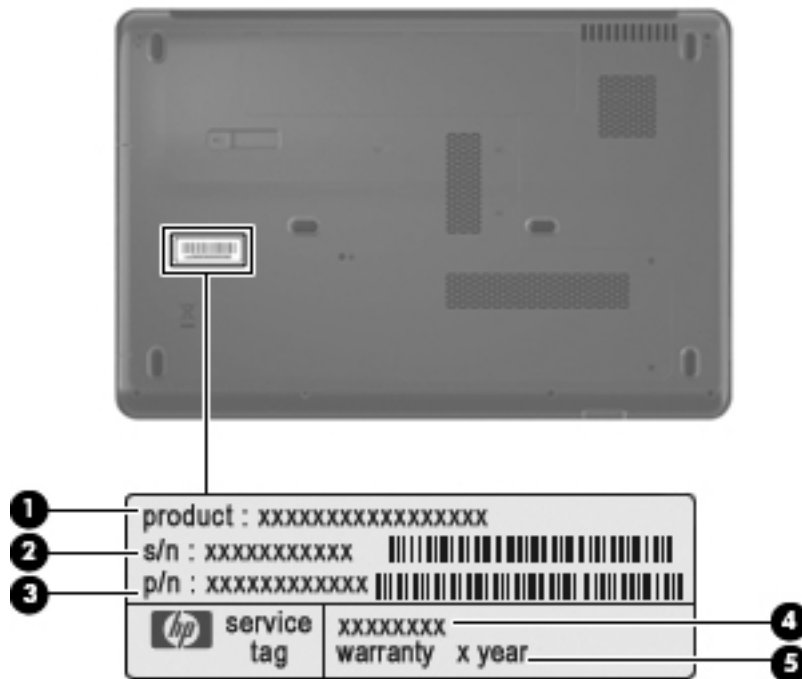

Item	Component	Description
❶	Product name	This is the product name affixed to the front of the computer.
❷	Serial number (s/n)	This is an alphanumeric identifier that is unique to each product.
❸	Part number/Product number (p/n)	This number provides specific information about the product's hardware components. The part number helps a service technician to determine what components and parts are needed.
❹	Model description	This is the number used to locate documents, drivers, and support for the computer.
❺	Warranty period	This number describes the duration of the warranty period for the computer.

Computer feet

Description	Serial Number
Rubber Feet Kit (includes 6 rubber feet)	486623-001

The computer feet are adhesive-backed rubber pads. The feet attach to the base enclosure in the locations illustrated below.

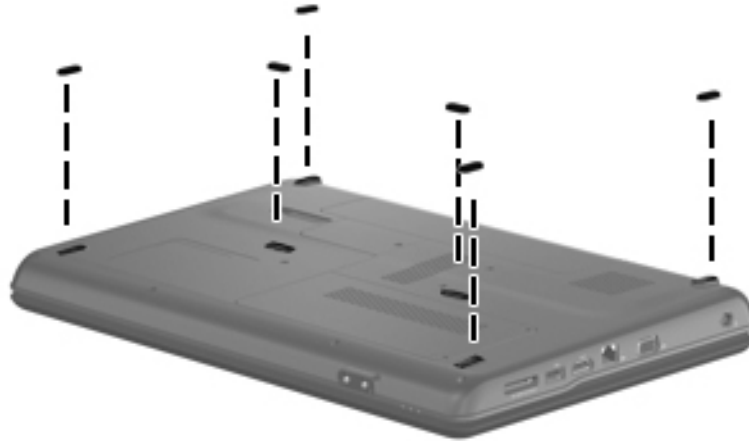

Battery

Description	Spare part number
6 cell, 2.20-Ah, 47-Wh	485041-001

Before disassembling the computer, follow these steps:

1. Shut down the computer. If you are unsure whether the computer is off or in Hibernation, turn the computer on, and then shut it down through the operating system.
2. Disconnect all external devices connected to the computer.
3. Disconnect the power from the computer by first unplugging the power cord from the AC outlet and then unplugging the AC adapter from the computer.

Remove the battery:

1. Turn the computer upside down on a flat surface, with the battery bay toward you.
2. Slide the battery release latch **1** to release the battery.
3. Pivot the battery **2** upward and remove it **3** from the computer.

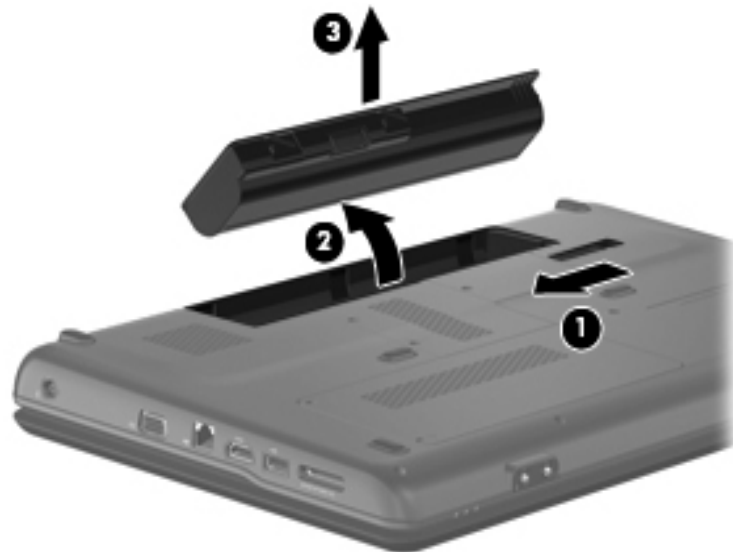

Install the battery by inserting it into the battery bay until you hear a click.

Optical drive



The optical drive spare part kit includes an optical drive bezel and optical drive bracket.

Description	Spare part number
DVD±RW and CD-RW SuperMulti Double Layer Combo Drive	498479-001
DVD±RW and CD-RW SuperMulti Double Layer Combo Drive with LightScribe	498480-001
Blu-ray ROM DVD±RW SuperMulti DL Drive	498481-001

Before removing the optical drive, follow these steps:

1. Shut down the computer. If you are unsure whether the computer is off or in Hibernation, turn the computer on, and then shut it down through the operating system.
2. Disconnect all external devices connected to the computer.
3. Disconnect the power from the computer by first unplugging the power cord from the AC outlet and then unplugging the AC adapter from the computer.
4. Remove the battery (see [“Battery” on page 4-7](#)).

Remove the optical drive:

1. Position the computer with the left side toward you.
2. Remove the Phillips PM2.5×9.0 screw ❶ that secures the optical drive to the computer.
3. Insert a thin tool, such as a paper clip ❷, into the release access. (The disc tray is partially ejected from the optical drive.)
4. Grasp the bezel and slide the optical drive ❸ out of the computer.

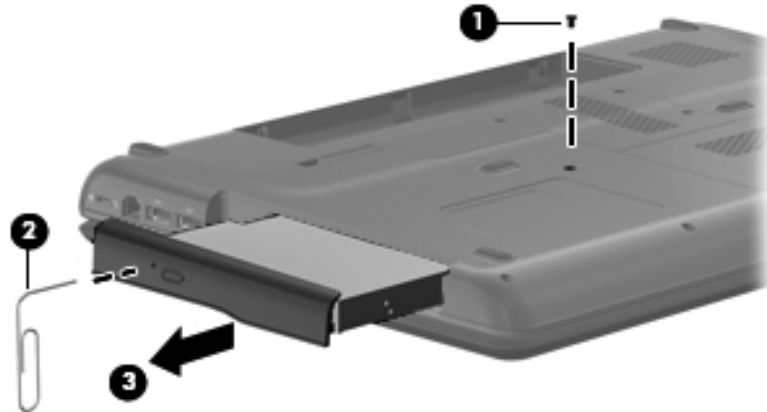

5. If it is necessary to replace the optical drive bracket, position the optical drive with the rear toward you.
6. Remove the 2 Phillips PM2.0×4.0 screws ❶ that secure the optical drive bracket to the optical drive.
7. Remove the optical drive bracket ❷.

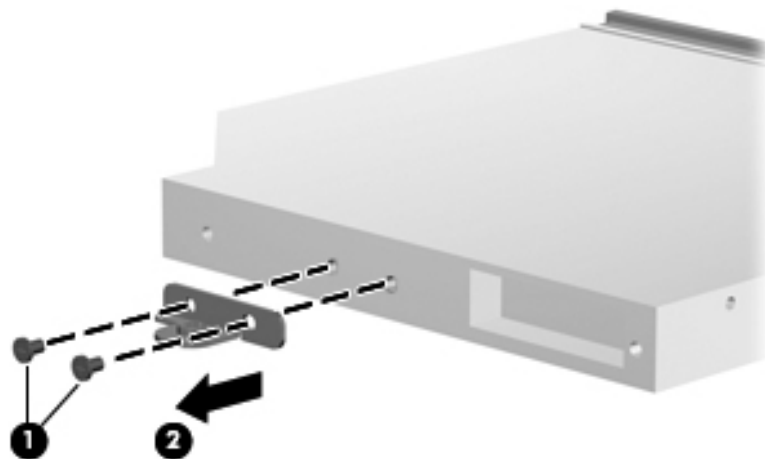

Reverse this procedure to reassemble and install an optical drive.

Hard drive



The hard drive spare part kit includes a hard drive bracket and hard drive connector. The hard drive bracket and hard drive connector, as well as the hard drive bracket screws, are also available in the Hard Drive Hardware Kit.

Description	Spare part number
120-GB, 5400-rpm	504072-001
160-GB, 5400-rpm	498478-001
200-GB, 5400-rpm	505971-001
250-GB, 5400-rpm	498477-001
320-GB, 5400-rpm	498476-001
Hard Drive Hardware Kit	504059-001

Before removing the hard drive, follow these steps:

1. Shut down the computer. If you are unsure whether the computer is off or in Hibernation, turn the computer on, and then shut it down through the operating system.
2. Disconnect all external devices connected to the computer.
3. Disconnect the power from the computer by first unplugging the power cord from the AC outlet and then unplugging the AC adapter from the computer.
4. Remove the battery (see [“Battery” on page 4-7](#)).

Remove the hard drive:

1. Loosen the two Phillips PM2.5×6.0 captive screws ❶ that secure the hard drive cover to the computer.
2. Lift the right side of the hard drive cover ❷, swing it up and to the left, and remove the cover. The hard drive cover is included in the Plastics Kit, spare part number 486621-001.

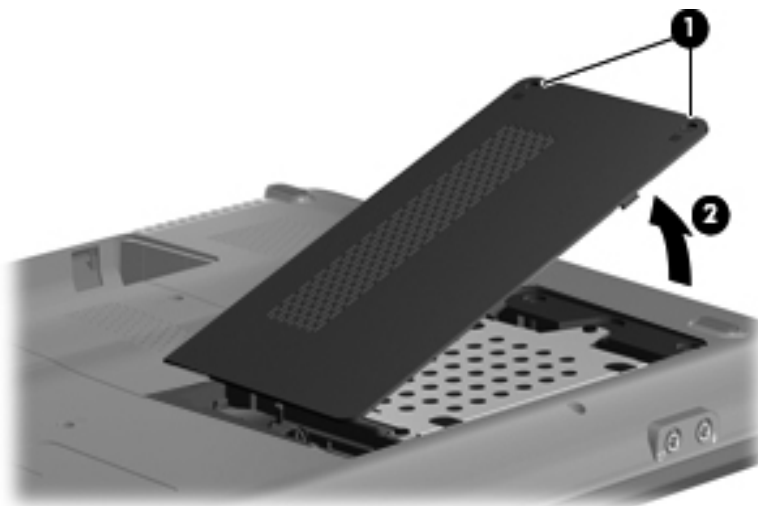

3. Remove the three Phillips PM2.5×5.0 screws ❶ that secure the hard drive to the computer.
4. Grasp the Mylar tab ❷ on the hard drive, and then slide the hard drive ❸ to the right to disconnect it from the system board.
5. Remove the hard drive ❹ from the hard drive bay.

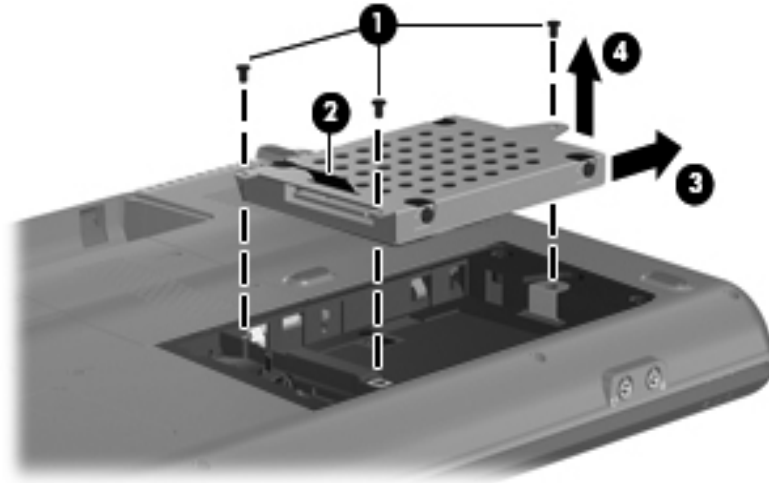

6. If it is necessary to replace the hard drive bracket, remove the two Phillips PM3.0×4.0 hard drive bracket screws ❶ from each side of the hard drive.
7. Lift the bracket ❷ straight up to remove it from the hard drive.

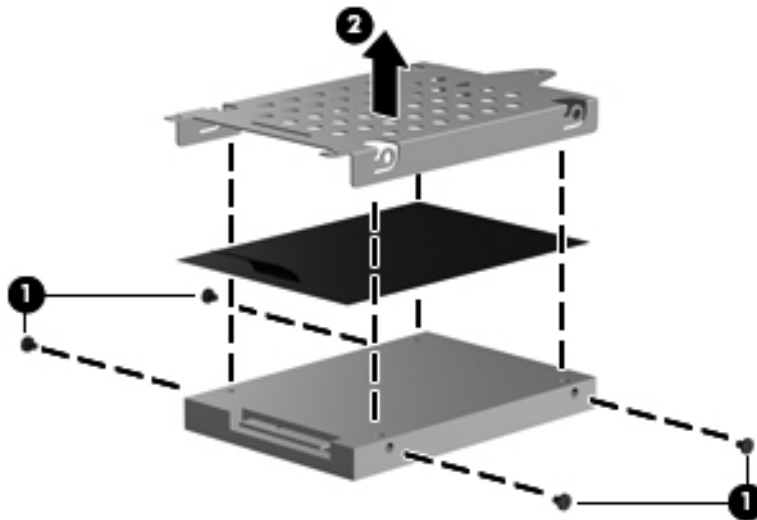

Reverse this procedure to reassemble and install the hard drive.

RTC battery



Removing the RTC battery and leaving it uninstalled for 5 or more minutes causes all passwords and CMOS settings to be cleared.

Description	Spare part number
RTC battery	501587-001

Before removing the RTC battery, follow these steps:

1. Shut down the computer. If you are unsure whether the computer is off or in Hibernation, turn the computer on, and then shut it down through the operating system.
2. Disconnect all external devices connected to the computer.
3. Disconnect the power from the computer by first unplugging the power cord from the AC outlet and then unplugging the AC adapter from the computer.
4. Remove the battery (see [“Battery” on page 4-7](#)).
5. Remove the hard drive cover (see [“Hard drive” on page 4-10](#)).

Remove the RTC battery:

1. Disconnect the RTC battery cable ❶ from the system board.
2. Remove the RTC battery ❷ from the clip built into the base enclosure. The RTC battery is attached to the system board with double-sided tape.

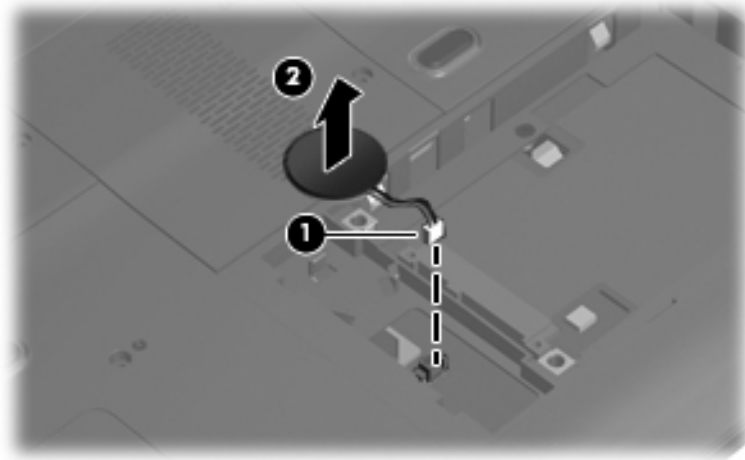

Reverse this procedure to install the RTC battery.

Memory module

Description	Spare part number
512-MB, PC2-5300	498473-004
1-GB, PC2-5300	498474-004
2-GB, PC2-5300	498475-004
512-MB, PC2-6400	485031-005
1-GB, PC2-6400	485032-005
2-GB, PC2-6400	485033-005

Before removing the memory module, follow these steps:

1. Shut down the computer. If you are unsure whether the computer is off or in Hibernation, turn the computer on, and then shut it down through the operating system.
2. Disconnect all external devices connected to the computer.
3. Disconnect the power from the computer by first unplugging the power cord from the AC outlet and then unplugging the AC adapter from the computer.
4. Remove the battery (see [“Battery” on page 4-7](#)).

Remove the memory module:

1. Loosen the two Phillips PM2.5×6.0 captive screws ❶ that secure the memory module compartment cover to the computer.
2. Lift the right side of the cover ❷, swing it up and to the left, and remove the cover. The memory module compartment cover is included in the Plastics Kit, spare part number 486621-001.

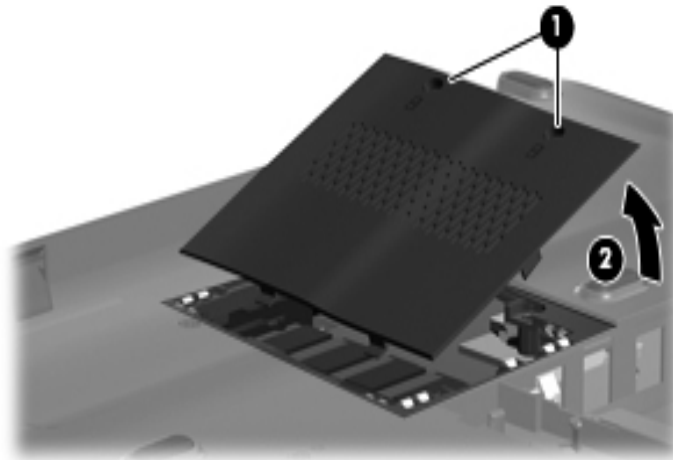

3. Spread the retaining tabs ❶ on each side of the memory module slot to release the memory module. (The edge of the module opposite the slot rises away from the computer.)
4. Remove the memory module ❷ by pulling the module away from the slot at an angle.



Memory modules are designed with a notch ❸ to prevent incorrect insertion into the memory module slot.

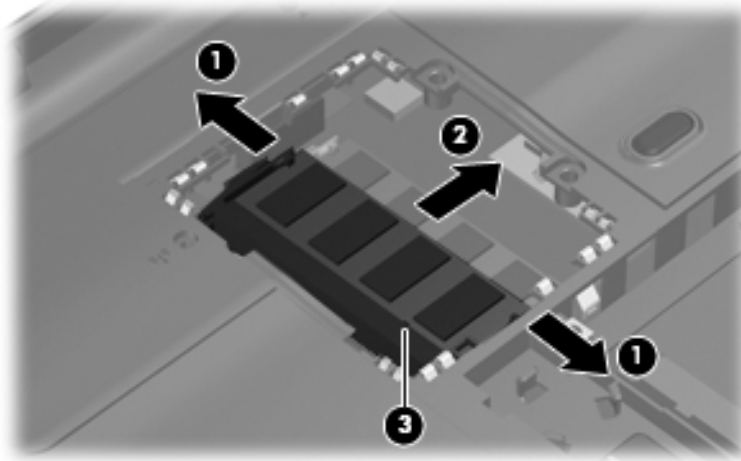

Reverse this procedure to install a memory module.

WLAN module

Description	Spare part number
Atheros AR2425 802.11b/g	459339-001
Atheros AR2425 802.11b/g	459339-002
Broadcom BCM4312 802.11b/g	459263-001
Broadcom BCM4312 802.11b/g	459263-002
Atheros AR9280 802.11a/b/g/n	482260-001
Atheros AR9280 802.11a/b/g/n	482260-002

Before removing the WLAN module, follow these steps:

1. Shut down the computer. If you are unsure whether the computer is off or in Hibernation, turn the computer on, and then shut it down through the operating system.
2. Disconnect all external devices connected to the computer.
3. Disconnect the power from the computer by first unplugging the power cord from the AC outlet and then unplugging the AC adapter from the computer.
4. Remove the battery (see [“Battery” on page 4-7](#)).

Remove the WLAN module:

1. Remove the WLAN module cover:
 - a. Loosen the Phillips PM2.5X6.0 captive screw ❶ that secures the WLAN module component cover to the computer.
 - b. Lift the right side of the WLAN module cover ❷, swing it to the left, and remove it. The WLAN module cover is included in the Plastics Kit, spare part number 486621-001.

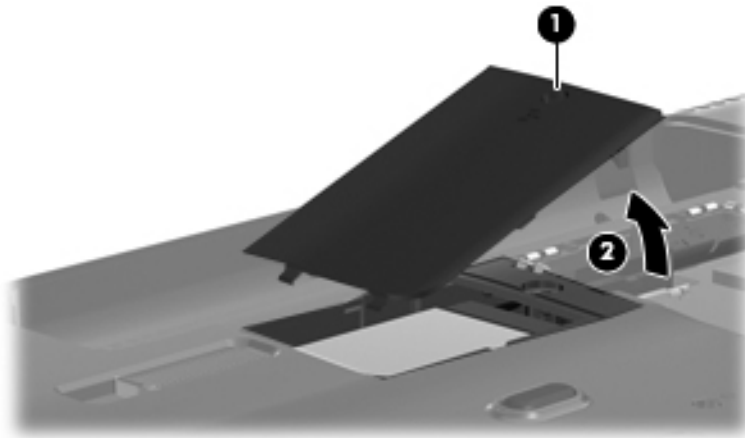

2. Disconnect the two antenna cables ❶ from the wireless module.

 The black WLAN antenna cable is connected to the WLAN module “Main” terminal. The white WLAN antenna cable is connected to the WLAN module “Aux” terminal.

3. Remove the two Phillips PM2.0×4.0 screws ❷ that secure the WLAN module to the computer. (The edge of the module opposite the slot rises away from the computer.)

4. Remove the WLAN module ❸ by pulling the module away from the slot at an angle.

 WLAN modules are designed with a notch ❹ to prevent incorrect insertion.

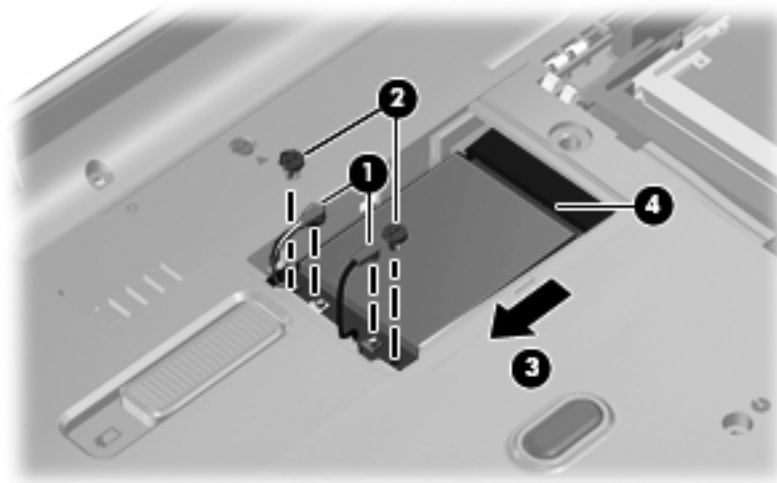

Reverse this procedure to install the WLAN module.

Keyboard

Description	Spare part number
For use in the Czech Republic	496771-221
For use in Canada	496771-121
(Silver) For use in Canada	502958-121
For use in France	496771-051
For use in Germany	496771-041
For use in Greece	496771-151
For international use	496771-B31
For use in Israel	496771-BB1
For use in Italy	496771-061
For use in Japan	496771-291
For use in Norway	496771-091
For use in South Korea	496771-AD1
For use in Latin America	496771-161
For use in Portugal	496771-131
For use in Russia	496771-251
For use in Saudi Arabia	496771-171
For use in Spain	496771-071
For use in Switzerland	496771-111
For use in Thailand	496771-281
For use in Taiwan	496771-AB1
For use in Turkey	496771-141
For use in the United Kingdom	496771-031
For use in the United States	496771-001
(Silver) For use in the United States	502958-001

Before removing the keyboard, follow these steps:

1. Shut down the computer. If you are unsure whether the computer is off or in Hibernation, turn the computer on, and then shut it down through the operating system.
2. Disconnect all external devices connected to the computer.
3. Disconnect the power from the computer by first unplugging the power cord from the AC outlet and then unplugging the AC adapter from the computer.
4. Remove the battery (see [“Battery” on page 4-7](#)).

Remove the keyboard:

1. Turn the computer upside down, with the front toward you.
2. Remove the three Phillips PM2.5x5.0 screws that secure the keyboard to the computer.

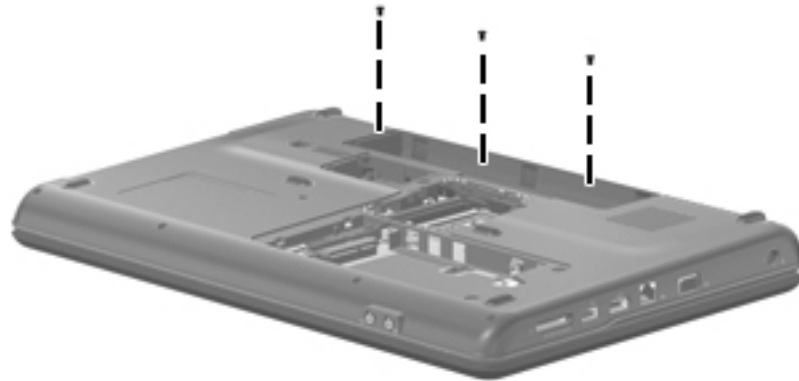

3. Turn the computer display-side up, with the front toward you.
4. Open the computer as far as possible.
5. Release the tabs ❶ along the right and left edges of the keyboard.
6. Lift the rear edge of the keyboard ❷, and then slide it back until it rests on the display.



7. Release the zero insertion force (ZIF) connector ❶ to which the keyboard cable is attached, and then disconnect the keyboard cable ❷ from the system board.

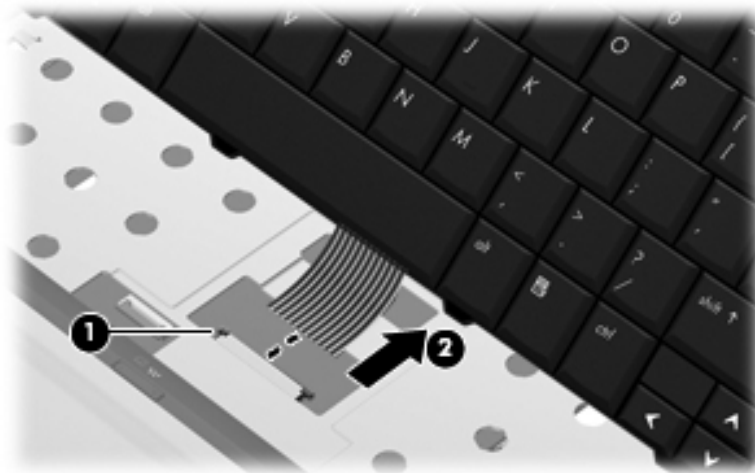

8. Remove the keyboard.
- Reverse this procedure to install the keyboard.

Keyboard cover

Description	Spare part number
Keyboard cover	496828-001
Silver keyboard cover	506848-001

Before removing the keyboard cover, follow these steps:

1. Shut down the computer. If you are unsure whether the computer is off or in Hibernation, turn the computer on, and then shut it down through the operating system.
2. Disconnect all external devices connected to the computer.
3. Disconnect the power from the computer by first unplugging the power cord from the AC outlet and then unplugging the AC adapter from the computer.
4. Remove the battery (see [“Battery” on page 4-7](#)).
5. Remove the keyboard (see [“Keyboard” on page 4-17](#)).

Remove the keyboard cover:

1. Remove the 2 Phillips PM2.5x9.0 screws **1** at the corners and the 2 Phillips PM2.0x4.0 screws **2** in the battery bay that secure the keyboard cover to the computer. The keyboard cover screws are identified by a triangle icon.

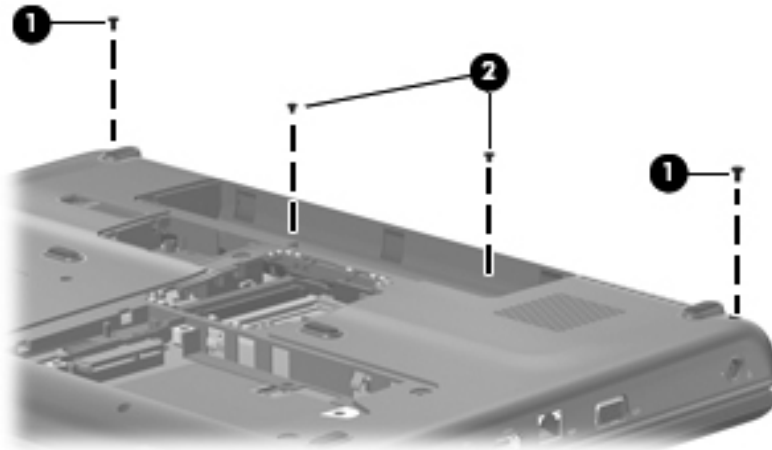

2. Turn the computer display-side up, with the front toward you.
3. Open the computer as far as possible.
4. Release the ZIF connector **1** to which the power button board cable is attached, and disconnect the power button board cable **2** from the system board.

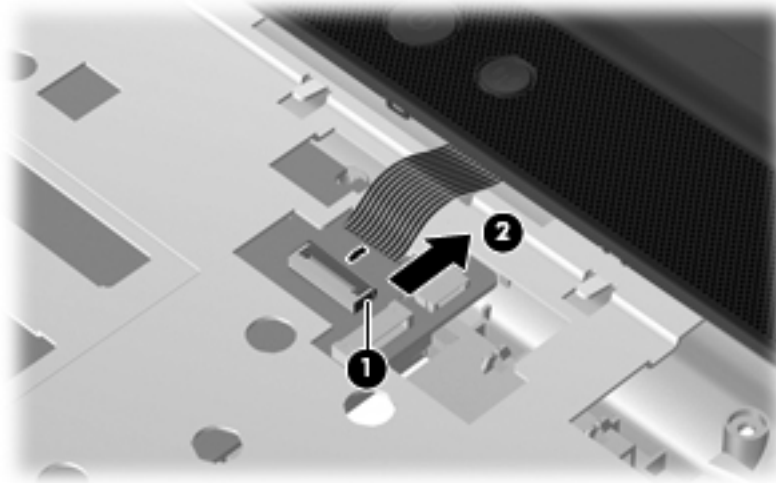

5. Slide the keyboard cover toward the display panel until it disengages from the top cover, and then lift up to remove the keyboard cover.

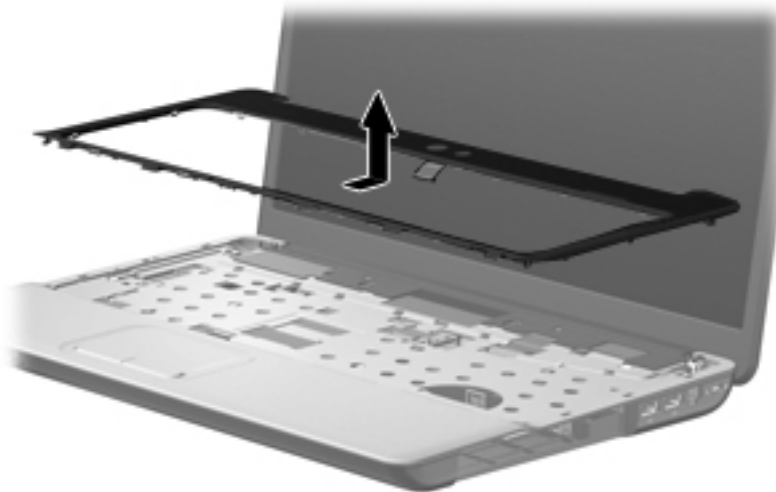

Reverse this procedure to install the keyboard cover.

Power button board

Description	Spare part number
Power button board	496830-001

Before removing the display assembly, follow these steps:

1. Shut down the computer. If you are unsure whether the computer is off or in Hibernation, turn the computer on, and then shut it down through the operating system.
2. Disconnect all external devices connected to the computer.
3. Disconnect the power from the computer by first unplugging the power cord from the AC outlet and then unplugging the AC adapter from the computer.
4. Remove the battery (see [“Battery” on page 4-7](#)).
5. Disconnect the wireless antenna cables from the WLAN module (see [“WLAN module” on page 4-15](#)).
6. Remove the keyboard (see [“Keyboard” on page 4-17](#)).
7. Remove the keyboard cover (see [“Keyboard cover” on page 4-20](#)).

Remove the power button board:

1. Remove the two Phillips PM2.0x4.0 screws ❶ that secure the power button board to the keyboard cover.
2. Remove the power button board ❷.

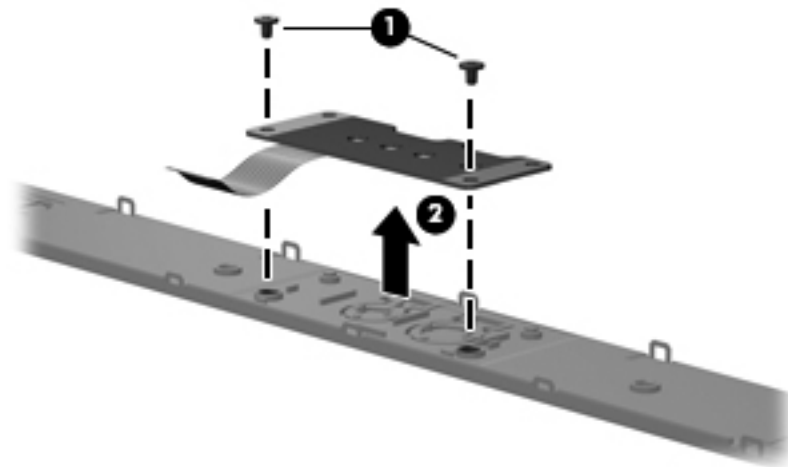

Reverse this procedure to install the power button board.

Display assembly

Description	Spare part number
16-inch WXGA BrightView display assembly for HP G60 computer models (includes microphone and cable and logo)	496761-001
16-inch WXGA BrightView display assembly for HP G60 computer models (includes webcam module and cable, 2 WLAN antenna transceivers and cables, microphone and cable, and logo)	496762-001
16-inch Silver WXGA BrightView display assembly for HP G60 computer models (includes microphone and cable and logo)	502949-001
16-inch Silver WXGA BrightView display assembly for HP G60 computer models (includes webcam module and cable, 2 WLAN antenna transceivers and cables, microphone and cable, and logo)	502950-001
15.6-inch WXGA BrightView display assembly for HP G60 computer models (includes microphone and cable, and logo)	496763-001
15.6-inch WXGA BrightView display assembly for HP G60 computer models (includes webcam module and cable, 2 WLAN antenna transceivers and cables, microphone and cable, and logo)	496764-001
15.6-inch Silver WXGA BrightView display assembly for HP G60 computer models (includes microphone and cable, and logo)	502951-001
15.6-inch Silver WXGA BrightView display assembly for HP G60 computer models (includes webcam module and cable, 2 WLAN antenna transceivers and cables, microphone and cable, and logo)	502952-001
16-inch WXGA BrightView display assembly for Presario CQ60 computer models (includes microphone and cable and logo)	496765-001
16-inch WXGA BrightView display assembly for Presario CQ60 computer models (includes webcam module and cable, 2 WLAN antenna transceivers and cables, microphone and cable, and logo)	496766-001
15.6-inch WXGA BrightView display assembly for Presario CQ60 computer models (includes microphone and cable, and logo)	496767-001
15.6-inch WXGA BrightView display assembly for Presario CQ60 computer models (includes webcam module and cable, 2 WLAN antenna transceivers and cables, microphone and cable, and logo)	496768-001

Before removing the display assembly, follow these steps:

1. Shut down the computer. If you are unsure whether the computer is off or in Hibernation, turn the computer on, and then shut it down through the operating system.
2. Disconnect all external devices connected to the computer.
3. Disconnect the power from the computer by first unplugging the power cord from the AC outlet and then unplugging the AC adapter from the computer.
4. Remove the battery (see [“Battery” on page 4-7](#)).
5. Disconnect the wireless antenna cables from the WLAN module (see [“WLAN module” on page 4-15](#)).
6. Remove the keyboard (see [“Keyboard” on page 4-17](#)).
7. Remove the keyboard cover (see [“Keyboard cover” on page 4-20](#)).

Remove the display assembly:

1. Pull the antenna cables through the opening in the top cover **1** and disengage the cables from the clip **2** in the routing channel leading to the display hinge.
2. Disconnect the display panel cable **3** from the system board and make sure that the cable is out of its routing channel.
3. Disconnect the microphone cable **4** from the system board and release it from the clips that attach it to the top cover.
4. Remove the caps lock LED **5** from its mounting clips on the top cover.

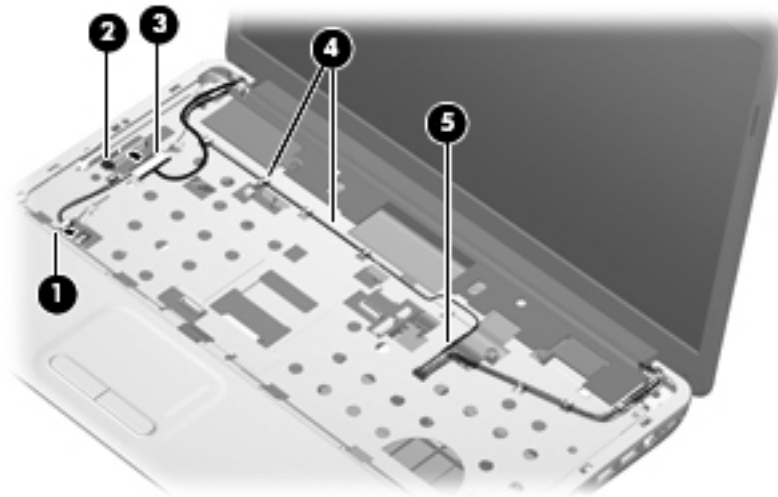



CAUTION: Support the display assembly when removing the following screws. Failure to support the display assembly can result in damage to the display assembly and other computer components.

5. Remove the four Phillips PM2.5x9.0 screws ❶ securing the display hinges to the computer.
6. Remove the display panel ❷.

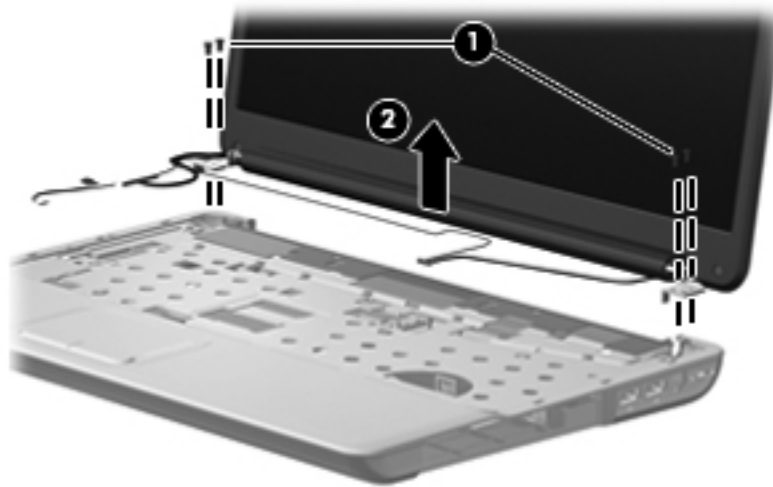

7. If it is necessary to replace the display bezel or any of the display assembly internal components, remove the following screw covers and screws:
 - ❶ Two rubber screw covers on the display bezel bottom edge. The display rubber screw covers are included in the Display Rubber Kit, spare part number 486584-001.
 - ❷ Two Phillips PM2.5x7.0 screws on the display bezel bottom edge.

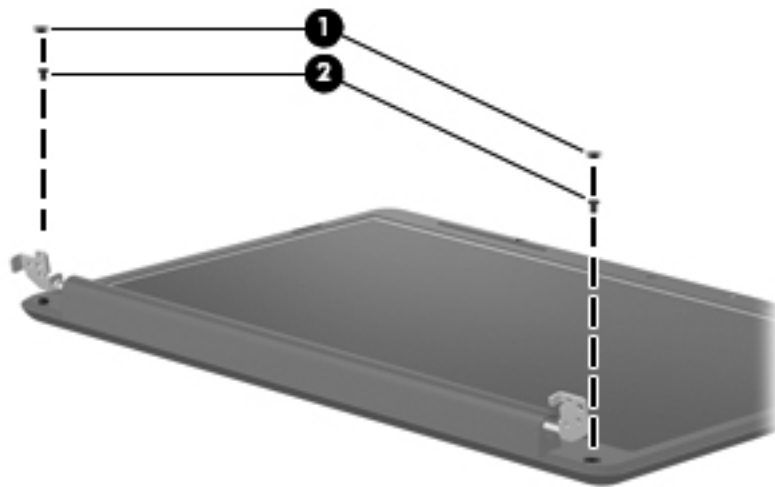

8. Flex the inside edges of the bezel at the top ❶, the left and right sides ❷, and the bottom ❸ until the bezel disengages from the display enclosure.
9. Remove the display bezel ❹.

The following display bezels are available:

- ❑ For use only with 16-inch HP G60 computer models equipped with a webcam module and microphone, spare part number 497098-001.
- ❑ For use only with 16-inch HP G60 computer models equipped with a microphone, spare part number 497097-001.
- ❑ For use only with silver 16-inch HP G60 computer models equipped with a webcam module and microphone, spare part number 502955-001.
- ❑ For use only with silver 16-inch HP G60 computer models equipped with a microphone, spare part number 502954-001.
- ❑ For use only with 15.6-inch HP G60 computer models equipped with a webcam module and microphone, spare part number 497102-001.
- ❑ For use only with 15.6-inch HP G60 computer models equipped with a microphone, spare part number 497101-001.
- ❑ For use only with silver 15.6-inch HP G60 computer models equipped with a webcam module and microphone, spare part number 502957-001.
- ❑ For use only with silver 15.6-inch HP G60 computer models equipped with a microphone, spare part number 502956-001.
- ❑ For use only with 16-inch Presario CQ60 computer models equipped with a webcam module and microphone, spare part number 497096-001.
- ❑ For use only with 16-inch Presario CQ60 computer models equipped with a microphone, spare part number 497095-001.
- ❑ For use only with 15.6-inch Presario CQ60 computer models equipped with a webcam module and microphone, spare part number 497100-001.
- ❑ For use only with 15.6-inch Presario CQ60 computer models equipped with a microphone, spare part number 497099-001.

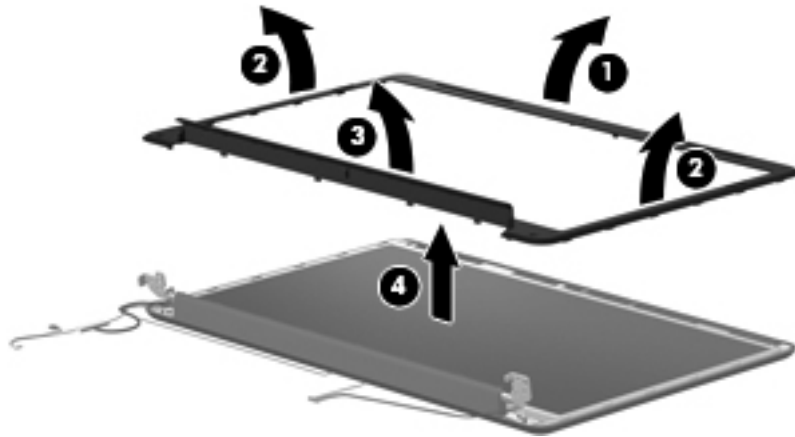

10. If it is necessary to replace the webcam module, release the webcam module ❶ as far from the display enclosure as the webcam module cable allows.
11. Disconnect the webcam module cable ❷ from the webcam module, and remove the webcam module. The webcam module is available using spare part number 488385-001.

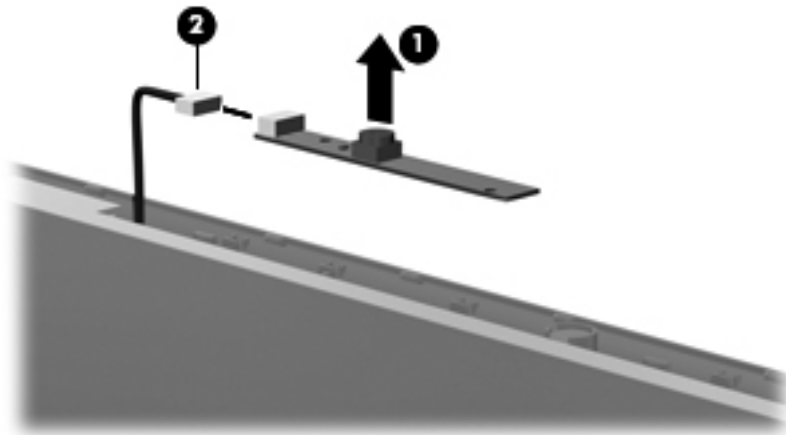

12. If it is necessary to replace the display inverter, release the display inverter ❶, located at the bottom edge of the display assembly, from its mounting clips.
13. Disconnect the display panel cable ❷ and the back light cable ❸ from the display inverter, and remove the display inverter from the display enclosure. The display inverter is available using spare part number 486556-001.

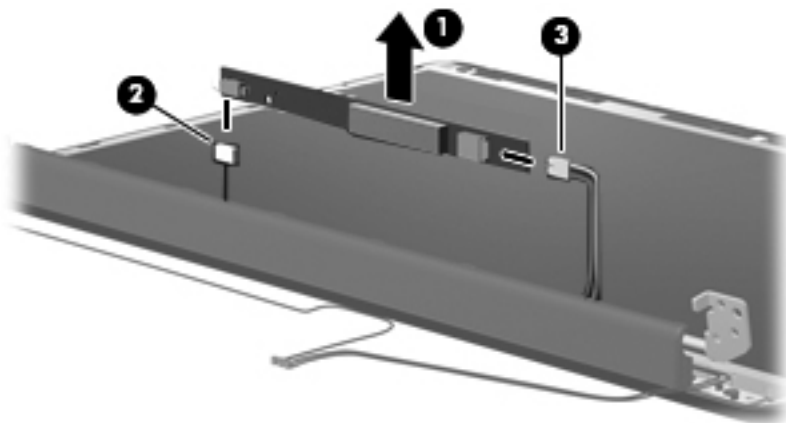

14. If it is necessary to replace the display hinges, remove the two Phillips PM2.5x6.0 screws ❶ that secure each hinge to the display enclosure.
15. Remove the display hinges ❷. The display hinges are available in the Display Hinge Kit, spare part number 486558-001.

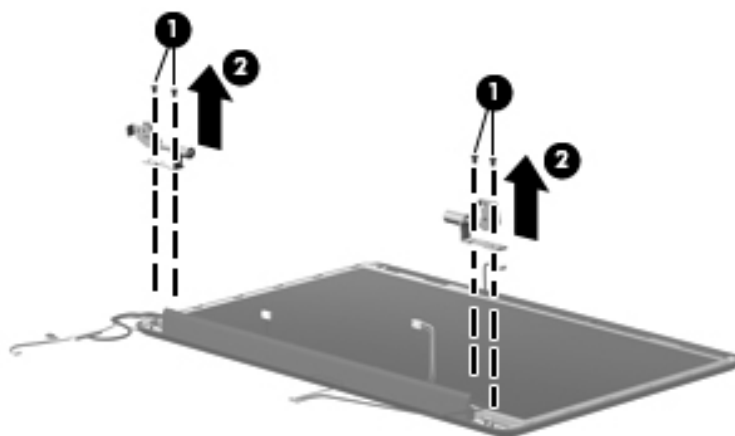

16. If it is necessary to replace the display panel, remove the two Phillips PM2.0x7.0 screws ❶ that secure the display panel to the display enclosure.
17. Remove the display panel ❷ from the display enclosure.

The following display panels are available:

- ❑ For use only with 16-inch WXGA BrightView equipped with microphone, spare part number 496769-001
- ❑ For use only with 15.6-inch WXGA BrightView equipped with a webcam module, spare part number 496770-001.

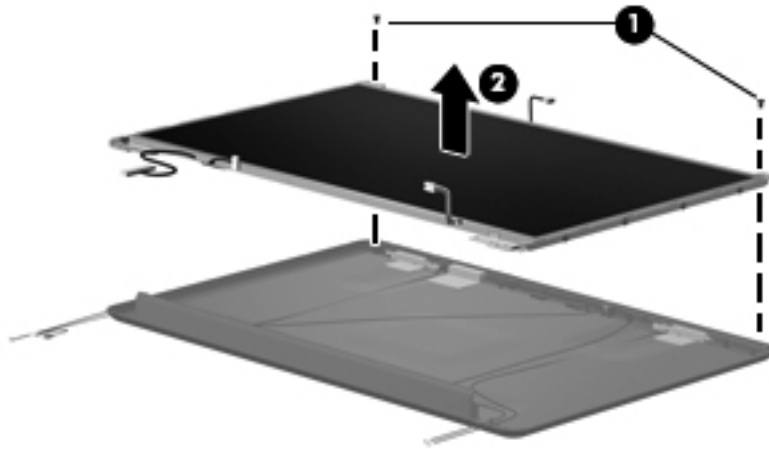

18. If it is necessary to replace the display panel brackets, remove the three Phillips PM2.0x3.0 screws ❶ that secure each bracket to the display panel.
19. Remove the display panel brackets ❷ from the display panel. The display panel brackets for the 16-inch vertical display bracket is available using spare part number 496843-001, and for the 15.6-inch display brackets available using spare part number 496844-001.

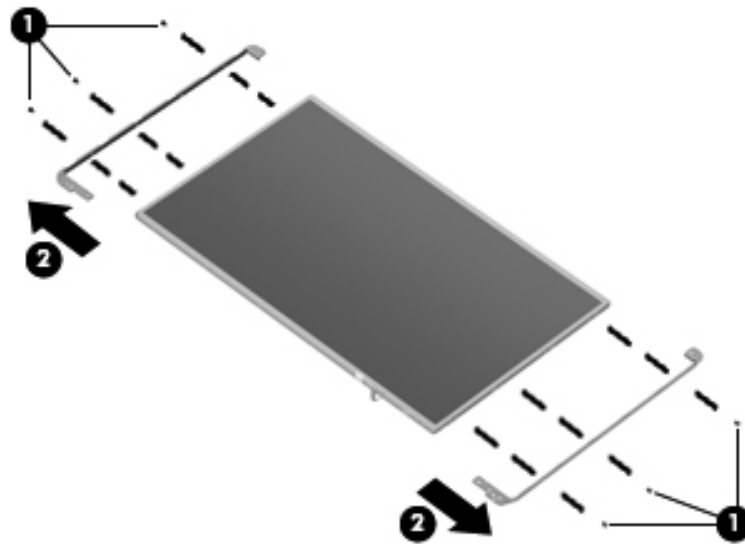

20. If it is necessary to replace the display panel cable, which is attached to the back of the display panel with clear adhesive tape, remove the tape ❶ to release the cable from its connector. The display panel cable includes the camera module cable. The display panel cable with webcam cable is available using spare part number 496841-001.
21. Remove display panel cable ❷.

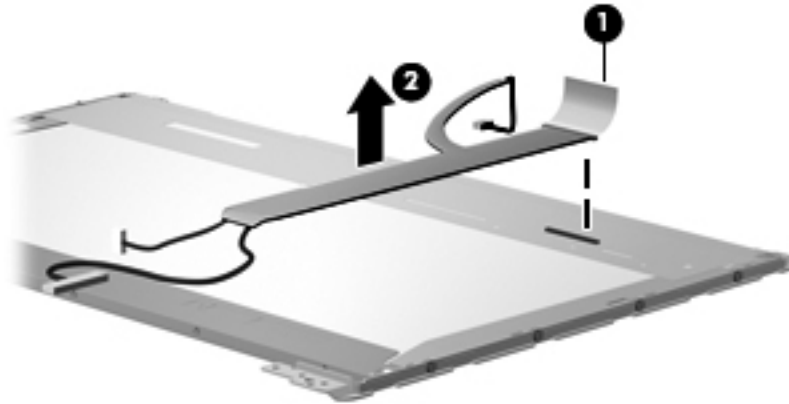

22. If it is necessary to replace the microphone ❶, release the microphone from its mounting clip ❷ at the top of the display enclosure.
23. Pull the microphone cable through the left hinge opening, and release the microphone cable from the foil tab ❸. The microphone with cable is available using spare part number 496840-001.

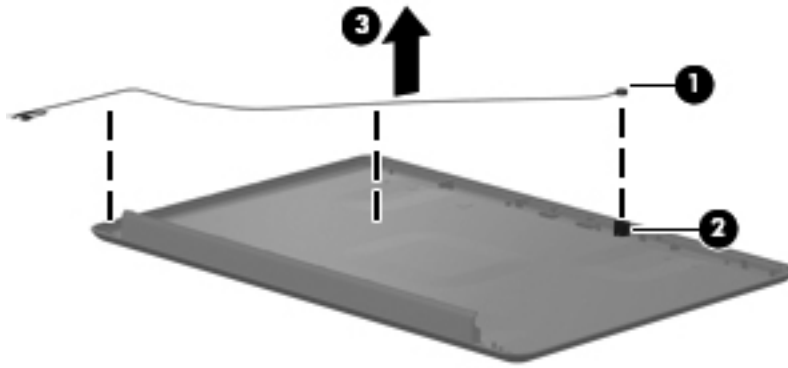

Reverse this procedure to reassemble and install the display assembly.

Top cover

Description	Spare part number
Top cover (includes TouchPad)	506849-001

Before removing the top cover, follow these steps:

1. Shut down the computer. If you are unsure whether the computer is off or in Hibernation, turn the computer on, and then shut it down through the operating system.
2. Disconnect all external devices connected to the computer.
3. Disconnect the power from the computer by first unplugging the power cord from the AC outlet and then unplugging the AC adapter from the computer.
4. Remove the battery (see [“Battery” on page 4-7](#)).
5. Remove the following components:
 - a. Optical drive (see [“Optical drive” on page 4-8](#))
 - b. Hard drive (see [“Hard drive” on page 4-10](#))
 - c. Keyboard (see [“Keyboard” on page 4-17](#))
 - d. Keyboard cover (see [“Keyboard cover” on page 4-20](#))
 - e. Power button board (see [“Power button board” on page 4-22](#))
 - f. Display assembly (see [“Display assembly” on page 4-23](#))

Remove the top cover:

1. Turn the computer upside down, with the front toward you.
2. Remove the four Phillips PM2.5X9.0 screws ❶ that secure the top cover to the computer.
3. Remove the three Phillips PM2.0x4.0 screws ❷.

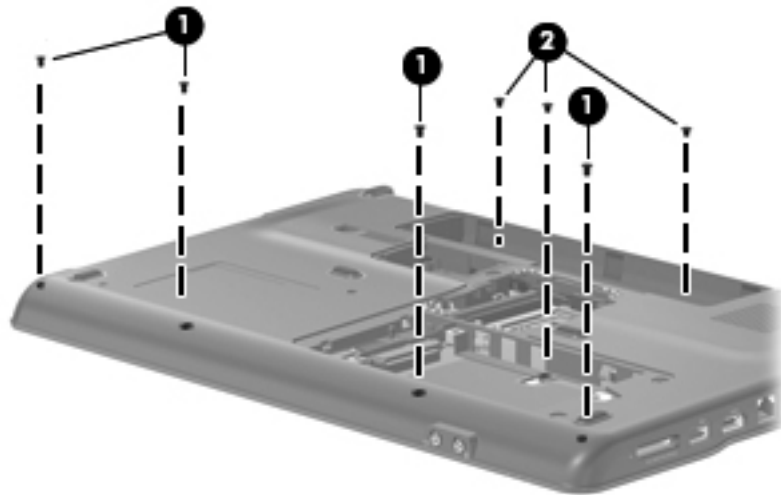

4. Turn the computer right-side up, with the front facing you.
5. Release the ZIF connector to which the TouchPad cable is attached, and disconnect the TouchPad cable from the system board.

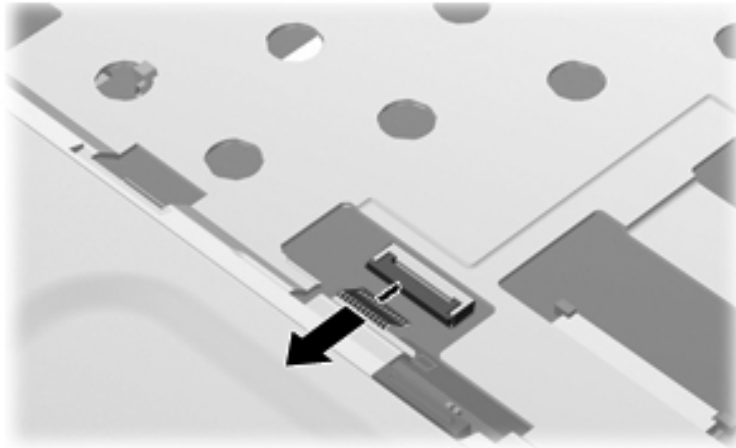

6. Remove the following screws:
 - a. Four Phillips PM2.0x6.0 screws ❶
 - b. One Phillips PM2.0x4.0 screw ❷

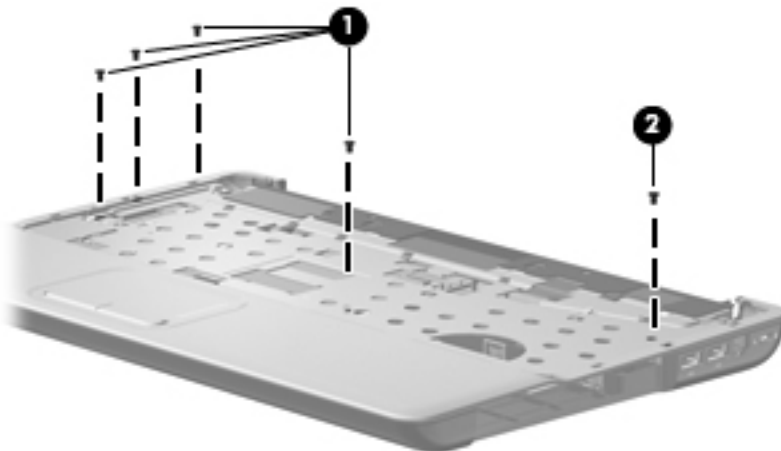

7. Lift the rear edge of the top cover ❶ until the top cover disengages from the base enclosure.
8. Remove the top cover ❷.

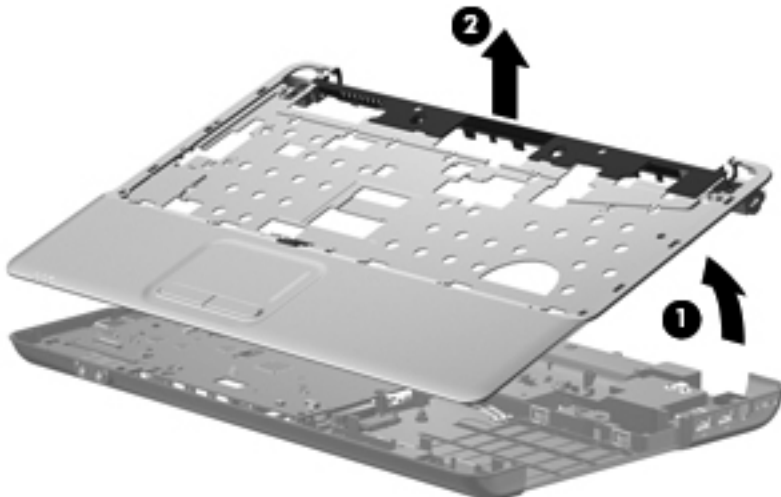

Reverse this procedure to install the top cover.

TouchPad on/off button board and board bracket

Description	Spare Parts Number
TouchPad board bracket	489119-001
TouchPad on/off button board (includes cables)	496832-001

Before removing the TouchPad on/off button board, follow these steps:

1. Shut down the computer. If you are unsure whether the computer is off or in Hibernation, turn the computer on, and then shut it down through the operating system.
2. Disconnect all external devices connected to the computer.
3. Disconnect the power from the computer by first unplugging the power cord from the AC outlet and then unplugging the AC adapter from the computer.
4. Remove the battery (see [“Battery”](#) on page 4-7).
5. Remove the following components:
 - a. Optical drive (see [“Optical drive”](#) on page 4-8)
 - b. Hard drive (see [“Hard drive”](#) on page 4-10)
 - c. Keyboard (see [“Keyboard”](#) on page 4-17)
 - d. Keyboard cover (see [“Keyboard cover”](#) on page 4-20)
 - e. Power button board (see [“Power button board”](#) on page 4-22)
 - f. Display assembly (see [“Display assembly”](#) on page 4-23)

Remove the TouchPad on/off button board and board bracket:

1. Turn the top cover upside down, with the front toward you.
2. Release the ZIF connector on the TouchPad on/off button board to which the TouchPad on/off board cable is attached, and then disconnect the TouchPad on/off board cable ❶ from the TouchPad button board.
3. Release the ZIF connector on the TouchPad button board to which the TouchPad on/off board cable is attached, and disconnect the TouchPad on/off board cable ❷ from the TouchPad board.
4. Remove the two Phillips PM2.0x4.0 screws ❸ securing the TouchPad on/off button board.
5. Single-sided and double-sided tape is used to help secure the TouchPad on/off button board to the TouchPad board bracket. Release the TouchPad on/off button board from the tape, and then remove the TouchPad on/off button board ❹.

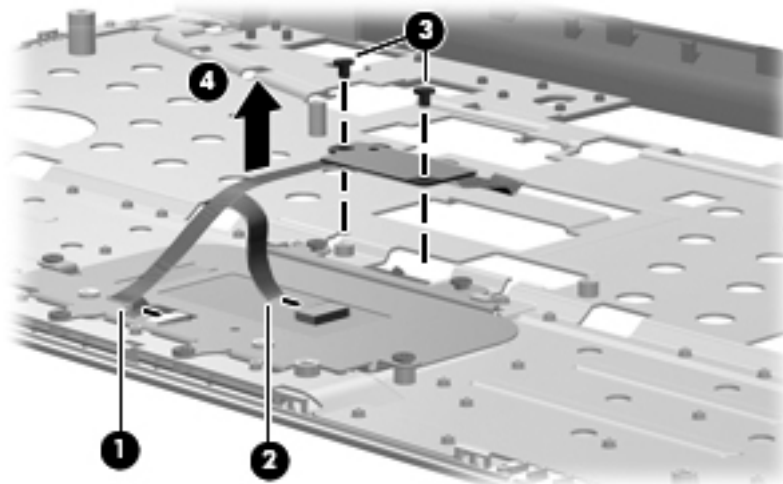

6. Remove the four Phillips PM2.0x4.0 screws ❶ that secure the TouchPad board to the base enclosure. Then remove the TouchPad board and bracket ❷.

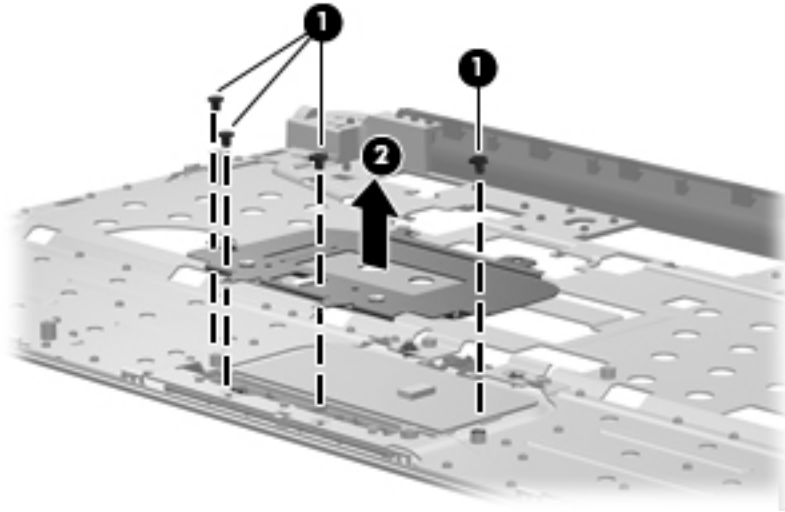

7. Remove the two Phillips PM2.0x4.0 screws ❶ that secure the switch actuator to the TouchPad board bracket, and then remove the actuator ❷.

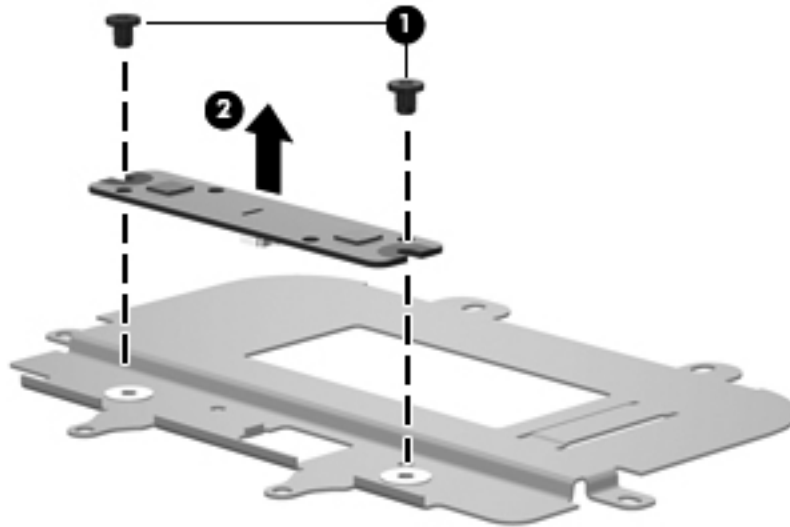

The TouchPad is glued to the top cover and is included with the top cover spare part.

Reverse this procedure to install the TouchPad on/off button board and board bracket.

Audio board

Description	Spare Part Number
Audio board (includes audio board cable)	486634-001

Before removing the audio board, follow these steps:

1. Shut down the computer. If you are unsure whether the computer is off or in Hibernation, turn the computer on, and then shut it down through the operating system.
2. Disconnect all external devices connected to the computer.
3. Disconnect the power from the computer by first unplugging the power cord from the AC outlet and then unplugging the AC adapter from the computer.
4. Remove the battery (see [“Battery” on page 4-7](#)).
5. Remove the following components:
 - a. Optical drive (see [“Optical drive” on page 4-8](#))
 - b. Hard drive (see [“Hard drive” on page 4-10](#))
 - c. Keyboard (see [“Keyboard” on page 4-17](#))
 - d. Keyboard cover (see [“Keyboard cover” on page 4-20](#))
 - e. Power button board (see [“Power button board” on page 4-22](#))
 - f. Display assembly (see [“Display assembly” on page 4-23](#))

Remove the audio board:

1. Release the ZIF connector **1** to which the audio board cable is attached, and disconnect the audio board cable **2** from the system board.
2. Remove the two Phillips PM2.0×4.0 screws **3** that secure the audio board to the base enclosure.
3. Remove the audio board **4**.

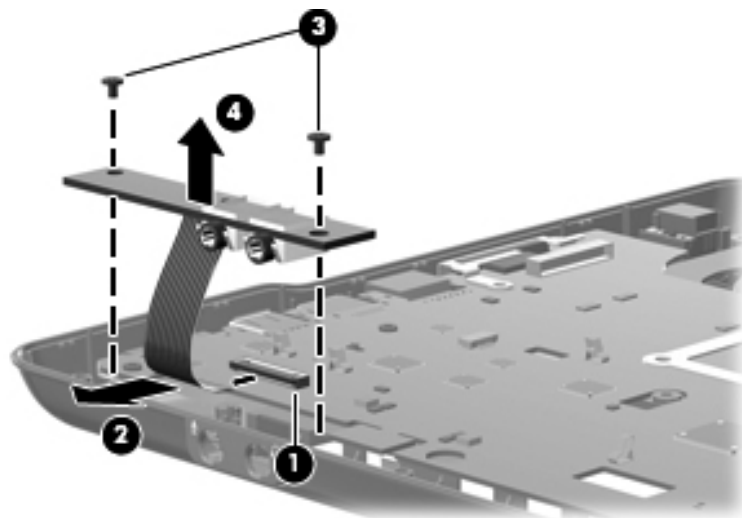

Reverse this procedure to install the audio board.

Bluetooth module

Description	Spare Part Number
Bluetooth module	483113-001
Bluetooth cable	496836-001

Before removing the Bluetooth module, follow these steps:

1. Shut down the computer. If you are unsure whether the computer is off or in Hibernation, turn the computer on, and then shut it down through the operating system.
2. Disconnect all external devices connected to the computer.
3. Disconnect the power from the computer by first unplugging the power cord from the AC outlet and then unplugging the AC adapter from the computer.
4. Remove the battery (see [“Battery” on page 4-7](#)).
5. Remove the following components:
 - a. Optical drive (see [“Optical drive” on page 4-8](#))
 - b. Hard drive (see [“Hard drive” on page 4-10](#))
 - c. Keyboard (see [“Keyboard” on page 4-17](#))
 - d. Keyboard cover (see [“Keyboard cover” on page 4-20](#))
 - e. Power button board (see [“Power button board” on page 4-22](#))
 - f. Display assembly (see [“Display assembly” on page 4-23](#))

Remove the Bluetooth module:

1. Disconnect the Bluetooth module cable ❶ from the system board. The Bluetooth cable is available using spare part number 496836-001.
2. Remove the two Phillips PM2.0×4.0 screws ❷ that secure the Bluetooth module to the base enclosure.
3. Remove the Bluetooth module ❸.

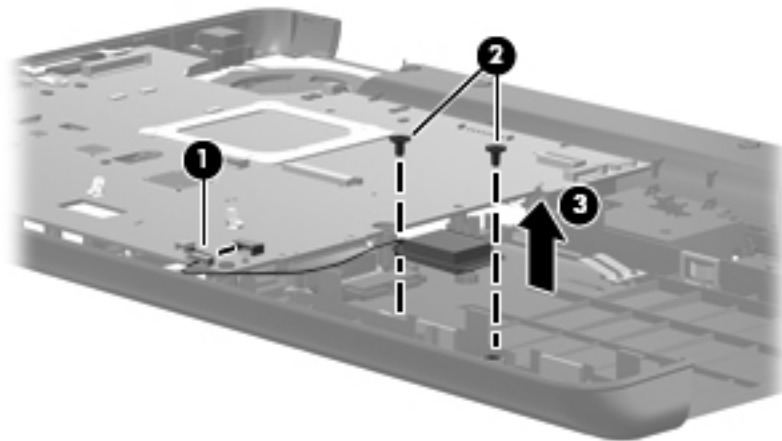

Reverse this procedure to install the Bluetooth module.

Speakers

Description	Spare Part Number
Speakers	496829-001

Before removing the speakers, follow these steps:

1. Shut down the computer. If you are unsure whether the computer is off or in Hibernation, turn the computer on, and then shut it down through the operating system.
2. Disconnect all external devices connected to the computer.
3. Disconnect the power from the computer by first unplugging the power cord from the AC outlet and then unplugging the AC adapter from the computer.
4. Remove the battery (see [“Battery” on page 4-7](#)).
5. Remove the following components:
 - a. Optical drive (see [“Optical drive” on page 4-8](#))
 - b. Hard drive (see [“Hard drive” on page 4-10](#))
 - c. Keyboard (see [“Keyboard” on page 4-17](#))
 - d. Keyboard cover (see [“Keyboard cover” on page 4-20](#))
 - e. Power button board (see [“Power button board” on page 4-22](#))
 - f. Display assembly (see [“Display assembly” on page 4-23](#))

Remove the speakers:

1. Disconnect the speaker cable from the system board ❶.
2. Disconnect the LED cable from the right speaker ❷.
3. Remove one screw from each speaker. A Phillips PM2.0x6.0 screw is on the left ❸, and a Phillips PM2.0x4.0 screw is on the right ❹.
4. Remove the speakers ❺.

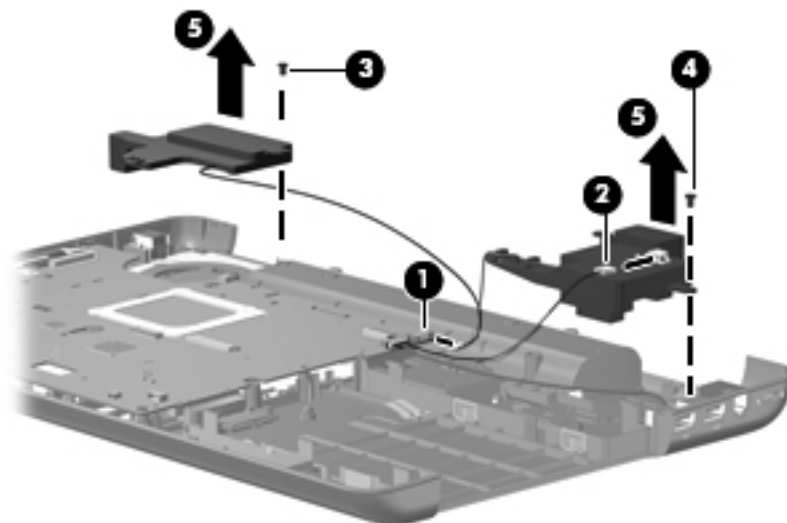

Reverse this procedure to install the speakers.

USB board

Description	Spare part number
USB board	486633-001
USB board cable (includes num lock LED)	496837-001

Before removing the USB board, follow these steps:

1. Shut down the computer. If you are unsure whether the computer is off or in Hibernation, turn the computer on, and then shut it down through the operating system.
2. Disconnect all external devices connected to the computer.
3. Disconnect the power from the computer by first unplugging the power cord from the AC outlet and then unplugging the AC adapter from the computer.
4. Remove the battery (see [“Battery” on page 4-7](#)).
5. Remove the following components:
 - a. Optical drive (see [“Optical drive” on page 4-8](#))
 - b. Hard drive (see [“Hard drive” on page 4-10](#))
 - c. Keyboard (see [“Keyboard” on page 4-17](#))
 - d. Keyboard cover (see [“Keyboard cover” on page 4-20](#))
 - e. Power button board (see [“Power button board” on page 4-22](#))
 - f. Display assembly (see [“Display assembly” on page 4-23](#))

Remove the USB board:

1. Disconnect the USB board cable ❶ from the system board.
2. Disconnect the num lock LED cable ❷ from the system board.
3. Lift the USB board ❸ straight up to remove it from the computer.

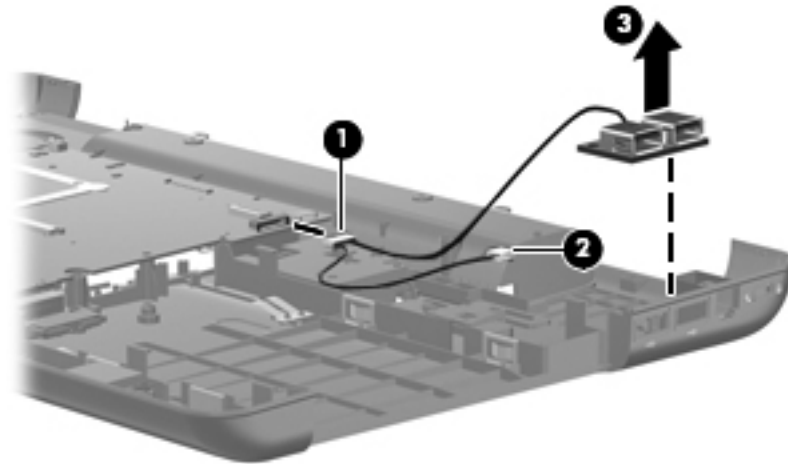

Reverse this procedure to install a USB board.

System board



The system board spare part kit includes UMA or discrete graphics subsystem memory, built-in modem, and replacement thermal material.

Description	Spare part number
UMA system board, GM45 (includes built-in modem, Digital Media Slot, HDMI port, and replacement thermal material)	485218-001
UMA system board, GM45 (includes built-in modem, Digital Media Slot, and replacement thermal material)	494281-001
UMA system board, GL40 (includes built-in modem, Digital Media Slot, and replacement thermal material)	494282-001
UMA system board, GL40 (includes built-in modem, Digital Media Slot, HDMI port, and replacement thermal material)	485219-001
UMA system board, GL40 (for Presario CQ60 only; includes built-in modem, and replacement thermal material)	501266-001
Discrete system board, PM45 (includes built-in modem, Digital Media Slot, HDMI port, and replacement thermal material)	488338-001
Discrete system board, PM45 (includes built-in modem, Digital Media Slot, and replacement thermal material)	494283-001
UMA system board, NVIDIA (includes built-in modem, Digital Media Slot, HDMI port, and replacement thermal material)	498460-001
UMA system board, NVIDIA (for Presario only; includes built-in modem, Digital Media Slot, and replacement thermal material)	498462-001
UMA system board, NVIDIA (for Presario only; includes built-in modem, Digital Media Slot, and replacement thermal material)	498463-001
UMA system board, NVIDIA (for Presario only; includes built-in modem, and replacement thermal material)	498464-001
Optical extension board (not illustrated)	506951-001

Before removing the system board, follow these steps:

1. Shut down the computer. If you are unsure whether the computer is off or in Hibernation, turn the computer on, and then shut it down through the operating system.
2. Disconnect all external devices connected to the computer.
3. Disconnect the power from the computer by first unplugging the power cord from the AC outlet and then unplugging the AC adapter from the computer.
4. Remove the battery (see [“Battery” on page 4-7](#)).
5. Remove the following components:
 - a. Optical drive (see [“Optical drive” on page 4-8](#))
 - b. Hard drive (see [“Hard drive” on page 4-10](#))
 - c. Keyboard (see [“Keyboard” on page 4-17](#))
 - d. Keyboard cover (see [“Keyboard cover” on page 4-20](#))
 - e. Power button board (see [“Power button board” on page 4-22](#))
 - f. Display assembly (see [“Display assembly” on page 4-23](#))

When replacing the system board, be sure that the following components are removed from the defective system board and installed on the replacement system board:

- RTC battery (see “RTC battery” on page 4-12)
- Memory module (see “Memory module” on page 4-13)
- WLAN module (see “WLAN module” on page 4-15)
- Fan/heat sink assembly (see “Fan/heat sink assembly” on page 4-41)
- Processor (see “Processor” on page 4-44)

Remove the system board:

1. Disconnect the USB board cable ❶ from its mounting clip in the base enclosure.
2. Disconnect the Bluetooth cable ❷ from the system board.
3. Disconnect the RJ-11 cable ❸ from the system board.
4. Disconnect the audio cable ❹ from the system board.

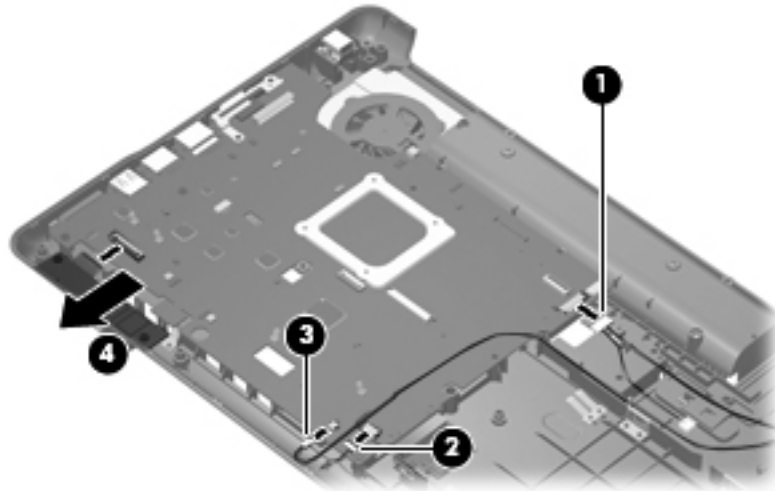

CAUTION: Do not attempt to disconnect the optical extension board before removing the system board. Otherwise, you will damage the locator pin on the optical extension board.

5. Remove the four Phillips PM2.5x6.0 screws ❶ that secure the system board
6. Remove the two Phillips PM2.5x5.0 screws ❷ that secure the optical extension board.

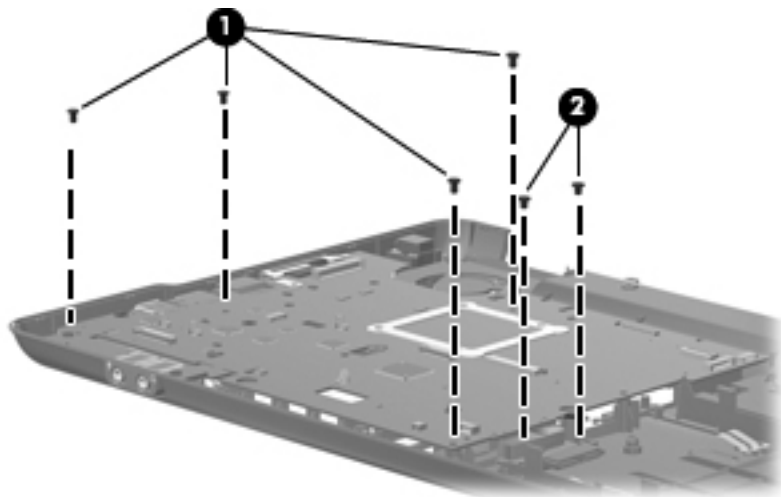

7. Release the power cable from the base enclosure ❶.
8. Use the optical drive connector ❷ to lift the right edge of the system board ❸ until it rests at an angle.
9. Remove the system board ❹ from the base enclosure by sliding it up and to the right at an angle.

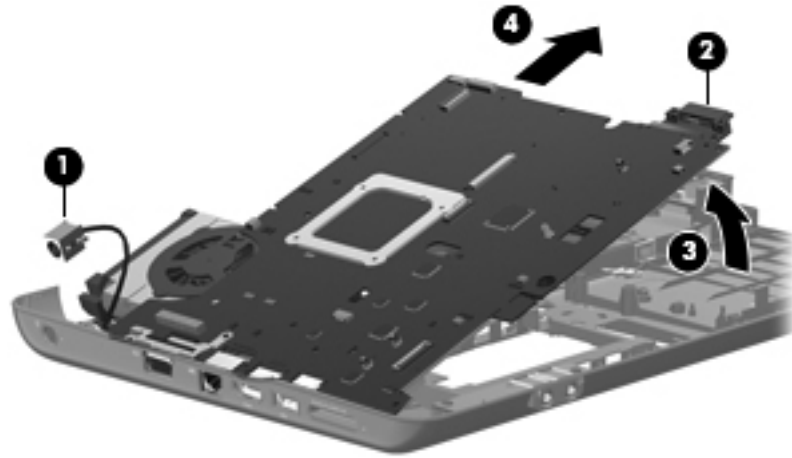

10. Remove the optical extension board from the system board.

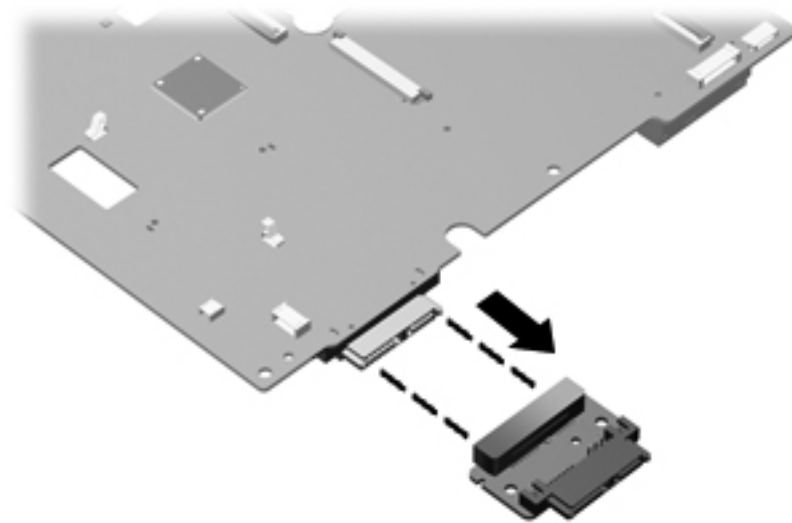

Reverse this procedure to install the system board.

Fan/heat sink assembly

Description	Spare part number
Fan/heat sink assembly (includes replacement thermal material) for use only with computer models with UMA graphics subsystem memory	489126-001
Fan/heat sink assembly (includes replacement thermal material) for use only with computer models with discrete graphics subsystem memory	489154-001

Before removing the fan, follow these steps:

1. Shut down the computer. If you are unsure whether the computer is off or in Hibernation, turn the computer on, and then shut it down through the operating system.
2. Disconnect all external devices connected to the computer.
3. Disconnect the power from the computer by first unplugging the power cord from the AC outlet and then unplugging the AC adapter from the computer.
4. Remove the battery (see [“Battery” on page 4-7](#)).
5. Remove the following components:
 - a. Optical drive (see [“Optical drive” on page 4-8](#))
 - b. Hard drive (see [“Hard drive” on page 4-10](#))
 - c. Keyboard (see [“Keyboard” on page 4-17](#))
 - d. Keyboard cover (see [“Keyboard cover” on page 4-20](#))
 - e. Power button board (see [“Power button board” on page 4-22](#))
 - f. Display assembly (see [“Display assembly” on page 4-23](#))
 - g. Top cover (see [“Top cover” on page 4-30](#))
 - h. Bluetooth module (see [“Bluetooth module” on page 4-35](#))
 - i. System board (see [“System board” on page 4-38](#))

Remove the fan/heat sink assembly:

1. Turn the system board right-side up, with the front toward you.
2. Disconnect the fan cable from the system board.

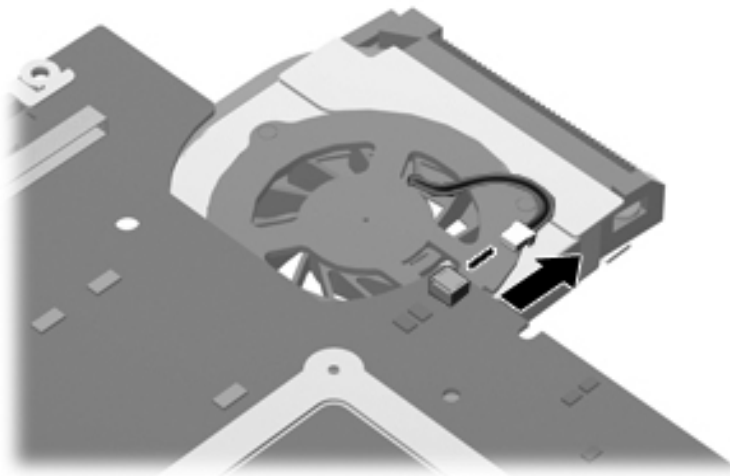

To properly ventilate the computer, allow at least a 7.6-cm (3-inch) clearance on the left side of the computer.

 Due to the adhesive quality of the thermal material located between the fan/heat sink assembly and system board components, you may need to move the fan/heat sink assembly from side to side to detach the assembly.

3. Turn the system board upside down with the fan assembly toward you.

 **WARNING:** To avoid damage to the processor, loosen the fan/heat sink screws in the 1-2-3-4 sequence indicated. Likewise, tighten the screws in the same sequence when installing the fan/heat sink assembly.

 Steps 4 through 5 apply only to computer models equipped with graphics subsystems with UMA memory.

4. Following the 1, 2, 3, 4 sequence stamped into the heat sink, loosen the four Phillips PM2.0x10.0 spring-loaded captive screws ❶ that secure the fan/heat sink assembly.

5. Remove the fan/heat sink assembly ❷ by lifting it straight up.

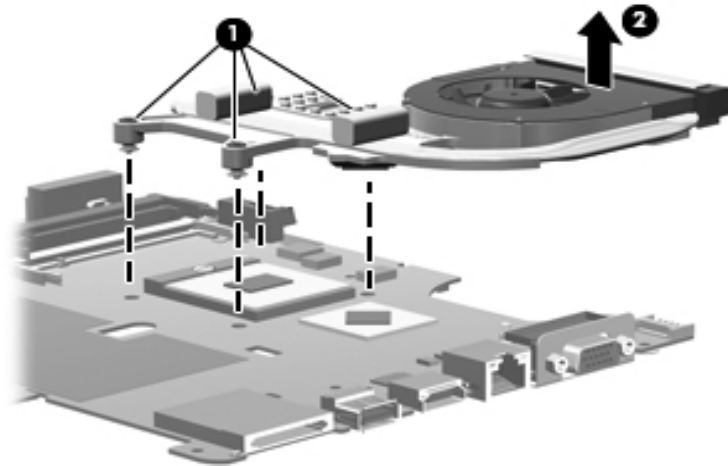

 Steps 6 through 7 apply only to computer models equipped with graphics subsystems with discrete memory.

6. Loosen the 4 Phillips PM2.0x11.0 spring-loaded captive screws ❶ that secure the fan/heatsink assembly.

7. Remove the fan/heat sink assembly ❷ by lifting it straight up.

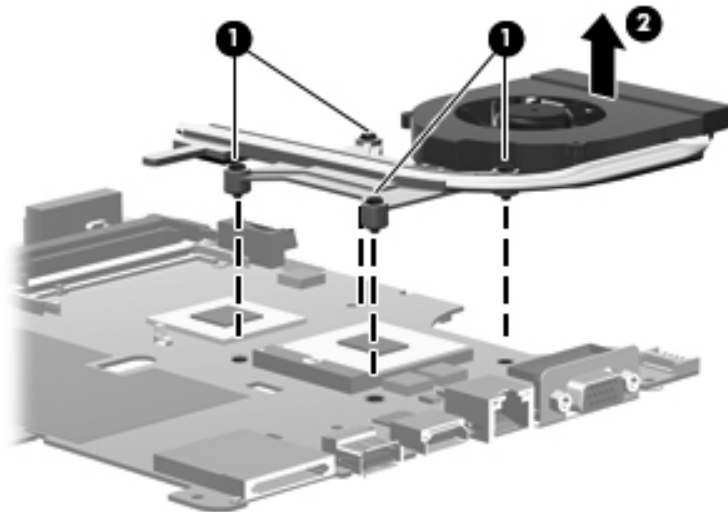



The thermal material must be thoroughly cleaned from the surfaces of the fan/heat sink and the system board components each time the fan/heat sink is removed. Thermal grease is located on the section of the fan/heat sink ❶ that services the processor ❷. Thermal pads are located on the section of the fan/heat sink ❸ that services the Northbridge chip ❹. Replacement thermal grease and pads are included with all system board, fan/heat sink assembly, and processor spare part kits.

The following illustration shows the replacement thermal material locations for computer models equipped with graphics subsystems with UMA memory.

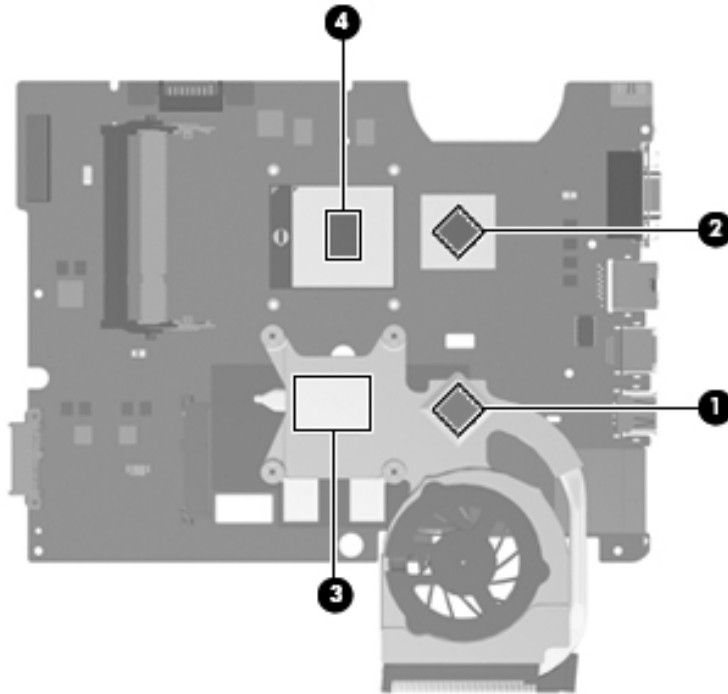

The following illustration shows the replacement thermal material locations for computer models equipped with graphics subsystems with discrete memory.

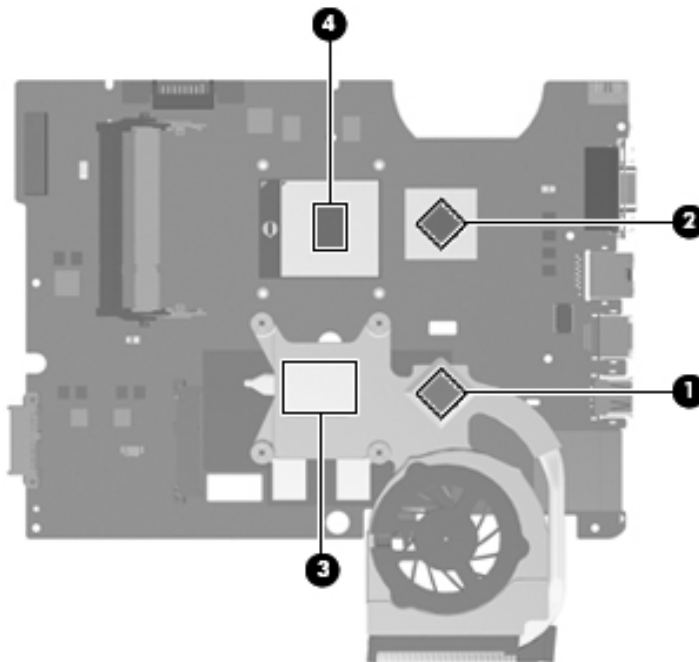

Reverse this procedure to install the fan/heat sink assembly.

Processor



The processor spare part kit includes replacement thermal material.

Description	Spare part number
Intel Core2 Duo (3-MB L2 cache) P8400, 2.26-GHz processor	490111-001
Intel Core2 Duo (3-MB L2 cache) P8600, 2.4-GHz processor	490112-001
Intel Core2 Duo (3-MB L2 cache) P7350, 2.0-GHz processor	501520-001
Intel Core2 Duo (6-MB L2 cache) T9400, 2.53-GHz processor	490113-001
Intel Pentium (1-MB L2 cache) T3200, 2.0-GHz processor	490115-001
Intel Pentium (1-MB L2 cache) T3400, 2.16-GHz processor	501523-001
Intel Pentium (2-MB L2 cache) T5800, 2.0-GHz processor	501521-001
Intel Pentium (2-MB L2 cache) T5900, 2.2-GHz processor	501522-001
Intel Celeron-M (1-MB L2 cache) 575, 2.0-GHz processor	490116-001
Intel Celeron-M (1-MB L2 cache) 585, 2.16-GHz processor	490117-001
Intel Celeron (1-MB L2 cache) T1600, 1.66-GHz processor	501524-001
Intel Celeron (1-MB L2 cache) T1700, 1.86-GHz processor	501525-001
AMD Turion Ultra Dual-Core (2-MB L2 cache) ZM-80 2.1-GHz processor	498465-001
AMD Turion Ultra Dual-Core (2-MB L2 cache) ZM-82 2.2-GHz processor	498466-001
AMD Turion Dual-Core (1-MB L2 cache) RM-70 2.0-GHz processor	498467-001
AMD Turion Dual-Core (1-MB L2 cache) RM-72 2.1-GHz processor	498468-001
AMD Athlon X2 dual-Core (1-MB L2 cache) QL_60 1.9-GHz processor	498469-001
AMD Athlon X2 dual-Core (1-MB L2 cache) QL-62 2.0-GHz processor	498470-001
AMD Sempron Single Core (512-KB L2 cache) SI-42 2.1-GHz processor	498471-001
AMD Sempron Single Core (512-KB L2 cache) SI-40 2.0-GHz processor	498472-001

Before removing the processor, follow these steps:

1. Shut down the computer. If you are unsure whether the computer is off or in Hibernation, turn the computer on, and then shut it down through the operating system.
2. Disconnect all external devices connected to the computer.
3. Disconnect the power from the computer by first unplugging the power cord from the AC outlet and then unplugging the AC adapter from the computer.
4. Remove the following components:
 - a. Remove the battery (see [“Battery” on page 4-7](#)).
 - b. Optical drive (see [“Optical drive” on page 4-8](#))
 - c. Hard drive (see [“Hard drive” on page 4-10](#))
 - d. Keyboard (see [“Keyboard” on page 4-17](#))
 - e. Keyboard cover (see [“Keyboard cover” on page 4-20](#))
 - f. Power button board (see [“Power button board” on page 4-22](#))

- g. Display assembly (see “Display assembly” on page 4-23)
- h. Top cover (see “Top cover” on page 4-30)
- i. Bluetooth module (see “Bluetooth module” on page 4-35)
- j. System board (see “System board” on page 4-38)
- k. Fan/heat sink assembly (see “Fan/heat sink assembly” on page 4-41)

Remove the processor:

1. Use a flat-bladed screwdriver to turn the processor locking screw ❶ one-half turn counterclockwise until you hear a click.
2. Lift the processor ❷ straight up and remove it.



When you install the processor, the gold triangle on the processor ❸ must be aligned with the triangle embossed on the processor slot ❹.

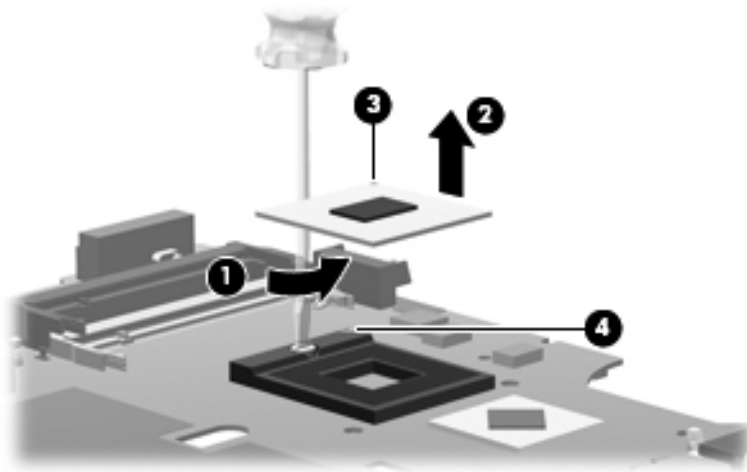

Reverse this procedure to install the processor.

Power connector cable

Description	Spare Part Number
Power connector cable	496835-001

Before removing the power connector cable, follow these steps:

1. Shut down the computer. If you are unsure whether the computer is off or in Hibernation, turn the computer on, and then shut it down through the operating system.
2. Disconnect all external devices connected to the computer.
3. Disconnect the power from the computer by first unplugging the power cord from the AC outlet and then unplugging the AC adapter from the computer.
4. Remove the following components:
 - a. Remove the battery (see [“Battery” on page 4-7](#)).
 - b. Optical drive (see [“Optical drive” on page 4-8](#)).
 - c. Hard drive (see [“Hard drive” on page 4-10](#)).
 - d. Keyboard (see [“Keyboard” on page 4-17](#)).
 - e. Keyboard cover (see [“Keyboard cover” on page 4-20](#)).
 - f. Power button board (see [“Power button board” on page 4-22](#)).
 - g. Display assembly (see [“Display assembly” on page 4-23](#)).
 - h. Top cover (see [“Top cover” on page 4-30](#)).
 - i. Bluetooth module (see [“Bluetooth module” on page 4-35](#)).
 - j. System board (see [“System board” on page 4-38](#)).



The power cable connector was released from its mounting clip in the base assembly during system board removal.

To remove the power connector cable, disconnect the cable connector from the system board.

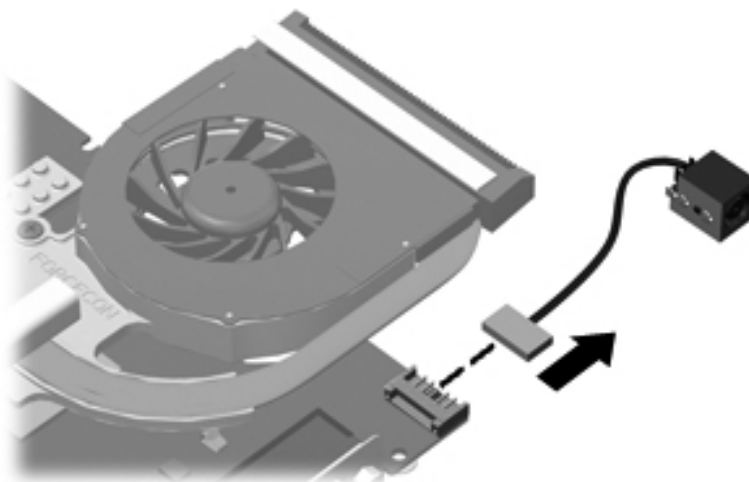

Reverse this procedure to install the power connector cable.

Setup Utility

The Setup Utility is a ROM-based information and customization utility that can be used even when your Windows operating system is not working.

The utility reports information about the computer and provides settings for startup, security, and other preferences.

Starting the Setup Utility

To start the Setup Utility:

- » Open the Setup Utility by turning on or restarting the computer. While the “Press the ESC key for Startup Menu” message is displayed in the lower-left corner of the screen, press **f10**.
- or –
- 1. Open the Setup Utility by turning on or restarting the computer. While the “Press the ESC key for Startup Menu” message is displayed in the lower-left corner of the screen, press **esc**.
- 2. When the Startup Menu is displayed, press **f10**.

Changing the language of the Setup Utility

The following procedure explains how to change the language of the Setup Utility. If the Setup Utility is not already running, begin at step 1. If the Setup Utility is already running, begin at step 2.

1. Open the Setup Utility by turning on or restarting the computer. While the “Press the ESC key for Startup Menu” message is displayed in the lower-left corner of the screen, press **f10**.

– or –

Open the Setup Utility by turning on or restarting the computer. While the “Press the ESC key for Startup Menu” message is displayed in the lower-left corner of the screen, press **esc**. When the Startup Menu is displayed, press **f10**.

2. Use the arrow keys to select **System Configuration > Language**, and then press **enter**.
3. Use the arrow keys to select a language, and then press **enter**.
4. When a confirmation prompt with your language selected is displayed, press **enter**.
5. To save your change and exit the Setup Utility, use the arrow keys to select **Exit > Exit Saving Changes**, and then press **enter**.

Your change goes into effect immediately.

Navigating and selecting in the Setup Utility

Because the Setup Utility is not Windows based, it does not support the TouchPad. Navigation and selection are by keystroke.

- To choose a menu or a menu item, use the arrow keys.
- To choose an item in a list or to toggle a field, for example an Enable/Disable field, use either the arrow keys or **f5** or **f6**.
- To select an item, press **enter**.
- To close a text box or return to the menu display, press **esc**.
- To display additional navigation and selection information while the Setup Utility is open, press **f1**.

Displaying system information

The following procedure explains how to display system information in the Setup Utility. If the Setup Utility is not open, begin at step 1. If the Setup Utility is open, begin at step 2.

1. Open the Setup Utility by turning on or restarting the computer. While the “Press the ESC key for Startup Menu” message is displayed in the lower-left corner of the screen, press **f10**.
– or –
Open the Setup Utility by turning on or restarting the computer. While the “Press the ESC key from Startup Menu” message is displayed in the lower-left corner of the screen, press **esc**. When the Startup Menu is displayed, press **f10**.
2. Select the **Main** menu. System information such as the system time and date, and identification information about the computer is displayed.
3. To exit the Setup Utility without changing any settings, use the arrow keys to select **Exit > Exit Discarding Changes**, and then press **enter**.

Restoring default settings in the Setup Utility

The following procedure explains how to restore the Setup Utility default settings. If the Setup Utility is not already running, begin at step 1. If the Setup Utility is already running, begin at step 2.

1. Open the Setup Utility by turning on or restarting the computer. While the “Press the ESC key for Startup Menu” message is displayed in the lower-left corner of the screen, press **f10**.
– or –
Open the Setup Utility by turning on or restarting the computer. While the “Press the ESC key for Startup Menu” message is displayed in the lower-left corner of the screen, press **esc**. When the Startup Menu is displayed, press **f10**.
2. Use the arrow keys to select **Exit > Load Setup Defaults**, and then press **enter**.
3. When the Setup Confirmation is displayed, press **enter**.
4. To save your change and exit the Setup Utility, use the arrow keys to select **Exit > Exit Saving Changes**, and then press **enter**.

The Setup Utility default settings go into effect when the computer restarts.



Your password, security, and language settings are not changed when you restore the factory default settings.

Exiting the Setup Utility

You can exit the Setup Utility with or without saving changes.

- To exit the Setup Utility and save your changes from the current session:

If the Setup Utility menus are not visible, press **esc** to return to the menu display. Then use the arrow keys to select **Exit > Exit Saving Changes**, and then press **enter**.

- To exit the Setup Utility without saving your changes from the current session:

If the Setup Utility menus are not visible, press **esc** to return to the menu display. Then use the arrow keys to select **Exit > Exit Discarding Changes**, and then press **enter**.

After either choice, the computer restarts in Windows.

Setup Utility menus

The menu tables in this section provide an overview of Setup Utility options.



Some of the Setup Utility menu items listed in this chapter may not be supported by your computer.

Main menu

Select	To do this
System information	<ul style="list-style-type: none">■ View and change the system time and date.■ View identification information about the computer.■ View specification information about the processor, memory size, system BIOS, and keyboard controller version (select models only).

Security menu

Select	To do this
BIOS administrator password	Enter, change, or delete a BIOS administrator password.
Power-On Password	Enter, change, or delete a power-on password.

System Configuration menu

Select	To do this
Language Support	Change the Setup Utility language.
Button Sound (select models only)	Enable/disable the capacitive button tapping sound.
Virtualization Technology	Enable/disable the processor Virtualization Technology.
Processor C4 State (select models only)	Enable/disable the processor C4 sleep state.
LAN Power Saving (select models only)	Enable/disable LAN Power Saving. When enabled, saves power when the computer is in DC mode.
Card Reader/1394 Power Saving (select models only)	Enable/disable Card Reader/1394 Power Saving. When enabled, saves power when the computer is in DC mode.
Fan Always On	Enabled/disable Fan Always On. When enabled, the computer fan will always be on.
Boot Options	<p>Set the following boot options:</p> <ul style="list-style-type: none">■ f9 and f10 Delay (sec.)—Set the delay for the f9 and f10 functions of the Setup Utility in intervals of 5 seconds each (0, 5, 10, 15, 20).■ CD-ROM boot—Enable/disable boot from CD-ROM.■ Floppy boot—Enable/disable boot from diskette.■ Internal Network Adapter boot—Enable/disable boot from Internal Network Adapter.■ Boot Order—Set the boot order for:<ul style="list-style-type: none"><input type="checkbox"/> USB Floppy<input type="checkbox"/> Internal CD/DVD ROM Drive<input type="checkbox"/> Hard drive<input type="checkbox"/> USB Diskette on Key<input type="checkbox"/> USB Hard drive<input type="checkbox"/> Network adapter

Diagnostics menu

Select	To do this
Hard Disk Self Test	<p>Run a comprehensive self-test on the hard drive.</p> <p> On models with two hard drives, this menu option is called the Primary Hard Disk Self Test.</p>
Secondary Hard Disk Self Test (select models only)	Run a comprehensive self-test on a secondary hard drive.
Memory Test	Run a diagnostic test on the system memory.

Specifications

Computer specifications

	Metric	U.S.
Dimensions		
Width	37.8 cm	14.9 in
Depth	25.2 cm	9.9 in
Height (front to rear)	35.1 cm	13.8 in
Weight		
Equipped with 6-cell battery and optical drive	2.75 kg	7.56 lbs
Input power		
Operating voltage	18.5 V dc @ 3.5 A - 65 W or 19.0 V dc @ 4.74 A - 90 W	
Operating current	3.5 A or 4.74 A	
Temperature		
Operating (not writing to optical disc)	0°C to 35°C	32°F to 95°F
Operating (writing to optical disc)	5°C to 35°C	41°F to 95°F
Nonoperating	-20°C to 60°C	-4°F to 140°F
Relative humidity (noncondensing)		
Operating	10% to 90%	10% to 90%
Nonoperating	5% to 95%	5% to 95%
Maximum altitude (unpressurized)		
Operating	-15 m to 3,048 m	-50 ft to 10,000 ft
Nonoperating	-15 m to 12,192 m	-50 ft to 40,000 ft



Applicable product safety standards specify thermal limits for plastic surfaces. The computer operates well within this range of temperatures.

16 and 15.6-inch WXGA display specifications

	Metric	U.S.
Dimensions		
Height	25.2 cm	9.9 in
Width	37.8 cm	14.9 in
Diagonal	35.1 cm	13.8 in
Number of colors	Up to 16.8 million	
Contrast ratio	200:1	
Brightness	180 nits typical	
Pixel resolution		
Pitch	.259x.259 mm	
Format	1440x900	
Configuration	RGB typical strip	
Backlight	CCFT	
Character display	80x25	
Total power consumption	6.5 w	
Viewing angle	+/-45° horizontal, +15/-35 vertical typical	

Hard drive specifications

	320-GB*	250-GB*	200-GB*	160-GB*	120-GB*
Dimensions					
Height	9.5 mm	9.5 mm	9.5 mm	9.5 mm	9.5 mm
Width	70 mm	70 mm	70 mm	70 mm	70 mm
Weight	101 g	101 g	101 g	101 g	101 g
Interface type	SATA	SATA	SATA	SATA	SATA
Transfer rate	100 MB/sec	100 MB/sec	100 MB/sec	100 MB/sec	100 MB/sec
Security	ATA security	ATA security	ATA security	ATA security	ATA security
Seek times (typical read, including setting)					
Single track	3 ms	3 ms	3 ms	3 ms	3 ms
Average	13 ms	13 ms	13 ms	13 ms	13 ms
Maximum	24 ms	24 ms	24 ms	24 ms	24 ms
Logical blocks	625,142,448	488,376,120	390,700,850	312,560,340	234,420,480
Disc rotational speed	5400 rpm	5400 rpm	5400 rpm	7200 and 5400 rpm	7200 and 5400 rpm
Operating temperature	5°C to 55°C (41°F to 131°F)				

*1 GB = 1 billion bytes when referring to hard drive storage capacity. Actual accessible capacity is less. Actual drive specifications may differ slightly.

 Certain restrictions and exclusions apply. Contact technical support for details.

DVD±RW and CD-RW SuperMulti Double-Layer Combo Drive specifications

Applicable disc	Read:	Write:
	CD-DA, CD+(E)G, CD-MIDI, CD-TEXT, CD-ROM, CD-ROM XA, MIXED MODE CD, CD-I, CD-I Bridge (Photo-CD, Video CD), Multisession CD (Photo-CD, CD-EXTRA, Portfolio, CD-R, CD-RW), CD-R, CD-RW, DVD-ROM (DVD-5, DVD-9, DVD-10, DVD-18), DVD-R, DVD-RW, DVD+R, DVD+RW, DVD-system memory	CD-R and CD-RW DVD+R, DVD+RW, DVD-R, DVD-RW, DVD-system memory
Access time	CD	DVD
Random	< 175 ms	< 230 ms
Cache buffer	2 MB	
Data transfer rate		
24X CD-ROM	3,600 KB/sec	
8X DVD	10,800 KB/sec	
24X CD-R	3,600 KB/sec	
16X CD-RW	2,400 KB/sec	
8X DVD+R	10,800 KB/sec	
4X DVD+RW	5,400 KB/sec	
8X DVD-R	10,800 KB/sec	
4X DVD-RW	5,400 KB/sec	
2.4X DVD+R(9)	2,700 KB/sec	
5X DVD-system memory	6,750 KB/sec	

DVD±RW and CD-RW SuperMulti Double-Layer Combo Drive with LightScribe specifications

Applicable disc	Read:	Write:
	CD-ROM, CD-R, CD-RW, High Speed CD-RW, Ultra & Ultra+ Speed CD-RW, DVD, DVD±R/RW, DVD±R, DVD-system memory	DVD-system memory (Ver.2), DVD±R, DVD±RW, DVD±Dual, CD-R, and CD-RW
Access time	CD	DVD
Random	< 130 ms	< 150 ms
Cache buffer	2 MB	
Data transfer rate		
5X DVD-system memory	6,750 KB/sec	
8X DVD±RW	10,800 KB/sec	
8X DVD±R	10,800 KB/sec	
16X CD-R	3,600 KB/sec	
16X CD-RW (High Speed)	1,500 KB/sec	

Blu-ray ROM DVD±RW SuperMulti DL Drive specifications

Applicable disc	Read:	Write:
	BD-ROM, BD-ROM-DL, BD-R, BD-R-DL, BD-RE, BD-RE-DL, DVD-ROM, DVD+R, DVD+R-DL, DVD+RW, DVD-R, DVD-R-DL, DVD-RW, DVD-system memory (Ver.2), CD-DA, CD-ROM (Mode 1 and mode 2), CD-ROM XA (Mode 2, form 1 and form 2), Photo CD (Single and multiple sessions), CD Extra, CD-R, CD-RW, and CD-TEXT	DVD-system memory (Ver.2), DVD+R, DVD-R, CD-R, and CD-RW
Access time	BD	DVD
Random	< 230 ms	< 180 ms
Cache buffer	4.5 MB	
Data transfer rate		
2X BD-system memory	9 MB/sec	
8X DVD	2,400 KB/sec	
16X CD-R	2,400 KB/sec	
16X CD-RW	2,400 KB/sec	

System DMA specifications

Hardware	DMA System function
DMA0	Not applicable
DMA1*	Not applicable
DMA2*	Not applicable
DMA3	Not applicable
DMA4	Direct memory access controller
DMA5*	Available for PC Card
DMA6	Not assigned
DMA7	Not assigned

*PC Card controller can use DMA 1, 2, or 5.

System interrupt specifications

Hardware IRQ	System function
IRQ0	System timer
IRQ1	Standard 101-/102-key or Microsoft® Natural Keyboard
IRQ2	Cascaded
IRQ4	COM1
IRQ6	Diskette drive
IRQ7*	Parallel port
IRQ8	System CMOS/real-time clock
IRQ9*	Microsoft ACPI-compliant system
IRQ12	Synaptics PS/2 TouchPad
IRQ13	Numeric data processor
IRQ14	Primary IDE channel
IRQ15	Secondary IDE channel

*Default configuration; audio possible configurations are IRQ5, IRQ7, IRQ9, IRQ10, or none.

 PC Cards may assert IRQ3, IRQ4, IRQ5, IRQ7, IRQ9, IRQ10, IRQ11, or IRQ15. Either the infrared or the serial port may assert IRQ3 or IRQ4.

System I/O address specifications

I/O address (hex)	System function (shipping configuration)
000 - 00F	DMA controller no. 1
010 - 01F	Unused
020 - 021	Interrupt controller no. 1
022 - 024	Opti chipset configuration registers
025 - 03F	Unused
02E - 02F	87334 "Super I/O" configuration for CPU
040 - 05F	Counter/timer registers
044 - 05F	Unused
060	Keyboard controller
061	Port B
062 - 063	Unused
064	Keyboard controller
065 - 06F	Unused
070 - 071	NMI enable/RTC
072 - 07F	Unused
080 - 08F	DMA page registers
090 - 091	Unused
092	Port A
093 - 09F	Unused
0A0 - 0A1	Interrupt controller no. 2
I/O Address (hex)	System Function (shipping configuration)
0A2 - 0BF	Unused
0C0 - 0DF	DMA controller no. 2
0E0 - 0EF	Unused
0F0 - 0F1	Coprocessor busy clear/reset
0F2 - 0FF	Unused
100 - 16F	Unused
170 - 177	Secondary fixed disk controller
178 - 1EF	Unused
1F0 - 1F7	Primary fixed disk controller
1F8 - 200	Unused
201	JoyStick (decoded in ESS1688)
202 - 21F	Unused
220 - 22F	Entertainment audio
230 - 26D	Unused
26E - 26	Unused

(Continued)

I/O address (hex)	System function (shipping configuration)
278 - 27F	Unused
280 - 2AB	Unused
2A0 - 2A7	Unused
2A8 - 2E7	Unused
2E8 - 2EF	Reserved serial port
2F0 - 2F7	Unused
2F8 - 2FF	Infrared port
300 - 31F	Unused
320 - 36F	Unused
370 - 377	Secondary diskette drive controller
378 - 37F	Parallel port (LPT1/default)
380 - 387	Unused
388 - 38B	FM synthesizer-OPL3
38C - 3AF	Unused
3B0 - 3BB	VGA
3BC - 3BF	Reserved (parallel port/no EPP support)
3C0 - 3DF	VGA
3E0 - 3E1	PC Card controller in CPU
3E2 - 3E3	Unused
3E8 - 3EF	Internal modem
3F0 - 3F7	"A" diskette controller
3F8 - 3FF	Serial port (COM1/default)
CF8 - CFB	PCI configuration index register (PCIDIVO-1)
CFC - CFF	PCI configuration data register (PCIDIVO-1)

System memory map specifications

Size	Memory address	System function
640 KB	00000000-0009FFFF	Base memory
128 KB	000A0000-000BFFFF	Video memory
48 KB	000C0000-000CBFFF	Video BIOS
160 KB	000C8000-000E7FFF	Unused
64 KB	000E8000-000FFFFF	System BIOS
15 MB	00100000-00FFFFFF	Extended memory
58 MB	04800000-07FFFFFF	Super extended memory
58 MB	04800000-07FFFFFF	Unused
2 MB	08000000-080FFFFF	Video memory (direct access)
4 GB	08200000-FFFEFFFF	Unused
64 KB	FFFF0000-FFFFFFFF	System BIOS

Screw listing

This section provides specification and reference information for the screws used in the computer. All screws listed in this section are available in the Screw Kit, spare part number 486622-001.

Phillips PM2.5×6.0 screw

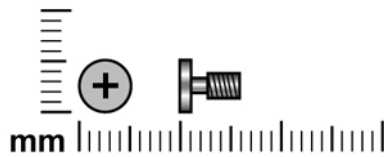

Color	Quantity	Length	Thread	Head diameter
Black	13	6.0 mm	2.5 mm	5.0 mm

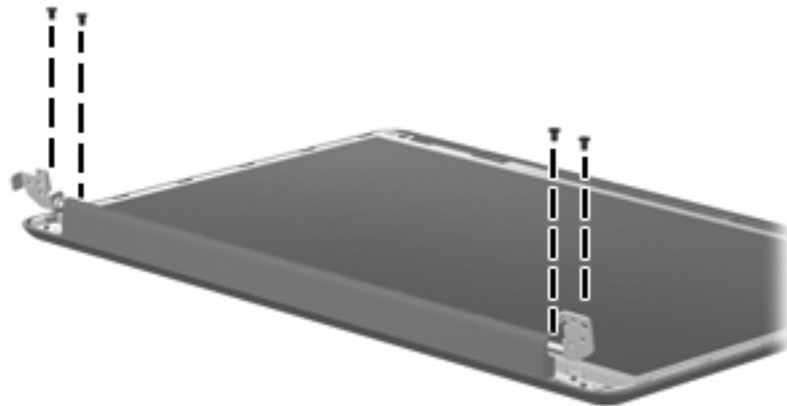

Where used: 4 screws that secure the display to the computer.

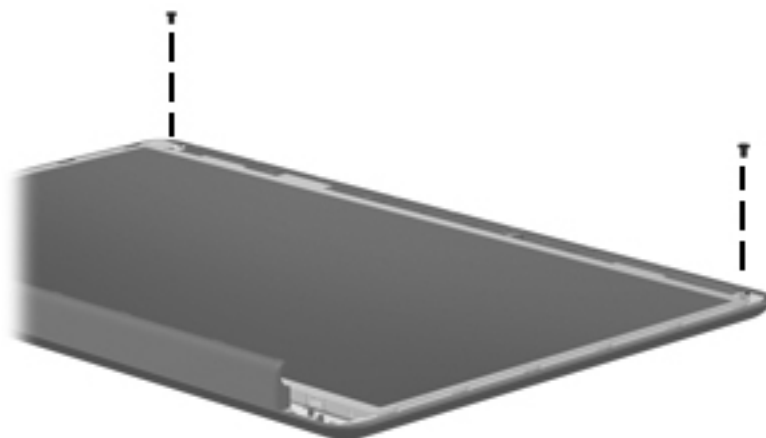

Where used: 2 screws that secure the display panel to the display.

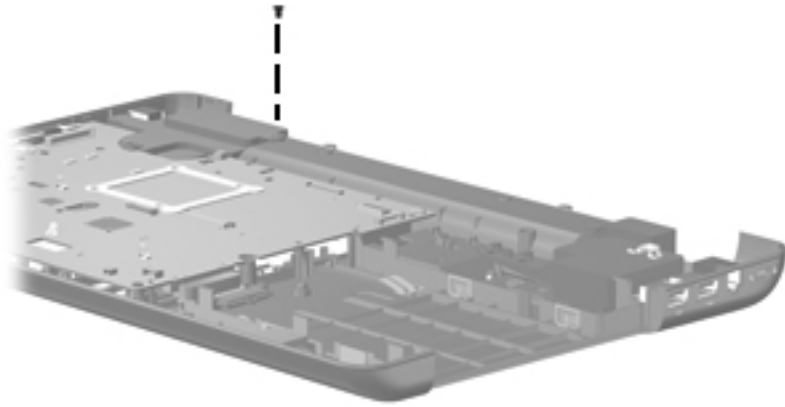

Where used: 1 screw that secures the left speaker to the base enclosure.

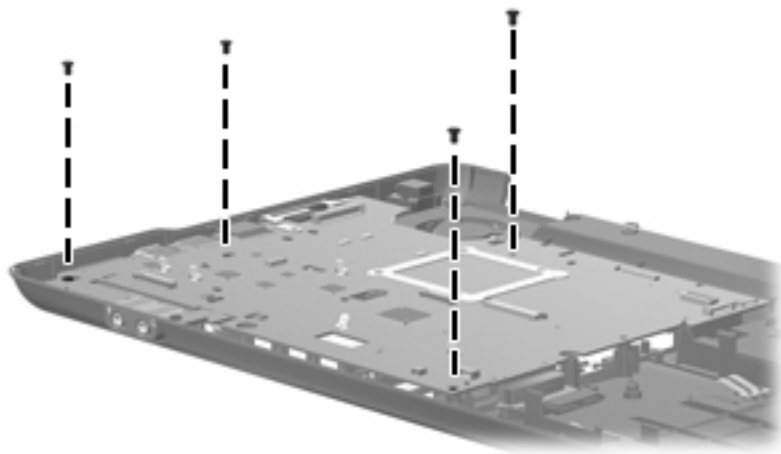

Where used: 4 screws that secure the system board to the base enclosure.

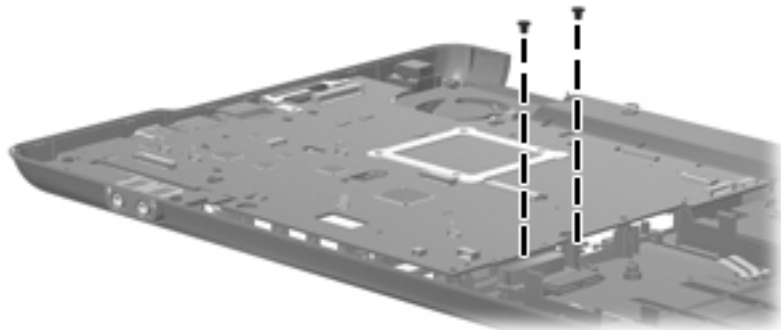

Where used: 2 screws that secure the optical drive connector board to the base enclosure.

Phillips PM2.5x5.0 screw

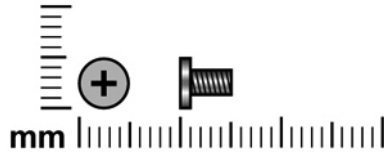

Color	Quantity	Length	Thread	Head diameter
Black	6	5.0 mm	2.5 mm	5.0 mm

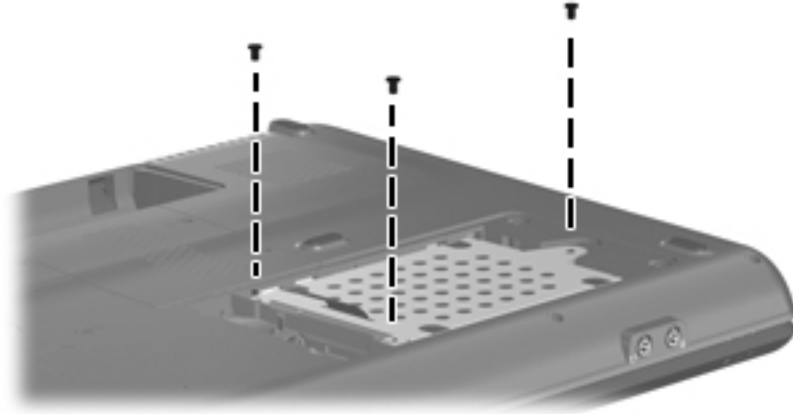

Where used: 3 screws that secure hard drive to the computer.

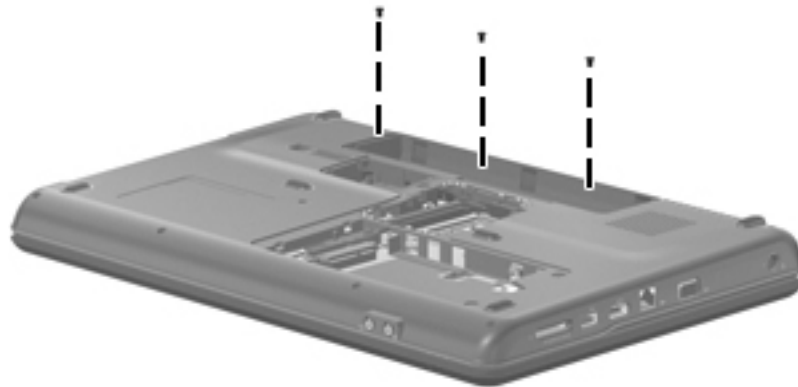

Where used: 3 screws that secure the keyboard to the computer.

Phillips PM2.5x6.0 captive screw

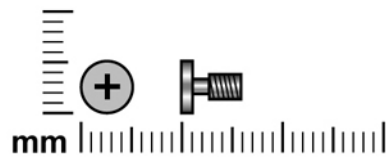

Color	Quantity	Length	Thread	Head diameter
Black	5	6.0 mm	2.5 mm	5.0 mm

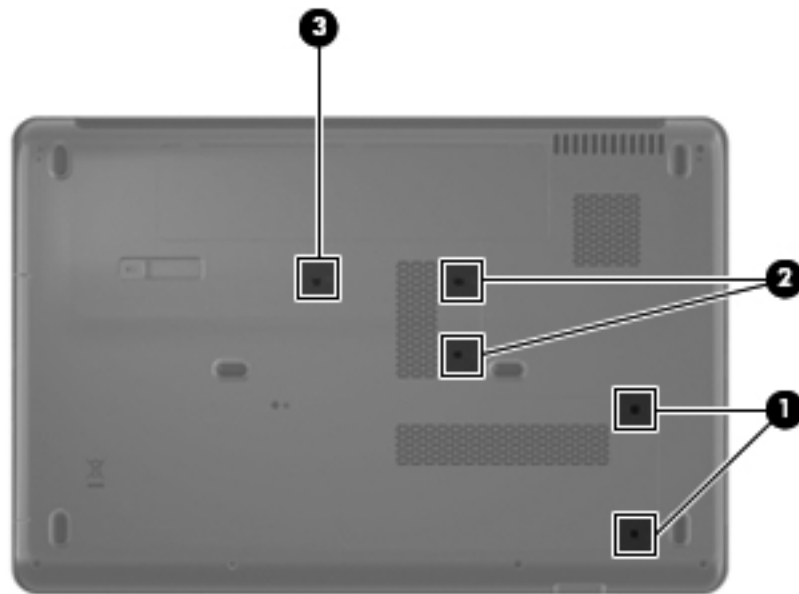

Where used:

- ❶ Two screws that secure the hard drive cover to the computer (screws are secured by C-clips)
- ❷ Two screws that secure the memory module cover to the computer (screws are secured by C-clips)
- ❸ One screw that secures the WLAN cover to the computer (screw is secured by a C-clip)

Phillips PM3.0x4.0 screw

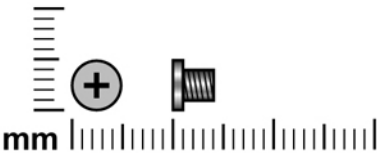

Color	Quantity	Length	Thread	Head diameter
Black	4	4.0 mm	3.0 mm	5.0 mm

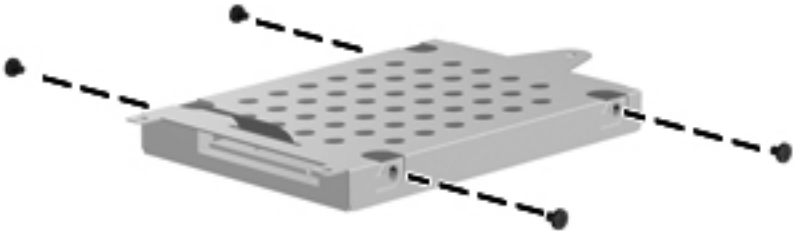

Where used: 4 screws that secure the hard drive bracket to the hard drive.

Phillips PM2.0x4.0 screw

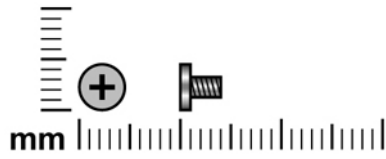

Color	Quantity	Length	Thread	Head diameter
Black	23	4.0 mm	2.0 mm	4.0 mm

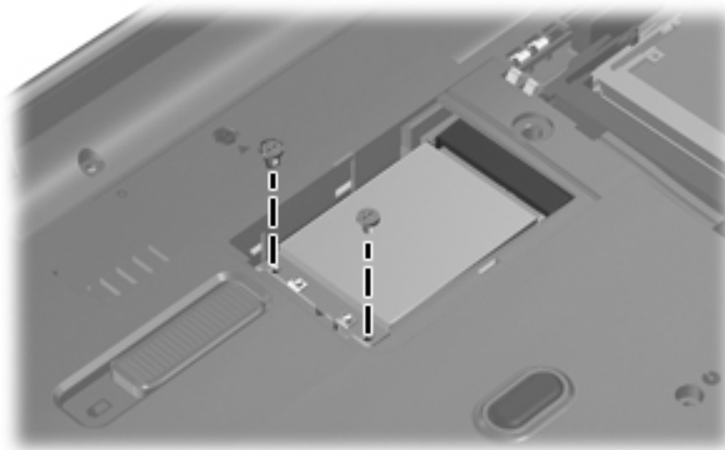

Where used: 2 screws that secure the WLAN module to the computer

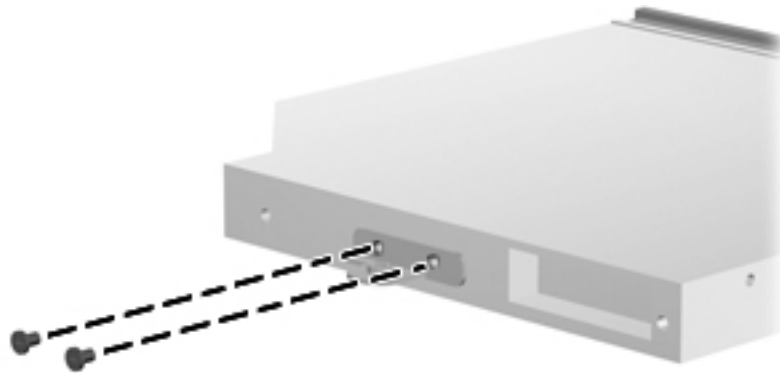

Where used: 2 screws that secure the optical drive bracket to the optical drive

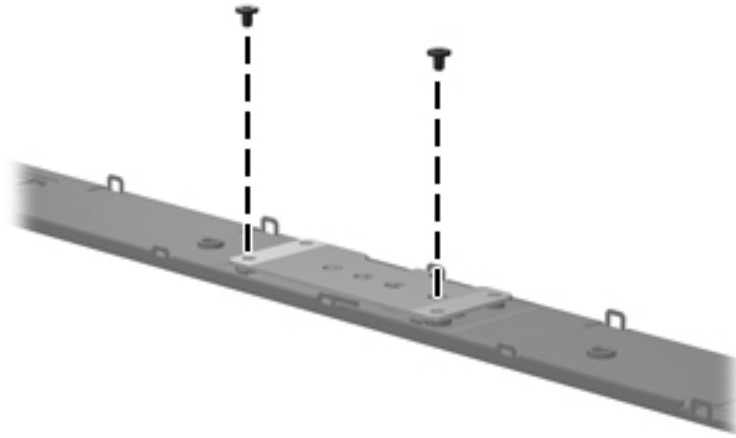

Where used: 2 screws that secure the power button board to the computer

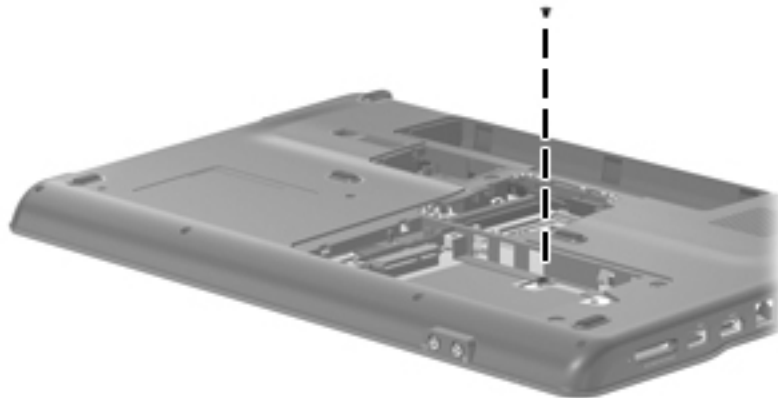

Where used: 1 screw that secures the top cover to the computer

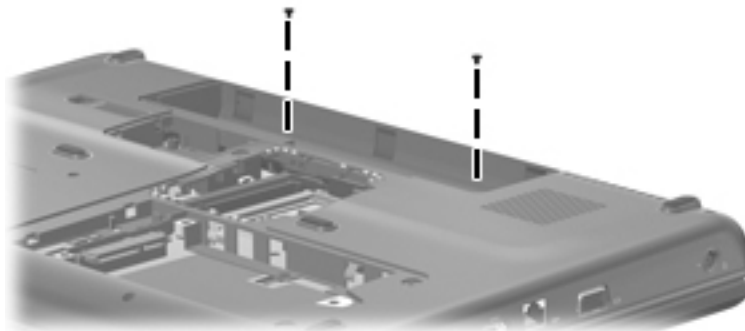

Where used: 2 screws that secure the top cover to the computer



Where used: 1 screw that secures the top cover to the computer

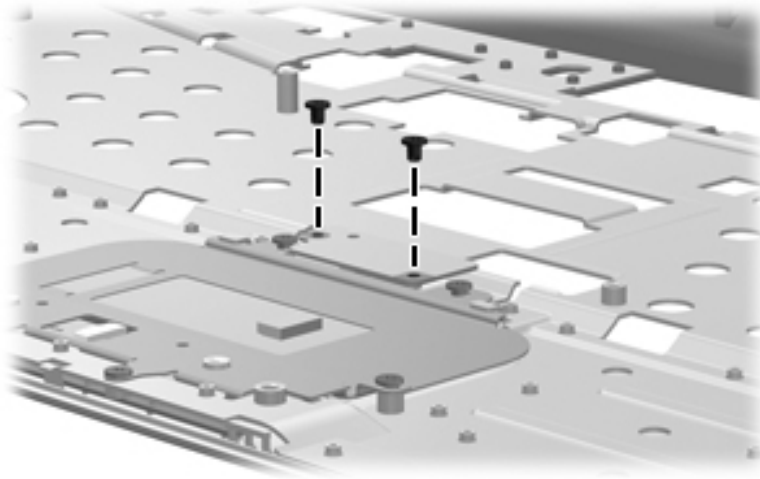

Where used: 2 screws that secure the TouchPad on/off button board to the computer

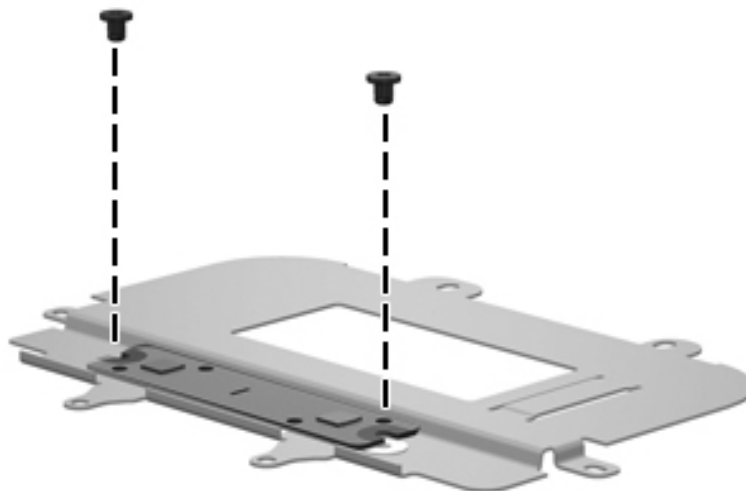

Where used: 2 screws that secure the TouchPad button board bracket to the TouchPad button board

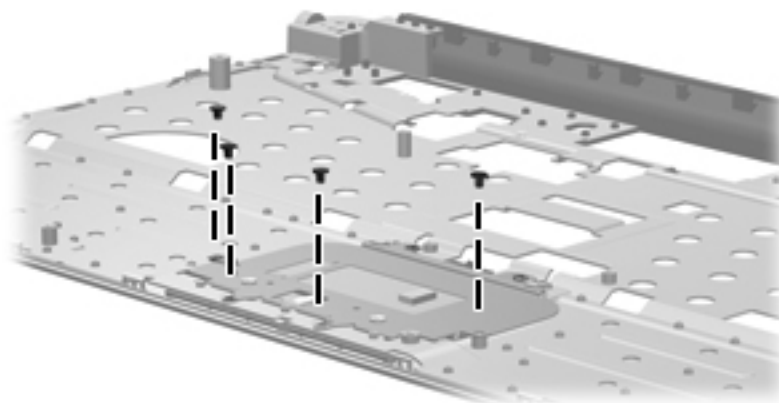

Where used: 4 screws that secure the TouchPad button board bracket to the TouchPad button board

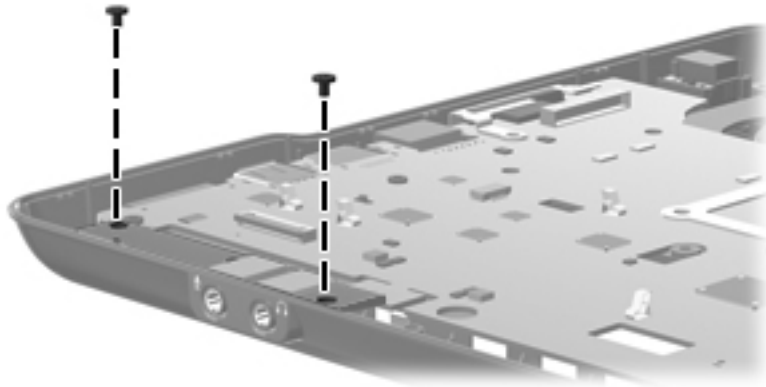

Where used: 2 screws that secure the audio board to the base enclosure

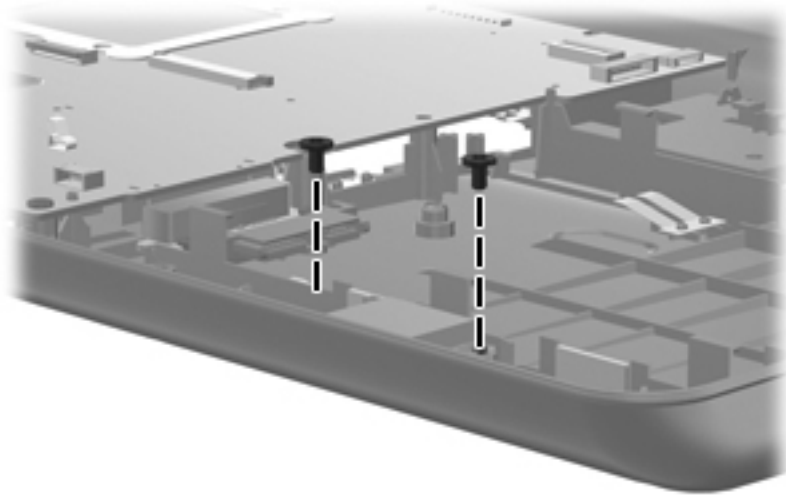

Where used: 2 screws that secure the Bluetooth module to the base enclosure

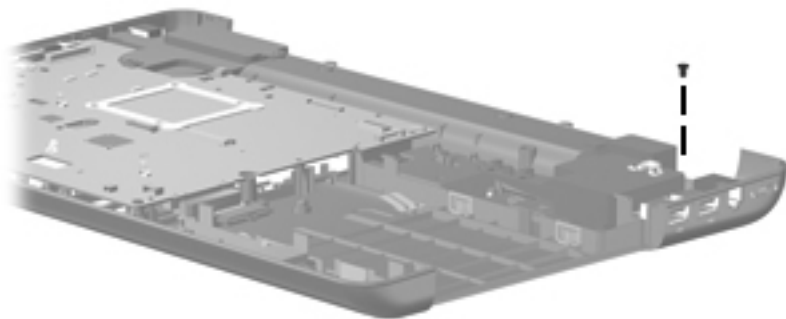

Where used: 1 screw that secures the right speaker to the base enclosure

Phillips PM2.5x9.0 screw

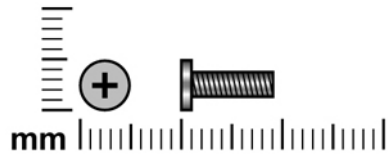

Color	Quantity	Length	Thread	Head diameter
Black	11	9.0 mm	2.5 mm	5.0 mm



Where used: 1 screw that secures the optical drive to the computer

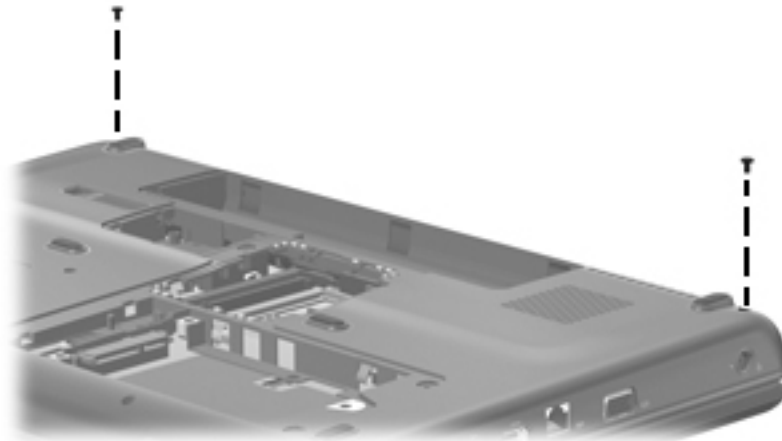

Where used: 2 screws that secure the keyboard cover to the computer



Where used: 4 screws that secure the display to the computer

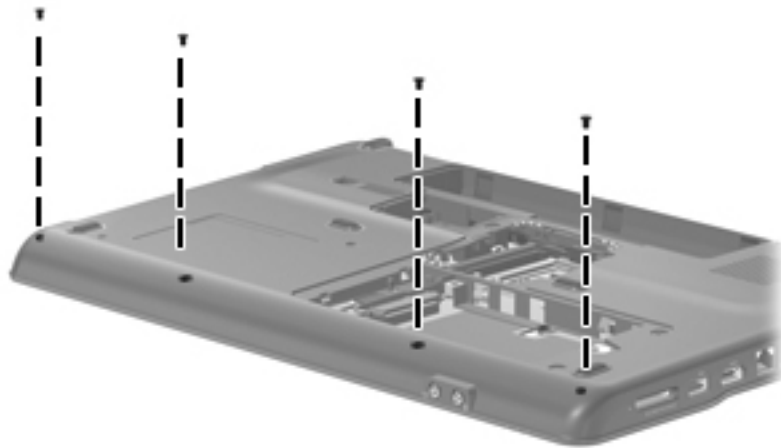

Where used: 4 screws that secure the top cover to the computer

Phillips PM2.5x7.0 screw

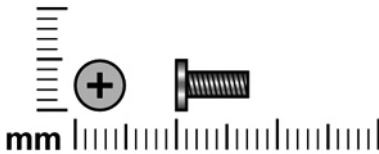

Color	Quantity	Length	Thread	Head diameter
Black	2	7.0 mm	2.5 mm	5.0 mm

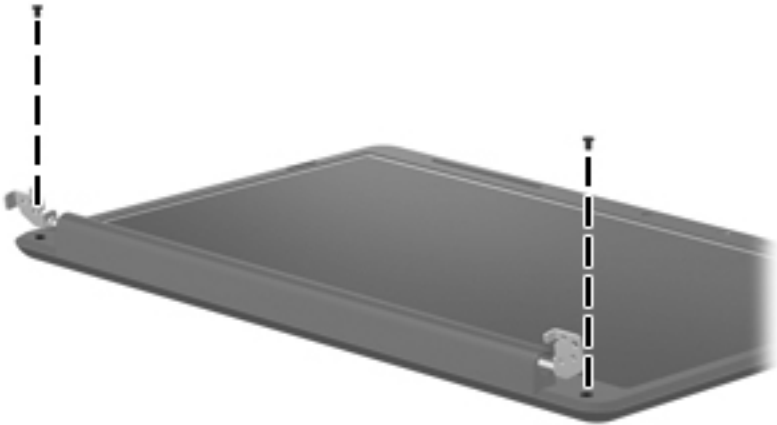

Where used: 2 screws that secure the display bezel to the display

Phillips PM2.0x6.0 screw

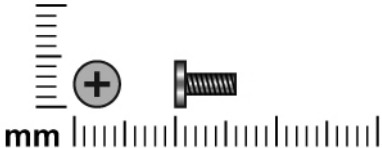

Color	Quantity	Length	Thread	Head diameter
Black	4	6.0 mm	2.0 mm	4.0 mm

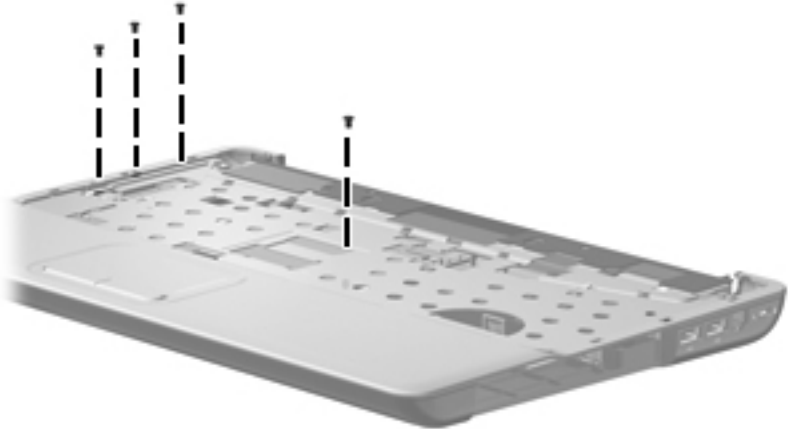

Where used: 4 screws that secure the top cover to the computer

Phillips PM2.0×3.0 screw



Color	Quantity	Length	Thread	Head diameter
Black	1	3.0 mm	2.0 mm	4.0 mm

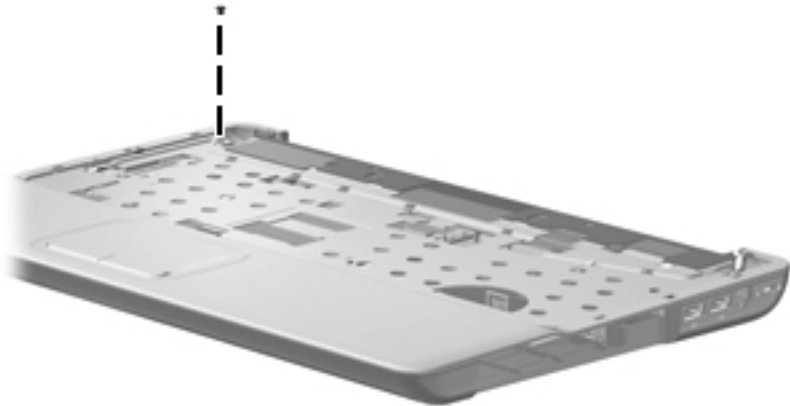

Where used: 1 screw that secures the top cover to the computer

Phillips PM2.0x10.0 captive screw

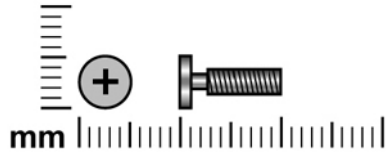

Color	Quantity	Length	Thread	Head diameter
Silver	4	10.0 mm	2.0 mm	5.0 mm

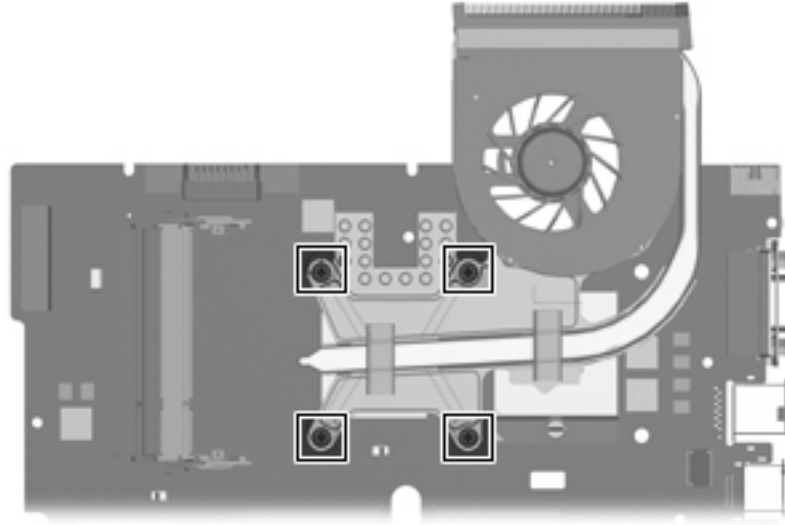

Where used: 4 screws that secure the fan/heat sink to the base enclosure (screws are secured by C-clips) on computer models equipped with graphics subsystems with UMA memory

Phillips PM2.5x11.0 captive screw

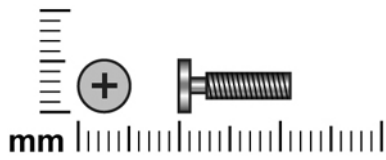

Color	Quantity	Length	Thread	Head diameter
Silver	4	11.0 mm	2.5 mm	5.0 mm

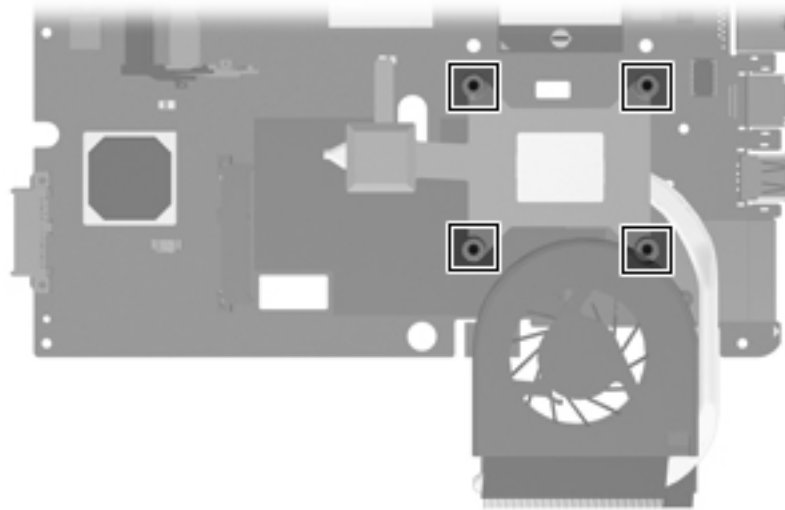

Where used: 4 screws that secure the fan/heat sink to the base enclosure (screws are secured by C-clips) on computer models equipped with graphics subsystems with discrete memory

Backup and recovery

Recovery after a system failure is as complete as your most current backup. HP recommends that you create recovery discs immediately after software setup. As you add new software and data files, you should continue to back up your system on a regular basis to maintain a reasonably current backup.

Tools provided by the operating system and Recovery Manager software are designed to help you with the following tasks for safeguarding your information and restoring it in case of a system failure:

- Making a set of recovery discs (Recovery Manager software feature). Recovery discs are used to start up (boot) your computer and restore the operating system and software programs to factory settings in case of system failure or instability.
- Backing up your information regularly to protect your important system files.
- Creating system restore points (operating system feature). System restore points allow you to reverse undesirable changes to your computer by restoring the computer to an earlier state.
- Recovering a program or driver (Recovery Manager software feature). This feature helps you reinstall a program or driver without performing a full system recovery.
- Performing a full system recovery (Recovery Manager software feature). With Recovery Manager, you can recover your full factory image if you experience system failure or instability. Recovery Manager works from a dedicated recovery partition (select models only) on the hard drive or from recovery discs you create.



If your computer includes a solid-state drive (SSD), you may not have a recovery partition. Recovery discs have been included for computers that do not have a partition. Use these discs to recover your operating system and software. To check for the presence of a recovery partition, select **Start > Computer**. If the partition is present, an HP Recovery drive is listed in the Hard Disk Drives section of the window.

Creating recovery discs



HP recommends that you create recovery discs to be sure that you can restore your system to its original factory state if you experience serious system failure or instability. Create these discs after setting up the computer for the first time.



Handle these discs carefully and keep them in a safe place. The software allows the creation of only one set of recovery discs.

Note the following guidelines before creating recovery discs:

- You will need high quality CD-R, DVD-R, double-layer DVD-R, DVD+R, double-layer DVD+R, or BD-R (writable Blu-ray) discs. All these discs are purchased separately.
 -  Read-write discs, such as CD-RW, DVD±RW, double-layer DVD±RW, and BD-RE (rewritable Blu-ray) discs, are not compatible with the Recovery Manager software.
- The computer must be connected to AC power during this process.

- Only one set of recovery discs can be created per computer.
- Number each disc before inserting it into the computer optical drive.
- If necessary, you can exit the program before you have finished creating the recovery discs. The next time you open Recovery Manager, you will be prompted to continue the disc creation process.

To create a set of recovery discs:

1. Select **Start > All Programs > Recovery Manager > Recovery Manager**.

Recovery Manager opens.

2. Click **Advanced Options**.

 If you are operating the computer on battery power, you will be prompted to connect to AC power before you can go to the next step.

3. Click **Recovery disc creation**, and then click **Next**.
4. Follow the on-screen instructions.

When to back up

- On a regularly scheduled basis
 -  Set reminders to back up your information periodically.
- Before the computer is repaired or restored
- Before you add or modify hardware or software

Backup suggestions

- Create a set of recovery discs using Recovery Manager.
- Create system restore points using the Windows System Restore feature, and periodically copy them to disc.
- Store personal files in the Documents folder and back up these folders periodically.
- Back up templates stored in their associated programs.
- Save customized settings in a window, toolbar, or menu bar by taking a screen shot of your settings. The screen shot can be a time-saver if you have to reset your preferences.

To copy the screen and paste it into a word-processing document, follow these steps:

- a. Display the screen.
- b. Copy the screen:
 - To copy only the active window, press **alt+fn+prt sc**.
 - To copy the entire screen, press **fn+prt sc**.
- c. Open a word-processing document, and then select **Edit > Paste**.

Using system restore points

When you back up your system, you are creating a system restore point. A system restore point allows you to save and name a snapshot of your hard drive at a specific point in time. You can then recover back to that point if you want to reverse subsequent changes made to your system.



Recovering to an earlier restore point does not affect data files saved or e-mails created since the last restore point.

You also can create additional restore points to provide increased protection for your system files and settings.

When to create restore points

- Before you add or extensively modify software or hardware
- Periodically, whenever the system is performing optimally



If you revert to a restore point and then change your mind, you can reverse the restoration.

Create a system restore point

1. Select **Start > Control Panel > System and Maintenance > System**.
2. In the left pane, click **System Protection**.
3. Click the **System Protection** tab.
4. Under **Automatic restore points**, select the disk for which you want to create a restore point.
5. Click **Create**.

The System Protection window opens.

6. Follow the on-screen instructions.

Restore to a previous date and time

To revert to a restore point (created at a previous date and time), when the computer was functioning optimally, follow these steps:

1. Select **Start > Control Panel > System and Maintenance > System**.
2. In the left pane, click **System protection**.
3. Click the **System Protection** tab.
4. Click the **System Restore** button, and then click **Next**.

The System Restore window opens.

5. Follow the on-screen instructions.

Performing a recovery



You can recover only files that you have previously backed up. HP recommends that you use Recovery Manager to create an entire drive backup as soon as you set up your computer.

Recovery Manager software allows you to repair or restore the system if you experience system failure or instability. Recovery Manager works from recovery discs that you create or from a dedicated recovery partition (select models only) on the hard drive. However, if your computer includes a solid-state drive (SSD), you may not have a recovery partition. If that is the case, recovery discs have been included with your computer. Use these discs to recover your operating system and software.



Windows has its own built-in repair features, such as System Restore and driver roll-back capabilities. If you have not already tried these features, try them before using Recovery Manager.



Recovery Manager recovers only software that was preinstalled at the factory. Software not provided with this computer must be downloaded from the manufacturer's Web site or reinstalled from the disc provided by the manufacturer.

Recovering from the recovery discs

To restore the system from the recovery discs:

1. Back up all personal files.
2. Insert the first recovery disc into the optical drive and restart the computer.
3. Follow the on-screen instructions.

Recovering from the dedicated recovery partition (select models only)



If your computer includes a solid-state drive (SSD), you may not have a recovery partition. You will not be able to recover using this procedure. Recovery discs have been included for computers that do not have a partition. Use these discs to recover your operating system and software.

On some models, you can perform a recovery from the partition on the hard drive from either the Start button or **f11**.

To restore the system from the partition, follow these steps:

1. Access Recovery Manager in either of the following ways:
 - Select **Start > All Programs > Recovery Manager > Recovery Manager**.
 - or–
 - Restart the computer and press **f11** while the “Press <F11> for recovery” message is displayed on the screen. Then select **Recovery Manager**.

Recovery Manager opens.

2. Click **Advanced Options**.
3. Click **System recovery**, and then click **Next**.
4. Follow the on-screen instructions.

Connector pin assignments

Audio-in (microphone)

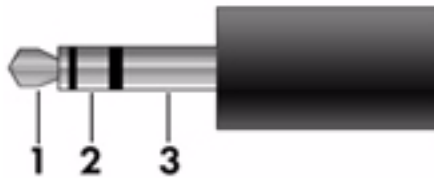

Pin	Signal
1	Audio signal in
2	Audio signal in
3	Ground

Audio-out (headphone)

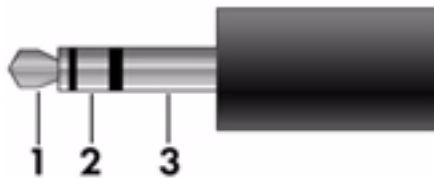

Pin	Signal
1	Audio out, left channel
2	Audio out, right channel
3	Ground

External monitor

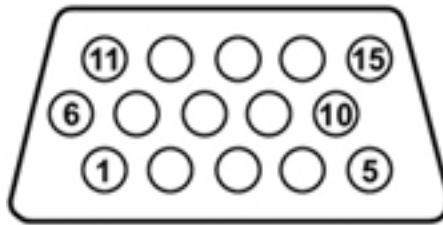

Pin	Signal
1	Red analog
2	Green analog
3	Blue analog
4	Not connected
5	Ground
6	Ground analog
7	Ground analog
8	Ground analog
9	+5 VDC
10	Ground
11	Monitor detect
12	DDC 2B data
13	Horizontal sync
14	Vertical sync
15	DDC 2B clock

HDMI

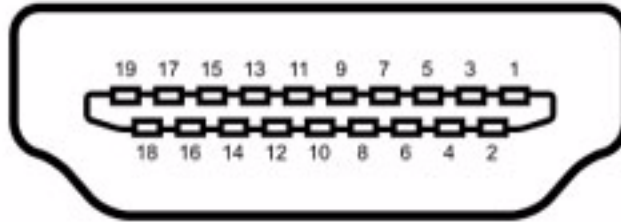

Pin	Signal
1	Transition minimized differential signal (TDMS) data 2+
2	Transition minimized differential signal (TDMS) data 2 shield
3	Transition minimized differential signal (TDMS) data 2-
4	Transition minimized differential signal (TDMS) data 1+
5	Transition minimized differential signal (TDMS) data 1 shield
6	Transition minimized differential signal (TDMS) data 1 shield
7	Transition minimized differential signal (TDMS) data 0+
8	Transition minimized differential signal (TDMS) data 0 shield
9	Transition minimized differential signal (TDMS) data 0-
10	Transition minimized differential signal (TDMS) clock +
11	Transition minimized differential signal (TDMS) data clock shield
12	Transition minimized differential signal (TDMS) data clock-
13	Consumer electronics control (CEC)
14	Not connected
15	Display data channel (DDC) clock
16	Display data channel (DDC) data
17	Ground
18	+5V Power
19	Hot plug detect

RJ-11 (modem)

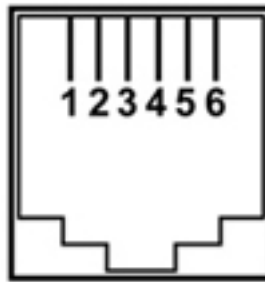

Pin	Signal
1	Unused
2	Tip
3	Ring
4	Unused
5	Unused
6	Unused

RJ-45 (network)

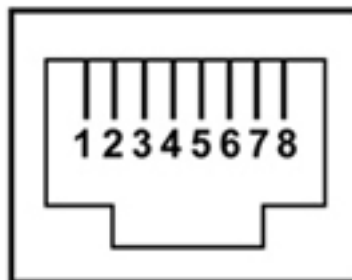

Pin	Signal
1	Transmit +
2	Transmit -
3	Receive +
4	Unused
5	Unused
6	Receive -
7	Unused
8	Unused

Universal Serial Bus

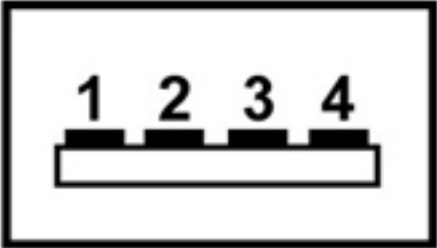

Pin	Signal
1	+5 VDC
2	Data -
3	Data +
4	Ground

Power cord set requirements

The wide range input feature of the computer permits it to operate from any line voltage from 100 to 120 volts AC or from 220 to 240 volts AC.

The 3-conductor power cord set included with the computer meets the requirements for use in the country or region where the equipment is purchased.

Power cord sets for use in other countries and regions must meet the requirements of the country or region where the computer is used.

Requirements for all countries and regions

The requirements listed below are applicable to all countries and regions:

- The length of the power cord set must be at least 1.5 m (5.0 ft) and no more than 2.0 m (6.5 ft).
- All power cord sets must be approved by an acceptable accredited agency responsible for evaluation in the country or region where the power cord set will be used.
- The power cord sets must have a minimum current capacity of 10 amps and a nominal voltage rating of 125 or 250 V AC, as required by the power system of each country or region.
- The appliance coupler must meet the mechanical configuration of an EN 60 320/IEC 320 Standard Sheet C13 connector for mating with the appliance inlet on the back of the computer.

Requirements for specific countries and regions

Country/region	Accredited agency	Applicable note number
Australia	EANSW	1
Austria	OVE	1
Belgium	CEBC	1
Canada	CSA	2
Denmark	DEMKO	1
Finland	FIMKO	1
France	UTE	1
Germany	VDE	1
Italy	IMQ	1
Japan	METI	3
The Netherlands	KEMA	1
Norway	NEMKO	1
The People's Republic of China	CCC	5
South Korea	EK	4
Sweden	SEMKO	1
Switzerland	SEV	1
Taiwan	BSMI	4
The United Kingdom	BSI	1
The United States	UL	2

1. The flexible cord must be Type HO5VV-F, 3-conductor, 1.0-mm² conductor size. Power cord set fittings (appliance coupler and wall plug) must bear the certification mark of the agency responsible for evaluation in the country or region where it will be used.
2. The flexible cord must be Type SPT-3 or equivalent, No. 18 AWG, 3-conductor. The wall plug must be a two-pole grounding type with a NEMA 5-15P (15 A, 125 V) or NEMA 6-15P (15 A, 250 V) configuration.
3. The appliance coupler, flexible cord, and wall plug must bear a "T" mark and registration number in accordance with the Japanese Dentori Law. The flexible cord must be Type VCT or VCTF, 3-conductor, 1.00-mm² conductor size. The wall plug must be a two-pole grounding type with a Japanese Industrial Standard C8303 (7 A, 125 V) configuration.
4. The flexible cord must be Type RVV, 3-conductor, 0.75-mm² conductor size. Power cord set fittings (appliance coupler and wall plug) must bear the certification mark of the agency responsible for evaluation in the country or region where it will be used.
5. The flexible cord must be Type VCTF, 3-conductor, 0.75-mm² conductor size. Power cord set fittings (appliance coupler and wall plug) must bear the certification mark of the agency responsible for evaluation in the country or region where it will be used.

Battery

When a battery has reached the end of its useful life, do not dispose of the battery in general household waste. Follow the local laws and regulations in your area for computer battery disposal.

Display

 **WARNING:** The backlight contains mercury. Exercise caution when removing and handling the backlight to avoid damaging this component and causing exposure to the mercury.

 **CAUTION:** The procedures in this chapter can result in damage to display components. The only components intended for recycling purposes are the liquid crystal display (LCD) panel and the backlight. When you remove these components, handle them carefully.

 **Materials disposal.** This HP product contains mercury in the backlight in the display assembly that might require special handling at end-of-life. Disposal of mercury may be regulated because of environmental considerations. For disposal or recycling information, contact your local authorities, or see the Electronic Industries Alliance (EIA) Web site at <http://www.eiae.org>.

This section provides disassembly instructions for the display assembly. The display assembly must be disassembled to gain access to the backlight ❶ and the liquid crystal display (LCD) panel ❷.



 The procedures provided in this chapter are general disassembly instructions. Specific details, such as screw sizes, quantities, and locations, and component shapes and sizes, can vary from one computer model to another.

Perform the following steps to disassemble the display assembly:

1. Remove all screw covers ① and screws ② that secure the display bezel to the display assembly.

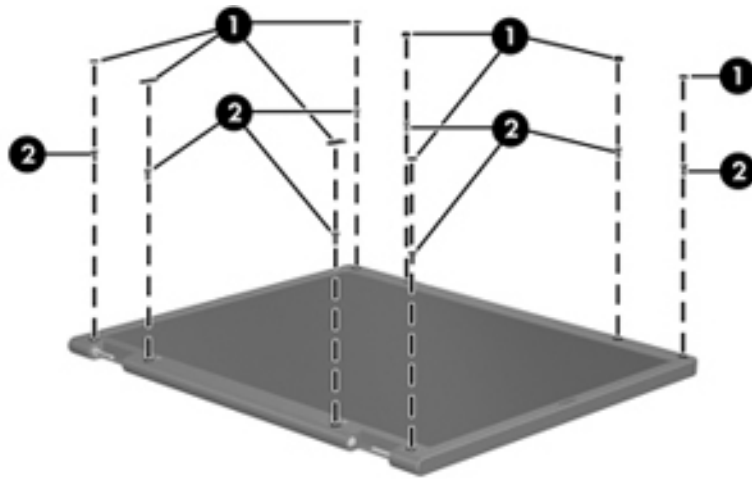

2. Lift up and out on the left and right inside edges ① and the top and bottom inside edges ② of the display bezel until the bezel disengages from the display assembly.
3. Remove the display bezel ③.

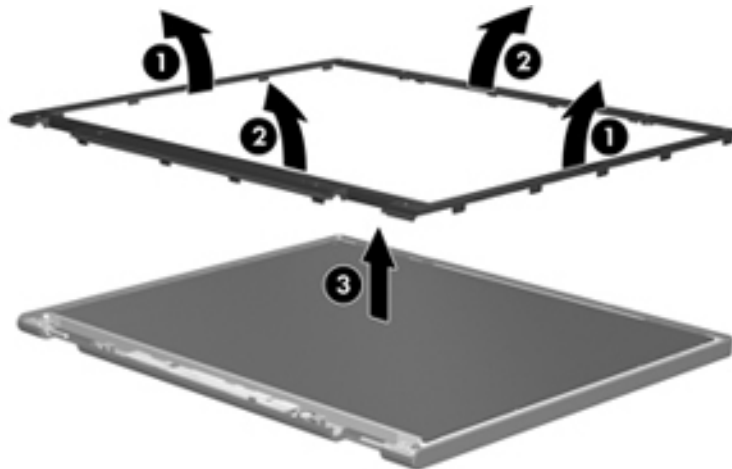

4. Disconnect all display panel cables ❶ from the display inverter and remove the inverter ❷.

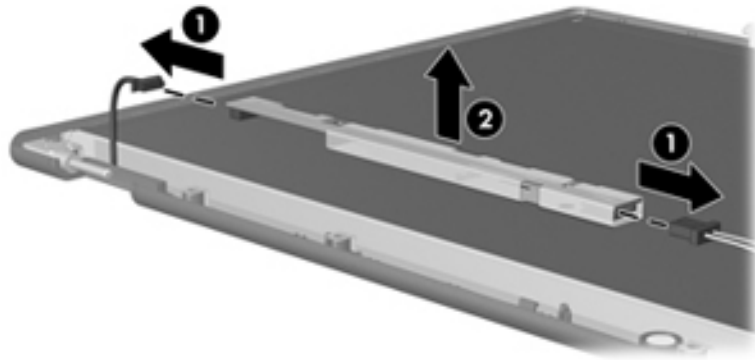

5. Remove all screws ❶ that secure the display panel assembly to the display enclosure.

6. Remove the display panel assembly ❷ from the display enclosure.

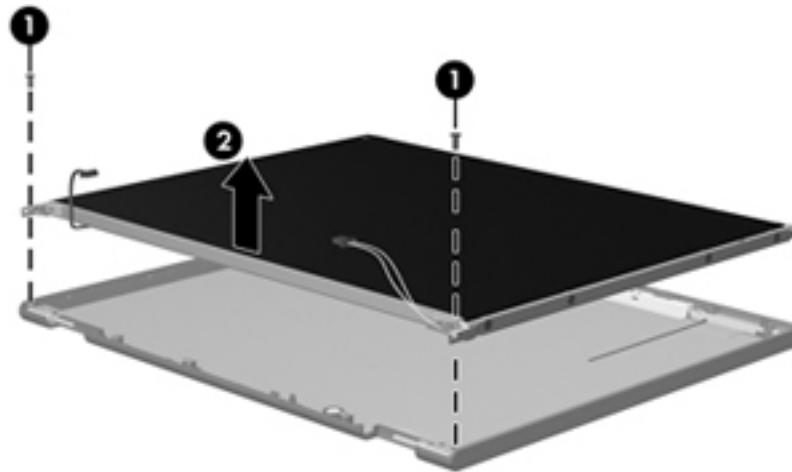

7. Turn the display panel assembly upside down.

8. Remove all screws that secure the display panel frame to the display panel.

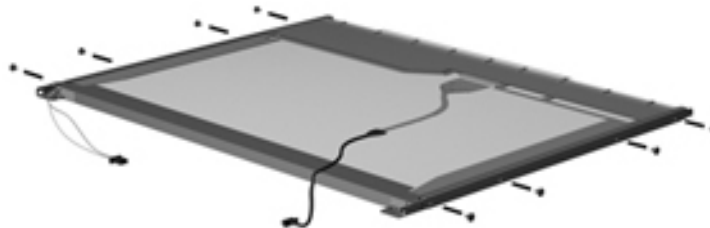

9. Use a sharp-edged tool to cut the tape ❶ that secures the sides of the display panel to the display panel frame.
10. Remove the display panel frame ❷ from the display panel.

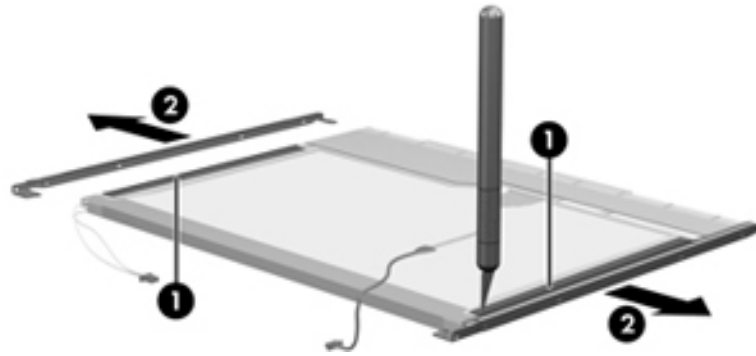

11. Remove the screws ❶ that secure the backlight cover to the display panel.
12. Lift the top edge of the backlight cover ❷ and swing it outward.

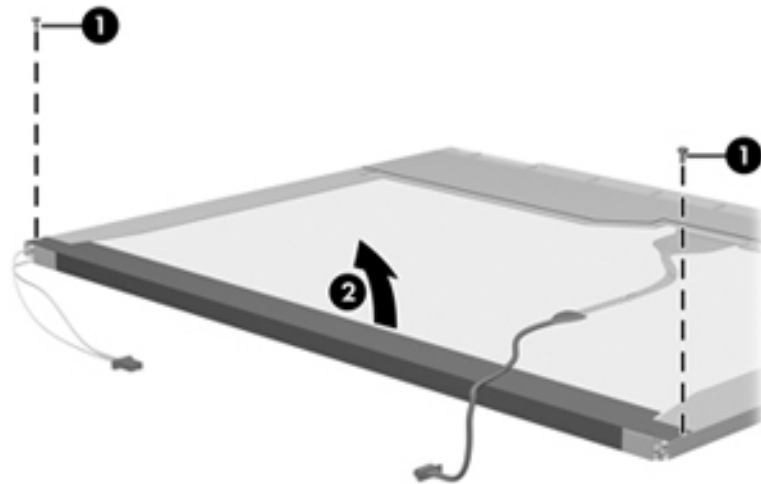

13. Remove the backlight cover.
14. Turn the display panel right-side up.
15. Remove the backlight cables ❶ from the clip ❷ in the display panel.

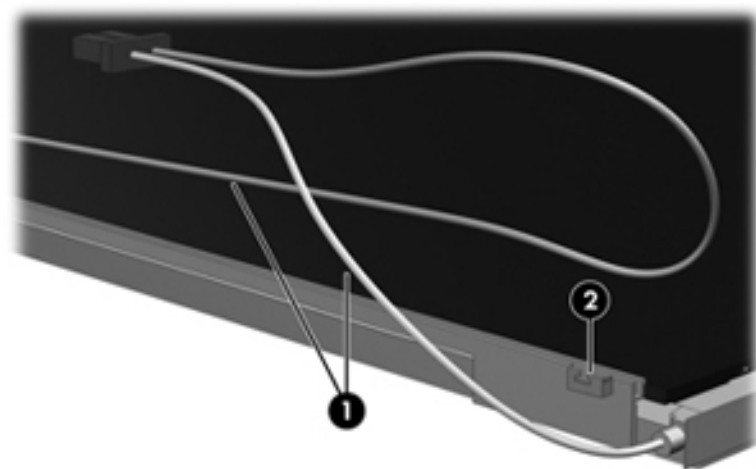

16. Turn the display panel upside down.
17. Remove the backlight frame from the display panel.

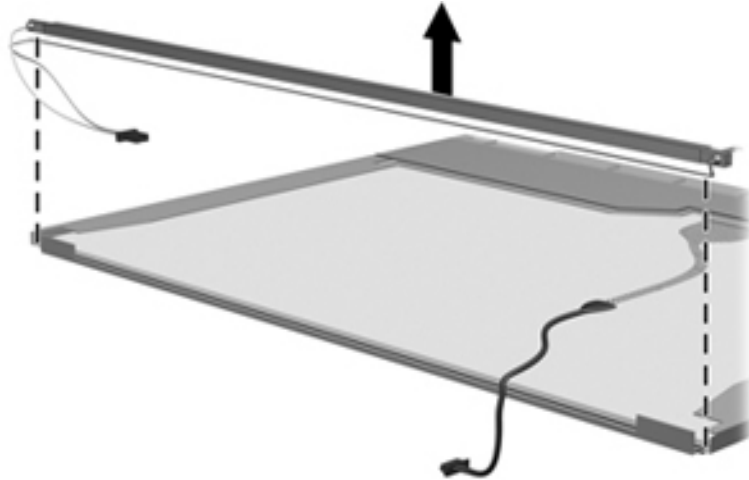

WARNING: The backlight contains mercury. Exercise caution when removing and handling the backlight to avoid damaging this component and causing exposure to the mercury.

18. Remove the backlight from the backlight frame.

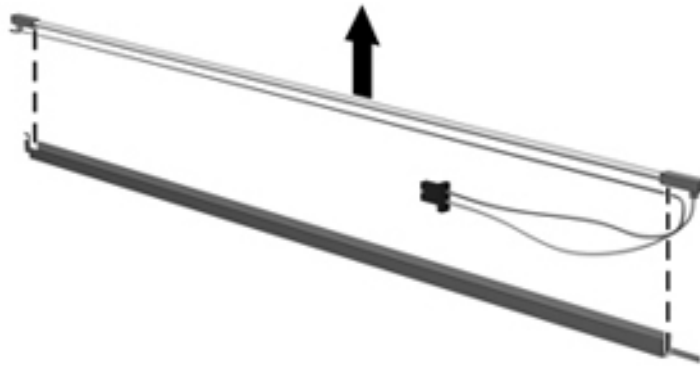

- 19. Disconnect the display cable ❶ from the LCD panel.
- 20. Remove the screws ❷ that secure the LCD panel to the display rear panel.
- 21. Release the LCD panel ❸ from the display rear panel.
- 22. Release the tape ❹ that secures the LCD panel to the display rear panel.

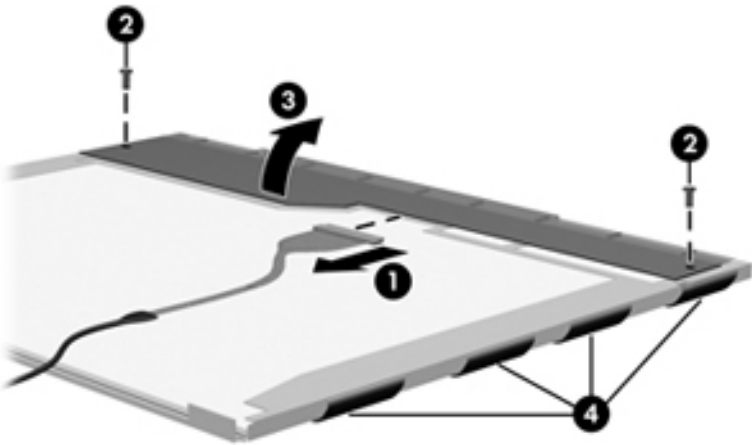

- 23. Remove the LCD panel.

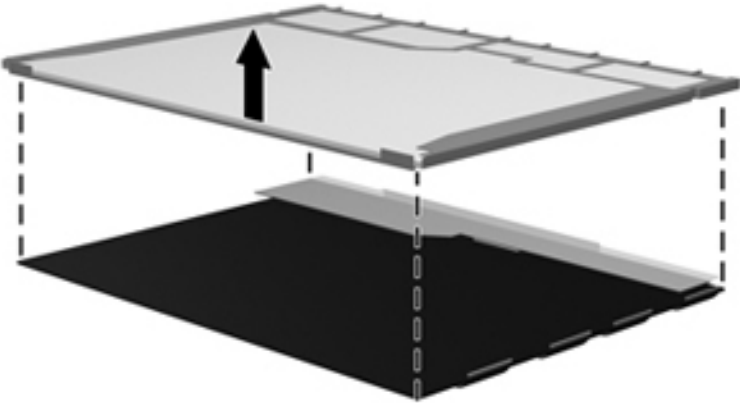

- 24. Recycle the LCD panel and backlight.

A

- AC adapter light 2–7
- AC adapters
 - product description 1–5
 - spare part numbers 3–13
- antenna
 - components 2–1
 - disconnecting 4–16
 - location 4–16
 - spare part number 2–1, 3–3, 3–16, 3–19
- audio, product description 1–4
- audio-in jack
 - location 2–6
 - pin assignments 9–1
- audio-out jack
 - location 2–6
 - pin assignments 9–1
- B**
- backing up 8–1, 8–2
- backup
 - files and folders 8–2
 - hard drive 8–2
 - scheduling 8–2
- base enclosure, spare part number 3–6
- battery
 - removal 4–7
 - spare part number 3–6
- battery bay 2–8
- battery light 2–2, 2–6
- battery release latch 2–8
- BIOS administrator password 5–3
- Bluetooth module
 - removal 4–35
 - spare part number 4–35
- Bluetooth module cable 3–17
 - removal 4–35
 - spare part number 3–6, 3–17
- Blu-ray disc specifications 6–4
- Blu-ray ROM DVD±RW SuperMulti DL Drive
 - product description 1–4
 - removal 4–9
 - spare part number 4–8
 - specifications 6–4
- boot options 5–4
- boot order 5–4
- bottom components 2–8

- built-in device
 - Bluetooth device radio 2–8
 - modem 1–4
 - wireless button 2–3
 - WLAN device radio 2–8
- buttons
 - power 2–3
 - wireless 2–3

C

- cables, service consideration 4–1
- caps lock light 2–2
- chipset, product description 1–2
- CMOS clearing 4–4
- components
 - antenna 3–10
 - bottom 2–8
 - buttons 2–3
 - display 2–1
 - front 2–6
 - keys 2–4
 - left-side 2–7
 - lights 2–2
 - rear 2–6
 - right-side 2–7
 - top 2–1
 - TouchPad 2–5
 - wireless antennae 2–1
- computer feet
 - locations 4–6
 - spare part number 4–6
- computer specifications 6–1
- connectors
 - power 2–7
 - service consideration 4–1
- creating recovery discs 8–1
- creating recovery points 8–3
- D**
- Diagnostics menu 5–4
- Digital Media Slot 2–7
- display assembly
 - removal 4–24
 - spare part number 3–3, 3–16, 3–19, 4–23
- display bezel 3–9
 - removal 4–25
 - spare part number 3–9

- display component recycling 11–1
- display hinges
 - removal 4–25, 4–27
 - spare part number 3–9, 3–15, 4–27
- display inverter, spare part number 3–9, 3–15
- Display Rubber Kit, spare part number 3–10, 3–15, 4–25
- display specifications 6–2
- drive light 2–2, 2–6
- DVD±RW and CD-RW SuperMulti Double-Layer Combo Drive
 - precautions 4–2
 - product description 1–4
 - removal 4–9
 - spare part number 3–8, 3–12, 3–18, 4–8
 - specifications 6–3
- DVD±RW and CD-RW SuperMulti Double-Layer Combo Drive with LightScribe
 - product description 1–4
 - removal 4–9
 - spare part number 3–12, 4–8
 - specifications 6–4

E

- electrostatic discharge 4–2
- esc** key 2–4
- Ethernet, product description 1–4
- external media cards, product description 1–5
- external monitor port
 - location 2–7
 - pin assignments 9–2

F

- f11 recovery 8–4
- factory state, recovering to 8–1
- fan
 - removal 4–41
 - spare part number 3–4, 3–15, 4–41
- feet
 - locations 4–6
 - spare part number 4–6
- fn** key 2–4
- front components 2–6
- function keys 2–4

G

- graphics, product description 1–2, 1–3
- grounding equipment 4–4

H

- hard drive
 - precautions 4–2
 - product description 1–4
 - removal 4–10
 - spare part number 3–6, 3–12, 4–10
 - specifications 6–2
- hard drive backup 8–2
- hard drive bay 2–8
- hard drive bracket, removal 4–11
- hard drive cover
 - illustration 3–4, 3–11
 - removal 4–10
 - spare part number 3–11
- HDMI port
 - location 2–7
 - pin assignments 9–3
 - product description 1–5
- headphone jack
 - location 2–6
 - pin assignments 9–1
- heat sink
 - removal 4–41
 - spare part number 3–4, 3–15, 4–41
- hinges
 - removal 4–25
 - spare part number 3–9

I

- I/O address specifications 6–6
- internal display switch 2–1
- interrupt specifications 6–5

J

- jacks
 - audio-in 2–6
 - audio-out 2–6
 - headphones 2–6
 - microphone 2–6
 - modem 2–7
 - network 2–7
 - RJ-11 2–7
 - RJ-45 2–7

K

- key components 2–4
- keyboard
 - product description 1–5
 - removal 4–18
 - spare part number 3–3, 3–17, 4–17
- keyboard cover
 - removal 4–20
 - spare part number 3–4, 4–20
- keypad keys 2–4
- keys
 - esc** 2–4
 - fn** 2–4
 - function 2–4
 - keypad 2–4
 - Windows applications 2–4
 - Windows logo 2–4

L

- LAN Power Saving 5-4
- language, changing in Setup Utility 5-1
- left-side components 2-7
- lights
 - AC adapter 2-7
 - battery 2-2
 - caps lock 2-2
 - drive 2-2
 - num lock 2-2
 - optical drive 2-7
 - power 2-2
 - TouchPad 2-2, 2-5
 - wireless 2-2

M

- Main menu 5-3
- mass storage devices, spare part number 3-12
- media cards, supported 2-7
- memory map specifications 6-7
- memory module
 - compartment 2-8
 - product description 1-3
 - removal 4-13
 - spare part numbers 3-6, 4-13
- memory module compartment cover
 - illustration 3-4, 3-11
 - removal 4-13
 - spare part number 3-11
- microphone
 - location 2-1
 - product description 1-4
- microphone jack
 - location 2-6
 - pin assignments 9-1
- model name 1-1, 3-1
- modem jack
 - location 2-7
 - pin assignments 9-4
- modem module, product description 1-4
- monitor port
 - location 2-7
 - pin assignments 9-2

N

- network jack
 - location 2-7
 - pin assignments 9-4
- num lock light 2-2

O

- operating system, product description 1-6
- optical drive
 - location 2-7
 - precautions 4-2
 - product description 1-4
 - removal 4-9
 - spare part number 3-8, 3-12, 4-7, 4-8
 - specifications 6-3, 6-4
- optical drive light 2-7

P

- packaging guidelines 4-3
- panel, product description 1-3
- password clearing 4-4
- pin assignments
 - audio-in 9-1
 - audio-out 9-1
 - HDMI 9-3
 - headphone 9-1
 - headphone jack 2-6
 - microphone 9-1
 - microphone jack 2-6
 - modem 9-4
 - monitor port 9-2
 - network 9-4
 - RJ-11 2-7, 9-4
 - RJ-45 9-4
 - USB 9-5
- plastic parts 4-1
- Plastics Kit
 - contents 3-11
 - spare part number 3-4, 3-15
- ports
 - HDMI 2-7
 - monitor 2-7
 - product description 1-5
 - USB 2-7
- power button 2-3
- power button board
 - removal 4-22
 - spare part number 3-4, 4-22
- power cord
 - set requirements 10-1
 - spare part number 3-13, 3-16
- power lights 2-2
- processor
 - product description 1-1, 1-2
 - removal 4-45
 - spare part number 3-5, 4-44
- product description
 - audio 1-4
 - chipset 1-2
 - Ethernet 1-4
 - external media cards 1-5
 - graphics 1-2
 - hard drives 1-4
 - keyboard 1-5
 - memory module 1-3
 - microphone 1-4
 - modem module 1-4

- operating system 1–6
- optical drives 1–4
- panel 1–3
- ports 1–5
- power requirements 1–5
- processors 1–1
- product name 1–1
- security 1–5
- serviceability 1–6
- TouchPad 2–5
- video 2–7
- webcam 1–4
- wireless 1–4
- product name 1–1, 3–1

R

- rear components 2–6
- recovery methods
 - f11 recovery 8–4
 - recovery discs 8–4
 - Recovery Manager 8–3
- recovery partition 8–4
- removal/replacement
 - preliminaries 4–1
 - procedures 4–5
- restore points 8–3
- restoring factory settings 5–2
- right-side components 2–7
- RJ-11 (modem) jack
 - location 2–7
 - pin assignments 9–4
- RJ-45 (network) jack
 - location 2–7
 - pin assignments 9–4
- RTC battery
 - removal 4–12
 - spare part number 3–6, 3–19, 4–12
- Rubber Feet Kit, spare part number 3–6, 3–15

S

- scheduling backups 8–2
- Screw Kit
 - contents 3–13
 - spare part number 3–10, 3–15, 7–1
- screw listing 7–1
- security cable slot 2–7
- Security menu
 - BIOS administrator password 5–3
 - Power-On password 5–3
- security, product description 1–5
- serial number 3–1, 4–5
- serviceability, product description 1–6

- Setup Utility
 - accessing 5–1
 - changing the language 5–1
 - Diagnostics menu 5–4
 - displaying system information 5–2
 - exiting 5–3
 - Main menu 5–3
 - navigating and selecting 5–2
 - restoring default settings 5–2
 - System Configuration menu 5–4
- speaker
 - removal 4–36
 - spare part number 3–5, 3–17, 4–36
- specifications
 - Blu-ray ROM DVD±RW SuperMulti DL Drive 6–4
 - display 6–2
 - DVD±RW and CD-RW SuperMulti Double-Layer Combo Drive 6–3
 - DVD±RW and CD-RW SuperMulti Double-Layer Combo Drive with LightScribe 6–4
 - hard drive 6–2
 - I/O addresses 6–6
 - interrupts 6–5
 - memory map 6–7
 - system DMA 6–5
- system backup 8–1
- system board
 - removal 4–39
 - spare part number 3–4
- System Configuration menu 5–4
- system information 5–2, 5–3
- system memory map 6–7
- system recovery points 8–2

T

- thermal material 4–42
- thermal module
 - removal 4–41
 - spare part number 4–41
- tools required 4–1
- top components 2–1
- top cover
 - removal 4–30
 - spare part number 3–4, 4–30
- TouchPad board bracket
 - removal 4–33
 - spare part number 3–4
- TouchPad button board
 - removal 4–32
 - spare part number 3–4, 4–32
- TouchPad light 2–2, 2–5
- TouchPad on/off button 2–5
- TouchPad scroll zone 2–5
- TouchPad, location 2–5

U

- unknown password 4-4
- USB port
 - location 2-7
 - pin assignments 9-5
- user replaceable parts 1-6

V

- vents 2-6, 2-8
- video, product description 2-1
- volume keys 2-4

W

- warranty period 3-1
- webcam
 - location 2-1
 - product description 1-4
 - removal 4-27
 - spare part number 3-9
- webcam light 2-1
- Windows application keys 2-4
- Windows logo key 2-4
- wireless antenna
 - disconnecting 4-24
 - location 2-1
 - spare part number 3-10
- Wireless Antenna Kit, spare part number 3-10
- wireless button 2-3
- wireless compartment cover
 - illustration 3-4, 3-11
 - removal 4-15
 - spare part number 3-11
- wireless light 2-2
- wireless module compartment 2-8
- wireless, product description 1-4, 1-5
- WLAN module compartment cover
 - illustration 3-4, 3-11
 - removal 4-15
 - spare part number 3-11
- WLAN modules
 - removal 4-16
 - spare part number 3-7, 3-8
- workstation guidelines 4-3