



## HP Photosmart 7510 Series

---

# Contents

<b>1</b>	<b>HP Photosmart 7510 Series Help</b>	<b>3</b>
<b>2</b>	<b>Get to Know the HP Photosmart</b>	
	Printer parts	5
	Control panel features	6
	Tips for getting to know the printer	7
<b>3</b>	<b>How do I?</b>	<b>9</b>
<b>4</b>	<b>Print</b>	
	Print photos from a memory card	11
	Select Print Media	13
	Load media	13
	Recommended papers for photo printing	15
	Recommended papers for printing and copying	16
	Tips for print success	17
<b>5</b>	<b>Copy and scan</b>	
	Scan to a computer or memory card	19
	Copy text or mixed documents	20
	Tips for copy and scan success	22
<b>6</b>	<b>Use Web Services</b>	
	Print with HP ePrint	23
	Use Print Apps	24
	Visit the HP ePrintCenter website	24
<b>7</b>	<b>Send and receive faxes with eFax</b>	
	Set up the printer for faxing (required)	25
	Send a fax	26
	Receive a fax	26
	Fax Settings	26
	Fax Issues and Questions	26
<b>8</b>	<b>Work with cartridges</b>	
	Check the estimated ink levels	27
	Clean printhead automatically	27
	Clean ink smear	27
	Replace the cartridges	28
	Order ink supplies	30
	Cartridge warranty information	30
	Tips for working with ink	31
<b>9</b>	<b>Solve a problem</b>	
	Get more help	33
	Register the product	33
	Clear the paper jam from the two-sided printing accessory	33
	Clear the paper jam from the automatic document feeder	34
	Clear carriage jam	34
	Solve print problem	35
	Solve copy and scan problem	35
	Solve networking problem	35
	HP support by phone	35
	Additional warranty options	36
	Cartridge supply upgrade	36
	Prepare printer	37

Check cartridge access door.....	37
Printhead failure.....	37
Printer failure.....	37
Ink cartridge problem.....	37
SETUP cartridges.....	39
<b>10 Connectivity</b>	
Add the HP Photosmart to a network.....	41
Change from a USB connection to a wireless network.....	42
Connect a new printer.....	43
Change network settings.....	43
Tips for setting up and using a networked printer.....	43
Advanced printer management tools (for networked printers).....	44
<b>11 Technical information</b>	
Notice.....	45
Cartridge chip information.....	45
Specifications.....	46
Environmental product stewardship program.....	48
Regulatory notices.....	53
Regulatory wireless statements.....	56
<b>Index</b> .....	<b>59</b>

---

# 1 HP Photosmart 7510 Series Help

Click the links below for information about the HP Photosmart:

- [Get to Know the HP Photosmart](#)
- [How do I?](#)
- [Print](#)
- [Copy and scan](#)
- [Work with cartridges](#)
- [Send and receive faxes with eFax](#)
- [Connectivity](#)
- [Technical information](#)
- [Solve a problem](#)



## 2 Get to Know the HP Photosmart

- [Printer parts](#)
- [Control panel features](#)
- [Tips for getting to know the printer](#)

### Printer parts

- **Front view of the printer**

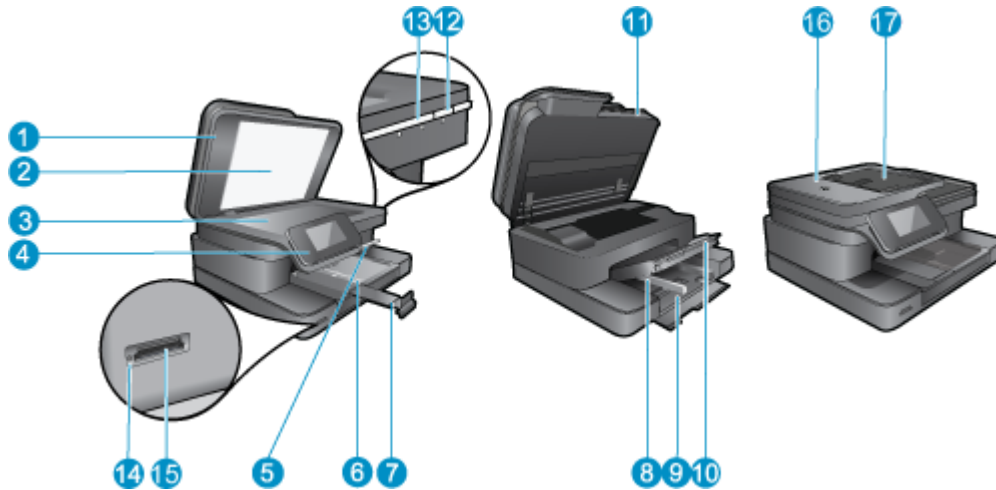

1	Lid
2	Lid Backing
3	Glass
4	Color graphics display (also referred to as the display)
5	Photo tray
6	Paper-width guide for the photo tray
7	Paper tray extender (also referred to as the tray extender)
8	Paper-width guide for the main tray
9	Main tray (also referred to as the input tray)
10	Output tray
11	Cartridge door
12	On button
13	Wireless LED
14	Memory Card slots
15	Memory Card slots LED
16	Automatic document feeder
17	Automatic document feeder tray

- **Top and rear views of the printer**

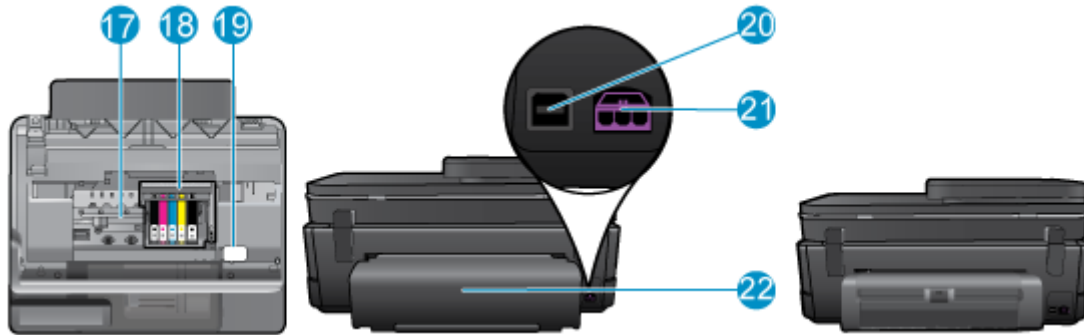

17	Cartridge access area
18	Printhead assembly
19	Model number location
20	Rear USB port
21	Power connection (Use only with the power adapter supplied by HP).
22	Two-sided printing accessory

- View the animation for this topic. Some screens that appear in the animation may not reflect your product.

## Control panel features

The touch screen display shows menus, photos, and messages. You can touch and drag your finger horizontally to scroll through photos and vertically through menu options.

---

 **NOTE:** eFax may not be available in all countries/regions.

---

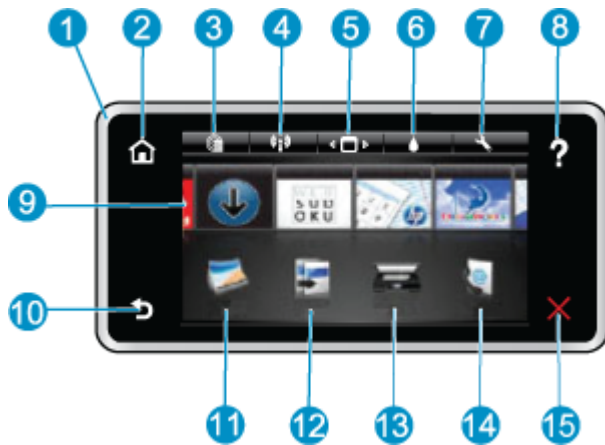

1	<b>Display:</b> The touch screen display shows menus, photos, and messages. You can flick horizontally through photos and vertically through list menus.
2	<b>Home:</b> Returns to the <b>Home</b> screen (the default screen when you turn on the product).
3	<b>Web Services:</b> Opens the <b>Web Services</b> menu, which displays status details. You can also change settings and, if Web Services is enabled, print out a report..
4	<b>Wireless Settings:</b> Opens the <b>Wireless</b> menu where you can see wireless properties and change wireless settings.
5	<b>Apps Manager:</b> Opens the <b>Manage My Favorites</b> menu where you can rearrange and remove Apps.
6	<b>Ink Levels:</b> Opens the <b>Ink Levels</b> menu showing estimated ink levels.
7	<b>Settings:</b> Opens the <b>Settings</b> menu where you can change product settings and perform maintenance functions.
8	<b>Help:</b> From the <b>Help</b> screen, lists the topics for which help is available. From other screens, provides help applicable to the current screen.
9	<b>Apps:</b> Provide quick and easy way to access and print information from the Apps, such as maps, coupons, coloring pages, and puzzles.
10	<b>Back:</b> Returns to the previous screen on the display.
11	<b>Photo:</b> Opens the <b>Photo</b> menu where you can view, edit, print, and save your photos.
12	<b>Copy:</b> Opens the <b>Copy</b> menu where you can preview your copy, edit for size and darkness, select black or color, and select the number of copies. You can also change settings to make 2-sided copies, or select size, quality, and paper type.
13	<b>Scan:</b> Opens the <b>Choose Scan Destination</b> menu, where you can select a destination for your scan.
14	<b>eFax:</b> Opens the eFax internet fax service. Send and receive faxes without fax hardware or a phone line. Internet connection and Web Services required.
15	<b>Cancel:</b> Stops the current operation.

View the animation for this topic. Some screens that appear in the animation may not reflect your product.

## Tips for getting to know the printer

Use the following tips to get to know the printer:

- Learn how to manage print apps for printing recipes, coupons, and other content from the web. [Click here to go online for more information.](#)





---

## 3 How do I?

This section contains links to commonly performed tasks, such as printing photos, scanning, and making copies.

- [Scan to a computer or memory card](#)
- [Copy text or mixed documents](#)
- [Clear the paper jam from the two-sided printing accessory.](#)
- [Replace the cartridges](#)
- [Load media](#)
- [Use Web Services](#)



# 4 Print



[Print photos from a memory card](#)

## Related topics

- [Load media](#)
- [Tips for print success](#)

## Print photos from a memory card

Do one of the following:

### Print photo on small-size paper

1. Load paper.
  - ▲ Load up to 10 x 15 cm (4 x 6 inch) photo paper print side down in photo tray.

#### Load photo paper in the photo tray



2. Insert memory device.

#### Memory cards and slots

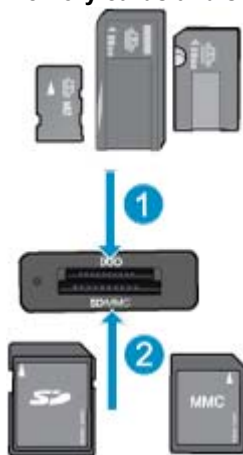

1	Memory Stick Duo or Pro Duo, Memory Stick Pro-HG Duo, or Memory Stick Micro (adapter required)
2	MultiMedia Card (MMC), MMC Plus, Secure MultiMedia Card, MMC Mobile (RS-MMC; adapter required), Secure Digital (SD), Secure Digital Mini, Secure Digital High Capacity (SDHC), Secure Digital Extended Capacity (SDXC), or TransFlash MicroSD Card (adapter required)

3. Select photo.
  - a. Touch **Photo** on the Home screen.
  - b. Touch **View & Print**.
  - c. Flick left or right to scroll through the photos.
  - d. Touch photo you want to print.
  - e. Touch up arrow to increase number of copies.
4. Print photo.
  - a. Touch **Print** to preview print job.
  - b. Touch **Print**.

**Print photo on full-size paper**

1. Load paper.
  - ▲ Load full-size photo paper print side down in the main input tray.

**Load paper**



2. Insert memory device.

**Memory cards and slots**

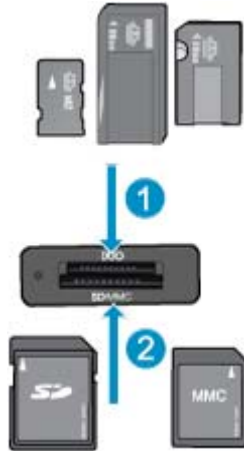

1	Memory Stick Duo or Pro Duo, Memory Stick Pro-HG Duo, or Memory Stick Micro (adapter required)
2	MultiMedia Card (MMC), MMC Plus, Secure MultiMedia Card, MMC Mobile (RS-MMC; adapter required), Secure Digital (SD), Secure Digital Mini, Secure Digital High Capacity (SDHC), Secure Digital Extended Capacity (SDXC), or TransFlash MicroSD Card (adapter required)

3. Select photo.
  - a. Touch **Photo** on the Home screen.
  - b. Touch **View & Print**.
  - c. Flick left or right to scroll through the photos.
  - d. Touch photo you want to print.
  - e. Touch up arrow to increase number of copies.

4. Change page layout.
  - a. Touch **Print** to preview print job.
  - b. Touch **Print Settings** to change print settings.
  - c. Touch **Layout**.
  - d. Touch **8.5x11**.
5. Print photo.
  - ▲ Touch **Print**.

## Select Print Media

The printer is designed to work well with most types of office media. Use HP media for optimum print quality. Visit the HP Web site at [www.hp.com](http://www.hp.com) for more information about HP media.

HP recommends plain papers with the ColorLok logo for printing and copying of everyday documents. All papers with the ColorLok logo are independently tested to meet high standards of reliability and print quality, and produce documents with crisp, vivid color, bolder blacks and dry faster than ordinary plain papers. Look for papers with the ColorLok logo in a variety of weights and sizes from major paper manufacturers.

To purchase HP papers, go to [Shop for Products and Services](#) and select ink, toner and paper.

## Load media

1. Do one of the following:

### Load 10 x 15 cm (4 x 6 inch) paper

- a. Raise photo tray lid.
  - Raise photo tray lid and slide paper-width guide outwards.
- b. Load paper.
  - Insert stack of photo paper into photo tray with short edge forward and print side down.



- Slide stack of paper forward until it stops.

---

 **NOTE:** If the photo paper you are using has perforated tabs, load photo paper so that tabs are closest to you.

---

- Slide paper-width guide inward until it stops at edge of paper.



- c. Lower photo tray lid.



**Load A4 or 8.5 x 11 inch paper**

- a. Raise the photo tray.
  - Slide paper-width guide outwards.



- Remove all paper from the main input tray.
- b. Load paper.
  - Insert stack of paper into main input tray with short edge forward and print side down.



- Slide stack of paper forward until it stops.
- Slide paper-width guide inward until it stops at edge of paper.



- Lower the photo tray.

**Load envelopes**

- a. Raise the photo tray.
  - Slide paper-width guide outwards.



- Remove all paper from the main input tray.
- b. Load envelopes.**
  - Insert one or more envelopes into far-right side of main input tray, with envelope flaps on left and facing up.



- Slide stack of envelopes forward until it stops.
- Slide paper-width guide inward against stack of envelopes until it stops.



- Lower the photo tray.
- 2.** View the animation for this topic. Some screens that appear in the animation may not reflect your product.

#### Related topics

- [Tips for print success](#)

## Recommended papers for photo printing

If you want the best print quality, HP recommends using HP papers that are specifically designed for the type of project you are printing. Depending on your country/region, some of these papers might not be available.

Paper	Description
<b>HP Premium Plus Photo Paper</b>	HP's best photo paper is heavyweight for producing professional-quality photos. Features an instant-dry finish for easy handling without smudging. It resists water, smears, fingerprints, and humidity. It is available in several sizes, including A4, 8.5 x 11 inch, 10 x 15 cm (4 x 6 inch), 13 x 18 cm



Paper	Description
	(5 x 7 inch) and two finishes – high gloss or soft gloss (satin matte). It is acid-free for longer lasting documents.
<b>HP Advanced Photo Paper</b>	This thick photo paper features an instant-dry finish for easy handling without smudging. It resists water, smears, fingerprints, and humidity. Your prints have a look and feel comparable to a store processed photo. It is available in several sizes, including A4, 8.5 x 11 inch, 10 x 15 cm (4 x 6 inch), 13 x 18 cm (5 x 7 inch) and two finishes – glossy or soft gloss (satin matte). It is acid-free for longer lasting documents.
<b>HP Everyday Photo Paper</b>	Print colorful, everyday snapshots at a low cost, using paper designed for casual photo printing. This affordable, photo paper dries quickly for easy handling. Get sharp, crisp images when you use this paper with any inkjet printer. Available in glossy finish in 8.5 x 11 inch, A4, 4 x 6 inch and 10 x 15 cm. It is acid-free for longer lasting documents.
<b>HP Photo Value Packs</b>	HP Photo Value Packs conveniently package Original HP ink cartridges and HP Advanced Photo Paper to save you time and take the guesswork out of printing affordable Lab-quality photos with your HP printer. Original HP inks and HP Advanced Photo Paper have been designed to work together so your photos are long lasting and vivid, print after print. Great for printing out an entire vacation's worth of photos or multiple prints to share.

## Recommended papers for printing and copying

Depending on your country/region, some of these papers might not be available.

Paper	Description
<b>HP Brochure Paper and HP Professional Paper 180gsm</b>	These papers are glossy-coated or matte-coated on both sides for two-sided use. They are the best choice for producing professional-quality marketing materials such as brochures and mailers as well as business graphics for report covers and calendars.
<b>HP Premium Presentation 120gsm Paper and HP Professional Paper 120gsm</b>	These papers are heavy two-sided matte papers perfect for presentation, proposals, reports and newsletters. They are a professional weight for an impressive look and feel.
<b>HP Bright White Inkjet Paper</b>	HP Bright White Inkjet Paper delivers high-contrast colors and sharp text. It is opaque enough for two-sided color usage with no showthrough, which makes it ideal for newsletters, reports, and flyers. It features ColorLok Technology for less smearing, bolder blacks and vivid colors.
<b>HP Printing Paper</b>	HP Printing Paper is a high-quality multifunction paper. It produces documents that look and feel more substantial than documents printed on standard multipurpose or copy paper. It features ColorLok Technology for less smearing, bolder blacks and vivid colors.
<b>HP Office Paper</b>	HP Office Paper is a high-quality multifunction paper. It is suitable for copies, drafts, memos and other everyday documents. It features ColorLok Technology for less smearing, bolder blacks and vivid colors.
<b>HP Office Recycled Paper</b>	HP Office Recycled Paper is a high-quality multifunction paper made with 30% recycled fiber. It features ColorLok Technology for less smearing, bolder blacks and vivid colors.
<b>HP Iron-On Transfers</b>	HP Iron-on Transfers (for color fabrics or for light or white fabrics) are the ideal solution for creating custom T-shirts from your digital photos.

---

 **NOTE:** Learn more about paper types that support 2-sided printing on your printer. [Click here to go online for more information.](#)

---

## Tips for print success

Use the following tips to print successfully.

### Print tips

- Use genuine HP cartridges. Genuine HP cartridges are designed for and tested with HP printers to help you produce great results, time after time.
- Make sure the cartridges have sufficient ink. To check the estimated ink levels, touch the Ink Levels icon on the printer display.
- Load a stack of paper, not just one page. Use clean and flat paper of the same size. Make sure only one type of paper is loaded at a time.
- Adjust the paper-width guide in the input tray to fit snugly against all paper. Make sure the paper-width guide does not bend the paper in the input tray.
- Set the print quality and paper size settings according to the type and size of paper loaded in the input tray.
- Use print preview to check margins. Do not let the margin settings for the document exceed the printable area of the printer.
- Learn how to share your photos online and order prints. [Click here to go online for more information.](#)
- Learn how to print documents from computer. [Click here to go online for more information.](#)
- Learn how to print photos saved on your computer. Learn about print resolution and how to set the maximum DPI. [Click here to go online for more information.](#)
- Learn how to print envelopes from computer. [Click here to go online for more information.](#)
- Learn more about managing apps for printing recipes, coupons, and other content on the HP ePrintCenter website. [Click here to go online for more information.](#)
- Learn how to print from anywhere by sending an email and attachments to your printer. [Click here to go online for more information.](#)



## 5 Copy and scan

- [Scan to a computer or memory card](#)
- [Copy text or mixed documents](#)
- [Tips for copy and scan success](#)

### Scan to a computer or memory card

To scan to a computer or memory card from the printer display

1. Load original.
  - a. Lift lid on the product.



- b. Load original print side down on the right front corner of glass.

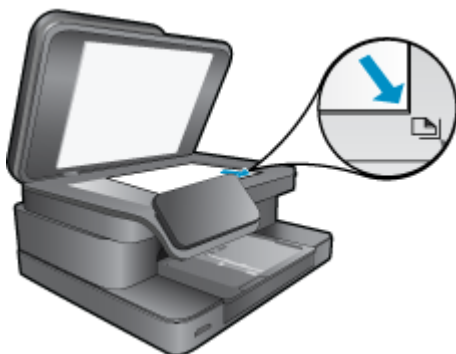

- c. Close lid.
2. To scan to a memory card, insert a memory card in the memory card slot.  
If you want to scan to a computer, make sure the printer is connected to your computer on a wireless network or through a USB cable.
  3. Start scan.
    - a. From the Home screen, touch **Scan**.
    - b. Select the destination by touching either **Computer** or **Memory Card**.  
To scan to a computer, select the computer, and then select a scan type to start the scan. If your computer is not listed, touch **Not listed** for further information.
  4. View the animation for this topic. Some screens that appear in the animation may not reflect your product.

**Related topics**

- [Tips for copy and scan success](#)

## Copy text or mixed documents

1. Do one of the following:

**1-sided copy**

- a. Load paper.

- Load full-size paper in the main input tray.



- b. Load original.

- Lift lid on product.



- Load original print side down on right front corner of glass.

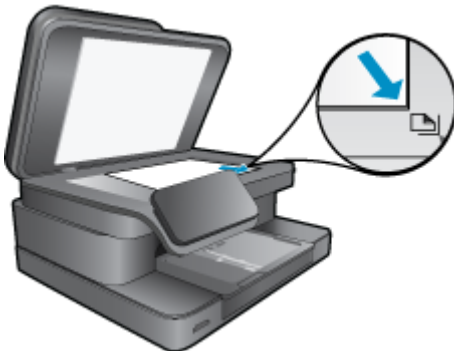

- Close lid.

- c. Specify number of copies.
  - Touch **Copy** on Home screen.  
The **Copy** preview appears.
  - Touch the screen to set the number of copies.
- d. Start copy.
  - Touch **B&W** or **Color**.

**2-sided copy**

- a. Load paper.
  - Load full-size paper in the main input tray.



- b. Load original.
  - Lift lid on product.



- Load original print side down on right front corner of glass.

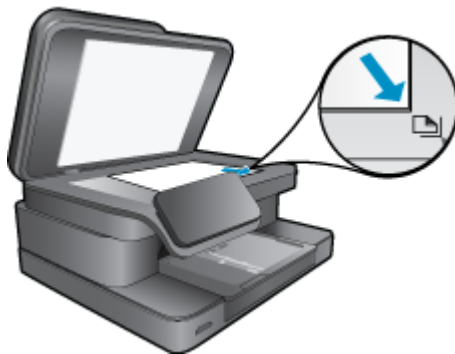

- Close lid.

- c. Specify 2-sided option.
    - Touch **Copy** on Home screen.  
The **Copy** preview appears.
    - Touch **Print Settings**.  
The **Copy Settings** menu appears.
    - Touch **2-Sided**.
    - Touch **On**.
  - d. Specify number of copies.
    - Use the touch screen to set the number of copies.
  - e. Start copy.
    - Touch **B&W** or **Color**.
  - f. Copy the second original.
    - Load second page on the glass and touch **OK**.
2. View the animation for this topic. Some screens that appear in the animation may not reflect your product.

#### Related topics

- [Tips for copy and scan success](#)

Learn more about using the automatic document feeder to scan your documents. [Click here to go online for more information.](#)

## Tips for copy and scan success

Use the following tips to copy and scan successfully:

- Keep the glass and the back of the lid clean. The scanner may interpret anything it detects on the glass as part of the image.
- Load your original, print side down, on the right front corner of the glass.
- If you have a wireless connection and you have confirmed that the connection is working, you will need to enable wireless scanning in the software to scan from the printer display. Open the Printer Software to select **Scanner Actions** and then select **Manage Scan to Computer**.
- To make a large copy of a small original, scan the original into the computer, resize the image in the scanning software, and then print a copy of the enlarged image.
- To avoid incorrect or missing scanned text, make sure the brightness is set appropriately in the software.
- If the document to be scanned has a complex layout, select framed text as the scan document setting in the software. With this setting, the text layout and formatting are retained.
- If the scanned image is incorrectly cropped, turn off the autocropping feature in the software and crop the scanned image manually.

---

## 6 Use Web Services

- [Print with HP ePrint](#)
- [Use Print Apps](#)
- [Visit the HP ePrintCenter website](#)

### Print with HP ePrint

HP's free ePrint service provides an easy way to print from email. Just email a document or photo to the email address assigned to your printer when you enable Web Services, and both the email message and recognized attachments will print.

- Your printer needs to have a wireless network connection to the Internet. You won't be able to use ePrint via a USB connection to a computer.
- Attachments might print differently from the way they appear in the software program that created them, depending on the original fonts and layout options used.
- Free product updates are provided with ePrint. Some updates might be required to enable certain functionality.

#### Related topics

- [Your printer is protected](#)
- [How to get started with ePrint](#)

### Your printer is protected

To help prevent unauthorized email, HP assigns a random email address to your printer, never publicizes this address, and by default does not respond to any sender. ePrint also provides industry-standard spam filtering and transforms email and attachments to a print-only format to reduce the threat of virus or other harmful content. However, the ePrint service does not filter email based on content, so it cannot prevent objectionable or copyrighted material from being printed.

Go to the HP ePrintCenter website for more information and specific terms and conditions: [www.hp.com/go/ePrintCenter](http://www.hp.com/go/ePrintCenter).

### How to get started with ePrint

To use ePrint, you first need to connect your printer wirelessly to a network and enable Web Services. You also need to create an ePrintCenter account if you do not already have one.

#### To get started with ePrint

1. Turn on wireless radio to connect wirelessly to a network.
  - a. Touch the **Wireless** button on the control panel to check the wireless status. If it shows **Connected**, and details like IP address and network name appears, the printer has connected wirelessly to the network.
  - b. If it shows **Wireless Off**, touch **Turn On**, and then the printer will try to connect wirelessly to a network. If you haven't set up the wireless network connection before, follow the prompts on the screen to set up wireless network connection.
2. Enable Web services.
  - a. Touch **ePrint** on the home screen to display **Web Services Settings**.
  - b. If the Web services are not already enabled, touch **Enable Web Services**. If the **No Internet Connection** screen is prompted, touch **Retry** or **Enter Proxy** to configure Web proxy settings.
3. On the **Web Services Settings** menu, touch **Turn ePrint On**.
4. Touch **ePrint** on the control panel. On the **Web Services Summary** screen, get your printer's email address.



5. Compose and send email to your printer's email address from your computer or mobile device, anywhere and anytime. Both the email message and recognized attachments will print.
6. View the animation for this topic. Some screens that appear in the animation may not reflect your product.

## Use Print Apps

The enhanced HP Touchsmart display makes it easy to browse and print your favorite web content without a PC. Choose from a wide variety of Apps or create your own.

Learn how to use Print Apps at the [HP ePrintCenter](#).

## Manage apps

Print pages from the web, without using a computer, by setting up **Print Apps**, a free service from HP. You can print coloring pages, calendars, puzzles, recipes, maps, and more, depending on the apps available in your country/region.

Touch the **Get More** icon on the **Print Apps** screen to connect to the Internet and add more apps. You need to have web services enabled in order to use apps.

Go to the HP ePrintCenter website for more information and specific terms and conditions: [www.hp.com/go/ePrintCenter](http://www.hp.com/go/ePrintCenter).

---

 **NOTE:** Apps are offered on an availability basis to HP Photosmart 7510 Series series owners. HP and its third party content providers may, from time to time, make additional apps available, enhance, modify, or eliminate existing apps in accordance with our Terms of Use ([www.hp.com/go/ePrintCenter](http://www.hp.com/go/ePrintCenter)).

---

### To manage apps

1. Add apps
  - a. Touch **Print Apps** on the Home screen, and then touch the **Get More** icon.
  - b. Touch an app icon that you want to add.
  - c. Touch **Add** to confirm your adding.
2. Remove apps
  - a. Touch **Print Apps** on the Home screen, and then touch the **Get More** icon.
  - b. Touch one or more apps icons to select the apps that you want to remove.
  - c. Touch **Yes** to confirm your removing.

Removing an app from your Favorites Bar only removes it from your Home screen. You can add it again by touching **Get More**.

3. View the animation for this topic. Some screens that appear in the animation may not reflect your product.

## Visit the HP ePrintCenter website

Use HP's free ePrintCenter website to set up increased security for ePrint and specify the email addresses that are allowed to send email to your printer. You can also get Product Updates, more Print Apps, and other free services.

Go to the HP ePrintCenter website for more information and specific terms and conditions: [www.hp.com/go/ePrintCenter](http://www.hp.com/go/ePrintCenter).

# 7 Send and receive faxes with eFax

The HP Photosmart 7510 Series printer faxes without a phone line. The printer sends and receives faxes using eFax®, a web-based faxing service. This service is free when you send up to 20 pages and receive up to 20 pages per month.

If you want to send or receive more pages per month, you can upgrade to the eFax Plus® service, and your account is charged a monthly fee.

When you use eFax®, your document is scanned by the printer, sent wirelessly to the eFax® server, and then on to the receiving fax number.

To use the eFax® brand service, the printer must have an Internet connection and Web Services must be enabled so the printer can communicate with eFax's® server.

Before you can use eFax® with your printer, you must perform the simple setup procedures described below. This one-time setup allows the printer to communicate with eFax's® server using your eFax® account information whenever you send and receive faxes.

[Click here for more information about eFax®.](#)

---

 **NOTE:** eFax may not be available in all countries/regions.

---

## Set up the printer for faxing (required)

### Register with eFax®

1. Touch **eFax** on the printer Home screen to display the eFax® home screen.
2. Touch **Register**, then touch the **Web Services** checkbox to enable Web Services.
3. Create an account by following the onscreen instructions.
4. Touch **Terms and Conditions** to read the eFax® brand services agreement, then touch the **I agree** checkbox and click **OK**.
5. After connecting with the eFax® server, you are assigned the eFax® number that appears on the screen.
6. Touch **Continue**, and the eFax® home screen displays your eFax® number and a number entry keypad for sending faxes.

---

 **NOTE:** Although the area code may not be local to you, you do not incur any long-distance charges when sending and receiving faxes with this number.

---

### Set up your printer with an existing eFax® number

1. Touch **eFax** on the printer Home screen to display the eFax® home screen. Enter your existing eFax® number in the area indicated below **Already have an eFax® number?**
2. Enter the personal identification number (PIN) code for this account.

---

 **NOTE:** If you've forgotten your PIN, touch the indicated area to have it sent to the email address associated with your eFax® number.

---

3. Touch **Enable** to continue. Your eFax® number and PIN code is sent to eFax® for verification. After they are verified, your existing eFax® number is displayed on the eFax® home screen and you are ready for faxing.

---

 **NOTE:** If eFax® cannot verify the eFax® number and PIN you entered, log in to your eFax brand account at [www.efax.com](http://www.efax.com) and review your account information. You cannot fax using this number until the eFax® account information is verified on the printer.

---

4. After connecting with the eFax® server, you are assigned the eFax® number that appears on the screen.
5. Touch **OK**, and the eFax® home screen displays your eFax® number and a number entry keypad for sending faxes.

## Send a fax

### Send a Fax

1. Touch **eFax** on the printer Home screen to display the eFax® home screen.
2. Lift the printer's lid and place the first page of your original document print side down on the scanner glass, aligning it with the right front corner.
3. If you are sending the fax inside your own country, proceed to the next step. If you are sending the fax outside of your country, touch this option on the screen. This ensures that the appropriate international dialing codes are used.
4. Enter the fax number on the keypad and touch **Start**. Your document is scanned. When scanning is complete, you are asked if you have more pages to fax.
5. If you have more pages to fax, touch **Yes**, remove your first original from the scanner glass and replace it with the next one.

OR

If you do not have more pages to fax, touch **No**. Your fax is sent. Once it has been successfully sent to eFax's® server, you are notified with a message. Touch **OK** to acknowledge the message and continue.

OR

To cancel your fax, touch **Back**.

### Print a confirmation report of faxes you have sent

1. Touch **Sent Faxes** on the bottom of the screen.
2. Touch the checkbox next to the fax(es) you want included in the report.
3. Touch **Print Confirmation**.

## Receive a fax

Provide your eFax® number to anyone who needs to send you a fax.

When a fax is received, it is printed automatically.

## Fax Settings

Touch **Settings** at the bottom of the eFax® home screen to display the Fax Settings.

## Fax Issues and Questions

- For questions and answers about the eFax® brand service, touch Settings/FAQs on the eFax® home screen
- For other information about the eFax® brand service go to [www.efax.com](http://www.efax.com).
- eFax® is a registered trademark of j2 Global Communications, Inc. in the U.S. and internationally.

---

# 8 Work with cartridges

- [Check the estimated ink levels](#)
- [Clean printhead automatically](#)
- [Clean ink smear](#)
- [Replace the cartridges](#)
- [Order ink supplies](#)
- [Cartridge warranty information](#)
- [Tips for working with ink](#)

## Check the estimated ink levels

You can easily check the ink supply level to determine how soon you might need to replace a cartridge. The ink supply level shows an estimate of the amount of ink remaining in the cartridges.

 **NOTE: 1** If you have installed a refilled or remanufactured cartridge, or a cartridge that has been used in another printer, the ink level indicator might be inaccurate or unavailable.

**NOTE: 2** Ink level warnings and indicators provide estimates for planning purposes only. When you receive a low-ink warning message, consider having a replacement cartridge available to avoid possible printing delays. You do not have to replace the cartridges until the print quality is unacceptable.

**NOTE: 3** Ink from the cartridges is used in the printing process in a number of different ways, including in the initialization process, which prepares the product and cartridges for printing, and in printhead servicing, which keeps print nozzles clear and ink flowing smoothly. In addition, some residual ink is left in the cartridge after it is used. For more information, see [www.hp.com/go/inkusage](http://www.hp.com/go/inkusage).

---

### To check the ink levels from the printer display

- ▲ From the Home screen, press the **Ink Levels** icon. The estimated ink levels are displayed.

#### Related topics

- [Order ink supplies](#)
- [Tips for working with ink](#)

## Clean printhead automatically

If print quality is unacceptable, and the problem is not low ink levels or non-HP ink, try a printhead cleaning.

### To clean the printhead from the printer display

1. From the Home screen, press the **Settings** button. The **Setup Menu** is displayed.
2. In the **Setup Menu**, touch the screen to highlight **Tools**. Press **OK**.
3. Touch the screen to highlight **Clean Printhead**. Press **OK**.

#### Related topics

- [Order ink supplies](#)
- [Tips for working with ink](#)

## Clean ink smear

If printouts shows smears of ink, try cleaning ink smear from the printer display. This process takes several minutes to complete. Full-size plain paper needs to be loaded and will be moved back and forth during the cleaning. Mechanical noises are normal at this time.

**To clean ink smear from the printer display**

1. From the Home screen, touch the **Settings** icon, and then touch **Tools**.
2. On the **Tools** menu, touch the down arrow to scroll through the options, and then touch **Clean Ink Smear**.

**Related topics**

- [Order ink supplies](#)  
[Tips for working with ink](#)

## Replace the cartridges

**To replace the cartridges**

1. Check that power is on.
2. Remove cartridge.
  - a. Open cartridge access door.



Wait for print carriage to move to center of product.

- b. Press tab on cartridge, then remove it from slot.

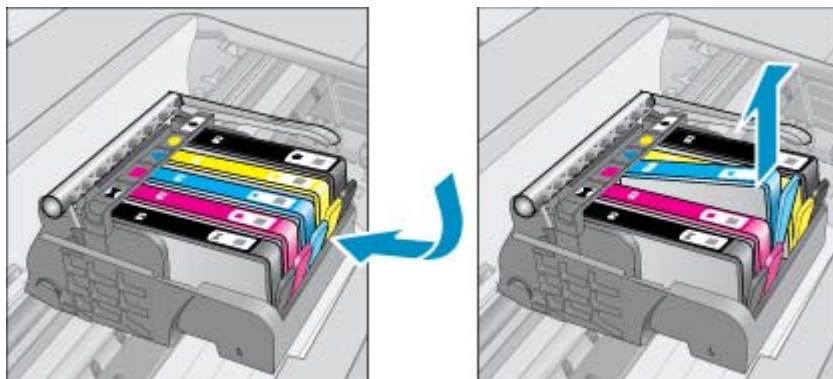

3. Insert new cartridge.
  - a. Remove cartridge from packaging.



b. Twist orange cap to snap it off. A forceful twist may be required to remove cap.



c. Match color icons, then slide cartridge into slot until it clicks into place.

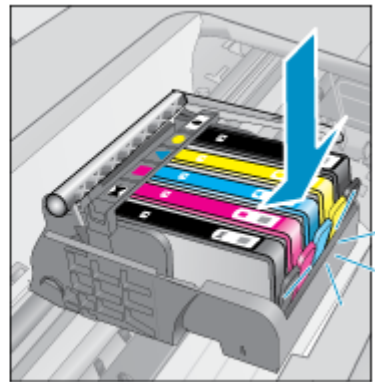
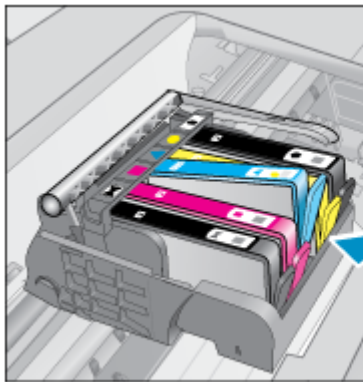

d. Close cartridge door.



4. View the animation for this topic. Some screens that appear in the animation may not reflect your product.

**Related topics**

- [Order ink supplies](#)  
[Tips for working with ink](#)

## Order ink supplies

To learn which HP supplies work with your product, order supplies online, or create a printable shopping list, open HP Solution Center, and select the online shopping feature.

Cartridge information and links to online shopping also appear on ink alert messages. In addition, you can find cartridge information and order online by visiting [www.hp.com/buy/supplies](http://www.hp.com/buy/supplies).

---

 **NOTE:** Ordering cartridges online is not supported in all countries/regions. If it is not supported in your country/region, contact a local HP reseller for information about purchasing cartridges.

---

## Cartridge warranty information

The HP cartridge warranty is applicable when the product is used in its designated HP printing device. This warranty does not cover HP ink products that have been refilled, remanufactured, refurbished, misused, or tampered with.

During the warranty period the product is covered as long as the HP ink is not depleted and the end of warranty date has not been reached. The end of warranty date, in YYYY/MM format, may be found on the product as indicated:

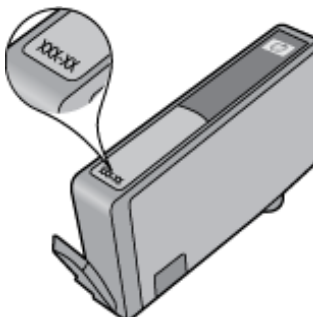

For a copy of the HP Limited Warranty Statement, see the printed documentation that came with the product.

## Tips for working with ink

Use the following tips to work with ink cartridges:

- Use the correct ink cartridges for your printer. For a list of compatible ink cartridges, see the printed documentation that came with the printer.
- Insert the ink cartridges into the correct slots. Match the color and icon of each cartridge to the color and icon for each slot. Make sure all cartridges snap down into place.
- Use genuine HP ink cartridges. Genuine HP ink cartridges are designed for and tested with HP printers to help you produce great results, time after time.
- Consider getting replacement ink cartridges when you receive an ink alert message. This avoids possible printing delays. You do not need to replace the ink cartridges until print quality becomes unacceptable.





## 9 Solve a problem

- [Get more help](#)
- [Register the product](#)
- [Clear the paper jam from the two-sided printing accessory.](#)
- [Clear the paper jam from the automatic document feeder](#)
- [Clear carriage jam](#)
- [Solve print problem](#)
- [Solve copy and scan problem](#)
- [Solve networking problem](#)
- [HP support by phone](#)
- [Additional warranty options](#)
- [Cartridge supply upgrade](#)
- [Prepare printer](#)
- [Check cartridge access door](#)
- [Printhead failure](#)
- [Printer failure](#)
- [Ink cartridge problem](#)
- [SETUP cartridges](#)

### Get more help

You can find more information and help about your HP Photosmart by entering a keyword in the **Search** field in the top left of the help viewer. Titles of related topics -- for both local and online topics -- will be listed.

To contact HP Support, [click here to go online.](#)

### Register the product

By taking just a few quick minutes to register, you can enjoy quicker service, more efficient support, and product support alerts. If you did not register your printer while installing the software, you can register now at <http://www.register.hp.com>.

### Clear the paper jam from the two-sided printing accessory.

**To clear a paper jam from the two-sided printing accessory.**

1. Turn product off.
2. Remove the two-sided printing accessory.



3. Remove jammed paper.
4. Replace two-sided printing accessory.



5. Turn on product.
6. Try printing again.
7. View the animation for this topic. Some screens that appear in the animation may not reflect your product.

If the above solutions do not resolve the problem, [click here for more online troubleshooting](#).

## Clear the paper jam from the automatic document feeder

**To clear a paper jam from the automatic document feeder**

1. Turn product off.
2. Lift automatic document feeder mechanism.



3. Remove jammed paper.
4. Close automatic document feeder.
5. Turn on product.
6. View the animation for this topic.

If the above solutions do not resolve the problem, [click here for more online troubleshooting](#).

## Clear carriage jam

Remove any objects, such as paper, that are blocking the print carriage.

---

 **NOTE:** Do not use any tools or other devices to remove jammed paper. Always use caution when removing jammed paper from inside the printer.

---

To get help from the print display, touch **Help** from the Home screen. Touch directional key to navigate through help topics, touch **Troubleshoot and Support**, and then touch **Clear Carriage Jam**.

[Click here to go online for more information.](#)

## Solve print problem

Make sure that the printer is turned on and that there is paper in the paper tray. If you are still unable to print, HP provides a Print Diagnostic Utility (Windows only) that can help solve many common “Unable to Print” issues. From the **Start** menu on your computer, click **All Programs**, and then click **HP**. Under **HP Photosmart 7510 Series**, click **HP Photosmart 7510 Series**, double-click **Print Actions**, and then double-click **HP Print Diagnostic Utility**.

[Click here to go online for more information.](#)

If print quality is not acceptable, try the following to improve print quality.

- Use printer status and print quality report to diagnose printer and print quality issues. From the Home screen, touch the **Settings** button, and then touch **Tools**. Scroll through options, and then touch **Printer Status Report** or **Print Quality Report**. [Click here to go online for more information](#)

## Solve copy and scan problem

HP provides a Scan Diagnostic Utility (Windows only) that can help solve many common “Unable to scan” issues. From the **Start** menu on your computer, click **All Programs**, and then click **HP**. Under **HP Photosmart 7510 Series**, click **HP Photosmart 7510 Series**, double-click **Scanner Actions**, and then double-click **HP Scan Diagnostic Utility**.

Learn more about how to solve scan issues. [Click here to go online for more information](#)

Learn how to solve copy issues. [Click here to go online for more information.](#)

## Solve networking problem

Check network configuration or print wireless test report to assist in diagnosing network connection issues.

### To check network configuration or print wireless test report

1. From the Home screen, touch the **Wireless** icon.
2. Do one of the following.

#### To check network configuration

- a. From the Wireless screen, touch **Settings** and then **Network**.
- b. Touch **View Network Settings**.

#### To print wireless test report

- ▲ From the Wireless screen, touch **Print Report**.

Click the links below to find more online information to solve networking issues.

- Learn more about wireless printing. [Click here to go online for more information.](#)
- Learn how to find your network security settings. [Click here to go online for more information.](#)
- Learn about the Network Diagnostic Utility (Windows only) and other troubleshooting tips. [Click here to go online for more information.](#)
- Learn how to work with your firewall and anti-virus programs during printer setup. [Click here to go online for more information.](#)

## HP support by phone

Phone support options and availability vary by product, country/region, and language.

This section contains the following topics:

- [Phone support period](#)
- [Placing a call](#)
- [After the phone support period](#)

## Phone support period

One year of phone support is available in North America, Asia Pacific, and Latin America (including Mexico). To determine the duration of phone support in Europe, the Middle East, and Africa, go to [www.hp.com/support](http://www.hp.com/support). Standard phone company charges apply.

## Placing a call

Call HP support while you are in front of the computer and the product. Be prepared to provide the following information:

- Product name (HP Photosmart 7510 Series)
- Serial number (located on the back or bottom of the product)
- Messages that appear when the situation occurs
- Answers to these questions:
  - Has this situation happened before?
  - Can you re-create it?
  - Did you add any new hardware or software to your computer at about the time that this situation began?
  - Did anything else occur prior to this situation (such as a thunderstorm, product was moved, etc.)?

For the list of support phone numbers, visit [www.hp.com/support](http://www.hp.com/support).

## After the phone support period

After the phone support period, help is available from HP at an additional cost. Help may also be available at the HP online support Web site: [www.hp.com/support](http://www.hp.com/support). Contact your HP dealer or call the support phone number for your country/region to learn more about support options.

## Additional warranty options

Extended service plans are available for the HP Photosmart at additional costs. Go to [www.hp.com/support](http://www.hp.com/support), select your country/region and language, then explore the services and warranty area for information about the extended service plans.

## Cartridge supply upgrade

If the supply upgrade is not successful, try getting your printer to recognize the supply upgrade cartridge.

### To get the printer to recognize the supply upgrade cartridge:

1. Remove the supply upgrade cartridge.
2. Insert the original cartridge in the carriage.
3. Close the cartridge access door, then wait until the carriage stops moving.
4. Remove the original cartridge, then replace with the supply upgrade cartridge.
5. Close the cartridge access door, then wait until the carriage stops moving.

If you still receive a supply upgrade problem error message, contact HP support for help.

[Click here to go online for more information.](#)

## Prepare printer

If you are not satisfied with the print quality, try cleaning the cartridges from the control panel. See [Clean printhead automatically](#) for more information.

## Check cartridge access door

The cartridge access door should be closed for printing.



[Click here to go online for more information.](#)

## Printhead failure

The printhead in this product has failed. Contact HP support for help.

[Click here to go online for more information.](#)

## Printer failure

If you have already turned the printer off and then on, and this does not solve your problem, contact HP support for help.

[Click here to go online for more information.](#)

## Ink cartridge problem

### To solve ink cartridge problem

1. Try removing and reinserting the cartridges. Make sure the cartridges are in the correct slots.
2. If reinserting the cartridges does not work, try cleaning cartridge contacts.

### To clean cartridge contacts

---

**⚠ CAUTION:** The cleaning procedure should take only a few minutes. Make sure that the ink cartridges are reinstalled in the product as soon as possible. It is not recommended to leave the ink cartridges outside of the product longer than 30 minutes. This could result in damage to both the printhead and the ink cartridges.

---

- a. Check that power is on.
- b. Open the cartridge access door.



Wait for the print carriage to move to the ink label part of the product.

- c. Press tab on the cartridge indicated in the error message, then remove it from slot.

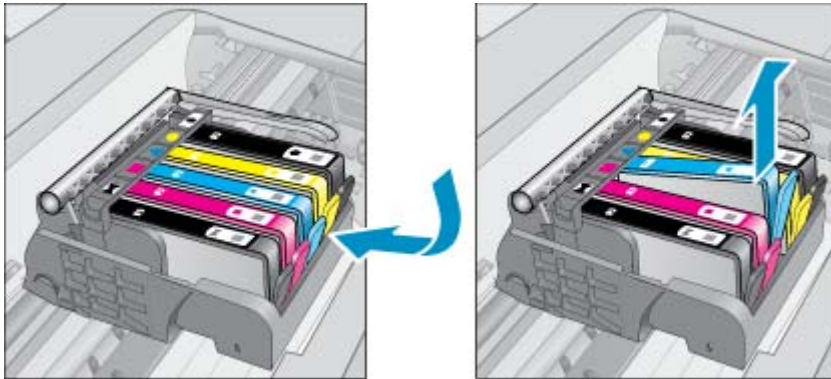

- d. Hold the ink cartridge by its sides with the bottom pointing up and locate the electrical contacts on the ink cartridge. The electrical contacts are four small rectangles of copper or gold-colored metal on the bottom of the ink cartridge.

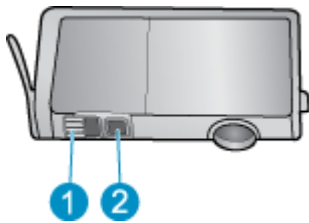

1	Ink window
2	Electrical contacts

- e. Wipe only the contacts with a dry swab or lint-free cloth.

**⚠ CAUTION:** Be careful to touch only the contacts, and do not smear any of the ink or other debris elsewhere on the cartridge.

- f. On the inside of the product, locate the contacts in the printhead. The contacts look like a set of four copper or gold-colored pins positioned to meet the contacts on the ink cartridge.







---

# 10 Connectivity

- [Add the HP Photosmart to a network](#)
- [Change from a USB connection to a wireless network](#)
- [Connect a new printer](#)
- [Change network settings](#)
- [Tips for setting up and using a networked printer](#)
- [Advanced printer management tools \(for networked printers\)](#)

## Add the HP Photosmart to a network

- [WiFi Protected Setup \(WPS\)](#)
- [Wireless with a router \(infrastructure network\)](#)

### WiFi Protected Setup (WPS)

These instructions are for customers who have already setup and installed the printer software. For first time installation refer to the setup instructions that came with the printer.

To connect the HP Photosmart to a wireless network using Wi-Fi Protected Setup (WPS), you will need the following:

- A wireless 802.11b/g/n network that includes a WPS-enabled wireless router or access point.

---

 **NOTE:** 802.11n will only support 2.4Ghz

---

- A desktop computer or laptop with either wireless networking support, or a network interface card (NIC). The computer must be connected to the wireless network that you intend to install the HP Photosmart on.

---

 **NOTE:** If you have a Wi-Fi Protected Setup (WPS) router with a WPS push button, follow the **Push Button method**. If you are not certain your router has a push button, follow the **Wireless Settings Menu method**.

---

#### Push Button (PBC) method

1. Press the Wi-Fi Protected Setup (WPS) button on your router.
2. Press and hold the **Wireless** button on the printer until the wireless light starts blinking. Press and hold for 3 seconds to start WPS push button mode .

---

 **NOTE:** The product begins a timer for approximately two minutes while a wireless connection is established.

---

#### Wireless Settings Menu method

1. Touch the **Wireless** button on the printer display to see the Wireless menu. If the printer is printing, in an error state, or performing a critical task, wait until the task has been completed or the error cleared before pressing the **Wireless** button.
2. Select **Wireless Settings** from the printer display.
3. Select **Wi-Fi Protected Setup** from the printer display.
4. If you have a Wi-Fi Protected Setup (WPS) router with a WPS push button, select **Push Button**, and then follow the onscreen instructions. If your router does not have a push button or you are not certain if your router has a push button, select **PIN**, and then follow the onscreen instructions.

---

 **NOTE:** The product begins a timer for approximately two minutes during which the corresponding button on the networking device needs to be pressed or the router PIN needs to be entered on the router's configuration page.

---

## Wireless with a router (infrastructure network)

To connect the HP Photosmart to an integrated wireless WLAN 802.11 network, you will need the following:

- A wireless 802.11b/g/n network that includes a wireless router or access point.



**NOTE:** 802.11n will only support 2.4Ghz.

---

- A desktop computer or laptop with either wireless networking support, or a network interface card (NIC). The computer must be connected to the wireless network that you intend to install the HP Photosmart on.
- Broadband Internet access (recommended) such as cable or DSL.  
If you connect the HP Photosmart on a wireless network that has Internet access, HP recommends that you use a wireless router (access point or base station) that uses Dynamic Host Configuration Protocol (DHCP).
- Network name (SSID).
- WEP key or WPA Passphrase (if needed).

### To connect the product with the Wireless Setup Wizard

1. Write down your network name (SSID) and WEP key or WPA passphrase.
2. Start Wireless Setup Wizard.
  - a. From the Home screen on the printer display, touch the **Wireless** icon.
  - b. On the Wireless menu, touch **Settings** and then touch **Wireless Setup Wizard**.
3. Connect to wireless network.
  - ▲ Select your network from the list of detected networks.
4. Follow prompts.
5. Install software.
  - ▲ Insert the product Software CD in the computer CD-ROM drive.
  - ▲ Follow the instructions on the screen.  
When you are prompted, connect the product to the computer using a USB setup cable (not included with the printer). Follow the onscreen prompts to enter your wireless network settings. The product will attempt to connect to the network. If the connection fails, follow the prompts to correct the problem, and then try again.
  - ▲ When the setup is finished, you will be prompted to disconnect the USB cable and test the wireless network connection. Once the product connects successfully to the network, install the software on each computer that will use the product over the network.

### Related topics

- [Tips for setting up and using a networked printer](#)

## Change from a USB connection to a wireless network

If you first setup your printer and installed the software with a USB cable, directly connecting the printer to your computer, you can easily change to a wireless network connection. You will need a wireless 802.11b/g/n network that includes a wireless router or access point.



**NOTE:** 802.11n will only support 2.4Ghz

---

### To change from a USB connection to a wireless network

Do one of the following according to your operating system.

1. On Windows:
  - a. From the **Start** menu on your computer, click **All Programs**, and then click **HP**.
  - b. Click **HP Photosmart 7510 Series**, click **Printer Setup & Software Selection**, and then click **Convert a USB connected printer to wireless**.
  - c. Follow the instructions on the screen.
2. On Mac:
  - a. Touch the **Wireless** icon, and then touch **Wireless Setup Wizard**.
  - b. Follow the instructions on the screen to connect the printer.
  - c. Use **HP Setup Assistant** in Applications/Hewlett-Packard/Device Utilities to change the software connection to this printer to wireless.

## Connect a new printer

### To connect a new printer from the printer software

If you have not finished connecting the printer to your computer, you need to connect it from the printer software. If you want to connect another new printer of the same model to your computer, you don't need to install the printer software once again. Do one of following according to your operating system:

1. On Windows:
  - a. From the **Start** menu on your computer, click **All Programs**, and then click **HP**.
  - b. Click **HP Photosmart 7510 Series**, click **Printer Setup and Software**, and then click **Connect a new printer**
  - c. Follow the instructions on the screen.
2. On Mac:
  - ▲ Use **HP Setup Assistant** in Applications/Hewlett-Packard/Device Utilities to change the software connection to this printer to wireless.

## Change network settings

If you want to change the wireless settings that you previously configured to a network, you need to run the Wireless Setup Wizard from the printer display.

### To run Wireless Setup Wizard to change network settings

1. From the Home screen on the printer display, touch the **Wireless** icon.
2. On the Wireless menu, touch **Settings** and then touch **Wireless Setup Wizard**.
3. Follow the instructions on the screen to change the network settings.

## Tips for setting up and using a networked printer

Use the following tips to set up and use a networked printer:

- When setting up the wireless networked printer, make sure your wireless router or access point is powered on. The printer searches for wireless routers, then lists the detected network names on the display.
- To verify the wireless connection, check the wireless icon at the top of the Home screen. If the icon is colored, the wireless connection is on. Touch the icon to display the Wireless status dashboard. Touch **Settings** to display the Network menu, with options for setting up a wireless connection or turning on the wireless connection, if already set up.
- If your computer is connected to a Virtual Private Network (VPN), you need to disconnect from the VPN before you can access any other device on your network., including the printer.
- Learn how to find your network security settings. [Click here to go online for more information.](#)

- Learn about the Network Diagnostic Utility and other troubleshooting tips. [Click here to go online for more information.](#)
- Learn how to change from a USB to wireless connection. [Click here to go online for more information.](#)
- Learn how to work with your firewall and anti-virus programs during printer setup. [Click here to go online for more information.](#)

## Advanced printer management tools (for networked printers)

When the printer is connected to a network, you can use the embedded Web server to view status information, change settings, and manage the printer from your computer.

 **NOTE:** To view or change some settings, you might need a password.

You can open and use the embedded Web server without being connected to the Internet. However, some features are not available.

- [To open the embedded Web server](#)
- [About cookies](#)

### To open the embedded Web server

 **NOTE:** The printer must be on a network and must have an IP address. The IP address for the printer can be found by touching the **Wireless** button on the control panel or by printing a network configuration page.

In a supported Web browser on your computer, type the IP address or hostname that has been assigned to the printer.

For example, if the IP address is 192.168.0.12, type the following address into a Web browser such as Internet Explorer: `http://192.168.0.12`.

To access the embedded Web server your computer and your printer need to be on the same network.

### About cookies

The embedded Web server (EWS) places very small text files (cookies) on your hard drive when you are browsing. These files let the EWS recognize your computer the next time you visit. For example, if you have configured the EWS language, a cookie helps remember which language you have selected so that the next time you access the EWS, the pages are displayed in that language. Though some cookies are cleared at the end of each session (such as the cookie that stores the selected language), others (such as the cookie that stores customer-specific preferences) are stored on the computer until you clear them manually.

You can configure your browser to accept all cookies, or you can configure it to alert you every time a cookie is offered, which allows you to decide which cookies to accept or refuse. You can also use your browser to remove unwanted cookies.

 **NOTE:** Depending on your printer, if you disable cookies, you also disable one or more of the following features:

- Starting where you left the application (especially useful when using setup wizards).
- Remembering the EWS browser language setting.
- Personalizing the EWS Home page.

For information about how to change your privacy and cookie settings and how to view or delete cookies, see the documentation available with your Web browser.

# 11 Technical information

The technical specifications and international regulatory information for the HP Photosmart are provided in this section.

For additional specifications, see the printed documentation that came with the HP Photosmart.

This section contains the following topics:

- [Notice](#)
- [Cartridge chip information](#)
- [Specifications](#)
- [Environmental product stewardship program](#)
- [Regulatory notices](#)
- [Regulatory wireless statements](#)

## Notice

### Hewlett-Packard Company notices

The information contained in this document is subject to change without notice.

All rights reserved. Reproduction, adaptation, or translation of this material is prohibited without prior written permission of Hewlett-Packard, except as allowed under copyright laws. The only warranties for HP products and services are set forth in the express warranty statements accompanying such products and services. Nothing herein should be construed as constituting an additional warranty. HP shall not be liable for technical or editorial errors or omissions contained herein.

© 2011 Hewlett-Packard Development Company, L.P.

Microsoft, Windows, Windows XP, and Windows Vista are U.S. registered trademarks of Microsoft Corporation.

Windows 7 is either a registered trademark or trademark of Microsoft Corporation in the United States and/or other countries.

Intel and Pentium are trademarks or registered trademarks of Intel Corporation or its subsidiaries in the United States and other countries.

Adobe® is a trademark of Adobe Systems Incorporated.

## Cartridge chip information

The HP cartridges used with this product contain a memory chip that assists in the operation of the product. In addition, this memory chip collects a limited set of information about the usage of the product, which might include the following: the date when the cartridge was first installed, the date when the cartridge was last used, the number of pages printed using the cartridge, the page coverage, the printing modes used, any printing errors that might have occurred, and the product model. This information helps HP design future products to meet our customers printing needs.

The data collected from the cartridge memory chip does not contain information that can be used to identify a customer or user of the cartridge or their product.

HP collects a sampling of the memory chips from cartridges returned to HP's free return and recycling program (HP Planet Partners: [www.hp.com/hpinfo/globalcitizenship/environment/recycle/](http://www.hp.com/hpinfo/globalcitizenship/environment/recycle/)). The memory chips from this sampling are read and studied in order to improve future HP products. HP partners who assist in recycling this cartridge might have access to this data, as well.

Any third party possessing the cartridge might have access to the anonymous information on the memory chip. If you prefer to not allow access to this information, you can render the chip inoperable. However, after you render the memory chip inoperable, the cartridge cannot be used in an HP product.

If you are concerned about providing this anonymous information, you can make this information inaccessible by turning off the memory chip's ability to collect the product's usage information.

### To disable the usage information function

1. Touch **Setup**.



2. Touch **Preferences**.
3. Touch **Cartridge Chip Info**, and then touch **OK**.

---

 **NOTE:** To re-enable the usage information function, restore the factory defaults.

---

 **NOTE:** You can continue to use the cartridge in the HP product if you turn off the memory chip's ability to collect the product's usage information.

---

## Specifications

Technical specifications for the HP Photosmart are provided in this section. For complete product specifications, see the Product Data Sheet at [www.hp.com/support](http://www.hp.com/support).

### System requirements

Software and system requirements are located in the Readme file.

For information about future operating system releases and support, visit the HP online support Web site at [www.hp.com/support](http://www.hp.com/support).

### Environmental specifications

- Allowable operating temperature range: Main printer: 5 to 40 degrees C (41 to 104 degrees F) Removable display: -10 to 40 degrees C (14 to 104 degrees F)
- Allowable operating temperature range: 5 °C to 40 °C (41 °F to 104 °F)
- Humidity: 15% to 80% RH non-condensing; 28 °C maximum dewpoint
- Non-operating (Storage) temperature range: -20 to 60 degrees C (-4 to 140 degrees F)
- In the presence of high electromagnetic fields, it is possible the output from the HP Photosmart may be slightly distorted
- HP recommends using a USB cable less than or equal to 3 m (10 feet) in length to minimize injected noise due to potential high electromagnetic fields

### Print resolution

To learn more about the printer resolution, see the printer software.

### Paper specifications

Type	Paper weight	Input tray <sup>*</sup>	Output tray <sup>†</sup>	Photo tray <sup>*</sup>
Plain paper	16 to 24 lb. (60 to 90 gsm)	Up to 125 (20 lb. paper)	50 (20 lb. paper)	n/a
Legal paper	16 to 24 lb. (60 to 90 gsm)	Up to 125 (20 lb. paper)	10 (20 lb. paper)	n/a
Cards	Up to 75 lb. (281 gsm)	Up to 60	25	Up to 20
Envelopes	20 to 24 lb. (75 to 90 gsm)	Up to 15	15	n/a
Transparency film	n/a	Up to 40	25	n/a
Labels	n/a	Up to 40	25	n/a
5 x 7 inch (13 x 18 cm) Photo paper	Up to 75 lb (281 gsm) (236 gsm)	Up to 40	25	Up to 20
4 x 6 inch (10 x 15 cm) Photo paper	Up to 75 lb. (281 gsm) (236 gsm)	Up to 40	25	Up to 20

(continued)

Type	Paper weight	Input tray*	Output tray†	Photo tray*
8.5 x 11 inch (216 x 279 mm) Photo paper	Up to 75 lb. (281 gsm)	Up to 40	25	n/a

\* Maximum capacity.

† Output tray capacity is affected by the type of paper and the amount of ink you are using. HP recommends emptying the output tray frequently. FAST DRAFT print quality mode requires the extender tray to be extended and the end tray rotated up. Without the end tray rotated up, both letter and legal-sized paper will fall on the first sheet.

\*

 **NOTE:** For a complete list of supported media sizes, see the printer driver.

#### Two-sided printing accessory paper specifications - all regions except Japan

Type	Size	Weight
Paper	Letter: 8.5 x 11 inches Executive: 7.25 x 10.5 inches A4: 210 x 297 mm B5 (ISO): 176 x 250 mm B5 (JIS): 182 x 257 mm	16 to 24 lb. (60 to 90 gsm)
Brochure paper	Letter: 8.5 x 11 inches A4: 210 x 297 mm	Up to 48 lb. (180 gsm)

#### Two-sided printing accessory paper specifications - Japan only

Type	Size	Weight
Paper	Letter: 8.5 x 11 inches Executive: 7.25 x 10.5 inches A4: 210 x 297 mm A5: 148 x 210 mm B5 (ISO): 176 x 250 mm B5 (JIS): 182 x 257 mm	60 to 90 g/m <sup>2</sup> (16 to 24 lb.)
Brochure paper	Letter: 8.5 x 11 inches A4: 210 x 297 mm	Up to 180 g/m <sup>2</sup> (48 lb. bond)
Cards and photos	4 x 6 inches 5 x 8 inches 10 x 15 cm A6: 105 x 148.5 mm Hagaki: 100 x 148 mm	Up to 200 g/m <sup>2</sup> (110 lb. index)

#### Alignment skew

- .006 mm/mm on plain paper (2nd side)

 **NOTE:** Media type availability varies by country/region.

#### Print specifications

- Print speeds vary according to the complexity of the document
- Panorama-size printing
- Method: drop-on-demand thermal inkjet
- Language: PCL3 GUI

#### Copy specifications

- Digital image processing
- Maximum number of copies varies by model



- Copy speeds vary according to the complexity of the document and model
- Maximum copy enlargement ranging from 200-400% (depends on model)
- Maximum copy reduction ranging from 25-50% (depends on model)

#### **Ink cartridge yield**

Visit [www.hp.com/go/learnaboutsupplies](http://www.hp.com/go/learnaboutsupplies) for more information on estimated cartridge yields.

#### **Scan specifications**

- Image editor included
- Resolution: up to 1200 x 2400 ppi optical (depends on model); 19200 ppi enhanced (software)  
For more information about ppi resolution, see the scanner software.
- Color: 48-bit color, 8-bit grayscale (256 levels of gray)
- Maximum scan size from glass: 21.6 x 29.7 cm (8.5 x 11.7 inches)

## **Environmental product stewardship program**

Hewlett-Packard is committed to providing quality products in an environmentally sound manner. Design for recycling has been incorporated into this product. The number of materials has been kept to a minimum while ensuring proper functionality and reliability. Dissimilar materials have been designed to separate easily. Fasteners and other connections are easy to locate, access, and remove using common tools. High priority parts have been designed to access quickly for efficient disassembly and repair.

For more information, visit HP's Commitment to the Environment Web site at:

[www.hp.com/hpinfo/globalcitizenship/environment/index.html](http://www.hp.com/hpinfo/globalcitizenship/environment/index.html)

This section contains the following topics:

- [Eco-Tips](#)
- [Paper use](#)
- [Plastics](#)
- [Material safety data sheets](#)
- [Recycling program](#)
- [HP inkjet supplies recycling program](#)
- [Auto Power-Off](#)
- [Set the Energy Save Mode](#)
- [Power consumption](#)
- [Disposal of waste equipment by users in private households in the European Union](#)
- [Chemical Substances](#)
- [Toxic and hazardous substance table](#)
- [Battery disposal in the Netherlands](#)
- [Battery disposal in Taiwan](#)
- [Attention California users](#)
- [EU battery directive](#)

### **Eco-Tips**

HP is committed to helping customers reduce their environmental footprint. HP has provided the Eco-Tips below to help you focus on ways to assess and reduce the impact of your printing choices. In addition to specific features in this product, please visit the HP Eco Solutions web site for more information on HP's environmental initiatives.

[www.hp.com/hpinfo/globalcitizenship/environment/](http://www.hp.com/hpinfo/globalcitizenship/environment/)

#### **Your product's Eco features**

- **Energy Savings information:** To determine the ENERGY STAR® qualification status for this product, see [Power consumption](#).
- **Recycled Materials:** For more information regarding recycling of HP products, please visit: [www.hp.com/hpinfo/globalcitizenship/environment/recycle/](http://www.hp.com/hpinfo/globalcitizenship/environment/recycle/)

## Paper use

This product is suited for the use of recycled paper according to DIN 19309 and EN 12281:2002.

## Plastics

Plastic parts over 25 grams are marked according to international standards that enhance the ability to identify plastics for recycling purposes at the end of product life.

## Material safety data sheets

Material safety data sheets (MSDS) can be obtained from the HP Web site at:

[www.hp.com/go/msds](http://www.hp.com/go/msds)

## Recycling program

HP offers an increasing number of product return and recycling programs in many countries/regions, and partners with some of the largest electronic recycling centers throughout the world. HP conserves resources by reselling some of its most popular products. For more information regarding recycling of HP products, please visit:

[www.hp.com/hpinfo/globalcitizenship/environment/recycle/](http://www.hp.com/hpinfo/globalcitizenship/environment/recycle/)

## HP inkjet supplies recycling program

HP is committed to protecting the environment. The HP Inkjet Supplies Recycling Program is available in many countries/regions, and lets you recycle used print cartridges and ink cartridges free of charge. For more information, go to the following Web site:

[www.hp.com/hpinfo/globalcitizenship/environment/recycle/](http://www.hp.com/hpinfo/globalcitizenship/environment/recycle/)

## Auto Power-Off

Auto Power-Off is automatically enabled by default when you turn on the printer. When Auto Power-Off is enabled, the printer will automatically turn off after two hours of inactivity to help reduce energy use. Auto Power-Off is automatically disabled when the printer establishes a wireless connection with a network router or with a mobile device for Wireless Direct printing, or when you enable alarms or calendar reminders. You can change the Auto Power-Off setting from the control panel. Once you change the setting, the printer will maintain the setting that you choose. **Auto Power-Off turns the printer off completely, so you must use the power button to turn the printer back on.**

### To enable or disable Auto Power-Off

1. From the Home screen, touch **Setup**.



2. Touch **Preferences**.
3. Scroll through the options, and then touch **Set Auto-off**.
4. Touch **On** or **Off**.
5. Touch **Yes** to confirm your selection or **No** to keep your current setting.

---

 **TIP:** If you are printing through a wireless connection over a network, Auto Power-Off should be disabled to ensure that print jobs do not get lost. Even when Auto Power-Off is disabled, the user-adjustable Energy Saver Mode helps reduce energy use.

---

## Set the Energy Save Mode

The HP Photosmart Energy Save Mode reduces energy use by entering a sleep mode after 5 minutes of inactivity. The time to sleep mode can be extended to 10 or 15 minutes.

---

 **NOTE:** This feature is on by default and cannot be turned off.

---

### To set Energy Save Mode

1. Touch the Setup icon.



2. Touch **Preferences**.
3. Scroll through the options and touch **Energy Save Mode**.
4. Touch the desired time interval (5, 10 or 15 minutes).

### Power consumption

Hewlett-Packard printing and imaging equipment marked with the ENERGY STAR® logo is qualified to the U.S. Environmental Protection Agency's ENERGY STAR specifications for imaging equipment. The following mark will appear on ENERGY STAR qualified imaging products:



Additional ENERGY STAR qualified imaging product model information is listed at: [www.hp.com/go/energystar](http://www.hp.com/go/energystar)



## Toxic and hazardous substance table

有毒有害物质表						
根据中国《电子信息产品污染控制管理办法》						
零件描述	有毒有害物质和元素					
	铅	汞	镉	六价铬	多溴联苯	多溴联苯醚
印刷电路板*	0	0	0	0	0	0
电阻*	0	0	0	0	0	0
印刷电容器*	X	0	0	0	0	0
打印系统*	X	0	0	0	0	0
显示器*	X	0	0	0	0	0
喷墨打印机墨盒*	X	0	0	0	0	0
喷墨打印机墨盒*	0	0	0	0	0	0
驱动叉簧*	X	0	0	0	0	0
打印头*	X	X	0	0	0	0
网咯配件*	X	0	0	0	0	0
电源线*	X	0	0	0	0	0
自动双面打印系统*	0	0	0	0	0	0
外置电源*	X	0	0	0	0	0

0: 按此零件的所有均一材质中包含的这种有毒有害物质, 含量低于SJ/T11383-2008 的限制  
X: 按此零件使用的均一材质中至少有一种包含的这种有毒有害物质, 含量高于SJ/T11383-2006 的限制  
注: 环保使用期限的参考标识取决于产品正常工作的高度和温度等条件  
\*以上只适用于使用这些零件的产品

## Battery disposal in the Netherlands



Dit HP Product bevat een lithium-mangane-dioxide batterij. Deze bevindt zich op de hoofdprintplaat. Wanneer deze batterij leeg is, moet deze volgens de geldende regels worden afgevoerd.

## Battery disposal in Taiwan



廢電池請回收

Please recycle waste batteries.

## Attention California users

The battery supplied with this product may contain perchlorate material. Special handling may apply. For more information, go to the following Web site:

[www.dtsc.ca.gov/hazardouswaste/perchlorate](http://www.dtsc.ca.gov/hazardouswaste/perchlorate)

## EU battery directive



English	<b>European Union Battery Directive</b> This product contains a battery that is used to maintain data integrity of real time clock or product settings and is designed to last the life of the product. Any attempt to service or replace this battery should be performed by a qualified service technician.
Français	<b>Directive sur les batteries de l'Union Européenne</b> Ce produit contient une batterie qui permet de maintenir l'intégrité des données pour les paramètres du produit ou l'horloge en temps réel et qui a été conçue pour durer aussi longtemps que le produit. Toute tentative de réparation ou de remplacement de cette batterie doit être effectuée par un technicien qualifié.
Deutsch	<b>Batterie-Richtlinie der Europäischen Union</b> Dieses Produkt enthält eine Batterie, die dazu dient, die Datenintegrität der Echtzeituhr sowie der Produkteinstellungen zu erhalten, und die für die Lebensdauer des Produkts ausreicht. Im Bedarfsfall sollte das Instandhalten bzw. Austauschen der Batterie von einem qualifizierten Servicetechniker durchgeführt werden.
Italiano	<b>Direttiva dell'Unione Europea relativa alla raccolta, al trattamento e allo smaltimento di batterie e accumulatori</b> Questo prodotto contiene una batteria utilizzata per preservare l'integrità dei dati dell'orologio in tempo reale o delle impostazioni del prodotto e la sua durata si intende pari a quella del prodotto. Eventuali interventi di riparazione o sostituzione della batteria devono essere eseguiti da un tecnico dell'assistenza qualificato.
Español	<b>Directiva sobre baterías de la Unión Europea</b> Este producto contiene una batería que se utiliza para conservar la integridad de los datos del reloj de tiempo real o la configuración del producto y está diseñada para durar toda la vida útil del producto. El mantenimiento o la sustitución de dicha batería deberá realizarla un técnico de mantenimiento cualificado.
Česky	<b>Směrnice Evropské unie pro nakládání s bateriemi</b> Tento výrobek obsahuje baterii, která slouží k uchování správných dat hodin reálného času nebo nastavení výrobku. Baterie je navržena tak, aby vydržela celou životnost výrobku. Jakýkoliv pokus o opravu nebo výměnu baterie by měl provést kvalifikovaný servisní technik.
Dansk	<b>EU's batteridirektiv</b> Produktet indeholder et batteri, som bruges til at vedligeholde dataintegriteten for realtidsur- eller produktindstillinger og er beregnet til at holde i hele produktets levetid. Service på batteriet eller udskiftning bør foretages af en uddannet servicetekniker.
Nederlands	<b>Richtlijn batterijen voor de Europese Unie</b> Dit product bevat een batterij die wordt gebruikt voor een juiste tijdsaanwijzing van de klok en het behoud van de productinstellingen. Bovendien is deze ontworpen om gedurende de levensduur van het product mee te gaan. Het onderhoud of de vervanging van deze batterij moet door een gekwalificeerde onderhoudstechnicus worden uitgevoerd.
Eesti	<b>Euroopa Liidu aku direktiiv</b> Toode sisaldab akut, mida kasutatakse reaalaja kella andmeühitsuse või toote sätete säilitamiseks. Aku on valmistatud kestma terve toote kasutusaja. Akut tohib hooldada või vahetada ainult kvalifitseeritud hooldustehnik.
Soomi	<b>Euroopan unionin paristodirektiivi</b> Tämä laite sisältää pariston, jota käytetään reaalitajaisen kellon tietojen ja laitteen asetusten säilyttämiseen. Pariston on suunniteltu kestävänsä laitteen koko käyttöajan ajan. Pariston mahdollinen korjaus tai vaihto on jätettävä pätevän huoltohenkilön tehtäväksi.
Ελληνικά	<b>Οδηγία της Ευρωπαϊκής Ένωσης για τις ηλεκτρικές σήλας</b> Αυτό το προϊόν περιλαμβάνει μία μπαταρία, η οποία χρησιμοποιείται για τη διατήρηση της ακεραιότητας των δεδομένων ρολογιού πραγματικού χρόνου ή των ρυθμίσεων προϊόντος και έχει σχεδιαστεί έτσι ώστε να διαρκέσει όσο και το προϊόν. Τυχόν απόπειρες επιδιόρθωσης ή αντικατάστασης αυτής της μπαταρίας θα πρέπει να πραγματοποιούνται από κατάλληλα εκπαιδευμένο τεχνικό.
Magyar	<b>Az Európai unió telepek és akkumulátorok direktívája</b> A termék tartalmaz egy elemet, melynek feladata az, hogy biztosítsa a valós idejű óra vagy a termék beállításainak adatintegritását. Az elem úgy van tervezve, hogy végig kiartson a termék használatá során. Az elem bármilyen javítását vagy cseréjét csak képzett szakember végezheti el.
Lietuvių	<b>Eiropas Savienības Bateriju direktīva</b> Produktam ir baterija, ko izmanto reālo laika pulksteņa vai produkta iestatījumu datu integritātes saglabāšanai, un tā ir paredzēta visam produkta dzīves ciklam. Jebkura apkope vai baterijas nomaiņa ir jāveic atbilstoši kvalificētam darbiniekam.
Latviešu	<b>Eiropas Savienības bateriju ir akumulatoru direktīva</b> Šīme gaminājā ir baterija, kuru izmanto, kad būtu galma priekšrēti reālo laika laukrodzīo veikimā arba gaminio nuostatas; jī skīrtā veikī visā gaminio ekspluatavīmo laikā. Bet kokius šīs baterijas aptarmavīmo arba keīlīmo darbus turī atlīktī kvalīfīkūotas aptarmavīmo tehnikas.
Polski	<b>Dyrektywa Unii Europejskiej w sprawie baterii i akumulatorów</b> Produkt zawiera baterię wykorzystywaną do zachowania integralności danych zegara czasu rzeczywistego lub ustawień produktu, która podtrzymuje działanie produktu. Przegląd lub wymiana baterii powinny być wykonywane wyłącznie przez uprawnionego technika serwisu.
Português	<b>Diretiva sobre baterias da União Europeia</b> Este produto contém uma bateria que é usada para manter a integridade dos dados do relógio em tempo real ou das configurações do produto e é projetada para ter a mesma duração que este. Qualquer tentativa de consertar ou substituir essa bateria deve ser realizada por um técnico qualificado.
Slovenščina	<b>Smernica Evropske unie pre zaobchádzanie s bateriami</b> Tento výrobok obsahuje batériu, ktorá slúži na uchovanie správnych údajov hodin reálneho času alebo nastavení výrobku. Batéria je skonštruovaná tak, aby vydržala celú životnosť výrobku. Akýkoľvek pokus o opravu alebo výmenu batérie by mal vykonať kvalifikovaný servisný technik.
Svenska	<b>Direktiva Evropske unije o baterijah in akumulatorjih</b> V tem izdelku je baterija, ki zagotavlja natančnost podatkov ure v realnem času ali nastavitev izdelka v celotni življenjski dobi izdelka. Kakršno koli popravilo ali zamenjavo te baterije lahko izvede le pooblaščen tehnik.
Български	<b>EU's batteridirektiv</b> Produkten innehåller ett batteri som används för att upprätthålla data i realtidsklockan och produktinställningarna. Batteriet ska röcka produktens hela livslängd. Endast kvalificerade servicetekniker får utföra service på batteriet och byta ut det.
Български	<b>Директива за батерии на Европейския съюз</b> Този продукт съдържа батерия, която се използва за поддържане на целостта на данните на часовника в реално време или настройките за продукта, създадена на издръжи през целия живот на продукта. Сервисът или замната на батерията трябва да се извършва от квалифициран техник.
Română	<b>Directiva Uniunii Europene referitoare la baterii</b> Acest produs conține o baterie care este utilizată pentru a menține integritatea datelor ceasului de timp real sau setările produsului și care este proiectată să funcționeze pe întreaga durată de viață a produsului. Orice lucrare de service sau de înlocuire a acestei baterii trebuie efectuată de un tehnician de service calificat.

## Regulatory notices

The HP Photosmart meets product requirements from regulatory agencies in your country/region.

This section contains the following topics:

- [Regulatory model identification number](#)
- [FCC statement](#)
- [VCCI \(Class B\) compliance statement for users in Japan](#)
- [Notice to users in Japan about the power cord](#)
- [Notice to users in Korea](#)
- [Notice to users in Germany](#)
- [Noise emission statement for Germany](#)
- [European Union Regulatory Notice](#)

## Regulatory model identification number

For regulatory identification purposes, your product is assigned a Regulatory Model Number. The Regulatory Model Number for your product is SDGOB-1021. This regulatory number should not be confused with the marketing name (HP Photosmart 7510 Series, etc.) or product numbers (CD734A, etc.).

## FCC statement

### FCC statement

The United States Federal Communications Commission (in 47 CFR 15.105) has specified that the following notice be brought to the attention of users of this product.

This equipment has been tested and found to comply with the limits for a Class B digital device, pursuant to Part 15 of the FCC Rules. These limits are designed to provide reasonable protection against harmful interference in a residential installation. This equipment generates, uses and can radiate radio frequency energy and, if not installed and used in accordance with the instructions, may cause harmful interference to radio communications. However, there is no guarantee that interference will not occur in a particular installation. If this equipment does cause harmful interference to radio or television reception, which can be determined by turning the equipment off and on, the user is encouraged to try to correct the interference by one or more of the following measures:

- Reorient the receiving antenna.
- Increase the separation between the equipment and the receiver.
- Connect the equipment into an outlet on a circuit different from that to which the receiver is connected.
- Consult the dealer or an experienced radio/TV technician for help.

For further information, contact:

Manager of Corporate Product Regulations  
Hewlett-Packard Company  
3000 Hanover Street  
Palo Alto, Ca 94304  
(650) 857-1501

Modifications (part 15.21)

The FCC requires the user to be notified that any changes or modifications made to this device that are not expressly approved by HP may void the user's authority to operate the equipment.

This device complies with Part 15 of the FCC Rules. Operation is subject to the following two conditions: (1) this device may not cause harmful interference, and (2) this device must accept any interference received, including interference that may cause undesired operation.

## VCCI (Class B) compliance statement for users in Japan

この装置は、クラスB情報技術装置です。この装置は、家庭環境で使用することを目的としていますが、この装置がラジオやテレビジョン受信機に近接して使用されると、受信障害を引き起こすことがあります。取扱説明書に従って正しい取り扱いをして下さい。

VCCI-B

## Notice to users in Japan about the power cord

製品には、同梱された電源コードをお使い下さい。  
同梱された電源コードは、他の製品では使用出来ません。

## Notice to users in Korea

B 급 기기 (가정용 방송통신기기)	이 기기는 가정용(B급)으로 전자파적합등록을 한 기기로서 주로 가정에서 사용하는 것을 목적으로 하며, 모든 지역에서 사용할 수 있습니다.
------------------------	--

## Notice to users in Germany

<b>Sehanzeige-Arbeitsplätze</b> Das Gerät ist nicht für die Benutzung am Bildschirmarbeitsplatz gemäß Bildschirmarbeitsstättengesetz vorgesehen.
---

## Noise emission statement for Germany

<b>Geräuschemission</b> LpA < 70 dB am Arbeitsplatz im Normalbetrieb nach DIN 45635 T. 19
--

## European Union Regulatory Notice

Products bearing the CE marking comply with the following EU Directives:

- Low Voltage Directive 2006/95/EC
- EMC Directive 2004/108/EC
- Ecodesign Directive 2009/125/EC, where applicable

CE compliance of this product is valid only if powered with the correct CE-marked AC adapter provided by HP.



If this product has telecommunications functionality, it also complies with the essential requirements of the following EU Directive:

- R&TTE Directive 1999/5/EC

Compliance with these directives implies conformity to applicable harmonized European standards (European Norms) that are listed in the EU Declaration of Conformity issued by HP for this product or product family and available (in English only) either within the product documentation or at the following web site: [www.hp.com/go/certificates](http://www.hp.com/go/certificates) (type the product number in the search field).



The compliance is indicated by one of the following conformity markings placed on the product:

	<p>For non-telecommunications products and for EU harmonized telecommunications products, such as Bluetooth® within power class below 10mW.</p>
	<p>For EU non-harmonized telecommunications products (If applicable, a 4-digit notified body number is inserted between CE and !).</p>

Please refer to the regulatory label provided on the product.

The telecommunications functionality of this product may be used in the following EU and EFTA countries: Austria, Belgium, Bulgaria, Cyprus, Czech Republic, Denmark, Estonia, Finland, France, Germany, Greece, Hungary, Iceland, Ireland, Italy, Latvia, Liechtenstein, Lithuania, Luxembourg, Malta, Netherlands, Norway, Poland, Portugal, Romania, Slovak Republic, Slovenia, Spain, Sweden, Switzerland, and United Kingdom.

The telephone connector (not available for all products) is intended for connection to analogue telephone networks.

#### Products with wireless LAN devices

- Some countries may have specific obligations or special requirements about the operation of Wireless LAN networks such as indoor use only or restrictions of the channels available. Please make sure that the country settings of the wireless network are correct.

#### France

- For 2.4-GHz Wireless LAN operation of this product, certain restrictions apply: This product may be used indoors for the entire 2400-MHz to 2483.5-MHz frequency band (channels 1 to 13). For outdoor use, only the 2400-MHz to 2454-MHz frequency band (channels 1 to 7) may be used. For the latest requirements, see [www.arcep.fr](http://www.arcep.fr).

The point of contact for regulatory matters is:

Hewlett-Packard GmbH, Dept./MS: HQ-TRE, Herrenberger Strasse 140, 71034 Boeblingen, GERMANY

## Regulatory wireless statements

This section contains the following regulatory information pertaining to wireless products:

- [Exposure to radio frequency radiation](#)
- [Notice to users in Brazil](#)
- [Notice to users in Canada](#)
- [Notice to users in Taiwan](#)

### Exposure to radio frequency radiation

#### Exposure to radio frequency radiation



**Caution** The radiated output power of this device is far below the FCC radio frequency exposure limits. Nevertheless, the device shall be used in such a manner that the potential for human contact during normal operation is minimized. This product and any attached external antenna, if supported, shall be placed in such a manner to minimize the potential for human contact during normal operation. In order to avoid the possibility of exceeding the FCC radio frequency exposure limits, human proximity to the antenna shall not be less than 20 cm (8 inches) during normal operation.

## Notice to users in Brazil

### **Aviso aos usuários no Brasil**

Este equipamento opera em caráter secundário, isto é, não tem direito à proteção contra interferência prejudicial, mesmo de estações do mesmo tipo, e não pode causar interferência a sistemas operando em caráter primário. (Res. ANATEL 282/2001).

## Notice to users in Canada

### **Notice to users in Canada/Note à l'attention des utilisateurs canadiens**

For Indoor Use. This digital apparatus does not exceed the Class B limits for radio noise emissions from the digital apparatus set out in the Radio Interference Regulations of the Canadian Department of Communications. The internal wireless radio complies with RSS 210 and RSS GEN of Industry Canada.

Utiliser à l'intérieur. Le présent appareil numérique n'émet pas de bruit radioélectrique dépassant les limites applicables aux appareils numériques de la classe B prescrites dans le Règlement sur le brouillage radioélectrique édicté par le ministère des Communications du Canada. Le composant RF interne est conforme à la norme RSS-210 and RSS GEN d'Industrie Canada.

## Notice to users in Taiwan

### **低功率電波輻射性電機管理辦法**

#### **第十二條**

經型式認證合格之低功率射頻電機，非經許可，公司、商號或使用者均不得擅自變更頻率、加大功率或變更設計之特性及功能。

#### **第十四條**

低功率射頻電機之使用不得影響飛航安全及干擾合法通信；經發現有干擾現象時，應立即停用，並改善至無干擾時方得繼續使用。

前項合法通信，指依電信法規定作業之無線電通信。低功率射頻電機須忍受合法通信或工業、科學及醫藥用電波輻射性電機設備之干擾。



---

# Index

## Symbols/Numerics

10 x 15 cm photo paper specifications 46

## A

after the support period 36

## B

buttons, control panel 6

## C

control panel

buttons 6

features 6

copy

specifications 47

customer support

warranty 36

## E

envelopes

specifications 46

environment

Environmental product stewardship program 48

environmental specifications 46

## I

interface card 41, 42

## L

labels

specifications 46

legal paper

specifications 46

letter paper

specifications 46

## N

network

interface card 41, 42

## P

paper

specifications 46

phone support 35

phone support period

period for support 36

photo paper

specifications 46

print

specifications 47

## R

recycle

ink cartridges 49

regulatory notices

regulatory model identification

number 54

wireless statements 56

## S

scan

scan specifications 48

system requirements 46

## T

technical information

copy specifications 47

environmental specifications 46

paper specifications 46

print specifications 47

scan specifications 48

system requirements 46

transparencies

specifications 46

## W

warranty 36



