

# Getting Started

HP Notebook

© Copyright 2011 Hewlett-Packard Development Company, L.P.

Bluetooth is a trademark owned by its proprietor and used by Hewlett-Packard Company under license. Microsoft, Windows, and Windows Vista are U.S. registered trademarks of Microsoft Corporation. SD Logo is a trademark of its proprietor.

The information contained herein is subject to change without notice. The only warranties for HP products and services are set forth in the express warranty statements accompanying such products and services. Nothing herein should be construed as constituting an additional warranty. HP shall not be liable for technical or editorial errors or omissions contained herein.

Second Edition: August 2011

First Edition: July 2011

Document Part Number: 656966-002

### **Product notice**

This guide describes features that are common to most models. Some features may not be available on your computer.

### **Software terms**

By installing, copying, downloading, or otherwise using any software product preinstalled on this computer, you agree to be bound by the terms of the HP End User License Agreement (EULA). If you do not accept these license terms, your sole remedy is to return the entire unused product (hardware and software) within 14 days for a refund subject to the refund policy of your place of purchase.

For any further information or for requesting a full refund of the computer, please contact your local point of sale (the seller).

## Safety warning notice

---

 **WARNING!** To reduce the possibility of heat-related injuries or of overheating the computer, do not place the computer directly on your lap or obstruct the computer air vents. Use the computer only on a hard, flat surface. Do not allow another hard surface, such as an adjoining optional printer, or a soft surface, such as pillows or rugs or clothing, to block airflow. Also, do not allow the AC adapter to come into contact with the skin or a soft surface, such as pillows or rugs or clothing, during operation. The computer and the AC adapter comply with the user-accessible surface temperature limits defined by the International Standard for Safety of Information Technology Equipment (IEC 60950).

---



---

# Table of contents

<b>1 Welcome</b> .....	<b>1</b>
Finding information .....	1
<b>2 Getting to know your computer</b> .....	<b>4</b>
Top .....	5
TouchPad .....	5
Lights .....	6
Buttons and fingerprint reader (select models only) .....	7
Keys .....	9
Front .....	11
Right .....	12
Left .....	13
Display .....	15
Bottom .....	16
<b>3 Networking</b> .....	<b>17</b>
Using an Internet service provider (ISP) .....	18
Connecting to a wireless network .....	18
Connecting to an existing WLAN .....	19
Setting up a new WLAN network .....	20
Configuring a wireless router .....	21
Protecting your WLAN .....	21
<b>4 HP QuickWeb</b> .....	<b>22</b>
Getting started .....	22
Starting HP QuickWeb .....	23
<b>5 Keyboard and pointing devices</b> .....	<b>24</b>
Using the keyboard .....	25
Identifying the hotkeys .....	25
Using keypads .....	26

Using the embedded numeric keypad (select models only) .....	27
Turning the embedded numeric keypad on and off .....	28
Switching key functions on the embedded numeric keypad .....	28
Using the integrated numeric keypad (select models only) .....	28
Using pointing devices .....	29
Setting pointing device preferences .....	29
Using the TouchPad .....	29
Turning the TouchPad off and on .....	30
Navigating .....	30
Selecting .....	31
Using TouchPad gestures .....	31
Scrolling .....	32
Pinching/Zooming .....	32
Rotating .....	32
Flicking .....	33
<b>6 Maintenance .....</b>	<b>34</b>
Inserting or removing the battery .....	34
Using the optional security screw .....	37
Replacing or upgrading the hard drive .....	38
Removing the hard drive .....	38
Installing a hard drive .....	39
Adding or replacing memory modules .....	41
Updating programs and drivers .....	45
Using SoftPaq Download Manager .....	46
Cleaning your computer .....	47
Cleaning products .....	47
Cleaning procedures .....	47
Cleaning the display .....	47
Cleaning the sides and cover .....	47
Cleaning the TouchPad and keyboard .....	48
<b>7 Backup and recovery .....</b>	<b>49</b>
Windows 7 .....	49
Backing up your information .....	49
Performing a system recovery .....	50
Using the Windows recovery tools .....	51
Using f11 recovery tools .....	51
Using a Windows 7 operating system DVD (purchased separately) .....	52
Windows Vista .....	53
Backing up your information .....	53

Performing a recovery .....	54
Using the Windows recovery tools .....	54
Using f11 recovery tools .....	55
Using a Windows Vista operating system DVD (purchased separately) .....	55
<b>8 Customer support .....</b>	<b>57</b>
Contacting customer support .....	57
Labels .....	58
<b>9 Specifications .....</b>	<b>59</b>
Input power .....	60
Operating environment .....	61
<b>Index .....</b>	<b>62</b>





---

# 1 Welcome

- [Finding information](#)

After you set up and register the computer, it is important to take the following steps:

- **Set up HP QuickWeb**—Immediately access the Internet, widgets, e-mail, and communication programs without launching your main operating system. For more information, refer to [HP QuickWeb on page 22](#).
- **Connect to the Internet**—Set up your wired or wireless network so that you can connect to the Internet. For more information, refer to [Networking on page 17](#).
- **Update your antivirus software**—Protect your computer from damage caused by viruses. The software is preinstalled on the computer and includes a limited subscription for free updates. For more information, refer to the *HP Notebook Reference Guide*. For instructions on accessing this guide, refer to [Finding information on page 1](#).
- **Get to know your computer**—Learn about your computer features. Refer to [Getting to know your computer on page 4](#) and [Keyboard and pointing devices on page 24](#) for additional information.
- **Find installed software**—Access a list of the software preinstalled on the computer. Select **Start > All Programs**. For details about using the software included with the computer, refer to the software manufacturer's instructions, which may be provided with the software or on the manufacturer's Web site.

## Finding information

The computer comes with several resources to help you perform various tasks.

Resources	For information about
<i>Setup Instructions</i> poster	<ul style="list-style-type: none"><li>• How to set up the computer</li><li>• Help to identify computer components</li></ul>

Resources	For information about
<p><i>Getting Started</i></p> <p>To access this guide:</p> <p>Select <b>Start &gt; Help and Support &gt; User Guides</b>.</p> <p>– or –</p> <p>Select <b>Start &gt; All Programs &gt; HP &gt; HP Documentation</b>.</p>	<ul style="list-style-type: none"> <li>• Computer features</li> <li>• How to connect to a wireless network specifications</li> <li>• How to use the keyboard and pointing devices</li> <li>• How to replace or upgrade the hard drive and memory modules</li> <li>• How to perform a backup and recovery</li> <li>• How to contact customer support</li> <li>• Computer specifications</li> </ul>
<p><i>HP Notebook Reference Guide</i></p> <p>To access this guide:</p> <p>Select <b>Start &gt; Help and Support &gt; User Guides</b>.</p> <p>– or –</p> <p>Select <b>Start &gt; All Programs &gt; HP &gt; HP Documentation</b>.</p>	<ul style="list-style-type: none"> <li>• Power management features</li> <li>• How to maximize battery life</li> <li>• How to use the multimedia features of the computer</li> <li>• How to protect the computer</li> <li>• How to care for the computer</li> <li>• How to update the software</li> <li>• How to install certain components</li> <li>• How to create a wired and/or wireless network</li> </ul>
<p>Help and Support</p> <p>To access Help and Support, select <b>Start &gt; Help and Support</b>.</p> <p><b>NOTE:</b> For country- or region-specific support, go to <a href="http://www.hp.com/support">http://www.hp.com/support</a>, select your country or region, and follow the on-screen instructions.</p>	<ul style="list-style-type: none"> <li>• Operating system information</li> <li>• Software, driver, and BIOS updates</li> <li>• Troubleshooting tools</li> <li>• How to access technical support</li> </ul>
<p><i>Regulatory, Safety, and Environmental Notices</i></p> <p>To access this guide:</p> <p>Select <b>Start &gt; Help and Support &gt; User Guides</b>.</p> <p>– or –</p> <p>Select <b>Start &gt; All Programs &gt; HP &gt; HP Documentation</b>.</p>	<ul style="list-style-type: none"> <li>• Regulatory and safety information</li> <li>• Battery disposal information</li> </ul>
<p><i>Safety &amp; Comfort Guide</i></p> <p>To access this guide:</p> <p>Select <b>Start &gt; Help and Support &gt; User Guides</b>.</p> <p>– or –</p> <p>Select <b>Start &gt; All Programs &gt; HP &gt; HP Documentation</b>.</p> <p>– or –</p> <p>Go to <a href="http://www.hp.com/ergo">http://www.hp.com/ergo</a>.</p>	<ul style="list-style-type: none"> <li>• Proper workstation setup, posture, health, and work habits</li> <li>• Electrical and mechanical safety information</li> </ul>

Resources	For information about
<p><i>Worldwide Telephone Numbers</i> booklet</p> <p>This booklet is provided with your computer.</p>	<p>HP support telephone numbers</p>
<p>HP Web site</p> <p>To access this Web site, go to <a href="http://www.hp.com/support">http://www.hp.com/support</a>.</p>	<ul style="list-style-type: none"> <li>• Support information</li> <li>• Ordering parts and finding additional help</li> <li>• Accessories available for the device</li> </ul>
<p><i>Limited Warranty*</i></p> <p>To access the warranty:</p> <p>Select <b>Start &gt; Help and Support &gt; User Guides &gt; View Warranty Information.</b></p> <p>– or –</p> <p>Select <b>Start &gt; All Programs &gt; HP &gt; HP Documentation &gt; View Warranty Information.</b></p> <p>– or –</p> <p>Go to <a href="http://www.hp.com/go/orderdocuments">http://www.hp.com/go/orderdocuments</a>.</p>	<p>Warranty information</p>
<p>*You may find the expressly provided HP Limited Warranty applicable to your product located with the electronic guides on your computer and/or on the CD/DVD provided in the box. In some countries/regions, HP may provide a printed HP Limited Warranty in the box. For countries/regions where the warranty is not provided in printed format, you may request a printed copy at <a href="http://www.hp.com/go/orderdocuments">http://www.hp.com/go/orderdocuments</a> or write to:</p>	
<ul style="list-style-type: none"> <li>• <b>North America:</b> Hewlett-Packard, MS POD, 11311 Chinden Blvd, Boise, ID 83714, USA</li> <li>• <b>Europe, Middle East, Africa:</b> Hewlett-Packard, POD, Via G. Di Vittorio, 9, 20063, Cernusco s/Naviglio (MI), Italy</li> <li>• <b>Asia Pacific:</b> Hewlett-Packard, POD, P.O. Box 200, Alexandra Post Office, Singapore 911507</li> </ul>	
<p>Please include your product number, warranty period (found on your serial number label), name, and postal address.</p>	

---

## 2 Getting to know your computer

- [Top](#)
- [Front](#)
- [Right](#)
- [Left](#)
- [Display](#)
- [Bottom](#)

# Top

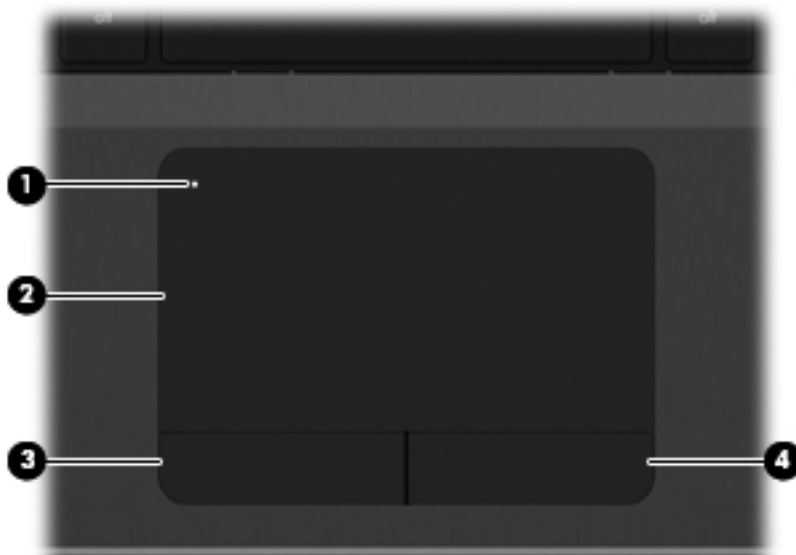

## TouchPad

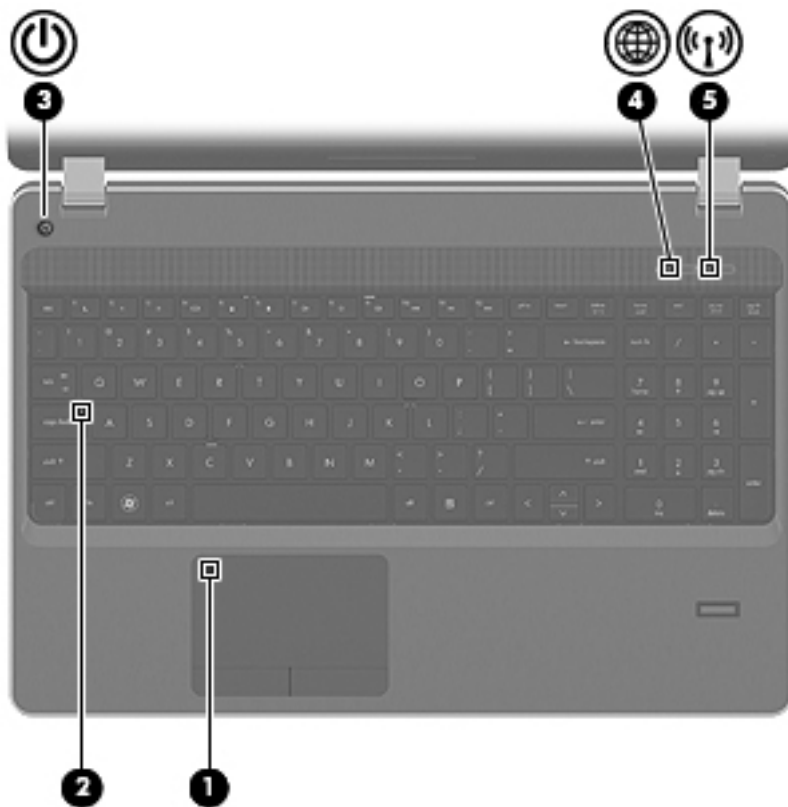

Component		Description
(1)	TouchPad on/off button	Turns the TouchPad on and off.
(2)	TouchPad	Moves the pointer and selects or activates items on the screen.
(3)	Left TouchPad button	Functions like the left button on an external mouse.
(4)	Right TouchPad button	Functions like the right button on an external mouse.

## Lights



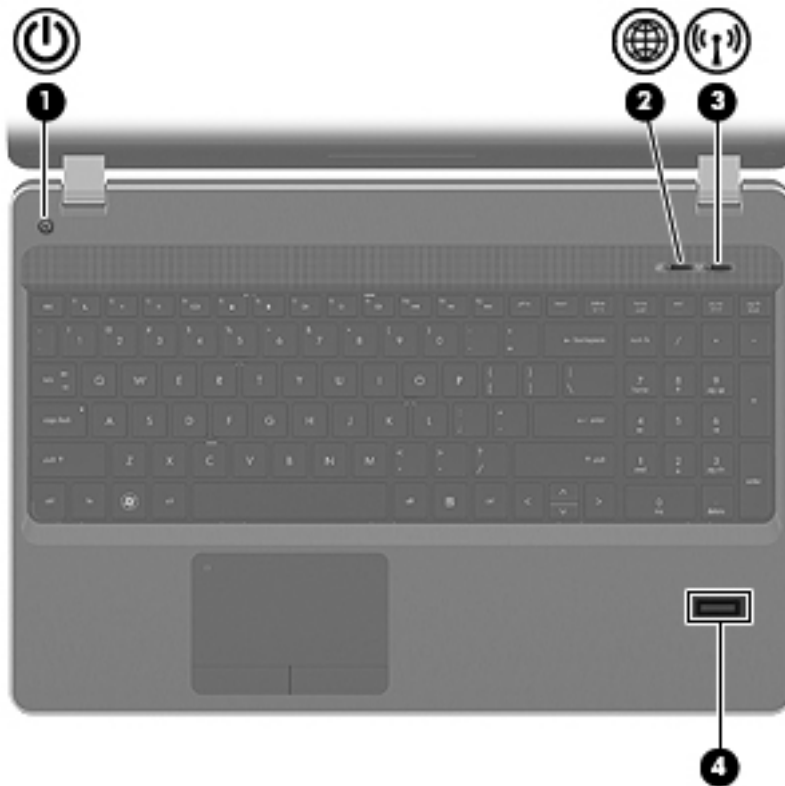

Component	Description
(1) TouchPad light	<ul style="list-style-type: none"> <li>• Amber: The TouchPad is off.</li> <li>• Off: The TouchPad is on.</li> </ul>
(2) Caps lock light	<ul style="list-style-type: none"> <li>• White: Caps lock is on.</li> <li>• Off: Caps lock is off.</li> </ul>
(3)  Power light	<ul style="list-style-type: none"> <li>• On: The computer is on.</li> <li>• Blinking: The computer is in the Sleep state.</li> <li>• Off: The computer is off or in Hibernation.</li> </ul>
(4)  QuickWeb light	<ul style="list-style-type: none"> <li>• Blinking: QuickWeb is on.</li> <li>• Off: QuickWeb is off.</li> </ul> <p data-bbox="858 1558 1374 1610"><b>NOTE:</b> For more information, refer to <a href="#">HP QuickWeb on page 22</a> and to the HP QuickWeb software Help.</p>
(5)  Wireless light	<ul style="list-style-type: none"> <li>• White: An integrated wireless device, such as a wireless local area network (WLAN) device and/or a Bluetooth® device, is on.</li> <li>• Amber: All wireless devices are off.</li> </ul>

## Buttons and fingerprint reader (select models only)



Component	Description
(1)  Power button	<ul style="list-style-type: none"><li>• When the computer is off, press the button to turn on the computer.</li><li>• When the computer is on, press the button briefly to initiate Sleep.</li><li>• When the computer is in the Sleep state, press the button briefly to exit Sleep.</li><li>• When the computer is in Hibernation, press the button briefly to exit Hibernation.</li></ul> <p>If the computer has stopped responding and Windows® shutdown procedures are ineffective, press and hold the power button for at least 5 seconds to turn off the computer.</p> <p>To learn more about your power settings:</p> <ul style="list-style-type: none"><li>• <b>Windows 7</b>—Select <b>Start &gt; Control Panel &gt; System and Security &gt; Power Options</b>.</li><li>• <b>Windows Vista</b>—Select <b>Start &gt; Control Panel &gt; System and Maintenance &gt; Power Options</b></li><li>• Or refer to the <i>HP Notebook Reference Guide</i>.</li></ul>



Component	Description
(2)  QuickWeb button	<ul style="list-style-type: none"> <li>• When the computer is off or in Hibernation, press the button to open HP QuickWeb.</li> <li>• When the computer is in Microsoft Windows, press the button to open the default Web browser.</li> <li>• When the computer is in HP QuickWeb, press the button to open the default Web browser.</li> </ul> <p><b>NOTE:</b> For more information, refer to <a href="#">HP QuickWeb on page 22</a> and to the HP QuickWeb software Help. If your computer does not have HP QuickWeb software, the button does not perform any action or function.</p>
(3)  Wireless button	Turns the wireless feature on or off but does not establish a wireless connection.
(4)  Fingerprint reader (select models only)	Allows a fingerprint logon to Windows, instead of a password logon.



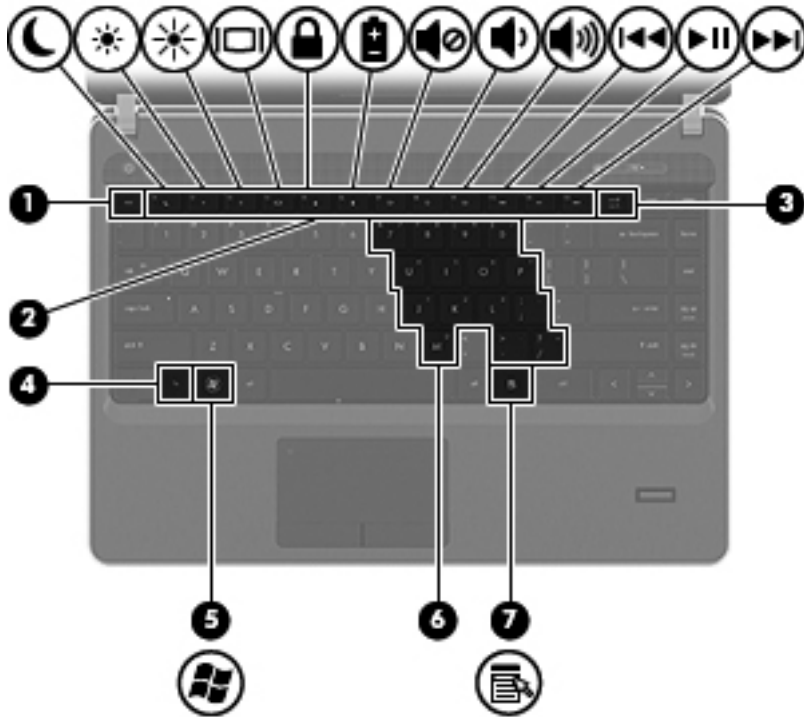

# Keys

 **NOTE:** Refer to the illustration that most closely matches your computer.



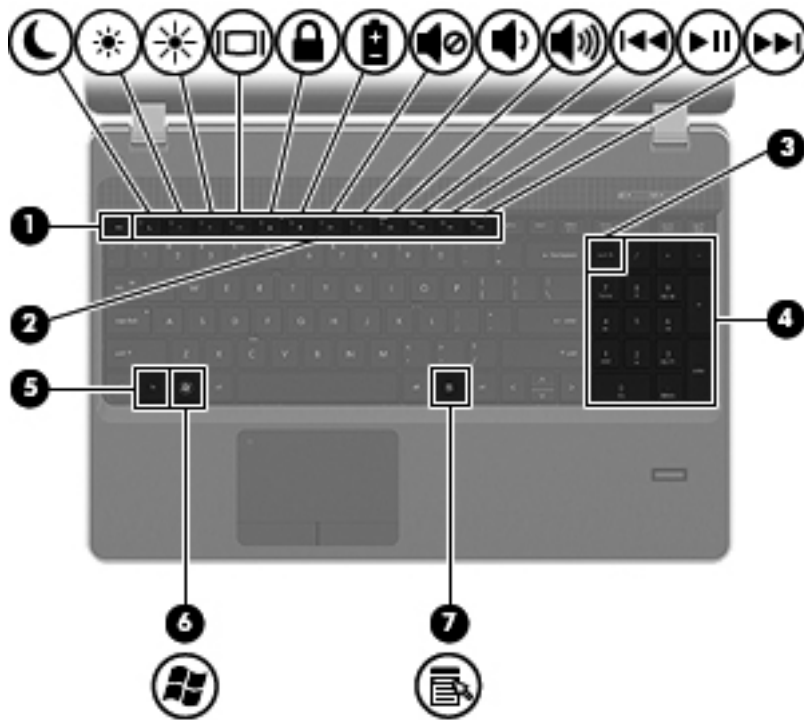

Component	Description
(1) <a href="#">esc</a> key	Displays system information when pressed in combination with the <a href="#">fn</a> key.
(2) Function keys	Execute frequently used system functions when pressed in combination with the <a href="#">fn</a> key.
(3) <a href="#">num lk</a> key (select models only)	Turns the embedded numeric keypad on and off when pressed in combination with the <a href="#">fn</a> key.  <b>NOTE:</b> The keypad function that is active when the computer is turned off is reinstated when the computer is turned back on.
(4) <a href="#">fn</a> key	Executes frequently used system functions when pressed in combination with a function key, the <a href="#">num lk</a> key, or the <a href="#">esc</a> key.
(5)  Windows logo key	Displays the Windows Start menu.
(6) Embedded numeric keypad (select models only)	When the keypad is turned on, it can be used like an external numeric keypad.  Each key on the keypad performs the function indicated by the icon in the upper-right corner of the key.
(7)  Windows applications key	Displays a shortcut menu for items beneath the cursor.



Component	Description
(1) <code>esc</code> key	Displays system information when pressed in combination with the <code>fn</code> key.
(2) Function keys	Execute frequently used system functions when pressed in combination with the <code>fn</code> key.
(3) <code>num lk</code> key (select models only)	Alternates between the navigational and numeric functions on the integrated numeric keypad.  <b>NOTE:</b> The keypad function that is active when the computer is turned off remains on when the computer is turned back on.
(4) Integrated numeric keypad (select models only)	When the <code>num lk</code> has been enabled, it can be used like an external numeric keypad.
(5) <code>fn</code> key	Executes frequently used system functions when pressed in combination with a function key or the <code>esc</code> key.
(6)  Windows logo key	Displays the Windows Start menu.
(7)  Windows applications key	Displays a shortcut menu for items beneath the cursor.



# Front



Component	Description
(1)  Hard drive light	<ul style="list-style-type: none"><li>• Blinking White: The hard drive is being accessed.</li><li>• Amber: HP 3D DriveGuard has temporarily parked the hard drive.</li></ul> <p><b>NOTE:</b> For information on HP 3D DriveGuard, refer to the <i>HP Notebook Reference Guide</i>.</p>
(2) 6-in-1 Media Card Reader	Supports the following digital card formats: <ul style="list-style-type: none"><li>• Memory Stick Pro</li><li>• Memory Stick Duo Pro</li><li>• MultiMediaCard</li><li>• MultiMediaCard Micro</li><li>• Secure Digital (SD) Card</li><li>• Secure Digital (SD) Card Micro</li></ul>
(3)  Audio-out (headphone) jack	Connects optional powered speakers, headphones, earbuds, a headset, or television audio. <p><b>WARNING!</b> To reduce the risk of personal injury, adjust the volume before putting on headphones, earbuds, or a headset. For additional safety information, refer to the <i>Regulatory, Safety, and Environmental Notices</i></p> <p><b>NOTE:</b> When a device is connected to the jack, the computer speakers are disabled.</p>
(4)  Audio-in (microphone) jack	Connects an optional computer headset microphone, stereo array microphone, or monaural microphone.

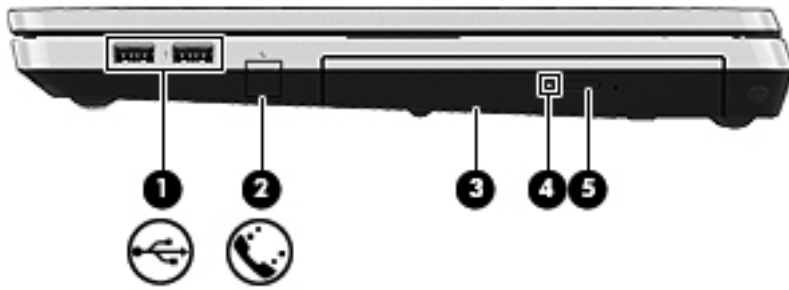





## Right

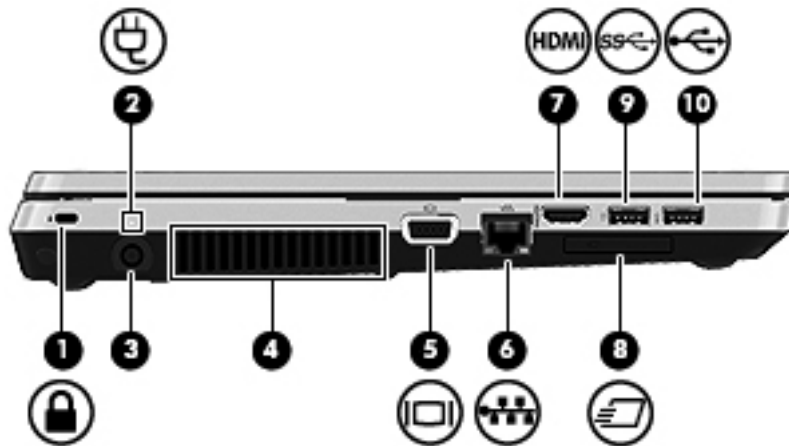



Component	Description
(1)  USB 2.0 ports (2)	Connect optional USB devices.
(2)  RJ-11 (modem) jack (select models only)	Connects a modem cable.
(3) Optical drive (select models only)	Reads and writes (select models only) to an optical disc.
(4) Optical drive light	Lights when the optical drive is active.
(5) Optical drive eject button	Releases the optical drive disc tray.

## Left



Component	Description
(1) 	<p>Security cable slot</p> <p>Attaches an optional security cable to the computer.</p> <p><b>NOTE:</b> The security cable is designed to act as a deterrent, but it may not prevent the computer from being mishandled or stolen.</p>
(2) 	<p>Battery light</p> <ul style="list-style-type: none"> <li>Amber: The computer is connected to external power and the battery is 0 to 90% charged.</li> <li>White: The computer is connected to external power and the battery is 90 to 99% charged.</li> <li>Blinking amber: A battery that is the only available power source has reached a low battery level. When the battery reaches a critical battery level, the battery light begins blinking rapidly.</li> <li>Off: The battery is fully charged.</li> </ul>
(3)	<p>Power connector</p> <p>Connects an AC adapter.</p>
(4)	<p>Vent</p> <p>Enables airflow to cool internal components.</p> <p><b>NOTE:</b> The computer fan starts up automatically to cool internal components and prevent overheating. It is normal for the internal fan to cycle on and off during routine operation.</p>
(5) 	<p>External monitor port</p> <p>Connects an external VGA monitor or projector.</p>
(6) 	<p>RJ-45 (network) jack</p> <p>Connects a network cable.</p>
(7) 	<p>HDMI port</p> <p>Connects an optional video or audio device, such as a high-definition television, or any compatible digital or audio component.</p>
(8) 	<p>ExpressCard slot</p> <p>Reads and writes to ExpressCards.</p>

Component	Description
(9)  USB 3.0 port	Connects an optional USB device. <b>NOTE:</b> Some models may show a slightly different icon.
(10)  USB 2.0 port	Connects an optional USB device.

# Display

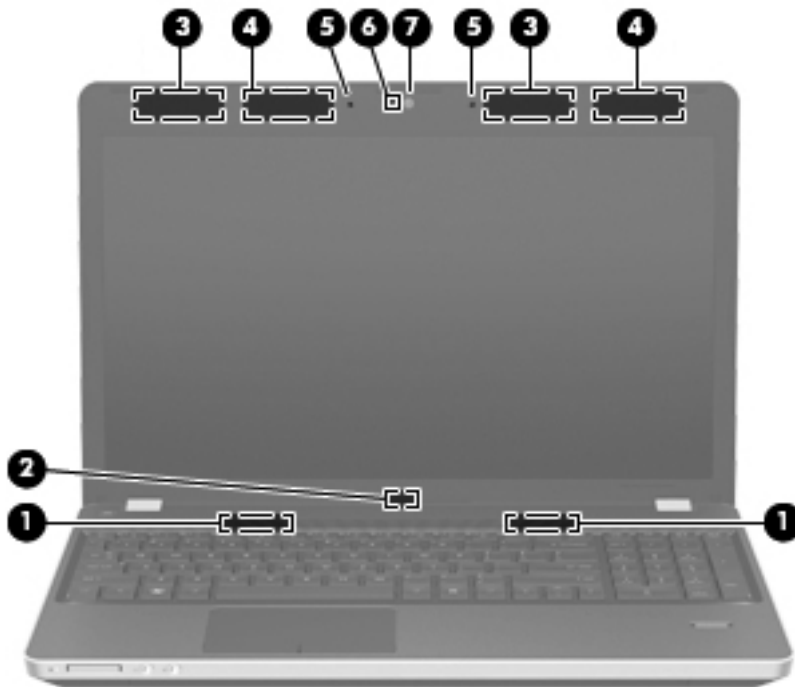



Component	Description
(1) Speakers (2)	Produce sound.
(2) Internal display switch	Turns off the display or initiates Sleep if the display is closed while the power is on.  <b>NOTE:</b> The display switch is not visible from the outside of the computer.
(3) WWAN antennas (2)* (select models only)	Send and receive wireless signals to communicate with wireless wide area networks (WWAN).
(4) WLAN antennas (2)*	Send and receive wireless signals to communicate with wireless local area networks (WLAN).
(5) Internal microphone(s) (1 or 2 depending on model)	Record sound.
(6) Webcam light (select models only)	On: The webcam is in use.
(7) Webcam (select models only)	Records video and captures still photographs.  To use the webcam, select <b>Start &gt; All Programs &gt; ArcSoft TotalMedia Suite &gt; WebCam Companion</b> .

\*The antennas are not visible from the outside of the computer. For optimal transmission, keep the areas immediately around the antennas free from obstructions. To see wireless regulatory notices, refer to the section of the *Regulatory, Safety, and Environmental Notices* that applies to your country or region. These notices are located in Help and Support.

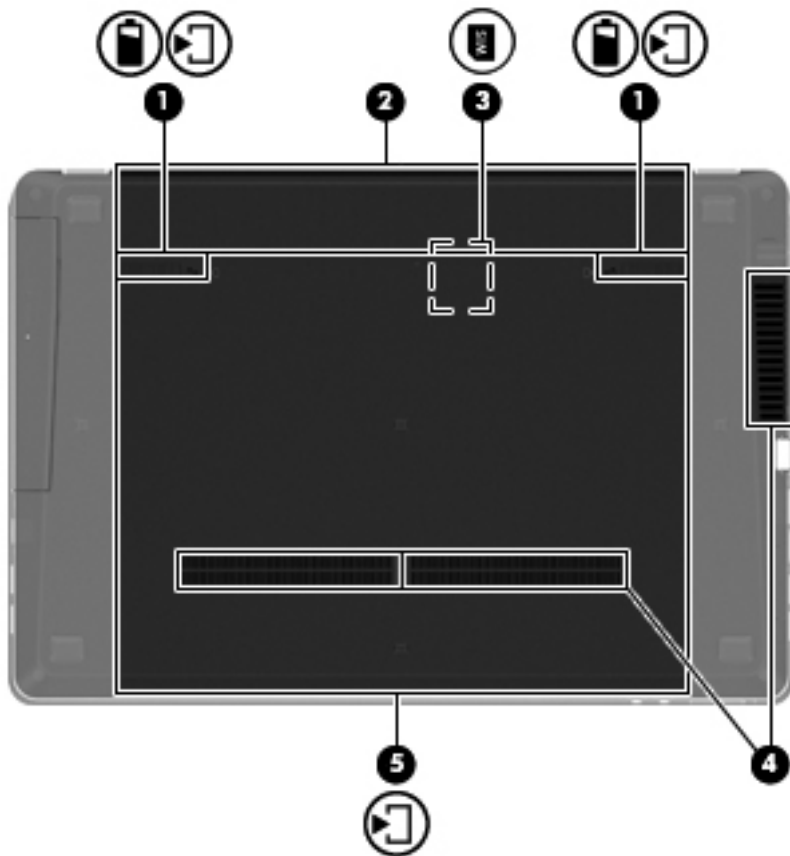
## Bottom



Component	Description
(1) 	Battery and access cover release latches Release the battery from the battery bay and the access cover from the computer.
(2)	Battery bay Holds the battery.
(3) 	SIM slot Supports a wireless subscriber identity module (SIM) (select models only). The SIM slot is located inside the battery bay.
(4)	Vents (2) Enable airflow to cool internal components.  <b>NOTE:</b> The computer fan starts up automatically to cool internal components and prevent overheating. It is normal for the internal fan to cycle on and off during routine operation.
(5) 	Hard drive bay and wireless and memory module compartments Holds the hard drive, and also contains the wireless LAN module slot and the memory module slot.  <b>CAUTION:</b> To prevent an unresponsive system, replace the wireless module only with a wireless module authorized for use in the computer by the governmental agency that regulates wireless devices in your country or region. If you replace the module and then receive a warning message, remove the module to restore computer functionality, and then contact technical support through Help and Support.



---

# 3 Networking

- [Using an Internet service provider \(ISP\)](#)
- [Connecting to a wireless network](#)



---

**NOTE:** Internet hardware and software features vary depending on computer model and your location.

---

Your computer may support one or both of the following types of Internet access:

- **Wireless**—For mobile Internet access, you can use a wireless connection. Refer to [Connecting to an existing WLAN on page 19](#) or [Setting up a new WLAN network on page 20](#).
- **Wired**—You can access the Internet by connecting to a wired network. For information on connecting to a wired network, refer to the *HP Notebook Reference Guide*.

## Using an Internet service provider (ISP)

Before you can connect to the Internet, you must establish an ISP account. Contact a local ISP to purchase Internet service and a modem. The ISP will help set up the modem, install a network cable to connect your wireless computer to the modem, and test the Internet service.

---

 **NOTE:** Your ISP will give you a user ID and password to access the Internet. Record this information and store it in a safe place.

---

The following features will help you set up a new Internet account or configure the computer to use an existing account:

- **Internet Services & Offers (available in some locations)**—This utility assists with signing up for a new Internet account and configuring the computer to use an existing account. To access this utility, select **Start > All Programs > Online Services > Get Online**.
- **ISP-provided icons (available in some locations)**—These icons may be displayed either individually on the Windows desktop or grouped in a desktop folder named Online Services. To set up a new Internet account or configure the computer to use an existing account, double-click an icon, and then follow the on-screen instructions.
- **Windows Connect to the Internet Wizard**—You can use the Windows Connect to the Internet Wizard to connect to the Internet in any of these situations:
  - You already have an account with an ISP.
  - You do not have an Internet account and want to select an ISP from the list provided within the wizard. (The list of ISP providers is not available in all regions.)
  - You have selected an unlisted ISP, and the ISP has provided you with information such as a specific IP address and POP3 and SMTP settings.

To access the Windows Connect to the Internet Wizard and instructions for using it, select **Start > Control Panel > Network and Internet > Network and Sharing Center**.

---

 **NOTE:** If you are prompted within the wizard to choose between enabling or disabling Windows Firewall, choose to enable the firewall.

---

## Connecting to a wireless network

Wireless technology transfers data across radio waves instead of wires. Your computer may be equipped with one or more of the following wireless devices:

- Wireless local area network (WLAN) device
- HP Mobile Broadband Module, a wireless wide area network (WWAN) device
- Bluetooth device

For more information on wireless technology and connecting to a wireless network, refer to the *HP Notebook Reference Guide* and information and Web site links provided in Help and Support.

## Connecting to an existing WLAN

### Windows 7

1. Turn on the computer.
2. Be sure that the WLAN device is on.
3. Click the network icon in the notification area, at the far right of the taskbar.
4. Select a network to connect to.

---

 **NOTE:** If no WLANs are listed, you may be out of range of a wireless router or access point.

 **NOTE:** If you do not see the WLAN you want to connect to, click **Open Network and Sharing Center**, and then click **Set up a new connection or network**. A list of options is displayed. You can choose to manually search for and connect to a network or to create a new network connection.

---

5. Click **Connect**.
6. If the network is a security-enabled WLAN, you are prompted to enter a network security code. Type the code, and then click **OK** to complete the connection.

### Windows Vista

1. Turn on the computer.
2. Be sure that the WLAN device is on.
3. Select **Start > Connect to**.
4. Select your WLAN from the list.
  - If the network is unsecured, a warning is displayed. Click **Connect Anyway** to accept the warning and complete the connection.
  - If the network is a security-enabled WLAN, you are prompted to enter a network security code. Type the code, and then click **Connect** to complete the connection.

---

 **NOTE:** If no WLANs are listed, you may be out of range of a wireless router or access point.

 **NOTE:** If you do not see the WLAN you want to connect to, click **Show all connections**. A list of available networks is displayed. You can choose to connect to an existing network or you can create a new network connection.

After the connection is made, you can place the mouse pointer over the network icon in the notification area, at the far right of the taskbar, to verify the name and status of the connection.

 **NOTE:** The functional range (how far your wireless signals travel) depends on WLAN implementation, router manufacturer, and interference from other electronic devices or structural barriers such as walls and floors.

---

## Setting up a new WLAN network

Required equipment:

- A broadband modem (either DSL or cable) **(1)** and high-speed Internet service purchased from an Internet service provider (ISP)
- A wireless router (purchased separately) **(2)**
- Your new wireless computer **(3)**

---

 **NOTE:** Some modems have a built-in wireless router. Check with your ISP to determine what type of modem you have.

---

The illustration shows an example of a completed WLAN network installation that is connected to the Internet. As your network grows, additional wireless and wired computers can be connected to the network to access the Internet.

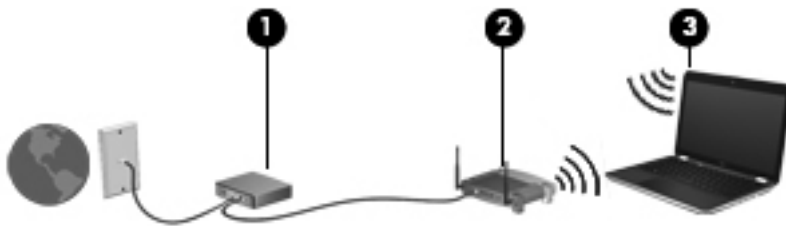

## Configuring a wireless router

For help in setting up a WLAN, refer to the information provided by your router manufacturer or your ISP.

The Windows operating system also provides tools to help you set up a new wireless network. To use the Windows tools to set up your network:

- **Windows 7**—Select **Start > Control Panel > Network and Internet > Network and Sharing Center > Set up a new connection or network > Set up a network**. Then follow the on-screen instructions.
- **Windows Vista**—Select **Start > Control Panel > Network and Internet > Network and Sharing Center > Set up a connection or network > Set up a wireless router or access point**. Then follow the on-screen instructions.



---

**NOTE:** It is recommended that you initially connect your new wireless computer to the router by using the network cable provided with the router. When the computer successfully connects to the Internet, you can disconnect the cable, and then access the Internet through your wireless network.

---

## Protecting your WLAN

When you set up a WLAN or access an existing WLAN, always turn on security features to protect your network from unauthorized access.

For information on protecting your WLAN, refer to the *HP Notebook Reference Guide*.

---

# 4 HP QuickWeb

## Getting started

The HP QuickWeb environment provides a fun and engaging way to perform many of your favorite activities. Your computer is ready to go within seconds of starting QuickWeb, allowing you to rapidly access the Internet, widgets, and communication programs. Simply press the QuickWeb button on your computer, and then start browsing the Internet, communicating with Skype, and exploring other HP QuickWeb programs.

Your HP QuickWeb Home screen includes the following features:

- Web browser—Search and browse the Internet, and create links to your favorite Web sites.
- Skype—Communicate using Skype, an application that uses voice over Internet protocol (VoIP). Skype lets you make conference calls or have video chats with one or more people at a time. You can also make long-distance phone calls to land lines.
- QuickWeb E-Mail—Read and send e-mail by connecting to Web-based e-mail providers or to your own mail server.
- Widgets—Start using widgets for news, weather, social networking, stocks, a calculator, sticky notes, and more. You can also use Widget Manager to add more widgets to the HP QuickWeb Home screen.



---

**NOTE:** For additional information about using HP QuickWeb, refer to the HP QuickWeb software Help.

---

## Starting HP QuickWeb

▲ To start HP QuickWeb, press the QuickWeb button when the computer is off or in Hibernation.

The following table explains the different behaviors of the QuickWeb button.

Button	Behavior
QuickWeb button	<ul style="list-style-type: none"><li>• When the computer is off or in Hibernation, opens HP QuickWeb.</li><li>• When the computer is in Microsoft Windows, opens the default Web browser.</li><li>• When the computer is in HP QuickWeb, opens the default Web browser.</li></ul> <p><b>NOTE:</b> If your computer does not have HP QuickWeb software, the button does not perform any action or function.</p>



**NOTE:** For more information, refer to the HP QuickWeb software Help.

---

# 5 Keyboard and pointing devices

- [Using the keyboard](#)
- [Using pointing devices](#)



# Using the keyboard



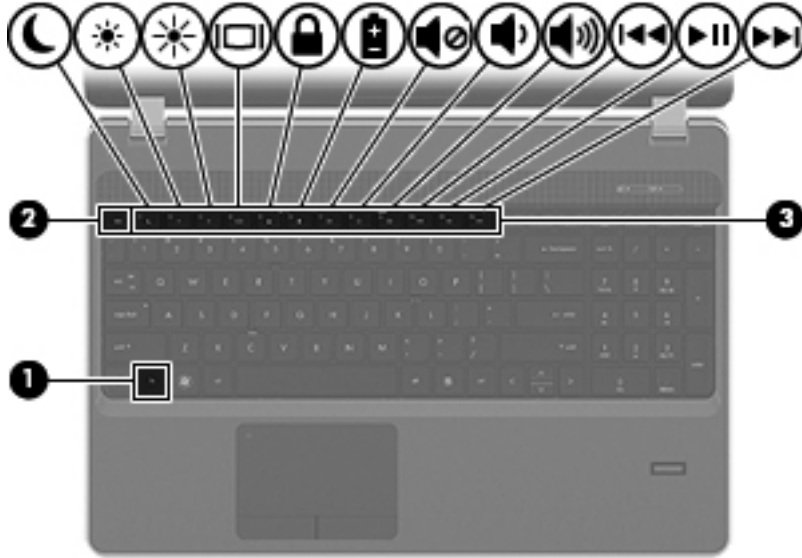

## Identifying the hotkeys









A hotkey is a combination of the **fn** key (1) and either the **esc** key (2) or one of the function keys (3).



To use a hotkey:

- ▲ Briefly press the **fn** key, and then briefly press the second key of the hotkey combination.

Hotkey combination	Description
<b>fn+esc</b>	Displays system information.
 <b>fn+f1</b>	Initiates Sleep, which saves your information in system memory. The display and other system components turn off and power is conserved.  To exit Sleep, briefly press the power button.  <b>CAUTION:</b> To reduce the risk of information loss, save your work before initiating Sleep.  <b>NOTE:</b> If a critical battery level occurs while the computer is in the Sleep state, the computer initiates Hibernation and the information stored in is saved to the hard drive.  The function of the <b>fn+f1</b> hotkey can be changed. For example, you can set the <b>fn+f1</b> hotkey to initiate Hibernation instead of Sleep.
 <b>fn+f2</b>	Decreases the screen brightness level.
 <b>fn+f3</b>	Increases the screen brightness level.
 <b>fn+f4</b>	Switches the screen image among display devices connected to the system. For example, if a monitor is connected to the computer, <b>fn+f4</b> alternates the screen image from computer display to monitor display to simultaneous display on both the computer and the monitor.  Most external monitors receive video information from the computer using the external VGA video standard. The <b>fn+f4</b> hotkey can also alternate images among other devices that are receiving video information from the computer.

Hotkey combination	Description
 <a href="#">fn+f5</a>	Initiates the QuickLock security feature. QuickLock protects your information by displaying the operating system Log On window. While the Log On window is displayed, the computer cannot be accessed until a Windows user password or a Windows administrator password is entered.  <b>NOTE:</b> Before you can use QuickLock, you must set a Windows user password or a Windows administrator password. For instructions, refer to Help and Support.
 <a href="#">fn+f6</a>	Displays charge information for all installed batteries. The display indicates which batteries are charging and reports the amount of charge remaining in each battery.
 <a href="#">fn+f7</a>	Mutes or restores speaker sound.
 <a href="#">fn+f8</a>	Decreases speaker volume.
 <a href="#">fn+f9</a>	Increases speaker volume.
 <a href="#">fn+f10</a>	Plays the previous track of an audio CD or the previous section of a DVD or a BD.
 <a href="#">fn+f11</a>	Plays, pauses, or resumes an audio CD, a DVD, or a BD.
 <a href="#">fn+f12</a>	Plays the next track of an audio CD or the next section of a DVD or a BD.

## Using keypads

The computer includes an embedded numeric keypad or an integrated numeric keypad, depending on the model. The computer also supports an optional external numeric keypad or an optional external keyboard that includes a numeric keypad.

## Using the embedded numeric keypad (select models only)

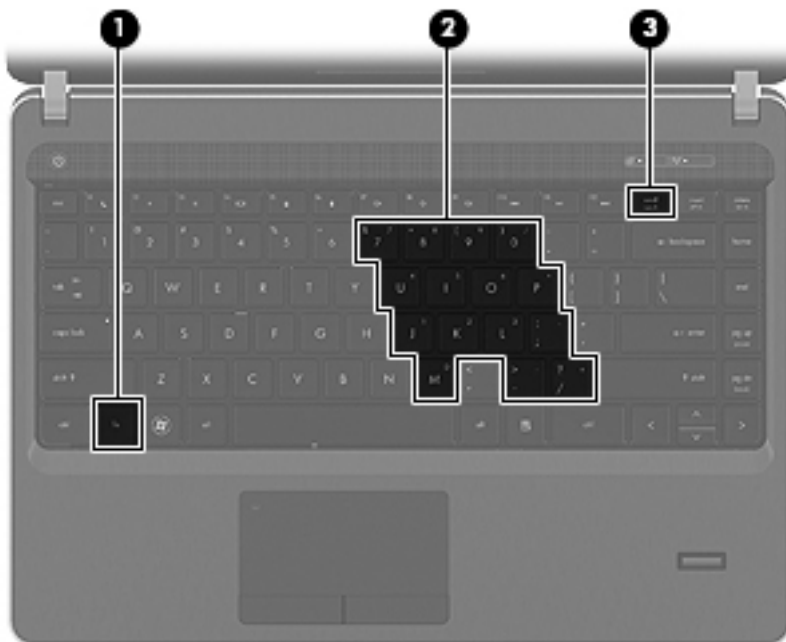

Component	Description
(1) <a href="#">fn</a> key	Turns the embedded numeric keypad on and off when pressed in combination with the <a href="#">num lk</a> key.  <b>NOTE:</b> The embedded numeric keypad will not function while an external keyboard or numeric keypad is connected to the computer.
(2) Embedded numeric keypad	When the keypad is turned on, it can be used like an external numeric keypad.  Each key on the keypad performs the function indicated by the icon in the upper-right corner of the key.
(3) <a href="#">num lk</a> key	Turns the embedded numeric keypad on and off when pressed in combination with the <a href="#">fn</a> key.  <b>NOTE:</b> The keypad function that is active when the computer is turned off is reinstated when the computer is turned back on.

## Turning the embedded numeric keypad on and off

Press **fn+num lk** to turn on the embedded numeric keypad. Press **fn+num lk** again to turn off the keypad.



**NOTE:** The embedded numeric keypad is turned off while an external keyboard or numeric keypad is connected to the computer.

## Switching key functions on the embedded numeric keypad

You can temporarily alternate the functions of keys on the embedded numeric keypad between their standard keyboard functions and their keypad functions:

- To use the numeric function of a keypad key while the keypad is off, press and hold the **fn** key while pressing the keypad key.
- To use the standard function of a keypad key while the keypad is on:
  - Press and hold the **fn** key to type in lowercase.
  - Press and hold **fn+shift** to type in uppercase.

## Using the integrated numeric keypad (select models only)

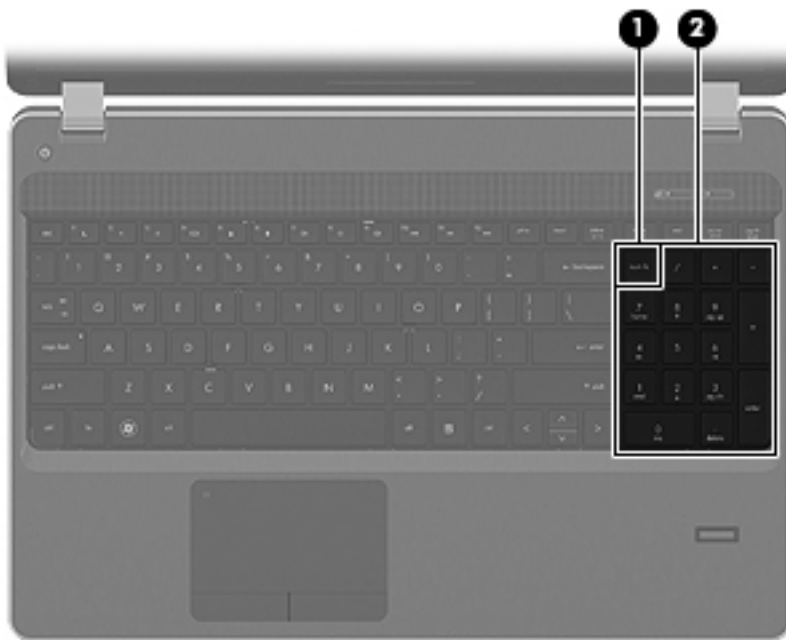

Component	Description
(1) <b>num lk</b> key	Alternates between the navigational and numeric functions on the integrated numeric keypad.  <b>NOTE:</b> The keypad function that is active when the computer is turned off remains on when the computer is turned back on.
(2) Integrated numeric keypad	When the <b>num lk</b> has been enabled, it can be used like an external numeric keypad.

# Using pointing devices

---

 **NOTE:** In addition to the pointing devices included with your computer, you can use an external USB mouse (purchased separately) by connecting it to one of the USB ports on the computer.

---

## Setting pointing device preferences

Use Mouse Properties in Windows to customize settings for pointing devices, such as button configuration, click speed, and pointer options.

To access Mouse Properties:

- **Windows 7**—Select **Start > Devices and Printers**. Then right-click the device representing your computer, and select **Mouse settings**.
- **Windows Vista**—Select **Start > Control Panel > Hardware and Sound > Mouse**.

## Using the TouchPad

To move the pointer, slide one finger across the TouchPad in the direction you want the pointer to go. Use the left and right TouchPad buttons like the buttons on an external mouse. To scroll up and down using the TouchPad vertical scroll zone, slide your finger up or down over the lines.

---

 **NOTE:** If you are using the TouchPad to move the pointer, you must lift your finger off the TouchPad before moving it to the scroll zone. Simply sliding your finger from the TouchPad to the scroll zone does not activate the scrolling function.



---

## Turning the TouchPad off and on

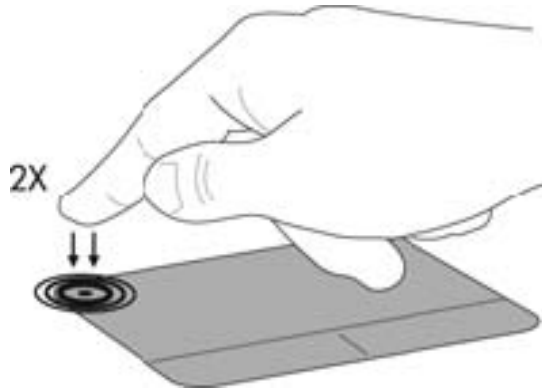
To turn the TouchPad off and on, quickly double-tap the TouchPad on/off button.



The following table shows and describes the TouchPad display icons.

TouchPad light	Item	Description
Amber		Indicates that the TouchPad is off.
Off		Indicates that the TouchPad is on.

## Navigating

To move the pointer, slide one finger across the TouchPad in the direction you want the pointer to go.

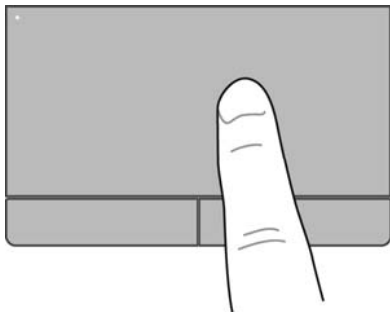

## Selecting

Use the left and right TouchPad buttons like the corresponding buttons on an external mouse.

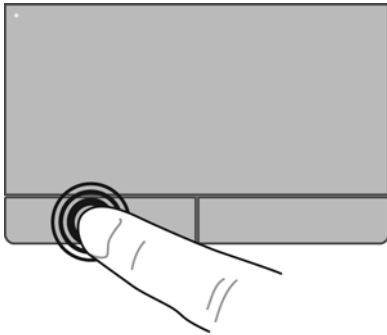

## Using TouchPad gestures

The TouchPad supports a variety of gestures. To use TouchPad gestures, place two fingers on the TouchPad at the same time.

---

 **NOTE:** TouchPad gestures are not supported in all programs.

---

To view the demonstration of a gesture:

1. Click the **Show hidden icons** icon in the notification area, at the far right of the taskbar.
2. Click the **Synaptics Pointing Device** icon , and then click **Pointing Device Properties**.
3. Click the **Device Settings** tab, select the device in the window that is displayed, and then click **Settings**.
4. Select the gesture to activate the demonstration.

To turn the gestures on and off:

1. Click the **Show hidden icons** icon in the notification area, at the far right of the taskbar.
2. Click the **Synaptics Pointing Device** icon , and then click **Pointing Device Properties**.
3. Click the **Device Settings** tab, select the device in the window that is displayed, and then click **Settings**.
4. Select the check box next to the gesture that you want to turn on or off.
5. Click **Apply**, and then click **OK**.

## Scrolling

Scrolling is useful for moving up, down, or sideways on a page or image. To scroll, place two fingers slightly apart on the TouchPad, and then drag them across the TouchPad in an up, down, left, or right motion.

 **NOTE:** Scrolling speed is controlled by finger speed.

---

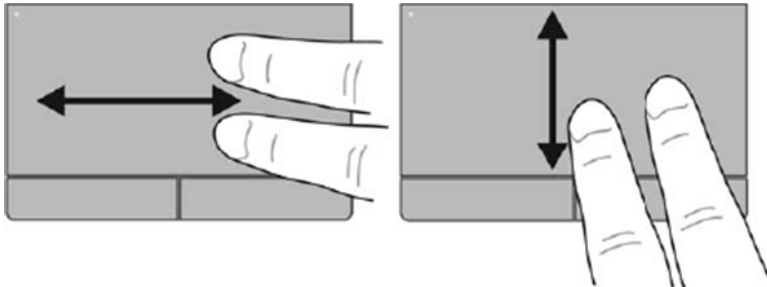

## Pinching/Zooming

Pinching allows you to zoom in or out on images or text.

- Zoom in by placing two fingers together on the TouchPad, and then moving them apart.
- Zoom out by placing two fingers apart on the TouchPad, and then moving them together.

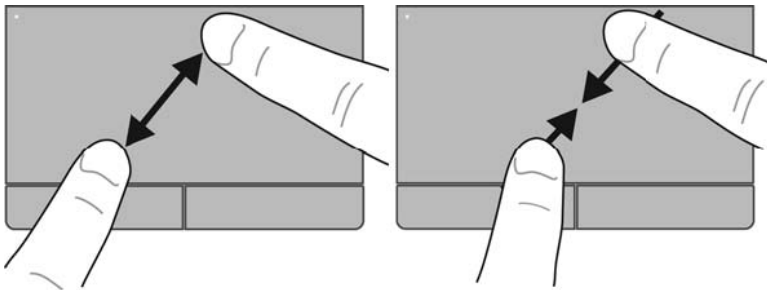

## Rotating

Rotating allows you to rotate items such as photos. To rotate, anchor your left forefinger in the TouchPad zone. Move the right forefinger around the anchored finger in a sweeping motion, moving from 12 o'clock to 3 o'clock. To reverse the rotation, move your right forefinger from 3 o'clock to 12 o'clock.

 **NOTE:** Rotating must be done within the TouchPad zone.

---

 **NOTE:** Rotating is disabled at the factory.

---



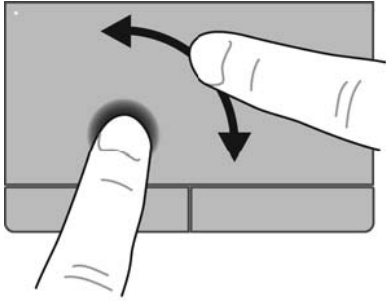

## Flicking

Flicking allows you to navigate through screens or quickly scroll through documents. To flick, use three fingers to touch the TouchPad zone in a light, quick flicking motion up, down, left, or right.



**NOTE:** Three-finger flicking is disabled at the factory.

---

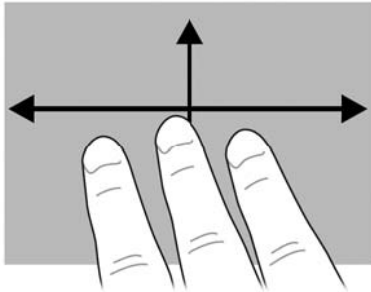

---

# 6 Maintenance

- [Inserting or removing the battery](#)
- [Using the optional security screw](#)
- [Replacing or upgrading the hard drive](#)
- [Adding or replacing memory modules](#)
- [Updating programs and drivers](#)
- [Using SoftPaq Download Manager](#)
- [Cleaning your computer](#)

## Inserting or removing the battery



**NOTE:** For additional information on using the battery, refer to the *HP Notebook Reference Guide*.

To insert the battery:

- ▲ Insert the battery **(1)** into the battery bay until it is seated **(2)**.

The battery release latches automatically lock the battery into place.

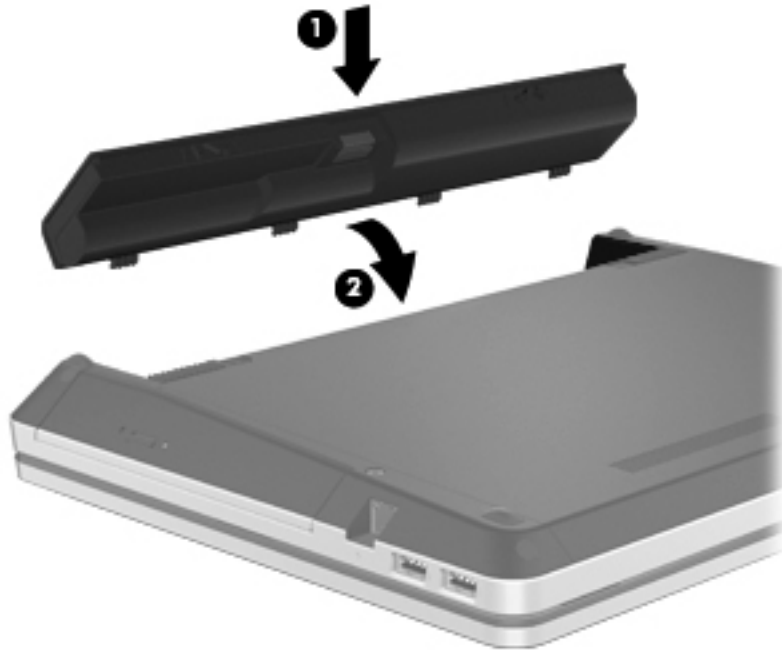

To remove the battery:

---

**⚠ CAUTION:** Removing a battery that is the sole power source for the computer can cause loss of information. To prevent loss of information, save your work and initiate Hibernation or shut down the computer through Windows before removing the battery.

---

1. Slide the battery release latches **(1)** to release the battery.

2. Slide the battery up (2), and remove the battery from the battery bay (3).

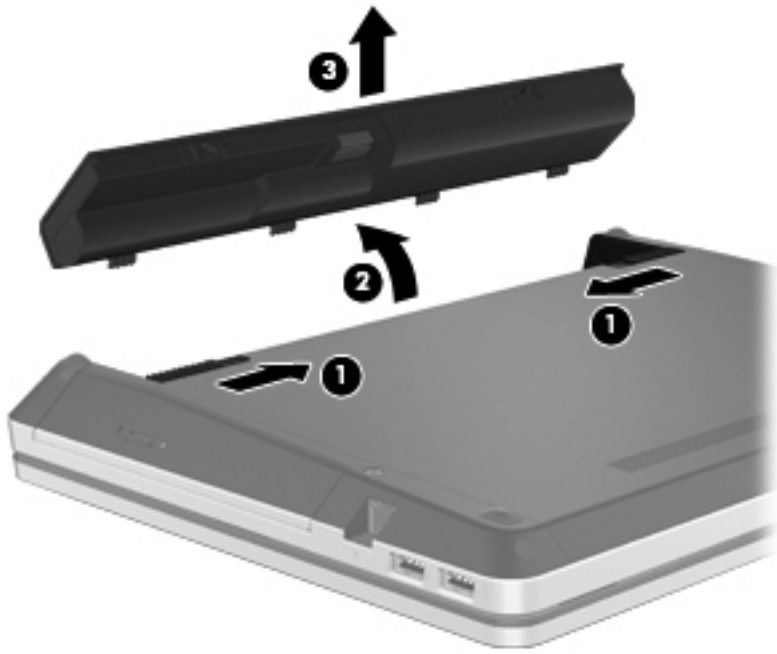

## Using the optional security screw

Use the optional security screw to lock the access cover to the bottom of the computer. When not in use the security screw can be stored inside the battery bay.

To use the security screw:

1. Remove the battery.

**⚠ CAUTION:** Removing a battery that is the sole power source for the computer can cause loss of information. To prevent loss of information, save your work and initiate Hibernation or shut down the computer through Windows before removing the battery.

2. Remove the security screw from inside the battery bay (1) and insert it into the access cover (2) to lock the access cover in place.

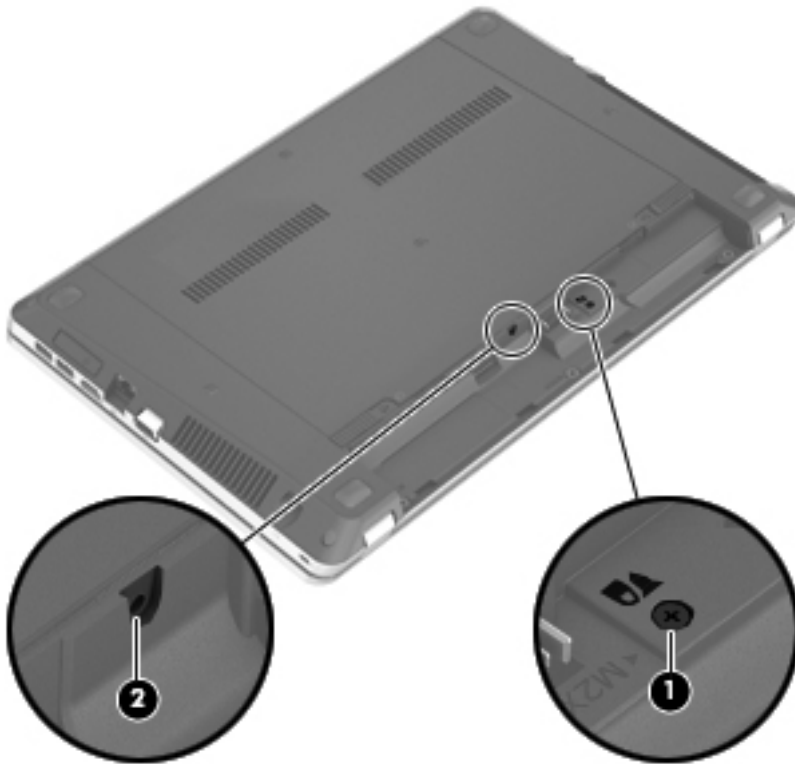

## Replacing or upgrading the hard drive

**CAUTION:** To prevent information loss or an unresponsive system:

Shut down the computer before removing the hard drive from the hard drive bay. Do not remove the hard drive while the computer is on, in the Sleep state, or in Hibernation.

If you are not sure whether the computer is off or in Hibernation, turn the computer on by pressing the power button. Then shut down the computer through the operating system.

### Removing the hard drive

1. Save your work and shut down the computer.
2. Disconnect AC power and external devices connected to the computer.
3. Remove the battery.
4. Remove the security screw (1), if in use. For additional information about the security screw, refer to [Using the optional security screw on page 37](#).
5. Slide the access cover release latches (2) to release the cover.
6. Slide the access cover (3) back, and then lift it away from the computer (4).

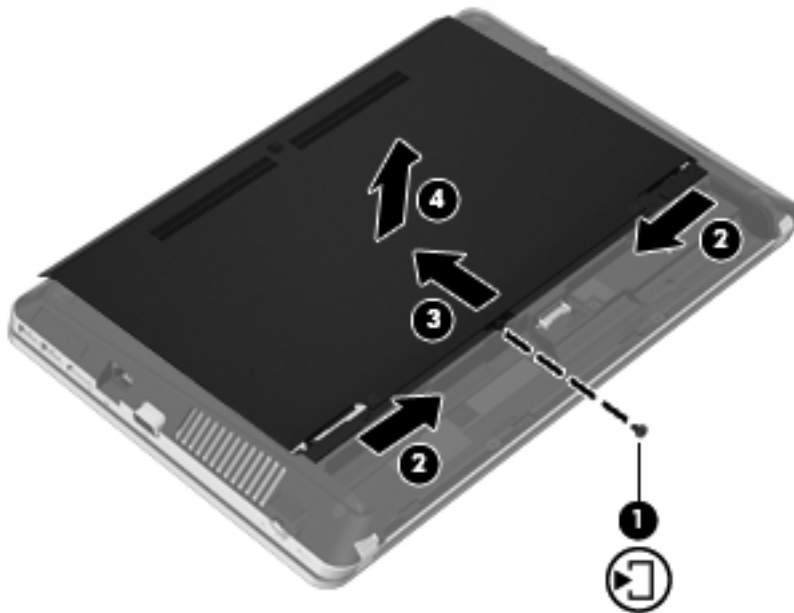

7. Remove the four hard drive screws (1) from the hard drive.
8. Pull the hard drive tab (2) to the right to disconnect the hard drive.

9. Lift the hard drive **(3)** out of the hard drive bay.

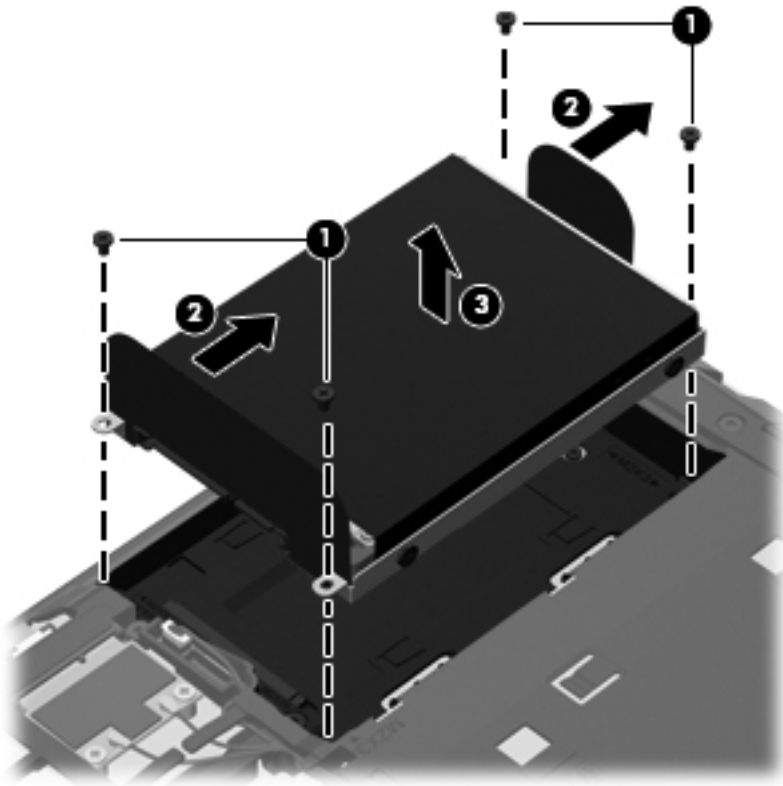

## Installing a hard drive

1. Insert the hard drive into the hard drive bay **(1)**.
2. Pull the hard drive tab **(2)** to the left until the hard drive is fully seated.

3. Replace the four hard drive screws (3).

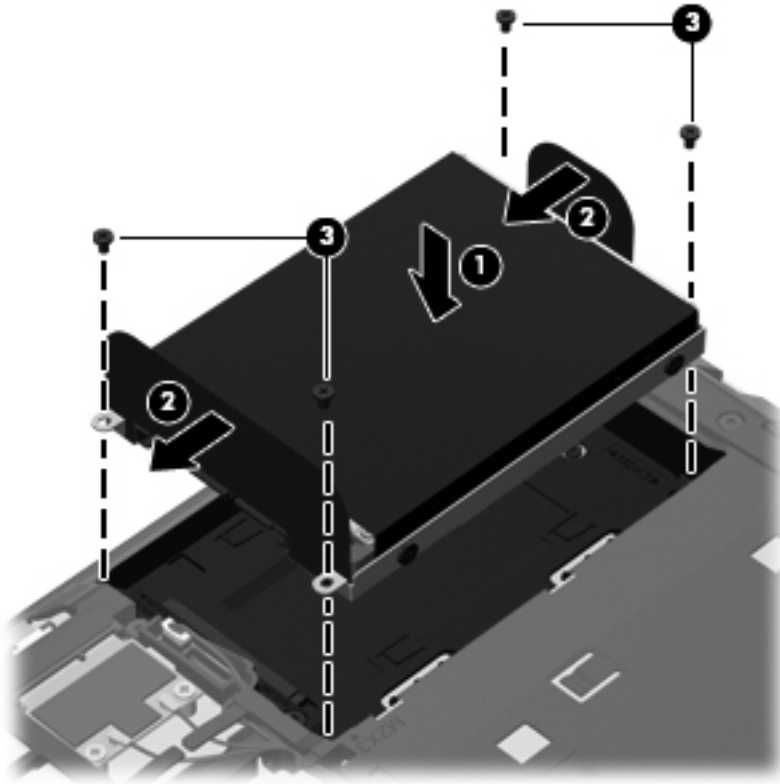

4. Align the tabs on the access cover with the latches on the computer (1), then slide the cover in to close it (2).

The release latches automatically lock the access cover into place (3).



5. Replace the security screw (4), if desired. For additional information about the security screw, refer to [Using the optional security screw on page 37](#).

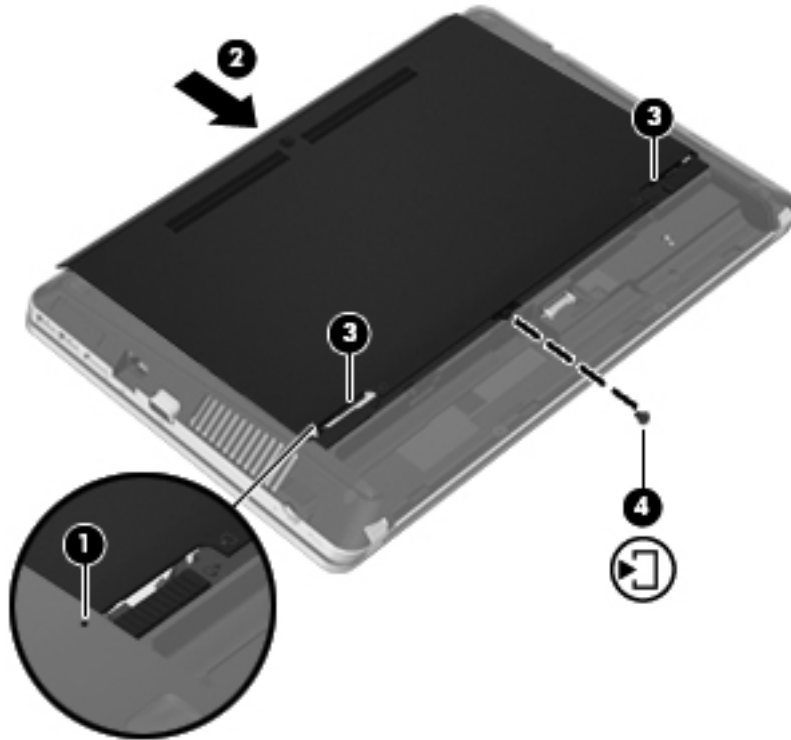

6. Replace the battery.
7. Connect AC power and external devices to the computer.
8. Turn on the computer.

## Adding or replacing memory modules

The computer has two memory module slots. The capacity of the computer can be upgraded by adding a memory module to the vacant expansion memory module slot or by upgrading the existing memory module in the primary memory module slot.

**WARNING!** To reduce the risk of electric shock and damage to the equipment, unplug the power cord and remove all batteries before installing a memory module.

**CAUTION:** Electrostatic discharge (ESD) can damage electronic components. Before beginning any procedure, ensure that you are discharged of static electricity by touching a grounded metal object.

**NOTE:** To use a dual-channel configuration when adding a second memory module, be sure that both memory modules are identical.

To add or replace a memory module:

**CAUTION:** To prevent information loss or an unresponsive system:

Shut down the computer before adding or replacing memory modules. Do not remove a memory module while the computer is on, in the Sleep state, or in Hibernation.

If you are not sure whether the computer is off or in Hibernation, turn the computer on by pressing the power button. Then shut down the computer through the operating system.

1. Save your work and shut down the computer.
2. Disconnect AC power and external devices connected to the computer.
3. Remove the battery.
4. Remove the security screw (1), if in use. For additional information about the security screw, refer to [Using the optional security screw on page 37](#).
5. Slide the access cover release latches (2) to release the cover.
6. Slide the access cover (3) back, and then lift it away from the computer (4).

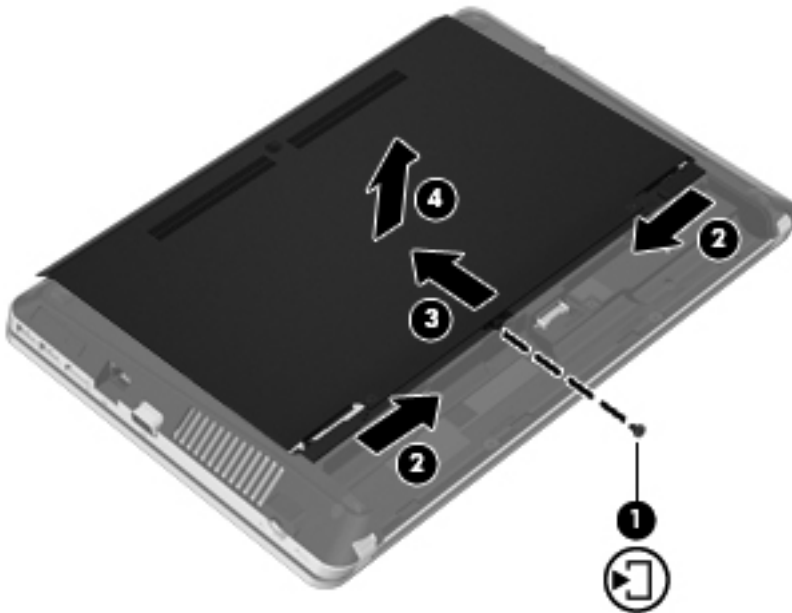

7. If you are replacing a memory module, remove the existing memory module:
  - a. Pull away the retention clips (1) on each side of the memory module.  
The memory module tilts up.



- c. Gently press the memory module **(3)** down, applying pressure to both the left and right edges of the memory module, until the retention clips snap into place.

**⚠ CAUTION:** To prevent damage to the memory module, be sure that you do not bend the memory module.



9. Align the tabs on the access cover with the latches on the computer **(1)**, then slide the cover in to close it **(2)**.

The release latches automatically lock the access cover into place **(3)**.

10. Replace the security screw (4), if desired. For additional information about the security screw, refer to [Using the optional security screw on page 37](#).

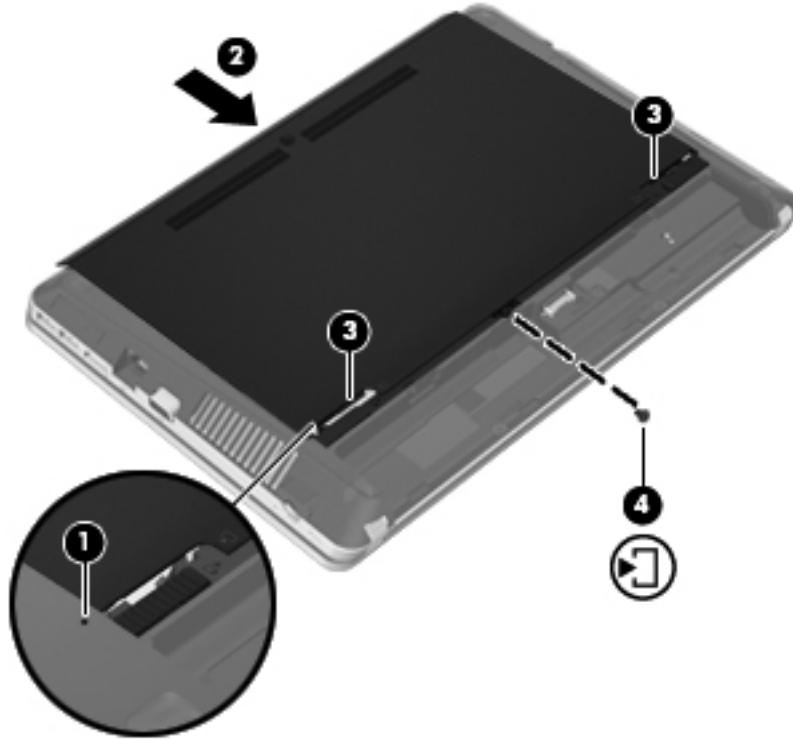

11. Replace the battery.
12. Connect AC power and external devices to the computer.
13. Turn on the computer.

## Updating programs and drivers

HP recommends that you update your programs and drivers on a regular basis with the latest versions. Go to <http://www.hp.com/support> to download the latest versions. You can also register to receive automatic update notifications when they become available.

## Using SoftPaq Download Manager

HP SoftPaq Download Manager (SDM) is a tool that provides quick access to SoftPaq information for HP business computers without requiring the SoftPaq number. Using this tool, you can easily search for SoftPaqs, and then download and unpack them.

SoftPaq Download Manager works by reading and downloading, from the HP FTP site, a published database file containing computer model and SoftPaq information. SoftPaq Download Manager allows you to specify one or more computer models to determine which SoftPaqs are available for download.

SoftPaq Download Manager checks the HP FTP site for updates to the database and software. If updates are found, they are downloaded and applied automatically.

SoftPaq Download Manager is available on the HP Web site. To use SoftPaq Download Manager to download SoftPaqs, you must first download and install the program. Go to the HP Web site at <http://www.hp.com/go/sdm>, and follow the instructions to download and install SoftPaq Download Manager.

To download SoftPaqs:

1. Select **Start > All Programs > HP > HP SoftPaq Download Manager**.
2. When SoftPaq Download Manager opens for the first time, a window is displayed asking if you want to show only software for the computer you are using or to show the software for all supported models. Select **Show software for all supported models**. If you have used HP SoftPaq Download Manager previously, go to Step 3.
  - a. Select your operating system and language filters in the Configuration Options window. The filters limit the number of options that are listed in the Product Catalog pane. For example, if only Windows 7 Professional is selected in the operating system filter, the only operating system that is displayed in the Product Catalog is Windows 7 Professional.
  - b. To add other operating systems, change the filter settings in the Configuration Options window. Refer to the HP SoftPaq Download Manager software Help for more information.
3. In the left pane, click the plus sign (+) to expand the model list, and then select the model or models of the products you want to update.
4. Click **Find Available SoftPaqs** to download a list of available SoftPaqs for the selected computer.
5. Select from the list of available SoftPaqs, and then click **Download Only** if you have many SoftPaqs to download, because the SoftPaq selection and Internet connection speed determine how long the download process will take.

If you want to download only one or two SoftPaqs and have a high-speed Internet connection, click **Download & Unpack**.

6. Right-click **Install SoftPaq** in the SoftPaq Download Manager software to install the selected SoftPaqs on the computer.

# Cleaning your computer

- [Cleaning products](#)
- [Cleaning procedures](#)

## Cleaning products

Use the following products to safely clean and disinfect your notebook or tablet PC:

- Dimethyl benzyl ammonium chloride 0.3 percent maximum concentration (For example: germicidal disposable wipes. These wipes come in a variety of brand names.)
- Alcohol-free glass cleaning fluid
- Water with mild soap solution
- Dry microfiber cleaning cloth or a chamois (static-free cloth without oil)
- Static-free cloth wipes

---

 **CAUTION:** Avoid the following cleaning products:

Strong solvents, such as alcohol, acetone, ammonium chloride, methylene chloride, and hydrocarbons, which can permanently damage the surface of the notebook or the tablet PC.

Fibrous materials, such as paper towels, which can scratch the notebook or tablet PC. Over time, dirt particles and cleaning agents can get trapped in the scratches.

---

## Cleaning procedures

Follow the procedures in this section to safely clean your notebook or tablet PC.

---

 **WARNING!** To prevent electric shock or damage to components, do not attempt to clean your notebook or tablet PC while it is turned on:

Turn off the notebook or tablet PC.

Disconnect external power.

Disconnect all powered external devices.

---

 **CAUTION:** Do not spray cleaning agents or liquids directly on any notebook or tablet PC surface. Liquids dripped on the surface can permanently damage internal components.

---

## Cleaning the display

Gently wipe the display using a soft, lint-free cloth moistened with an *alcohol-free* glass cleaner. Be sure that the display is dry before closing the display.

## Cleaning the sides and cover

To clean and disinfect the sides and cover, use a soft microfiber cloth or chamois moistened with one of the cleaning solutions listed in [Cleaning products on page 47](#) or use an acceptable germicidal disposable wipe.

---

 **NOTE:** When cleaning the cover of the notebook, use a circular motion to aid in removing dirt and debris.

---

## Cleaning the TouchPad and keyboard

---

**⚠ WARNING!** To reduce the risk of electric shock or damage to internal components, do not use a vacuum cleaner attachment to clean the keyboard. A vacuum cleaner can deposit household debris on the keyboard surface.

**⚠ CAUTION:** When cleaning the TouchPad and keyboard, do not let liquids drip between the keys. This can permanently damage internal components.

---

- To clean and disinfect the TouchPad and keyboard, use a soft microfiber cloth or chamois moistened with one of the cleaning solutions listed in [Cleaning products on page 47](#) or use an acceptable germicidal disposable wipe.
- To prevent keys from sticking and to remove dust, lint, and particles from the keyboard, use a can of compressed air with a straw extension.



---

# 7 Backup and recovery

## Windows 7

- [Backing up your information](#)
- [Performing a system recovery](#)

To protect your information, use Windows Backup and Restore to back up individual files and folders, back up your entire hard drive (select models only), create system repair discs (select models only) by using the installed optical drive (select models only) or an optional external optical drive, or create system restore points. In case of system failure, you can use the backup files to restore the contents of your computer.

Windows Backup and Restore provides the following options:

- Creating a system repair disc (select models only) by using the installed optical drive (select models only) or an optional external optical drive
- Backing up your information
- Creating a system image (select models only)
- Scheduling automatic backups (select models only)
- Creating system restore points
- Recovering individual files
- Restoring the computer to a previous state
- Recovering information using recovery tools

---

 **NOTE:** For detailed instructions, perform a search for these topics in Help and Support.

In case of system instability, HP recommends that you print the recovery procedures and save them for later use.

 **NOTE:** Windows includes the User Account Control feature to improve the security of your computer. You may be prompted for your permission or password for tasks such as installing software, running utilities, or changing Windows settings. Refer to Help and Support for more information.

---

## Backing up your information

Recovery after a system failure is as good as your most recent backup. You should create system repair discs (select models only) by using the installed optical drive (select models only) or an optional external optical drive, and your initial backup immediately after software setup. As you add

new software and data files, you should continue to back up your system on a regular basis to maintain a reasonably current backup. The system repair discs (select models only) are used to start up (boot) the computer and repair the operating system in case of system instability or failure. Your initial and subsequent backups allow you to restore your data and settings if a failure occurs.

You can back up your information to an optional external hard drive, a network drive, or discs.

Note the following when backing up:

- Store personal files in the Documents library, and back it up regularly.
- Back up templates that are stored in their associated programs.
- Save customized settings that appear in a window, toolbar, or menu bar by taking a screen shot of your settings. The screen shot can be a time-saver if you have to reset your preferences.
- When backing up to discs, use any of the following types of discs (purchased separately): CD-R, CD-RW, DVD+R, DVD+R DL, DVD-R, DVD-R DL, or DVD±RW. The discs you use will depend on the type of external optical drive you are using.

---

 **NOTE:** DVDs and DVDs with double-layer (DL) support store more information than CDs, so using them for backup reduces the number of recovery discs required.

---

- When backing up to discs, number each disc before inserting it into the external drive.

To create a backup using Backup and Restore:

---

 **NOTE:** Be sure that the computer is connected to AC power before you start the backup process.

---

 **NOTE:** The backup process may take over an hour, depending on file size and the speed of the computer.

---

1. Select **Start > All Programs > Maintenance > Backup and Restore**.
2. Follow the on-screen instructions to set up your backup, create a system image (select models only), or create a system repair disc (select models only).

## Performing a system recovery

In case of system failure or instability, the computer provides the following tools to recover your files:

- Windows recovery tools: You can use Windows Backup and Restore to recover information you have previously backed up. You can also use Windows Startup Repair to fix problems that might prevent Windows from starting correctly.
- f11 recovery tools: You can use the f11 recovery tools to recover your original hard drive image. The image includes the Windows operating system and software programs installed at the factory.

---

 **NOTE:** If you are unable to boot (start up) your computer and you cannot use the system repair discs you previously created (select models only), you must purchase a Windows 7 operating system DVD to reboot the computer and repair the operating system. For additional information, refer to [Using a Windows 7 operating system DVD \(purchased separately\) on page 52](#).

---

## Using the Windows recovery tools

To recover information you previously backed up:

1. Select **Start > All Programs > Maintenance > Backup and Restore**.
2. Follow the on-screen instructions to recover your system settings, your computer (select models only), or your files.

To recover your information using Startup Repair, follow these steps:

---

 **CAUTION:** Using Startup Repair completely erases hard drive contents and reformats the hard drive. All files you have created and any software installed on the computer are permanently removed. When reformatting is complete, the recovery process restores the operating system, as well as the drivers, software, and utilities from the backup used for recovery.

---

1. If possible, back up all personal files.
2. If possible, check for the presence of the Windows partition and the HP Recovery partition.

To check for the Windows partition, select **Start > Computer**.

To check for the HP Recovery partition, click **Start**, right-click **Computer**, click **Manage**, and then click **Disk Management**.

---

 **NOTE:** If the Windows partition and the HP Recovery partition are not listed, you must recover your operating system and programs using the Windows 7 operating system DVD and the *Driver Recovery* disc (both purchased separately). For additional information, refer to [Using a Windows 7 operating system DVD \(purchased separately\) on page 52](#).

---

3. If the Windows partition and the HP Recovery partition are listed, restart the computer, and then press **f8** before the Windows operating system loads.
4. Select **Startup Repair**.
5. Follow the on-screen instructions.

---

 **NOTE:** For additional information on recovering information using the Windows tools, perform a search for these topics in Help and Support.

---

## Using f11 recovery tools

---

 **CAUTION:** Using **f11** completely erases hard drive contents and reformats the hard drive. All files you have created and any software installed on the computer are permanently removed. The **f11** recovery tool reinstalls the operating system and HP programs and drivers that were installed at the factory. Software not installed at the factory must be reinstalled.

---

To recover the original hard drive image using **f11**:

1. If possible, back up all personal files.
2. If possible, check for the presence of the HP Recovery partition: click **Start**, right-click **Computer**, click **Manage**, and then click **Disk Management**.

---

 **NOTE:** If the HP Recovery partition is not listed, you must recover your operating system and programs using the Windows 7 operating system DVD and the *Driver Recovery* disc (both purchased separately). For additional information, refer to [Using a Windows 7 operating system DVD \(purchased separately\) on page 52](#).

---

3. If the HP Recovery partition is listed, restart the computer, and then press **esc** while the “Press the ESC key for Startup Menu” message is displayed at the bottom of the screen.
4. Press **f11** while the “Press <F11> for recovery” message is displayed on the screen.
5. Follow the on-screen instructions.

## Using a Windows 7 operating system DVD (purchased separately)

To order a Windows 7 operating system DVD, go to <http://www.hp.com/support>, select your country or region, and follow the on-screen instructions. You can also order the DVD by calling technical support. For contact information, refer to the *Worldwide Telephone Numbers* booklet included with the computer.

---

 **CAUTION:** Using a Windows 7 operating system DVD completely erases hard drive contents and reformats the hard drive. All files you have created and any software installed on the computer are permanently removed. When reformatting is complete, the recovery process helps you restore the operating system, as well as drivers, software, and utilities.

---

To initiate recovery using a Windows 7 operating system DVD:

---

 **NOTE:** This process takes several minutes.

---

1. If possible, back up all personal files.
2. Restart the computer, and then insert the Windows 7 operating system DVD into the optical drive before the Windows operating system loads.
3. When prompted, press any keyboard key.
4. Follow the on-screen instructions.
5. Click **Next**.
6. Select **Repair your computer**.
7. Follow the on-screen instructions.

After the repair is completed:

1. Eject the Windows 7 operating system DVD, and then insert the *Driver Recovery* disc.
2. Install the Hardware Enabling Drivers first, and then install Recommended Applications.

# Windows Vista

To protect your information, use the Backup and Restore Center to back up individual files and folders, back up your entire hard drive (select models only), or create system restore points. In case of system failure, you can use the backup files to restore the contents of your computer.

The Backup and Restore Center provides the following options:

- Backing up individual files and folders
- Backing up the entire hard drive (select models only)
- Scheduling automatic backups (select models only)
- Creating system restore points
- Recovering individual files
- Restoring the computer to a previous state
- Recovering information using recovery tools

---

 **NOTE:** For detailed instructions, perform a search for these topics in Help and Support.

 **NOTE:** In case of system instability, HP recommends that you print the recovery procedures and save them for later use.

 **NOTE:** Windows® includes the User Account Control feature to improve the security of your computer. You may be prompted for your permission or password for tasks such as installing software, running utilities, or changing Windows settings. Refer to Help and Support for more information.

---

## Backing up your information

Recovery after a system failure is as complete as your most current backup. You should create your initial backup immediately after software setup. As you add new software and data files, you should continue to back up your system on a regular basis to maintain a reasonably current backup.

You can back up your information to an optional external hard drive, a network drive, or discs.

Note the following when backing up:

- Store personal files in the Documents folder, and back it up regularly.
- Back up templates that are stored in their associated programs.
- Save customized settings that appear in a window, toolbar, or menu bar by taking a screen shot of your settings. The screen shot can be a time-saver if you have to reset your preferences.
- When backing up to discs, use any of the following types of discs (purchased separately): CD-R, CD-RW, DVD+R, DVD+R DL, DVD-R, DVD-R DL, or DVD±RW. The discs you use will depend on the type of optical drive installed in your computer.

---

 **NOTE:** DVDs and DVDs with double-layer (DL) support store more information than CDs, so using them for backup reduces the number of recovery discs required.

---

- When backing up to discs, number each disc before inserting it into the optical drive of the computer.

To create a backup using Backup and Restore Center:

---

 **NOTE:** Be sure that the computer is connected to AC power before you start the backup process.

 **NOTE:** The backup process may take over an hour, depending on file size and the speed of the computer.

---

1. Select **Start > All Programs > Maintenance > Backup and Restore Center**.
2. Follow the on-screen instructions to back up your entire computer (select models only) or your files.

## Performing a recovery

In case of system failure or instability, the computer provides the following tools to recover your files:

- Windows recovery tools: You can use the Backup and Restore Center to recover information you have previously backed up. You can also use Windows Startup Repair to fix problems that might prevent Windows from starting correctly.
- **f11** recovery tools: You can use the **f11** recovery tools to recover your original hard drive image. The image includes the Windows operating system and software programs installed at the factory.

---

 **NOTE:** If you are unable to boot (start up) your computer, you must purchase a Windows Vista® operating system DVD to reboot the computer and repair the operating system. For additional information, refer to [Using a Windows Vista operating system DVD \(purchased separately\) on page 55](#).

---

## Using the Windows recovery tools

To recover information you previously backed up:

1. Select **Start > All Programs > Maintenance > Backup and Restore Center**.
2. Follow the on-screen instructions to recover your entire computer (select models only) or your files.

To recover your information using Startup Repair, follow these steps:

---

 **CAUTION:** Using Startup Repair completely erases hard drive contents and reformats the hard drive. All files you have created and any software installed on the computer are permanently removed. When reformatting is complete, the recovery process restores the operating system, as well as the drivers, software, and utilities from the backup used for recovery.

---

1. If possible, back up all personal files.
2. If possible, check for the presence of the Windows partition and the HP Recovery partition. To find the partitions, select **Start > Computer**.

---

 **NOTE:** If the Windows partition and the HP Recovery partition have been deleted, you must recover your operating system and programs using the Windows Vista operating system DVD and the *Driver Recovery* disc (both purchased separately). For additional information, refer to [Using a Windows Vista operating system DVD \(purchased separately\) on page 55](#).

---

3. Restart the computer, and then press **f8** before the Windows operating system loads.

4. Select **Repair your computer**.
5. Follow the on-screen instructions.

 **NOTE:** For additional information on recovering information using the Windows tools, perform a search for these topics in Help and Support.

---

## Using f11 recovery tools

 **CAUTION:** Using **f11** completely erases hard drive contents and reformats the hard drive. All files you have created and any software installed on the computer are permanently removed. The **f11** recovery tool reinstalls the operating system and HP programs and drivers that were installed at the factory. Software not installed at the factory must be reinstalled. Personal files must be restored from a backup.

 **NOTE:** If your computer includes a solid-state drive (SSD), you may not have a recovery partition. Recovery discs have been included for computers that do not have a partition. Use these discs to recover your operating system and software. To check for the presence of a recovery partition, select **Start > Computer**. If the partition is present, an HP Recovery drive is listed in the Hard Disk Drives section of the window.

---

To recover the original hard drive image using **f11**, follow these steps:

1. If possible, back up all personal files.
2. If possible, check for the presence of the HP Recovery partition. To find the partition, select **Start > Computer**.

 **NOTE:** If the HP Recovery partition has been deleted, you must recover your operating system and programs using the Windows Vista operating system DVD and the *Driver Recovery* disc (both purchased separately). For additional information, refer to [Using a Windows Vista operating system DVD \(purchased separately\) on page 55](#).

---

3. Turn on or restart the computer, and then press **esc** while the “Press the ESC key for Startup Menu” message is displayed at the bottom of the screen.
4. Press **f11** while the “Press <F11> for recovery” message is displayed on the screen.
5. Follow the on-screen instructions.

## Using a Windows Vista operating system DVD (purchased separately)

To order a Windows Vista operating system DVD, go to <http://www.hp.com/support>, select your country or region, and follow the on-screen instructions. You can also order the DVD by calling technical support. For contact information, refer to the *Worldwide Telephone Numbers* booklet included with the computer.

 **CAUTION:** Using a Windows Vista operating system DVD completely erases hard drive contents and reformats the hard drive. All files you have created and any software installed on the computer are permanently removed. When reformatting is complete, the recovery process helps you restore the operating system, as well as drivers, software, and utilities.

---

To initiate recovery using a Windows Vista operating system DVD:



---

**NOTE:** This process takes several minutes.

---

1. If possible, back up all personal files.
2. Restart the computer, and then insert the Windows Vista operating system DVD into the optical drive before the Windows operating system loads.
3. When prompted, press any keyboard key.
4. Follow the on-screen instructions.
5. Click **Next**.
6. Select **Repair your computer**.
7. Follow the on-screen instructions.

After the repair is completed:

1. Eject the Windows Vista operating system DVD, and then insert the *Driver Recovery* disc.
2. Install the Hardware Enabling Drivers first, and then install Recommended Applications.



---

# 8 Customer support

- [Contacting customer support](#)
- [Labels](#)

## Contacting customer support

If the information provided in this user guide, in the *HP Notebook Reference Guide*, or in Help and Support does not address your questions, you can contact HP Customer Support at:

<http://www.hp.com/go/contactHP>

---

 **NOTE:** For worldwide support, click **Contact HP worldwide** on the left side of the page, or go to [http://welcome.hp.com/country/us/en/wwcontact\\_us.html](http://welcome.hp.com/country/us/en/wwcontact_us.html).

---

Here you can:

- Chat online with an HP technician.

---

 **NOTE:** When technical support chat is not available in a particular language, it is available in English.

---

- E-mail HP Customer Support.
- Find HP Customer Support worldwide telephone numbers.
- Locate an HP service center.

# Labels

The labels affixed to the computer provide information you may need when you troubleshoot system problems or travel internationally with the computer:

- Serial number label—Provides important information, including the following:

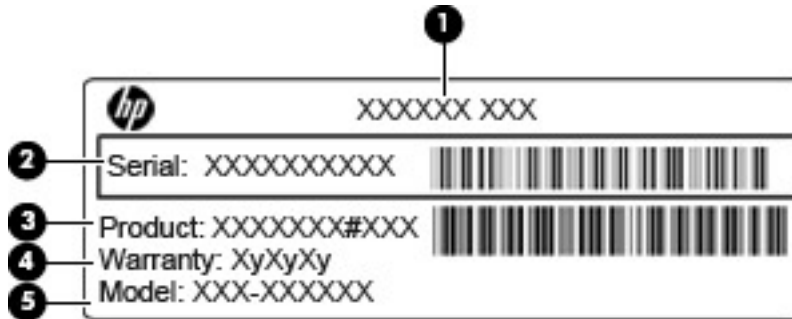

Component	
(1)	Product name
(2)	Serial number (s/n)
(3)	Part number/Product number (p/n)
(4)	Warranty period
(5)	Model description

Have this information available when you contact technical support. The serial number label is affixed inside the battery bay.

- Microsoft® Certificate of Authenticity—Contains the Windows Product Key. You may need the Product Key to update or troubleshoot the operating system. The Microsoft Certificate of Authenticity is affixed inside the battery bay.
- Regulatory label—Provides regulatory information about the computer. The regulatory label is affixed inside the battery bay.
- Wireless certification label or labels (select models only)—Provide information about optional wireless devices and the approval markings of some of the countries or regions in which the devices have been approved for use. If your computer model includes one or more wireless devices, one or more certification labels are included with your computer. You may need this information when traveling internationally. Wireless certification labels are affixed inside the battery bay.
- SIM (subscriber identity module) label (select models only)—Provides the ICCID (Integrated Circuit Card Identifier) of the SIM. This label is located inside the battery bay.
- HP Mobile Broadband Module serial number label (select models only)—Provides the serial number of the HP Mobile Broadband Module. This label is located inside the battery bay.

---

# 9 Specifications

- [Input power](#)
- [Operating environment](#)

## Input power

The power information in this section may be helpful if you plan to travel internationally with the computer.

The computer operates on DC power, which can be supplied by an AC or a DC power source. The AC power source must be rated at 100–240 V, 50–60 Hz. Although the computer can be powered from a standalone DC power source, it should be powered only with an AC adapter or a DC power source supplied and approved by HP for use with this computer.

The computer can operate on DC power within the following specifications.

Input power	Rating
Operating voltage and current	18.5 V dc @ 3.5 A - 65W
	19 V dc @ 4.74 A - 90W

 **NOTE:** This product is designed for IT power systems in Norway with phase-to-phase voltage not exceeding 240 V rms.

 **NOTE:** The computer operating voltage and current can be found on the system regulatory label.

## Operating environment

<b>Factor</b>	<b>Metric</b>	<b>U.S.</b>
<b>Temperature</b>		
Operating (writing to optical disc)	<b>5°C to 35°C</b>	41°F to 95°F
Nonoperating	<b>-20°C to 60°C</b>	-4°F to 140°F
<b>Relative humidity</b> (noncondensing)		
Operating	<b>10% to 90%</b>	10% to 90%
Nonoperating	<b>5% to 95%</b>	5% to 95%
<b>Maximum altitude</b> (unpressurized)		
Operating	<b>-15 m to 3,048 m</b>	-50 ft to 10,000 ft
Nonoperating	<b>-15 m to 12,192 m</b>	-50 ft to 40,000 ft

---

# Index

## Symbols/Numerics

6-in-1 Media Card Reader 11

## A

access cover

removing 38, 41

replacing 39, 44

security screw 37

access cover release latches 16

audio-in (microphone) jack 11

audio-out (headphone) jack 11

## B

Backup and Restore 50

Backup and Restore Center 53, 54

battery

removing 34

replacing 34

battery bay 16, 58

Battery light 13

battery release latches 16

Bluetooth label 58

buttons

left TouchPad 5

optical drive eject 12

power 7

QuickWeb 8

right TouchPad 5

TouchPad on/off 5

wireless 8

## C

caps lock light, identifying 6

caring for your computer 47

Certificate of Authenticity label 58

cleaning your computer 47

components

bottom 16

display 15

front 11

left side 13

right side 12

top 5

## D

display image, switching 25

drives

optical 12

## E

embedded numeric keypad,  
identifying 9, 27

esc key, identifying 9, 10

ExpressCard slot, identifying 13

external monitor port 13

## F

f11 recovery 51, 55

fingerprint reader, identifying 8

flicking TouchPad gesture 33

fn key, identifying 9, 10, 25, 27

function keys

identifying 9, 10

## H

hard drive

installing 39

removing 38

hard drive bay, identifying 16

hard drive light 11

hard drive recovery 51, 55

HDMI port, identifying 13

hotkeys

adjusting volume 26

audio CD, DVD, or BD

controls 26

battery charge 26

decrease screen brightness  
25

description 25

increase screen brightness 25

muting speaker sound 26

QuickLock 26

Sleep 25

switching screen image 25

using 25

## I

input power 60

integrated numeric keypad,  
identifying 10, 28

integrated webcam light,  
identifying 15

internal display switch 15

internal microphones, identifying  
15

Internet connection setup 20

ISP, using 18

## J

jacks

audio-in (microphone) 11

audio-out (headphone) 11

network 13

RJ-11 (modem) 12

RJ-45 (network) 13

## K

keyboard hotkeys, identifying 25

keypad, embedded numeric 9

keypad, integrated numeric 10

keypads, identifying 27, 28

keys

esc 9, 10

fn 9, 10, 27

function 9, 10

- num lk 9, 10
  - Windows Applications 9, 10
  - Windows logo 9, 10
- L**
- labels
    - Bluetooth 58
    - HP Mobile Broadband Module 58
    - Microsoft Certificate of Authenticity 58
    - regulatory 58
    - serial number 58
    - SIM 58
    - wireless certification 58
    - WLAN 58
  - lights
    - Battery 13
    - caps lock 6
    - hard drive 11
    - optical drive 12
    - power 6
    - QuickWeb 6
    - TouchPad 6
    - webcam 15
    - wireless 6
- M**
- Media Card Reader 11
  - media controls, keys 26
  - memory module
    - inserting 43
    - removing 42
    - replacing 41
  - memory module compartment, identifying 16
  - Microsoft Certificate of Authenticity label 58
  - mouse, external
    - setting preferences 29
  - mute key, identifying 26
- N**
- network jack, identifying 13
  - num lk key, identifying 9, 10, 27, 28
- O**
- operating environment 61
- operating system
    - Microsoft Certificate of Authenticity label 58
    - Product Key 58
  - optical drive 12
  - optical drive eject button 12
  - optical drive light 12
- P**
- pinching TouchPad gesture 32
  - pointing devices, setting preferences 29
  - ports
    - external monitor 13
    - HDMI 13
    - USB 12, 14
  - power button, identifying 7
  - power connector, identifying 13
  - power light 6
  - Product Key 58
  - product name and number, computer 58
- Q**
- QuickWeb button, identifying 8
  - QuickWeb light 6
- R**
- recovery partition 51, 55
  - regulatory information
    - regulatory label 58
    - wireless certification labels 58
  - release latches
    - access cover 16
    - battery 16
  - restoring the hard drive 51, 55
  - RJ-11 (modem) jack, identifying 12
  - RJ-45 (network) jack, identifying 13
  - rotating TouchPad gesture 32
- S**
- screen brightness keys 25
  - screen image, switching 25
  - scrolling TouchPad gesture 32
  - security cable slot, identifying 13
  - security screw 37
  - serial number 58
  - serial number, computer 58
  - setup of WLAN 20
- SIM slot, identifying 16
  - slots
    - ExpressCard 13
    - security cable 13
    - SIM 16
  - SoftPaqs, downloading 46
  - speakers, identifying 15
  - system repair disc 49
  - system restore points 49
- T**
- TouchPad
    - buttons 5
    - identifying 5
    - using 29
  - TouchPad gestures
    - flicking 33
    - pinching 32
    - rotating 32
    - scrolling 32
    - zooming 32
  - TouchPad light, identifying 6
  - TouchPad on/off button 5
  - traveling with the computer 58
- U**
- USB ports, identifying 12, 14
- V**
- vents, identifying 13, 16
  - volume keys, identifying 26
- W**
- webcam 15
  - webcam light, identifying 15
  - webcam, identifying 15
  - Windows 7 operating system
    - DVD 52
  - Windows Applications key, identifying 9, 10
  - Windows Backup and Restore 49
  - Windows logo key, identifying 9, 10
  - Windows Vista operating system
    - DVD 55
  - wireless antennas, identifying 15
  - wireless button, identifying 8
  - wireless certification label 58
  - wireless compartment, identifying 16
  - wireless light 6

- wireless network (WLAN),
  - equipment needed 20
- wireless network, connecting 18
- wireless router, configuring 21
- wireless set up 20
- WLAN
  - connecting 19
  - protecting 21
- WLAN antennas, identifying 15
- WLAN device 58
- WLAN label 58
- WWAN antennas, identifying 15

## Z

- zooming TouchPad gesture 32