



HP Pavilion dv6 Notebook PC

Maintenance and Service Guide

© Copyright 2011 Hewlett-Packard
Development Company, L.P.

AMD, the AMD Arrow logo, and combinations thereof, are trademarks of Advanced Micro Devices, Inc. Bluetooth is a trademark owned by its proprietor and used by Hewlett-Packard Company under license. Intel and Core are trademarks of Intel Corporation in the U.S. and other countries. Microsoft and Windows are U.S. registered trademarks of Microsoft Corporation. SD Logo is a trademark of its proprietor.

The information contained herein is subject to change without notice. The only warranties for HP products and services are set forth in the express warranty statements accompanying such products and services. Nothing herein should be construed as constituting an additional warranty. HP shall not be liable for technical or editorial errors or omissions contained herein.

First Edition: September 2011

Document Part Number: 657631-001

Safety warning notice

⚠ WARNING! To reduce the possibility of heat-related injuries or of overheating the device, do not place the device directly on your lap or obstruct the device air vents. Use the device only on a hard, flat surface. Do not allow another hard surface, such as an adjoining optional printer, or a soft surface, such as pillows or rugs or clothing, to block airflow. Also, do not allow the AC adapter to contact the skin or a soft surface, such as pillows or rugs or clothing, during operation. The device and the AC adapter comply with the user-accessible surface temperature limits defined by the International Standard for Safety of Information Technology Equipment (IEC 60950).

Table of contents

1 Product description	1
2 External component identification	10
Display	10
Buttons, speakers, and fingerprint reader (select models only)	11
Keys	12
Lights	13
TouchPad	14
Front	15
Rear	15
Left side	16
Right side	17
Bottom	18
3 Illustrated parts catalog	19
Service tag	19
Computer major components	21
Cable Kit	29
Display assembly subcomponents	30
Mass storage devices	32
Miscellaneous parts	33
Sequential part number listing	34
4 Removal and replacement procedures	44
Preliminary replacement requirements	44
Tools required	44
Service considerations	44
Plastic parts	44
Cables and connectors	44
Drive handling	45
Grounding guidelines	45

Electrostatic discharge damage	45
Packaging and transporting guidelines	47
Component replacement procedures	49
Service tag	49
Computer feet	50
Battery	51
Optical drive	52
Hard drive	54
RTC battery	57
Memory module	58
WLAN module	59
Keyboard	62
Top cover	66
Power button board	69
Fingerprint reader board	70
Bluetooth module	72
USB board	74
Power connector cable	75
System board	77
Fan/heat sink assembly	81
Processor	85
Speakers	89
Optical drive connector cable	92
Display assembly	93
5 Setup Utility (BIOS) and System Diagnostics	102
Using Setup Utility	102
Starting Setup Utility	102
Changing the language of Setup Utility	102
Navigating and selecting in Setup Utility	103
Displaying system information	103
Restoring factory settings in Setup Utility	104
Exiting Setup Utility	104
Updating the BIOS	104
Determining the BIOS version	105
Downloading a BIOS update	105
Using System Diagnostics	106
6 Specifications	107
Computer specifications	107
15.6-inch display specifications	108

Hard drive specifications	109
Hard drive specifications (continued)	110
7 Backup and recovery	111
Restore	111
Creating restore media	112
Performing a system restore	113
Restoring using the dedicated recovery partition (select models only)	113
Restoring using the restore media	114
Changing the computer boot order	114
Backing up and recovering your information	115
Using Windows Backup and Restore	116
Using Windows system restore points	116
When to create restore points	116
Create a system restore point	117
Restore to a previous date and time	117
8 Power cord set requirements	118
Requirements for all countries	118
Requirements for specific countries and regions	119
9 Recycling	121
Index	122

1 Product description

Category	Description	Computer models equipped with an AMD processor	Computer models equipped with an Intel processor
Product Name	HP Pavilion dv6 Notebook PC	√	√
Processors	AMD® A8-3530MX 2.60-GHz processor, (1.90-GHz FSB, 4.0-MB L2 cache, quad core, 45 W)	√	
	AMD A8-3510MX 2.50-GHz processor (1.50-GHz FSB, 4.0-MB L2 cache, quad core, 45 W)	√	
	AMD A8-3500M 2.40-GHz processor (1.5-GHz FSB, 4.0-MB L2 cache, quad core, 35 W)	√	
	AMD A6-3410MX 2.30-GHz processor (1.60-GHz FSB, 2.0-MB L2 cache, quad core, 45 W)	√	
	AMD A6-3400M 2.30-GHz processor (1.4-GHz FSB, 4.0-MB L2 cache, quad core, 35 W)	√	
	AMD A4-3310MX 2.50-GHz processor (2.10-GHz FSB, 2.0-MB L2 cache, dual core, 45 W)	√	
	AMD A4-3300M 2.50-GHz processor (1.9-GHz FSB, 4.0-MB L2 cache, dual core, 35 W)	√	
	Intel® Core® i7-2860QM 2.50-GHz (SC turbo up to 3.60-GHz) processor (1600-MHz FSB, 8.0-MB L3 cache, dual core, 45 W)		√
	Intel Core i7-2820QM 2.30-GHz (SC turbo up to 3.20-GHz) processor (1600-MHz FSB, 8.0-MB L3 cache, quad core, 45 W)		√
	Intel Core i7-2760QM 2.40-GHz (SC turbo up to 3.50-GHz) processor (1600-MHz FSB, 6.0-MB L3 cache, dual core, 45 W)		√
	Intel Core i7-2720QM 2.20-GHz (SC turbo up to 3.00-GHz) processor (6.0-MB L3 cache, quad core, 45 W)		√
	Intel Core i7-2670QM 2.20-GHz (SC turbo up to 3.10-GHz) processor (1600-MHz FSB, 6.0-MB L3 cache, dual core, 45 W)		√

Category	Description	Computer models equipped with an AMD processor	Computer models equipped with an Intel processor
	Intel Core i7-2640M 2.80-GHz (SC turbo up to 3.50-GHz) processor (1333-MHz FSB, 4.0-MB L3 cache, dual core, 35 W)		√
	Intel Core i7-2630QM 2.00-GHz (SC turbo up to 2.90-GHz) processor (1333-MHz FSB, 6.0-MB L3 cache, quad core, 45 W)		√
	Intel Core i7-2620M 2.70-GHz (SC turbo up to 3.40-GHz) processor (4.0-MB L3 cache, dual core, 35 W)		√
	Intel Core i5-2540M 2.60-GHz (SC turbo up to 3.30-GHz) processor (3.0-MB L3 cache, dual core, 35 W)		√
	Intel Core i5-2520M 2.50-GHz (SC turbo up to 3.20-GHz) processor (3.0-MB L3 cache, dual core, 35 W)		√
	Intel Core i5-2430M 2.40-GHz (SC turbo up to 3.00-GHz) processor (3.0-MB L3 cache, dual core, 35 W)		√
	Intel Core i3-2350M 2.30-GHz processor (3.0-MB L3 cache, dual core, 35 W)		√
	Intel Core i3-2330M 2.20-GHz processor (3.0-MB L3 cache, dual core, 35 W)		√
	Intel Pentium® B960 TJ85 2.20-GHz processor (2.0-MB L3 cache, dual core, 35 W)		√
	Intel Pentium B950 TJ85 2.10-GHz processor (2.0-MB L3 cache, dual core, 35 W)		√
Chipset	Northbridge: AMD A70M Fusion controller hub (FCH)	√	
	Northbridge: AMD A60M FCH		
	Southbridge: AMD SB820M		
	Intel HM65 Express chipset with NEC USB 3.0 (select models only)		√
	Intel HM65 Express chipset		√

Category	Description	Computer models equipped with an AMD processor	Computer models equipped with an Intel processor
Graphics	<p data-bbox="496 285 691 308">Internal graphics:</p> <ul data-bbox="496 338 1002 590" style="list-style-type: none"> <li data-bbox="496 338 1002 422">• AMD Radeon™ HD 6620G graphics on computer models equipped with an AMD A8 processor <li data-bbox="496 451 1002 501">• AMD Radeon HD 6520G graphics on computer models equipped with an AMD A6 processor <li data-bbox="496 531 1002 581">• AMD Radeon HD 6480G graphics on computer models equipped with an AMD A4 processor <p data-bbox="496 611 820 634">Switchable discrete graphics:</p> <ul data-bbox="496 663 1002 1633" style="list-style-type: none"> <li data-bbox="496 663 1002 842">• AMD Radeon HD 6755G2 graphics subsystem on computer models equipped with an AMD A8 or A6 processor, with 1024-MB of dedicated video memory (64-MB × 16 GDDR5 × 8 PCs, 3.2 GBPS), utilize VRAM component GDDR5 32-MB × 32 with 5GBPS capability <li data-bbox="496 871 1002 1041">• AMD Radeon HD 6750M graphics subsystem on computer models equipped with an AMD A4 processor, with 1024-MB of dedicated video memory (64-MB × 16 GDDR5 × 8 PCs, 3.2 GBPS), utilize VRAM component GDDR5 32-MB × 32 with 5GBPS capability <li data-bbox="496 1071 1002 1241">• AMD Radeon HD 6645G2 graphics subsystem on computer models equipped with an AMD A8 processor, with 512-MB of dedicated video memory (64-MB × 16 GDDR5 × 4 PCs, 3.2 GBPS), utilize VRAM component GDDR5 32-MB × 32 with 5GBPS capability <li data-bbox="496 1270 1002 1440">• AMD Radeon HD 6545G2 graphics subsystem on computer models equipped with an AMD A6 processor, with 512-MB of dedicated video memory (64-MB × 16 GDDR5 × 4 PCs, 3.2 GBPS), utilize VRAM component GDDR5 32-MB × 32 with 5GBPS capability <li data-bbox="496 1470 1002 1633">• AMD Radeon HD 6515G2 graphics subsystem on computer models equipped with an AMD A4 processor, with 512-MB of dedicated video memory (64-MB × 16 GDDR5 × 4 PCs, 3.2 GBPS), utilize VRAM component GDDR5 32-MB × 32 with 5GBPS capability 	√	

Category	Description	Computer models equipped with an AMD processor	Computer models equipped with an Intel processor
	<p>Internal graphics:</p> <ul style="list-style-type: none"> Intel HD Graphics 3000 on computer models equipped with an Intel Core i7, i5, or i3 processor Intel HD Graphics 3000 on computer models equipped with an Intel Pentium processor <p>Switchable discrete graphics:</p> <ul style="list-style-type: none"> ATI XT Radeon HD 6770M M2 package with 2048-MB (64-MB × 32 GDDR5 × 8 PCs, 5GBPS) or 1024-MB (32-MB × 32 GDDR5 × 8 PCs, 5GBPS) of graphics subsystem discrete memory, muxless ATi XT Radeon HD 6490M M2 package with 1024-MB of graphics subsystem discrete memory (64-MB × 32 GDDR5 × 4 PCs, 5GBPS), muxless 		√
	Support for DX11, HD decode, HDMI, BACO	√	√
Panel	<p>15.6-in, full high-definition (FHD), light-emitting diode (LED), low-voltage differential signalling (LVDS), WVA AntiGlare (1080p, 1900×1080) display; typical brightness: 220 nits</p> <p>15.6-in, HD, LED, LVDS, SVA BrightView (1366×768) display; typical brightness: 200 nits</p> <p>All display assemblies include 2 wireless local area network (WLAN) antenna cables</p> <p>Supports 16:9 ultra wide aspect ratio</p> <p>Lighted logo on top bezel</p>	√	√
Memory	2 customer-accessible/upgradable memory module slots	√	√
	Supports dual-channel memory	√	√
	Supports up to 8192 GB of system RAM	√	
	Supports up to 16384 GB of system RAM		√
	DDR3/1333-MHz	√	√

Category	Description	Computer models equipped with an AMD processor	Computer models equipped with an Intel processor
	Supports the following configurations: <ul style="list-style-type: none"> 16384-MB total system memory (8192×2) 12288-MB total system memory (8192×1 + 4096×1) 8192-MB total system memory (8192×1 or 4096×2) 6144-MB total system memory (4096×1 + 2048×1) 4096-MB total system memory (4096×1 or 2048×2) 2048-MB total system memory (2048×1) 	√	√
Hard drives	Supports 6.35-cm (2.5-in) hard drives in 12.7-mm (.50-in), 9.5-mm (.37-in), and 7.0-mm (.28-in) thicknesses	√	√
	Customer-accessible	√	√
	Accelerometer / HDD protection support	√	√
	Serial ATA	√	√
	Supports the following configurations: <ul style="list-style-type: none"> 1 TB, 5400 rpm (12.7 mm) 750 GB, 7200 and 5400 rpm (9.5 mm) 640 GB, 5400 rpm (9.5 mm) 500 GB, 7200 rpm (9.5 mm) 320 GB, 7200 and 5400 rpm (7.0 mm) 	√	√
	Supports 160-GB solid-state drive		√
Optical drive	Fixed	√	√
	Serial ATA	√	√
	12.7-mm tray load	√	√
	Blu-ray Disc ROM FX SuperMulti DVD±R/RW Double-Layer Drive	√	√
	Blu-ray Disc R/RW FX SuperMulti Drive		√
	DVD±RW Double-Layer FX SuperMulti Drive	√	√
Audio and video	Dual array digital microphones with appropriate beam-forming, echo-cancellation, noise-suppression software	√	√
	HD audio	√	√

Category	Description	Computer models equipped with an AMD processor	Computer models equipped with an Intel processor
	HP-branded Altec/Lansing quad Beats Audio speakers (select models only)	√	√
	HP TrueVision HD webcam (fixed, integrated, low-light)	√	√
Ethernet	Integrated 10/100/1000 network interface card (NIC)	√	√
Wireless	Integrated wireless local area network (WLAN) options by way of wireless module	√	√
	Two WLAN antennas built into display assembly	√	√
	Support for the following WLAN formats:	√	√
	<ul style="list-style-type: none"> Atheros 9485GN 802.11b/g/n 1×1 WiFi and 3012 Bluetooth 4.0 Combo Adapter Broadcom 4313 802.11b/g/n 1×1 WiFi and 2070 Bluetooth 2.1+EDR Combo Adapter (Bluetooth 3.0+HS ready) Broadcom 4313GN 802.11b/g/n 1×1 WiFi and 20702 Bluetooth 4.0 Combo Adapter Ralink 5390GN 802.11b/g/n 1×1 WiFi Adapter Realtek RTL8191SE 802.11b/g/n 1×1 WiFi Adapter 		
	Support for the following WLAN formats:	√	
	<ul style="list-style-type: none"> Atheros AR8002WB-1NGB 802.11b/g/n 1×1 WiFi and Bluetooth 2.1+EDR Combo Adapter (BT3.0+HS ready) 		
	Support for the following WLAN formats:		√
	<ul style="list-style-type: none"> Broadcom 4313 802.11b/g/n 1×1 WiFi Adapter Intel Centrino Advanced-N 6230 WLAN module Intel Centrino Wireless-N 1000 WLAN module Intel Centrino Wireless-N + WiMAX 6150 WLAN module Ralink RT3090BC4 802.11b/g/n 1×1 WiFi and Bluetooth 2.1+EDR Combo Adapter (Bluetooth 3.0+HS ready) 		

Category	Description	Computer models equipped with an AMD processor	Computer models equipped with an Intel processor
External media card	<p>HP Multi-Format Digital Media Reader supports the following digital card formats:</p> <ul style="list-style-type: none"> Secure Digital (SD) Memory Card Secure Digital Extended Capacity (SDxC) Memory Card Secure Digital High Capacity (SDHC) Memory Card Ultra High Speed MultiMediaCard (UHS/MMC) 	√	√
Ports	<ul style="list-style-type: none"> 3-pin AC power Audio-in (mono microphone) Audio-out (stereo headphone; 2) HDMI version 1.4 supporting up to 1920 × 1200 @ 60Hz RJ-45 (Ethernet, includes link and activity lights) USB 2.0 (3 ports) VGA (Dsub 15 pin) supporting 2048×1536 external resolution @ 75 Hz hot plug and unplug and auto-detection for correct output to wide-aspect vs. standard aspect video 	√	√
Keyboard/ pointing devices	Full-size (15.6-in), textured, keyboard with numeric keypad	√	√
	TouchPad with multi-touch gestures, 2-finger scrolling, and pinch-zoom enabled	√	√
	Dura-coat, island-style keyboard	√	√
	Multitouch gestures (2-finger scrolling and pinch-zoom) enabled by default	√	√
	Taps enabled by default	√	√

Category	Description	Computer models equipped with an AMD processor	Computer models equipped with an Intel processor
Power requirements	Support for the following 3-wire plug with ground pin AC adapters (supports 3-pin DC connector): <ul style="list-style-type: none"> 120W AC adapter with localized cable plug support 90W EM AC adapter with localized cable plug support 90W AC adapter with localized cable plug support 65W EM AC adapter with localized cable plug support 65W AC adapter with localized cable plug support 	√	√
	Support for the following batteries: <ul style="list-style-type: none"> 9-cell, 100-Whr, 3.00-Ah Li-ion battery 6-cell, 62-Whr, 2.80-Ah Li-ion battery 6-cell, 55-Whr, 2.55-Ah Li-ion battery 	√	√
Security	Security cable slot	√	√
	Fingerprint reader with Digital Persona software support (select models only)		√
	Support for Intel AT-p Ready		√
Operating system	Preinstalled: <ul style="list-style-type: none"> Windows 7 Home Basic (select models only) Windows 7 Home Premium 64-bit (select models only) Windows 7 Professional 64-bit (select models only) 	√	

Category	Description	Computer models equipped with an AMD processor	Computer models equipped with an Intel processor
	<p>Preinstalled:</p> <ul style="list-style-type: none"> • Windows 7 Home Basic (64- and 32-bit; select models only) • Windows 7 Home Premium (64- and 32-bit; select models only) • Windows 7 Professional (64- and 32-bit; select models only) • Windows 7 Starter (32-bit; select models only) • Windows 7 Ultimate (64-bit; select models only) • FreeDOS • RedFlag 		√
Serviceability	<p>End-user replaceable parts:</p> <ul style="list-style-type: none"> • AC adapter • Battery • Hard drive • Memory modules (2) • Optical drive • WLAN module 	√	√

2 External component identification

Display



Item	Component	Description
(1)	WLAN antennas (2)*	Send and receive wireless signals to communicate with WLANs.
(2)	Internal microphones (2)	Record sound.
(3)	Webcam light	On: The webcam is in use.
(4)	Webcam	Records video and captures still photographs. To use the webcam, select Start > All Programs > CyberLink YouCam > CyberLink YouCam .

*The antennas are not visible from the outside of the computer. For optimal transmission, keep the areas immediately around the antennas free from obstructions. To see wireless regulatory notices, refer to the section of the *Regulatory, Safety, and Environmental Notices* that applies to your country or region. These notices are located in Help and Support.

Buttons, speakers, and fingerprint reader (select models only)

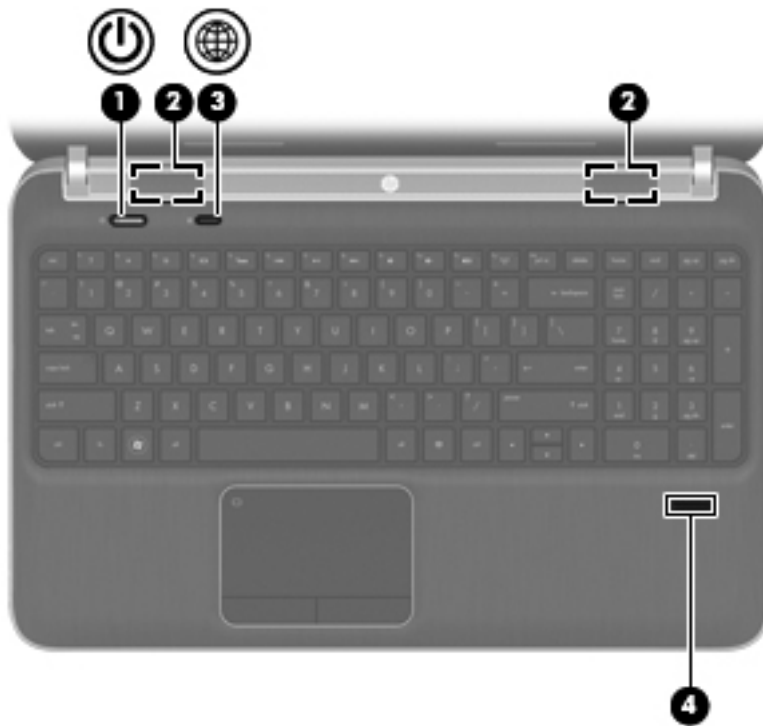

Item	Component	Description
(1)	Power button	<ul style="list-style-type: none"> When the computer is off, press the button to turn on the computer. When the computer is on, press the button briefly to initiate Sleep. When the computer is in the Sleep state, press the button briefly to exit Sleep. When the computer is in Hibernation, press the button briefly to exit Hibernation. <p>If the computer has stopped responding and Windows shutdown procedures are ineffective, press and hold the power button for at least 5 seconds to turn off the computer.</p> <p>To learn more about your power settings, select Start > Control Panel > System and Security > Power Options, or refer to the <i>HP Notebook Reference Guide</i>.</p>
(2)	Speakers (2)	Produce sound.
(3)	Web browser button	Opens the default Web browser.
(4)	Fingerprint reader (select models only)	Allows a fingerprint logon to Windows, instead of a password logon.

Keys

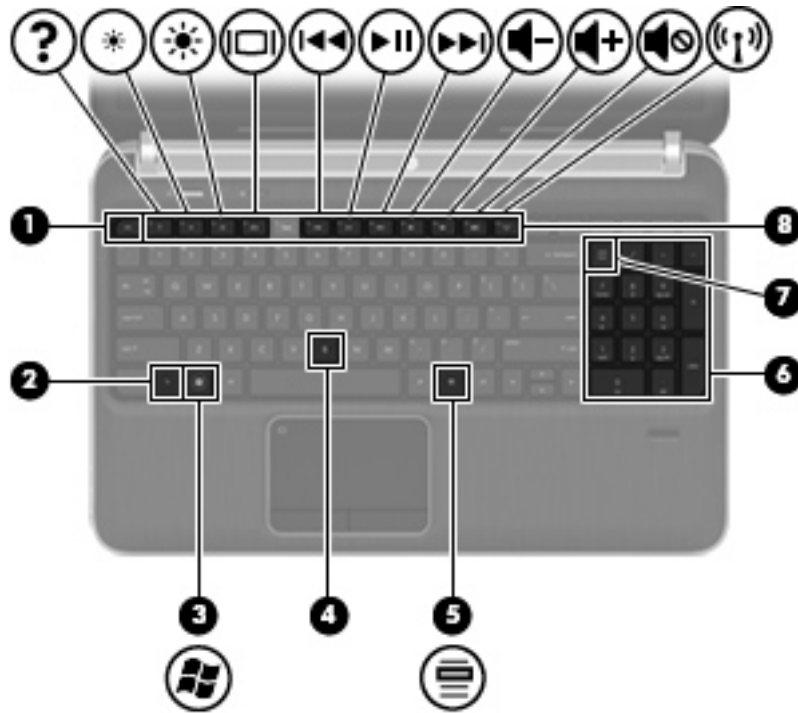

Item	Component	Description
(1)	esc key	Displays system information when pressed in combination with the fn key.
(2)	fn key	Executes frequently used system functions when pressed in combination with the num lk key, the b key, or the esc key.
(3)	Windows logo key	Displays the Windows Start menu.
(4)	b key	Increases or decreases the Beats Audio bass settings (select models only). Beats Audio is an enhanced audio profile that provides a deep, controlled bass while maintaining a clear sound. Beats Audio is enabled by default. You can also view and control the bass settings through the Windows operating system. To view and control the bass properties: <ul style="list-style-type: none"> • Select Start > All Programs > Beats Audio Control Panel > Listening Experience. – or – • Select Start > Control Panel > Hardware and Sound > Beats Audio Control Panel > Listening Experience.
(5)	Windows applications key	Displays a shortcut menu for items beneath the pointer.

Item	Component	Description
(6)	Integrated numeric keypad	When the keypad has been enabled, the keys can be used like an external numeric keypad.
(7)	num lk key	Enables/disables the integrated numeric keypad when pressed in combination with the fn key.
(8)	Action keys	Execute frequently used system functions.

Lights

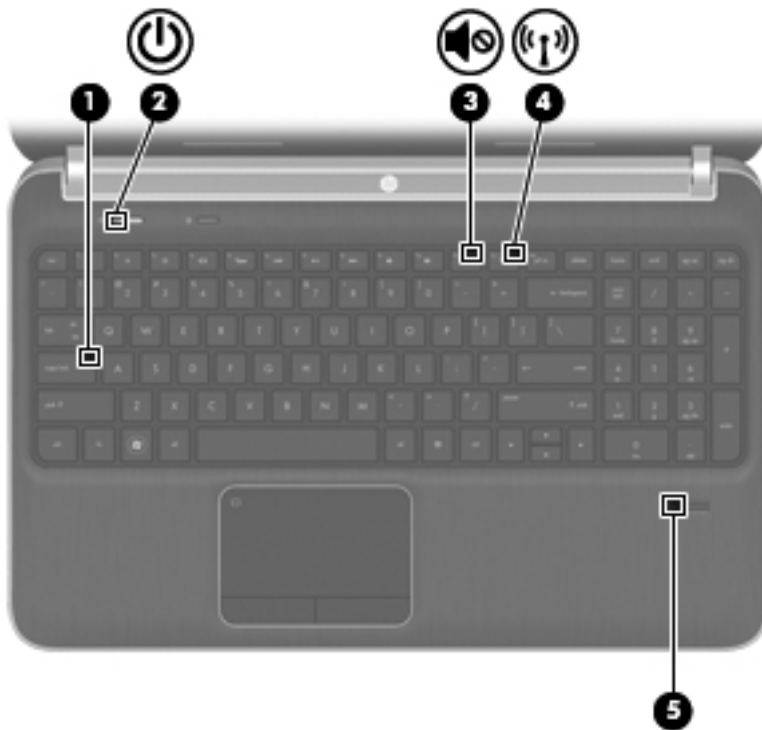

Item	Component	Description
(1)	Caps lock light	On: Caps lock is on.
(2)	Power light	<ul style="list-style-type: none"> White: the computer is on. Blinking white: the computer is in the Sleep state. Off: the computer is off or in Hibernation.
(3)	Mute light	<ul style="list-style-type: none"> Amber: Computer sound is off. Off: Computer sound is on.

Item	Component	Description
(4)	Wireless light	<ul style="list-style-type: none"> White: An integrated wireless device, such as a WLAN device and/or a Bluetooth device, is on. Amber: All wireless devices are off.
(5)	Fingerprint reader light (select models only)	<ul style="list-style-type: none"> White: The fingerprint was read. Amber: The fingerprint was not read.

TouchPad

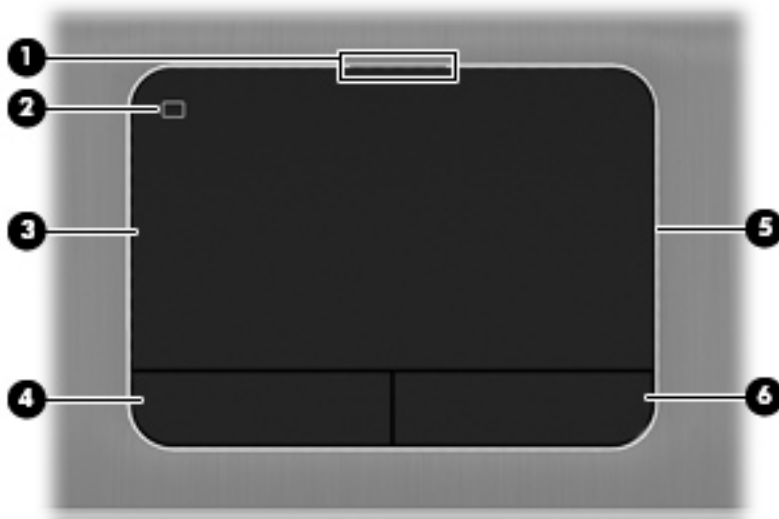

Item	Component	Description
(1)	TouchPad off light	<ul style="list-style-type: none"> On: The TouchPad is off. Off: The TouchPad is on.
(2)	TouchPad on/off button	Turns the TouchPad on and off.
(3)	TouchPad zone	Moves the pointer and selects or activates items on the screen.
(4)	Left TouchPad button	Functions like the left button on an external mouse.
(5)	TouchPad on light	<ul style="list-style-type: none"> On: The TouchPad is on. Off: The TouchPad is off.
(6)	Right TouchPad button	Functions like the right button on an external mouse.

Front



Item	Component	Description
(1)	Digital Media Slot	Supports the following digital card formats: <ul style="list-style-type: none">• Secure Digital (SD) Memory Card• Secure Digital Extended Capacity (SDxC) Memory Card• Secure Digital High Capacity (SDHC) Memory Card• Ultra High Speed MultiMediaCard (UHS/MMC)
(2)	Speakers (2) (select models only)	Produce sound.

Rear



Component	Description
Vent	Enables airflow to cool internal components. NOTE: the computer fan starts up automatically to cool internal components and prevent overheating. It is normal for the internal fan to cycle on and off during routine operation.

Left side

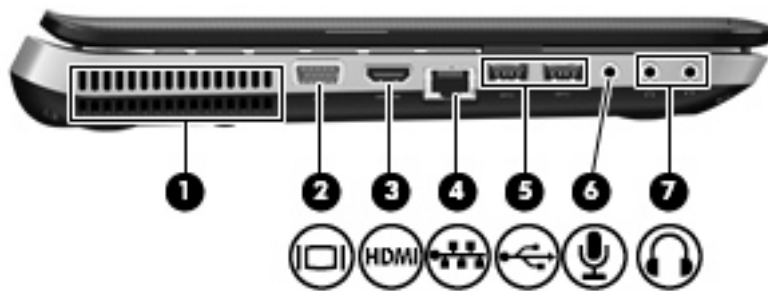

Item	Component	Description
(1)	Vent	Enables airflow to cool internal components. NOTE: the computer fan starts up automatically to cool internal components and prevent overheating. It is normal for the internal fan to cycle on and off during routine operation.
(2)	External monitor port	Connects an external VGA monitor or projector.
(3)	HDMI port	Connects an optional video or audio device, such as a high-definition television, or any compatible digital or audio component.
(4)	RJ-45 (network) jack	Connects a network cable.
(5)	USB ports (2)	Connect optional USB devices. NOTE: Depending on your computer model, your computer may be equipped with 2 USB 3.0 ports, which connect optional 3.0 devices and provide enhanced USB power performance. USB 3.0 ports are also compatible with USB 1.0 and USB 2.0 devices.
(6)	Audio-in (microphone) jack	Connects an optional computer headset microphone, stereo array microphone, or monaural microphone.
(7)	Audio-out (headphone) jacks (2)	Produce sound when connected to optional powered stereo speakers, headphones, ear buds, a headset, or television audio. WARNING! To reduce the risk of personal injury, adjust the volume before putting on headphones, earbuds, or a headset. For additional safety information, refer to the <i>Regulatory, Safety, and Environmental Notices</i> . NOTE: When a device is connected to a headphone jack, the computer speakers are disabled.

Right side

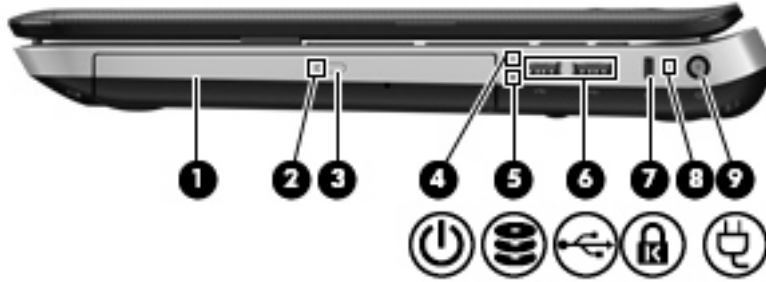

Item	Component	Description
(1)	Optical drive	Reads and writes (select models only) to an optical disc.
(2)	Optical drive light	<ul style="list-style-type: none"> Green: The optical drive is being accessed. Off: The optical drive is off.
(3)	Optical drive eject button	Ejects the optical drive.
(4)	Power light	<ul style="list-style-type: none"> White: the computer is on. Blinking white: the computer is in the Sleep state. Off: the computer is off or in Hibernation.
(5)	Drive light	<ul style="list-style-type: none"> Blinking white: The hard drive is being accessed. Amber: HP ProtectSmart Hard Drive Protection has temporarily parked the hard drive. <p>NOTE: For information on HP ProtectSmart Hard Drive Protection, refer to the <i>HP Notebook Reference Guide</i>.</p>
(6)	USB ports (2)	Connect optional USB devices.
(7)	Security cable slot	Attaches an optional security cable to the computer.
(8)	Battery light	<ul style="list-style-type: none"> White: the computer is connected to external power and the battery is fully charged. Amber: A battery is charging. Blinking amber: The battery has reached a low battery level, or there is a battery error. When a battery reaches a critical battery level, the battery light begins blinking rapidly.
(9)	Power connector	Connects an AC adapter.

Bottom

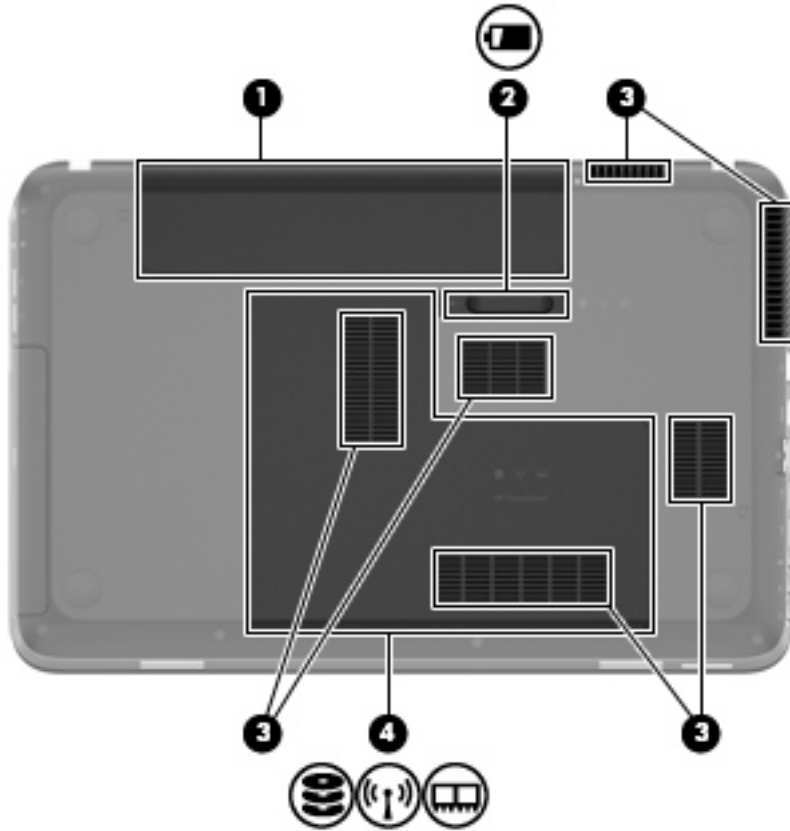

Item	Component	Description
(1)	Battery bay	Holds the battery.
(2)	Battery release latch	Releases the battery from the battery bay.
(3)	Vents (6)	Enable airflow to cool internal components. NOTE: the computer fan starts up automatically to cool internal components and prevent overheating. It is normal for the internal fan to cycle on and off during routine operation.
(4)	Hard drive bay	Contains the hard drive, the WLAN device, and the memory module slots. CAUTION: To prevent an unresponsive system, replace the wireless module only with a wireless module authorized for use in the computer by the governmental agency that regulates wireless devices in your country or region. If you replace the module and then receive a warning message, remove the module to restore computer functionality, and then contact technical support through Help and Support.

3 Illustrated parts catalog

Service tag

When ordering parts or requesting information, provide the computer serial number and model number provided on the service tag.

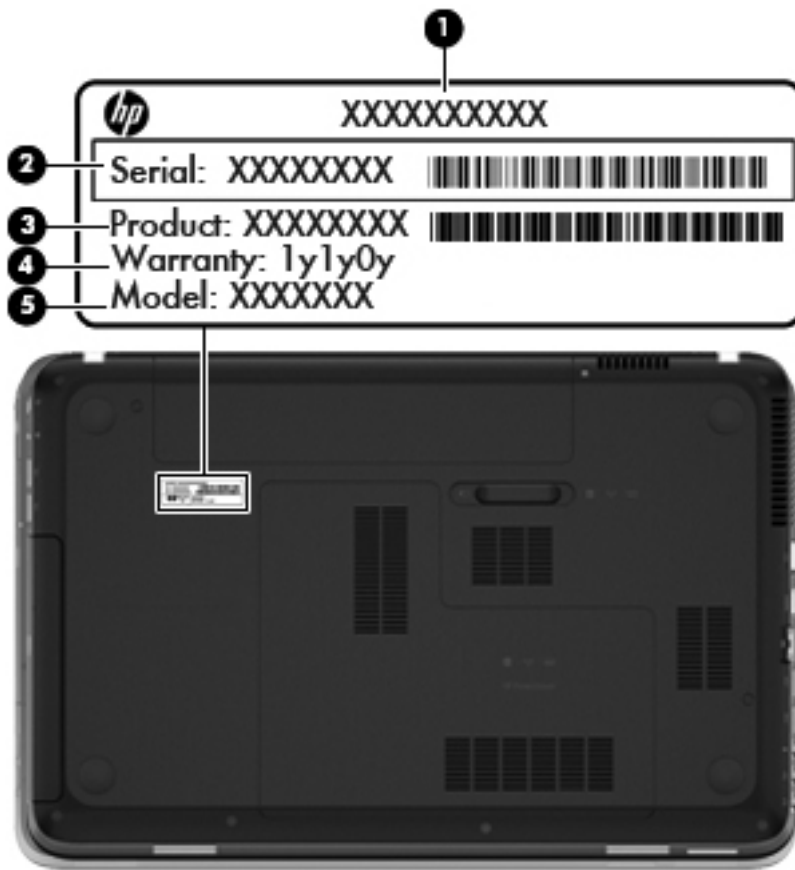

Item	Component	Description
(1)	Product name	This is the product name affixed to the front of the computer.
(2)	Serial number (s/n)	This is an alphanumeric identifier that is unique to each product.

Item	Component	Description
(3)	Part number/Product number (p/n)	This number provides specific information about the product's hardware components. The part number helps a service technician determine what components and parts are needed.
(4)	Warranty period	This number describes the duration of the warranty period for the computer.
(5)	Model description	This is the alphanumeric identifier used to locate documents, drivers, and support for the computer.

Computer major components

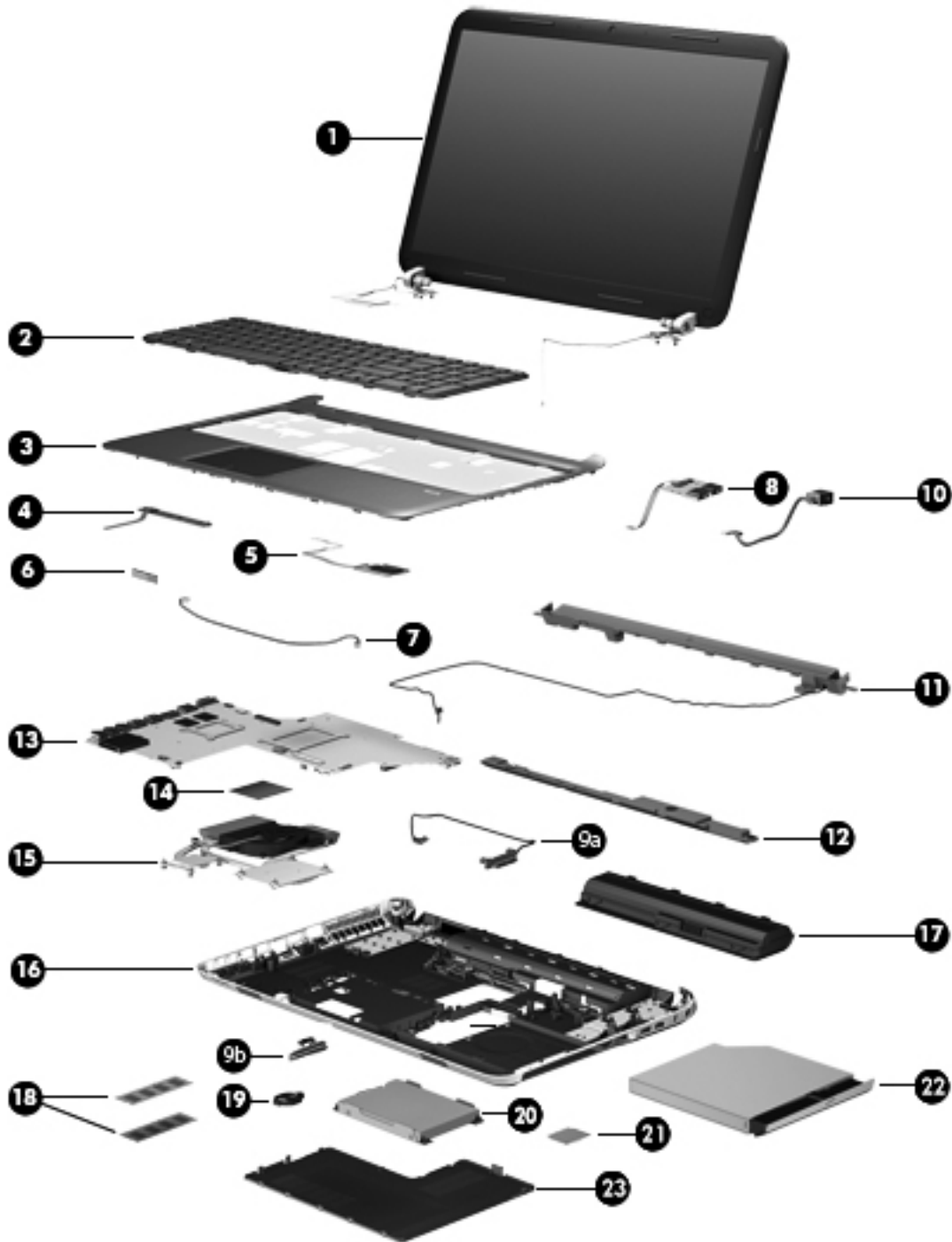

Item	Component	Spare part number
(1)	Display assembly: The display assembly is spared at the subcomponent level only. For more display assembly spare part information, see Display assembly subcomponents on page 30 .	
(2)	Keyboard (includes keyboard cable):	

Item	Component	Spare part number
	Keyboard in black finish:	
	For use with all computer models in Belgium	665326-A41
	For use with all computer models in Brazil	665326-201
	For use only with computer models equipped with an AMD processor in Bulgaria	665326-261
	For use with all computer models in Canada	665326-121
	For use with all computer models in the Czech Republic and Slovakia	665326-FL1
	For use with all computer models in Denmark, Finland, and Norway	665326-DH1
	For use with all computer models in France	665326-051
	For use with all computer models in Germany	665326-041
	For use with all computer models in Greece	665326-DJ1
	For use with all computer models in Hungary	665326-211
	For use only with computer models equipped with an Intel processor in India	665326-D61
	For use only with computer models equipped with an Intel processor in Israel	665326-BB1
	For use with all computer models Italy	665326-061
	For use with all computer models in Japan	665326-291
	For use with all computer models in Latin America	665326-161
	For use with all computer models in the Netherlands	665326-B31
	For use with all computer models in Portugal	665326-131
	For use with all computer models in Russia	665326-251
	For use with all computer models in Saudi Arabia	665326-171
	For use with all computer models in Slovenia	665326-BA1
	For use only with computer models equipped with an Intel processor in South Korea	665326-AD1
	For use with all computer models in Spain	665326-071
	For use with all computer models in Switzerland	665326-BG1
	For use only with computer models equipped with an Intel processor in Taiwan	665326-AB1
	For use only with computer models equipped with an Intel processor in Thailand	665326-281
	For use with all computer models in Turkey	665326-141
	For use with all computer models in the United Kingdom and Singapore	665326-031
	For use with all computer models in the United States	665326-001
	Keyboard in silver finish:	
	For use with all computer models in Belgium	666423-A41
	For use with all computer models in Brazil	666423-201

Item	Component	Spare part number
	For use only with computer models equipped with an AMD processor in Bulgaria	666423-261
	For use with all computer models in Canada	666423-121
	For use with all computer models in the Czech Republic and Slovakia	666423-FL1
	For use with all computer models in Denmark, Finland, and Norway	666423-DH1
	For use with all computer models in France	666423-051
	For use with all computer models in Germany	666423-041
	For use with all computer models in Greece	666423-DJ1
	For use with all computer models in Hungary	666423-211
	For use only with computer models equipped with an Intel processor in India	666423-D61
	For use only with computer models equipped with an Intel processor in Israel	666423-BB1
	For use with all computer models Italy	666423-061
	For use with all computer models in Japan	666423-291
	For use with all computer models in Latin America	666423-161
	For use with all computer models in the Netherlands	666423-B31
	For use with all computer models in Portugal	666423-131
	For use with all computer models in Russia	666423-251
	For use with all computer models in Saudi Arabia	666423-171
	For use with all computer models in Slovenia	666423-BA1
	For use only with computer models equipped with an Intel processor in South Korea	666423-AD1
	For use with all computer models in Spain	666423-071
	For use with all computer models in Switzerland	666423-BG1
	For use only with computer models equipped with an Intel processor in Taiwan	666423-AB1
	For use only with computer models equipped with an Intel processor in Thailand	666423-281
	For use with all computer models in Turkey	666423-141
	For use with all computer models in the United Kingdom and Singapore	666423-031
	For use with all computer models in the United States	666423-001
(3)	Top cover (includes TouchPad and TouchPad button board, but does not include TouchPad cable or TouchPad button board cable):	
	NOTE: The TouchPad cable and TouchPad button board cable are included in the Cable Kit, spare part number 665301-001.	
	In butter gold finish	665364-001
	In dark umber finish	665356-001
	In espresso black finish	665358-001

Item	Component	Spare part number
	In linen white finish	665359-001
	In Pacific blue finish	665360-001
	In pearl pink finish	665363-001
	In ruby red finish	665362-001
	In Sonoma red finish	665361-001
	In steel gray finish	665357-001
(4)	Power button board (does not include cable) NOTE: The power button board cable is not included in the power button board spare part kit. The power button board cable is included in the Cable Kit, spare part number 665301-001.	665330-001
(5)	Fingerprint reader board (select models only, includes bracket, but does not include cable) NOTE: The fingerprint reader board cable is not included in the fingerprint reader board spare part kit. The fingerprint reader board cable is included in the Cable Kit, spare part number 665301-001.	665310-001
(6)	EDR v.4.0 Bluetooth module (for use only with computer models equipped with an Intel processor) NOTE: The Bluetooth module spare part kit does not include the Bluetooth module cable. The Bluetooth module cable is available using spare part number 665303-001.	655792-001
(7)	Bluetooth module cable (for use only with computer models equipped with an Intel processor)	665303-001
(8)	USB board (does not include cable) NOTE: The USB board cable is not included in the USB board spare part kit. The USB board cable is included in the Cable Kit, spare part number 665303-001.	665331-001
	Cable Kit , includes:	665301-001
(9a)	Optical drive connector cable	
(9b)	Hard drive connector cable	
	Not illustrated:	
	Power button board cable	
	Fingerprint reader board cable	
	TouchPad cable	
	TouchPad button board cable	
	USB board cable	
	NOTE: See Cable Kit on page 29 for more Cable Kit spare part information.	
(10)	Power connector cable	665306-001
(11)	Speaker cover	665333-001

Item	Component	Spare part number
(12)	Speaker Kit (includes left and right speakers and cable)	665340-001
(13)	System board (includes replacement thermal material):	
	For use only with computer models equipped with an AMD A70M processor, the HD6750 graphics subsystem with 1024-MB of discrete memory, and USB version 3.0	665284-001
	For use only with computer models equipped with an AMD A70M processor, a graphics subsystem with UMA memory, and USB version 3.0	665282-001
	For use only with computer models equipped with an AMD A60M processor, the HD6750 graphics subsystem with 1024-MB of discrete memory, and USB version 2.0	665281-001
	For use only with computer models equipped with an AMD A60M processor, the HD6490 graphics subsystem with 512-MB of discrete memory, and USB version 2.0	665280-001
	For use only with computer models equipped with an AMD A60M processor, a graphics subsystem with UMA memory, and USB version 2.0	665279-001
	For use only with computer models equipped with an Intel quad core processor, the HD6770 graphics subsystem with 2048-MB of discrete memory, and USB version 3.0	665342-001
	For use only with computer models equipped with an Intel dual core processor, the HD6770 graphics subsystem with 2048-MB of discrete memory, and USB version 3.0	665341-001
	For use only with computer models equipped with an Intel quad core processor, the HD6770 graphics subsystem with 1024-MB of discrete memory, and USB version 3.0	665344-001
	For use only with computer models equipped with an Intel dual core processor, the HD6770 graphics subsystem with 1024-MB of discrete memory, and USB version 3.0	665343-001
	For use only with computer models equipped with an Intel quad core processor, the HD6490 graphics subsystem with 1024-MB of discrete memory, and USB version 3.0	665348-001
	For use only with computer models equipped with an Intel quad core processor, the HD6490 graphics subsystem with 1024-MB of discrete memory, and USB version 2.0	665346-001
	For use only with computer models equipped with an Intel dual core processor, the HD6490 graphics subsystem with 1024-MB of discrete memory, and USB version 3.0	665347-001
	For use only with computer models equipped with an Intel dual core processor, the HD6490 graphics subsystem with 1024-MB of discrete memory, and USB version 2.0	665345-001
	For use only with computer models equipped with an Intel quad core processor, a graphics subsystem with UMA memory, and USB version 3.0	665352-001
	For use only with computer models equipped with an Intel quad core processor, a graphics subsystem with UMA memory, and USB version 2.0	665350-001
	For use only with computer models equipped with an Intel dual core processor, a graphics subsystem with UMA memory, and USB version 3.0	665351-001
	For use only with computer models equipped with an Intel dual core processor, a graphics subsystem with UMA memory, and USB version 2.0	665349-001
	Thermal Material Kit (not illustrated, includes replacement thermal paste and pads)	
	For use only with computer models equipped with an AMD processor and a graphics subsystem with discrete memory	665286-001
	For use only with computer models equipped with an AMD processor and a graphics subsystem with UMA memory	665285-001

Item	Component	Spare part number
	For use only with computer models equipped with an Intel processor and a graphics subsystem with 2048-MB discrete memory	665354-001
	For use only with computer models equipped with an Intel processor and a graphics subsystem with 1024-MB discrete memory	665355-001
	For use only with computer models equipped with an Intel processor and a graphics subsystem with UMA memory	665353-001
(14)	Processor (includes replacement thermal material)	
	AMD A8-3530MX 2.60-GHz processor (1.90-GHz FSB, 4.0-MB L2 cache, quad core, 45 W)	653364-001
	AMD A8-3510MX 2.50-GHz processor (1.50-GHz FSB, 4.0-MB L2 cache, quad core, 45 W)	653358-001
	AMD A8-3500M 2.40-GHz processor (1.5-GHz FSB, 4.0-MB L2 cache, quad core, 35 W)	653350-001
	AMD A6-3410MX 2.30-GHz processor (1.60-GHz FSB, 2.0-MB L2 cache, quad core, 45 W)	653357-001
	AMD A6-3400M 2.30-GHz processor (1.4-GHz FSB, 4.0-MB L2 cache, quad core, 35 W)	653349-001
	AMD A4-3310MX 2.50-GHz processor (2.10-GHz FSB, 2.0-MB L2 cache, dual core, 45 W)	653356-001
	AMD A4-3300M 2.50-GHz processor (1.9-GHz FSB, 4.0-MB L2 cache, dual core, 35 W)	653348-001
	Intel Core i7-2860QM 2.50-GHz (SC turbo up to 3.60-GHz) processor (1600-MHz FSB, 8.0-MB L3 cache, dual core, 45 W)	666175-001
	Intel Core i7-2820QM 2.30-GHz (SC turbo up to 3.20-GHz) processor (1600-MHz FSB, 8.0-MB L3 cache, quad core, 45 W)	634694-001
	Intel Core i7-2760QM 2.40-GHz (SC turbo up to 3.50-GHz) processor (1600-MHz FSB, 6.0-MB L3 cache, dual core, 45 W)	666174-001
	Intel Core i7-2720QM 2.20-GHz (SC turbo up to 3.00-GHz) processor (6.0-MB L3 cache, quad core, 45 W)	631254-001
	Intel Core i7-2670QM 2.20-GHz (SC turbo up to 3.10-GHz) processor (1600-MHz FSB, 6.0-MB L3 cache, dual core, 45 W)	665116-001
	Intel Core i7-2640M 2.80-GHz (SC turbo up to 3.50-GHz) processor (1333-MHz FSB, 4.0-MB L3 cache, dual core, 35 W)	666173-001
	Intel Core i7-2630QM 2.00-GHz (SC turbo up to 2.90-GHz) processor (1333-MHz FSB, 6.0-MB L3 cache, quad core, 45 W)	635501-001
	Intel Core i7-2620M 2.70-GHz (SC turbo up to 3.40-GHz) processor (4.0-MB L3 cache, dual core, 35 W)	631252-001
	Intel Core i5-2540M 2.60-GHz (SC turbo up to 3.30-GHz) processor (3.0-MB L3 cache, dual core, 35 W)	631255-001
	Intel Core i5-2520M 2.50-GHz (SC turbo up to 3.20-GHz) processor (3.0-MB L3 cache, dual core, 35 W)	631253-001

Item	Component	Spare part number
	Intel Core i5-2430M 2.40-GHz (SC turbo up to 3.00-GHz) processor (3.0-MB L3 cache, dual core, 35 W)	653341-001
	Intel Core i3-2350M 2.30-GHz processor (3.0-MB L3 cache, dual core, 35 W)	653340-001
	Intel Core i3-2330M 2.20-GHz processor (3.0-MB L3 cache, dual core, 35 W)	653339-001
	Intel Pentium B960 TJ85 2.20-GHz processor (2.0-MB L3 cache, dual core, 35 W)	664662-001
	Intel Pentium B950 TJ85 2.10-GHz processor (2.0-MB L3 cache, dual core, 35 W)	653338-001
(15)	Fan/heat sink assembly (includes replacement thermal material):	
	For use only with computer models equipped with an AMD processor and a graphics subsystem with discrete memory	665278-001
	For use only with computer models equipped with an AMD processor and a graphics subsystem with UMA memory	665277-001
	For use only with computer models equipped with an Intel processor and a graphics subsystem with 2048-MB discrete memory	665309-001
	For use only with computer models equipped with an Intel processor and a graphics subsystem with 1024-MB discrete memory	665308-001
	For use only with computer models equipped with an Intel processor and a graphics subsystem with UMA memory	665307-001
(16)	Base enclosure (includes battery release latch and 4 rubber feet)	
	For use only with computer models equipped with USB version 3.0	665298-001
	For use only with computer models equipped with USB version 2.0	665297-001
(17)	Battery:	
	9-cell, 100-Whr, 3.00-Ah Li-ion battery	636631-001
	6-cell, 62-Whr, 2.80-Ah Li-ion battery	593562-001
	6-cell, 55-Whr, 2.55-Ah Li-ion battery	593554-001
(18)	Memory modules (2, DDR3, 10600, 1333-MHz):	
	8 GB	634091-001
	4 GB	621569-001
	2 GB	621565-001
(19)	RTC battery	651038-001
(20)	Hard drive (2.5-in, SATA, does not include hard drive bracket, hard drive connector cable, or screws):	
	1-TB, 5400-rpm, 12.7 mm	638974-001
	750-GB, 7200-rpm, 9.5 mm	633252-001
	750-GB, 5400-rpm, 9.5 mm	634250-001
	640-GB, 5400-rpm, 9.5 mm	603785-001
	500-GB, 7200-rpm, 9.5 mm	608218-001

Item	Component	Spare part number
	500-GB, 7200-rpm, 9.5 mm	634932-001
	320-GB, 7200-rpm, 7.0 mm	634862-001
	320-GB, 5400-rpm, 7.0 mm	645193-001
	160-GB solid-state drive (not illustrated, for use only with computer models equipped with an Intel processor)	666441-001
	Hard Drive Hardware Kit (not illustrated, includes hard drive bracket and screws)	665311-001
(21)	WLAN module:	
	For use on all computer models:	
	Atheros 9485GN 802.11b/g/n 1×1 WiFi and 3012 Bluetooth 4.0 Combo Adapter	655795-001
	Broadcom 4313 802.11b/g/n 1×1 WiFi and 2070 Bluetooth 2.1+EDR Combo Adapter (Bluetooth 3.0+HS ready)	600370-001
	Broadcom 4313GN 802.11b/g/n 1×1 WiFi and 20702 Bluetooth 4.0 Combo Adapter	657325-001
	Ralink 5390GN 802.11b/g/n 1×1 WiFi Adapter	630703-001
	Realtek RTL8191SE 802.11b/g/n 1×1 WiFi Adapter	640926-001
	For use only with computer models equipped with an AMD processor:	
	Atheros AR8002WB-1NGB 802.11b/g/n 1×1 WiFi and Bluetooth 2.1+EDR Combo Adapter (BT3.0+HS ready)	593127-001
	For use only with computer models equipped with an Intel processor:	
	Broadcom 4313 802.11b/g/n 1×1 WiFi Adapter	593836-001
	Intel Centrino Advanced-N 6230 WLAN module	631956-001
	Intel Centrino Wireless-N 1000 WLAN module	593530-001
	Intel Centrino Wireless-N + WiMAX 6150 WLAN module	633817-001
	Ralink RT3090BC4 802.11b/g/n 1×1 WiFi and Bluetooth 2.1+EDR Combo Adapter (Bluetooth 3.0+HS ready)	630705-001
(22)	Optical drive (includes bezel and bracket):	
	Blu-ray Disc ROM FX SuperMulti DVD±R/RW Double-Layer Drive	665329-001
	Blu-ray Disc R/RW FX SuperMulti Drive	665328-001
	DVD±RW Double-Layer FX SuperMulti Drive	665327-001
(23)	Service cover — available in the Plastics Kit, spare part number 665332-001	

Cable Kit



Item	Component	Spare part number
	Cable Kit , includes:	665301-001
(1)	Optical drive connector cable	
(2)	Hard drive connector cable	
(3)	Fingerprint reader board cable	
(4)	USB board cable	
(5)	TouchPad cable	
(6)	TouchPad button board cable	
(7)	Power button board cable	

Display assembly subcomponents

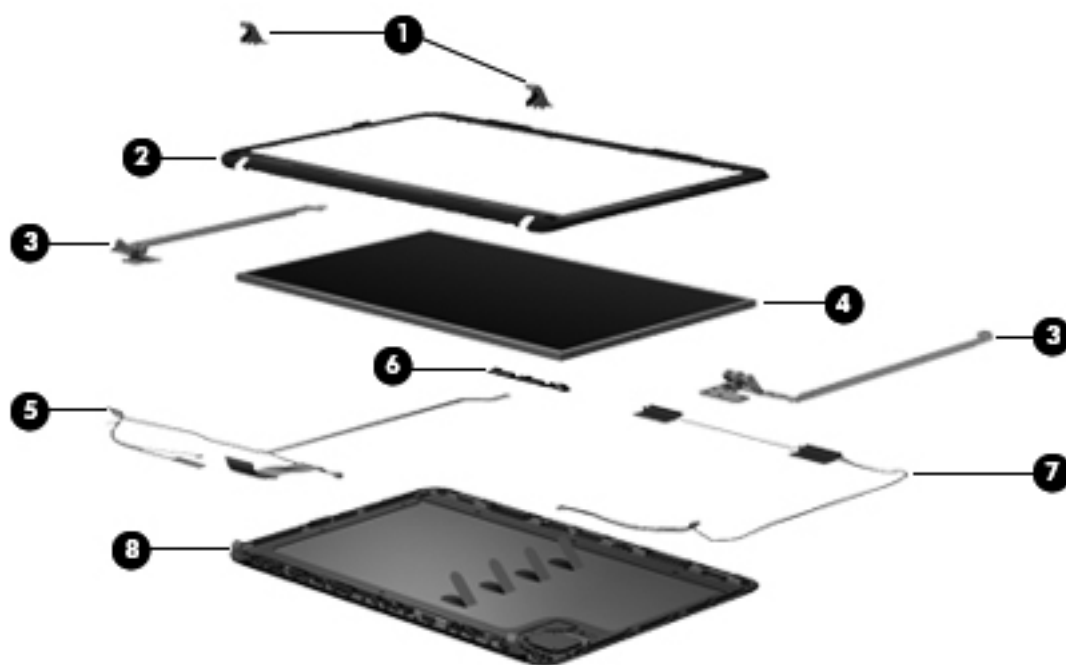

Item	Component	Spare part number
(1)	Display hinge covers (2)	665314-001
(2)	Display bezel:	
	For use only with computer models in dark umber and steel gray finish	665300-001
	For use only with computer models in butter gold, espresso black, linen white, Pacific blue, pearl pink, ruby red, and Sonoma red finish	665299-001
	Display bezel and panel combination spare part kit:	
	15.6-in, FHD, LED, AntiGlare, SVA display panel with display bezel	668279-001
	15.6-in, HD, LED, BrightView, SVA display panel with display bezel in aluminum finish	668280-001
	15.6-in, HD, LED, BrightView, SVA display panel with display bezel	668278-001
(3)	Display Hinge Kit (includes left and right display hinges and brackets)	665313-001
(4)	Display panel:	
	15.6-in, FHD, LED, AntiGlare display panel	665335-001
	15.6-in, HD, LED, BrightView display panel	665334-001
(5)	Display Cable Kit (includes display panel cable and webcam/microphone module cable)	
	For use only with computer models equipped with a FHD display assembly	665305-001
	For use only with computer models in dark umber and steel gray finish	665304-001
	For use only with computer models in butter gold, espresso black, linen white, Pacific blue, pearl pink, ruby red, and Sonoma red finish	665302-001

Item	Component	Spare part number
(6)	Webcamera/microphone module	665365-001
(7)	Antenna Kit (includes left and right wireless antenna cables and transceivers)	665287-001
(8)	Display enclosure:	
	In butter gold finish	665296-001
	In dark umber finish	665288-001
	In espresso black finish	665290-001
	In linen white finish	665291-001
	In Pacific blue finish	665292-001
	In pearl pink finish	665295-001
	In ruby red finish	665294-001
	In Sonoma red finish	665293-001
	In steel gray finish	665289-001
	Display Rubber Kit (not illustrated)	665337-001
	Display Screw Kit (not illustrated)	665339-001

Mass storage devices

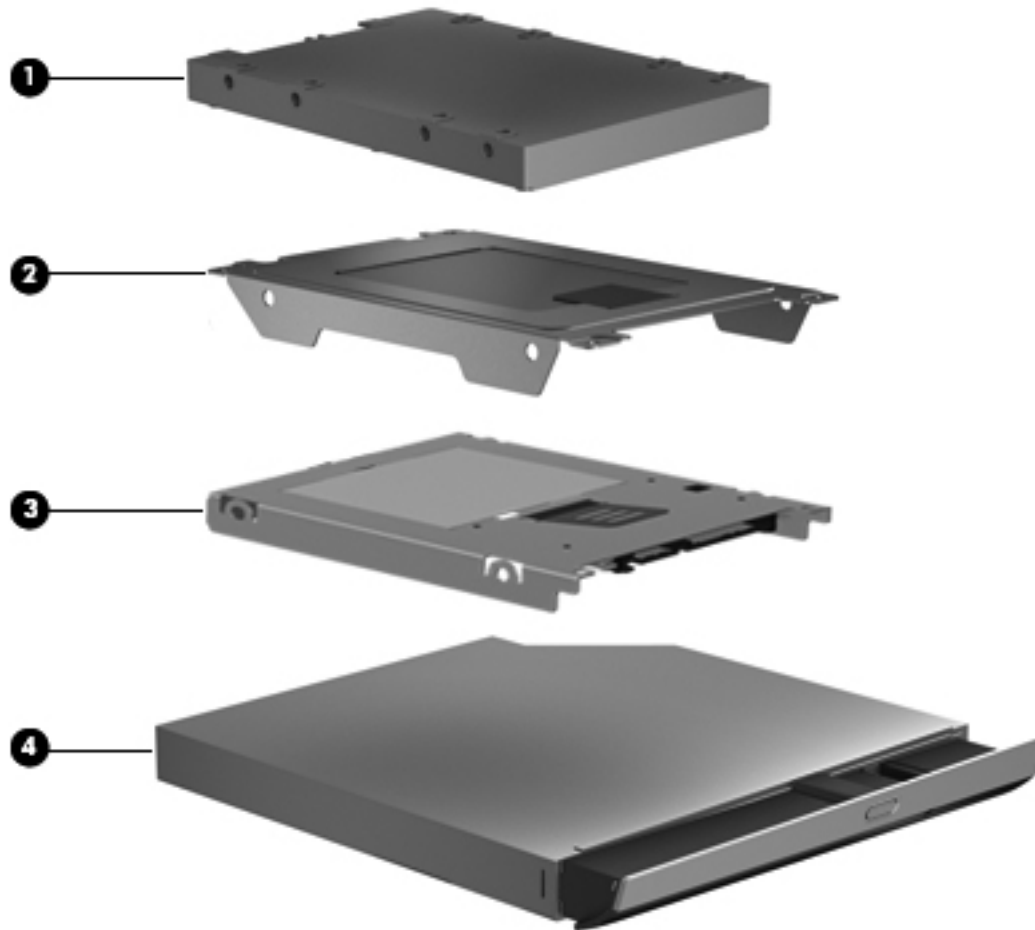

Item	Component	Spare part number
(1)	Hard drive (2.5-in, SATA, does not include hard drive bracket, hard drive connector cable, or screws):	
	1-TB, 5400-rpm, 12.7 mm	638974-001
	750-GB, 7200-rpm, 9.5 mm	633252-001
	750-GB, 5400-rpm, 9.5 mm	634250-001
	640-GB, 5400-rpm, 9.5 mm	603785-001
	500-GB, 7200-rpm, 9.5 mm	608218-001
	500-GB, 7200-rpm, 9.5 mm	634932-001
	320-GB, 7200-rpm, 7.0 mm	634862-001
	320-GB, 5400-rpm, 7.0 mm	645193-001
	Hard Drive Hardware Kit , includes:	665311-001
(2)	Hard drive bracket	
	Hard drive screws (not illustrated)	

Item	Component	Spare part number
(3)	160-GB solid-state drive (for use only with computer models equipped with an Intel processor)	641825-001
(4)	Optical drive (includes bezel and bracket):	
	Blu-ray Disc ROM FX SuperMulti DVD±R/RW Double-Layer Drive	665329-001
	Blu-ray Disc R/RW FX SuperMulti Drive	665328-001
	DVD±RW Double-Layer FX SuperMulti Drive	665327-001

Miscellaneous parts

Component	Spare part number
HP Smart AC adapter:	
For use with all computer models:	
120-W PFC RC V HP Smart AC adapter	609941-001
90-W PFC RC V HP Smart AC adapter	609940-001
65-W RC V HP Smart AC adapter	609939-001
For use only with computer models equipped with an Intel processor:	
90-W PFC RC V EM HP Smart AC adapter	609947-001
65-W RC V EM HP Smart AC adapter	609948-001
Power cord (3-pin, black, 1.83-m):	
For use with all computer models:	
For use in Argentina	490371-D01
For use in Denmark	490371-081
For use in Europe	490371-021
For use in Italy	490371-061
For use in North America	490371-001
For use in South Africa	490371-AR1
For use in Switzerland	490371-111
For use in the United Kingdom and Singapore	490371-031
For use only with computer models equipped with AMD processors in Brazil	490371-202
For use only with computer models equipped with Intel processors:	
For use in Australia	490371-111
For use in India	490371-D61

Component	Spare part number
For use in Israel	490371-BB1
For use in Japan	490371-291
For use in the People's Republic of China	490371-AA1
For use in South Korea	490371-AD1
For use in Taiwan	490371-AB1
For use in Thailand	490371-281
Remote control (full-function, with teletext)	465541-004
USB DVD-T antenna	581223-001
USB DVB-T TV tuner	581222-001
Screw Kit	665338-001

Sequential part number listing

Spare part number	Description
465541-004	Remote control (full-function, with teletext)
490371-001	Power cord for use with all computer models in North America (3-pin, black, 1.83-m)
490371-011	Power cord for use with all computer models in Australia (3-pin, black, 1.83-m)
490371-021	Power cord for use with all computer models in Europe (3-pin, black, 1.83-m)
490371-031	Power cord for use with all computer models in the United Kingdom and Singapore (3-pin, black, 1.83-m)
490371-061	Power cord for use with all computer models in Italy (3-pin, black, 1.83-m)
490371-081	Power cord for use with all computer models in Denmark (3-pin, black, 1.83-m)
490371-111	Power cord for use with all computer models in Switzerland (3-pin, black, 1.83-m)
490371-201	Power cord for use only with computer models equipped with an Intel processor in Thailand (3-pin, black, 1.83-m)
490371-202	Power cord for use with all computer models in Brazil (3-pin, black, 1.83-m)
490371-291	Power cord for use with all computer models in Japan (3-pin, black, 1.83-m)
490371-AA1	Power cord for use only with computer models equipped with an Intel processor in the People's Republic of China (3-pin, black, 1.83-m)
490371-AB1	Power cord for use only with computer models equipped with an Intel processor in Taiwan (3-pin, black, 1.83-m)
490371-AD1	Power cord for use only with computer models equipped with an Intel processor in South Korea (3-pin, black, 1.83-m)
490371-AR1	Power cord for use with all computer models in South Africa (3-pin, black, 1.83-m)

Spare part number	Description
490371-BB1	Power cord for use only with computer models equipped with an Intel processor in Israel (3-pin, black, 1.83-m)
490371-D01	Power cord for use with all computer models in Argentina (3-pin, black, 1.83-m)
490371-D61	Power cord for use only with computer models equipped with an Intel processor in India (3-pin, black, 1.83-m)
581222-001	USB DVB-T TV tuner
581223-001	USB DVD-T antenna
593127-001	Atheros AR8002WB-1NGB 802.11b/g/n 1×1 WiFi and Bluetooth 2.1+EDR Combo Adapter (BT3.0+HS ready) for use only with computer models equipped with an AMD processor
593530-001	Intel Centrino Wireless-N 1000 WLAN module for use only on computer models equipped with an Intel processor
593554-001	6-cell, 55-Whr, 2.55-Ah Li-ion battery
593562-001	6-cell, 62-Whr, 2.80-Ah Li-ion battery
593836-001	Broadcom 4313 802.11b/g/n 1×1 WiFi Adapter for use only on computer models equipped with an Intel processor
600370-001	Broadcom 4313 802.11b/g/n 1×1 WiFi and 2070 Bluetooth 2.1+EDR Combo Adapter (Bluetooth 3.0+HS ready) for use with all computer models
603785-001	640-GB, 5400-rpm, 9.5-mm hard drive for use with all computer models (2.5-in, SATA, does not include hard drive bracket, hard drive connector cable, or screws)
608218-001	500-GB, 7200-rpm, 9.5-mm hard drive for use with all computer models (2.5-in, SATA, does not include hard drive bracket, hard drive connector cable, or screws)
609939-001	65-W RC V HP Smart AC adapter for use with all computer models
609940-001	90-W PFC RC V HP Smart AC adapter for use with all computer models
609941-001	120-W PFC RC V HP Smart AC adapter for use with all computer models
609947-001	90-W PFC RC V EM HP Smart AC adapter for use only with computer models equipped with an Intel processor
609948-001	65-W PFC RC V EM HP Smart AC adapter for use only with computer models equipped with an Intel processor
621565-001	2-GB memory module (DDR3, 10600, 1333-MHz)
621569-001	4-GB memory module (DDR3, 10600, 1333-MHz)
630703-001	Ralink 5390GN 802.11b/g/n 1×1 WiFi Adapter for use with all computer models
630705-001	Ralink RT3090BC4 802.11b/g/n 1×1 WiFi and Bluetooth 2.1+EDR Combo Adapter (Bluetooth 3.0+HS ready) for use only on computer models equipped with an Intel processor
631252-001	Intel Core i7-2620M 2.70-GHz (SC turbo up to 3.40-GHz) processor (4.0-MB L3 cache, dual core, 35 W; includes replacement thermal material)
631253-001	Intel Core i5-2520M 2.50-GHz (SC turbo up to 3.20-GHz) processor (3.0-MB L3 cache, dual core, 35 W; includes replacement thermal material)

Spare part number	Description
631254-001	Intel Core i7-2720QM 2.20-GHz (SC turbo up to 3.00-GHz) processor (6.0-MB L3 cache, quad core, 45 W; includes replacement thermal material)
631255-001	Intel Core i5-2540M 2.60-GHz (SC turbo up to 3.30-GHz) processor (3.0-MB L3 cache, dual core, 35 W; includes replacement thermal material)
631956-001	Intel Centrino Advanced-N 6230 WLAN module for use only on computer models equipped with an Intel processor
633252-001	750-GB, 7200-rpm, 9.5-mm hard drive for use with all computer models (2.5-in, SATA, does not include hard drive bracket, hard drive connector cable, or screws)
633817-001	Intel Centrino Wireless-N + WiMAX 6150 WLAN module for use only with computer models equipped with an Intel processor
634091-001	8-GB memory module (DDR3, 10600, 1333-MHz)
634250-001	750-GB, 5400-rpm, 9.5-mm hard drive for use with all computer models (2.5-in, SATA, does not include hard drive bracket, hard drive connector cable, or screws)
634694-001	Intel Core i7-2820QM 2.30-GHz (SC turbo up to 3.20-GHz) processor (1600-MHz FSB, 8.0-MB L3 cache, quad core, 45 W; includes replacement thermal material)
634862-001	320-GB, 7200-rpm, 7.0-mm hard drive for use with all computer models (2.5-in, SATA, does not include hard drive bracket, hard drive connector cable, or screws)
634932-001	500-GB, 5400-rpm, 7.0-mm hard drive for use with all computer models (2.5-in, SATA, does not include hard drive bracket, hard drive connector cable, or screws)
635501-001	Intel Core i7-2630QM 2.00-GHz (SC turbo up to 2.90-GHz) processor (1333-MHz FSB, 6.0-MB L3 cache, quad core, 45 W; includes replacement thermal material)
636631-001	9-cell, 100-Whr, 3.00-Ah Li-ion battery
638974-001	1-TB, 5400-rpm, 12.7-mm hard drive for use with all computer models (2.5-in, SATA, does not include hard drive bracket, hard drive connector cable, or screws)
640926-001	Realtek 8188GN 802.11b/g/n 1x1 WiFi Adapter for use with all computer models
645193-001	320-GB, 5400-rpm, 7.0-mm hard drive for use with all computer models (2.5-in, SATA, does not include hard drive bracket, hard drive connector cable, or screws)
651038-001	RTC battery
653338-001	Intel Pentium B950 TJ85 2.10-GHz processor (2.0-MB L3 cache, dual core, 35 W; includes replacement thermal material)
653339-001	Intel Core i3-2330M 2.20-GHz processor (3.0-MB L3 cache, dual core, 35 W; includes replacement thermal material)
653340-001	Intel Core i3-2350M 2.30-GHz processor (3.0-MB L3 cache, dual core, 35 W; includes replacement thermal material)
653341-001	Intel Core i5-2430M 2.40-GHz (SC turbo up to 3.00-GHz) processor (3.0-MB L3 cache, dual core, 35 W; includes replacement thermal material)
653348-001	AMD A4-3300M 2.50-GHz processor (1.9-GHz FSB, 4.0-MB L2 cache, dual core, 35 W; includes replacement thermal material)
653349-001	AMD A6-3400M 2.30-GHz processor (1.4-GHz FSB, 4.0-MB L2 cache, quad core, 35 W; includes replacement thermal material)

Spare part number	Description
653350-001	AMD A8-3500M 2.40-GHz processor (1.5-GHz FSB, 4.0-MB L2 cache, quad core, 35 W; includes replacement thermal material)
653356-001	AMD A4-3310MX 2.50-GHz processor (2.10-GHz FSB, 2.0-MB L2 cache, dual core, 45 W; includes replacement thermal material)
653357-001	AMD A6-3410MX 2.30-GHz processor (1.60-GHz FSB, 2.0-MB L2 cache, quad core, 45 W; includes replacement thermal material)
653358-001	AMD A8-3510MX 2.50-GHz processor (1.80-GHz FSB, 4.0-MB L2 cache, quad core, 45 W; includes replacement thermal material)
653364-001	AMD A8-3530MX 2.60-GHz processor, (1.90-GHz FSB, 4.0-MB L2 cache, quad core, 45 W; includes replacement thermal material)
655792-001	4.0 EDR Bluetooth module (for use only with computer models equipped with an Intel processor) NOTE: The Bluetooth module spare part kit does not include the Bluetooth module cable. The Bluetooth module cable is available using spare part number 665303-001.
655795-001	Atheros 9485GN 802.11b/g/n 1×1 WiFi and 3012 Bluetooth 4.0 Combo Adapter for use with all computer models
657325-001	Broadcom 4313GN 802.11b/g/n 1×1 WiFi and 20702 Bluetooth 4.0 Combo Adapter for use with all computer models
664662-001	Intel Pentium B960 TJ85 2.20-GHz processor (2.0-MB L3 cache, dual core, 35 W; includes replacement thermal material)
665116-001	Intel Core i7-2670QM 2.20-GHz (SC turbo up to 3.10-GHz) processor (1600-MHz FSB, 6.0-MB L3 cache, dual core, 45 W; includes replacement thermal material)
665277-001	Fan/heat sink assembly for use only with computer models equipped with an AMD processor and a graphics subsystem with UMA memory (includes replacement thermal material)
665278-001	Fan/heat sink assembly for use only with computer models equipped with an AMD processor and a graphics subsystem with discrete memory (includes replacement thermal material)
665279-001	System board for use only with computer models equipped with an AMD A60M processor and a graphics subsystem with UMA memory (includes replacement thermal material)
665280-001	System board for use only with computer models equipped with an AMD A60M processor and a graphics subsystem with 512-MB discrete memory (includes replacement thermal material)
665281-001	System board for use only with computer models equipped with an AMD A60M processor and a graphics subsystem with 1024-MB discrete memory (includes replacement thermal material)
665282-001	System board for use only with computer models equipped with an AMD A70M processor and a graphics subsystem with UMA memory (includes replacement thermal material)
665284-001	System board for use only with computer models equipped with an AMD A70M processor and a graphics subsystem with 1024-MB discrete memory (includes replacement thermal material)
665285-001	Thermal Material Kit for use only with computer models equipped with an AMD processor and a graphics subsystem with UMA memory (includes replacement thermal paste and pads)
665286-001	Thermal Material Kit for use only with computer models equipped with an AMD processor and a graphics subsystem with discrete memory (includes replacement thermal paste and pads)
665287-001	Antenna Kit (includes left and right wireless antenna cables and transceivers)
665288-001	Display enclosure in dark umber finish

Spare part number	Description
665289-001	Display enclosure in steel gray finish
665290-001	Display enclosure in espresso black finish
665291-001	Display enclosure in linen white finish
665292-001	Display enclosure in Pacific blue finish
665293-001	Display enclosure in Sonoma red finish
665294-001	Display enclosure in ruby red finish
665295-001	Display enclosure in pearl pink finish
665296-001	Display enclosure in butter gold finish
665297-001	Base enclosure for use with computer models equipped with USB version 2.0 (includes battery release latch and 4 rubber feet)
665298-001	Base enclosure for use with computer models equipped with USB version 3.0 (includes battery release latch and 4 rubber feet)
665299-001	Display bezel for use only with computer models in butter gold, espresso black, linen white, Pacific blue, pearl pink, ruby red, and Sonoma red finish and equipped with a webcam/microphone module
665300-001	Display bezel for use only with computer models in dark umber and steel gray finish and equipped with a webcam/microphone module
665301-001	Cable Kit (includes the optical drive connector cable, hard drive connector cable, power button board cable, fingerprint reader board cable, TouchPad cable, TouchPad button board cable, and USB board cable)
665302-001	Display Cable Kit for use only with computer models in butter gold, espresso black, linen white, Pacific blue, pearl pink, ruby red, and Sonoma red finish (includes display panel cable and webcam/microphone module cable)
665303-001	Bluetooth module cable (for use only with computer models equipped with an Intel processor)
665304-001	Display Cable Kit for use only with computer models equipped with an HD display assembly (includes display panel cable and webcam/microphone module cable)
665305-001	Display Cable Kit for use only with computer models equipped with an FHD display assembly (includes display panel cable and webcam/microphone module cable)
665306-001	Power connector cable
665307-001	Fan/heat sink assembly for use only with computer models equipped with an Intel processor and a graphics subsystem with UMA memory (includes replacement thermal material)
665308-001	Fan/heat sink assembly for use only with computer models equipped with an Intel processor and a graphics subsystem with 1024-MB of discrete memory (includes replacement thermal material)
665309-001	Fan/heat sink assembly for use only with computer models equipped with an Intel processor and a graphics subsystem with 2048-MB of discrete memory (includes replacement thermal material)
665310-001	Fingerprint reader board (select models only, includes bracket, but does not include cable)
	NOTE: The fingerprint reader board cable is not included in the fingerprint reader board spare part kit. The fingerprint reader board cable is included in the Cable Kit, spare part number 665301-001.

Spare part number	Description
665311-001	Hard Drive Hardware Kit (includes hard drive bracket and screws)
665313-001	Display Hinge Kit (includes left and right display hinges and brackets)
665314-001	Display hinge covers (2)
665326-001	Keyboard in black finish for use in the United States (includes keyboard cable)
665326-031	Keyboard in black finish for use in the United Kingdom and Singapore (includes keyboard cable)
665326-041	Keyboard in black finish for use in Germany (includes keyboard cable)
665326-051	Keyboard in black finish for use in France (includes keyboard cable)
665326-061	Keyboard in black finish for use in Italy (includes keyboard cable)
665326-071	Keyboard in black finish for use in Spain (includes keyboard cable)
665326-121	Keyboard in black finish for use in Canada (includes keyboard cable)
665326-131	Keyboard in black finish for use in Portugal (includes keyboard cable)
665326-141	Keyboard in black finish for use in Turkey (includes keyboard cable)
665326-161	Keyboard in black finish for use in Latin America (includes keyboard cable)
665326-171	Keyboard in black finish for use in Saudi Arabia (includes keyboard cable)
665326-201	Keyboard in black finish for use in Brazil (includes keyboard cable)
665326-211	Keyboard in black finish for use in Hungary (includes keyboard cable)
665326-251	Keyboard in black finish for use in Russia (includes keyboard cable)
665326-261	Keyboard in black finish for use only on computer models equipped with an AMD processor in Bulgaria (includes keyboard cable)
665326-281	Keyboard in black finish for use only on computer models equipped with an Intel processor in Thailand (includes keyboard cable)
665326-291	Keyboard in black finish for use in Japan (includes keyboard cable)
665326-A41	Keyboard in black finish for use in Belgium (includes keyboard cable)
665326-AB1	Keyboard in black finish for use only on computer models equipped with an Intel processor in Taiwan (includes keyboard cable)
665326-AD1	Keyboard in black finish for use only on computer models equipped with an Intel processor in South Korea (includes keyboard cable)
665326-B31	Keyboard in black finish for use in the Netherlands (includes keyboard cable)
665326-BA1	Keyboard in black finish for use in Slovenia (includes keyboard cable)
665326-BB1	Keyboard in black finish for use only on computer models equipped with an Intel processor in Israel (includes keyboard cable)
665326-BG1	Keyboard in black finish for use in Switzerland (includes keyboard cable)
665326-D61	Keyboard in black finish for use only on computer models equipped with an Intel processor in India (includes keyboard cable)
665326-DH1	Keyboard in black finish for use in Denmark, Finland, and Norway (includes keyboard cable)

Spare part number	Description
665326-DJ1	Keyboard in black finish for use in Slovakia (includes keyboard cable)
665326-FL1	Keyboard in black finish for use in the Czech Republic and Slovenia (includes keyboard cable)
665327-001	DVD±RW Double-Layer FX SuperMulti Drive
665328-001	Blu-ray Disc R/RW FX SuperMulti Drive
665329-001	Blu-ray Disc ROM FX SuperMulti DVD±R/RW Double-Layer Drive
665330-001	Power button board (does not include cable)
	NOTE: The power button board cable is not included in the power button board spare part kit. The power button board cable is included in the Cable Kit, spare part number 665301-001.
665331-001	USB board (does not include cable)
	NOTE: The USB board cable is not included in the USB board spare part kit. The USB board cable is included in the Cable Kit, spare part number 665301-001.
665332-001	Plastics Kit (includes the service cover)
665333-001	Speaker cover
665334-001	15.6-in, HD, LED, BrightView, SVA display panel
665335-001	15.6-in, FHD, LED, AntiGlare, SVA display panel
665337-001	Display Rubber Kit
665338-001	Screw Kit
665339-001	Display Screw Kit
665340-001	Speaker Kit (includes left and right speakers and cable)
665341-001	System board for use only with computer models equipped with an Intel dual core processor, the HM65 chipset, the HD6770 graphics subsystem with discrete memory, and USB version 3.0 (includes 2048-MB of discrete graphics subsystem memory; includes replacement thermal material)
665342-001	System board for use only with computer models equipped with an Intel quad core processor, the HM65 chipset, the HD6770 graphics subsystem with discrete memory, and USB version 3.0 (includes 2048-MB of discrete graphics subsystem memory; includes replacement thermal material)
665343-001	System board for use only with computer models equipped with an Intel dual core processor, the HM65 chipset, the HD6770 graphics subsystem with discrete memory, and USB version 3.0 (includes 1024-MB of discrete graphics subsystem memory; includes replacement thermal material)
665344-001	System board for use only with computer models equipped with an Intel quad core processor, the HM65 chipset, the HD6770 graphics subsystem with discrete memory, and USB version 3.0 (includes 1024-MB of discrete graphics subsystem memory; includes replacement thermal material)
665345-001	System board for use only with computer models equipped with an Intel dual core processor, the HM65 chipset, the HD6490 graphics subsystem with discrete memory, and USB version 3.0 (includes 1024-MB of discrete graphics subsystem memory; includes replacement thermal material)

Spare part number	Description
665346-001	System board for use only with computer models equipped with an Intel quad core processor, the HM65 chipset, the HD6490 graphics subsystem with discrete memory, and USB version 2.0 (includes 1024-MB of discrete graphics subsystem memory; includes replacement thermal material)
665347-001	System board for use only with computer models equipped with an Intel dual core processor, the HM65 chipset, the HD6490 graphics subsystem with discrete memory, and USB version 3.0 (includes 1024-MB of discrete graphics subsystem memory; includes replacement thermal material)
665348-001	System board for use only with computer models equipped with an Intel quad core processor, the HM65 chipset, the HD6490 graphics subsystem with discrete memory, and USB version 3.0 (includes 1024-MB of discrete graphics subsystem memory; includes replacement thermal material)
665349-001	System board for use only with computer models equipped with an Intel dual core processor, the HM65 chipset, a graphics subsystem with UMA memory, and USB version 2.0 (includes replacement thermal material)
665350-001	System board for use only with computer models equipped with an Intel quad core processor, the HM65 chipset, a graphics subsystem with UMA memory, and USB version 2.0 (includes replacement thermal material)
665351-001	System board for use only with computer models equipped with an Intel dual core processor, the HM65 chipset, a graphics subsystem with UMA memory, and USB version 3.0 (includes replacement thermal material)
665352-001	System board for use only with computer models equipped with an Intel quad core processor, the HM65 chipset, a graphics subsystem with UMA memory, and USB version 3.0 (includes replacement thermal material)
665353-001	Thermal Material Kit for use only with computer models equipped with an Intel processor and a graphics subsystem with UMA memory (includes replacement thermal paste and pads)
665354-001	Thermal Material Kit for use only with computer models equipped with an Intel processor and a graphics subsystem with 1024-MB discrete memory (includes replacement thermal paste and pads)
665355-001	Thermal Material Kit for use only with computer models equipped with an Intel processor and a graphics subsystem with 2048-MB discrete memory (includes replacement thermal paste and pads)
665356-001	Top cover in dark umber finish (includes TouchPad and TouchPad button board, but does not include TouchPad cable or TouchPad button board cable) NOTE: The TouchPad cable and TouchPad button board cable are included in the Cable Kit, spare part number 665301-001.
665357-001	Top cover in steel grey finish (includes TouchPad and TouchPad button board, but does not include TouchPad cable or TouchPad button board cable) NOTE: The TouchPad cable and TouchPad button board cable are included in the Cable Kit, spare part number 665301-001.
665358-001	Top cover in espresso black finish (includes TouchPad and TouchPad button board, but does not include TouchPad cable or TouchPad button board cable) NOTE: The TouchPad cable and TouchPad button board cable are included in the Cable Kit, spare part number 665301-001.

Spare part number	Description
665359-001	Top cover in linen white finish (includes TouchPad and TouchPad button board, but does not include TouchPad cable or TouchPad button board cable) NOTE: The TouchPad cable and TouchPad button board cable are included in the Cable Kit, spare part number 665301-001.
665360-001	Top cover in Pacific blue finish (includes TouchPad and TouchPad button board, but does not include TouchPad cable or TouchPad button board cable) NOTE: The TouchPad cable and TouchPad button board cable are included in the Cable Kit, spare part number 665301-001.
665361-001	Top cover in Sonora red finish (includes TouchPad and TouchPad button board, but does not include TouchPad cable or TouchPad button board cable) NOTE: The TouchPad cable and TouchPad button board cable are included in the Cable Kit, spare part number 665301-001.
665362-001	Top cover in ruby red finish (includes TouchPad and TouchPad button board, but does not include TouchPad cable or TouchPad button board cable) NOTE: The TouchPad cable and TouchPad button board cable are included in the Cable Kit, spare part number 665301-001.
665363-001	Top cover in pearl pink finish (includes TouchPad and TouchPad button board, but does not include TouchPad cable or TouchPad button board cable) NOTE: The TouchPad cable and TouchPad button board cable are included in the Cable Kit, spare part number 665301-001.
665364-001	Top cover in butter gold finish (includes TouchPad and TouchPad button board, but does not include TouchPad cable or TouchPad button board cable) NOTE: The TouchPad cable and TouchPad button board cable are included in the Cable Kit, spare part number 665301-001.
665365-001	Webcamera/microphone module
666173-001	Intel Core i7-2640M 2.80-GHz (SC turbo up to 3.50-GHz) processor (1333-MHz FSB, 4.0-MB L3 cache, dual core, 35 W; includes replacement thermal material)
666174-001	Intel Core i7-2760QM 2.40-GHz (SC turbo up to 3.50-GHz) processor (1600-MHz FSB, 6.0-MB L3 cache, dual core, 45 W; includes replacement thermal material)
666175-001	Intel Core i7-2860QM 2.50-GHz (SC turbo up to 3.60-GHz) processor (1600-MHz FSB, 8.0-MB L3 cache, dual core, 45 W; includes replacement thermal material)
666423-001	Keyboard in silver finish for use in the United States (includes keyboard cable)
666423-031	Keyboard in silver finish for use in the United Kingdom and Singapore (includes keyboard cable)
666423-041	Keyboard in silver finish for use in Germany (includes keyboard cable)
666423-051	Keyboard in silver finish for use in France (includes keyboard cable)
666423-061	Keyboard in silver finish for use in Italy (includes keyboard cable)
666423-071	Keyboard in silver finish for use in Spain (includes keyboard cable)
666423-121	Keyboard in silver finish for use in Canada (includes keyboard cable)
666423-131	Keyboard in silver finish for use in Portugal (includes keyboard cable)

Spare part number	Description
666423-141	Keyboard in silver finish for use in Turkey (includes keyboard cable)
666423-161	Keyboard in silver finish for use in Latin America (includes keyboard cable)
666423-171	Keyboard in silver finish for use in Saudi Arabia (includes keyboard cable)
666423-201	Keyboard in silver finish for use in Brazil (includes keyboard cable)
666423-211	Keyboard in silver finish for use in Hungary (includes keyboard cable)
666423-251	Keyboard in silver finish for use in Russia (includes keyboard cable)
666423-261	Keyboard in silver finish for use only on computer models equipped with an AMD processor in Bulgaria (includes keyboard cable)
666423-281	Keyboard in silver finish for use only on computer models equipped with an Intel processor in Thailand (includes keyboard cable)
666423-291	Keyboard in silver finish for use in Japan (includes keyboard cable)
666423-A41	Keyboard in silver finish for use in Belgium (includes keyboard cable)
666423-AB1	Keyboard in silver finish for use only on computer models equipped with an Intel processor in Taiwan (includes keyboard cable)
666423-AD1	Keyboard in silver finish for use only on computer models equipped with an Intel processor in South Korea (includes keyboard cable)
666423-B31	Keyboard in silver finish for use in the Netherlands (includes keyboard cable)
666423-BA1	Keyboard in silver finish for use in Slovenia (includes keyboard cable)
666423-BB1	Keyboard in silver finish for use only on computer models equipped with an Intel processor in Israel (includes keyboard cable)
666423-BG1	Keyboard in silver finish for use in Switzerland (includes keyboard cable)
666423-D61	Keyboard in silver finish for use only on computer models equipped with an Intel processor in India (includes keyboard cable)
666423-DH1	Keyboard in silver finish for use in Denmark, Finland, and Norway (includes keyboard cable)
666423-DJ1	Keyboard in silver finish for use in Slovakia (includes keyboard cable)
666423-FL1	Keyboard in silver finish for use in the Czech Republic and Slovenia (includes keyboard cable)
666441-001	160-GB solid-state drive (for use only with computer models equipped with an Intel processor)
668278-001	15.6-in, HD, LED, BrightView, SVA display panel with display bezel
668279-001	15.6-in, FHD, LED, AntiGlare, SVA display panel with display bezel
668280-001	15.6-in, HD, LED, BrightView, SVA display panel with display bezel in aluminum finish

4 Removal and replacement procedures

Preliminary replacement requirements

Tools required

You will need the following tools to complete the removal and replacement procedures:

- Flat-bladed screwdriver
- Magnetic screwdriver
- Phillips P0 and P1 screwdrivers

Service considerations

The following sections include some of the considerations that you must keep in mind during disassembly and assembly procedures.

 **NOTE:** As you remove each subassembly from the computer, place the subassembly (and all accompanying screws) away from the work area to prevent damage.

Plastic parts

 **CAUTION:** Using excessive force during disassembly and reassembly can damage plastic parts. Use care when handling the plastic parts. Apply pressure only at the points designated in the maintenance instructions.

Cables and connectors

 **CAUTION:** When servicing the computer, be sure that cables are placed in their proper locations during the reassembly process. Improper cable placement can damage the computer.

Cables must be handled with extreme care to avoid damage. Apply only the tension required to unseat or seat the cables during removal and insertion. Handle cables by the connector whenever possible. In all cases, avoid bending, twisting, or tearing cables. Be sure that cables are routed in such a way that they cannot be caught or snagged by parts being removed or replaced. Handle flex cables with extreme care; these cables tear easily.

Drive handling

⚠ CAUTION: Drives are fragile components that must be handled with care. To prevent damage to the computer, damage to a drive, or loss of information, observe these precautions:

Before removing or inserting a hard drive, shut down the computer. If you are unsure whether the computer is off or in Hibernation, turn the computer on, and then shut it down through the operating system.

Before handling a drive, be sure that you are discharged of static electricity. While handling a drive, avoid touching the connector.

Before removing a diskette drive or optical drive, be sure that a diskette or disc is not in the drive and be sure that the optical drive tray is closed.

Handle drives on surfaces covered with at least one inch of shock-proof foam.

Avoid dropping drives from any height onto any surface.

After removing a hard drive, an optical drive, or a diskette drive, place it in a static-proof bag.

Avoid exposing an internal hard drive to products that have magnetic fields, such as monitors or speakers.

Avoid exposing a drive to temperature extremes or liquids.

If a drive must be mailed, place the drive in a bubble pack mailer or other suitable form of protective packaging and label the package "FRAGILE."

Grounding guidelines

Electrostatic discharge damage

Electronic components are sensitive to electrostatic discharge (ESD). Circuitry design and structure determine the degree of sensitivity. Networks built into many integrated circuits provide some protection, but in many cases, ESD contains enough power to alter device parameters or melt silicon junctions.

A discharge of static electricity from a finger or other conductor can destroy static-sensitive devices or microcircuitry. Even if the spark is neither felt nor heard, damage may have occurred.

An electronic device exposed to ESD may not be affected at all and can work perfectly throughout a normal cycle. Or the device may function normally for a while, then degrade in the internal layers, reducing its life expectancy.

⚠ CAUTION: To prevent damage to the computer when you are removing or installing internal components, observe these precautions:

Keep components in their electrostatic-safe containers until you are ready to install them.

Before touching an electronic component, discharge static electricity by using the guidelines described in this section.

Avoid touching pins, leads, and circuitry. Handle electronic components as little as possible.

If you remove a component, place it in an electrostatic-safe container.

The following table shows how humidity affects the electrostatic voltage levels generated by different activities.

⚠ CAUTION: A product can be degraded by as little as 700 V.

Typical electrostatic voltage levels			
Event	Relative humidity		
	10%	40%	55%
Walking across carpet	35,000 V	15,000 V	7,500 V
Walking across vinyl floor	12,000 V	5,000 V	3,000 V
Motions of bench worker	6,000 V	800 V	400 V
Removing DIPS from plastic tube	2,000 V	700 V	400 V
Removing DIPS from vinyl tray	11,500 V	4,000 V	2,000 V
Removing DIPS from Styrofoam	14,500 V	5,000 V	3,500 V
Removing bubble pack from PCB	26,500 V	20,000 V	7,000 V
Packing PCBs in foam-lined box	21,000 V	11,000 V	5,000 V

Packaging and transporting guidelines

Follow these grounding guidelines when packaging and transporting equipment:

- To avoid hand contact, transport products in static-safe tubes, bags, or boxes.
- Protect ESD-sensitive parts and assemblies with conductive or approved containers or packaging.
- Keep ESD-sensitive parts in their containers until the parts arrive at static-free workstations.
- Place items on a grounded surface before removing items from their containers.
- Always be properly grounded when touching a component or assembly.
- Store reusable ESD-sensitive parts from assemblies in protective packaging or nonconductive foam.
- Use transporters and conveyors made of antistatic belts and roller bushings. Be sure that mechanized equipment used for moving materials is wired to ground and that proper materials are selected to avoid static charging. When grounding is not possible, use an ionizer to dissipate electric charges.

Workstation guidelines

Follow these grounding workstation guidelines:

- Cover the workstation with approved static-shielding material.
- Use a wrist strap connected to a properly grounded work surface and use properly grounded tools and equipment.
- Use conductive field service tools, such as cutters, screwdrivers, and vacuums.
- When fixtures must directly contact dissipative surfaces, use fixtures made only of static-safe materials.
- Keep the work area free of nonconductive materials, such as ordinary plastic assembly aids and Styrofoam.
- Handle ESD-sensitive components, parts, and assemblies by the case or PCM laminate. Handle these items only at static-free workstations.
- Avoid contact with pins, leads, or circuitry.
- Turn off power and input signals before inserting or removing connectors or test equipment.

Equipment guidelines

Grounding equipment must include either a wrist strap or a foot strap at a grounded workstation.

- When seated, wear a wrist strap connected to a grounded system. Wrist straps are flexible straps with a minimum of one megohm $\pm 10\%$ resistance in the ground cords. To provide proper ground, wear a strap snugly against the skin at all times. On grounded mats with banana-plug connectors, use alligator clips to connect a wrist strap.
- When standing, use foot straps and a grounded floor mat. Foot straps (heel, toe, or boot straps) can be used at standing workstations and are compatible with most types of shoes or boots. On conductive floors or dissipative floor mats, use foot straps on both feet with a minimum of one megohm resistance between the operator and ground. To be effective, the conductive must be worn in contact with the skin.

The following grounding equipment is recommended to prevent electrostatic damage:

- Antistatic tape
- Antistatic smocks, aprons, and sleeve protectors
- Conductive bins and other assembly or soldering aids
- Nonconductive foam
- Conductive tabletop workstations with ground cords of one megohm resistance
- Static-dissipative tables or floor mats with hard ties to the ground
- Field service kits
- Static awareness labels
- Material-handling packages
- Nonconductive plastic bags, tubes, or boxes
- Metal tote boxes
- Electrostatic voltage levels and protective materials

The following table lists the shielding protection provided by antistatic bags and floor mats.

Material	Use	Voltage protection level
Antistatic plastics	Bags	1,500 V
Carbon-loaded plastic	Floor mats	7,500 V
Metallized laminate	Floor mats	5,000 V

Component replacement procedures

This chapter provides removal and replacement procedures.

There are as many as 88 screws that must be removed, replaced, or loosened when servicing the computer. Make special note of each screw and screw lock size and location during removal and replacement.

Service tag

When ordering parts or requesting information, provide the computer serial number and model number provided on the service tag.

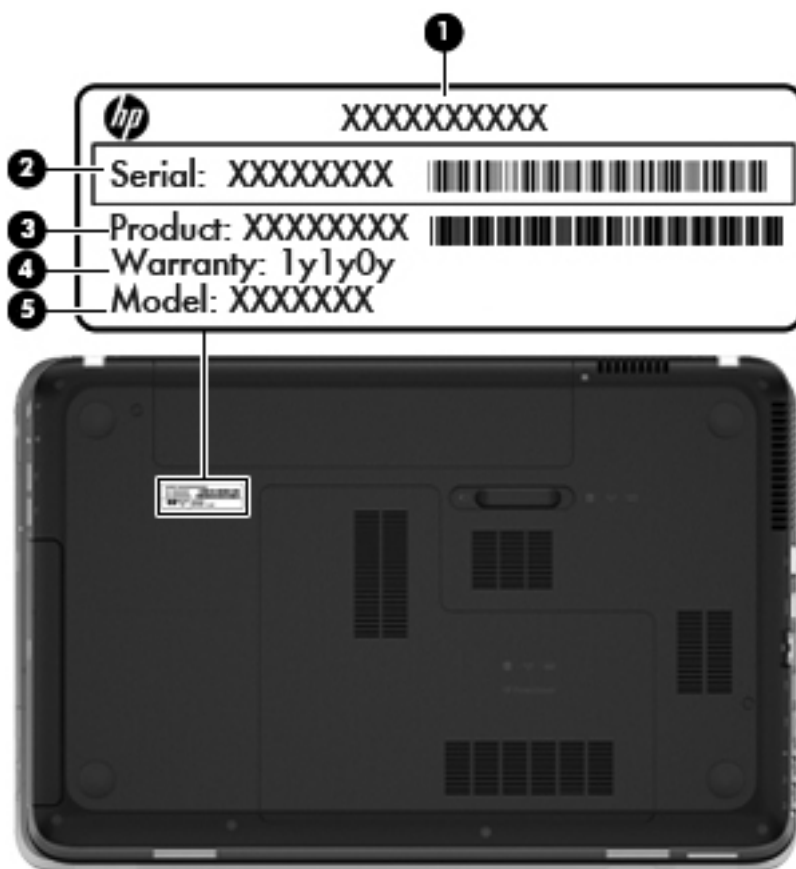

Item	Component	Description
(1)	Product name	This is the product name affixed to the front of the computer.
(2)	Serial number (s/n)	This is an alphanumeric identifier that is unique to each product.
(3)	Part number/Product number (p/n)	This number provides specific information about the product's hardware components. The part number helps a service technician determine what components and parts are needed.

Item	Component	Description
(4)	Warranty period	This number describes the duration of the warranty period for the computer.
(5)	Model description	This is the alphanumeric identifier used to locate documents, drivers, and support for the computer.

Computer feet

the computer feet are adhesive-backed rubber pads. There are 4 rubber feet that attach to the base enclosure in the locations illustrated below.

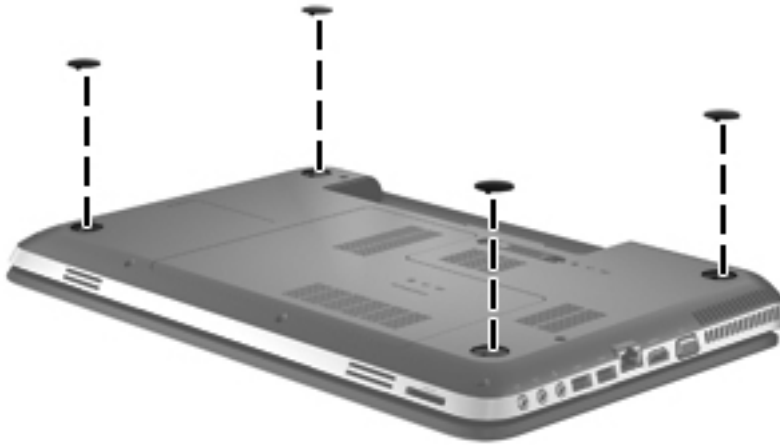

Battery

Description	Spare part number
9-cell, 100-Whr, 3.00-Ah Li-ion battery	636631-001
6-cell, 62-Whr, 2.80-Ah Li-ion battery	593562-001
6-cell, 55-Whr, 2.55-Ah Li-ion battery	593554-001

Before disassembling the computer, follow these steps:

1. Shut down the computer. If you are unsure whether the computer is off or in Hibernation, turn the computer on, and then shut it down through the operating system.
2. Disconnect all external devices connected to the computer.
3. Disconnect the power from the computer by first unplugging the power cord from the AC outlet and then unplugging the AC adapter from the computer.

Remove the battery:

1. Slide the battery release latch **(1)** to release the battery.
2. Pivot the front edge of the battery **(2)** up and back.
3. Remove the battery **(3)** from the computer.

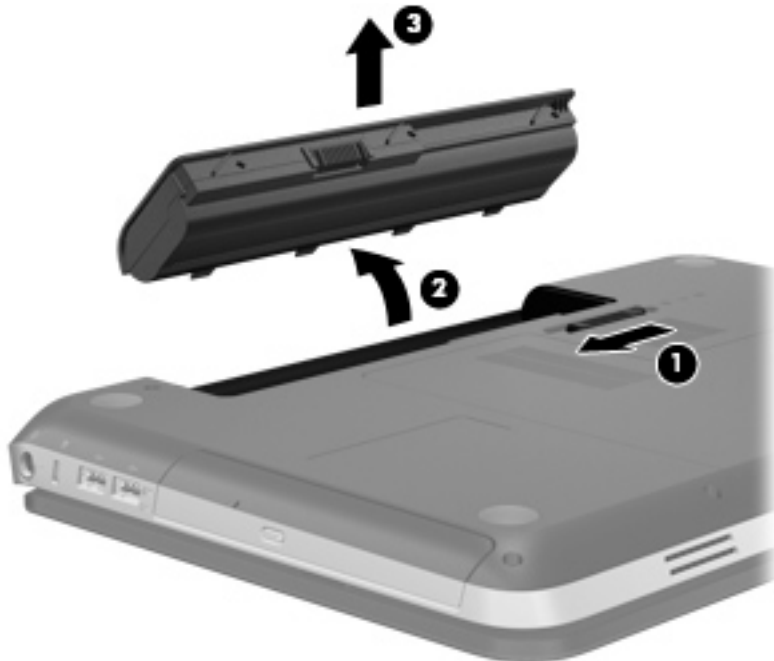

To insert the battery:

1. Align the tabs on the rear edge of the battery with the notches on the rear edge of the battery bay.
2. Pivot the front edge of the battery down into the battery bay until it is seated. (The battery release latch will automatically lock into place.)

Optical drive



NOTE: The optical drive spare part kit includes a bezel and bracket.

Description	Spare part number
Blu-ray Disc ROM FX SuperMulti DVD±R/RW Double-Layer Drive	665329-001
Blu-ray Disc R/RW FX SuperMulti Drive	665328-001
DVD±RW Double-Layer FX SuperMulti Drive	665327-001

Before removing the optical drive, follow these steps:

1. Shut down the computer. If you are unsure whether the computer is off or in Hibernation, turn the computer on, and then shut it down through the operating system.
2. Disconnect all external devices connected to the computer.
3. Disconnect the power from the computer by first unplugging the power cord from the AC outlet and then unplugging the AC adapter from the computer.
4. Remove the battery (see [Battery on page 51](#)).

Remove the optical drive:

1. Slide the service cover release latch to release the service cover.



2. Lift the rear edge of the service cover up and forward until it rests at an angle.



3. Remove the service cover. The service cover is available in the Plastics Kit, spare part number 665332-001.
4. Remove the Phillips PM2.5×4.0 screw that secures the optical drive to the computer.

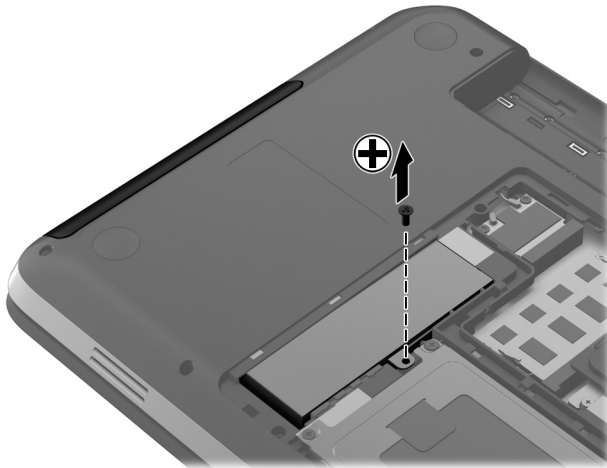

5. Remove the optical drive by sliding it out of the optical drive bay.

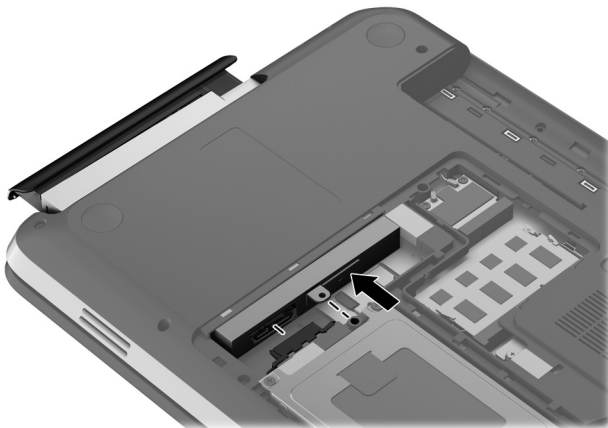

6. If it is necessary to replace the optical drive bracket, position the optical drive with the rear panel toward you.

7. Remove the two Phillips PM2.0×4.0 screws **(1)** that secure the bracket to the optical drive.
8. Remove the optical drive bracket **(2)**.

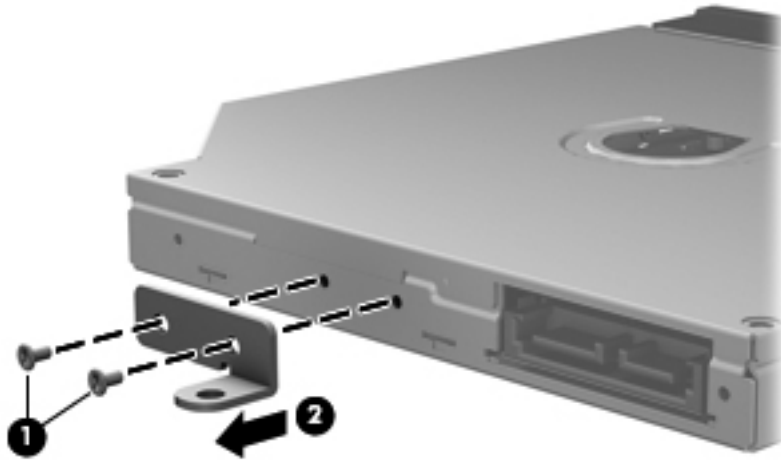

Reverse this procedure to reassemble and install the optical drive.

Hard drive

 **NOTE:** The hard drive and solid-state drive spare part kit does not include the bracket, connector cable, or screws. The bracket and screws are included in the Hard Drive Hardware Kit, spare part number 665311-001. The connector cable is included in the Cable Kit, spare part number 665301-001.

Description	Spare part number
1-TB, 5400-rpm, 12.7 mm	638974-001
750-GB, 7200-rpm, 9.5 mm	633252-001
750-GB, 5400-rpm, 9.5 mm	634250-001
640-GB, 5400-rpm, 9.5 mm	603785-001
500-GB, 7200-rpm, 9.5 mm	608218-001
500-GB, 7200-rpm, 9.5 mm	634932-001
320-GB, 7200-rpm, 7.0 mm	634862-001
320-GB, 5400-rpm, 7.0 mm	645193-001
160-GB solid-state drive	666441-001

Before removing the hard drive, follow these steps:

1. Shut down the computer. If you are unsure whether the computer is off or in Hibernation, turn the computer on, and then shut it down through the operating system.
2. Disconnect all external devices connected to the computer.

3. Disconnect the power from the computer by first unplugging the power cord from the AC outlet and then unplugging the AC adapter from the computer.
4. Remove the battery (see [Battery on page 51](#)).
5. Remove the service cover (see [Optical drive on page 52](#)).

Remove the hard drive:

1. Disconnect the hard drive connector cable **(1)** from the system board.
2. Remove the four Phillips PM2.5×4.0 screws **(2)** that secure the hard drive to the computer.
3. Use the Mylar tab built into the hard drive bracket to lift and remove the hard drive **(3)** from the computer.

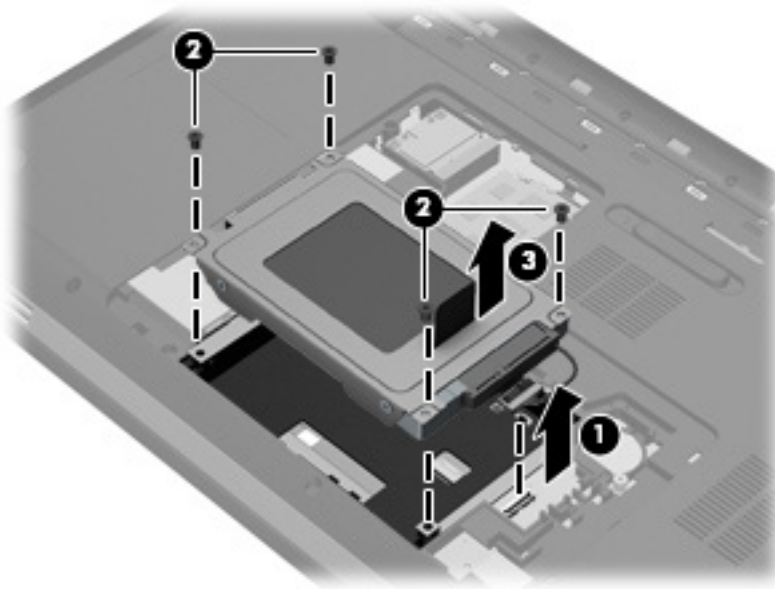

4. If it is necessary to replace the hard drive connector cable or hard drive bracket:
 - a. Remove the four Phillips PM3.0×4.0 screws **(1)** that secure the hard drive bracket to the hard drive.
 - b. Remove the hard drive bracket **(2)** from the hard drive.

- c. Disconnect the hard drive connector cable **(3)** from the hard drive.

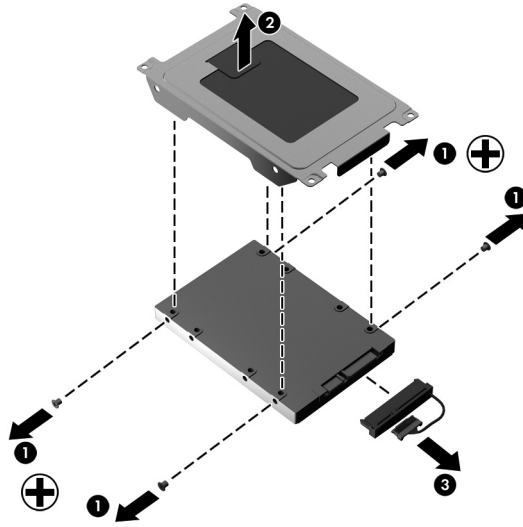

Reverse this procedure to reassemble and install the hard drive.

RTC battery

Description	Spare part number
RTC battery	651038-001

Before removing the RTC battery, follow these steps:

1. Shut down the computer. If you are unsure whether the computer is off or in Hibernation, turn the computer on, and then shut it down through the operating system.
2. Disconnect all external devices connected to the computer.
3. Disconnect the power from the computer by first unplugging the power cord from the AC outlet and then unplugging the AC adapter from the computer.
4. Remove the battery (see [Battery on page 51](#)).
5. Remove the service cover (see [Optical drive on page 52](#)).

Remove the RTC battery:

- ▲ Remove the RTC battery from the socket on the system board.

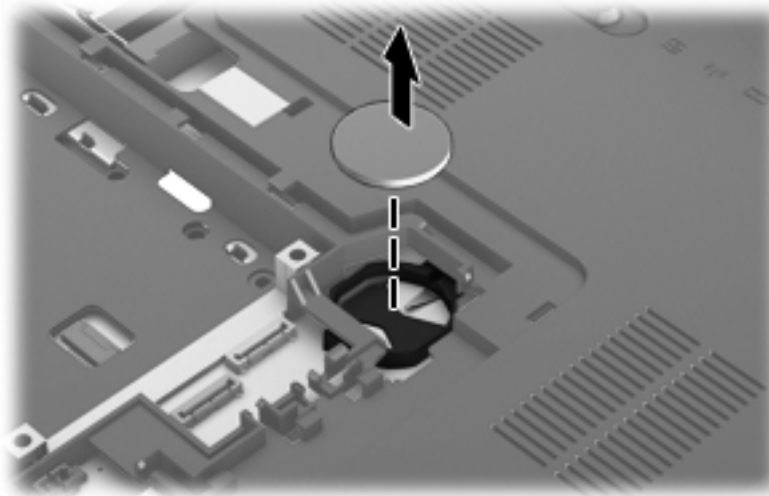

Reverse this procedure to install the RTC battery.

Memory module

Description	Spare part number
8-GB (DDR3, 10600, 1333-MHz)	634091-001
4-GB (DDR3, 10600, 1333-MHz)	621569-001
2-GB (DDR3, 10600, 1333-MHz)	621565-001

Before removing a memory module, follow these steps:

1. Shut down the computer. If you are unsure whether the computer is off or in Hibernation, turn the computer on, and then shut it down through the operating system.
2. Disconnect all external devices connected to the computer.
3. Disconnect the power from the computer by first unplugging the power cord from the AC outlet and then unplugging the AC adapter from the computer.
4. Remove the battery (see [Battery on page 51](#)).
5. Remove the service cover (see [Optical drive on page 52](#)).

Remove the memory module:

1. Spread the retaining tabs **(1)** on each side of the memory module slot to release the memory module. (The memory module tilts up.)
2. Remove the memory module **(2)** by pulling it away from the slot at an angle.

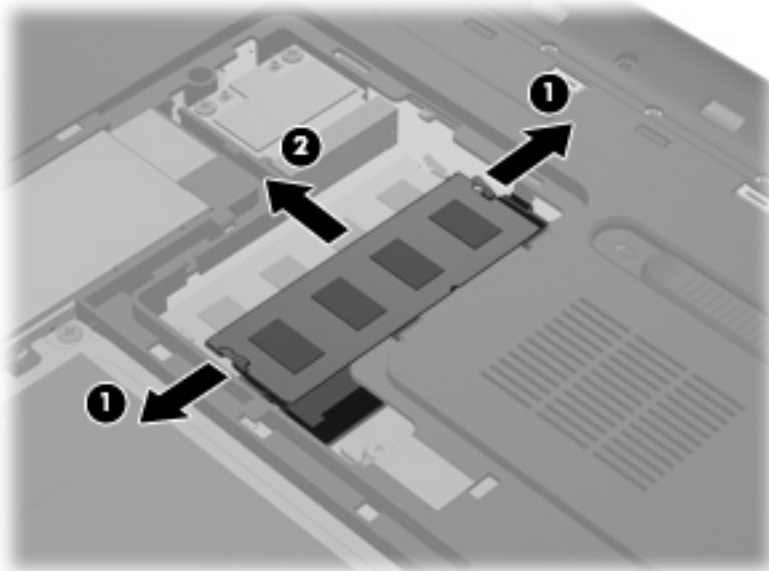

Reverse this procedure to install a memory module.

WLAN module

Description	Spare part number
For use on all computer models:	
Atheros 9485GN 802.11b/g/n 1×1 WiFi and 3012 Bluetooth 4.0 Combo Adapter	655795-001
Broadcom 4313 802.11b/g/n 1×1 WiFi and 2070 Bluetooth 2.1+EDR Combo Adapter (Bluetooth 3.0+HS ready)	600370-001
Broadcom 4313GN 802.11b/g/n 1×1 WiFi and 20702 Bluetooth 4.0 Combo Adapter	657325-001
Ralink 5390GN 802.11b/g/n 1×1 WiFi Adapter	630703-001
Realtek RTL8191SE 802.11b/g/n 1×1 WiFi Adapter	640926-001
For use only with computer models equipped with an AMD processor:	
Atheros AR8002WB-1NGB 802.11b/g/n 1×1 WiFi and Bluetooth 2.1+EDR Combo Adapter (BT3.0+HS ready)	593127-001
For use only with computer models equipped with an Intel processor:	
Broadcom 4313 802.11b/g/n 1×1 WiFi Adapter	593836-001
Intel Centrino Advanced-N 6230 WLAN module	631956-001
Intel Centrino Wireless-N 1000 WLAN module	593530-001
Intel Centrino Wireless-N + WiMAX 6150 WLAN module	633817-001
Ralink RT3090BC4 802.11b/g/n 1×1 WiFi and Bluetooth 2.1+EDR Combo Adapter (Bluetooth 3.0+HS ready)	630705-001

⚠ CAUTION: To prevent an unresponsive system, replace the wireless module only with a wireless module authorized for use in the computer by the governmental agency that regulates wireless devices in your country or region. If you replace the module and then receive a warning message, remove the module to restore device functionality, and then contact technical support.

Before removing the WLAN module, follow these steps:

1. Shut down the computer. If you are unsure whether the computer is off or in Hibernation, turn the computer on, and then shut it down through the operating system.
2. Disconnect all external devices connected to the computer.
3. Disconnect the power from the computer by first unplugging the power cord from the AC outlet and then unplugging the AC adapter from the computer.
4. Remove the battery (see [Battery on page 51](#)).
5. Remove the service cover (see [Optical drive on page 52](#)).

Remove the WLAN module:

1. Disconnect the WLAN antenna cables from the terminals on the WLAN module.

 **NOTE:** The #1/black WLAN antenna cable is connected to the WLAN module Main terminal. The #2/gray WLAN antenna cable is connected to the WLAN module Aux terminal.

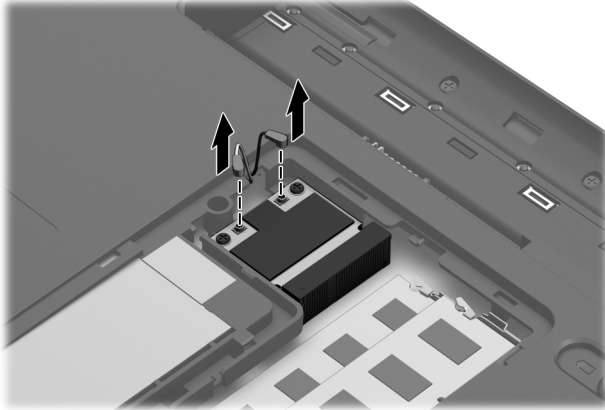

2. Remove the two Phillips PM2.0×4.0 screws that secure the WLAN module to the system board. (The WLAN module tilts up.)

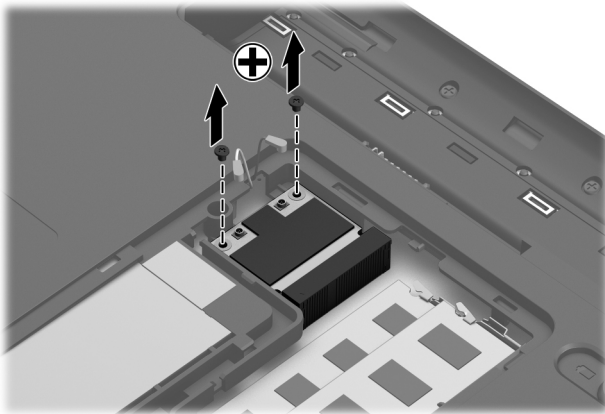

3. Remove the WLAN module by pulling the module away from the slot at an angle.

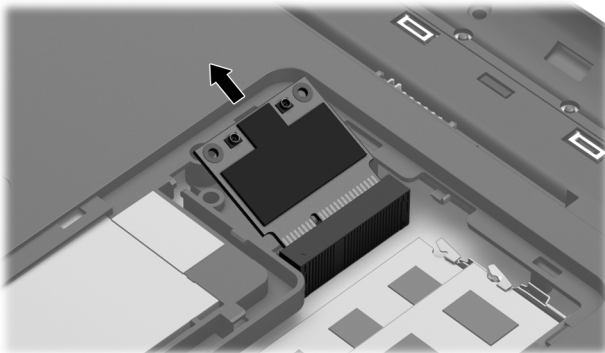

 **NOTE:** If the WLAN antennas are not connected to the terminals on the WLAN module, the protective sleeves must be installed on the antenna connectors, as shown in the following illustration.

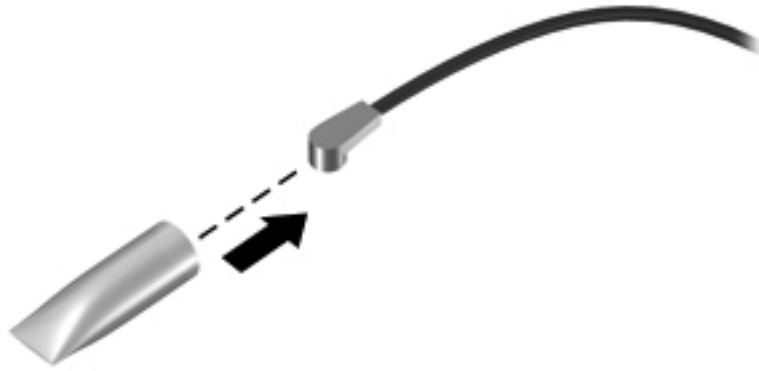

Reverse this procedure to install the WLAN module.

Keyboard



NOTE: The keyboard spare part kit includes a keyboard cable.

Description	Spare part number	Description	Spare part number
Keyboard in black finish:			
For use with all computer models in Belgium	665326-A41	For use with all computer models in Latin America	665326-161
For use with all computer models in Brazil	665326-201	For use with all computer models in the Netherlands	665326-B31
For use only with computer models equipped with an AMD processor in Bulgaria	665326-261	For use with all computer models in Portugal	665326-131
For use with all computer models in Canada	665326-121	For use with all computer models in Russia	665326-251
For use with all computer models in the Czech Republic and Slovakia	665326-FL1	For use with all computer models in Saudi Arabia	665326-171
For use with all computer models in Denmark, Finland, and Norway	665326-DH1	For use with all computer models in Slovenia	665326-BA1
For use with all computer models in France	665326-051	For use only with computer models equipped with an Intel processor in South Korea	665326-AD1
For use with all computer models in Germany	665326-041	For use with all computer models in Spain	665326-071
For use with all computer models in Greece	665326-DJ1	For use with all computer models in Switzerland	665326-BG1
For use with all computer models in Hungary	665326-211	For use only with computer models equipped with an Intel processor in Taiwan	665326-AB1
For use only with computer models equipped with an Intel processor in India	665326-D61	For use only with computer models equipped with an Intel processor in Thailand	665326-281
For use only with computer models equipped with an Intel processor in Israel	665326-BB1	For use with all computer models in Turkey	665326-141
For use with all computer models Italy	665326-061	For use with all computer models in the United Kingdom and Singapore	665326-031
For use with all computer models in Japan	665326-291	For use with all computer models in the United States	665326-001
Keyboard in silver finish:			
For use with all computer models in Belgium	666423-A41	For use with all computer models in Latin America	666423-161

Description	Spare part number	Description	Spare part number
For use with all computer models in Brazil	666423-201	For use with all computer models in the Netherlands	666423-B31
For use only with computer models equipped with an AMD processor in Bulgaria	666423-261	For use with all computer models in Portugal	666423-131
For use with all computer models in Canada	666423-121	For use with all computer models in Russia	666423-251
For use with all computer models in the Czech Republic and Slovakia	666423-FL1	For use with all computer models in Saudi Arabia	666423-171
For use with all computer models in Denmark, Finland, and Norway	666423-DH1	For use with all computer models in Slovenia	666423-BA1
For use with all computer models in France	666423-051	For use only with computer models equipped with an Intel processor in South Korea	666423-AD1
For use with all computer models in Germany	666423-041	For use with all computer models in Spain	666423-071
For use with all computer models in Greece	666423-DJ1	For use with all computer models in Switzerland	666423-BG1
For use with all computer models in Hungary	666423-211	For use only with computer models equipped with an Intel processor in Taiwan	666423-AB1
For use only with computer models equipped with an Intel processor in India	666423-D61	For use only with computer models equipped with an Intel processor in Thailand	666423-281
For use only with computer models equipped with an Intel processor in Israel	666423-BB1	For use with all computer models in Turkey	666423-141
For use with all computer models Italy	666423-061	For use with all computer models in the United Kingdom and Singapore	666423-031
For use with all computer models in Japan	666423-291	For use with all computer models in the United States	666423-001

Before removing the keyboard, follow these steps:

1. Shut down the computer. If you are unsure whether the computer is off or in Hibernation, turn the computer on, and then shut it down through the operating system.
2. Disconnect all external devices connected to the computer.
3. Disconnect the power from the computer by first unplugging the power cord from the AC outlet and then unplugging the AC adapter from the computer.
4. Remove the battery (see [Battery on page 51](#)).
5. Remove the service cover (see [Optical drive on page 52](#)).

Remove the keyboard:

1. Remove the Phillips PM2.5×4.0 screw that secures the keyboard to the computer.

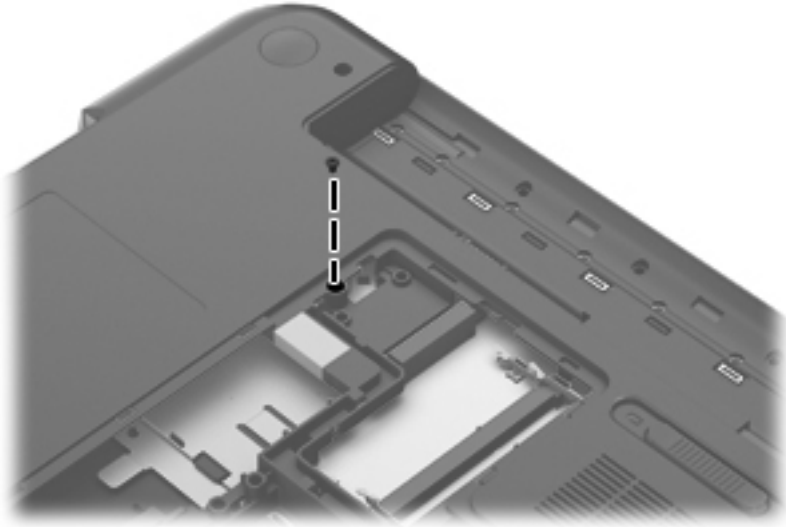

2. Rest the computer on its left side.
3. Open the computer.
4. Insert a screw driver or similar thin tool into the keyboard screw hole, and then press on the back of the keyboard until the keyboard disengages from the computer.

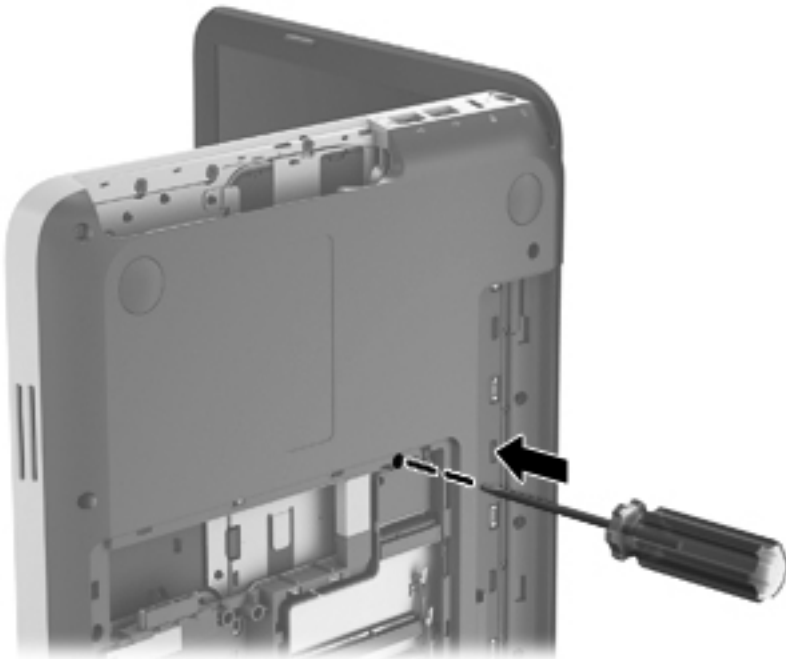

5. Turn the computer right-side up with the front toward you.

6. Lift the rear edge **(1)** of the keyboard, and then slide the keyboard **(2)** back until the keyboard cable is accessible.



7. Release the zero insertion force (ZIF) connector **(1)** to which the keyboard cable is attached, and then disconnect the keyboard cable **(2)** from the system board.

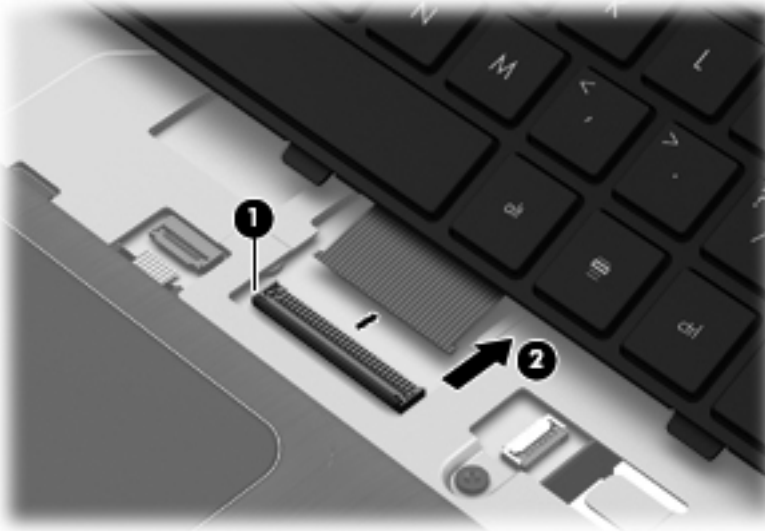

8. Remove the keyboard.

Reverse this procedure to install the keyboard.

Top cover

 **NOTE:** The top cover spare part kit includes the TouchPad and TouchPad button board, but does not include the TouchPad cable or TouchPad button board cable. The TouchPad cable and TouchPad button board cable are included in the Cable Kit, spare part number 665301-001.

Description	Spare part number
In butter gold finish	665364-001
In dark umber finish	665356-001
In espresso black finish	665358-001
In linen white finish	665359-001
In Pacific blue finish	665360-001
In pearl pink finish	665363-001
In ruby red finish	665362-001
In Sonoma red finish	665361-001
In steel gray finish	665357-001

Before removing the top cover, follow these steps:

1. Shut down the computer. If you are unsure whether the computer is off or in Hibernation, turn the computer on, and then shut it down through the operating system.
2. Disconnect all external devices connected to the computer.
3. Disconnect the power from the computer by first unplugging the power cord from the AC outlet and then unplugging the AC adapter from the computer.
4. Remove the battery (see [Battery on page 51](#)), and then remove the following components:
 - Optical drive (see [Optical drive on page 52](#))
 - Hard drive (see [Hard drive on page 54](#))
 - Keyboard (see [Keyboard on page 62](#))

 **NOTE:** When replacing the top cover, be sure that the power button board and cable (see [Power button board on page 69](#)) and fingerprint reader board and cable (see [Fingerprint reader board on page 70](#)) are removed from the defective top cover and installed on the replacement top cover.

Remove the top cover:

1. Close the computer.
2. Turn the computer upside down, with the front toward you.

3. Remove the seven Phillips PM2.5×10.0 screws that secure the top cover to the computer.

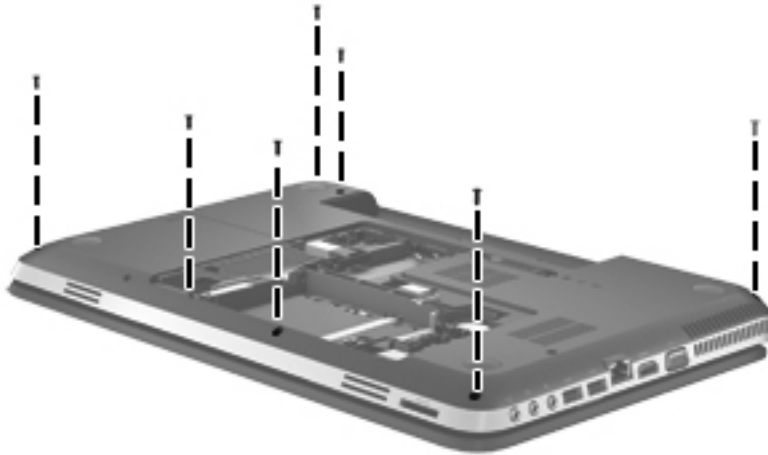

4. Remove the following screws that secure the top cover to the computer:
 - Three Phillips PM2.0×3.0 screws **(1)** in the optical drive bay
 - Three Phillips PM2.5×6.0 screws **(2)**
 - One Phillips PM2.0×4.0 screw **(3)** in the hard drive bay

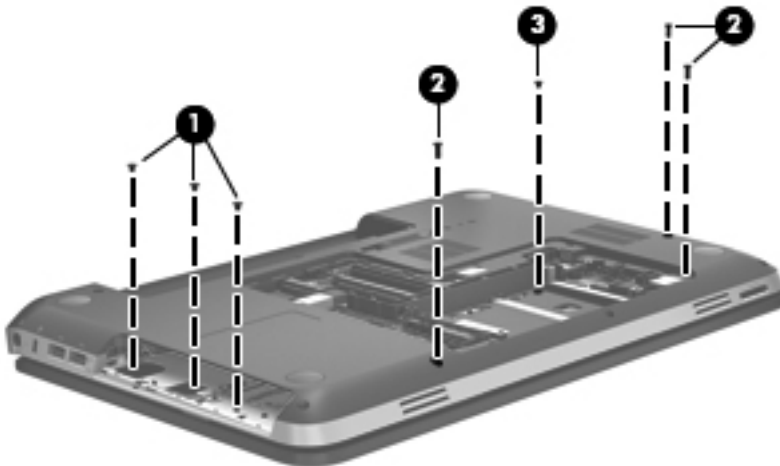

5. Turn the computer right-side up, with the front toward you.
6. Open the computer.

7. Release the ZIF connectors to which the following cables are attached, and then disconnect the cables from the system board:

 **NOTE:** The power button board cable, TouchPad button board cable, and fingerprint reader board cable are included in the Cable Kit, spare part number 665301-001.

- Power button board cable **(1)**
- TouchPad button board cable **(2)**
- Fingerprint reader board cable **(3)** (select models only)

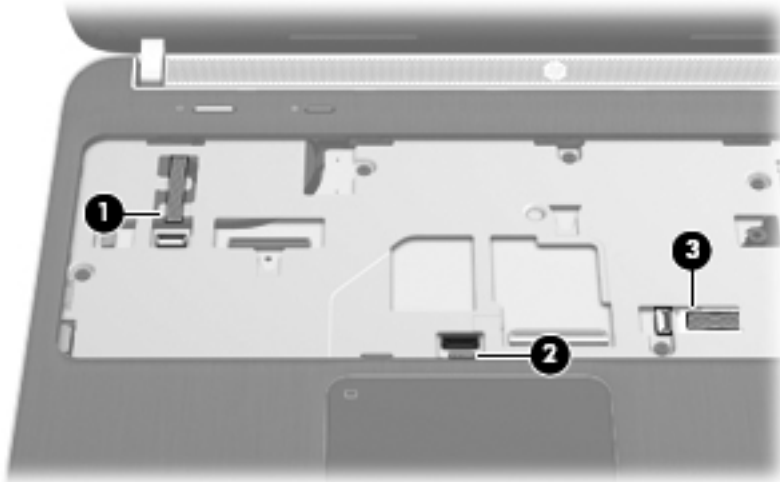

8. Remove the seven Phillips PM2.5×6.0 screws that secure the top cover to the computer.

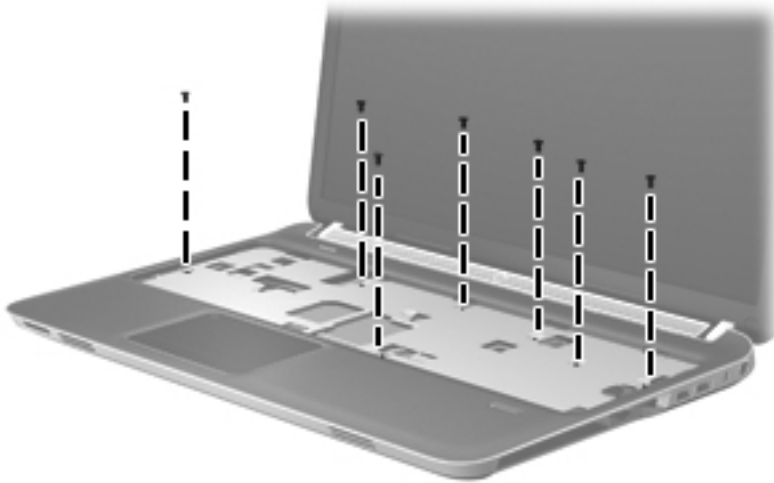

9. Lift the rear edge of the top cover **(1)** until the left and right sides disengage from the base enclosure.

10. Remove the top cover **(2)**.

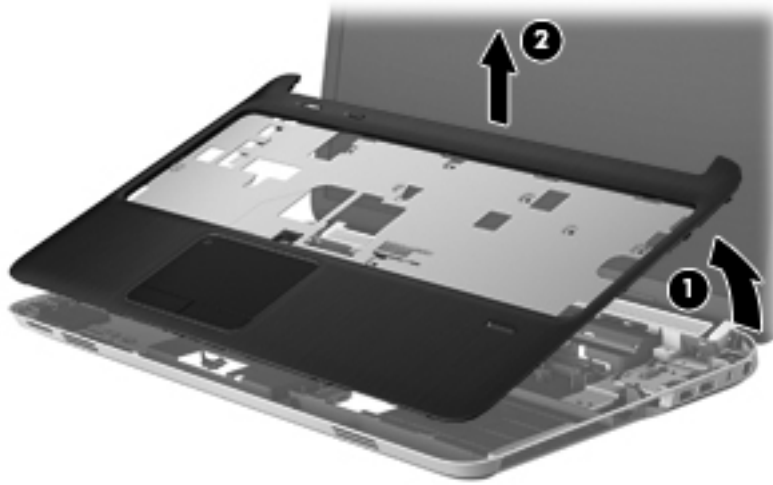

Reverse this procedure to install the top cover.

Power button board

Description	Spare part number
Power button board (does not include cable)	665330-001
NOTE: The power button board cable is not included in the power button board spare part kit. The power button board cable is included in the Cable Kit, spare part number 665301-001.	

Before removing the power button board, follow these steps:

1. Shut down the computer. If you are unsure whether the computer is off or in Hibernation, turn the computer on, and then shut it down through the operating system.
2. Disconnect all external devices connected to the computer.
3. Disconnect the power from the computer by first unplugging the power cord from the AC outlet and then unplugging the AC adapter from the computer.
4. Remove the battery (see [Battery on page 51](#)), and then remove the following components:
 - Optical drive (see [Optical drive on page 52](#))
 - Hard drive (see [Hard drive on page 54](#))
 - Keyboard (see [Keyboard on page 62](#))
 - Top cover (see [Top cover on page 66](#))

Remove the power button board:

1. Turn the top cover upside down, with the front toward you.
2. Release the power button board cable from the clip **(1)** built into the top cover.

3. Remove the three Phillips PM2.0×4.0 screws (2) that secure the power button board to the top cover.
4. Remove the power button board and cable (3).

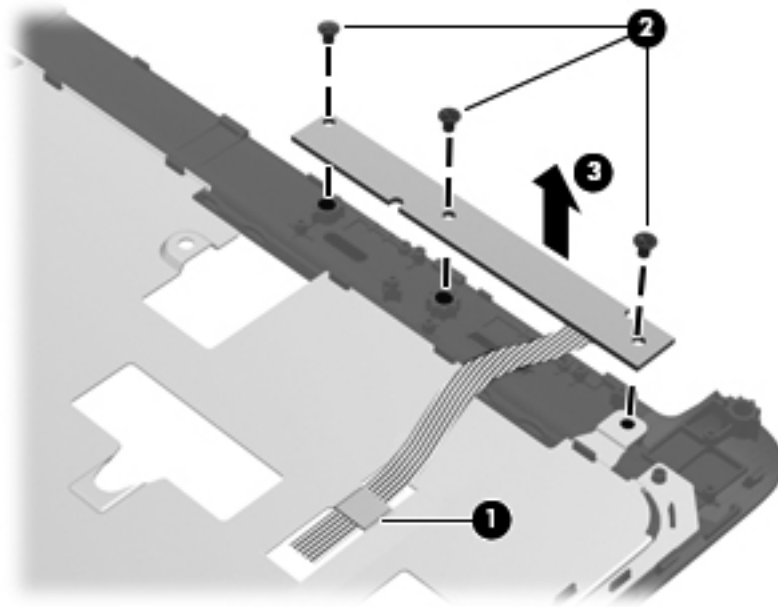

Reverse this procedure to install the power button board and cable.

Fingerprint reader board

Description	Spare part number
Fingerprint reader board (select models only, includes bracket, but does not include cable)	665330-001

NOTE: The fingerprint reader board cable is not included in the fingerprint reader board spare part kit. The fingerprint reader board cable is included in the Cable Kit, spare part number 665301-001.

Before removing the fingerprint reader board, follow these steps:

1. Shut down the computer. If you are unsure whether the computer is off or in Hibernation, turn the computer on, and then shut it down through the operating system.
2. Disconnect all external devices connected to the computer.
3. Disconnect the power from the computer by first unplugging the power cord from the AC outlet and then unplugging the AC adapter from the computer.
4. Remove the battery (see [Battery on page 51](#)), and then remove the following components:
 - Optical drive (see [Optical drive on page 52](#))
 - Hard drive (see [Hard drive on page 54](#))

- Keyboard (see [Keyboard on page 62](#))
- Top cover (see [Top cover on page 66](#))

Remove the fingerprint reader board and cable:

1. Turn the top cover upside down, with the front toward you.
2. Release the fingerprint reader board cable **(1)** from the clips **(2)** built into the top cover.
3. Remove the two Phillips PM2.0x4.0 screws **(3)** that secure the fingerprint reader board and bracket to the top cover.
4. Remove the fingerprint reader board bracket **(4)** and the fingerprint reader board **(5)**.

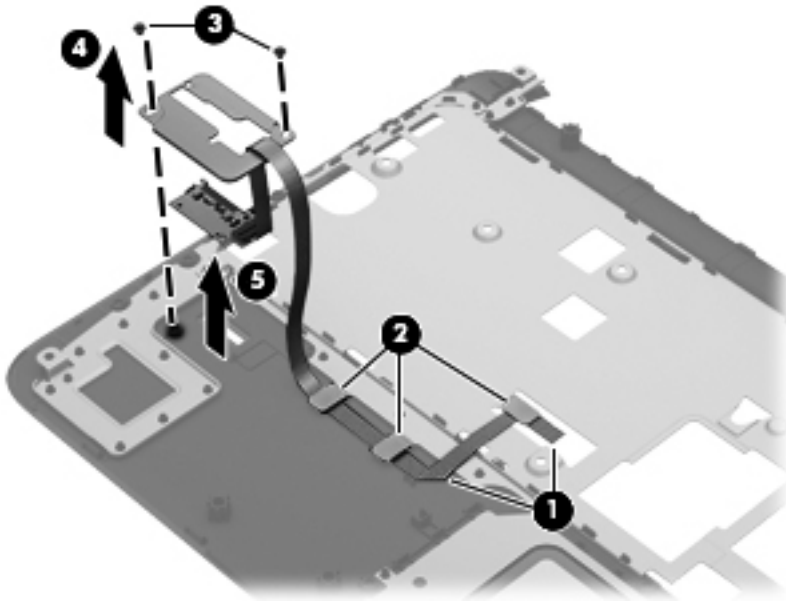

Reverse this procedure to install the fingerprint reader board and cable.

Bluetooth module



NOTE: This section applies only to computer models equipped with an Intel processor.

Description	Spare part number
EDR v.4.0 Bluetooth module	655792-001

NOTE: The Bluetooth module spare part kit does not include the Bluetooth module cable. The Bluetooth module cable is available using spare part number 665303-001.

Before removing the Bluetooth module and cable, follow these steps:

1. Shut down the computer. If you are unsure whether the computer is off or in Hibernation, turn the computer on, and then shut it down through the operating system.
2. Disconnect all external devices connected to the computer.
3. Disconnect the power from the computer by first unplugging the power cord from the AC outlet and then unplugging the AC adapter from the computer.
4. Remove the battery (see [Battery on page 51](#)), and then remove the following components:
 - Optical drive (see [Optical drive on page 52](#))
 - Hard drive (see [Hard drive on page 54](#))
 - Keyboard (see [Keyboard on page 62](#))
 - Top cover (see [Top cover on page 66](#))

Remove the Bluetooth module and cable:

1. Disconnect the Bluetooth module cable **(1)** from the system board.
2. Release the Bluetooth module cable from the clips **(2)** and the routing channel built into the front speaker assembly.

3. Release the Bluetooth module **(3)** from the clip built into the front speaker assembly.

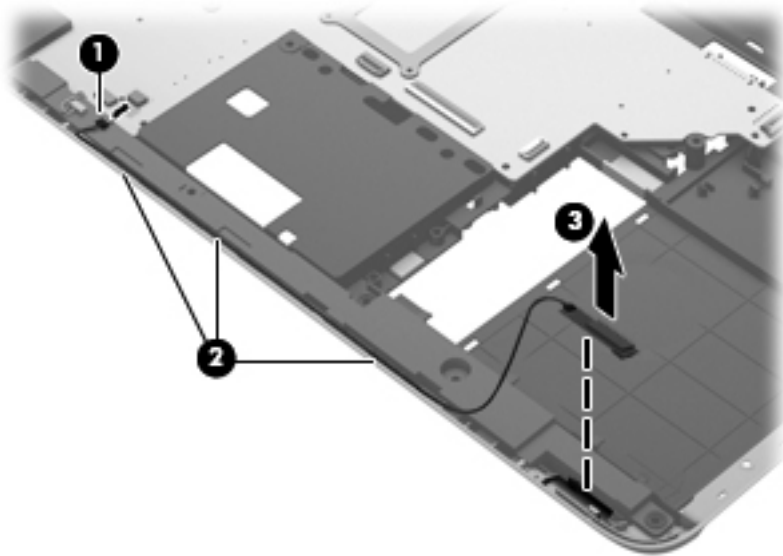

4. Remove the Bluetooth module and the Bluetooth module cable.
5. If it is necessary to replace the Bluetooth module cable, disconnect the cable from the Bluetooth module and replace it.

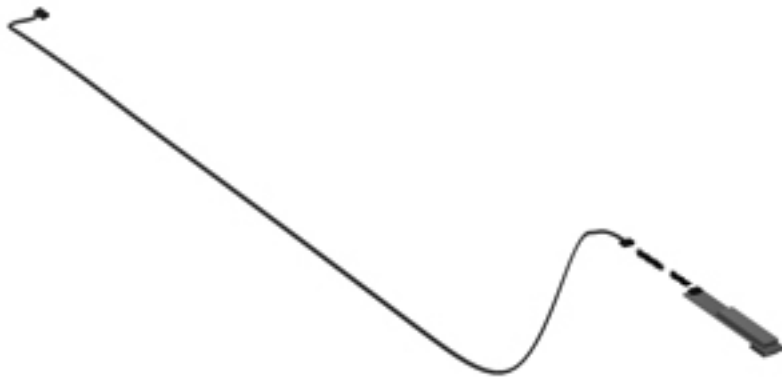

Reverse this procedure to install the Bluetooth module and cable.

USB board

Description	Spare part number
USB board (does not include cable)	665331-001
NOTE: The USB board cable is not included in the USB board spare part kit. The USB board cable is included in the Cable Kit, spare part number 665303-001.	

Before removing the USB board, follow these steps:

1. Shut down the computer. If you are unsure whether the computer is off or in Hibernation, turn the computer on, and then shut it down through the operating system.
2. Disconnect all external devices connected to the computer.
3. Disconnect the power from the computer by first unplugging the power cord from the AC outlet and then unplugging the AC adapter from the computer.
4. Remove the battery (see [Battery on page 51](#)), and then remove the following components:
 - Optical drive (see [Optical drive on page 52](#))
 - Hard drive (see [Hard drive on page 54](#))
 - Keyboard (see [Keyboard on page 62](#))
 - Top cover (see [Top cover on page 66](#))

Remove the USB board and cable:

1. Release the ZIF connector to which the USB board cable is connected, and then disconnect the USB board cable **(1)** from the system board.
2. Remove the Phillips PM2.5×5.0 screw **(2)** that secures the USB board to the base enclosure.
3. Remove the USB board **(3)** and cable.

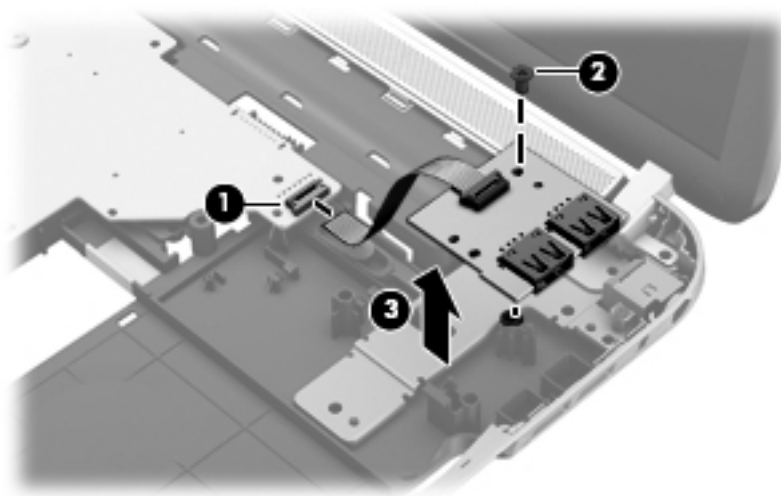

Reverse this procedure to install the USB board.

Power connector cable

Description	Spare part number
Power connector cable	665306-001

Before removing the power connector cable, follow these steps:

1. Shut down the computer. If you are unsure whether the computer is off or in Hibernation, turn the computer on, and then shut it down through the operating system.
2. Disconnect all external devices connected to the computer.
3. Disconnect the power from the computer by first unplugging the power cord from the AC outlet and then unplugging the AC adapter from the computer.
4. Remove the battery (see [Battery on page 51](#)), and then remove the following components:
 - Optical drive (see [Optical drive on page 52](#))
 - Hard drive (see [Hard drive on page 54](#))
 - Keyboard (see [Keyboard on page 62](#))
 - Top cover (see [Top cover on page 66](#))
 - USB board (see [USB board on page 74](#))

Remove the power connector cable:

1. Disconnect the power connector cable **(1)** from the system board.
2. Release the power connector cable from the clips **(2)** built into the base enclosure.
3. Remove the two Phillips PM2.0×2.0 screws **(3)** that secure the power connector to the base enclosure.

4. Remove the power connector **(4)** from the base enclosure.

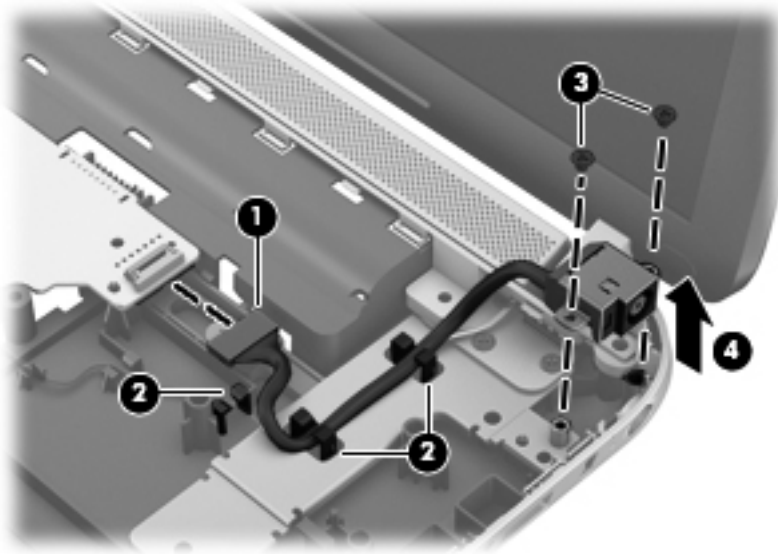

Reverse this procedure to install the power connector cable.

System board



NOTE: The system board spare part kit includes replacement thermal material.

Replacement thermal material is also available in the Thermal Material Kit, using the following spare part numbers:

- 665286-001 — For use only with computer models equipped with an AMD processor and a graphics subsystem with discrete memory
- 665285-001 — For use only with computer models equipped with an AMD processor and a graphics subsystem with UMA memory
- 665354-001 — For use only with computer models equipped with an Intel processor and a graphics subsystem with 2048-MB discrete memory
- 665355-001 — For use only with computer models equipped with an Intel processor and a graphics subsystem with 1024-MB discrete memory
- 665353-001 — For use only with computer models equipped with an Intel processor and a graphics subsystem with UMA memory

Description	Spare part number
For use only with computer models equipped with an AMD A70M processor, the HD6750 graphics subsystem with 1024-MB of discrete memory, and USB version 3.0	665284-001
For use only with computer models equipped with an AMD A70M processor, a graphics subsystem with UMA memory, and USB version 3.0	665282-001
For use only with computer models equipped with an AMD A60M processor, the HD6750 graphics subsystem with 1024-MB of discrete memory, and USB version 2.0	665281-001
For use only with computer models equipped with an AMD A60M processor, the HD6490 graphics subsystem with 512-MB of discrete memory, and USB version 2.0	665280-001
For use only with computer models equipped with an AMD A60M processor, a graphics subsystem with UMA memory, and USB version 2.0	665279-001
For use only with computer models equipped with an Intel quad core processor, the HD6770 graphics subsystem with 2048-MB of discrete memory, and USB version 3.0	665342-001
For use only with computer models equipped with an Intel dual core processor, the HD6770 graphics subsystem with 2048-MB of discrete memory, and USB version 3.0	665341-001
For use only with computer models equipped with an Intel quad core processor, the HD6770 graphics subsystem with 1024-MB of discrete memory, and USB version 3.0	665344-001
For use only with computer models equipped with an Intel dual core processor, the HD6770 graphics subsystem with 1024-MB of discrete memory, and USB version 3.0	665343-001
For use only with computer models equipped with an Intel quad core processor, the HD6490 graphics subsystem with 1024-MB of discrete memory, and USB version 3.0	665348-001
For use only with computer models equipped with an Intel quad core processor, the HD6490 graphics subsystem with 1024-MB of discrete memory, and USB version 2.0	665346-001
For use only with computer models equipped with an Intel dual core processor, the HD6490 graphics subsystem with 1024-MB of discrete memory, and USB version 3.0	665347-001

Description	Spare part number
For use only with computer models equipped with an Intel dual core processor, the HD6490 graphics subsystem with 1024-MB of discrete memory, and USB version 2.0	665345-001
For use only with computer models equipped with an Intel quad core processor, a graphics subsystem with UMA memory, and USB version 3.0	665352-001
For use only with computer models equipped with an Intel quad core processor, a graphics subsystem with UMA memory, and USB version 2.0	665350-001
For use only with computer models equipped with an Intel dual core processor, a graphics subsystem with UMA memory, and USB version 3.0	665351-001
For use only with computer models equipped with an Intel dual core processor, a graphics subsystem with UMA memory, and USB version 2.0	665349-001

Before removing the system board, follow these steps:

1. Shut down the computer. If you are unsure whether the computer is off or in Hibernation, turn the computer on, and then shut it down through the operating system.
2. Disconnect all external devices connected to the computer.
3. Disconnect the power from the computer by first unplugging the power cord from the AC outlet and then unplugging the AC adapter from the computer.
4. Remove the battery (see [Battery on page 51](#)), and then remove the following components:
 - Optical drive (see [Optical drive on page 52](#))
 - Hard drive (see [Hard drive on page 54](#))
 - WLAN module (see [WLAN module on page 59](#))
 - Keyboard (see [Keyboard on page 62](#))
 - Top cover (see [Top cover on page 66](#))

When replacing the system board, be sure that the following components are removed from the defective system board and installed on the replacement system board:

- RTC battery (see [RTC battery on page 57](#))
- Memory module (see [Memory module on page 58](#))
- Fan and heat sink (see [Fan/heat sink assembly on page 81](#))
- Processor (see [Processor on page 85](#))

Remove the system board:

1. Close the computer.
2. Turn the computer upside down, with the front toward you.

3. Disconnect the speaker cable **(1)** and the optical drive connector cable **(2)** from the system board.

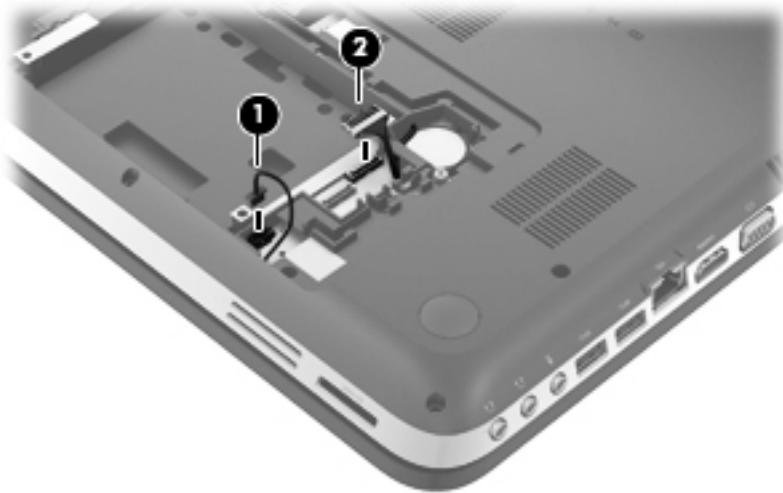

4. Turn the computer right side up, with the front toward you.
5. Open the computer.
6. Disconnect the following cables from the system board:

- Display panel cable **(1)**
- Webcamera/microphone cable **(2)**
- Bluetooth module cable **(3)**
- USB board cable **(4)**
- Power connector cable **(5)**

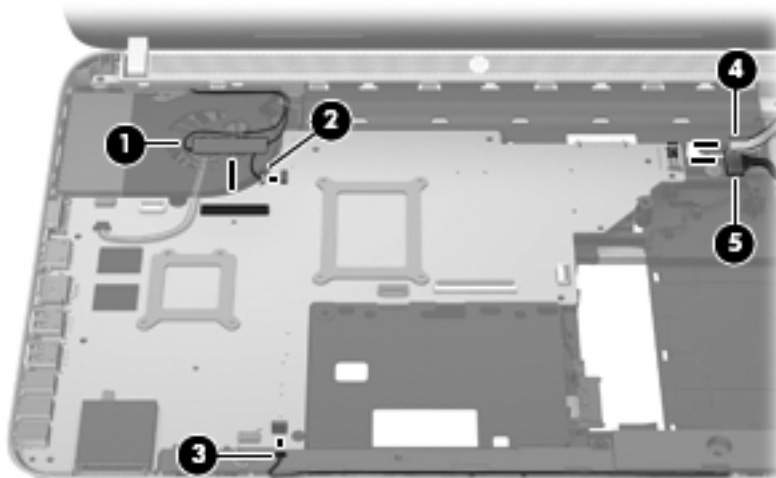

7. Remove the Phillips PM2.5×4.0 screw **(1)** and the two Phillips PM2.5×5.0 screws **(2)** that secure the system board to the base enclosure.

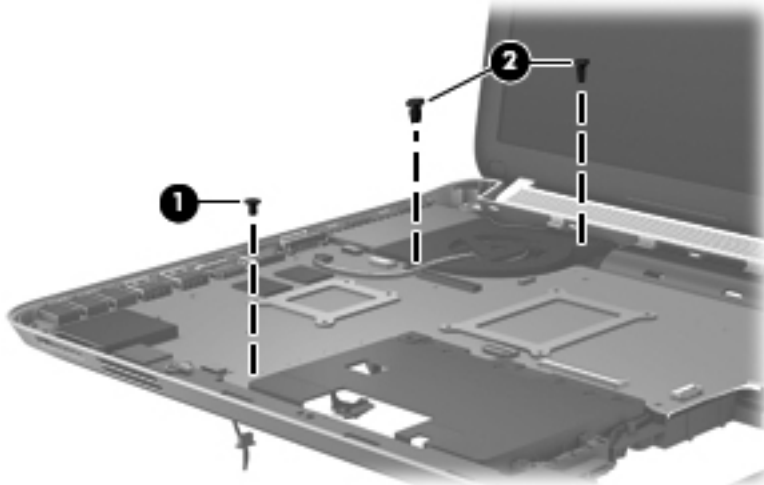

8. Flex the left side of the base enclosure **(1)** outward to provide clearance for the audio connectors **(2)** and the other connectors on the left side of the system board.
9. Lift the front edge of the system board **(3)** until it rests at an angle.
10. Remove the system board **(4)** by sliding it up and forward at an angle.

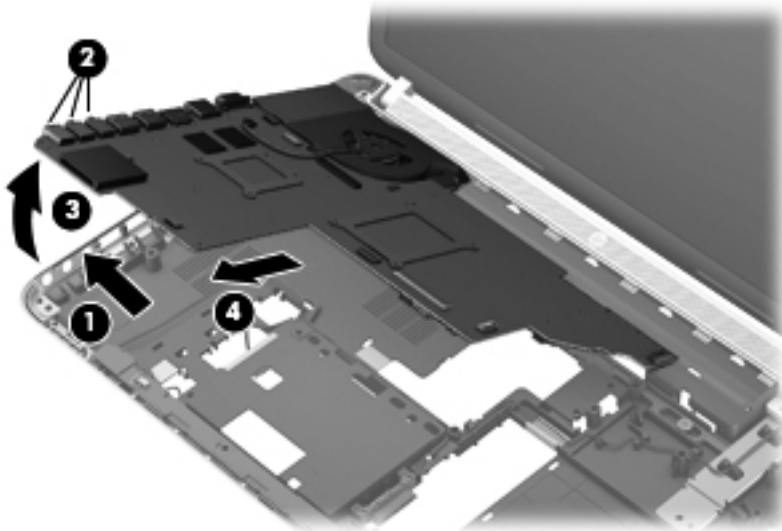

Reverse this procedure to install the system board.

Fan/heat sink assembly



NOTE: The fan/heat sink assembly spare part kit includes replacement thermal material. Replacement thermal material is also available in the Thermal Material Kit, using the following spare part numbers:

- 665286-001 — For use only with computer models equipped with an AMD processor and a graphics subsystem with discrete memory
- 665285-001 — For use only with computer models equipped with an AMD processor and a graphics subsystem with UMA memory
- 665354-001 — For use only with computer models equipped with an Intel processor and a graphics subsystem with 2048-MB discrete memory
- 665355-001 — For use only with computer models equipped with an Intel processor and a graphics subsystem with 1024-MB discrete memory
- 665353-001 — For use only with computer models equipped with an Intel processor and a graphics subsystem with UMA memory

Description	Spare part number
For use only with computer models equipped with an AMD processor and a graphics subsystem with discrete memory	665278-001
For use only with computer models equipped with an AMD processor and a graphics subsystem with UMA memory	665277-001
For use only with computer models equipped with an Intel processor and a graphics subsystem with 2048-MB discrete memory	665309-001
For use only with computer models equipped with an Intel processor and a graphics subsystem with 1024-MB discrete memory	665308-001
For use only with computer models equipped with an Intel processor and a graphics subsystem with UMA memory	665307-001



NOTE: To properly ventilate the computer, allow at least 7.6 cm (3 in) of clearance on the left side of the computer. The computer uses an electric fan for ventilation. The fan is controlled by a temperature sensor and is designed to turn on automatically when high temperature conditions exist. These conditions are affected by high external temperatures, system power consumption, power management/battery conservation configurations, battery fast charging, and software requirements. Exhaust air is displaced through the ventilation grill located on the left side of the computer.

Before removing the fan/heat sink assembly, follow these steps:

1. Shut down the computer. If you are unsure whether the computer is off or in Hibernation, turn the computer on, and then shut it down through the operating system.
2. Disconnect all external devices connected to the computer.

3. Disconnect the power from the computer by first unplugging the power cord from the AC outlet and then unplugging the AC adapter from the computer.
4. Remove the battery (see [Battery on page 51](#)), and then remove the following components:
 - Optical drive (see [Optical drive on page 52](#))
 - Hard drive (see [Hard drive on page 54](#))
 - WLAN module (see [WLAN module on page 59](#))
 - Keyboard (see [Keyboard on page 62](#))
 - Top cover (see [Top cover on page 66](#))
 - System board (see [System board on page 77](#))

Remove the fan/heat sink assembly:

1. Disconnect the fan cable from the system board.

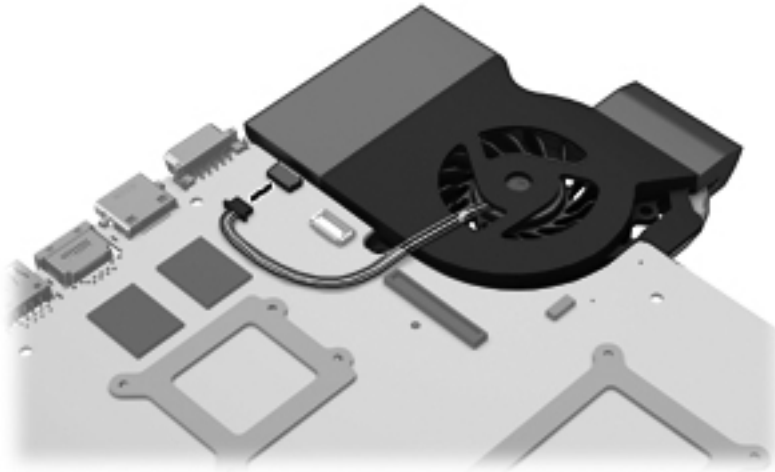

2. Turn the system board upside down, with the fan away from you.
3. Loosen the captive screws **(1)** that secure the fan/heat sink assembly to the system board.

 **NOTE:** The number of screws used to secure the fan/heat sink assembly to the system board varies by computer model.

 **NOTE:** Due to the adhesive quality of the thermal material located between the heat sink and system board components, it may be necessary to move the heat sink from side to side to detach it.

4. Remove the fan/heat sink assembly (2).

 **NOTE:** The following illustration shows the fan/heat sink assembly being removed from a computer model equipped with an AMD processor and a graphics subsystem with discrete memory. A computer model equipped with an AMD processor and a graphics subsystem with UMA memory has only four screws.

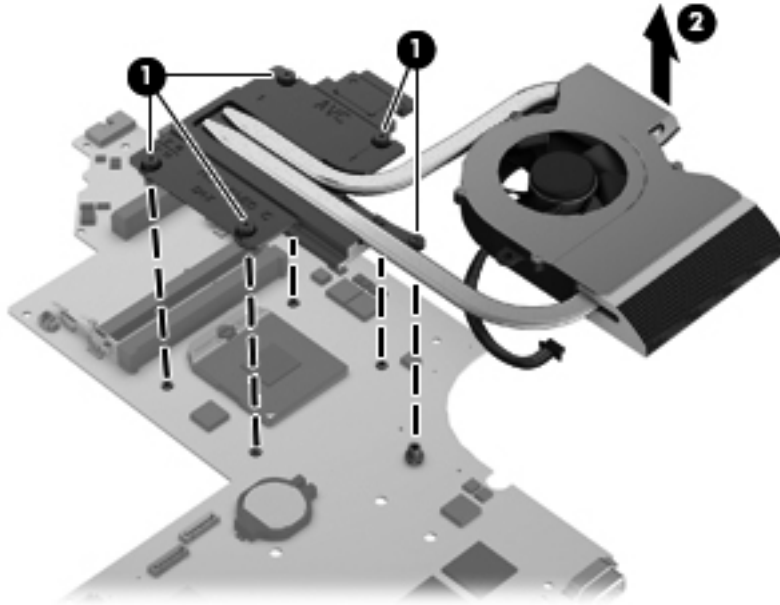

 **NOTE:** The following illustration shows the fan/heat sink assembly being removed from a computer model equipped with an Intel processor and a graphics subsystem with discrete memory. A computer model equipped with an Intel processor and a graphics subsystem with UMA memory has only four screws.

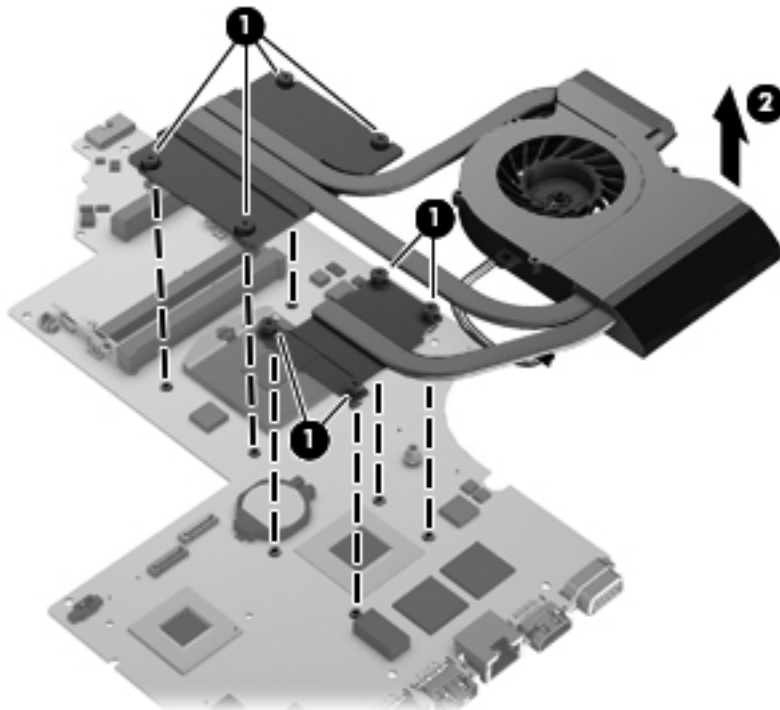

The thermal material must be thoroughly cleaned from the surfaces of the heat sink and the system board components each time the fan/heat sink assembly is removed. Replacement thermal material is included with the fan/heat sink assembly, processor, and system board spare part kits. Replacement thermal material is also available in the Thermal Material Kit.

 **NOTE:** The following illustration shows the replacement thermal material locations on a computer model equipped with an AMD processor and a graphics subsystem with discrete memory.

- Thermal paste is used on the processor **(1)** and the heat sink section **(2)** that services it
- A thermal pad is used on the graphics subsystem chip **(3)** and the heat sink section **(4)** that services it (only on computer models equipped with a graphics subsystem with discrete memory)
- A thermal pad is used on the Northbridge chip **(5)** and the heat sink section **(6)** that services it

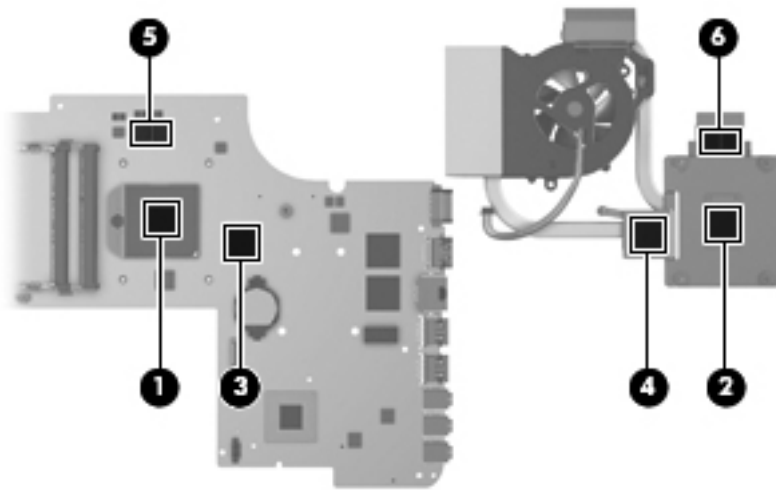

 **NOTE:** The following illustration shows the replacement thermal material locations on a computer model equipped with an Intel processor and a graphics subsystem with discrete memory.

- Thermal paste is used on the processor **(1)** and the heat sink section **(2)** that services it
- A thermal pad is used on the graphics subsystem chip **(3)** and the heat sink section **(4)** that services it (only on computer models equipped with a graphics subsystem with discrete memory)
- A thermal pad is used on the Northbridge chip **(5)** and the heat sink section **(6)** that services it

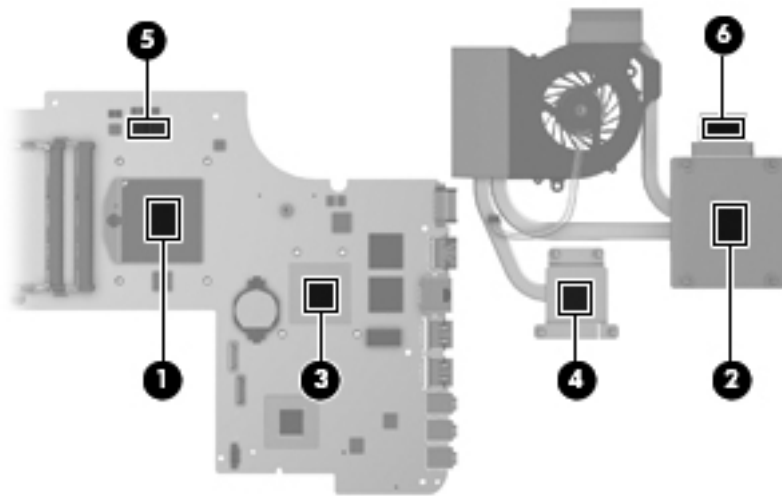

Reverse this procedure to reassemble and install the fan/heat sink assembly.

Processor

 **NOTE:** The processor spare part kit includes replacement thermal material. Replacement thermal material is also available in the Thermal Material Kit, using the following spare part numbers:

- 665286-001 — For use only with computer models equipped with an AMD processor and a graphics subsystem with discrete memory
- 665285-001 — For use only with computer models equipped with an AMD processor and a graphics subsystem with UMA memory
- 665354-001 — For use only with computer models equipped with an Intel processor and a graphics subsystem with 2048-MB discrete memory
- 665355-001 — For use only with computer models equipped with an Intel processor and a graphics subsystem with 1024-MB discrete memory
- 665353-001 — For use only with computer models equipped with an Intel processor and a graphics subsystem with UMA memory

Description	Spare part number
AMD A8-3530MX 2.60-GHz processor (1.90-GHz FSB, 4.0-MB L2 cache, quad core, 45 W)	653364-001
AMD A8-3510MX 2.50-GHz processor (1.50-GHz FSB, 4.0-MB L2 cache, quad core, 45 W)	653358-001
AMD A8-3500M 2.40-GHz processor (1.5-GHz FSB, 4.0-MB L2 cache, quad core, 35 W)	653350-001
AMD A6-3410MX 2.30-GHz processor (1.60-GHz FSB, 2.0-MB L2 cache, quad core, 45 W)	653357-001
AMD A6-3400M 2.30-GHz processor (1.4-GHz FSB, 4.0-MB L2 cache, quad core, 35 W)	653349-001
AMD A4-3310MX 2.50-GHz processor (2.10-GHz FSB, 2.0-MB L2 cache, dual core, 45 W)	653356-001
AMD A4-3300M 2.50-GHz processor (1.9-GHz FSB, 4.0-MB L2 cache, dual core, 35 W)	653348-001

Description	Spare part number
Intel Core i7-2860QM 2.50-GHz (SC turbo up to 3.60-GHz) processor (1600-MHz FSB, 8.0-MB L3 cache, dual core, 45 W)	666175-001
Intel Core i7-2820QM 2.30-GHz (SC turbo up to 3.20-GHz) processor (1600-MHz FSB, 8.0-MB L3 cache, quad core, 45 W)	634694-001
Intel Core i7-2760QM 2.40-GHz (SC turbo up to 3.50-GHz) processor (1600-MHz FSB, 6.0-MB L3 cache, dual core, 45 W)	666174-001
Intel Core i7-2720QM 2.20-GHz (SC turbo up to 3.00-GHz) processor (6.0-MB L3 cache, quad core, 45 W)	631254-001
Intel Core i7-2670QM 2.20-GHz (SC turbo up to 3.10-GHz) processor (1600-MHz FSB, 6.0-MB L3 cache, dual core, 45 W)	665116-001
Intel Core i7-2640M 2.80-GHz (SC turbo up to 3.50-GHz) processor (1333-MHz FSB, 4.0-MB L3 cache, dual core, 35 W)	666173-001
Intel Core i7-2630QM 2.00-GHz (SC turbo up to 2.90-GHz) processor (1333-MHz FSB, 6.0-MB L3 cache, quad core, 45 W)	635501-001
Intel Core i7-2620M 2.70-GHz (SC turbo up to 3.40-GHz) processor (4.0-MB L3 cache, dual core, 35 W)	631252-001
Intel Core i5-2540M 2.60-GHz (SC turbo up to 3.30-GHz) processor (3.0-MB L3 cache, dual core, 35 W)	631255-001
Intel Core i5-2520M 2.50-GHz (SC turbo up to 3.20-GHz) processor (3.0-MB L3 cache, dual core, 35 W)	631253-001
Intel Core i5-2430M 2.40-GHz (SC turbo up to 3.00-GHz) processor (3.0-MB L3 cache, dual core, 35 W)	653341-001
Intel Core i3-2350M 2.30-GHz processor (3.0-MB L3 cache, dual core, 35 W)	653340-001
Intel Core i3-2330M 2.20-GHz processor (3.0-MB L3 cache, dual core, 35 W)	653339-001
Intel Pentium B960 TJ85 2.20-GHz processor (2.0-MB L3 cache, dual core, 35 W)	664662-001
Intel Pentium B950 TJ85 2.10-GHz processor (2.0-MB L3 cache, dual core, 35 W)	653338-001

Before removing the processor, follow these steps:

1. Shut down the computer. If you are unsure whether the computer is off or in Hibernation, turn the computer on, and then shut it down through the operating system.
2. Disconnect all external devices connected to the computer.
3. Disconnect the power from the computer by first unplugging the power cord from the AC outlet and then unplugging the AC adapter from the computer.
4. Remove the battery (see [Battery on page 51](#)), and then remove the following components:
 - Optical drive (see [Optical drive on page 52](#))
 - Hard drive (see [Hard drive on page 54](#))
 - WLAN module (see [WLAN module on page 59](#))

- Keyboard (see [Keyboard on page 62](#))
- Top cover (see [Top cover on page 66](#))
- System board (see [System board on page 77](#))
- Fan/heat sink assembly (see [Fan/heat sink assembly on page 81](#))

Remove the processor:

1. Use a flat-bladed screw driver to turn the processor locking screw one-half turn counterclockwise **(1)**, until you hear a click.

2. Lift the processor **(2)** straight up, and remove it.

 **NOTE:** The gold triangle **(3)** on the processor must be aligned with the triangle icon embossed on the processor socket when you install the processor.

 **NOTE:** The following illustration shows the processor removal process on a computer model equipped with an AMD processor.

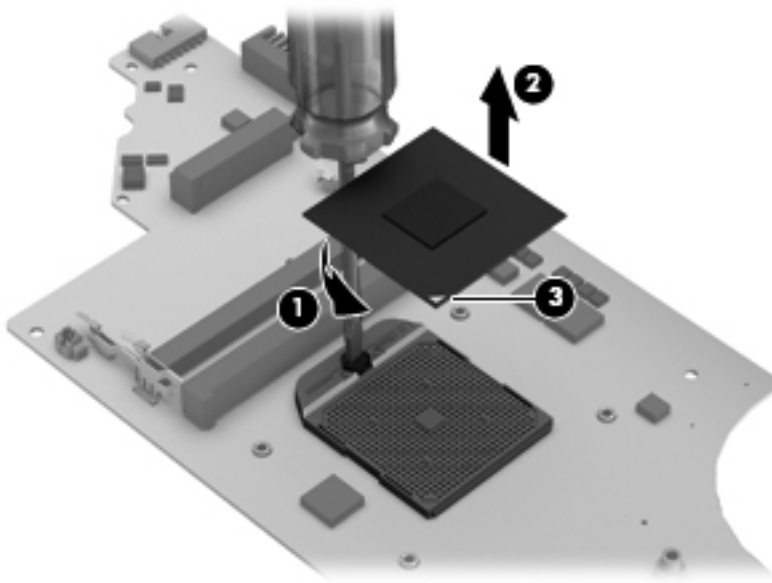

 **NOTE:** The following illustration shows the processor removal process on a computer model equipped with an Intel processor.

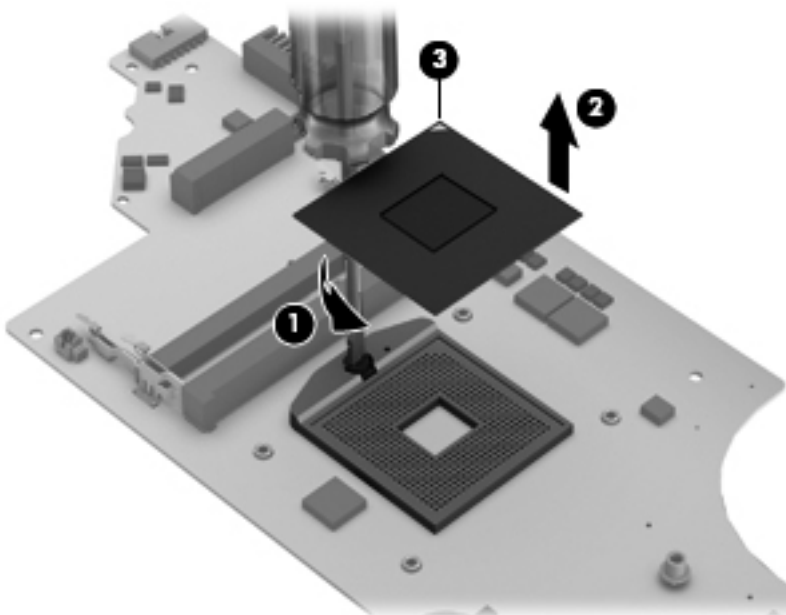

Reverse this procedure to install the processor.

Speakers

Description	Spare part number
Speaker cover	665333-001
Speaker Kit (includes left and right speakers and cable)	665340-001

Before removing the speakers, follow these steps:

1. Shut down the computer. If you are unsure whether the computer is off or in Hibernation, turn the computer on, and then shut it down through the operating system.
2. Disconnect all external devices connected to the computer.
3. Disconnect the power from the computer by first unplugging the power cord from the AC outlet and then unplugging the AC adapter from the computer.
4. Remove the battery (see [Battery on page 51](#)), and then remove the following components:
 - Optical drive (see [Optical drive on page 52](#))
 - Hard drive (see [Hard drive on page 54](#))
 - Keyboard (see [Keyboard on page 62](#))
 - Top cover (see [Top cover on page 66](#))
 - System board (see [System board on page 77](#))

Remove the speakers:

1. Close the computer.
2. Turn the computer upside down, with the front toward you.

3. Release the rear speaker cable **(1)** from the clips **(2)** and routing channel built into the base enclosure.

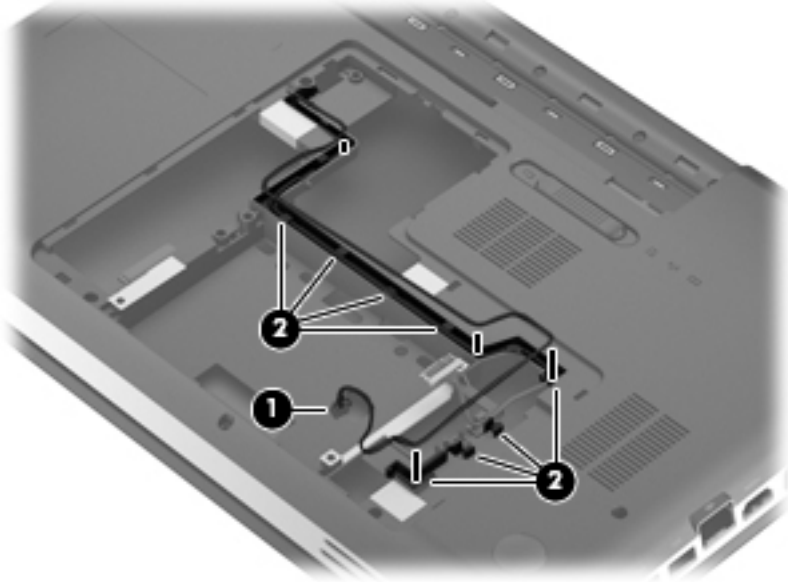

4. Remove the four Phillips PM2.5×4.0 screws **(1)** and the PM2.5×10.0 screw **(2)** that secure the rear speaker to the computer.

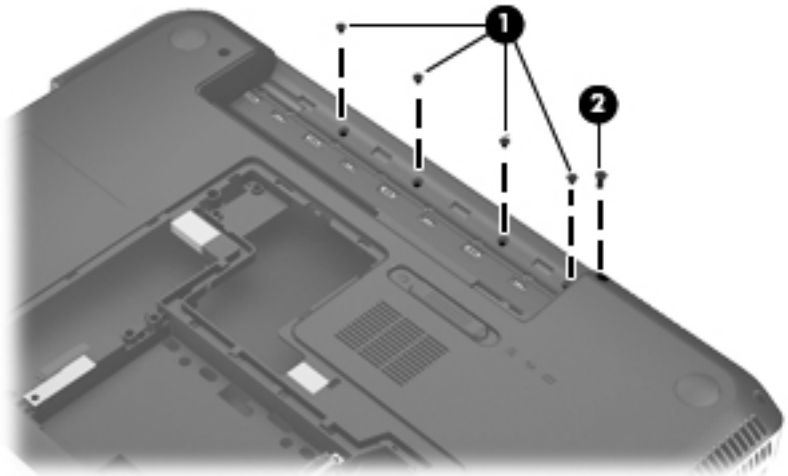

5. Turn the computer right side up, with the front toward you.
6. Open the computer.
7. Release the rear speaker cable **(1)** from the opening in the base enclosure and the clips **(2)** and **(3)** built into the base enclosure.

8. Remove the rear speaker **(4)** and cable.

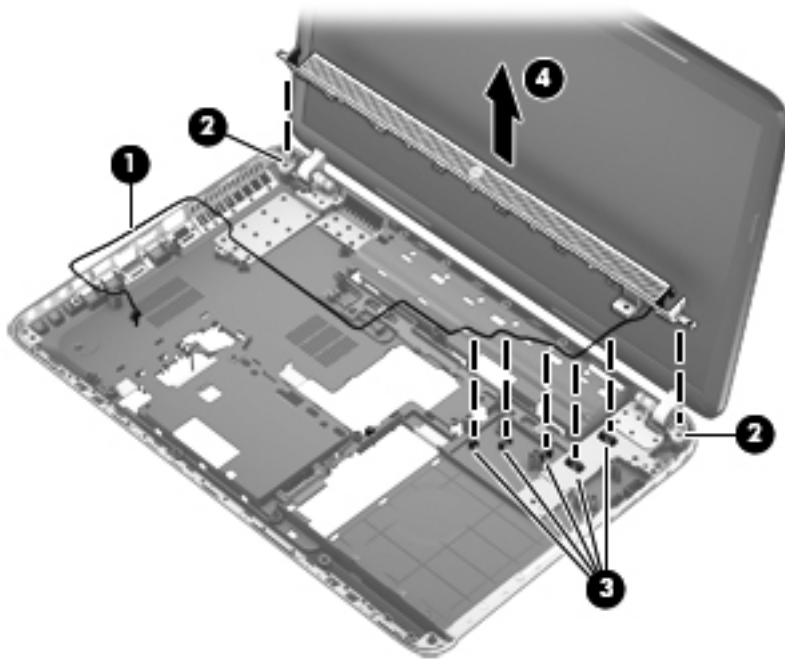

9. Remove the Phillips PM2.5×4.0 screw **(1)** that secures the front speaker to the base enclosure.

10. Remove the front speaker **(2)**.

 **NOTE:** When removing the front speaker, note the installation locations of two isolators **(3)**.

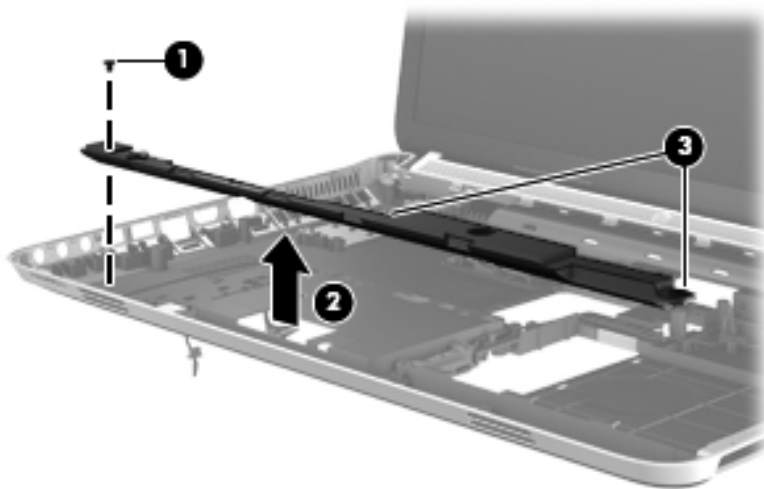

Reverse this procedure to install the speakers.

Optical drive connector cable

 **NOTE:** The optical drive connector cable is included in the Cable Kit, spare part number 665301-001. The optical drive connector cable includes the optical drive connector.

Before removing the optical drive connector cable, follow these steps:

1. Shut down the computer. If you are unsure whether the computer is off or in Hibernation, turn the computer on, and then shut it down through the operating system.
2. Disconnect all external devices connected to the computer.
3. Disconnect the power from the computer by first unplugging the power cord from the AC outlet and then unplugging the AC adapter from the computer.
4. Remove the battery (see [Battery on page 51](#)), and then remove the following components:
 - Optical drive (see [Optical drive on page 52](#))
 - Hard drive (see [Hard drive on page 54](#))
 - Keyboard (see [Keyboard on page 62](#))
 - Top cover (see [Top cover on page 66](#))
 - System board (see [System board on page 77](#))

Remove the optical drive connector cable:

1. Close the computer.
2. Turn the computer upside down, with the front toward you.
3. Release the optical drive connector cable **(1)** from the clips **(2)** and routing channel built into the base enclosure.

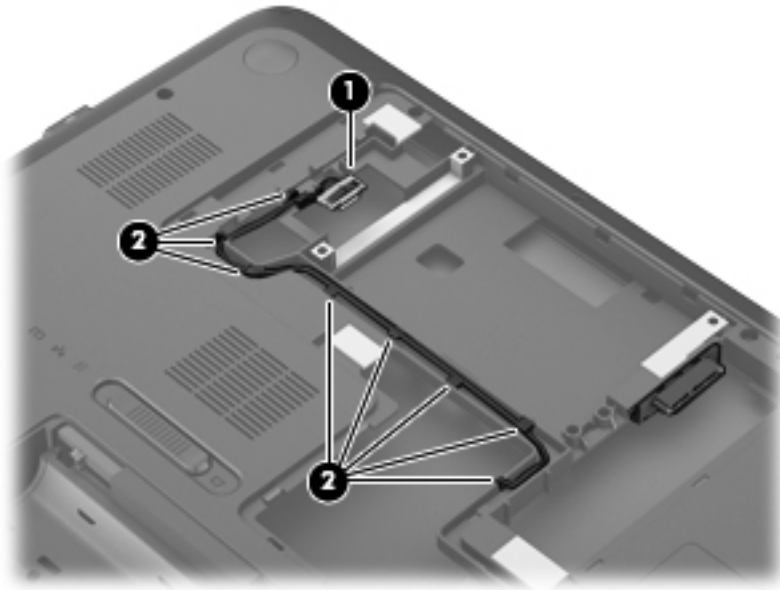

4. Turn the computer right side up, with the front toward you.
5. Open the computer.
6. Release the optical drive connector cable from the clips **(1)** built into the base enclosure.
7. Remove the two Phillips PM2.0x7.0 screws **(1)** that secure the optical drive connector to the base enclosure.
8. Remove the optical drive connector cable **(3)**.

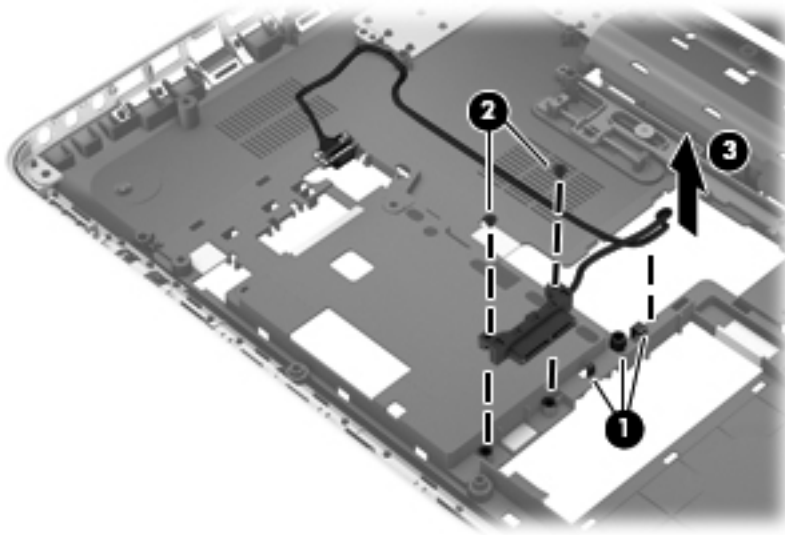

Reverse this procedure to install the optical drive connector cable.

Display assembly

 **NOTE:** The display assembly is spared at the subcomponent level only.

Before removing the display assembly, follow these steps:

1. Shut down the computer. If you are unsure whether the computer is off or in Hibernation, turn the computer on, and then shut it down through the operating system.
2. Disconnect all external devices connected to the computer.
3. Disconnect the power from the computer by first unplugging the power cord from the AC outlet and then unplugging the AC adapter from the computer.
4. Remove the battery (see [Battery on page 51](#)), and then remove the following components:
 - Optical drive (see [Optical drive on page 52](#))
 - Hard drive (see [Hard drive on page 54](#))
 - WLAN module (see [WLAN module on page 59](#))
 - Keyboard (see [Keyboard on page 62](#))

- Top cover (see [Top cover on page 66](#))
- System board (see [System board on page 77](#))

Remove the display assembly:

1. Release the wireless antenna cables from the clips **(1)** and the opening in the base enclosure.

CAUTION: Support the display assembly when removing the following screws. Failure to support the display assembly can result in damage to the display assembly and other computer components.

2. Remove the six Phillips PM2.5×5.0 screws **(2)** that secure the display assembly to the computer.

NOTE: The left-most screw on the left hinge secures a display panel cable ground loop **(3)**.

3. Remove the display assembly **(4)**.

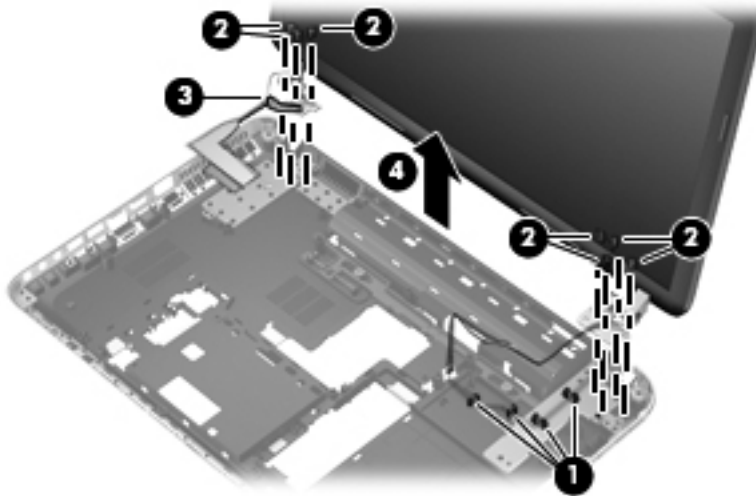

4. If it is necessary to replace the display bezel or any of the display assembly subcomponents:
- a. Remove the two screw covers **(1)** and the two Phillips PM2.5×5.0 screws **(2)** that secure the display bezel to the display assembly. (The screw covers are available in the Display Rubber Kit, spare part number 665337-001.)

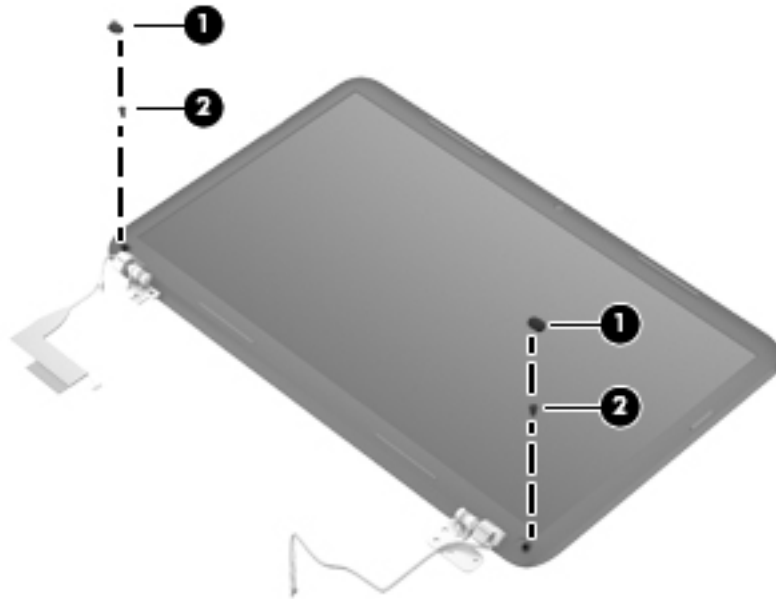

- b. Flex the inside edges of the top edge **(1)**, the left and right sides **(2)**, and the bottom edge **(3)** of the display bezel until the bezel disengages from the display enclosure.
- c. Remove the display bezel **(4)**. The display bezel is available using spare part numbers 665300-001 (for use only with computer models in dark umber and steel gray finish) and 665299-001 (for use only with computer models in butter gold, espresso black, linen white, Pacific blue, pearl pink, ruby red, and Sonoma red finish).

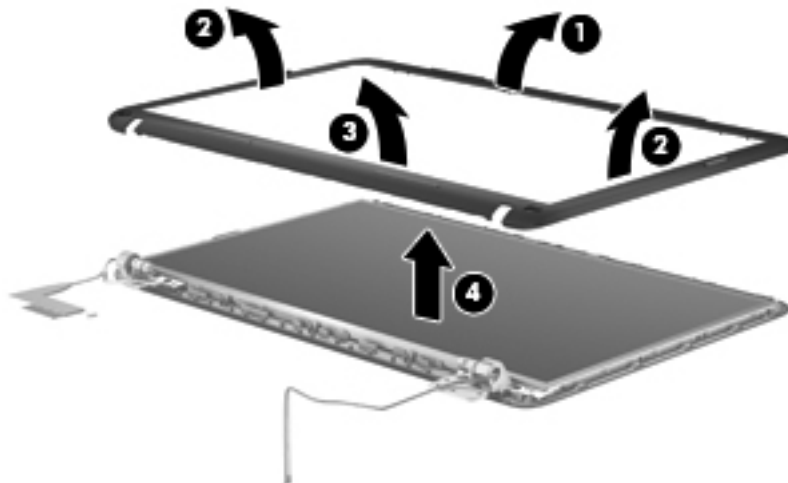

5. If it is necessary to replace the webcam/microphone module:
 - a. Detach and release the webcam/microphone module **(1)** as far as the webcam/microphone module cable allows. (The webcam/microphone module is attached to the display enclosure with double-sided tape.)
 - b. Disconnect the webcam/microphone module **(2)** from the webcam/microphone module.
 - c. Remove the webcam/microphone module **(3)**. The webcam/microphone module is available using spare part number 665365-001.

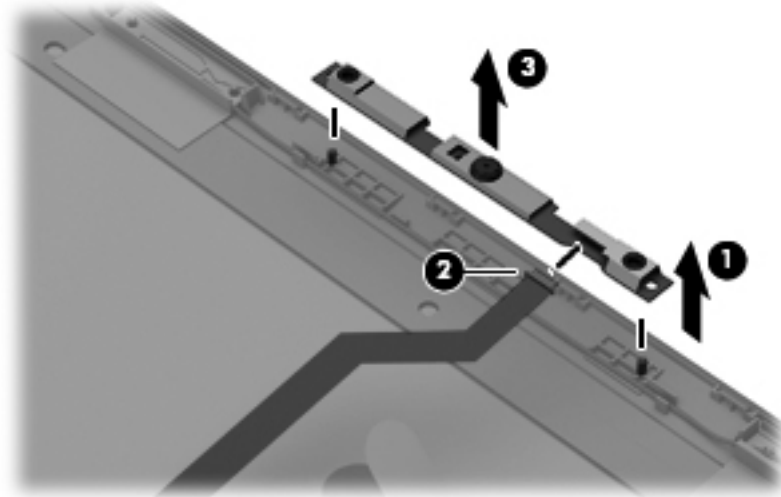

6. If it is necessary to replace the hinge covers:
 - a. Remove the two Phillips PM2.0×3.0 **(1)** screws that secure the hinge covers to the display enclosure.

- b. Remove the hinge covers (2). The hinge covers are available using spare part number 665314-001.

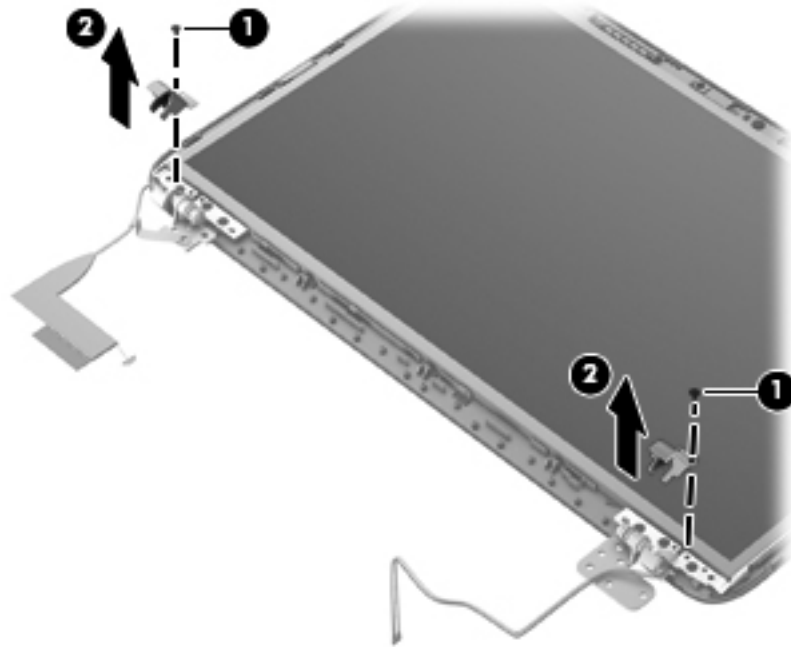

7. If it is necessary to replace the display panel:

- a. Remove the two Phillips PM2.5×3.5 (1) screws and the six Phillips PM2.5×5.0 screws (2) that secure the display panel to the display enclosure.

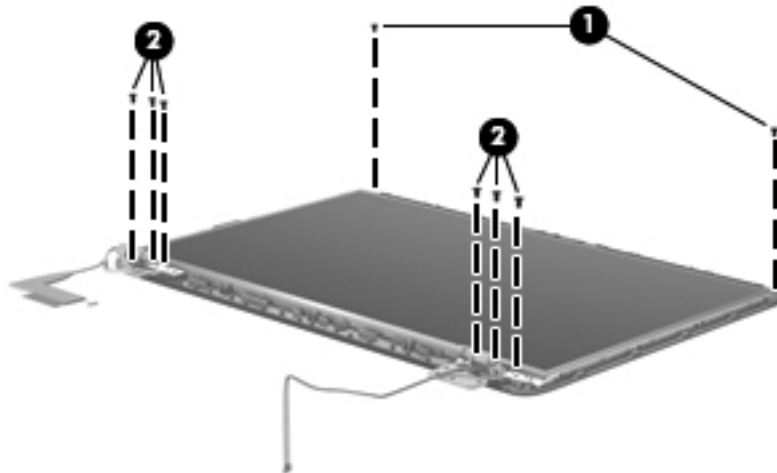

- b.** Lift the top edge of the display panel **(1)**, and then swing it forward **(2)** until it rests upside down in front of the display enclosure.

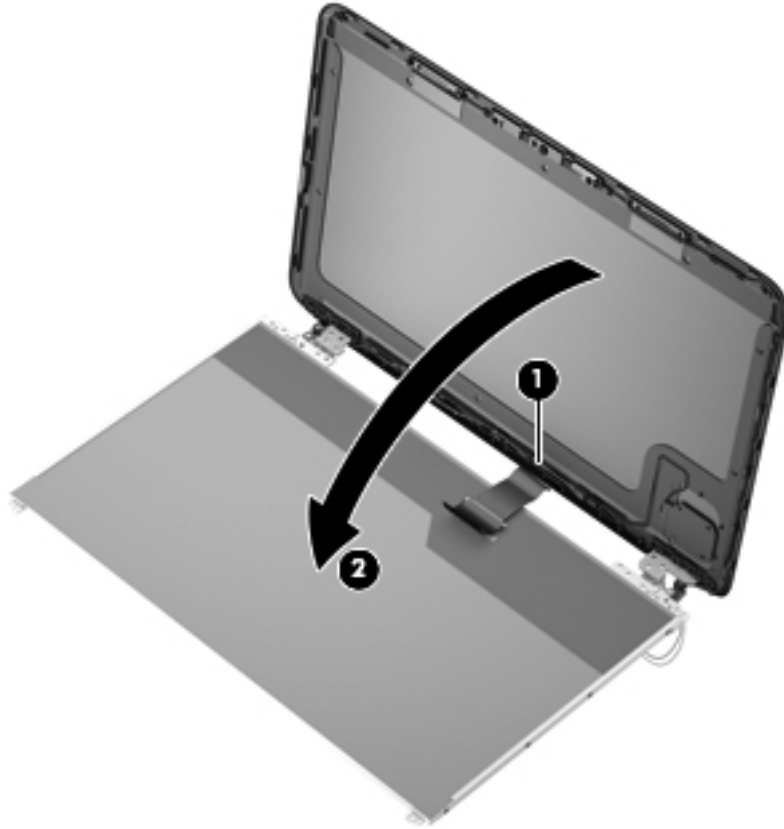

- c.** Release the adhesive strips **(1)** and **(2)** that secure the display panel cable to the display panel, and then disconnect the display panel cable **(3)** from the display panel.

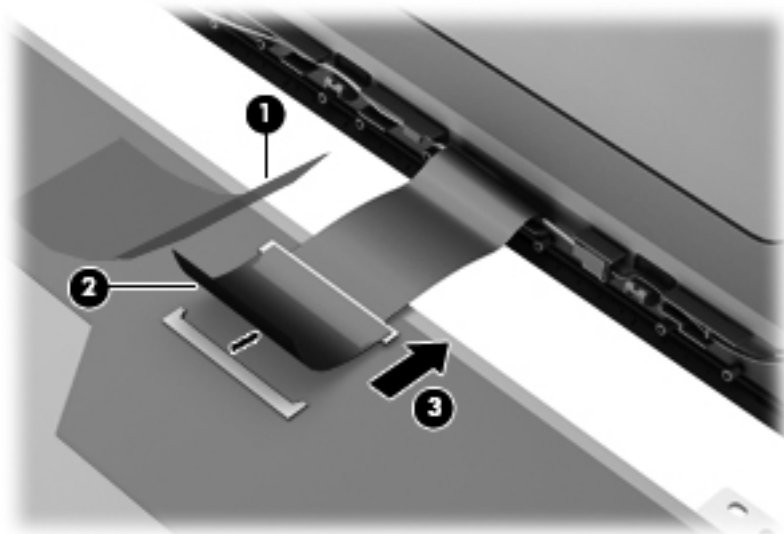

- d.** Remove the display panel. The display panel is available using spare part numbers 668279-001 and 665335-001 (for use with computer models equipped with a 15.6-in,

FHD, LED, AntiGlare display panel) and 668280-001, 668278-001, and 665334-001 (for use with computer models equipped with a 15.6-in, HD, LED, BrightView display panel).

8. If it is necessary to replace the display hinges:
 - a. Remove the eight Phillips PM2.0×2.0 screws **(1)** that secure the display hinges to the display panel.
 - b. Remove the display hinges **(2)**. The display hinges include the display hinges and brackets and are available using spare part number 665313-001.

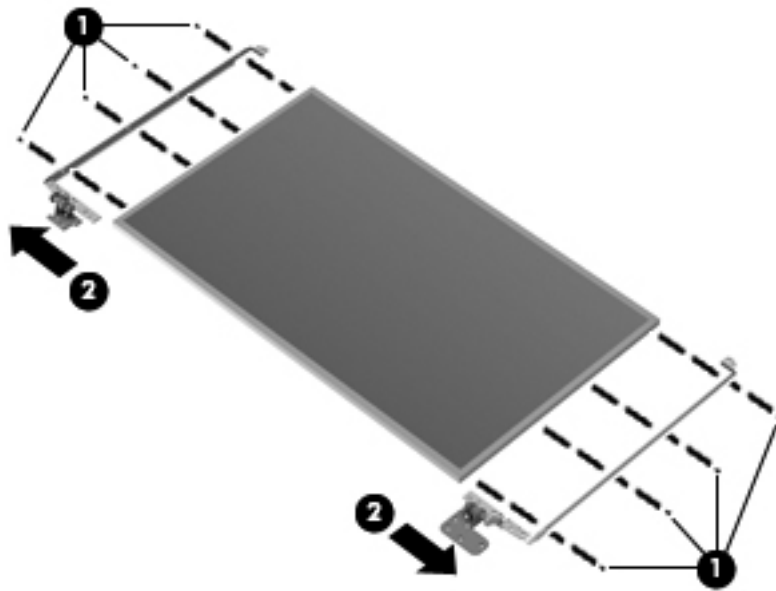

9. If it is necessary to replace the display panel cable:
 - a. Release the tabs **(1)** built into the display enclosure shielding that secure the display panel cable to the display enclosure.

- b.** Release the display panel cable from the clips **(2)** built into the display enclosure.

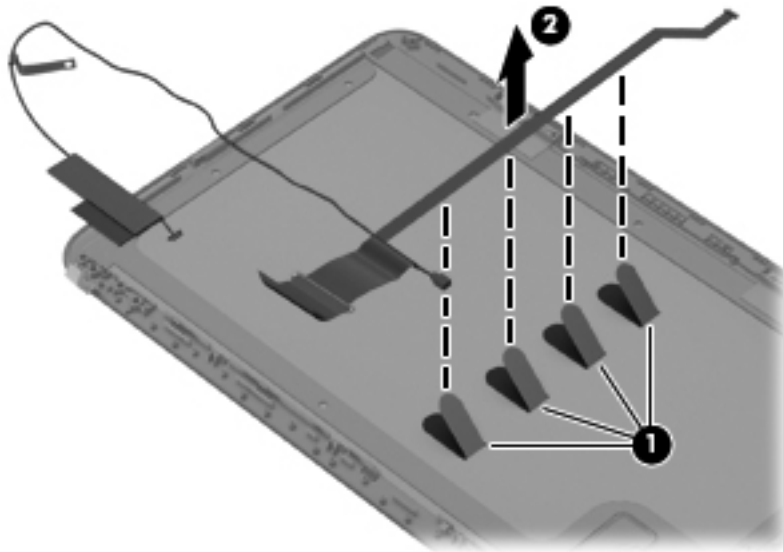

- c.** Remove the display panel cable. The display panel cable includes the webcam/microphone module cable and is available in the Display Cable Kit, using the following spare part numbers:

- 665305-001 — For use only with computer models equipped with a FHD display assembly
- 665304-001 — For use only with computer models in dark umber and steel gray finish
- 665302-001 — For use only with computer models in butter gold, espresso black, linen white, Pacific blue, pearl pink, ruby red, and Sonoma red finish

10. If it is necessary to replace the wireless antenna cables and transceivers:

- a.** Release the wireless antenna transceivers **(1)** from the display enclosure. (The wireless antenna transceivers are attached to the display enclosure with double-sided tape.)
- b.** Release the wireless antenna cables from the clips **(2)** built into the display enclosure.

- c. Remove the wireless antenna cables and transceivers **(3)**. The wireless antenna cables and transceivers are available in the Antenna Kit, spare part number 665287-001.

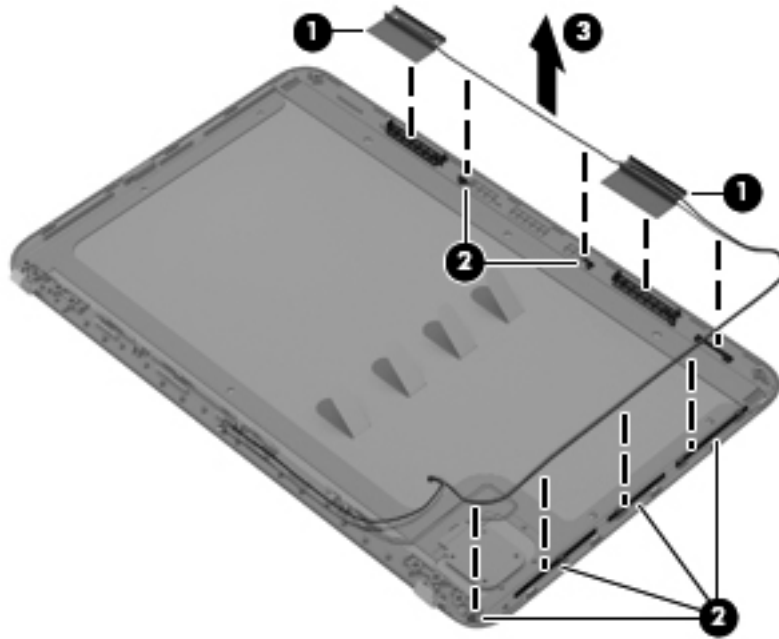

Reverse this procedure to reassemble and install the display assembly.

5 Setup Utility (BIOS) and System Diagnostics

Using Setup Utility

Setup Utility, or Basic Input/Output System (BIOS), controls communication between all the input and output devices on the system (such as disk drives, display, keyboard, mouse, and printer). Setup Utility includes settings for the types of peripherals installed, the startup sequence of the computer, and the amount of system and extended memory.

 **NOTE:** Use extreme care when making changes in Setup Utility. Errors can prevent the computer from operating properly.

Starting Setup Utility

 **NOTE:** An external keyboard or mouse connected to a USB port can be used with Setup Utility only if USB legacy support is enabled.

To start Setup Utility, follow these steps:

1. Turn on or restart the computer, and then press **esc** while the “Press the ESC key for Startup Menu” message is displayed at the bottom of the screen.
2. Press **f10** to enter Setup Utility.

Changing the language of Setup Utility

1. Start Setup Utility.
2. Use the arrow keys to select **System Configuration > Language**, and then press **enter**.
3. Use the arrow keys to select a language, and then press **enter**.
4. When a confirmation prompt with your language selected is displayed, press **enter**.
5. To save your change and exit Setup Utility, use the arrow keys to select **Exit > Exit Saving Changes**, and then press **enter**.

Your change takes effect immediately.

Navigating and selecting in Setup Utility

To navigate and select in Setup Utility, follow these steps:

1. Turn on or restart the computer, and then press **esc** while the “Press the ESC key for Startup Menu” message is displayed at the bottom of the screen.
 - To select a menu or a menu item, use the tab key and the keyboard arrow keys and then press **enter**, or use a pointing device to click the item.
 - To scroll up and down, click the up arrow or the down arrow in the upper-right corner of the screen, or use the up arrow key or the down arrow key.
 - To close open dialog boxes and return to the main Setup Utility screen, press **esc**, and then follow the on-screen instructions.



NOTE: You can use either a pointing device (TouchPad, pointing stick, or USB mouse) or the keyboard to navigate and make selections in Setup Utility.

2. Press **f10** to enter Setup Utility.

To exit Setup Utility menus, choose one of the following methods:

- To exit Setup Utility menus without saving your changes, click the **Exit** icon in the lower-left corner of the screen, and then follow the on-screen instructions.

– or –

Use the tab key and the arrow keys to select **File > Ignore Changes and Exit**, and then press **enter**.

- To save your changes and exit Setup Utility menus, click the **Save** icon in the lower-left corner of the screen, and then follow the on-screen instructions.

– or –

Use the tab key and the arrow keys to select **File > Save Changes and Exit**, and then press **enter**.

Your changes go into effect when the computer restarts.

Displaying system information

1. Start Setup Utility.
2. Select the **Main** menu. System information such as the system time and date, and identification information about the computer is displayed.
3. To exit Setup Utility without changing any settings, use the arrow keys to select **Exit > Exit Discarding Changes**, and then press **enter**.

Restoring factory settings in Setup Utility

 **NOTE:** Restoring defaults will not change the hard drive mode.

To return all settings in Setup Utility to the values that were set at the factory, follow these steps:

1. Turn on or restart the computer, and then press **esc** while the “Press the ESC key for Startup Menu” message is displayed at the bottom of the screen.
2. Press **f10** to enter Setup Utility.
3. Use a pointing device or the arrow keys to select **File > Restore Defaults**.
4. Follow the on-screen instructions.
5. To save your changes and exit, click the **Save** icon in the lower-left corner of the screen, and then follow the on-screen instructions.

– or –

Use the arrow keys to select **File > Save Changes and Exit**, and then press **enter**.

Your changes go into effect when the computer restarts.

 **NOTE:** Your password settings and security settings are not changed when you restore the factory settings.

Exiting Setup Utility

- To exit Setup Utility and save your changes from the current session:
If the Setup Utility menus are not visible, press **esc** to return to the menu display. Then use the arrow keys to select **Exit > Exit Saving Changes**, and then press **enter**.
- To exit Setup Utility without saving your changes from the current session:
If the Setup Utility menus are not visible, press **esc** to return to the menu display. Then use the arrow keys to select **Exit > Exit Discarding Changes**, and then press **enter**.

Updating the BIOS

Updated versions of the BIOS may be available on the HP Web site.

Most BIOS updates on the HP Web site are packaged in compressed files called *SoftPaqs*.

Some download packages contain a file named *Readme.txt*, which contains information regarding installing and troubleshooting the file.

Determining the BIOS version

To determine whether available BIOS updates contain later BIOS versions than those currently installed on the computer, you need to know the version of the system BIOS currently installed.

BIOS version information (also known as ROM date and System BIOS) can be displayed by pressing **fn +esc** (if you are already in Windows) or by using Setup Utility.

1. Start Setup Utility.
2. Use a pointing device or the arrow keys to select **File > System Information**.
3. To exit Setup Utility without saving your changes, click the **Exit** icon in the lower-left corner of the screen, and then follow the on-screen instructions.

– or –

Use the tab key and the arrow keys to select **File > Ignore Changes and Exit**, and then press **enter**.

Downloading a BIOS update

 **CAUTION:** To reduce the risk of damage to the computer or an unsuccessful installation, download and install a BIOS update only when the computer is connected to reliable external power using the AC adapter. Do not download or install a BIOS update while the computer is running on battery power, docked in an optional docking device, or connected to an optional power source. During the download and installation, follow these instructions:

Do not disconnect power from the computer by unplugging the power cord from the AC outlet.

Do not shut down the computer or initiate Sleep or Hibernation.

Do not insert, remove, connect, or disconnect any device, cable, or cord.

1. **Windows 7**—Select **Start > Help and Support > Maintain**.
Windows XP—Select **Start > Help and Support**, and then select the software and drivers update.
2. Follow the on-screen instructions to identify your computer and access the BIOS update you want to download.
3. At the download area, follow these steps:
 - a. Identify the BIOS update that is later than the BIOS version currently installed on your computer. Make a note of the date, name, or other identifier. You may need this information to locate the update later, after it has been downloaded to your hard drive.
 - b. Follow the on-screen instructions to download your selection to the hard drive. Make a note of the path to the location on your hard drive where the BIOS update is downloaded. You will need to access this path when you are ready to install the update.

 **NOTE:** If you connect your computer to a network, consult the network administrator before installing any software updates, especially system BIOS updates.

BIOS installation procedures vary. Follow any instructions that are displayed on the screen after the download is complete. If no instructions are displayed, follow these steps:

1. **Windows 7**—Open Windows Explorer by selecting **Start > Computer**.
Windows XP—Open Windows Explorer by selecting **Start > My Computer**.
2. Double-click your hard drive designation. The hard drive designation is typically Local Disk (C:).
3. Using the hard drive path you recorded earlier, open the folder on your hard drive that contains the update.
4. Double-click the file that has an .exe extension (for example, *filename.exe*).
The BIOS installation begins.
5. Complete the installation by following the on-screen instructions.

 **NOTE:** After a message on the screen reports a successful installation, you can delete the downloaded file from your hard drive.

Using System Diagnostics

System Diagnostics allows you to run diagnostic tests to determine if the computer hardware is functioning properly. The following diagnostic tests are available in System Diagnostics:

- Start-up test—This test analyzes the main computer components that are required to start the computer.
- Run-in test—This test repeats the start-up test and checks for intermittent problems that the start-up test does not detect.
- Hard disk test—This test analyzes the physical condition of the hard drive, and then checks all data in every sector of the hard drive. If the test detects a damaged sector, it attempts to move the data to a good sector.
- Memory test—This test analyzes the physical condition of the memory modules. If it reports an error, replace the memory modules immediately.
- Battery test—This test analyzes the condition of the battery. If the battery fails the test, contact HP support to report the issue and purchase a replacement battery.

You can also view system information and error logs in the System Diagnostics window.

To start System Diagnostics:

1. Turn on or restart the computer. While the “Press the ESC key for Startup Menu” message is displayed in the lower-left corner of the screen, press **esc**. When the Startup Menu is displayed, press **f2**.
2. Click the diagnostic test you want to run, and then follow the on-screen instructions.

 **NOTE:** If you need to stop a diagnostics test while it is running, press **esc**.

6 Specifications

Computer specifications

	Metric	U.S.
Dimensions		
Depth	24.7 cm	9.72 in
Width	37.8 cm	14.88 in
Height (front to back)	3.1 to 3.5 cm	1.23 to 1.39 in
Weight	2.91 kg	6.42 lb
Input power		
Operating voltage	18.5 V dc @ 3.5 A – 65 W; 19 V dc @ 4.74 A – 90 W; or 18.5 V dc @ 6.5 A – 120 W	
Operating current	3.5, 4.74, or 6.5 A	
Temperature		
Operating	5°C to 35°C	41°F to 95°F
Nonoperating	-20°C to 60°C	-4°F to 140°F
Relative humidity (noncondensing)		
Operating	10% to 90%	
Nonoperating	5% to 95%	
Maximum altitude (unpressurized)		
Operating	-15 m to 3,048 m	-50 ft to 10,000 ft
Nonoperating	-15 m to 12,192 m	-50 ft to 40,000 ft

NOTE: Applicable product safety standards specify thermal limits for plastic surfaces. The device operates well within this range of temperatures.

15.6-inch display specifications

	Metric	U.S.
Dimensions		
Height	19.6 cm	7.72 in
Width	34.7 cm	13.66 in
Diagonal	39.8 cm	15.67 in
Number of colors	Up to 16.8 million	
Contrast ratio	200:1 (typical)	
Brightness	200 nits (typical)	
Pixel resolution		
Pitch	0.197 × 0.197 mm	
Format	1366 × 768	
Configuration	RGB vertical stripe	
Backlight	LED	
Character display	80 × 25	
Total power consumption	2.0 W	
Viewing angle	±65° horizontal, ±50° vertical (typical)	

Hard drive specifications

	1-TB*	750-GB**	640-GB**
Dimensions			
Height	12.7 mm	9.5 mm	9.5 mm
Length	100.2 mm	100.2 mm	100.2 mm
Width	69.9 mm	69.9 mm	69.9 mm
Weight	152 g	110 g	98 g
Interface type	SATA (3 GB/sec)	SATA (3 GB/sec)	SATA
Transfer rate			
Synchronous (maximum)	97 MB/sec	97 MB/sec	106 MB/sec
Security	ATA security	ATA security	ATA security
Seek times (typical read, including setting)			
Single track	2.0 ms	2.0 ms	1.5 ms
Average (read/write)	12/16 ms	12/16 ms	12/13 ms
Maximum	21 ms	21 ms	24 ms
Logical blocks	1,953,525, 168	1,465,149,168	1,250,263,728
Disk rotational speed	5400 RPM	7200 and 5400 rpm	7200 rpm
Operating temperature	0°C to 60°C (32°F to 140°F)		
*1 TB = 1 trillion bytes when referring to hard drive storage capacity. Actual accessible capacity is less.			
**1 GB = 1 billion bytes when referring to hard drive storage capacity. Actual accessible capacity is less.			
NOTE: Certain restrictions and exclusions apply. Contact technical support for details.			

Hard drive specifications (continued)

	500-GB*	320-GB*	250-GB*
Dimensions			
Height	9.5 mm	7.0 mm	7.0 mm
Length	100.4 mm	100.4 mm	100.4 mm
Width	69.9 mm	69.9 mm	69.9 mm
Weight	110 g	110 g	105 g
Interface type			
	SATA	SATA	SATA
Transfer rate			
Synchronous (maximum)	1.1 GB/sec	1.1 GB/sec	1.1 GB/sec
Security	ATA security	ATA security	ATA security
Seek times (typical read, including setting)			
Single track	1.5 ms	1.5 ms	1.5 ms
Average (read/write)	11/13 ms	11/13 ms	11/13 ms
Maximum	22 ms	22 ms	22 ms
Logical blocks			
	976,773,168	628,142,448	488,397,168
Disk rotational speed			
	7200 rpm	7200 rpm	7200 rpm
Operating temperature			
	0°C to 60°C (32°F to 140°F)		
*1 GB = 1 billion bytes when referring to hard drive storage capacity. Actual accessible capacity is less.			
NOTE: Certain restrictions and exclusions apply. Contact technical support for details.			

7 Backup and recovery

Your computer includes tools provided by the operating system and HP to help you safeguard your information and restore it if ever needed.

This chapter provides information on the following topics:

- Creating a set of recovery discs or a recovery flash drive (Recovery Manager software feature)
- Performing a system restore (from the partition, recovery discs, or a recovery flash drive)
- Backing up your information
- Recovering a program or driver

Restore

In the event of hard drive failure, to restore your system to its factory image you will need a set of recovery discs or a recovery flash drive that you can create using HP Recovery Manager. HP recommends that you use this software to create either a set of recovery discs or a recovery flash drive immediately after software setup.

If for some other reason you need to restore your system, this can be achieved using the HP Recovery partition (select models only), without the need for recovery discs or a recovery flash drive. To check for the presence of a recovery partition, click **Start**, right-click **Computer**, click **Manage**, and then click **Disk Management**. If the recovery partition is present, a Recovery drive is listed in the window.

 **CAUTION:** HP Recovery Manager (partition, or discs/flash drive) restores only software that was preinstalled at the factory. Software not provided with this computer must be reinstalled manually.

 **NOTE:** Recovery discs have been included if your computer does not have a recovery partition.

Creating restore media

HP recommends that you create either a set of recovery discs or a recovery flash drive to be sure that you can restore your computer to its original factory state if the hard drive fails, or if for any reason you cannot restore using the recovery partition tools. Create these discs or the flash drive after setting up the computer for the first time.

 **NOTE:** HP Recovery Manager allows the creation of only one set of recovery discs or one recovery flash drive. Handle these discs or flash drive carefully and keep them in a safe place.

 **NOTE:** If your computer does not include an integrated optical drive, you can use an optional external optical drive (purchased separately) to create recovery discs, or you can purchase recovery discs for your computer from the HP Web site. If you use an external optical drive, it must be connected directly to a USB port on the computer, not to a USB port on an external device, such as a USB hub.

Guidelines:

- Purchase high-quality DVD-R, DVD+R, DVD-R DL, or DVD+R DL discs.

 **NOTE:** Read-write discs, such as CD-RW, DVD±RW, double-layer DVD±RW, and BD-RE (rewritable Blu-ray) discs, are not compatible with the Recovery Manager software.

- the computer must be connected to AC power during this process.
- Only one set of recovery discs or one recovery flash drive can be created per computer.

 **NOTE:** If you are creating recovery discs, number each disc before inserting into the optical drive.

- If necessary, you can exit the program before you have finished creating the recovery discs or recovery flash drive. The next time you open Recovery Manager, you will be prompted to continue the backup creation process.

To create a set of recovery discs or a recovery flash drive:

1. Select **Start > All Programs > Recovery Manager > Recovery Media Creation**.
2. Follow the on-screen instructions.

Performing a system restore

Recovery Manager software allows you to repair or restore the computer to its original factory state. Recovery Manager works from recovery discs, a recovery flash drive, or from a dedicated recovery partition (select models only) on the hard drive.

 **NOTE:** A system restore needs to be performed if the computer hard drive has failed or if all attempts to correct any functional computer issues fail.

A system restore should be used as a final attempt to correct computer issues. Note the following when performing a system restore:

- You can restore only the system that you have previously backed up. HP recommends that you use HP Recovery Manager to create either a set of recovery discs or a recovery flash drive as soon as you set up the computer.
- Windows has its own built-in repair features, such as System Restore. If you have not already tried these features, try them before using Recovery Manager.
- Recovery Manager restores only software that was preinstalled at the factory. Software not provided with this computer must be downloaded from the manufacturer's Web site or reinstalled from the disc provided by the manufacturer.

Restoring using the dedicated recovery partition (select models only)

When using the dedicated recovery partition, there is an option to back up pictures, music and other audio, videos and movies, recorded TV shows, documents, spreadsheets and presentations, e-mails, Internet favorites and settings during this process.

To restore the computer from the recovery partition, follow these steps:

1. Access Recovery Manager in either of the following ways:
 - Select **Start > All Programs > Recovery Manager > Recovery Manager**.
 - or –
 - Turn on or restart the computer, and then press **esc** while the “Press the ESC key for Startup Menu” message is displayed at the bottom of the screen. Then, press **f11** while the “F11 (System Recovery)” message is displayed on the screen.
2. Click **System Recovery** in the **Recovery Manager** window.
3. Follow the on-screen instructions.

Restoring using the restore media

1. If possible, back up all personal files.
2. Insert the first recovery disc into the optical drive on your computer or an optional external optical drive, and then restart the computer.

– or –

Insert the recovery flash drive into a USB port on your computer, and then restart the computer.



NOTE: If the computer does not automatically restart in the Recovery Manager, the computer boot order needs to be changed.

3. Press **f9** at system bootup.
4. Select the optical drive or the flash drive.
5. Follow the on-screen instructions.

Changing the computer boot order

To change the boot order for recovery discs:

1. Restart the computer.
2. Press **esc** while the computer is restarting, and then press **f9** for boot options.
3. Select **Internal CD/DVD ROM Drive** from the boot options window.

To change the boot order for recovery flash drive:

1. Insert the flash drive into a USB port.
2. Restart the computer.
3. Press **esc** while the computer is restarting, and then press **f9** for boot options.
4. Select the flash drive from the boot options window.

Backing up and recovering your information

It is very important to back up your files and keep any new software in a safe place. As you add new software and data files, continue to create backups on a regular basis.

How completely you are able to recover your system depends on how recent your backup is.

 **NOTE:** A recovery from your most recent backup needs to be performed if the computer has a virus attack or if any major system components fail. In order to correct computer issues, a recovery should first be attempted before a system restore is attempted.

You can back up your information to an optional external hard drive, a network drive, or discs. Back up your system at the following times:

- At regularly scheduled times

 **TIP:** Set reminders to back up your information periodically.

- Before the computer is repaired or restored
- Before you add or modify hardware or software

Guidelines:

- Create system restore points using the Windows System Restore feature, and periodically copy them to an optical disc or an external hard drive. For more information on using system restore points, refer to **Using Windows system restore points**.
- Store personal files in the Documents library and back up this folder periodically.
- Save customized settings in a window, toolbar, or menu bar by taking a screen shot of your settings. the screen shot can be a time-saver if you have to re-enter your preferences.

To create a screen shot:

1. Display the screen you want to save.
2. Copy the screen image:
 - To copy only the active window, press **alt+fn+prt sc**.
 - To copy the entire screen, press **fn+prt sc**.
3. Open a word-processing document, and then select **Edit > Paste**. the screen image is added to the document.
4. Save and print the document.

Using Windows Backup and Restore

Guidelines:

- Be sure that the computer is connected to AC power before you start the backup process.
- Allow enough time to complete the backup process. Depending on file sizes, it may take over an hour.

To create a backup:

1. Select **Start > Control Panel > System and Security > Backup and Restore**.
2. Follow the on-screen instructions to schedule and create a backup.



NOTE: Windows includes the User Account Control feature to improve the security of the computer. You may be prompted for your permission or password for tasks such as installing software, running utilities, or changing Windows settings. Refer to Help and Support for more information.

Using Windows system restore points

A system restore point allows you to save and name a snapshot of your hard drive at a specific point in time. You can then recover back to that point if you want to reverse subsequent changes.



NOTE: Recovering to an earlier restore point does not affect data files saved or e-mails created since the last restore point.

You also can create additional restore points to provide increased protection for your files and settings.

When to create restore points

- Before you add or modify software or hardware
- Periodically, whenever the computer is functioning optimally



NOTE: If you revert to a restore point and then change your mind, you can reverse the restoration.

Create a system restore point

1. Select **Start > Control Panel > System and Security > System**.
2. In the left pane, click **System Protection**.
3. Click the **System Protection** tab.
4. Follow the on-screen instructions.

Restore to a previous date and time

To revert to a restore point (created at a previous date and time), when the computer was functioning optimally, follow these steps:

1. Select **Start > Control Panel > System and Security > System**.
2. In the left pane, click **System Protection**.
3. Click the **System Protection** tab.
4. Click **System Restore**.
5. Follow the on-screen instructions.

8 Power cord set requirements

The wide-range input feature of the computer permits it to operate from any line voltage from 100 to 120 volts AC, or from 220 to 240 volts AC.

The 3-conductor power cord set included with the computer meets the requirements for use in the country or region where the equipment is purchased.

Power cord sets for use in other countries and regions must meet the requirements of the country or region where the computer is used.

Requirements for all countries

The following requirements are applicable to all countries and regions:

- The length of the power cord set must be at least **1.5 m** (5.0 ft) and no more than **2.0 m** (6.5 ft).
- All power cord sets must be approved by an acceptable accredited agency responsible for evaluation in the country or region where the power cord set will be used.
- The power cord sets must have a minimum current capacity of 10 A and a nominal voltage rating of 125 or 250 V ac, as required by the power system of each country or region.
- The appliance coupler must meet the mechanical configuration of an EN 60 320/IEC 320 Standard Sheet C13 connector for mating with the appliance inlet on the back of the computer.

Requirements for specific countries and regions

Country/region	Accredited agency	Applicable note number
Argentina	IRAM	1
Australia	SAA	1
Austria	OVE	1
Belgium	CEBEC	1
Brazil	ABNT	1
Canada	CSA	2
Chile	IMQ	1
Denmark	DEMKO	1
Finland	FIMKO	1
France	UTE	1
Germany	VDE	1
India	ISI	1
Israel	SII	1
Italy	IMQ	1
Japan	JIS	3
The Netherlands	KEMA	1
New Zealand	SANZ	1
Norway	NEMKO	1
The People's Republic of China	CCC	4
Saudi Arabia	SASO	7
Singapore	PSB	1
South Africa	SABS	1
South Korea	KTL	5
Sweden	SEMKO	1
Switzerland	SEV	1
Taiwan	BSMI	6
Thailand	TISI	1
The United Kingdom	ASTA	1

Country/region	Accredited agency	Applicable note number
The United States	UL	2
<ol style="list-style-type: none"> 1. The flexible cord must be Type HO5VV-F, 3-conductor, 0.75-mm² conductor size. Power cord set fittings (appliance coupler and wall plug) must bear the certification mark of the agency responsible for evaluation in the country or region where it will be used. 2. The flexible cord must be Type SVT/SJT or equivalent, No. 18 AWG, 3-conductor. The wall plug must be a two-pole grounding type with a NEMA 5-15P (15 A, 125 V) or NEMA 6-15P (15 A, 250 V ac) configuration. CSA or C-UL mark. UL file number must be on each element. 3. The appliance coupler, flexible cord, and wall plug must bear a “T” mark and registration number in accordance with the Japanese Dentori Law. The flexible cord must be Type VCTF, 3-conductor, 0.75-mm² or 1.25-mm² conductor size. The wall plug must be a two-pole grounding type with a Japanese Industrial Standard C8303 (7 A, 125 V ac) configuration. 4. The flexible cord must be Type RVV, 3-conductor, 0.75-mm² conductor size. Power cord set fittings (appliance coupler and wall plug) must bear the CCC certification mark. 5. The flexible cord must be Type H05VV-F 3X0.75-mm² conductor size. KTL logo and individual approval number must be on each element. Corset approval number and logo must be printed on a flag label. 6. The flexible cord must be Type HVCTF 3x1.25-mm² conductor size. Power cord set fittings (appliance coupler, cable, and wall plug) must bear the BSMI certification mark. 7. For 127 V ac, the flexible cord must be Type SVT or SJT 3 x 18 AWG, with plug NEMA 5-15P (15 A, 125 V ac), with UL and CSA or C-UL marks. For 240 V ac, the flexible cord must be Type H05VV-F 3x0.75-/1.00-mm² conductor size, with plug BS 1363/A with BSI or ASTA marks. 		

9 Recycling

When a non-rechargeable or rechargeable battery has reached the end of its useful life, do not dispose of the battery in general household waste. Follow the local laws and regulations in your area for battery disposal.

HP encourages customers to recycle used electronic hardware, HP original print cartridges, and rechargeable batteries. For more information about recycling programs, see the HP Web site at <http://www.hp.com/recycle>.

Index

A

- AC adapter, spare part numbers 33, 35
- Action keys 13
- antenna
 - locations 10
 - removal 100
 - spare part number 31, 37, 101
- Antenna Kit, spare part number 31, 37, 101
- audio, product description 5
- audio-in jack 16
- audio-out jack 16

B

- b key 12
- base enclosure, spare part numbers 27, 38
- battery
 - removal 51
 - spare part numbers 27, 35, 36, 51
- battery bay 18
- battery light 17
- battery release latch 18
- Blu-ray Disc R/RW FX SuperMulti Drive
 - precautions 45
 - removal 52
 - spare part number 28, 33, 40, 52
- Blu-ray Disc ROM FX SuperMulti DVD±R/RW Double-Layer Drive
 - precautions 45
 - removal 52
 - spare part number 28, 33, 40, 52

Bluetooth module

- removal 72
 - spare part number 24, 37, 72
- ## Bluetooth module cable
- removal 73
 - spare part number 24, 38
- ## bottom components 18
- ## button components 11
- ## buttons
- optical drive eject 17
 - power 11
 - TouchPad 14
 - TouchPad on/off 14
 - Web browser 11

C

- ## Cable Kit
- contents 29
 - spare part number 24, 29, 38
- ## cables, service considerations 44
- ## caps lock light 13
- ## chipset, product description 2
- ## components
- bottom 18
 - button 11
 - display 10
 - fingerprint reader 11
 - front 15
 - keys 12
 - left-side 16
 - lights 13
 - rear 15
 - right-side 17
 - speaker 11
 - TouchPad 14
- ## computer feet, locations 50
- ## computer major components 21
- ## computer part number 20, 49
- ## computer specifications 107

- connectors, service considerations 44

D

- ## Digital Media Slot 15
- ## display
- specifications 108
 - subcomponents 30
- ## display assembly
- removal 93
 - spare part numbers 93
- ## display bezel
- removal 95
 - spare part numbers 30, 38, 43
- ## Display Cable Kit, spare part numbers 30, 38, 100
- ## display components 10
- ## display enclosure, spare part numbers 31, 37, 38, 95
- ## Display Hinge Kit, spare part number 30, 39, 99
- ## display panel
- product description 4
 - removal 97
 - spare part numbers 30, 40, 43, 99
- ## display panel cable
- removal 99
 - spare part numbers 30, 100
- ## Display Rubber Kit, spare part number 31, 40
- ## Display Screw Kit, spare part number 31, 40
- ## drive light 17
- ## drives, preventing damage 45
- ## DVD±RW Double-Layer FX SuperMulti Drive
- precautions 45

- removal 52
- spare part number 28, 33, 40, 52

E

- electrostatic discharge 45
- equipment guidelines 48
- esc key 12
- Ethernet, product description 6
- external media cards, product description 7
- external monitor port 16

F

- fan/heat sink assembly
 - removal 81
 - spare part numbers 27, 37, 38, 81
- feet, locations 50
- fingerprint reader 11
- fingerprint reader board
 - removal 70
 - spare part number 24, 38, 70
- fingerprint reader board cable
 - disconnection 68
 - illustrated 29
- fingerprint reader components 11
- fn key 12
- front component 15

G

- graphics, product description 3
- grounding guidelines 45
- guidelines
 - equipment 48
 - grounding 45
 - packaging 47
 - transporting 47
 - workstation 47

H

- hard drive
 - precautions 45
 - product description 5
 - removal 54
 - spare part numbers 27, 32, 35, 36, 54
 - specifications 109, 110
- hard drive bay 18

- hard drive bracket
 - illustrated 32
 - removal 55
- hard drive connector cable
 - illustrated 29
 - removal 55
- Hard Drive Hardware Kit
 - contents 32
 - spare part number 28, 32, 39, 54
- HDMI port 16
- headphone jack 16
- hinge
 - removal 99
 - spare part number 30, 39, 99
- hinge cover
 - removal 96
 - spare part number 30, 39, 97

J

- jacks
 - audio-in 16
 - audio-out 16
 - headphone 16
 - microphone 16
 - network 16
 - RJ-45 16

K

- key components 12
- keyboard
 - product description 7
 - removal 62
 - spare part numbers 21, 39, 40, 42, 43, 62

keys

- Action 13
- b 12
- esc 12
- fn 12
- num lk 13
- numeric keypad 13
- Windows applications 12
- Windows logo 12

L

- left-side components 16
- light components 13
- lights
 - battery 17
 - caps lock 13

- drive 17
- fingerprint reader 14
- mute 13
- optical drive 17
- power 13, 17
- TouchPad off 14
- TouchPad on 14
- webcam 10
- wireless 14

M

- mass storage device
 - precautions 45
 - removal 54
 - spare part numbers 32, 54
- memory module
 - product description 4
 - removal 58
 - spare part numbers 27, 35, 36, 58
- microphone
 - locations 10
 - product description 5
- microphone jack 16
- model description 20, 50
- model name 1
- monitor port 16
- mute light 13

N

- network jack 16
- num lk key 13
- numeric keypad 13

O

- operating system, product description 8
- optical drive
 - location 17
 - precautions 45
 - product description 5
 - removal 52
 - spare part numbers 28, 33, 40, 52
- optical drive bracket, removal 53
- optical drive connector cable
 - illustrated 29
 - removal 92
- optical drive eject button 17
- optical drive light 17

- P**
- packaging guidelines 47
 - plastic parts, service considerations 44
 - Plastics Kit, spare part number 28, 40, 53
 - pointing device, product description 7
 - ports
 - external monitor 16
 - HDMI 16
 - monitor port 16
 - product description 7
 - USB 16, 17
 - power button 11
 - power button board
 - removal 69
 - spare part number 24, 40, 69
 - power button board cable
 - disconnection 68
 - illustrated 29
 - power connector 17
 - power connector cable
 - removal 75
 - spare part number 24, 38
 - power cord
 - set requirements 118
 - spare part numbers 33, 34, 35
 - power light 13, 17
 - power requirements, product description 8
 - processor
 - product description 1
 - removal 85
 - spare part numbers 26, 35, 36, 37, 42, 85
 - product description
 - audio 5
 - chipset 2
 - display panel 4
 - Ethernet 6
 - external media cards 7
 - graphics 3
 - hard drives 5
 - keyboard 7
 - memory module 4
 - microphone 5
 - operating system 8
 - optical drive 5
 - pointing device 7
 - ports 7
 - power requirements 8
 - processors 1
 - product name 1
 - security 8
 - serviceability 9
 - video 5
 - wireless 6
 - product name 1, 19, 49
 - product number 20, 49
- R**
- rear component 15
 - remote control, spare part number 34
 - removal/replacement
 - preliminaries 44
 - procedures 49
 - right-side components 17
 - RJ-45 jack 16
 - RTC battery
 - removal 57
 - spare part number 27, 36, 57
- S**
- Screw Kit, spare part number 34, 40
 - security cable slot 17
 - security, product description 8
 - serial number 19, 49
 - service considerations
 - cables 44
 - connectors 44
 - plastic parts 44
 - service cover
 - removal 53
 - spare part number 28, 53
 - service tag 19, 49
 - serviceability, product description 9
 - Setup Utility (BIOS) 102
 - solid-state drive
 - illustrated 33
 - precautions 45
 - removal 54
 - spare part number 28, 33, 43, 54
 - speaker components 11
 - speaker cover
 - removal 89
 - spare part number 24, 40, 89
 - Speaker Kit, spare part number 25, 40, 89
 - speakers
 - locations 11, 15
 - removal 89
 - spare part number 25, 40, 89
 - specifications
 - computer 107
 - display 108
 - hard drive 109, 110
 - system board
 - removal 77
 - spare part numbers 25, 37, 40, 41, 77
 - System Diagnostics 102
- T**
- Thermal Material Kit, spare part numbers 25, 37, 41, 77, 81, 85
 - tools required 44
 - top cover
 - removal 66
 - spare part numbers 23, 41, 42, 66
 - TouchPad button 14
 - TouchPad button board cable
 - disconnection 68
 - illustrated 29
 - TouchPad cable, illustrated 29
 - TouchPad components 14
 - TouchPad off light 14
 - TouchPad on light 14
 - TouchPad on/off button 14
 - TouchPad zone 14
 - transporting guidelines 47
- U**
- USB board
 - removal 74
 - spare part number 24, 40
 - USB board cable, illustrated 29
 - USB DVB-T TV tuner, spare part number 34, 35
 - USB DVD-T antenna, spare part number 34, 35
 - USB port 16, 17

V

vents 15, 16, 18
video, product description 5

W

warranty period 20, 50
Web browser button 11
webcam 10
webcam light 10
webcamera/microphone module
 removal 96
 spare part number 31, 42, 96
Windows applications key 12
Windows logo key 12
wireless antenna
 locations 10
 removal 100
 spare part number 31, 37,
 101
wireless light 14
wireless, product description 6
WLAN module
 removal 59
 spare part numbers 28, 35,
 36, 37, 59
workstation guidelines 47

