



HP LD4220tm and LD4720tm Digital Signage Touch Displays

User Guide

© 2011 Hewlett-Packard Development Company, L.P. The information contained herein is subject to change without notice.

The only warranties for HP products and services are set forth in the express warranty statements accompanying such products and services. Nothing herein should be construed as constituting an additional warranty. HP shall not be liable for technical or editorial errors or omissions contained herein.

This document contains proprietary information that is protected by copyright. No part of this document may be photocopied, reproduced, or translated to another language without the prior written consent of Hewlett-Packard Company.

Microsoft®, Windows®, and Windows Vista™ are either trademarks or registered trademarks of Microsoft Corporation in the United States and/or other countries.

First Edition (September 2011)

Document Part Number: 626998-001

About this guide

This guide provides information on setting up the display, installing drivers, using the On-Screen Display menu, troubleshooting, and technical specifications.

 **WARNING!** Text set off in this manner indicates that failure to follow directions could result in bodily harm or loss of life.

 **CAUTION:** Text set off in this manner indicates that failure to follow directions could result in damage to equipment or loss of information.

 **NOTE:** Text set off in this manner provides important supplemental information.

Table of contents

1 Product features	1
HP Digital Signage touch models	1
Accessories	1
Optional accessories	2
2 Safety and maintenance guidelines	3
Important safety information	3
Maintenance guidelines	3
Cleaning the display	5
Shipping the display	5
3 Setting up the display	6
Installing the stand (sold separately)	6
Connecting the speakers (sold separately)	9
Rotating to the portrait position	11
Using the remote control	12
Inserting the batteries	12
Identifying remote control buttons	13
Identifying display components	15
Display components	15
Display control panel	16
Display ports	17
VESA mounting support and security slot	17
Connecting to external devices	19
Connecting RGB	21
Connecting DisplayPort (480p/576p/720p/1080i/1080p)	22
Connecting HDMI (480p/576p/720p/1080i/1080p)	22
Connecting LAN	24
Connecting the USB (Universal Serial Bus) cable	25
Connecting daisy chain displays	25
4 Operating the display	27
Software and utilities	27
The information file	27
The image color matching file	27
Installing the .INF and .ICM files	28

Installing from the CD	28
Downloading from the Internet	28
Using the auto-adjustment function (RGB INPUT source only)	29
Using the On-Screen Display menu	29
Using the remote control to adjust the OSD	30
OSD menu selections	31
Selecting an Aspect Ratio	36
Adjusting the timer function	36
Clock	36
On Time and Off Time	37
Sleep Timer	37
Auto Off	38
Power On Delay	38
Using Key Lock	38
Using ISM Method	39
Using Tile Mode	39
5 Operating the touch screen	41
Plug and play (Microsoft Windows 7 and Windows Vista)	41
Touch software installation for Microsoft Windows XP	41
Installing the software from the CD	41
Installing the software from the Internet	42
Calibrating the touch screen in Windows Vista and Windows 7	42
Calibrating the Touch Screen Using MultiTouch Platform in Windows XP	42
Customizing the touch screen	43
Using the touch keyboard and writing tab	43
Finger operation	43
Upgrading the firmware	44
6 Multi-Display touch screen setup	45
7 Using the HP Media Sign Player	46
Using Photo List	46
Using Music List	47
Using Movie List	48
Appendix A Troubleshooting	50
Solving common problems	50
Using the Internet	52
Preparing to call technical support	52

Appendix B Technical specifications	53
HP Digital Signage Display	53
HP LD4220tm dimensions (with optional stand and speakers)	55
HP LD4720tm dimensions (with optional stand and speakers)	56
Recognizing preset display resolutions	57
Preset display modes	57
DTV mode	57
Power indicator	58
 Appendix C Command reference	 59
Connecting the cable	59
RS-232-C configurations	59
Communication parameter	60
Command reference list	60
Transmission/Receiving Protocol	61
01. Power (Command: a)	62
02. Input Select (Command: b) (Main Picture Input)	64
03. Aspect Ratio (Command: c) (Main picture format)	65
04. Screen Mute (Command: d)	65
05. Volume Mute (Command: e)	66
06. Volume Control (Command: f)	66
07. Contrast (Command: g)	67
08. Brightness (Command: h)	68
09. Color (Command: i) (Video Timing only)	68
10. Tint (Command: j) (Video Timing only)	69
11. Sharpness (Command: k) (Video Timing only)	70
12. OSD Select (Command: l)	71
13. Remote Lock/Key Lock (Command: m)	71
14. Balance (Command: t)	72
15. Color Temperature (Command: u)	72
16. Abnormal state (Command: z)	73
17. ISM Method (Command: j p)	73
18. Auto Configure (Command: j u)	74
19. Key (Command: m c)	74
20. Tile Mode (Command: d d)	75
21. Tile H Position (Command: d e)	75
22. Tile V Position (Command: d f)	75
23. Tile H Size (Command: d g)	76
24. Tile V Size (Command: d h)	76
25. Tile ID Set (Command: d i)	77
26. Natural Mode (In Tile Mode) (Command: d j)	77

27. Picture Mode (Command: d x)	78
28. Sound Mode (Command: d y)	78
29. Fan Fault check (Command: d w)	79
30. Elapsed time return (Command: d l)	79
31. Temperature value (Command: d n)	80
32. Lamp fault Check (Command: d p)	80
33. Auto volume (Command: d u)	81
34. Speaker (Command: d v)	82
35. Time (Command: f a)	82
36. On Timer (On/Off Timer) Time (Command: f d)	83
37. Off Timer (On/Off Timer) Time (Command: f e)	84
38. Scheduling Input select (Command: f u) (Main Picture Input)	85
39. Sleep Time (Command: f f)	85
40. Auto Off (Command: f g)	86
41. Power On Delay (Command: f h)	86
42. Language (Command: f i)	87
43. DPM Select (Command: f j)	88
44. Reset (Command: f k)	88
45. Energy saving (Command: f l)	88
46. Power Indicator (Command: f o)	89
47. Serial no. Check (Command: f y)	89
48. S/W Version (Command: f z)	90
49. Input Select (Command: x b)	90
IR codes	91
Remote Control IR Code	91
Output waveform	91
Configuration of frame	91
Lead code	91
Repeat code	91
Bit description	91
Frame interval: Tf	92
IR Codes Table	92
Appendix D Agency regulatory notices	94
Federal Communications Commission notice	94
Modifications	94
Cables	94
Declaration of Conformity for products marked with the FCC logo (United States only)	94
Canadian notice	95
Avis Canadien	95
European Union regulatory notice	95

German ergonomics notice	96
Japanese notice	96
Korean notice	96
Power cord set requirements	96
Japanese power cord requirements	96
Product environmental notices	97
Materials disposal	97
Disposal of waste equipment by users in private households in the European Union	97
Chemical substances	97
HP recycling program	97
Restriction of Hazardous Substances (RoHS)	97
Turkey EEE regulation	98
Ukraine Restriction of Hazardous Substances	98

1 Product features

HP Digital Signage touch models

The HP LCD digital signage displays have a wide-aspect active matrix thin-film transistor (TFT) panel. The displays features include the following:

- HP LD4220tm model, 106.7 cm (42-inch diagonal) widescreen viewable area display with 1920 x 1080 native resolution
- HP LD4720tm model, 119.28 cm (47-inch diagonal) widescreen viewable area display with 1920 x 1080 native resolution
- Landscape and portrait wall mounting positions
- Video inputs support DisplayPort In/Out, HDMI In, RGB In/Out, and RS-232-C In/Out signal inputs
- Audio input jack and external speaker ports
- LAN port for remote display control and controlling the HP Media Sign Player
- HP Media Sign Player—Play image, video, and music files from a USB storage device; define play list, timing options, and scheduling
- USB port for the HP Media Sign Player
- USB cable provided to connect the monitor and computer for touch driver functions
- On-Screen Display (OSD) menu in several languages for ease of setup and screen optimization
- Screen adjustment buttons (Power On/Off, AUTO/SET, OSD Controls, MENU, and INPUT) on the back of the display
- User controls to adjust Picture, Tile Mode, Timer, Energy Saving, Aspect Ratio, Audio, and additional setup options
- Plug and play capability if supported by the system
- Security cable provision on rear panel to lock down the display and help prevent theft
- Support VESA compliant mounting interface with 600 x 400 mm (23.62 x 15.75 in) hole pattern for the HP LD4220tm model and 800 x 400 mm (31.50 x 15.75 in) hole pattern for the HP LD4720tm model

Accessories

- Software and documentation CD
- Remote control
- Power cord
- DisplayPort cable
- HDMI cable

- RGB (VGA) cable
- USB cable for touch functionality

Optional accessories

Optional accessories (purchased separately) might vary depending on the model.

- Stand kit
- Speakers kit
- Wall mount kit

2 Safety and maintenance guidelines

Important safety information

A power cord is included with the display. If another cord is used, use only a power source and connection appropriate for this display. For information on the correct power cord set to use with the display, refer to the [Power cord set requirements on page 96](#).

⚠ WARNING! To reduce the risk of electric shock or damage to the equipment:

- Do not disable the power cord grounding feature. The grounding plug is an important safety feature.
- Plug the power cord in a grounded (earthed) outlet that is easily accessible at all times.
- Disconnect power from the product by unplugging the power cord from the electrical outlet.

For your safety, do not place anything on power cords or cables. Arrange them so that no one can accidentally step on or trip over them. Do not pull on a cord or cable. When unplugging from the electrical outlet, grasp the cord by the plug.

To reduce the risk of serious injury, read the *Safety and Comfort Guide*. It describes proper workstation, setup, posture, and health and work habits for computer users, and provides important electrical and mechanical safety information. This guide is located on the Web at www.hp.com/ergo and/or on the documentation CD, if one is included with the display.

⚠ CAUTION: For the protection of the display, as well as the media player/computer, connect all power cords for the media player/computer and its peripheral devices (such as a display, printer, scanner) to some form of surge protection device such as a power strip or Uninterruptible Power Supply (UPS). Not all power strips provide surge protection; the power strips must be specifically labeled as having this ability. Use a power strip whose manufacturer offers a Damage Replacement Policy so you can replace the equipment, if surge protection fails.

Use the appropriate and correctly sized furniture designed to properly support your display.

⚠ WARNING! Displays that are inappropriately situated on dressers, bookcases, shelves, desks, speakers, chests, or carts can fall over and cause personal injury.

Care should be taken to route all cords and cables connected to the display so that they cannot be pulled, grabbed, or tripped over.

⚠ CAUTION: Do not place the device in a location where water may drip and/or splash on the device.

Do not place an object that contains water, such as a flower vase, on the device.

Maintenance guidelines

To enhance the performance and extend the life of the display:

- Do not open the display cabinet or attempt to service this product yourself. Adjust only those controls that are covered in the operating instructions. If the display is not operating properly or has been dropped or damaged, contact an authorized HP dealer, reseller, or service provider.
- Use only a power source and connection appropriate for this display, as indicated on the label/back plate of the display.

- Be sure the total ampere rating of the products connected to the outlet does not exceed the current rating of the electrical outlet, and the total ampere rating of the products connected to the cord does not exceed the rating of the cord. Look on the power label to determine the ampere rating (AMPS or A) for each device.
- Install the display near an outlet that you can easily reach. Disconnect the display by grasping the plug firmly and pulling it from the outlet. Never disconnect the display by pulling the cord.
- Turn the display off when not in use. You can substantially increase the life expectancy of the display by using a screen saver program and turning off the display when not in use.

 **CAUTION:** Burn-in or image sticking might occur on displays which display the same static image on the screen for prolonged periods of time. To avoid burn-in or image sticking and to prolong the life of the display, you should activate one of the four ISM selections in the OSD, activate a screen-saver application, periodically cycle between static information and moving images, or turn off the display when it is not in use for prolonged periods of time.

- Slots and openings in the cabinet are provided for ventilation. These openings must not be blocked or covered. Never push objects of any kind into cabinet slots or other openings.
- Do not drop the display or place it on an unstable surface.
- Do not allow anything to rest on the power cord. Do not walk on the cord.
- Keep the display in a well-ventilated area, away from excessive light, heat or moisture.
- When removing the display base, you must lay the display face down on a soft area to prevent it from getting scratched, defaced, or broken.

Cleaning the display

1. Turn off the display and unplug the power cord from the back of the unit.
2. Dust the display by wiping the screen and the cabinet with a soft, clean antistatic cloth.
3. For more difficult cleaning situations, use a 50/50 mix of water and Isopropyl alcohol.

 **CAUTION:** Spray the cleaner onto a cloth and use the damp cloth to gently wipe the screen surface. Never spray the cleaner directly on the screen surface. It might seep behind the bezel and damage the electronics.

CAUTION: To clean the display screen or cabinet, do not use cleaners that contain any petroleum-based materials such as benzene or thinner or any volatile substance. These chemicals might damage the display.

Shipping the display

Keep the original packing box in a storage area. You might need it later if you move or ship the display.

3 Setting up the display

To set up the display, ensure that the power is turned off to the display, media player/computer system, and other attached devices, and then follow the instructions below.

Installing the stand (sold separately)

1. Take the parts for the stand out of the box.
 - HP LD4220tm—Four screws M4 x 32 mm (1.26 in) and stand

Figure 3-1 HP LD4220tm—Stand accessory contents

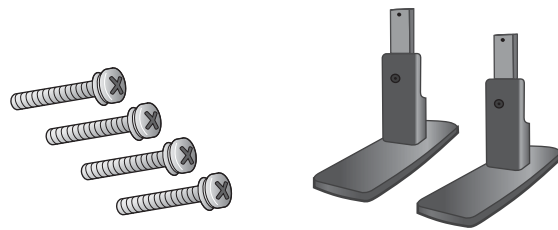

- HP LD4720tm—Four screws M4 x 10 mm (0.39 in) and stand

Figure 3-2 HP LD4720tm—Stand accessory contents

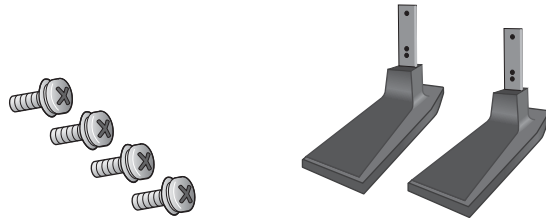

2. Place a soft cloth on the table and place the display with the screen facing downward. Connect the stand as shown in the following figure.

Figure 3-3 HP LD4220tm—Sliding the stand onto the display

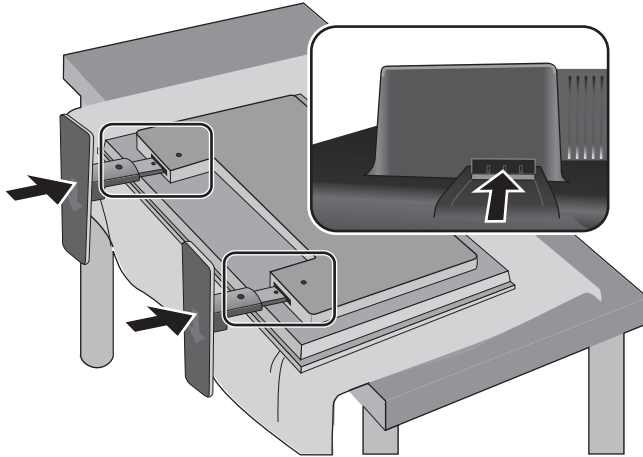
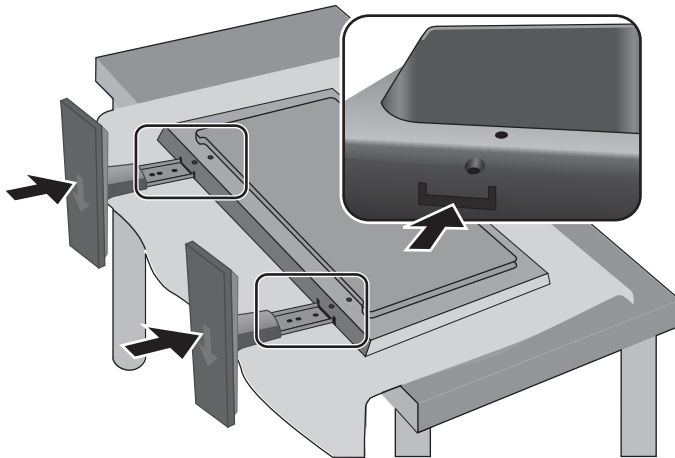

Figure 3-4 HP LD4720tm—Sliding the stand onto the display



3. Use the screws to secure the stand on the rear side of the product as shown in the figure.

Figure 3-5 HP LD4220tm—Securing the stand to the display

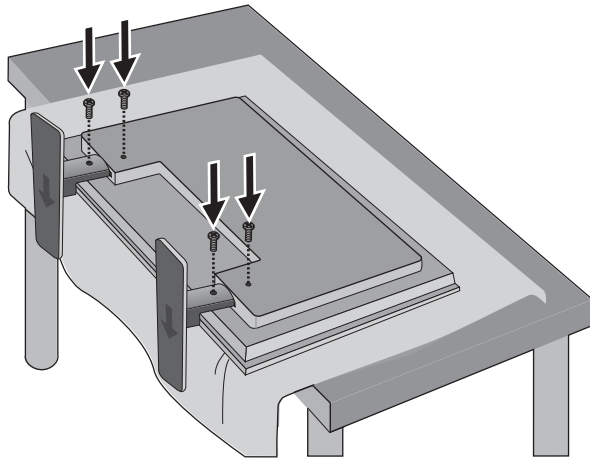
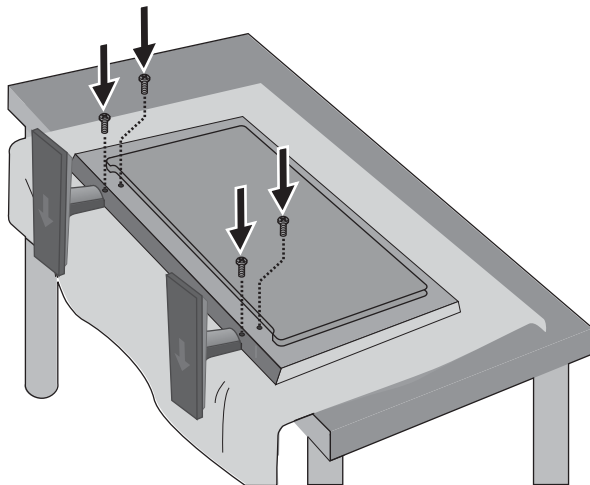

Figure 3-6 HP LD4720tm—Securing the stand to the display



Connecting the speakers (sold separately)

1. Mount the speakers onto the display.

Figure 3-7 Mounting the speakers

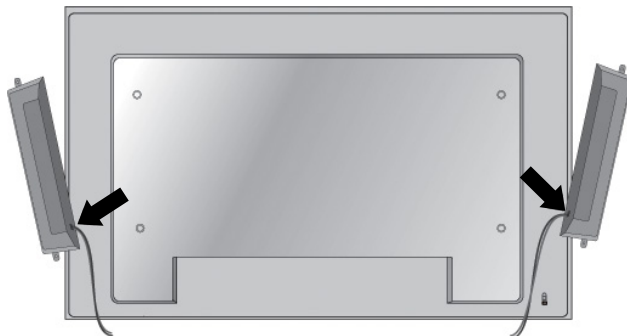

2. Use the four Taptite D3 x 12 mm (0.47 in) screws to secure the speakers to the display.

Figure 3-8 Securing the speakers to the display

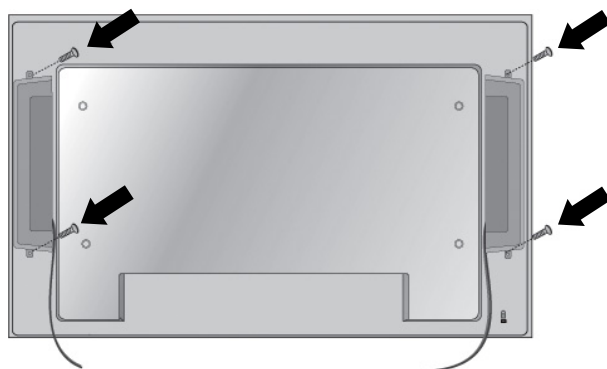

3. After installing the speakers, use the cable holders and cable ties (available on select models) to secure the speaker cables.

Figure 3-9 Using the cable holders (feature available on select models)

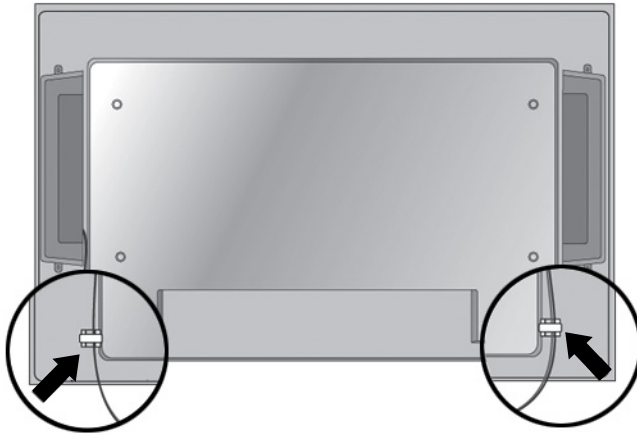
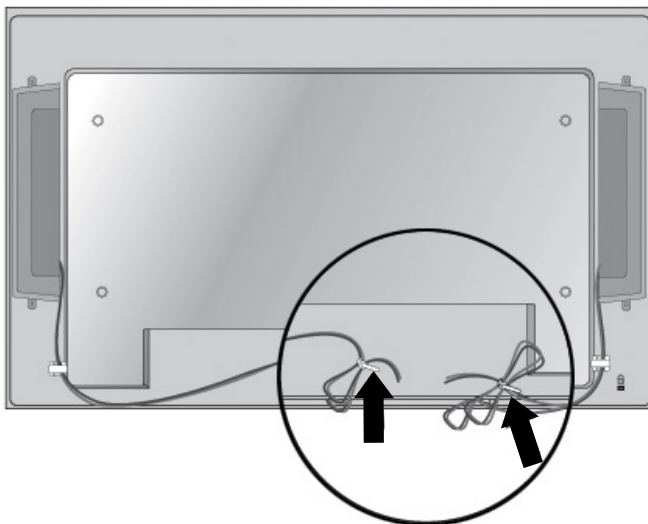
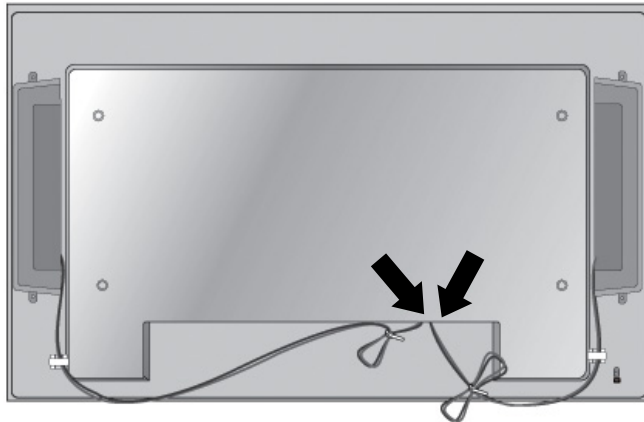

Figure 3-10 Using the cable ties (feature available on select models)



4. After installing the speakers, connect to the SPEAKER input terminal by connecting the proper color match for the left and right speakers.

Figure 3-11 Connecting to the input terminal



Rotating to the portrait position

When installing the display in the portrait position, rotate it clockwise based on its front. The display can be rotated in only one direction.



 **NOTE:** The display cannot be rotated if it is installed on the stand.

Figure 3-12 Installing portrait

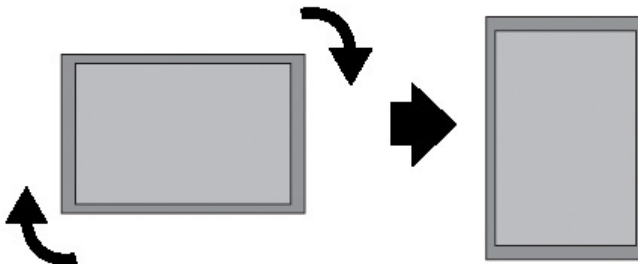

 **NOTE:** The LED indicator light orientation is on the bottom-right corner in the landscape position and on the bottom-left corner when rotated to the portrait position.

Using the remote control

Inserting the batteries

1. Slide off the battery cover.
2. Insert the batteries with correct polarity (+/-).
3. Close the battery cover.



NOTE: To prevent environmental pollution, dispose of used batteries in accordance with your local recycling guidelines.

Figure 3-13 Inserting batteries

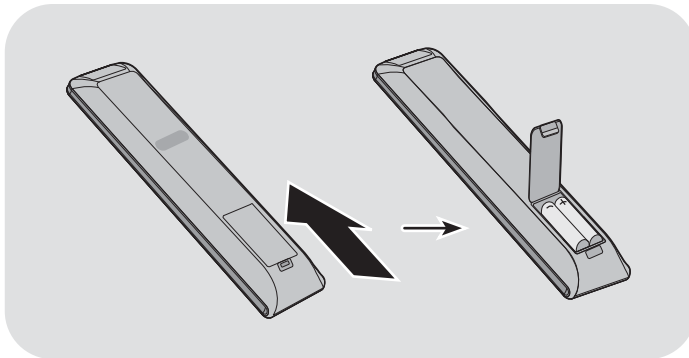

Identifying remote control buttons

Figure 3-14 Remote control buttons

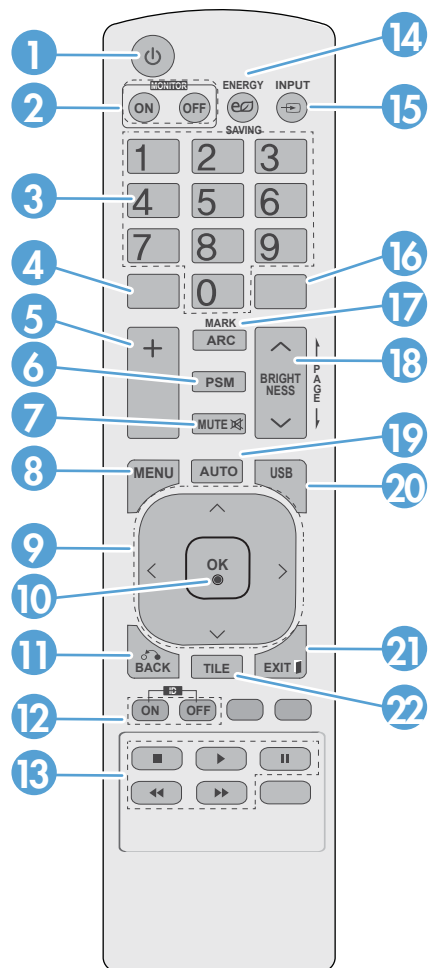

Component	Function	
1	Power on/off	Turns the display on from standby or off to standby
2	MONITOR ON or OFF	Turns the display on and off
3	Number	Types numbers
4		Not supported
5	Volume up (+) or down (-)	Adjusts the volume
6	PSM	Selects the Picture Status Mode
7	MUTE	Turns the sound on or off
8	MENU	Selects a menu or clears all on-screen displays and returns to display viewing from any menu
9	Up/down/left/right arrows	Allows navigation of the On-Screen Display menus and adjustment of the system settings
10	OK	Accepts a selection or displays the current mode

Component	Function
11	BACK Navigates one step back in an interactive application
12	ID ON or OFF Enables the display lock
13	USB menu control buttons Use with the HP Media Sign Player option lists in the USB menu
14	ENERGY SAVING Adjusts the Energy Saving mode
15	INPUT Opens the Input Source menu options (RGB , HDMI/DVI , and DisplayPort)
16	Not supported
17	ARC Selects the Aspect Ratio converter mode
18	BRIGHTNESS Adjusts the resolution and brightness by pressing the Up and Down buttons on the remote control In USB mode, the OSD menu uses the Page function of the BRIGHTNESS button to move to the next file list.
19	AUTO Automatically adjusts picture position and minimizes image instability (RGB input only)
20	USB Selects USB menu to control HP Media Sign Player
21	EXIT Clears all on-screen displays and returns to display viewing from any menu
22	TILE Selects the TILE Mode

Identifying display components

The components of the display and their functions are identified in the following sections.

Display components

Figure 3-15 HP LD4220tm—Display components

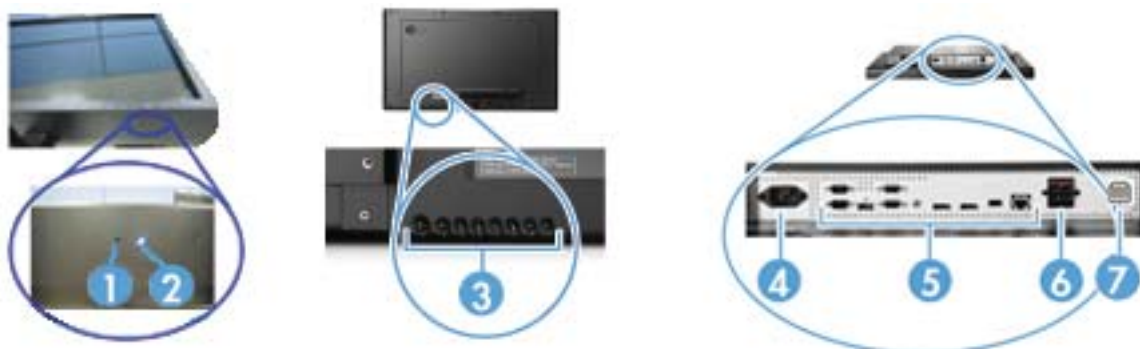

Figure 3-16 HP LD4720tm—Display components



Component	Function
1 IR receiver	Receives signals from the remote control
2 LED indicator light	Light is blue when display is on, amber when display is in power saving mode
3 Display control buttons	Power and OSD control buttons
4 Power cord receptacle	Power cord receptacle to connect the display to an electrical outlet
5 Display signal ports	RGB IN/OUT, HDMI/DVI, RS-232-C IN/OUT, Audio IN, DisplayPort IN/OUT, USB, LAN
6 External speaker connections	Connections for external speakers
7 Touch port	Connects the monitor and PC with a USB cable

Display control panel

Figure 3-17 HP LD4220tm—Display control panel

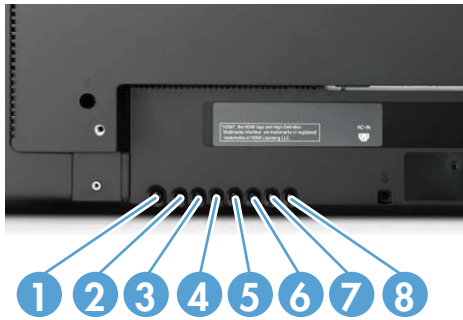
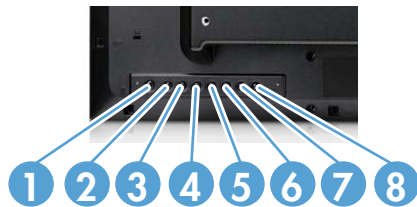

Figure 3-18 HP LD4720tm—Display control panel



Component	Function
1 Power ON/OFF	Press to turn the power ON. Press again to turn it OFF.
2 AUTO/SET	When the OSD window is closed, the auto-adjustment feature to optimize the screen image is activated. When the OSD window is open, press to select a menu item or save changes.
3 OSD select/adjust button UP	Selects an OSD menu icon or adjusts the settings in the OSD screen. UP arrow ▲ adjusts up
4 OSD select/adjust button DOWN	Selects an OSD menu icon or adjusts the settings in the OSD screen. DOWN arrow ▼ adjusts down
5 OSD select/adjust button LEFT	Selects an OSD menu icon or adjusts the settings in the OSD screen. LEFT arrow ◀ adjusts left
6 OSD select/adjust button RIGHT	Selects an OSD menu icon or adjusts the settings in the OSD screen. RIGHT arrow ▶ adjusts right
7 MENU	Opens or closes the OSD (On-Screen Display) menu screen.
8 INPUT	Toggles between video inputs: <ul style="list-style-type: none"> • DisplayPort—Digital signal • HDMI/DVI—Digital signal • RGB—15-pin D-Sub analog signal (VGA)

Display ports

Figure 3-19 Display ports

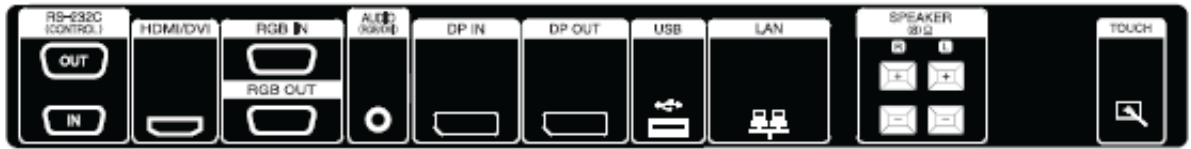

Component	Function
1	Power cord receptacle Power cord receptacle to connect the display to an electrical outlet.
2	RS-232-C (Control) serial ports RS-232-C (Control) serial ports connect to RS-232 devices.
3	HDMI/DVI, RGB IN, and RGB OUT HDMI supports High Definition (HD) input and HDCP (High-bandwidth Digital Content Protection). Some devices require HDCP in order to display HD signals. DVI input is supported with an HDMI to DVI signal cable (not included). RGB IN supports analog VGA connections from PCs. RGB OUT supports cloning connections with VGA cables from display to display.
4	AUDIO (RGB/DVI) AUDIO (RGB/DVI) connects the audio cable to the Line Out on the media player/ computer sound card. NOTE: Before connecting to the AUDIO (RGB/DVI) port on the display, verify what type of Audio Out connection is available on the media player/computer sound card. The Line Out on a media player/computer is used to connect to speakers, including a built-in amplifier (AMP). For additional instructions, refer to the sound card manual. If the Audio Out on the media player/computer sound card has only Speaker Out, reduce the media player/computer volume before connecting to the AUDIO (RGB/DVI) port on the display. If the Audio Out on the media player/computer sound card supports both Speaker Out and Line Out, choose Line Out.
5	DP IN and DP OUT (DisplayPort) DP IN supports digital input with DisplayPort cables from a media player/ computer. DP OUT supports cloning of connections with DisplayPort cables from display to display.
6	USB USB connects a USB storage device to the HP Media Sign Player.
7	LAN LAN connects the display directly to a media player/computer or to a network directly or indirectly by a router, hub, or switch using the LAN cable.
8	SPEAKER SPEAKER connects the external speakers to the display.
9	TOUCH Connects the display and the PC with USB cable.

VESA mounting support and security slot

VESA FDMI (Video Electronics Standards Association Flat Display Mounting Interface) wall mounting—This product supports a VESA FDMI-compliant mounting device. The mounting devices can be purchased separately from HP.

Security cable provision—To help prevent theft, a security cable provision is available on the rear of the display. The cable and lock required to connect to the display are available separately and can be purchased from HP.

Figure 3-20 VESA mounting holes

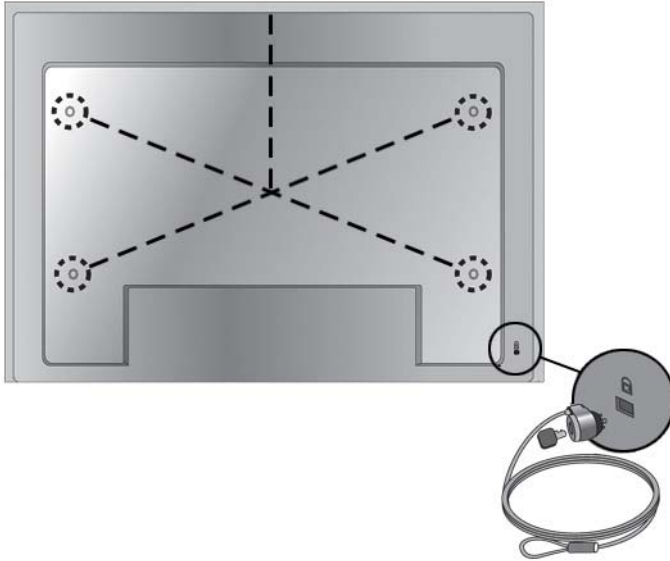

Connecting to external devices

1. Be sure that the display, media player/computer, and all attached devices are turned off.
2. Connect the signal input cable.

For additional information, refer to one of the following signal input cable sections:

- [Connecting RGB on page 21](#)
 - [Connecting DisplayPort \(480p/576p/720p/1080i/1080p\) on page 22](#)
 - [Connecting HDMI \(480p/576p/720p/1080i/1080p\) on page 22](#)
 - [Connecting LAN on page 24](#)
3. Connect the audio cable (sold separately) to the Audio (RGB/DVI) (1) connector on the rear of the display and the other end to the Line Out port (2) on the media player/computer if the video signal connection is from either a RGB (VGA) or DVI connector on the media player/computer.

Figure 3-21 Connecting the audio cable

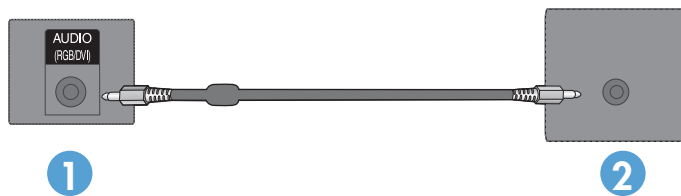

NOTE: The ferrite core can be used to reduce electromagnetic waves when connecting an audio cable. Fit the ferrite core to the audio cable. The ferrite core needs to be separated from the mold by 5 cm (2 in).

4. Connect the AC power cord to the AC-IN connector on the rear of the display and the other end to an electrical outlet. Before connecting the power cord, please read the power-cord safety precautions in the [Important safety information on page 3](#).

Figure 3-22 HP LD4220tm—Connecting the power cord

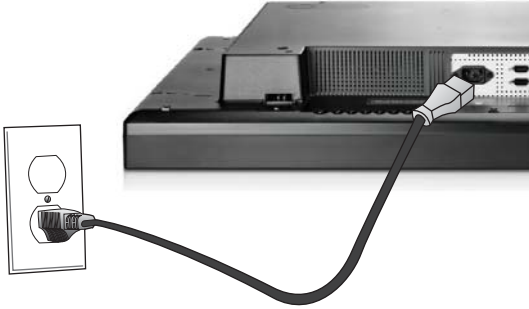

Figure 3-23 HP LD4720tm—Connecting the power cord



5. Turn on power to the display by pressing the power button (1).

Figure 3-24 HP LD4220tm—Power button



Figure 3-25 HP LD4720tm—Power button



6. Turn on the media player/computer.

7. Select an input signal:

Press the INPUT button on the remote control to open the **Input List**, select the appropriate input signal, and then press the OK button to save your change.

Or, press the INPUT button on the back of the display, select the appropriate input signal, and then press the AUTO/SET button to save your change.

- When connecting with a D-Sub (VGA) signal input cable, select **RGB** from the **Input List**.
- When connecting with an HDMI signal input cable or when connecting a DVI signal input cable with the HDMI to DVI cable, select **HDMI/DVI** from the **Input List**.
- When connecting with a DisplayPort signal input cable, select **DP** from the **Input List**.

 **NOTE:** If connecting more than one input source, connect the signal cables [HDMI/DVI, RGB (VGA), and DisplayPort] to each media player/computer. Press the INPUT button on the remote control to select the input to view.

Connecting RGB

1. For analog operation, connect the D-Sub signal cable to the RGB IN (1) connector on the rear of the display and the other end to the connector (2) on the media player/computer.

 **NOTE:** If connecting to a Mac media player/computer, use the standard Mac adapter (3)—not included.

Figure 3-26 Connecting the D-Sub signal cable



2. Connect the audio cable (sold separately) to the Audio (RGB/DVI) (1) connector on the rear of the display and the other end to the Line Out port (2) on the media player/computer if the video signal connection is from either a RGB (VGA) or DVI connector on the media player/computer.

Figure 3-27 Connecting the audio cable

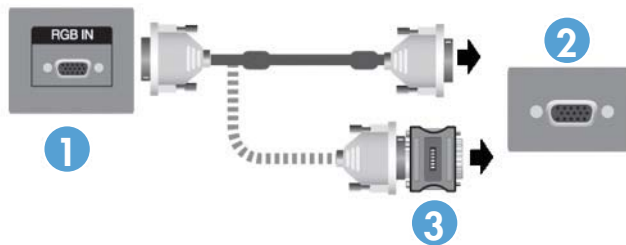

3. Select an input signal:

Press the INPUT button on the remote control, select the **RGB** input signal, and then press the OK button to save.

Or, press the INPUT button on the back of the display, select the **RGB** input signal, and then press the AUTO/SET button to save.

Connecting DisplayPort (480p/576p/720p/1080i/1080p)

1. Connect the DisplayPort cable to the DP IN port on the display and to the DisplayPort OUT port on the media player/computer, and then connect the display power cord.

Figure 3-28 Connecting DisplayPort input to a media player/computer

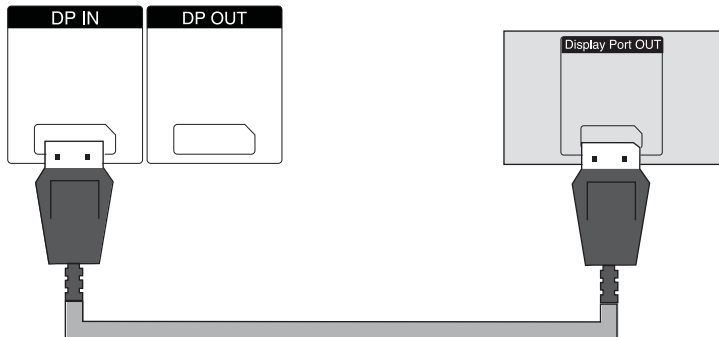

2. Select an input signal.

Press the **INPUT** button on the remote control, select the **DP** input signal, and then press the **OK** button to save.

Or, press the **INPUT** button on the back of the display, select the **DP** input signal from the Input List, and then press the **AUTO/SET** button to save.

Connecting HDMI (480p/576p/720p/1080i/1080p)

HDMI supports High Definition Input and HDCP. Some devices require HDCP in order to display HD signals.

1. Use one of the following examples to connect the HDMI input:
 - Connect an HDMI signal cable to the HDMI/DVI port on the display and to the HDMI port on the media player/computer, and then connect the display power cord.

Figure 3-29 Connecting the HDMI to HDMI signal cable

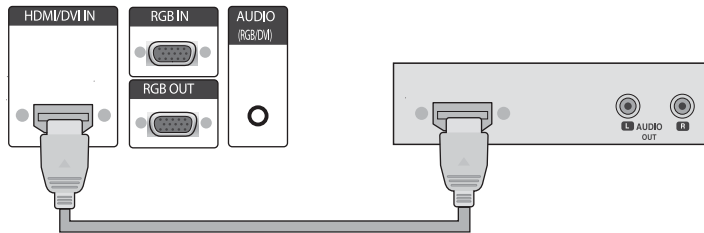

- Connect an HDMI to DVI signal cable to the HDMI/DVI port on the display, and then to the DVI port on the media player/computer.

For AUDIO input from the media player/computer (this is only needed with DVI input signal connections), connect the RCA-PC audio cable (cable not included) to the display and to the Audio OUT ports on the media player/computer, then connect the display power cord.

 **NOTE:** Use shielded signal interface cables (D-sub 15 pin cable, DVI cable) with ferrite cores to maintain standard compliance for this product.

Figure 3-30 Connecting the HDMI to DVI signal cable



2. Select an input signal.

Press the **INPUT** button on the remote control, select the **HDMI/DVI** input signal, and then press the **OK** button to save.

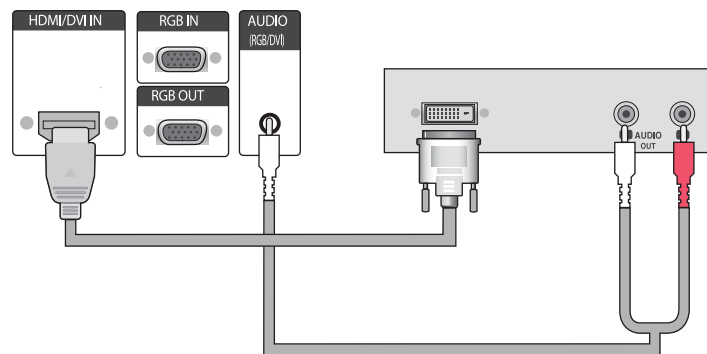
Or, press the **INPUT** button on the back of the display, select the **HDMI/DVI** input signal, and then press the **AUTO/SET** button to save.

Connecting LAN

The LAN input on the display can connect to a media player/computer, a router (switch), or an Intranet. A LAN connection with the display establishes communication between your media player/computer and the display. This enables the use of the HP Network Sign Manager program, running on the connected media player/computer, to assign an IP address to the display, to change display settings, and to set up HP Media Sign Player options, play lists, and On/Off schedule times.

1. Connect the LAN cable (not included) using one of the following connections:
 - Computer Direct Connection—Connect the LAN cable to the LAN port on the display and to the LAN port on the media player/computer (1).
 - Router—Connect the LAN cable to the LAN port on the display and to a LAN port on the router (2).
 - Intranet—Connect the LAN cable to the LAN port on the display and to the Intranet network via an access point (3).

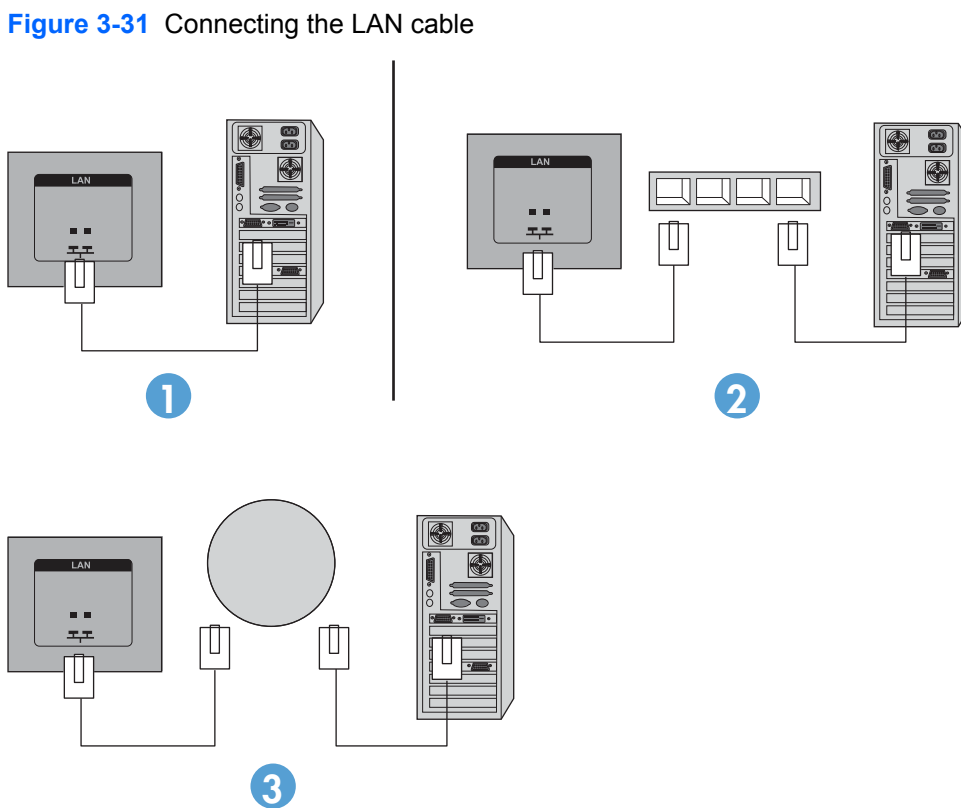

2. Install the HP Network Sign Manager on the media player/computer attached to the Intranet. To download the HP Network Sign Manager, refer to the website www.hp.com. For details on using the HP Network Sign Manager application, refer to the *HP Network Sign Manager User Guide* (available only in English) included on the CD provided with the display.

Connecting the USB (Universal Serial Bus) cable

Use the touch screen functionality by connecting the display and the media player/computer with a USB cable. Power on the media player/computer before connecting the USB cable.

Figure 3-32 Connecting the USB cable

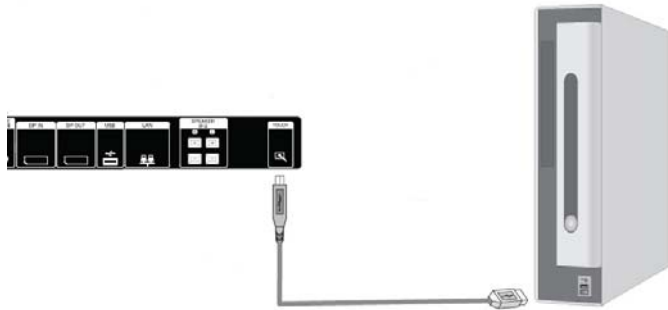

NOTE: The display's USB terminal supports USB 2.0 and full speed (12Mbps).

NOTE: When you connect the USB cable between the display and a media player/computer with Microsoft Windows 7 or Windows Vista operating systems, the Windows touch driver software will automatically install. Refer to [Operating the touch screen on page 41](#) for more information. Windows XP requires a driver.

Connecting daisy chain displays

Multiple displays (up to 25) can be connected in a daisy chain (connect several displays together in **Tile Mode**) to a computer using DisplayPort IN/OUT or with the combination of RGB IN/OUT and RS-232-C IN/OUT ports on the display.

To connect displays in a daisy chain, the displays must all be connected with the same input/output source (DisplayPort IN/OUT, RS-232-C IN/OUT, or RGB IN/OUT) as shown in the figures below.

- To daisy chain displays for video, use DisplayPort IN/OUT connections or RGB IN/OUT connections.
- To daisy chain for both video and display command and control, use DisplayPort IN/OUT plus RS-232-C IN/OUT or RGB IN/OUT plus RS-232-C IN/OUT.

NOTE: The number of displays that can be connected by daisy chain to one media player/computer might vary depending on the signal status and cable loss. If the signal status is good, and there is no cable loss, it is possible to connect up to twenty-five displays in a daisy chain from one media player/computer.

If you are going to play video that is copy protected with High-bandwidth Digital Content Protection (HDCP), a *maximum of six displays* can be daisy chained.

To connect multiple displays in a daisy chain, connect the input signal cable from the media player/computer to the first display in the daisy chain. Connect the subsequent displays, using the same input signal cables, from the OUT port to the IN port of the next display, as shown in the figures below, until all the displays are connected together.

Figure 3-33 Daisy chain connection—DisplayPort for video input signal

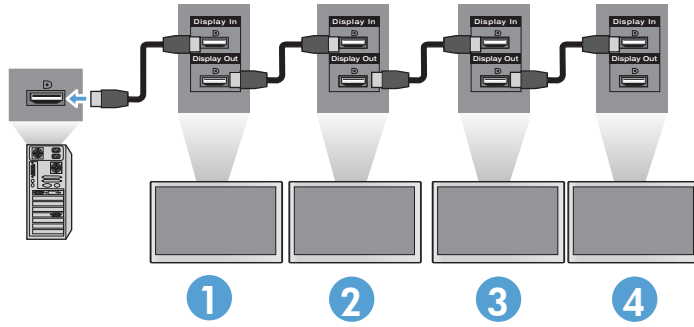

Figure 3-34 Daisy chain connection—RGB for video input signal

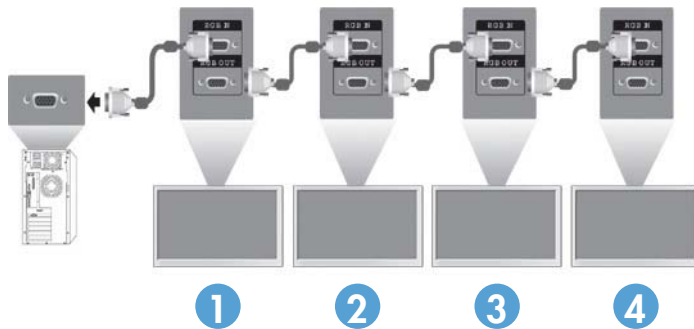
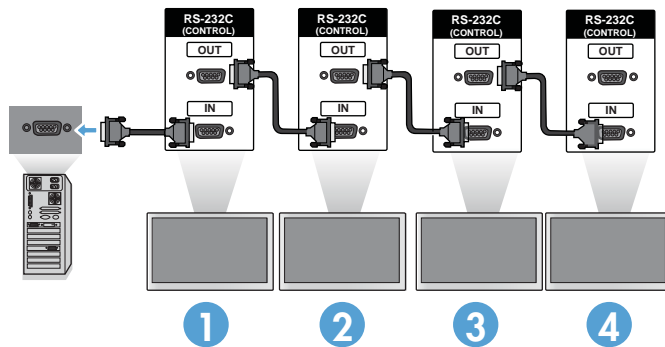

Figure 3-35 Daisy chain connection—RS-232-C



4 Operating the display

Software and utilities

HP displays are Plug-and-Play with Windows® XP, Windows Vista™, and Windows 7 operating systems, so you do not need to download the .INF file or the .ICM file for these operating systems. The most current versions of the following software and utilities can be downloaded from the following HP website for use with the displays as needed: www.hp.com.

- Auto-adjustment Pattern Utility—Optimizes the display.
- HP Network Sign Manager—Allows you to select and control the display options remotely from a connected media player/computer and allows you to select the options for the HP Media Sign Player. For more details on the HP Media Sign Player, refer to [Using the HP Media Sign Player on page 46](#). To install and configure the HP Network Sign Manager software, refer to the *HP Network Sign Manager User Guide* (available only in English) included on the CD provided with the display.
- Windows XP touch drivers (refer to [Operating the touch screen on page 41](#) for installation instructions)



NOTE: If the display does not include a CD, the .INF and .ICM files and touch drivers can be downloaded from the HP displays support website. Refer to [Downloading from the Internet on page 28](#).

The information file

The setup information, or .INF file, defines display resources used by Microsoft® Windows operating systems to ensure display compatibility with the media player/computer's graphics adapter.

The image color matching file

The image color matching, or .ICM file, is a color data file that is used in conjunction with graphics applications to provide consistent color matching from display screen to printer, or from scanner to the display screen. The .ICM file is only activated from within the graphics applications that support this feature.

Installing the .INF and .ICM files

You can install the .INF and .ICM files from the CD or download them from the HP displays support website.

Installing from the CD

To install the .INF and .ICM files on the media player/computer from the CD:

1. Insert the CD in the media player/computer CD-ROM drive. The CD menu appears.
2. View the **Display Driver Readme** file.
3. Select **Install display driver software**.
4. Follow the on-screen instructions.
5. Ensure that the proper resolution and refresh rates appear in the Windows Display control panel.



NOTE: You might need to install the digitally signed display .INF and .ICM files manually from the CD in the event of an installation error. Refer to the *Display Driver Readme* file on the CD for instructions (in English only).

Downloading from the Internet

To download the latest version of .INF and .ICM files and touch drivers from the HP displays support website:

1. Refer to www.hp.com/support and select the country/region.
2. Follow the links for the display to the support page and download page.
3. Ensure the system meets the requirements.
4. Download the software by following the instructions.

Using the auto-adjustment function (RGB INPUT source only)

You can optimize the screen performance by using the **AUTO/SET** button on the display (AUTO button on the remote control) and the Auto-adjustment Pattern Utility software on the CD provided.

 **NOTE:** Do not use this procedure if the display is set to use a DisplayPort or HDMI/DVI input source.

If the display is using a PC analog signal input, this procedure can correct the following image quality conditions:







- Fuzzy or unclear focus
- Ghosting, streaking or shadowing effects
- Faint vertical bars
- Thin, horizontal scrolling lines
- An off-center picture

To use the auto-adjustment feature:

1. Allow the display to warm up for 20 minutes before adjusting.
2. Press the **AUTO/SET** button.
If the result is not satisfactory, continue with the procedure.
3. Insert the CD in the disc drive. The CD menu appears.
4. Select **Open auto-adjustment software**. The setup test pattern appears.
5. Press the **AUTO/SET** button to produce a stable, centered image.
6. Press the **ESC** key or any other key on the keyboard to exit the test pattern.

Using the On-Screen Display menu

The display settings can be adjusted from the On-Screen Display (OSD) menu.

Icon	Main menu	Function description
	Picture	Set or change Video characteristics such as aspect ratio, brightness, contrast, energy savings, picture mode, and screen options
	Audio	Set or change the audio options
	Time	Set or change the timer options
	Option	Set or change display options such as OSD language, network setup, led lights on/off, control button lock, power management, DDC-CI, and ISM Method
	Tile	Set or change the tile options
	USB	Set or change the USB options

Using the remote control to adjust the OSD

Use the OSD to adjust the screen image based on your viewing preferences. To access the OSD, do the following:

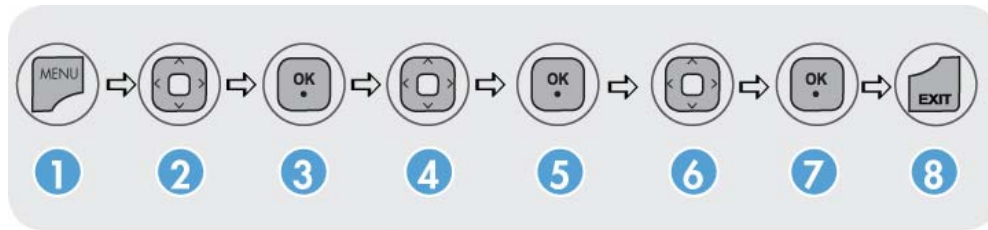

1. If the display is not already on, press the power button to turn on the display.
2. Press the MENU button (1) on the remote control.
3. To access a control, use the down arrow ▼ or up arrow ▲ button (2).
4. When the icon you want becomes highlighted, press the OK button (3).
5. To access a control, use the down arrow ▼ or up arrow ▲ button (4).
6. When the list you want becomes highlighted, press the OK button (5).
7. Use the down arrow ▼, up arrow ▲, left arrow ◀, or right arrow ▶ button (6) to set or change the selected item to the desired setting.
8. Accept the changes by pressing the OK button (7).
9. Exit the OSD menu by pressing the EXIT button (8).



OSD menu selections



The following table lists the On-Screen Display (OSD) menu selections and their functional descriptions.

Icon	Main menu	Submenu	Description
	PICTURE	Aspect Ratio	<p>Selects from the following screen image sizes:</p> <ul style="list-style-type: none"> • 16:9—Widescreen mode. • 1:1—Picture format is 1:1 aspect ratio. • Just Scan—Allows you to enjoy the transmitted data fully without any images cut off. (This menu is activated only in 720P, 1080P, 1080i (HDMI/DVI-DTV, DisplayPort-DTV).) • Original—Picture format is automatically set to 16:9 or 4:3 aspect ratio according to input signal. • 4:3—Picture format is 4:3 aspect ratio. • 14:9—Programs are viewed normally in 14:9 with black bars added to the top and bottom. The 4:3 programs are magnified on the top/bottom and left/right sides. • Zoom—4:3 programs are magnified until they fill the 16:9 screen. The top and bottom will be cut off. • Cinema Zoom 1—Picture format is 2.35:1 aspect ratio, extending the picture horizontally with black bars added to the top and bottom.
		Energy Saving	<p>Select from the following screen brightness levels:</p> <ul style="list-style-type: none"> • Off—100% light • Level 1—80% light • Level 2—60% light • Level 3—40% light
		Picture Mode	<p>Select from the following screen presets:</p> <ul style="list-style-type: none"> • Vivid—Select to display with brightest image. • Standard—The most general and natural screen display status. • Cinema—Lowers brightness by one level. • Sport—Displays with a soft image. • Game—To enjoy dynamic image when playing a game. • Expert 1 and Expert 2—Allows user-defined settings: <ul style="list-style-type: none"> ◦ Backlight—Controls the brightness of the screen, adjust the brightness of the LCD panel. ◦ Contrast—Adjusts the difference between the light and dark levels. ◦ Brightness—Adjusts the brightness of the screen. ◦ Sharpness—Adjusts the clearness of the image.

Icon	Main menu	Submenu	Description
			<ul style="list-style-type: none"> ◦ Color—Adjusts the color to desired level. ◦ Tint—Adjusts the tint to a desired level. <p>NOTE: If the Picture Mode setting is set to Vivid, Standard, Cinema, Sport, or Game, the above adjustments will be automatically set to predefined settings.</p>
		Advanced Control	<p>Select from the following screen color adjustment settings:</p> <ul style="list-style-type: none"> • Color Temperature—Select from the following color settings: <ul style="list-style-type: none"> ◦ Cool—Slightly purplish white. ◦ Medium—Slightly bluish white. ◦ Warm—Slightly reddish white. • Dynamic Contrast—Optimizes the contrast automatically according to the brightness of the reflection. • Dynamic Color—Adjusts the color of the reflection automatically to reproduce natural colors as close as possible. • Noise Reduction—Removes the noise up to the point where it does not damage the original picture. • Gamma—Set your own gamma value. On the display, high gamma values display whitish images and low gamma values display high contrast images. • Black Level—Adjusts the contrast and the brightness of the screen using the black level of the screen for HDMI/ DVI and DP input source only. <ul style="list-style-type: none"> ◦ Low—The reflection of the screen gets darker. ◦ High—The reflection of the screen gets brighter. • Film Mode—Adjusts the display, when watching a movie, to the best picture appearance.

Icon	Main menu	Submenu	Description
		Expert 1 and Expert 2 Control	<p>Select from the following settings:</p> <ul style="list-style-type: none"> • Dynamic Contrast—Optimizes the contrast automatically according to the brightness of the reflection. • Noise Reduction—Removes the noise up to the point where it does not damage the original picture. • Gamma—Set your own gamma value. On the display, high gamma values display whitish images and low gamma values display high contrast images. • Black Level—Adjusts the contrast and the brightness of the screen using the black level of the screen. • Film Mode—Adjusts the display, when watching a movie, to the best picture appearance. • Color Standard—Adjusts color. • White Balance—Adjusts the overall color of the screen to the feeling you want. • Color Management System—Adjusts by using test patterns. This does not affect other colors but can be used to selectively adjust the 6 color areas (Red/ Green/ Blue/Cyan/Magenta/Yellow). Color difference might not be distinctive even when you make the adjustments for a general video.
		Picture Reset	Returns the Picture Mode to the default factory settings.
	AUDIO	Auto Volume	<p>Adjusts uneven sound volumes across all channels or signals automatically to the most appropriate level.</p> <p>To use this feature, select On; to turn off the feature, select Off.</p>
		Clear Voice II	<p>Differentiates the human sound range from other sounds, which helps to make the human voices easier to hear.</p> <p>To use this feature, select On; to turn off the feature, select Off.</p>
		Balance	Balances sound between the left and right speakers.
		Sound Mode	<p>Automatically selects the best sound tone quality, depending on the video type that you are currently watching, from the following options:</p> <ul style="list-style-type: none"> • Standard—Most commanding and natural audio. • Music—Select for original sound when listening to music. • Cinema—Select for sublime sound. • Sport—Select for sports broadcasting. • Game—Select for dynamic sound when playing a game.
		Treble	Adjust treble 0–100.
		Bass	Adjust bass 0–100.
		Reset	Resets the Sound Mode to the factory default settings.

Icon	Main menu	Submenu	Description
		Speaker	Adjusts internal speaker status (speakers sold separately). To use this feature, select On ; to turn off the feature, select Off . To use an external hi-fi stereo system, turn off the internal speakers of the display.
		DisplayPort Audio Out	Select DisplayPort or Analog .
	TIME	Clock	Resets the Day , Hour , and Minute if the current time is incorrect.
		On Time	The on time automatically switches the display on at the pre-set time.
		Off Time	The off time automatically switches the display to standby at the pre-set time.
		Sleep Timer	Automatically turns off power when the time set by a user has passed.
		Auto Off	If active and there is no input signal, the display switches to off mode automatically after 10 minutes.
		Power On Delay	When connecting multiple displays and turning the power on, the displays are turned on individually to prevent overload.
	OPTION	Language	Selects the language in which the OSD menu is displayed.
		Input Label	Selects a label for each input source.
		Key Lock	Set On to disable the display buttons to prevent tampering with display settings. When set to On , the display options and settings can be set or changed only with the remote control or with HP Network Sign Manager.
		Set ID	Use to assign a unique Set ID NO (name assignment) to each product when several products are connected for display.
		ISM Method	This option allows setting the display to alter the image to avoid a static image being on the screen for a prolonged period of time. This can avoid burn-in or image sticking and prolong the life of the display.
		DPM Select	Display Power Management Select—Turns the power saving mode On or Off .
		Power Indicator	Sets the power indicator on the front of the display to On or Off .
		DDC-CI	Set this feature On to enable sending display OSD commands via RS-232-C connection from the media player/computer.
		DFC	Digital Fine Contrast—To use this feature, select On ; to turn off the feature, select Off .
		Interface Select	Select the connection you are using for remote display management. For more information, refer to the <i>HP Network Sign Manager User Guide</i> (available in English only) included on the CD provided with the display.

Icon	Main menu	Submenu	Description
		Network Setup	<p>Select the method of assigning an IP address to the display.</p> <p>IP Mode options:</p> <ul style="list-style-type: none"> • DHCP—Allows the display IP Address to be assigned automatically when the display is attached to the network through a router. • Manual—Allows you to assign the IP Address, Subnet Mask, Gateway, and DNS Server. <p>See your network administrator for the correct manual entries to enter. For more details on setting the display IP Address, refer to the <i>HP Network Sign Manager User Guide</i> (available in English only) included on the CD provided with the display.</p>
		Information	Contains the Serial No. , SW Version (MNT) , SW Version (LAN) , IP Address , and MAC Address information.
		Factory Reset	Resets to the default factory settings.
	TILE	Tile Mode	<p>Tile Mode is used when multiple displays are configured in a video wall and you want the image to be displayed on the entire video wall, with each display showing its part of the total image on the video wall.</p> <p>To use Tile Mode, the multiple displays must be connected with RGB IN/RGB OUT or DP IN/DP OUT. If you want to issue commands to the displays in the wall with application software or with the HP Network Sign Manager connected through the serial interface, the displays must be connected with RS-232-C IN/OUT.</p> <p>For more information, refer to Using Tile Mode on page 39.</p>
		Tile ID	Selects the location of the Tile by setting an ID of 1–25.
		Natural Mode	Setting this feature ON will compensate for the mullions (non-viewing area between active viewing areas in the video wall where the display bezels meet) by stretching the image in each display in the video wall so that the image is extended into the non-viewing areas of the mullions. This eliminates image distortion and displays the image in its natural proportions across all displays.
		H Size	Adjusts the horizontal size of the screen taking into account the size of the bezel.
		V Size	Adjusts the vertical size of the screen taking into account the size of the bezel.
		H Position	Moves the screen position horizontally.
		V Position	Moves the screen position vertically.
		Reset	Resets the Tile Mode configuration.
	USB	Photo List	View photo files on a USB storage device.
		Music List	Play music files on a USB storage device.
		Movie List	Play movie files on a USB storage device.

Icon	Main menu	Submenu	Description
		Lock System	Enables the USB security function to prevent the playing of unauthorized files from a USB storage device with the HP Media Sign Player.
		Set Password	Allows you to set a password for the HP Media Sign Player. NOTE: All USB menu options are disabled until a correct password is entered. If you should forget your password, enter 7777 in the password field and that will take you to the Set Password menu to change the password. The default password is 0000. The master password is 7777.

 **NOTE:** Depending upon the input setting, input video signal, Picture Mode, and option settings, some OSD options might not be available to be set or changed, and these will appear greyed out in the OSD menus.

Selecting an Aspect Ratio

The aspect ratio modes available for your selection depend on the current input source. Use the following table to determine which mode is available for your display.

Mode ARC	DisplayPort DTV	DisplayPort PC	RGB PC	HDMI/ DVI DTV	HDMI/ DVI PC
16:9	X	X	X	X	X
Just Scan	X			X	
Original	X	X	X	X	X
4:3	X	X	X	X	X
1:1		X	X		X
14:9	X			X	
Zoom	X			X	
Cinema Zoom 1	X			X	

Adjusting the timer function

Use the remote control to set the following timer options.

Clock

The **Clock** menu allows you to reset the clock manually if the current time is incorrect.

1. Press the MENU button, and then use the down arrow ▼ or up arrow ▲ button to select the **TIME** menu.
2. Press the right arrow ► button, and then use the down arrow ▼ or up arrow ▲ button to select the **Clock** menu.

3. Press the right arrow ► button, and then use the down arrow ▼ or up arrow ▲ button to set the hour (00h–23h).
4. Press the right arrow ► button, and then use the down arrow ▼ or up arrow ▲ button to set the minutes (00–59 min).

On Time and Off Time

The **On Time** and **Off Time** menus let you set the display to automatically switch to standby at a pre-set time.

1. Press the MENU button, and then use the down arrow ▼ or up arrow ▲ button to select the **TIME** menu.
2. Press the right arrow ► button, and then use the down arrow ▼ or up arrow ▲ button to select **On Time** or **Off Time**.
3. Press the right arrow ► button, and then use the down arrow ▼ or up arrow ▲ button to set the hour (00h–23h).
4. Press the right arrow ► button, and then use the down arrow ▼ or up arrow ▲ button to set the minutes (00–59 min).
5. Press the right arrow ► button, and then use the down arrow ▼ or up arrow ▲ button to select **On** or **Off**.



NOTE: Once the **On Time** or **Off Time** is set, these functions operate daily at the preset time. The **Off Time** function overrides the **On Time** function if they are set to the same time. When the **On Time** is operated, the input screen is turned on just as it was turned off.

Sleep Timer

The **Sleep Timer** menu lets you set the display power to automatically turn off when the time set by a user has passed.

1. Press the **MENU** button, and then use the down arrow ▼ or up arrow ▲ button to select the **TIME** menu.
2. Press the right arrow ► button, and then use the down arrow ▼ or up arrow ▲ button to select the **Sleep Timer** menu.
3. Press the right arrow ► button, and then use the down arrow ▼ or up arrow ▲ button to set the hour (00h–23h).
4. Press the right arrow ► button, and then use the down arrow ▼ or up arrow ▲ button to set the minutes (00–59 min).



NOTE: In the event of a power interruption (disconnection or power failure), the **Sleep Timer** clock must be reset.

Auto Off

To set the display to switch to the off mode automatically after 15 minutes if **Auto Off** is active and there is no input signal:

1. Press the MENU button, and then use the down arrow ▼ or up arrow ▲ button to select the **TIME** menu.
2. Press the right arrow ► button, and then use the down arrow ▼ or up arrow ▲ button to select the **Auto Off** menu.
3. Press the right arrow ► button, and then use the down arrow ▼ or up arrow ▲ button to select **On** or **Off**.

Power On Delay

When connecting multiple displays and turning the power on, the displays are turned on individually to prevent overload.

Using Key Lock

The display can be set up to disable the display control buttons on the back of the display. When the **Key Lock** is set **ON**, display options might only be set or changed with the remote control or using the HP Network Sign Manager.

1. Press the MENU button, and then use the down arrow ▼ or up arrow ▲ button to select the **OPTION** menu.
2. Press the right arrow ► button, and then use the down arrow ▼ or up arrow ▲ button to select the **Key Lock** menu.
3. To lock the OSD screen adjustment, press the right arrow ► button, and then use the down arrow ▼ or up arrow ▲ button to select **On**.
4. To unlock the OSD screen adjustment, press the MENU button on the remote control, and then use the down arrow ▼ or up arrow ▲ button to select **Off**.

Using ISM Method

Displaying a static image on the screen for a prolonged period of time could result in burn-in or image sticking. To avoid burn-in or image sticking or to fix a ghost or burned-in image, do not display a fixed image for prolonged periods of time. Either turn the display off or change the image. If you display a static image for long periods of time, you can help to avoid ghost images or burn-in by using the ISM option as follows:

1. Press the MENU button, and then use the down arrow ▼ or up arrow ▲ button to select the **OPTION** menu.
2. Press the right arrow ► button, and then use the down arrow ▼ or up arrow ▲ button to select the **ISM Method** menu.
3. Select one of the following menu options:
 - **Normal**—Leave on **Normal** if you do not want the ISM function to be active. When the display is turned **OFF**, the ISM setting will be reset to **Normal**, regardless of which ISM mode was **ON** when the display was turned off.
 - **Orbiter**—The screen will move two pixels every two minutes, alternately moving left, right, up, and down. Orbiter will remain on until changed in the ISM menu.
 - **Inversion**—This function can be used to fix a ghost or burned-in image. This function will invert the image colors every 30 minutes. If the screen image is inverted and you enter the USB function, images displayed in this function will be inverted. The inversion function will remain on until changed in the ISM menu.
 - **White wash**—This function can also be used to fix a ghost or burned-in image. This function will fill the screen with solid white. This helps to remove permanent images burned into the screen. Pressing any key on the remote control will exit the **White Wash** function and return the screen to **Normal**.

Using Tile Mode

Tile Mode is used to extend an image across multiple displays in a video wall. You can define up to a 5 x 5 video wall and the displays can be in either landscape or portrait orientation. **Tile Mode** allows you to assign each display its relative position (number) in the wall starting at the upper-left corner and down each row from left to right. Each display will automatically show the corresponding part of the full image as shown in the following figure.

Assign the correct position number to each display as follows:

MENU→**PICTURE**→**TILE**→**Tile Mode**→**OK**→**3x3**→**Close**→**Tile ID**→**OK**→**1** (for display #1, 2 for display #2, etc. ... 9 for display #9)→**Close**→**Natural Mode**→**OK**→**ON** (compensate for the mullions to display an image without distortion across the video wall)→**OK**→**EXIT**

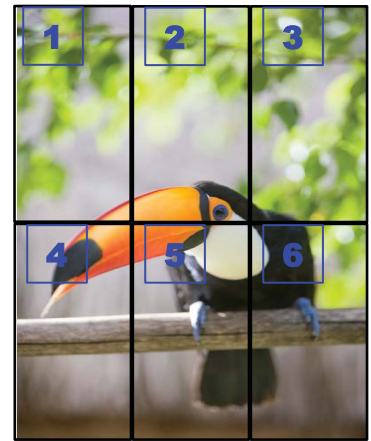
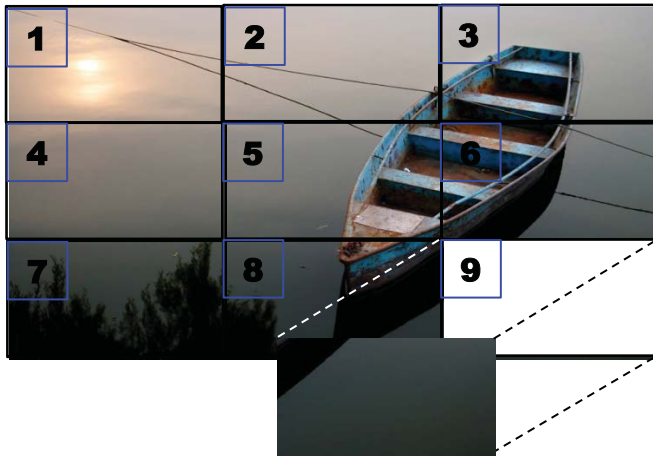

Each display must be connected to every other display, using either **RGB IN/RGB OUT** or **DP IN/DP OUT** as shown in the following figure. If you want to issue display commands from the media player/computer, you must connect each display with **RS-232-C IN/RS-232-C OUT** just like the video connections.

Figure 4-1 Tile Mode 3x3 video wall—Connecting displays with DP IN/DP OUT

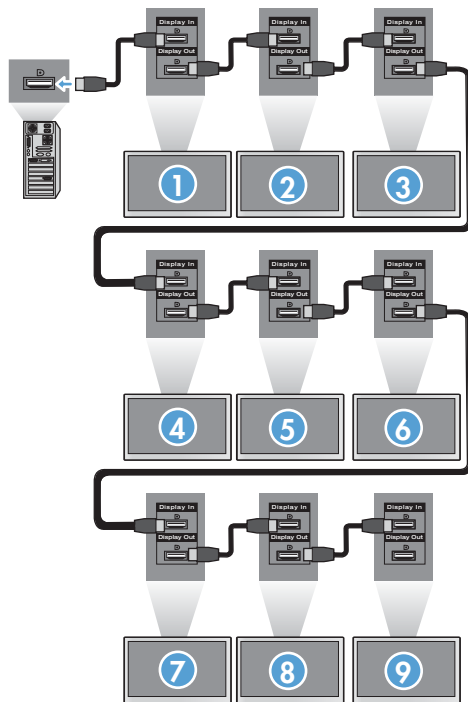

5 Operating the touch screen

Plug and play (Microsoft Windows 7 and Windows Vista)

When you connect the USB cable between the monitor and a computer with Microsoft Windows 7 and Windows Vista operating system, the Windows touch driver software will automatically install. The software may take a few minutes to install and a message will be displayed on the lower right corner of the screen indicating that the driver software has been installed successfully. Once you install the touch driver, you can select, launch, and drag objects using the touch screen. To make a selection, touch the screen. The touch driver installation program will not install drivers for Microsoft Windows Vista or Microsoft Windows 7 operating system. Microsoft plug-and-play touch drivers are already included in those operating systems for these monitors.



NOTE: Refer to [Connecting the USB \(Universal Serial Bus\) cable on page 25](#) for instructions on connecting the USB cable.

Touch software installation for Microsoft Windows XP

It is recommended that you install MultiTouch Platform software to achieve the best touch performance. HP recommends that you use a Dual Core 2.5GHz PC for best touch performance.

Installing the software from the CD

The CD that comes with digital signage displays contains files that you can install to communicate with the touch screen and use the touch screen with Windows applications.

To install the touch driver from the CD:

1. Insert the CD in the media player/computer.
2. Click **Install MultiTouch Platform**. To continue, click **Next** and follow the instructions on the screen to install the touch driver.
3. After setup has finished installing the touch driver, select **Yes** to restart and click **Finish**.
4. Connect the Touch screen display cable (USB) to your PC.

After installing the touch driver, connecting the USB cable, and restarting your computer, the **Found New Hardware Wizard** is displayed to complete the driver installation. To install the IR Touch Device Driver:

1. Select **Yes** and click **Next** to continue and follow the instructions on the screen.
2. If a Hardware Installation warning displays about the driver not passing Windows Logo testing, click **Continue Anyway**.
3. When prompted that files are needed from the IR Touch Controller Installation Disk, browse to the location of the file and click **OK**.
4. When the wizard finishes installing the software, click **Finish** to close the wizard.

To Uninstall the Touch Monitor driver:

1. Select **Start > Programs > MultiTouch Driver > Uninstall MultiTouch Driver**, then click **Yes** to confirm you want to remove the touch driver.
2. Click **Yes** to confirm you want to remove the touch driver.
3. Select **Start > Programs > MultiTouch Platform > Uninstall MultiTouch Platform**, then click **Yes** to confirm you want to remove the MultiTouch Platform.
4. Click **Yes** to confirm you want to remove the MultiTouch Platform.

Installing the software from the Internet

To install the touch driver from the Internet:

1. Got to <http://www.hp.com/support>.
2. Select your country/region.
3. Select your language.
4. Select **Download drivers and software (and firmware)** and enter you display model name and number.
5. Follow the instructions on the screen to download the **Setup.exe** file.
6. Open the file and follow the directions in the InstallShield Wizard to install the software.
7. To verify that the software installed, go to **Start > All Programs**, and ensure that the **MultiTouch Platform Software** folder appears in the Start menu.

Calibrating the touch screen in Windows Vista and Windows 7

It is not necessary to calibrate the touch screen when you initially begin using it. However, it may become necessary at some point. To calibrate the touch screen:

1. On the Windows 7 desktop, go to **Start > Control Panel > Hardware and Sound > Tablet PC Settings**.
2. On the Tablet PC Settings' **Display** tab, press the **Calibrate** button. The calibration window will be displayed.
3. On the calibration window, tap the crosshairs each time they appear in the corners of the screen. When complete, a dialog box will appear asking if you want to save the calibration data.
4. Select **Yes** on the dialog box to save the calibration data and close the calibration window.

Calibrating the Touch Screen Using MultiTouch Platform in Windows XP

If it becomes necessary to calibrate the touch screen after installing MultiTouch Platform software:

1. Go to **Start > All Programs > MultiTouch Platform > MultiTouch Platform** and select **Calibration**. The Calibration dialog will appear on the screen.
2. Press and hold the first black crosshairs as directed.

3. Release your finger after the black crosshair turns green.
4. Repeat step 2 for the other 3 crosshairs.

Customizing the touch screen

You can customize the touch settings in Microsoft Windows 7 to align with your personal preferences. For example, you can change the menus to appear on the right side or left side of the screen based on whether you write with your left hand or right hand by going to **Start > Control Panel > Hardware and Sound > Tablet PC Settings** and selecting the **Other** tab.

You can further customize the touch settings by going to **Start > Control Panel > Hardware and Sound > Pen and Touch**. The Pen and Touch dialog allows you to:

- adjust the settings for each pen action
- change navigational flick settings
- change settings for handwriting personalization
- adjust settings for each touch action
- adjust touch panning gestures

Using the touch keyboard and writing tab

You can input data into applications using either the touch keyboard or the writing tab on the Tablet PC Input Panel in Microsoft Windows 7. To open the Tablet PC Input Panel, go to **Start > All Programs > Accessories > Tablet PC > Tablet PC Input Panel**.

To switch between the touch keyboard and the writing tab, tap the **Touch Keyboard** button or the **Writing Tab** button in the upper left corner of the panel.

You can change the settings on the Tablet PC Input Panel by tapping the **Tools** button in the upper left corner of the Tablet PC Input Panel and selecting **Options**.

Finger operation

The touch function may replace the mouse after you start the Microsoft Windows operating system and introduce appropriate gesture judgement. Gesture judgement and related Windows software applications are listed below:

Finger Operation	Windows 7	Windows Vista	Windows XP
Drag	Y	Y	Y
Click	Y	Y	Y
Double-Click	Y	Y	Y
Single-touch Digitizer	Y	Y	N
Multi-touch Digitizer	Y	N	N

Use your finger or the provided stylus for touch applications.

 **NOTE:** The touch function may need about 7 seconds to resume if the USB cable is re-plugged or the computer resumes from sleep mode (suspend mode).

Upgrading the firmware

HP provides firmware upgrades so that your system can take advantage of the latest technology available. If you are encountering problems with your touch screen, try upgrading the firmware.

 **NOTE:** HP touch controller firmware upgrades may be limited depending on the operating system you are using.

 **CAUTION:** DO NOT terminate the USB Downloader program or power off your system during the firmware upgrade. Should power be lost during the firmware update, after the system reboots follow the steps below to restart the firmware download.

To upgrade the firmware:

1. Go to <http://www.hp.com/support>.
2. Select your region.
3. Select **Download drivers and software (and firmware)** and enter your display model number (HP LD4220tm or LD4720tm).

 **CAUTION:** Before proceeding to the next step, ensure that your display is connected to the media player/computer with the touch USB cable. The USB cable is required to enable the firmware upgrade.

4. Accept the default software driver language selection and select the operating system you are using.
5. Select **Firmware Updater**, and follow the directions on the screen.
6. When the **F/W Update Finished** message box appears, click **OK**.

 **NOTE:** It will take about 7–10 seconds after the firmware upgrade to be able to use touch screen functions. The wait time may vary depending on your media player/computer.

6 Multi-Display touch screen setup

Multi-display touch screen setup allows up to four displays connected to one media player/computer to be touch screen enabled.



NOTE: Multi-display touch screen setup is available only in Microsoft Windows 7 (Home Premium and above). It is not supported in any other operating system.

1. Click the Windows Start button and select **Control Panel**.
2. Select **Hardware and Sound**.
3. Select **Tablet PC Settings**.
4. On the **Display** tab under **Configure**, run **Setup**.
5. In the **Identify pen or touch input screens** window, select **Touch input**.
6. Touch screen #1 to match it to the Display. Then press **Enter** to move to the next screen.
7. Repeat step 6 for each additional screen.

HP recommends the following graphics cards for multi-display support.

- ATI Radeon HD 5450
- NVIDIA GeForce GT320
- NVIDIA GeForce 315
- NVIDIA GeForce G210
- ATI Radeon HD 4350
- NVIDIA GeForce G100
- ATI Radeon HD 4650
- NVIDIA GeForce 9300 GE
- NVIDIA Quadro NVS 450*

* Requires additional purchase of DisplayPort to HDMI adapter

7 Using the HP Media Sign Player

When you insert a USB storage device into the USB port in the back of the display, the **Enter Password** dialog box appears if you have the **Lock System** option turned **ON**. After entering your password, the HP Media Sign Player options appear with **Photo List**, **Music List**, and **Movie List**.

If the USB storage device is already inserted when you turn the power on to the display, press the USB button on the remote control and if you have the **Lock System** option **ON**, the **Enter Password** dialog box appears along with the **USB** menu options. After entering your password, you can set or change any of the **USB** options.

 **NOTE:** The **USB** menu will not be displayed by pressing the USB button on the remote control while the HP Media Sign Player is playing or while the OSD is active.

Using Photo List

After selecting the **Photo List** option, select the drive, and then select the folder with the desired .JPG images. A list of the files in the folder appears. If you select a folder which does not have supported files, the message **No Photo List in the Folder** appears. When you highlight a file, you can mark the file to play by pressing the MARK button on the remote control. If you highlight the file and then press the OK button for any file in the list, the **Photo selection and menu options** list appears.

Information about using Photo List

- PHOTO (*.JPEG) supporting file
- Baseline—15360 x 8640
- Progressive—1024 x 768
- You can view JPEG files only; non-supported files are displayed in the form of a bitmap.

Photo selection and menu options

- **View**—Starts the HP Media Sign Player. You will see the first image selected in the **Photo List** and the **Option** box. This image remains on the display until you select **Slideshow** in the **Option** box.
- **Mark All**—Marks all or selects all files in the selected folder from the **Photo List**.
- **Delete**—Deletes all the marked or selected files in the selected folder from the USB storage device. When you choose **Delete**, a verification dialog box appears to confirm that you want to delete the file.
- **Close**—Closes the **Photo selection and menu** options menu.

Options on full-sized photo view

- **Slideshow**—Starts the HP Media Sign Player. Only the files marked or selected are played unless there are no files marked, and then all files in the selected folder play in the order they appear in the **Photo List**. Set the time interval for all of the slides in the slide show in the **Options** dialog box.
- **BGM** (Background Music)—The HP Media Sign Player plays audio files while showing the selected images from the **Photo List**. Before selecting this option, you must select the **Music Folder for BGM** in the **Option** dialog box. For more details on audio files, refer to [Using Music List on page 47](#).
- **Rotate icon** —Use the rotate icon to change the orientation of the slide show 90° with each touch of the rotate icon (90°, 180°, or 270°) clockwise. When the image is rotated using the rotate icon, the image will be scaled to fill the screen, and any image not specifically created for a portrait viewing (90° or 270°) might be distorted or out of proportion in the rotated orientation.
- **Delete**—Deletes files from the USB storage device. A verification dialog box appears to confirm that you want to delete the file.
- **Option**—Sets values for the **Slide Speed** and the **Music Folder for BGM**. Use the down arrow ▼, up arrow ▲, left arrow ◀, or right arrow ▶ button and the OK button to set values. Press OK to save the settings. You cannot change the **Music Folder** while **BGM** is playing.
- **Hide**—Hides the HP Media Sign Player **Option** menu. The **Option** menu hides automatically after about 40 seconds if no options are chosen. To have the **Option** menu appear again, press the OK button on the remote control.

Using Music List

After selecting the **Music List** option, select the drive, and then select the folder with the desired audio files. A list of the files in the folder appears. If you select a folder which does not have supported files, the message **No Music List in the Folder** appears. When you highlight a file, you can mark the file to play by pressing the MARK button on the remote control. If you highlight and press the OK button on any file in the list, the **Music selection and menu options** appears.

Information about using Music List:

- MUSIC (*.MP3) supporting file—Purchased music files (*.MP3) might contain copyright restrictions; playback of these files might not be supported.
- Bit rate 32 to 320kbps.
- Sampling rate MPEG1 layer 3—32 kHz, 44.1 kHz, 48 kHz.
- Damaged or corrupted music does not play but displays 00:00 in playtime.

Music selection and menu options:

The Play ►, Pause II, Stop ■, Reverse ◀◀, and Forward ▶▶ buttons on the remote control are also available to use when playing music.

- **Play**—Starts the HP Media Sign Player. After **Play** is highlighted and OK is pressed, the selected music titles are played in the order that they are listed in the music list. If no music titles are selected, the player will play all the titles in the folder in the order they are listed in the **Music List**. The list of titles will remain on the screen for about 40 seconds, and then an information box with the name of the title and timer will be displayed and will move around the screen like a screen saver. Press the OK button on the remote control to get the menu with titles to reappear.
- **Stop Play** (if music is playing)—Stops playing the music titles selected.
- **Play with Photo**—Allows you to select image files to be played along with the music titles selected. When you highlight **Play with Photo** and press OK, the first selected music title will begin playing and you will see the **Photo List** menu. Refer to [Using Photo List on page 46](#) for details on selecting image files to play. After selecting image files, the **Photo List** option dialog box shows the music player as active and if you select **Option**, you see the name of the music folder in the **BGM** window.
- **Mark All**—Marks all music titles in the folder.
- **Delete**—Deletes all the marked or selected files in the selected folder from the USB storage device. When you choose **Delete**, a verification dialog box appears to confirm that you want to delete the file.
- **Close**—Closes the **Music selection and menu** pop-up menu.

Using Movie List

After selecting the **Movie List** option, select the drive, and then select the folder with the desired video files. A list of the files in the folder appears. If you select a folder which does not have supported files, the message **No Movie List in the Folder** appears. When you highlight a file, you can mark the file to play by pressing the MARK button on the remote control. If you highlight and press the OK button on any file in the list, the **Movie selection and menu options** list appears.

Information about using Movie List

- MOVIE (*.avi) supporting file
- Video format—MPEG1, MPEG2, MPEG4 (does not support Microsoft MPEG 4-V2, V3)
- Audio format—Mpeg, Mp3, PCM, Dolby Digital
- Sampling frequency—Within 32k to 48 khz
- Bit rate—32k to 320 kbps
- Subtitle format—*.smi/ *.srt/ *.sub (MicroDVD, SubViewer 2.0)/ *.ass/ *.ssa/*.txt (DVD Subtitle System)
- If the video and audio structure of recorded file is not interleaved, either video or audio is outputted.
- Maximum FPS (frame per second) can be reached only at SD level. FPS is 25 FPS (720*576) or 30 FPS (720*480) depending on Resolution.
- Files more than 25 FPS or 30 FPS or higher might not be played properly.
- A video file name and its subtitle file name must be identical for it to be displayed.

- Playing a video via a USB connection that does not support high speed might not work properly.
- USB storage devices below USB 2.0 are supported as well, but they might not work properly in the **Movie List**.
- Files encoded with GMC (Global Motion Compensation) might not be played.

File Extension name	Video decoder	Audio codec	Max. resolution
mpg, mpeg, vob, dat	MPEG1, MPEG2	AC3, MPEG, MP3, PCM	720 x 576 @ 25p
Avi, m4v	MPEG4-SP, MPEG4-ASP, XviD	AC3, MPEG, MP3, PCM	720 x 480 @ 30p

Movie selection and menu options

- **Play**—Plays the selected movie
- **Mark All**—Marks all movies in the folder
- **Delete**—Deletes the selected movie item
- **Close**—Closes the pop-up menu

Table 7-1 Using the remote control for movies

Reverse ◀◀ and Fast Forward ▶▶ buttons	When the movie is in play mode, press the Reverse ◀◀ button repeatedly to increase the reverse speed ◀◀ (x2) → ◀◀◀ (x4) → ◀◀◀◀ (x8) → ◀◀◀◀◀ (x16) → ◀◀◀◀◀◀ (x32). Press the Fast Forward ▶▶ button repeatedly to increase the forward speed ▶▶ (x2) → ▶▶▶ (x4) → ▶▶▶▶ (x8) → ▶▶▶▶▶ (x16) → ▶▶▶▶▶▶ (x32).
Pause button	During playback, press the Pause button; a still screen appears. Press the Pause button, and then use the Forward ▶▶ button for slow motion. If no buttons are pressed on the remote control for 10 minutes after pausing, the TV returns to the playback state.
Left arrow ◀ and right arrow ▶ buttons	When using the left arrow ◀ or right arrow ▶ buttons during playback, a cursor indicating the position can be viewed on the screen.
Play ▶ button	Press the Play ▶ button to return to normal playback.
ENERGY SAVING button	Press the ENERGY SAVING button repeatedly to change the brightness of your screen.

A Troubleshooting

Solving common problems

The following table lists possible problems, the possible cause of each problem, and the recommended solutions.

Problem	Possible cause	Solution
No image is displayed.	Power cord is not connected.	Be sure the power cord is properly connected to the outlet. <ul style="list-style-type: none">• Verify that the outlet has power to it.• Check that the fuse or breaker has not tripped or burned out. See if the power switch is turned on. Might need service.
Power is on, power indicator is blue, but the screen appears extremely dark.	Screen needs adjustment.	Adjust brightness and contrast again. Backlight might need repair.
Power indicator is amber.	Display is in power saving mode.	Move the mouse or press any key on the keyboard. Turn off equipment and then back on.
Out of Range message appears.	Input signal is out of frequency range.	The signal from the media player/computer (video card) is out of the vertical or horizontal frequency range of the display. Adjust the frequency range by referring to the specifications in this manual (maximum resolution: RGB —1920 x 1080 @ 60 Hz; HDMI —1920 x 1080 @ 60 Hz; DisplayPort —1920 x 1080 @ 60 Hz). NOTE: Vertical Frequency —To enable the user to watch the display, the screen image should change multiple times every second like a fluorescent lamp. The vertical frequency or refresh rate is the number of times the image displays per second. The unit is measured in Hz. Horizontal Frequency —The horizontal interval is the time to display one vertical line. When 1 is divided by the horizontal interval, the number of horizontal lines displayed every second can be tabulated as the horizontal frequency. The unit is measured in kHz.
Check signal cable message appears.	Signal cable is not connected.	The signal cable between the media player/computer and display is not connected. Make sure that the signal cable is properly connected. Press the INPUT button on the remote control to check the input signal.
Unknown Product message appears when the display is connected.	Display driver is not installed.	Install the display driver, which is provided with the display or download from the HP website www.hp.com . See if the Plug and Play function is supported by referring to the video card user manual.
Key Lock On message appears when pressing the Menu button.	Key Lock function is turned on.	The control locking function prevents unintentional OSD setting changes. To unlock the controls, simultaneously press the Menu button and right arrow ► button for several seconds. (You cannot set this function using the remote control buttons. You can set this function with the display only.)

Problem	Possible cause	Solution
The screen looks abnormal; screen position is wrong.	Screen is out of adjustment.	D-sub analog signal - press the AUTO button on the remote control to automatically select the optimal screen status that fits into the current mode. Check that the video card resolution and frequency are supported by the display. If the frequency is out of range, set to the recommended resolution in the Control Panel → Display → Settings of the operating system.
Lines appear on the background screen.	Screen is out of adjustment.	D-sub analog signal - press the AUTO button on the remote control to automatically select the optimal screen status that fits into the current mode.
Horizontal noise appears or the characters look blurred.	Screen is out of adjustment.	D-sub analog signal - press the AUTO button on the remote control to automatically select the optimal screen status that fits into the current mode.
The screen displays abnormally.	Using an incorrect input signal.	The proper input signal is not connected to the signal port. Connect the signal cable that matches with the source input signal.
An after image appears when the display is turned off.	Using a fixed image for too long a period of time.	If you used a fixed image for a long time, the pixels might be damaged. Use a screen-saver function or set the OSD menu to the ISM Method .
No sound.	Audio cable not connected.	Check that the audio cable is properly connected. Adjust the volume. Check if the sound is set properly.
Sound is too dull.	Equalizer is not balanced.	Select the appropriate sound equalize.
Sound is too low.	Sound needs adjusting.	Adjust the volume by pressing the volume buttons on the remote control.
Screen has poor color resolution (16 colors).	Color is not set correctly.	Set the number of colors to more than 24 bit (true color). Select Control Panel → Display → Settings → Color quality in the operating system.
Screen color is unstable or mono colored.	Signal cable or video card connection is loose.	Check the connection status of the signal cable, or reinsert the media player/computer video card.
Black spots appear on the screen.	Black spots are characteristics of the LCD panel.	Several pixels (red, green, white, or black color) might appear on the screen, which can be attributable to the unique characteristics of the LCD panel. It is not a malfunction of the LCD.
The power is suddenly turned off.	Sleep timer setting is turned on, or power is interrupted.	Check that the sleep timer is set. Check the power control settings.

Problem	Possible cause	Solution
Touch function is not recognized using Windows XP.	Windows XP driver is not installed.	To use the touch function in Windows XP, you must install the driver. Refer to Touch software installation for Microsoft Windows XP on page 41 for instructions.
Touch display is not functioning properly.	Firmware needs to be upgraded.	Upgrade the firmware. Refer to Upgrading the firmware on page 44 for instructions.

Using the Internet

For online access to technical support information, self-solve tools, online assistance, community forums of IT experts, broad multi-vendor knowledge base, monitoring and diagnostic tools, go to www.hp.com/support

Preparing to call technical support

If you cannot solve a problem using the troubleshooting tips in this section, you might need to call technical support. Contact your regional HP authorized service provider. Have the following information available when you call:

- Display model number
- Serial number for the display
- Purchase date on invoice
- Conditions under which the problem occurred
- Error messages received
- Hardware configuration
- Hardware and software you are using

B Technical specifications

 **NOTE:** All performance specifications are provided by the component manufacturers. Performance specifications represent the highest specification of all HP's component manufacturers' typical level specifications for performance; actual performance might vary either higher or lower.

HP Digital Signage Display

Table B-1 Specifications

		LD4220tm	LD4720tm
Display	Size	106.73 cm (42 in)	119.28 cm (47 in)
	Type	TFT LCD panel	TFT LCD panel
Viewable image size		106.73 cm (42 in) diagonal	119.28 cm (47 in) diagonal
Pixel pitch		0.4845 x 0.4845 mm (0.0191 x 0.0191 in) X RGB	0.5415 x 0.5415 mm (0.0213 x 0.0213 in) X RGB
Weight—maximum	Without stand and speaker	25.9 kg (57.03 lbs)	32.39 kg (71.41 lbs)
	With speaker	26.6 kg (57.03 lbs)	33.1 kg (73.02 lbs)
	With stand	27.1 kg (59.75 lbs)	33.8 kg (74.47 lbs)
	With stand and speaker	27.9 kg (61.43 lbs)	34.5 kg (76.09 lbs)
Dimensions (W x H x D)	Without stand and speaker	974.2 x 563.8 x 132.5 mm (38.35 x 22.20 x 5.22 in)	1082.2 x 628.6 x 132.2 mm (42.61 x 24.75 x 5.20 in)
	With speaker	974.2 x 563.8 x 132.5 mm (38.35 x 22.20 x 5.22 in)	1082.2 x 628.6 x 138.44 mm (42.61 x 24.75 x 5.45 in)
	With stand	974.2 x 637.0 x 258.61 mm (38.35 x 25.08 x 10.18 in)	1082.2 x 702.02 x 298.34 mm (42.61 x 27.64 x 11.75 in)
	With stand and speaker	974.2 x 637.0 x 258.61 mm (38.35 x 25.08 x 10.18 in)	1082.2 x 702.02 x 298.34 mm (42.61 x 27.64 x 11.75 in)
Power	Rated voltage	AC 100-240 V~50/60 Hz 2.5 A Japan: AC 100 V~50/60 Hz 2.5 A	AC 100-240 V~50/60 Hz 3.0 A Japan: AC 100 V~50/60 Hz 3.0 A
Power consumption	On mode	220 W Typical	270 W Typical
	Sleep mode	≤ 1 W (RGB) / 2 W (HDMI/DVI) ≤ 1 W (RGB) / 2 W (DisplayPort) (if LAN OFF is selected)	≤ 1 W (RGB) / 2 W (HDMI/DVI) ≤ 1 W (RGB) / 2 W (DisplayPort) (if LAN OFF is selected)

Table B-1 Specifications (continued)

		LD4220tm	LD4720tm
Resolution— maximum	RGB	1920 x 1080 @ 60 Hz	1920 x 1080 @ 60 Hz
	HDMI/DVI	1920 x 1080 @ 60 Hz (if supported by OS or video card type)	1920 x 1080 @ 60 Hz (if supported by OS or video card type)
	DisplayPort	1920 x 1080 @ 60 Hz (if supported by OS or video card type)	1920 x 1080 @ 60 Hz (if supported by OS or video card type)
Resolution— recommended	RGB	1920 x 1080 @ 60 Hz	1920 x 1080 @ 60 Hz
	HDMI/DVI	1920 x 1080 @ 60 Hz (if supported by OS or video card type)	1920 x 1080 @ 60 Hz (if supported by OS or video card type)
	DisplayPort	1920 x 1080 @ 60 Hz (if supported by OS or video card type)	1920 x 1080 @ 60 Hz (if supported by OS or video card type)
Horizontal frequency	RGB	30–83 kHz	30–83 kHz
	HDMI/DVI	30–83 kHz	30–83 kHz
	DisplayPort	30–83 kHz	30–83 kHz
Vertical frequency	RGB	56–75 Hz	56–75 Hz
	HDMI/DVI	56–60 Hz	56–60 Hz
	DisplayPort	56–60 Hz	56–60 Hz
Synchronization type		Separate/Digital	Separate/Digital
Input connector		15-pin D-Sub type, HDMI/DVI (digital), RS-232C, DisplayPort, USB, LAN	15-pin D-Sub type, HDMI/DVI (digital), RS-232C, DisplayPort, USB, LAN
Environmental conditions	Operating temperature	0° ~ 35°C Humidity 10% to 80%	0° ~ 35°C Humidity 10% to 80%
	Storage temperature	–20° to 60°C Humidity 20% to 80%	–20° to 60°C Humidity 20% to 80%
Audio (select models)	RMS audio output	10 W + 10 W (R + L)	10 W + 10 W (R + L)
	Input sensitivity	0.7 Vrms	0.7 Vrms
	Speaker impedance	8 Ohms	8 Ohms

HP LD4220tm dimensions (with optional stand and speakers)

Figure B-1 HP LD4220tm—Front and side view

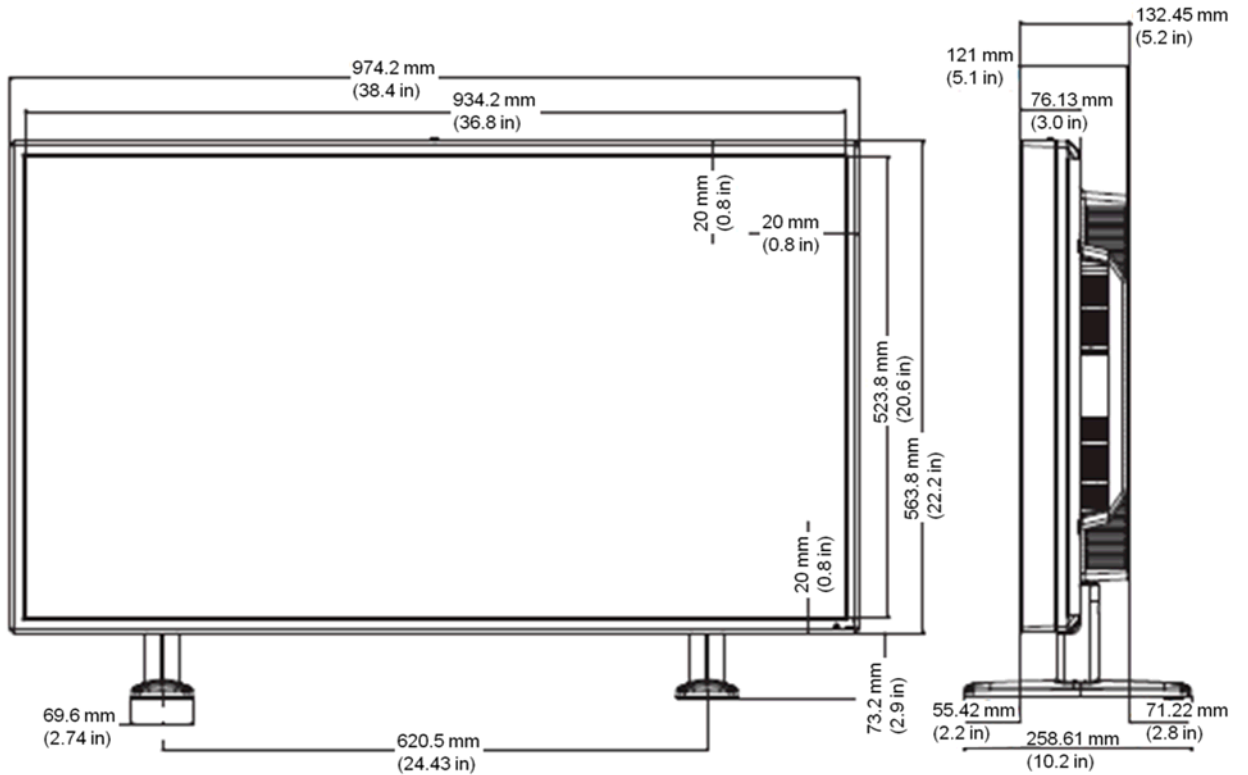
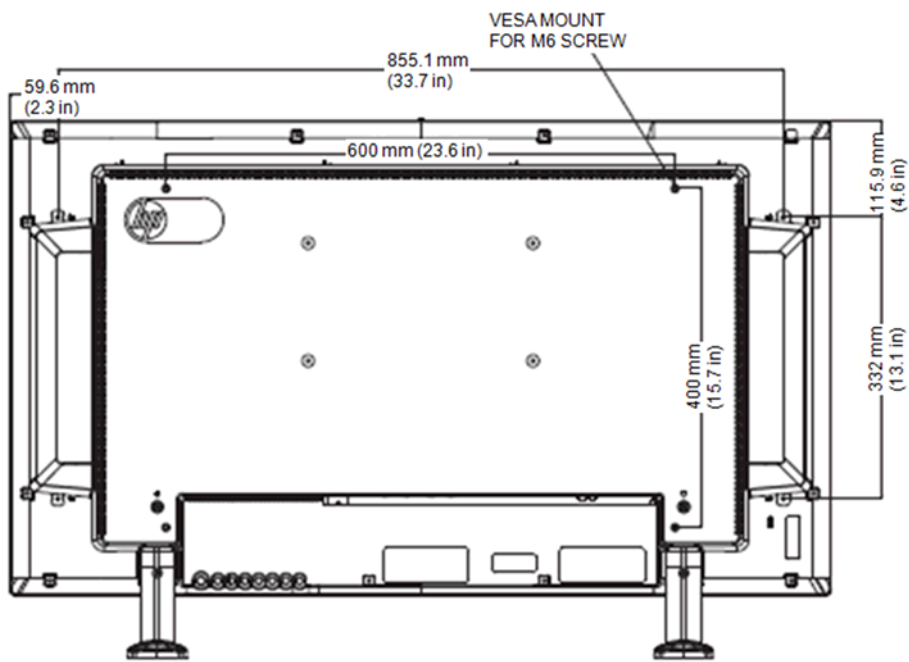

Figure B-2 HP LD4220tm—Back view



HP LD4720tm dimensions (with optional stand and speakers)

Figure B-3 HP LD4720tm—Front and side view

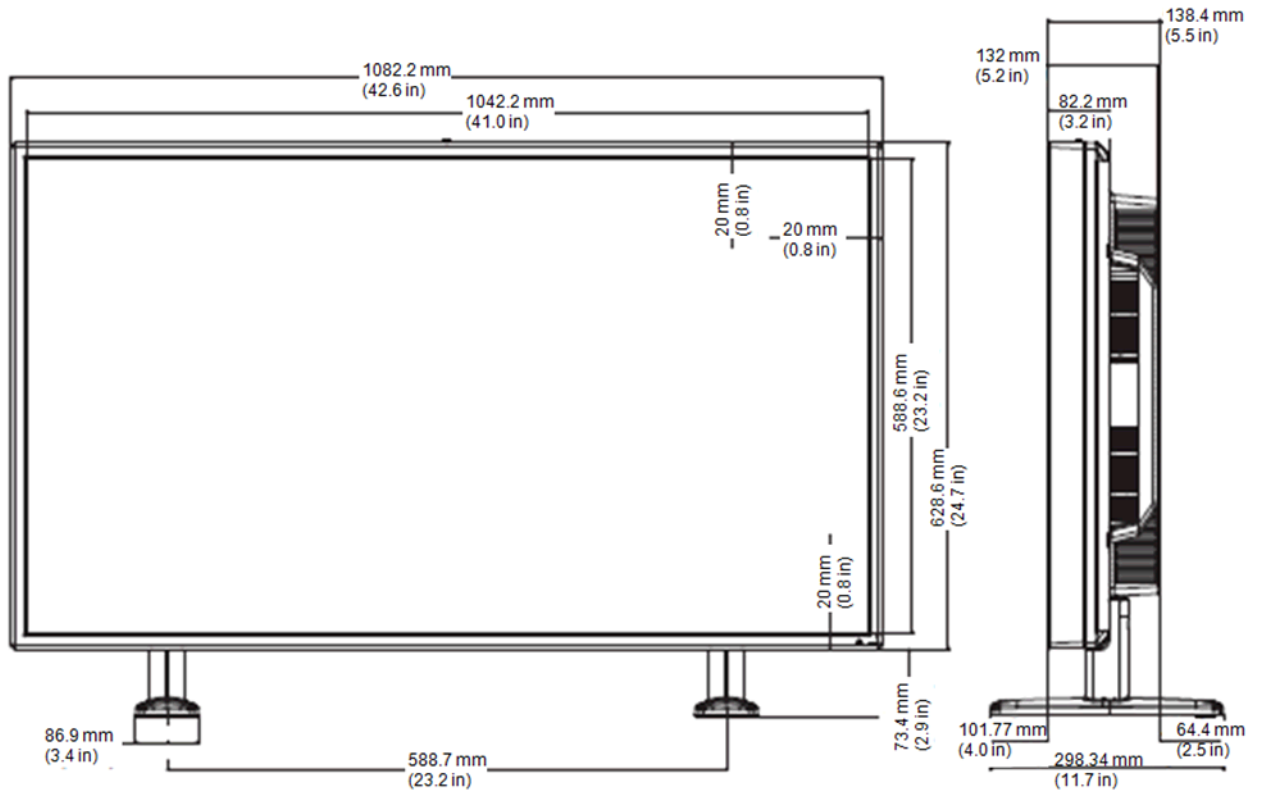
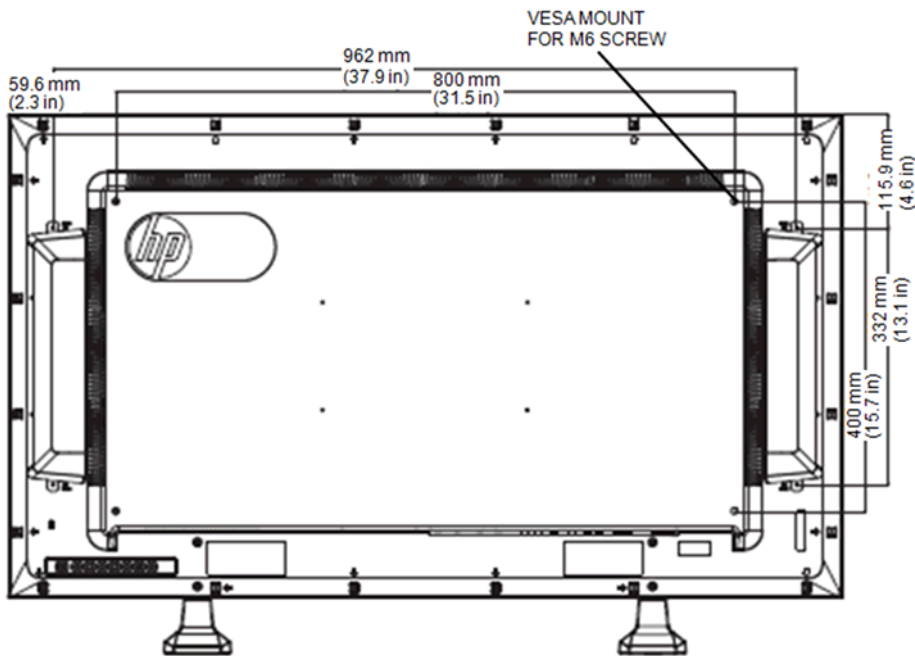

Figure B-4 HP LD4720tm—Back view



Recognizing preset display resolutions

The display resolutions listed below are the most commonly used modes and are set as factory defaults. This display automatically recognizes these preset modes and they will appear properly sized and centered on the screen.

Preset display modes

Table B-2 Factory preset display modes

Preset	Pixel format	Horizontal frequency (kHz)	Vertical Frequency (Hz)
1	720 x 400	31.468	70.1
*2	640 x 480	31.469	59.94
3	640 x 480	37.5	75
*4	800 x 600	37.879	60.317
5	800 x 600	46.875	75
6	832 x 624	49.725	74.55
*7	1024 x 768	48.363	60
8	1024 x 768	60.123	75.029
*9	1280 x 720	44.772	59.855
*10	1280 x 1024	63.981	60.02
11	1280 x 1024	79.98	75.02
*12	1680 x 1050	65.290	59.954
*13	1920 x 1080	67.5	60

1 to 13 RGB mode
* HDMI/DisplayPort mode

DTV mode

	HDMI/DVI (DTV)	DisplayPort
480i	x	x
480p	o	o
576i	x	x
576p	o	o
720p	o	o
1080i	o	o
1080p	o	o



NOTE: DTV/PC selection on HDMI/DVI inputs is available for media player/computer resolutions—640 x 480/60 Hz, 1280 x 720/60 Hz, 1920 x 1080/60 Hz and DTV resolutions—480p, 720p, 1080p.

Power indicator

Mode	LED indicator light
On Mode	Blue
Sleep Mode	Amber
Off Mode	-

C Command reference

Use this method to connect several products to a single PC. You can control several products at a time by connecting them to a single PC. If the **Set ID** menu in **Option** is set to **OFF**, the monitor ID value should be set between 1 and 99.

Connecting the cable

Connect the RS-232-C cable as shown in the following illustration. The RS-232-C protocol is used for communication between the media player/computer and the display. You can turn the display on/off, select an input source or adjust the OSD menu from the media player/computer.

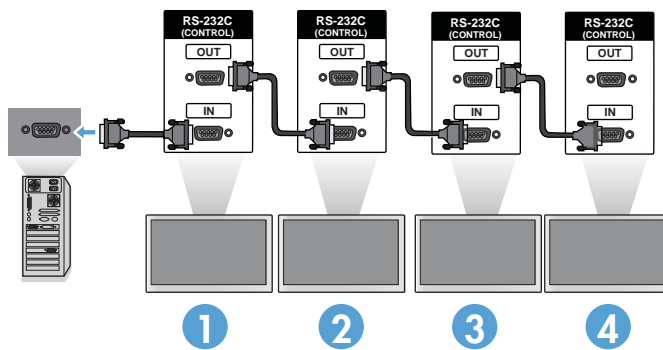

RS-232-C configurations

7-Wire configurations (Standard RS-232-C cable)				3-Wire configurations (Not Standard)			
media player/ computer		Display		media player/ computer		Display	
RXD	2	3	TXD	RXD	2	3	TXD
TXD	3	2	RXD	TXD	3	2	RXD
GND	5	5	GND	GND	5	5	GND
DTR	4	6	DSR	DTR	4	6	DSR
DSR	6	4	DTR	DSR	6	4	DTR
RTS	7	8	CTS	RTS	7	7	CTS
CTS	8	7	RTS	CTS	8	8	RTS
D-Sub 9 (Female)		D-Sub 9 (Female)		D-Sub 9 (Female)		D-Sub 9 (Female)	

Communication parameter

- Baud Rate—9600 baud rate (UART)
- Data Length—8 bit
- Parity Bit—None
- Stop Bit—1 bit
- Flow Control—None
- Communication Code—ASCII code
- Use a crossed (reverse) cable

Command reference list

	COMMAND1	COMMAND2	DATA1	DATA2	DATA3
01. Power	k	a	00H–01H		
02. Input Select	k	b	07H–0BH		
03. Aspect Ratio	k	c	01H–1FH		
04. Screen Mute	k	d	00H–01H		
05. Volume Mute	k	e	00H–01H		
06. Volume Control	k	f	00H–64H		
07. Contrast	k	g	00H–64H		
08. Brightness	k	h	00H–64H		
09. Color	k	i	00H–64H		
10. Tint	k	j	00H–64H		
11. Sharpness	k	k	00H–64H		
12. OSD Select	k	l	00H–01H		
13. Remote Lock/Key Lock	k	m	00H–01H		
14. Balance	k	t	00H–64H		
15. Color Temperature	k	u	00H–02H		
16. Abnormal State	k	z	FFH		
17. ISM Method	j	p	01H–08H		
18. Auto Configuration	j	u	01H		
19. Key	m	c	Key Code		
20. Tile Mode	d	d	00H–55H		
21. Tile H Position	d	e	00H–14H		
22. Tile V Position	d	f	00H–14H		
23. Tile H Size	d	g	00H–64H		
24. Tile V Size	d	h	00H–64H		

	COMMAND1	COMMAND2	DATA1	DATA2	DATA3
25. Tile ID Set	d	i	00H-19H		
26. Natural Mode (In Tile Mode)	d	j	00H-01H		
27. Picture Mode (PSM)	d	x	00H-06H		
28. Sound Mode	d	y	01H-05H		
29. Fan Fault Check	d	w	FFH		
30. Elapsed Time Return	d	l	FFH		
31. Temperature Value	d	n	FFH		
32. Lamp Fault Check	d	p	FFH		
33. Auto Volume	d	u	00H-01H		
34. Speaker	d	v	00H-01H		
35. Time	f	a	00H-06H	00H-17H	00H-3BH
36. On Timer (On/Off Timer) Time	f	d	F1H-F4H E0H-E4H 01H-80H	00H-17H	00H-3BH
37. Off Timer (On/Off Timer) Time	f	e	F1H-F4H E0H-E4H 01H-80H	00H-17H	00H-3BH
38. Scheduling Input Select	f	u	F1H-F4H	07H-0BH	
39. Sleep Time	f	f	00H-08H		
40. Auto Off	f	g	00H-01H		
41. Power On Delay	f	h	00H-64H		
42. Language	f	i	00H-09H		
43. DPM Select	f	j	00H-01H		
44. Reset	f	k	00H-02H		
45. Energy Saving	f	l	00H-03H		
46. Power Indicator	f	o	00H-01H		
47. Serial No.	f	y	FFH		
48. S/W Verison	f	z	FFH		
49. Input Select	x	b	60H-C0H		

Transmission/Receiving Protocol

Transmission

```
[Command1][Command2][Set ID][Data][Cr]
```

*[Command 1]	First command (k, j, m, d, f, x)
*[Command 2]	Second command (a to z)
*[Set ID]	Set up the Set ID number of product. range: 01H to 63H. by setting '0', server can control all products. When operating with more than 2 sets using set ID as '0' at the same time, do not check the ack message. Because all sets will send the ack message, it is not possible to check all of the ack messages.
*[Data]	To transmit command data. Transmit 'FF' data to read status of command.
*[Cr]	Carriage Return ASCII code '0 x 0 D'
*[]	ASCII code Space (0 x 20)

OK Acknowledgement

```
[Command2][Set ID][OK][Data][x]
```

*The Product transmits ACK (acknowledgement) based on this format when receiving normal data. At this time, if the data is in data read mode, it indicates present status data. If the data is in data write mode, it returns the data of the media player/computer.

Error Acknowledgement

```
[Command2][Set ID][NG][Data][x]
```

If there is an error, it returns NG

01. Power (Command: a)

To control Power On/Off of the Set.

Transmission

```
[k][a][Set ID][Data][Cr]
```

```
[Data]    0: Power Off
```

```
          1: Power On
```

Acknowledgement

```
[a][Set ID][OK][Data][x]
```

To show the status of Power On/Off.

Transmission

[k][a][Set ID][FF][Cr]

Acknowledgement

[a][Set ID][OK][Data][x]

[Data] 0: Power Off

 1: Power On

02. Input Select (Command: b) (Main Picture Input)

To select input source for the Set.

You can also select an input source using the INPUT button on the remote control.

Transmission

[k][b][Set ID][Data][Cr]

[Data]	7: RGB (PC)
	8: HDMI/DVI (HD-DVD)
	9: HDMI (PC)
	A: DisplayPort (HD-DVD)
	B: DisplayPort (PC)

Acknowledgement

[b][Set ID][OK][Data][x]

[Data]	7: RGB (PC)
	8: HDMI/DVI (HD-DVD)
	9: HDMI (PC)
	A: DisplayPort (HD-DVD)
	B: DisplayPort (PC)

03. Aspect Ratio (Command: c) (Main picture format)

To adjust the screen format.

You can also adjust the screen format using the ARC (Aspect Ratio Control) button on remote control or in the Screen menu.

Transmission

```
[k][c][Set ID][Data][Cr]
```

[Data]	1: Normal Screen (4:3)
	2: Wide Screen (16:9)
	4: Zoom [HDMI (HD-DVD), DisplayPort (HD-DVD)]
	6: Original
	7: 14:9 [HDMI (HD-DVD), DisplayPort (HD-DVD)]
	9: Just Scan [HDMI (HD-DVD), DisplayPort (HD-DVD)]
	When the RGB, HDMI/DVI-PC, DisplayPort-PC mode (1:1)
	10 to 1F: Cinema Zoom 1 to 16 [HDMI (HD-DVD), DisplayPort (HD-DVD)]

Acknowledgement

```
[c][Set ID][OK][Data][x]
```

04. Screen Mute (Command: d)

To select screen mute on/off.

Transmission

```
[k][d][Set ID][Data][Cr]
```

[Data]	0: Screen mute off (Picture on)
	1: Screen mute on (Picture off)

Acknowledgement

```
[d][Set ID][OK][Data][x]
```

05. Volume Mute (Command: e)

To control On/Off of the Volume Mute.

Transmission

```
[k][e][Set ID][Data][Cr]
```

[Data]	0: Volume Mute On (Volume Off)
	1: Volume Mute Off (Volume On)

Acknowledgement

```
[e][Set ID][OK][Data][x]
```

[Data]	0: Volume Mute On (Volume Off)
	1: Volume Mute Off (Volume On)

06. Volume Control (Command: f)

To adjust Volume.

Transmission

```
[k][f][Set ID][Data][Cr]
```

[Data]	Min: 00H to Max: 64H
	(Hexadecimal code)

Acknowledgement

```
[f][Set ID][OK][Data][x]
```

[Data]	Min: 00H to Max: 64H
--------	----------------------

Real data mapping	0: Step 0
	:
	A: Step 10
	:
	F: Step 15
	10: Step 16
	:
	64: Step 100

07. Contrast (Command: g)

To adjust screen contrast. You can also adjust the contrast in the Picture menu.

Transmission

[k][g][Set ID][Data][Cr]

[Data] Min: 00H to Max: 64H

Acknowledgement

[g][Set ID][OK][Data][x]

Real data mapping	0: Step 0
	:
	A: Step 10
	:
	F: Step 15
	10: Step 16
	:
	64: Step 100

08. Brightness (Command: h)

To adjust screen brightness. You can also adjust the brightness in the Picture menu.

Transmission

```
[k][h][Set ID][Data][Cr]
```

```
[Data]      Min: 00H to Max: 64H
```

Refer to “Real data mapping” as shown below.

Acknowledgement

```
[h][Set ID][OK][Data][x]
```

Real data mapping	0: Step 0
	:
	A: Step 10
	:
	F: Step 15
	10: Step 16
	:
	64: Step 100

09. Color (Command: i) (Video Timing only)

To adjust the screen color. You can also adjust the color in the Picture menu.

Transmission

```
[k][i][Set ID][Data][Cr]
```

```
[Data]      Min: 00H to Max: 64H  
            (Hexadecimal code)
```

Real data mapping	0: Step 0
	:
	A: Step 10
	:
	F: Step 15
	10: Step 16
	:
	64: Step 100

Acknowledgement

[i][Set ID][OK][Data][x]

[Data] Min: 00H to Max: 64H
(Hexadecimal code)

10. Tint (Command: j) (Video Timing only)

To adjust the screen tint. You can also adjust the tint in the Picture menu.

Transmission

[k][j][Set ID][Data][Cr]

[Data] Red: 00H to Green: 64H
(Hexadecimal code)

Real data mapping	0: Step 0
	:
	A: Step 10
	:
	F: Step 15
	10: Step 16
	:
	64: Step 100

Acknowledgement

[j][Set ID][OK][Data][x]

[Data] Red: 00H to Green: 64H

Tint real data mapping	0: Step 0 to Red
	:
	64: Step 100 to Green

11. Sharpness (Command: k) (Video Timing only)

To adjust the screen Sharpness. You can also adjust the sharpness in the Picture menu.

Transmission

[k][k][Set ID][Data][Cr]

[Data] Min: 00H to Max: 64H
(Hexadecimal code)

Real data mapping	0: Step 0
	:
	A: Step 10
	:
	F: Step 15
	10: Step 16
	:
	64: Step 100

Acknowledgement

[k][Set ID][OK][Data][x]

[Data] Min: 00H to Max: 64H

12. OSD Select (Command: l)

To control OSD on/off to the set.

Transmission

```
[k][l][Set ID][Data][Cr]
```

[Data]	0: OSD Off
	1: OSD On

Acknowledgement

```
[l][Set ID][OK][Data][x]
```

[Data]	0: OSD Off
	1: OSD On

13. Remote Lock/Key Lock (Command: m)

To control Remote Lock on/off to the set.

This function, when controlling RS-232C, locks the remote control and the local keys.

Transmission

```
[k][m][Set ID][Data][Cr]
```

[Data]	0: Off
	1: On

Acknowledgement

```
[m][Set ID][OK][Data][x]
```

[Data]	0: Off
	1: On

14. Balance (Command: t)

To adjust the sound balance.

Transmission

[k][t][Set ID][Data][Cr]

[Data] Min: 00H to Max: 64H
(Hexadecimal code)

00H: Step L50

64H: Step R50

Acknowledgement

[t][Set ID][OK][Data][x]

[Data] Min: 00H to Max: 64H

00H: Step 0 to L50

64H: Step 100 to R50

Balance: L50 to R50

15. Color Temperature (Command: u)

To adjust the screen color temperature.

Transmission

[k][u][Set ID][Data][Cr]

[Data] 0: Medium
1: Cool
2: Warm

Acknowledgement

[u][Set ID][OK][Data][x]

[Data]	0: Medium
	1: Cool
	2: Warm

16. Abnormal state (Command: z)

Abnormal State: Used to Read the power off status when Stand-by mode.

Transmission

```
[k][z][Set ID][Data][Cr]
```

[Data]	FF: Read
--------	----------

Acknowledgement

```
[z][Set ID][OK][Data][x]
```

[Data]	0: Normal (Power on and signal exist)
	1: No signal (Power on)
	2: Turn the display off by remote control
	3: Turn the display off by sleep time function
	4: Turn the display off by RS-232-C function
	8: Turn the display off by off time function
	9: Turn the display off by auto off function

17. ISM Method (Command: j p)

Used to select the afterimage preventing function.

Transmission

```
[j][p][Set ID][Data][Cr]
```

[Data]	1H: Inversion
	2H: Orbiter
	4H: White Wash
	8H: Normal

Acknowledgement

```
[p][Set ID][OK][Data][x]
```

18. Auto Configure (Command: j u)

To adjust picture position and minimize image shaking automatically. It works only in RGB (PC) mode.

Transmission

```
[j][u][Set ID][Data][Cr]
```

```
[Data]      1: To set
```

Acknowledgement

```
[u][Set ID][OK][Data][x]
```

19. Key (Command: m c)

To send IR remote key code.

Transmission

```
[m][c][Set ID][Data][Cr]
```

Data Key code: Refer to the [IR Codes Table on page 92](#) section.

Acknowledgement

```
[c][Set ID][OK][Data][x]
```

20. Tile Mode (Command: d d)

Change a Tile Mode.

Transmission

[d][d][Set ID][Data][x]

[Data]	Description
00 or 11	Tile mode is off.
12	1 x 2 mode (column x row)
13	1 x 3 mode
14	1 x 4 mode
...	...
55	5 x 5 mode

The [Data] cannot be set to 0X or X0 except 00.

Acknowledgement

[d][00][OK/NG][Data][x]

21. Tile H Position (Command: d e)

To set the Horizontal position.

Transmission

[d][e][Set ID][Data][x]

[Data] Min: 00H to Max: 14H

00H: Step -10 (Left)

14H: Step 10 (Right)

Acknowledgement

[e][Set ID][OK/NG][Data][x]

22. Tile V Position (Command: d f)

To set the Vertical position.

Transmission

[d][f][Set ID][Data][x]

[Data] Min: 00H to Max: 14H

00H: Step -10 (Left)

14H: Step 10 (Right)

Acknowledgement

[f][Set ID][OK/NG][Data][x]

23. Tile H Size (Command: d g)

To set the Horizontal size.

Transmission

[d][g][Set ID][Data][x]

[Data] Min: 00H to Max: 64H

Real data mapping	0: Step 0
	:
	A: Step 10
	:
	F: Step 15
	10: Step 16
	:
	64: Step 100

Acknowledgement

[g][Set ID][OK/NG][Data][x]

24. Tile V Size (Command: d h)

To set the Vertical size.

Transmission

[d][h][Set ID][Data][x]

[Data] Min: 00H to Max: 64H

Real data mapping	0: Step 0
	:
	A: Step 10
	:
	F: Step 15
	10: Step 16
	:
	64: Step 100

Acknowledgement

[h][Set ID][OK/NG][Data][x]

25. Tile ID Set (Command: d i)

To assign the Tile ID for Tiling function.

Transmission

[d][i][Set ID][Data][x]

[Data] Min: 00H to Max: 19H
(Hexadecimal code)

Acknowledgement

[i][Set ID][OK/NG][Data][x]

26. Natural Mode (In Tile Mode) (Command: d j)

To assign the Title Natural mode for Tiling function.

Transmission

[d][i][Set ID][Data][x]

[Data]	0: Natural Off
	1: Natural On
	ff: Read Status

Acknowledgement

[i][Set ID][OK/NG][Data][x]

27. Picture Mode (Command: d x)

To adjust the picture mode.

Transmission

[d][x][Set ID][Data][x]

Data Structure

Data (Hex)	MODE
00	Vivid
01	Standard
02	Cinema
03	Sport
04	Game
05	Expert 1
06	Expert 2

Acknowledgement

[x][Set ID][OK/NG][Data][x]

28. Sound Mode (Command: d y)

To adjust the Sound mode.

Transmission

[d][y][Set ID][Data][X]

Data Structure

Data (Hex)	MODE
01	Standard
02	Music
03	Cinema
04	Sport
05	Game

Acknowledgement

[y][Set ID][OK/NG][Data][x]

29. Fan Fault check (Command: d w)

To check the Fan fault of the display.

Transmission

[d][w][Set ID][Data][x]

[Data] Data is always FF (in Hex)
 Data ff: Read Status

Acknowledgement

[w][Set ID][OK/NG][Data][x]

[Data] [Data] is the status value of the Fan fault.
 0: Fan fault
 1: Fan OK
 2: N/A (Not Available)

30. Elapsed time return (Command: d l)

To read the elapsed time.

Transmission

[d][i][Set ID][Data][x]

[Data] Data is always FF (in Hex)

Acknowledgement

[i][Set ID][OK/NG][Data][x]

[Data] The data means used hours.
(Hexadecimal code)

31. Temperature value (Command: d n)

To read the inside temperature value.

Transmission

[d][n][Set ID][Data][x]

[Data] Data is always FF (in Hex)

Acknowledgement

[n][Set ID][OK/NG][Data][x]

[Data] The data is 1 byte long in Hexadecimal.

32. Lamp fault Check (Command: d p)

To check lamp fault.

Transmission

[d][p][Set ID][Data][x]

[Data] Data is always FF (in Hex)

Acknowledgement

[p][Set ID][OK/NG][Data][x]

[Data]	0: Lamp Fault
	1: Lamp OK
	2: N/A(DPM/Power Off)

33. Auto volume (Command: d u)

Automatically adjust the volume level.

Transmission

[d][u][Set ID][Data][x]

[Data]	0: Off
	1: On

Acknowledgement

[u][Set ID][OK/NG][Data][x]

34. Speaker (Command: d v)

Turn the speaker on or off.

Transmission

```
[d][v][Set ID][Data][x]
```

[Data]	0: Off
	1: On

Acknowledgement

```
[v][Set ID][OK/NG][Data][x]
```

35. Time (Command: f a)

Set the current time.

Transmission

```
[f][a][Set ID][Data1][Data2][Data3][Cr]
```

[Data1]	0: Monday
	1: Tuesday
	2: Wednesday
	3: Thursday
	4: Friday
	5: Saturday
	6: Sunday

[Data2]	00H to 17H (Hours)
---------	--------------------

[Data3]	00H to 3BH (Minutes)
---------	----------------------

Acknowledgement

```
[a][Set ID][OK/NG][Data1][Data2][Data3][x]
```

When reading data, FFH is inputted for [Data1], [Data2] and [Data3]. In other cases, all are treated as NG.

36. On Timer (On/Off Timer) Time (Command: f d)

Set On Timer.

Transmission

```
[f][d][Set ID][Data1][Data2][Data3][Cr]
```

	1.	2.	3.
[Data1]	f1h to f4h (read one index)	e0h to e4h (delete one index), e0h (delete all indexes)	01h to 80h (write) (Day of Week)
	f1: read 1st index of On Time List	e0: delete all indexes of On Time List	bit0 (01h): Monday
	f2: read 2nd index of On Time List	e1: delete 1st index of On Time List	bit1 (02h): Tuesday
	f3: read 3rd index of On Time List	e2: delete 2nd index of On Time List	bit2 (04h): Wednesday
	f4: read 4th index of On Time List	e3: delete 3rd index of On Time List	bit3 (08h): Thursday
			bit4 (10h): Friday
		e4: delete 4th index of On Time List	bit5 (20h): Saturday
			bit6 (40h): Sunday
			bit7 (80h): Everyday
			(1fh): Monday to Friday
			(3fh): Monday to Saturday
			(60h): Saturday to Sunday

```
[Data2] 00h to 17h, ffh (Hours)
```

```
[Data3] 00h to 3bh, ffh (Minutes)
```

When you read/delete the current on time list, all of [Data2][Data3] have to be 0xff.

ex1: fd 01 f1 ff ff - when you read 1st index of On Time List

ex2: fd 01 e1 ff ff - when you delete 1st index of On Time List

ex3: fd 01 3f 02 03 - when you write one On Time Data, "Monday to Saturday, 02:03"

Acknowledgement

[d][Set ID][OK][Data1][Data2][Data3][x]

37. Off Timer (On/Off Timer) Time (Command: f e)

Set Off Timer.

Transmission

[f][e][Set ID][Data1][Data2][Data3][Cr]

	1.	2.	3.
[Data1]	f1h to f4h (read one index)	e0h to e4h(delete one index), e0h (delete all indexes)	01h to 80h (write) (Day of Week)
	f1: read 1st index of On Time List	e0: delete all indexes of On Time List	bit0 (01h): Monday
	f2: read 2nd index of On Time List	e1: delete 1st index of On Time List	bit1 (02h): Tuesday
	f3: read 3rd index of On Time List	e2: delete 2nd index of On Time List	bit2 (04h): Wednesday
	f4: read 4th index of On Time List	e3: delete 3rd index of On Time List	bit3 (08h): Thursday
			bit4 (10h): Friday
		e4: delete 4th index of On Time List	bit5 (20h): Saturday
			bit6 (40h): Sunday
			bit7 (80h): Everyday
			(1fh): Monday to Friday
			(3fh): Monday to Saturday
			(60h): Saturday to Sunday

[Data2] 00h to 17h, ffh (Hours)

[Data3] 00h to 3bh, ffh (Minutes)

When you read/delete the current on time list, all of [Data2][Data3] have to be 0xff.

ex1: fd 01 f1 ff ff - when you read 1st index of On Time List

ex2: fd 01 e1 ff ff - when you delete 1st index of On Time List

ex3: fd 01 3f 02 03 - when you write one On Time Data, "Monday to Saturday, 02:03"

Acknowledgement

```
[e][Set ID][OK][Data1][Data2][Data3][x]
```

38. Scheduling Input select (Command: f u) (Main Picture Input)

To select input source for TV depending on day.

Transmission

```
[f][u][Set ID][Data1][Data2][Cr]
```

[Data1]	f1h to f4h(write/read one index)
	f1: read 1st index of On Time Input
	f2: read 2nd index of On Time Input
	f3: read 3rd index of On Time Input
	f4: read 4th index of On Time Input

	Data (Hex)	INPUT
[Data2]	07	RGB-PC
	08	HDMI/DVI (HD-DVD)
	09	HDMI/DVI (PC)
	A	DisplayPort (HD-DVD)
	B	DisplayPort (PC)

When you read/delete the current On Time Input, [Data2] needs to be 0xff.

ex1: fu 01 f1 ff - when you read 1st index of On Time Input

ex2: fu 01 f3 07 - when you write one On Time Input Data in to 3rd index, "RGB"

Acknowledgement

```
[u][Set ID][OK][Data1][Data2][x]
```

39. Sleep Time (Command: f f)

Set Sleep Time.

Transmission

```
[f][f][Set ID][Data][Cr]
```

[Data]	0: Off
	1: 10
	2: 20
	3: 30
	4: 60
	5: 90
	6: 120
	7: 180
	8: 240

Acknowledgement

```
[f][Set ID][OK/NG][Data][x]
```

40. Auto Off (Command: f g)

Set Auto Sleep.

Transmission

```
[f][g][Set ID][Data][Cr]
```

[Data]	0: Off
	1: On

Acknowledgement

```
[g][Set ID][OK/NG][Data][x]
```

41. Power On Delay (Command: f h)

Set the schedule delay when the power is turned on (Unit: second).

Transmission

```
[f][h][Set ID][Data][Cr]
```

[Data] 00H to 64H (Data value)

Real data mapping	0: Step 0
	:
	A: Step 10
	:
	F: Step 15
	10: Step 16
	:
	64: Step 100

Acknowledgement

[h][Set ID][OK/NG][Data][x]

42. Language (Command: f i)

Set the OSD language.

Transmission

[f][Set ID][Data][Cr]

[Data]	0: English
	1: French
	2: German
	3: Spanish
	4: Italian
	5: Portuguese
	6: Chinese
	7: Japanese
	8: Korean
	9: Russian

Acknowledgement

[i][Set ID][OK/NG][Data][x]

43. DPM Select (Command: f j)

Set the DPM (Display Power Management) function.

Transmission

```
[f][j][Set ID][Data][Cr]
```

[Data]	0: Off
	1: On

Acknowledgement

```
[j][Set ID][OK/NG][Data][x]
```

44. Reset (Command: f k)

Execute the Picture, Screen and Factory Reset functions.

Transmission

```
[f][k][Set ID][Data][Cr]
```

[Data]	0: Picture Reset
	1: Screen Reset
	2: Factory Reset

Acknowledgement

```
[k][Set ID][OK/NG][Data][x]
```

45. Energy saving (Command: f l)

To set the Power saving mode.

Transmission

```
[f][l][Set ID][Data][Cr]
```

[Data]	0: Off
	1: (static level 1)
	2: (static level 2)
	3: (static level 3)

Acknowledgement

[!][Set ID][OK/NG][Data][x]

46. Power Indicator (Command: f o)

To set the LED for Power Indicator

Transmission

[f][o][Set ID][Data][Cr]

[Data]	0: Off
	1: On

Acknowledgement

[o][Set ID][OK/NG][Data][x]

47. Serial no. Check (Command: f y)

To read the serial numbers

Transmission

[f][y][Set ID][Data][Cr]

[Data]	Data FF (to read the serial numbers)
--------	--------------------------------------

Acknowledgement

[y][Set ID][OK/NG][Data1]to[Data13][x]

[Data]	The data format is ASCII Code.
--------	--------------------------------

48. S/W Version (Command: f z)

Check the software version.

Transmission

[f][z][Set ID][Data][Cr]

[Data] FFH: Read

Acknowledgement

[z][Set ID][OK/NG][Data][x]

49. Input Select (Command: x b)

To select input source for the display.

Transmission

[x][b][Set ID][Data][Cr]

[Data] 60H: RGB (PC)
 90H: HDMI/DVI (HD-DVD)
 A0H: HDMI/DVI (PC)
 B0H: DisplayPort (HD-DVD)
 C0H: DisplayPort (PC)

Acknowledgement

[b][Set ID][OK][Data][x]

[Data] 60H: RGB (PC)
 90H: HDMI/DVI (HD-DVD)
 A0H: HDMI/DVI (PC)
 B0H: DisplayPort (HD-DVD)
 C0H: DisplayPort (PC)

IR codes

Use this method to connect your wired remote control port on the display.

Remote Control IR Code

Output waveform

- Single pulse, modulated with 37.917kHz signal at 455kHz
- Carrier Frequency
 - $FCAR = 1/Tc = f_{osc}/12$
 - Duty Ratio = $T1/Tc = 1/3$

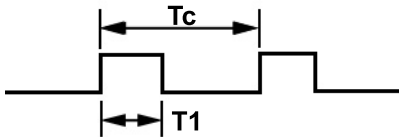

Configuration of frame

- 1st frame

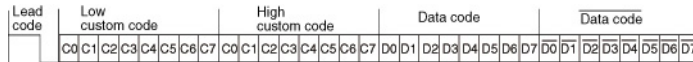

- Repeat frame

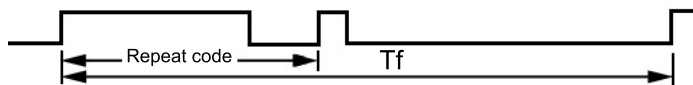

Lead code

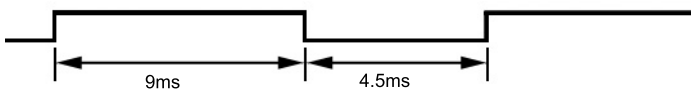

Repeat code

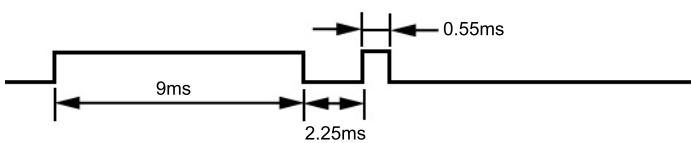

Bit description

- Bit "0"

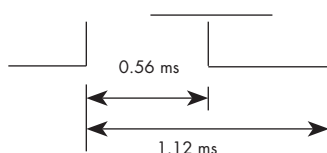

- Bit “1”

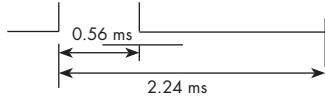

Frame interval: T_f

The waveform is transmitted as long as a key is depressed.

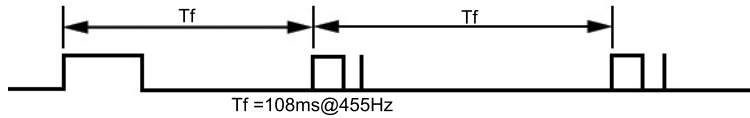

IR Codes Table

Code (Hex)	Function	Note
40	Up arrow ▲	R/C Button
41	Down arrow ▼	R/C Button
06	Right arrow ►	R/C Button
07	Left arrow ◀	R/C Button
08	POWER ON/OFF	R/C Button
C4	MONITOR ON	R/C Button (Discrete IR Code)
C5	MONITOR OFF	R/C Button (Discrete IR Code)
09	MUTE	R/C Button
95	Energy Saving	R/C Button
0B	INPUT	R/C Button
43	MENU	R/C Button
5B	EXIT	R/C Button
4D	PSM	R/C Button
44	OK	R/C Button
10	Number Key 0	R/C Button
11	Number Key 1	R/C Button
12	Number Key 2	R/C Button
13	Number Key 3	R/C Button
14	Number Key 4	R/C Button
15	Number Key 5	R/C Button
16	Number Key 6	R/C Button
17	Number Key 7	R/C Button
18	Number Key 8	R/C Button

Code (Hex)	Function	Note
19	Number Key 9	R/C Button
79	ARC (MARK)	R/C Button (Discrete IR Code)
02	Vol+	R/C Button
03	Vol-	R/C Button
E0	Bright^ (Page UP)	R/C Button
E1	Brightv (Page Down)	R/C Button
28	BACK	R/C Button
99	AUTO CONFIG	R/C Button
72	ID ON (Red Color)	R/C Button (Discrete IR Code)
71	ID OFF (Green Color)	R/C Button
63	(Yellow Color)	R/C Button
61	(Blue Color)	R/C Button
7B	TILE	R/C Button
B0	Play ▶	R/C Button
B1	Stop ■	R/C Button
BA	Pause II	R/C Button
8F	Reverse ◀◀	R/C Button
8E	Fast forward ▶▶	R/C Button
D5	RGB PC	Discrete IR Code (Input RGB PC Selection)
C6	HDMI/DVI	Discrete IR Code (Input HDMI/DVI Selection)
76	ARC (4:3)	Discrete IR Code (Only 4:3 mode)
77	ARC (16:9)	Discrete IR Code (Only 16:9 mode)
AF	ARC (ZOOM)	Discrete IR Code (Only ZOOM, Cinema ZOOM mode)
C8	USB	

D Agency regulatory notices

Federal Communications Commission notice

This equipment has been tested and found to comply with the limits for a Class B digital device, pursuant to Part 15 of the FCC Rules. These limits are designed to provide reasonable protection against harmful interference in a residential installation. This equipment generates, uses, and can radiate radio frequency energy and, if not installed and used in accordance with the instructions, may cause harmful interference to radio communications. However, there is no guarantee that interference will not occur in a particular installation. If this equipment does cause harmful interference to radio or television reception, which can be determined by turning the equipment off and on, the user is encouraged to try to correct the interference by one or more of the following measures:

- Reorient or relocate the receiving antenna.
- Increase the separation between the equipment and the receiver.
- Connect the equipment into an outlet on a circuit different from that to which the receiver is connected.
- Consult the dealer or an experienced radio or television technician for help.

Modifications

The FCC requires the user to be notified that any changes or modifications made to this device that are not expressly approved by Hewlett Packard Company may void the user's authority to operate the equipment.

Cables

Connections to this device must be made with shielded cables with metallic RFI/EMI connector hoods to maintain compliance with FCC Rules and Regulations.

Declaration of Conformity for products marked with the FCC logo (United States only)

This device complies with Part 15 of the FCC Rules. Operation is subject to the following two conditions:

1. This device may not cause harmful interference.
2. This device must accept any interference received, including interference that may cause undesired operation.

For questions regarding the product, contact:

Hewlett Packard Company

P. O. Box 692000, Mail Stop 530113

Houston, Texas 77269-2000

Or, call 1-800-HP-INVENT (1-800 474-6836)

For questions regarding this FCC declaration, contact:

Hewlett Packard Company

P. O. Box 692000, Mail Stop 510101

Houston, Texas 77269-2000

Or, call (281) 514-3333

To identify this product, refer to the Part, Series, or Model number found on the product.

Canadian notice

This Class B digital apparatus meets all requirements of the Canadian Interference-Causing Equipment Regulations.

Avis Canadien

Cet appareil numérique de la classe B respecte toutes les exigences du Règlement sur le matériel brouilleur du Canada.

European Union regulatory notice



Products bearing the CE marking comply with the following EU Directives:

- Low Voltage Directive 2006/95/EC
- EMC Directive 2004/108/EC
- Ecodesign Directive 2009/125/EC, where applicable

CE compliance of this product is valid if powered with the correct CE-marked AC adapter provided by HP.

Compliance with these directives implies conformity to applicable harmonized European standards (European Norms) that are listed in the EU Declaration of Conformity issued by HP for this product or product family and available (in English only) either within the product documentation or at the following web site: www.hp.eu/certificates (type the product number in the search field).

The compliance is indicated by one of the following conformity markings placed on the product:

	For non-telecommunications products and for EU harmonized telecommunications products, such as Bluetooth® within power class below 10mW.
	For EU non-harmonized telecommunications products (If applicable, a 4-digit notified body number is inserted between CE and !).

Please refer to the regulatory label provided on the product.

The point of contact for regulatory matters is: Hewlett-Packard GmbH, Dept./MS: HQ-TRE, Herrenberger Strasse 140, 71034 Boeblingen, GERMANY.

German ergonomics notice

HP products which bear the “GS” approval mark, when forming part of a system comprising HP brand computers, keyboards and monitors that bear the “GS” approval mark, meet the applicable ergonomic requirements. The installation guides included with the products provide configuration information.

Japanese notice

この装置は、クラスB情報技術装置です。この装置は、家庭環境で使用することを目的としていますが、この装置がラジオやテレビジョン受信機に近接して使用されると、受信障害を引き起こすことがあります。取扱説明書に従って正しい取り扱いをして下さい。

VCCI-B

Korean notice

B급 기기

(가정용 방송통신기기)

이 기기는 가정용(B급)으로 전자파적합등록을 한 기기로서 주로 가정에서 사용하는 것을 목적으로 하며, 모든 지역에서 사용할 수 있습니다.

Power cord set requirements

The display power supply is provided with Automatic Line Switching (ALS). This feature allows the display to operate on input voltages between 100–120V or 200–240V.

The power cord set (flexible cord or wall plug) received with the display meets the requirements for use in the country where you purchased the equipment.

If you need to obtain a power cord for a different country, you should purchase a power cord that is approved for use in that country.

The power cord must be rated for the product and for the voltage and current marked on the product's electrical ratings label. The voltage and current rating of the cord should be greater than the voltage and current rating marked on the product. In addition, the cross-sectional area of the wire must be a minimum of 0.75 mm² or 18 AWG, and the length of the cord must be between 6 feet (1.8 m) and 12 feet (3.6 m). If you have questions about the type of power cord to use, contact an authorized HP service provider.

A power cord should be routed so that it is not likely to be walked on or pinched by items placed upon it or against it. Particular attention should be paid to the plug, electrical outlet, and the point where the cord exits from the product.

Japanese power cord requirements

For use in Japan, use only the power cord received with this product.

⚠ CAUTION: Do not use the power cord received with this product on any other products.

Product environmental notices

Materials disposal

This HP product contains mercury in the fluorescent lamp in the display LCD that might require special handling at end-of-life.

Disposal of this material can be regulated because of environmental considerations. For disposal or recycling information, contact the local authorities or the Electronic Industries Alliance (EIA) www.eiae.org.

Disposal of waste equipment by users in private households in the European Union



This symbol on the product or on its packaging indicates that this product must not be disposed of with your household waste. Instead, it is your responsibility to dispose of your waste equipment by handing it over to a designated collection point for the recycling or waste electrical and electronic equipment. The separate collection and recycling of your waste equipment at the time of disposal will help to conserve natural resources and ensure that it is recycled in a manner that protects human health and the environment. For more information about where you can drop off your waste equipment for recycling, please contact the local city office, the household waste disposal service or the shop where you purchased the product.

Chemical substances

HP is committed to providing our customers with information about the chemical substances in our products as needed to comply with legal requirements such as REACH (Regulation EC No 1907/2006 of the European Parliament and Council). A chemical information report for this product can be found at www.hp.com/go/reach.

HP recycling program

HP encourages customers to recycle used electronic hardware, HP original print cartridges, and rechargeable batteries. For more information about recycling programs, go to www.hp.com/recycle.

Restriction of Hazardous Substances (RoHS)

A Japanese regulatory requirement, defined by specification JIS C 0950, 2005, mandates that manufacturers provide Material Content Declarations for certain categories of electronic products offered for sale after July 1, 2006. To view the JIS C 0950 material declaration for this product, visit www.hp.com/go/jisc0950.

2008年、日本における製品含有表示方法、JISC0950が公示されました。製造事業者は、2006年7月1日以降に販売される電気・電子機器の特定化学物質の含有につきまして情報提供を義務付けられました。製品の部材表示につきましては、www.hp.com/go/jisc0950を参照してください。

有毒有害物质/元素的名称及含量表

根据中国
《电子信息产品污染控制管理办法》

液晶显示器

部件名称	有毒有害物质和元素					
	铅 (Pb)	汞 (Hg)	镉 (Cd)	六价铬 (Cr(VI))	多溴联苯 (PBB)	多溴二苯醚 (PBDE)
液晶显示器显示面板	X	X	○	○	○	○
机箱/其它	X	○	○	○	○	○

CRT 显示器

部件名称	有毒有害物质和元素					
	铅 (Pb)	汞 (Hg)	镉 (Cd)	六价铬 (Cr(VI))	多溴联苯 (PBB)	多溴二苯醚 (PBDE)
阴极射线管	X	○	○	○	○	○
机箱/其它	X	○	○	○	○	○

O: 表示该有毒或有害物质在该部件所有均质材料中的含量均在 SJ/T11363-2006 标准规定的限量要求以下。

X: 表示该有毒或有害物质至少在该部件所用的某一均质材料中的含量超出 SJ/T11363-2006 标准规定的限量要求。

表中标有“X”的所有部件都符合欧盟 RoHS 法规 — “欧洲议会和欧盟理事会 2003 年 1 月 27 日关于电子电器设备中限制使用某些有害物质的 2002/95/EC 号指令”。

注: 环保使用期限的参考标识取决于产品正常工作的温度和湿度等条件。

Turkey EEE regulation

In Conformity with the EEE Regulation

EEE Yönetmeliğine Uygundur

Ukraine Restriction of Hazardous Substances

Обладнання відповідає вимогам Технічного регламенту щодо обмеження використання деяких небезпечних речовин в електричному та електронному обладнанні, затвердженого постановою Кабінету Міністрів України від 3 грудня 2008 № 1057.

The equipment complies with requirements of the Technical Regulation, approved by the Resolution of Cabinet of Ministry of Ukraine as of December 3, 2008, in terms of restrictions for the use of certain dangerous substances in electrical and electronic equipment.