



HP EliteBook 8560p Notebook PC  
HP ProBook 6560b Notebook PC

Maintenance and Service Guide

© Copyright 2011 Hewlett-Packard  
Development Company, L.P.

Bluetooth is a trademark owned by its proprietor and used by Hewlett-Packard Company under license. Intel and Core are trademarks or registered trademarks of Intel Corporation in the United States and other countries. Microsoft, Windows, and Windows Vista are either trademarks or registered trademarks of Microsoft Corporation in the United States and/or other countries. SD Logo is a trademark of its proprietor.

The information contained herein is subject to change without notice. The only warranties for HP products and services are set forth in the express warranty statements accompanying such products and services. Nothing herein should be construed as constituting an additional warranty. HP shall not be liable for technical or editorial errors or omissions contained herein.

Fifth Edition: October 2011

First Edition: March 2011

Document Part Number: 644148-005

## Safety warning notice

---

 **WARNING!** To reduce the possibility of heat-related injuries or of overheating the computer, do not place the computer directly on your lap or obstruct the computer air vents. Use the computer only on a hard, flat surface. Do not allow another hard surface, such as an adjoining optional printer, or a soft surface, such as pillows or rugs or clothing, to block airflow. Also, do not allow the AC adapter to contact the skin or a soft surface, such as pillows or rugs or clothing, during operation. The computer and the AC adapter comply with the user-accessible surface temperature limits defined by the International Standard for Safety of Information Technology Equipment (IEC 60950).

---



---

# Table of contents

<b>1 Product description .....</b>	<b>1</b>
<b>2 External component identification .....</b>	<b>9</b>
Display .....	9
Top .....	11
TouchPad .....	11
Lights .....	12
Buttons and fingerprint reader .....	14
Keys .....	16
Front .....	18
Left .....	19
Rear .....	21
Right .....	22
Bottom .....	23
<b>3 Illustrated parts catalog .....</b>	<b>25</b>
Service tag .....	25
Computer major components .....	26
Display components .....	34
Plastics Kit .....	36
Cable Kit .....	37
Mass storage devices .....	38
Miscellaneous parts .....	39
Sequential part number listing .....	40
<b>4 Removal and replacement procedures .....</b>	<b>51</b>
Preliminary replacement requirements .....	51
Tools required .....	51
Service considerations .....	51
Plastic parts .....	51
Cables and connectors .....	52

Drive handling .....	52
Grounding guidelines .....	53
Electrostatic discharge damage .....	53
Packaging and transporting guidelines .....	54
Workstation guidelines .....	54
Equipment guidelines .....	55
Component replacement procedures .....	56
Service tag .....	56
Computer feet .....	57
Battery .....	58
Display assembly (panel, bezel, webcam, microphone) .....	59
SIM .....	63
Bottom door .....	64
Optical drive .....	65
Upgrade bay .....	67
Hard drive .....	69
RTC battery .....	71
Memory modules .....	72
WWAN module .....	74
WLAN module .....	76
Bluetooth module .....	81
Modem module .....	83
Fan .....	85
Heat sink .....	86
Processor .....	90
Keyboard .....	92
Bottom cover .....	94
Speaker assembly .....	99
RJ-11 jack cable .....	101
Function board .....	103
USB board .....	105
System board .....	106
Display assembly and components (whole hinge-up, cable, antennas, hinges, enclosure) .....	111
<b>5 Computer Setup (BIOS) and System Diagnostics .....</b>	<b>120</b>
Using Computer Setup .....	120
Starting Computer Setup .....	120
Navigating and selecting in Computer Setup .....	120
Restoring factory settings in Computer Setup .....	121
Updating the BIOS .....	122

Determining the BIOS version .....	122
Downloading a BIOS update .....	122
Using System Diagnostics .....	123
<b>6 Specifications .....</b>	<b>124</b>
Computer specifications .....	124
39.6-cm (15.6-in), HD display specifications .....	125
39.6-cm (15.6-in), HD+ display specifications .....	126
Hard drive specifications .....	127
Blu-ray BD-R/RE + DVDSM DL Drive .....	128
DVD±RW and CD-RW SuperMulti DL Combo Drive specifications .....	129
Blu-ray Disc ROM with SuperMulti DVD±R/RW DL Drive .....	130
DVD-ROM Drive specifications .....	131
Specification information in Device Manager .....	132
<b>7 Backup and recovery .....</b>	<b>133</b>
Windows 7 .....	133
Backing up your information .....	133
Performing a system recovery .....	134
Using the Windows recovery tools .....	135
Using f11 recovery tools .....	135
Using a Windows 7 operating system DVD (purchased separately) .....	136
Windows Vista .....	137
Backing up your information .....	137
Performing a recovery .....	138
Using the Windows recovery tools .....	138
Using f11 recovery tools .....	139
Using a Windows Vista operating system DVD (purchased separately) .....	139
<b>8 Power cord set requirements .....</b>	<b>141</b>
Requirements for all countries and regions .....	141
Requirements for specific countries and regions .....	142
<b>9 Recycling .....</b>	<b>143</b>
Battery .....	143
Display .....	143
<b>Index .....</b>	<b>149</b>





# 1 Product description

Category	Description	HP ProBook 6560b Notebook PC	HP EliteBook 8560p Notebook PC
<b>Product Name</b>	<b>HP ProBook 6560p Notebook PC</b>	√	
	<b>HP EliteBook 8560p Notebook PC</b>		√
<b>Processors</b>	<b>Intel® Core™ i7 processor, Dual Core</b>		
	2620M, 2.70-GHz (Turbo up to 3.40) processor 4-MB L3 cache, 4 threads	√	
	<b>Intel® Core i5 processors, Dual Core</b> (not available with iAMT, Intel QM67 chipset)		
	2540M, 2.60-GHz (Turbo up to 3.30) processor 3-MB L3 cache, 4 threads	√	
	2520M, 2.50-GHz (Turbo up to 3.20) processor 3-MB L3 cache, 4 threads	√	√
	2410M, 2.30-GHz (Turbo up to 2.90) processor 3-MB L3 cache, 4 threads	√	√
	<b>Intel Core i3 processors, Dual Core</b> (not available with iAMT, Intel QM67 chipset)		
	2310M, 2.10-GHz processor 3-MB L3 cache	√	√
<b>Chipset</b>	<b>Intel Celeron processor, Dual Core</b>		
	B810, 1.60-GHz processor 2-MB L3 cache, 2 threads	√	
<b>Chipset</b>	Mobile Intel HM65 chipset (Non-vPro configurations)	√	
	Mobile Intel QM67 chipset (vPro configurations)	√	
<b>Graphics</b>	Intel HD Graphics 3000 (UMA)	√	√
	AMD Radeon™ HD 6470M (discrete)	√	√
	Supports dual-display ports through the dock	√	√
<b>Panel</b>	All display assemblies include 2 wireless local area network (WLAN) antennas	√	√

Category	Description	HP ProBook 6560b Notebook PC	HP EliteBook 8560p Notebook PC
	39.6-cm (15.6-in) HD, anti-glare, LED SVA (1366x768)	√	√
	39.6-cm (15.6-in) HD+, anti-glare, LED SVA (1600x900)	√	√
	39.6-cm (15.6-in) HD, anti-glare, LED SVA (1366x768) with WWAN	√	
	39.6-cm (15.6-in) HD+, anti-glare, LED SVA (1600x900) with WWAN	√	
	39.6-cm (15.6-in) HD, anti-glare, LED SVA (1366x768) with camera	√	√
	39.6-cm (15.6-in) HD+, anti-glare, LED SVA (1600x900) with camera	√	√
	39.6-cm (15.6-in) HD, anti-glare, LED SVA (1366x768) with camera and WWAN	√	
	39.6-cm (15.6-in) HD+, anti-glare, LED WVA (1600x900) with camera and WWAN	√	
	Support privacy filter	√	
<b>Memory</b>	Two customer-accessible/upgradeable memory module slots supporting up to 16 GB of RAM	√	√
	Supports dual-channel memory	√	√
	PC3-10600, 1333-MHz, DDR3	√	√
	Supports the following configurations:	√	√
	<ul style="list-style-type: none"> <li>• 16384 (8192 × 2)</li> <li>• 8192 (8192 × 1)</li> <li>• 8192 (4096 × 2)</li> <li>• 6144 (4096 + 2048)</li> <li>• 4096 (2048 × 2)</li> <li>• 4096 (4096 × 1)</li> <li>• 3072 (2048 + 1024)</li> <li>• 2048 (2048 × 1)</li> </ul>		
<b>Hard drives</b>	Supports 9.5-mm or 7-mm, 6.35-cm (2.50-in) SATA hard drives	√	√
	Customer-accessible	√	√
	Supports the following drives:	√	√
	<ul style="list-style-type: none"> <li>• 750-GB, 7200-rpm</li> <li>• 500-GB, 7200-rpm</li> <li>• 320-GB, 7200-rpm</li> <li>• 250-GB, 7200-rpm</li> </ul>		

Category	Description	HP ProBook 6560b Notebook PC	HP EliteBook 8560p Notebook PC
	Supports the following solid-state drives: <ul style="list-style-type: none"> <li>• 160-GB</li> <li>• 128-GB</li> </ul>	√	√
<b>Upgrade bay</b>	Fixed	√	√
	Customer-accessible	√	√
	Serial ATA	√	√
	12.7-mm tray load	√	√
	Supports "No Drive" option	√	√
	Supports the following 12.7-mm SATA optical drives: <ul style="list-style-type: none"> <li>• DVD-ROM</li> <li>• DVD+/-RW SuperMulti DL</li> <li>• Blu-ray ROM DVD+/-RW SuperMulti DL</li> </ul> Supports the following 9.5-mm SATA hard drive: <ul style="list-style-type: none"> <li>• 500-GB, 7200-rpm</li> </ul>	√	√
	Supports the following 12.7-mm SATA optical drive: <ul style="list-style-type: none"> <li>• Blu-ray R/RE DVD +/-RW SuperMulti DL Drive</li> </ul>		√
<b>Microphone</b>	Integrated dual-array microphone (webcam models only)	√	√
	Integrated mono (non-webcam models)	√	
<b>Audio</b>	HP SRS Premium Sound	√	√
	HP Premier Sound	√	
	Stereo speakers (2)	√	√
<b>Webcam</b>	Integrated webcam (720p HD)	√	√
<b>Modem</b>	56K V.92 MDC data/fax modem	√	√
	Modem cable not included	√	√
	Supports "No Modem" option	√	√
<b>Ethernet</b>	Intel 82579LM GbE LAN 10/100/1000 network interface card (NIC) with iAMT (vPro models)	√	√
	Intel 82579V GbE LAN 10/100/1000 network interface card (non-vPro models)	√	
	S3/S4/S5 wake on LAN	√	√
	NIC power down technology	√	√
	Ethernet cable not included	√	√
<b>Wireless</b>	<b>Integrated WLAN options by way of wireless module:</b>		
	Two WLAN antennas built into display assembly	√	

Category	Description	HP ProBook 6560b Notebook PC	HP EliteBook 8560p Notebook PC
	Three WLAN antennas built into display assembly		√
	Supports “no WLAN” option	√	√
	Supports the following WLAN formats:	√	√
	<ul style="list-style-type: none"> <li>• Broadcom 802.11 b/g/n, 1×1</li> <li>• Broadcom 802.11 a/b/g/n, 2×2</li> <li>• Intel Centrino Advanced N 6205, 2×2 a/b/g/n</li> </ul>		
	<ul style="list-style-type: none"> <li>• Intel Centrino Wireless-N 1000, 1×2 b/g/n</li> </ul>	√	
	<ul style="list-style-type: none"> <li>• Atheros 802.11 a/b/g/n 3×3</li> </ul>		√
	<ul style="list-style-type: none"> <li>• Intel Centrino Ultimate-N 6300, 3×3 a/b/g/n</li> </ul>		√
	<b>Integrated WWAN options by way of wireless module:</b>		
	Two WWAN antennas built into display assembly (world-wide 5 band, in WWAN panels only)	√	√
	Subscriber identity module (SIM) security (customer-accessible in battery bay)	√	√
	Supports “no WWAN” option	√	√
	Supports the following WWAN modules:	√	√
	<ul style="list-style-type: none"> <li>• Qualcomm Gobi 3000 HSPA/CDMA with GPS</li> <li>• Ericsson 5521 HSPA+</li> </ul>		
	<b>Integrated personal area network (PAN) options by way of Bluetooth® module:</b>		
	Supports “no PAN” option	√	√
	Integrated Bluetooth 2.1	√	√
<b>External media card</b>	One ExpressCard/54 slot	√	√
	Integrated Media Card Reader with SD, MMC support	√	√
<b>Ports</b>	Audio-in (stereo microphone)	√	√
	Audio-out (stereo headphone)	√	√
	DisplayPort 1.1a	√	√
	DisplayPort 1.2	√	√
	RJ-11 (modem)	√	√
	RJ-45 (Ethernet, includes link and activity lights)	√	√
	USB 3.0		√
	USB 2.0 (3)	√	
	USB 2.0 charging port		√
	eSATA/USB 2.0 combo port	√	√

Category	Description	HP ProBook 6560b Notebook PC	HP EliteBook 8560p Notebook PC
	VGA (Dsub 15-pin) supporting 1920 × 1200 external resolution at 75-GHz (hot plug with auto-detect)	√	√
	1394a	√	√
	Serial port	√	√
	3-pin AC power	√	√
	Secondary battery connector	√	√
	Docking connector	√	√
<b>Docking</b>	HP Docking Station	√	√
	HP Advanced Docking Station	√	√
<b>Keyboard/pointing devices</b>	Keyboard with numeric keypad	√	√
	Dual point	√	√
	Spill-resistant design	√	√
	Full chiclet keyboard	√	√
	Touchpad includes: on/off button, supports 2-way scroll with legend, taps enabled by default, 2-finger scrolling and zoom enabled by default	√	√
<b>Power requirements</b>	Smart AC adapter with localized cable plug support (3-wire plug with ground pin, supports 3-pin DC connector):	√	√
	<ul style="list-style-type: none"> <li>• 90-W</li> <li>• 65-W</li> </ul>		
	9-cell, 3.0-Ah (100-Wh) Li-ion battery	√	√
	6-cell, 2.8-Ah (62-Wh) Li-ion battery	√	√
	6-cell, 2.55-Ah (55-Wh) Li-ion battery	√	
	3-cell, 2.8-Ah (31-Wh) Li-ion battery	√	√
	Supports 9-cell, 73-Wh HP Ultra-Capacity Extended Life Battery	√	√
	Supports 9-cell, 100-Wh HP Extended Life Battery	√	√
	Supports 6-cell, 51-Wh HP Long Life Li-ion battery	√	√
	HP Fast Charge Technology	√	√
<b>Security</b>	Integrated fingerprint reader	√	√
	Integrated smart card reader	√	√
	Security cable slot	√	√
	Trusted platform module (TPM) V.1.2	√	√
	Full volume encryption	√	√
	Preboot authentication (password, smart card)	√	√

Category	Description	HP ProBook 6560b Notebook PC	HP EliteBook 8560p Notebook PC
<b>Operating system</b>	<b>Preinstalled:</b>		
	Windows 7 Professional 32 with Microsoft® Basics	√	√
	Windows 7 Professional 64 with Microsoft Basics	√	√
	Windows 7 Home Premium 64 with Microsoft Basics	√	√
	Windows 7 Home Premium 32 with Microsoft Basics	√	√
	Windows Vista Home Basic 32 with Microsoft Basics	√	√
	Novell™: SuSE Linux™ – SLED 11	√	
	FreeDOS	√	√
	<b>Preinstalled with Microsoft Office:</b>		
	Windows 7 Professional 32 with Microsoft Office 2010 Starter	√	√
	Windows 7 Professional 32 with Microsoft Office 2010 Personal	√	√
	Windows 7 Professional 32 with Microsoft Office 2010 Home & Business	√	√
	Windows 7 Professional 32 with Microsoft Office 2010 Professional	√	√
	Windows 7 Professional 64 with Microsoft Office 2010 Starter	√	√
	Windows 7 Professional 64 with Microsoft Office 2010 Personal	√	√
	Windows 7 Professional 64 with Microsoft Office 2010 Home & Business	√	√
	Windows 7 Professional 64 with Microsoft Office 2010 Professional	√	√
	Windows 7 Home Premium 32 with Microsoft Office 2010 Starter	√	√
	Windows 7 Home Premium 32 with Microsoft Office 2010 Personal	√	√
	Windows 7 Home Premium 32 with Microsoft Office 2010 Home & Business	√	√
	Windows 7 Home Premium 32 with Microsoft Office 2010 Professional	√	√
	Windows 7 Home Premium 64 with Microsoft Office 2010 Starter	√	√
	Windows 7 Premium 64 with Microsoft Office 2010 Professional	√	√
	Windows 7 Starter with Microsoft Office 2010 Starter	√	√
	Windows 7 Home Basic 32 with Microsoft Office 2010 Starter	√	√

Category	Description	HP ProBook 6560b Notebook PC	HP EliteBook 8560p Notebook PC
	Windows Vista Basic 32 with Microsoft Office 2010 Starter	√	√
	Windows Vista Basic 32 with Microsoft Office 2010 Personal	√	√
	Windows Vista Basic 32 with Microsoft Office 2010 Home & Business	√	√
	Windows Vista Basic 32 with Microsoft Office 2010 Professional	√	√
	<b>Restore Media:</b>		
	Windows 7 Professional 64	√	√
	Windows 7 Professional 32	√	√
	Windows 7 Home Basic 32	√	√
	Windows 7 Home Premium 64	√	√
	Windows 7 Home Premium 32	√	√
	Windows 7 Starter 32	√	
	DRDVD Windows 7	√	√
	DRDVD Windows 7 with WinDVD	√	√
	<b>Web-only support:</b>		
	Windows XP Professional 64		√
	Windows XP Professional 32	√	
	Windows Vista Enterprise 32/64	√	√
	Windows Vista Business 32/64	√	√
	Windows 7 Enterprise 32/64	√	√
	Windows 7 Ultimate 32/64	√	√
	<b>Certified:</b>		
	Microsoft WHQL	√	√
	Novell: SuSE Linux	√	√
<b>Serviceability</b>	<b>End-user replaceable parts:</b>		
	AC adapter	√	√
	Battery (system)	√	√
	Hard drive	√	√
	Memory module	√	√
	Optical drive	√	√
	Mini-PCI components (WLAN, WWAN, SIM)	√	√
	Modem	√	√

<b>Category</b>	<b>Description</b>	<b>HP ProBook 6560b Notebook PC</b>	<b>HP EliteBook 8560p Notebook PC</b>
	Keyboard	√	√
	Bluetooth module	√	√



## 2 External component identification

### Display

 **NOTE:** Refer to the illustration that most closely matches your computer.

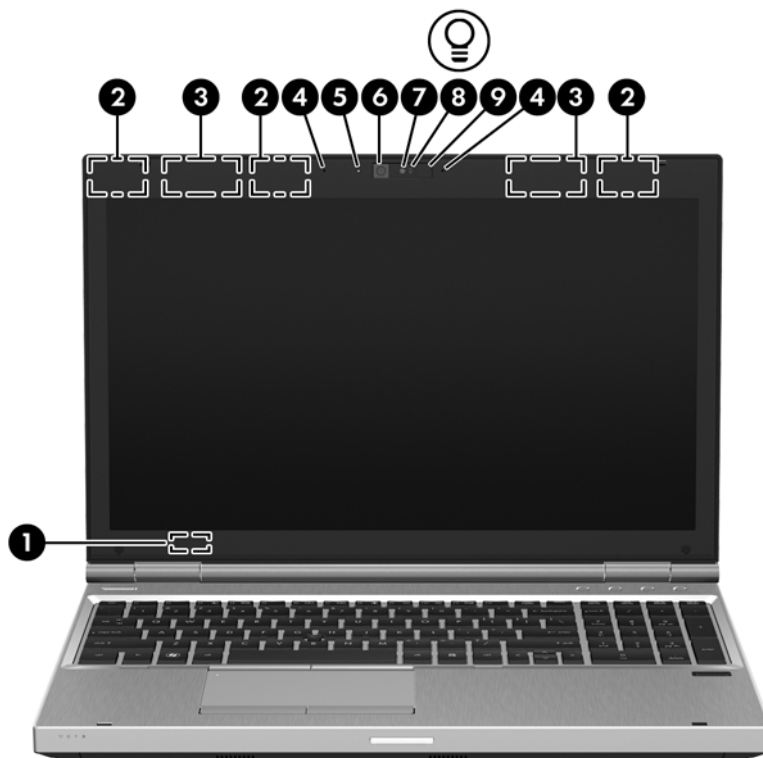

Component	Description
(1) Internal display switch	Turns off the display or initiates Sleep if the display is closed while the power is on. <b>NOTE:</b> The display switch is not visible from the outside of the computer.
(2) WLAN antennas (3)* — 8560p models WLAN antennas (2)* — 6560b models	Send and receive wireless signals to communicate with wireless local area networks (WLAN).
(3) WWAN antennas (2)* (select models only)	Send and receive wireless signals to communicate with wireless wide-area networks (WWAN).
(4) Internal microphones (2) (select models only)	Record sound.

Component	Description
(5) Webcam light (select models only)	On: The webcam is in use.
(6) Webcam (select models only)	Records video and captures still photographs.  To use the webcam, select <b>Start &gt; All Programs &gt; HP &gt; HP Webcam</b> .
(7) Ambient light sensor	When activated, the sensor automatically adjusts the display brightness based on the lighting conditions in your environment.
(8) Keyboard light	On: When the keyboard light is activated.
(9) Keyboard light button	Used to activate the keyboard light.

\*The antennas are not visible from the outside of the computer. For optimal transmission, keep the areas immediately around the antennas free from obstructions. To see wireless regulatory notices, refer to the section of the *Regulatory, Safety and Environmental Notices* that applies to your country or region. These notices are located in Help and Support.

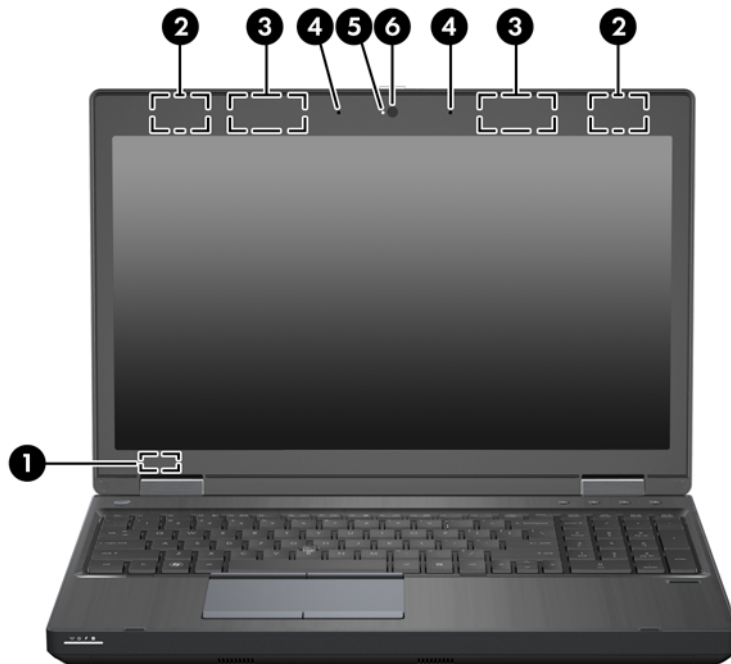

Component	Description
(1) Internal display switch	Turns off the display or initiates Sleep if the display is closed while the power is on.  <b>NOTE:</b> The display switch is not visible from the outside of the computer.
(2) WLAN antennas (2)*	Send and receive wireless signals to communicate with wireless local area networks (WLAN).
(3) WWAN antennas (2)* (select models only)	Send and receive wireless signals to communicate with wireless wide-area networks (WWAN).
(4) Internal microphone(s) (1 or 2 depending on model)	Record sound.
(5) Webcam light (select models only)	On: The webcam is in use.

Component	Description
(6) Webcam (select models only)	Records video and captures still photographs.  To use the webcam, select <b>Start &gt; All Programs &gt; HP &gt; HP Webcam</b> .

\*The antennas are not visible from the outside of the computer. For optimal transmission, keep the areas immediately around the antennas free from obstructions. To see wireless regulatory notices, refer to the section of the *Regulatory, Safety and Environmental Notices* that applies to your country or region. These notices are located in Help and Support.

## Top

### TouchPad

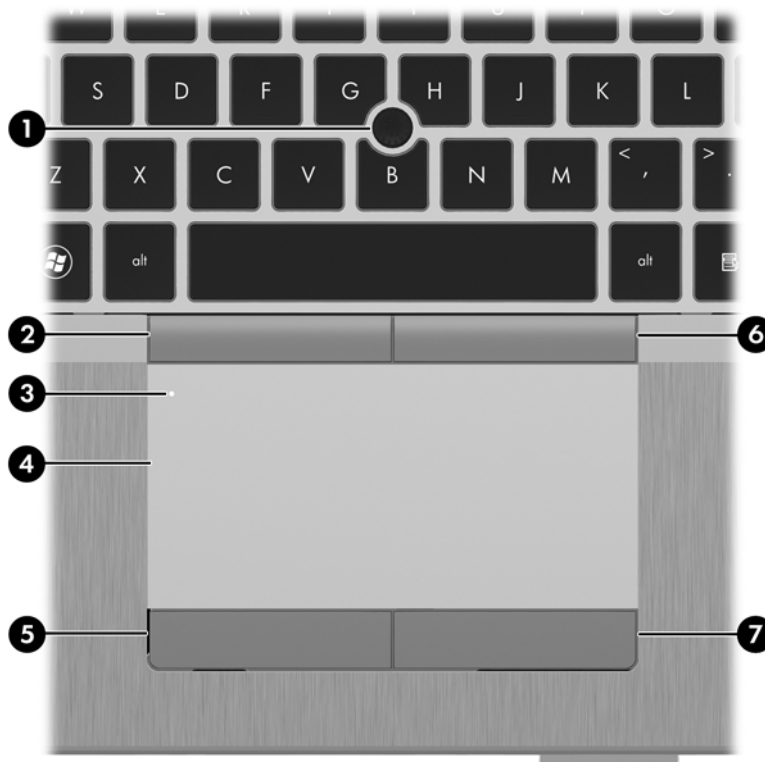

Component	Description
(1) Pointing stick (select models only)	Moves the pointer and selects or activates items on the screen.
(2) Left pointing stick button (select models only)	Can be used with the pointing stick and functions like the left button on an external mouse.
(3) TouchPad on/off button	Turns the TouchPad on and off.
(4) TouchPad	Moves the pointer and selects or activates items on the screen.  <b>NOTE:</b> Vertical scrolling is supported on the right edge of the TouchPad.
(5) Left TouchPad button	Functions like the left button on an external mouse.



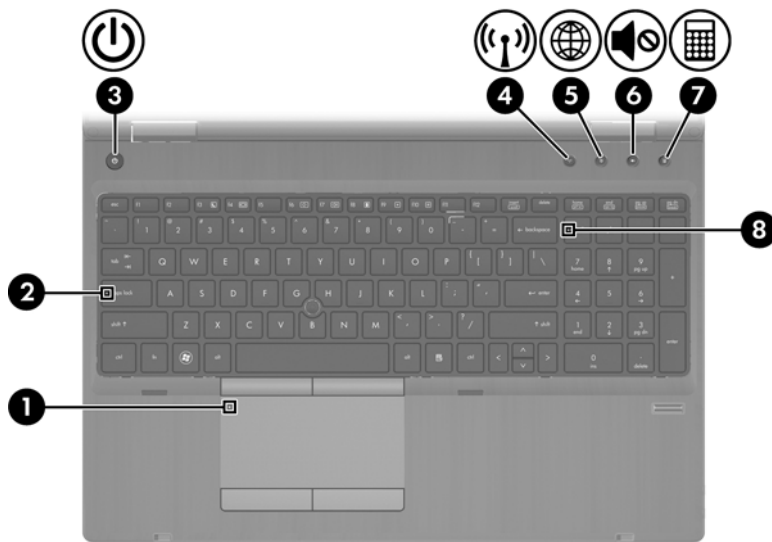
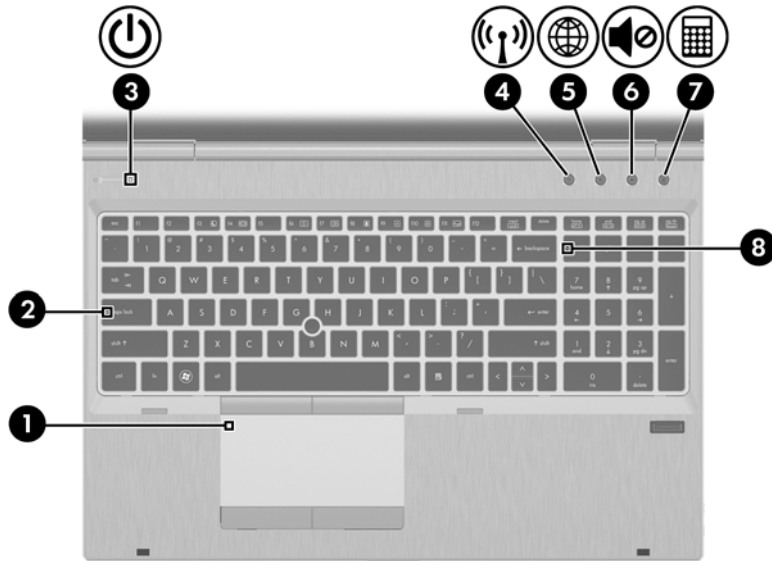

Component		Description
(6)	Right pointing stick button (select models only)	Can be used with the pointing stick and functions like the right button on an external mouse.
(7)	Right TouchPad button	Functions like the right button on an external mouse.

## Lights

 **NOTE:** Refer to the illustration that most closely matches your computer.



Component		Description
(1)	TouchPad on/off light	<ul style="list-style-type: none"> <li>• Amber: The TouchPad is off.</li> <li>• Off: The TouchPad is on.</li> </ul>
(2)	Caps lock light	On: Caps lock is on.





Component	Description
(3)  Power light	<ul style="list-style-type: none"> <li>• On: The computer is on.</li> <li>• Blinking: The computer is in the Sleep state.</li> <li>• Off: The computer is off or in Hibernation.</li> </ul>
(4)  Wireless light	<ul style="list-style-type: none"> <li>• White: An integrated wireless device, such as a wireless local area network (WLAN) device and/or a Bluetooth® device, is on.</li> <li>• Amber: All wireless devices are off.</li> </ul>
(5)  QuickWeb light	<ul style="list-style-type: none"> <li>• On: The computer is on.</li> <li>• Off: The computer is off or in Hibernation.</li> </ul> <p><b>NOTE:</b> For more information, refer to “HP QuickWeb” in this guide and to the HP Quickweb software Help</p>
(6)  Mute light	<ul style="list-style-type: none"> <li>• Amber: Computer sound is off.</li> <li>• Off: Computer sound is on.</li> </ul>
(7)  Calculator light	<ul style="list-style-type: none"> <li>• On: The Windows® calculator function is on.</li> <li>• Blinking: The Windows calculator has been activated.</li> </ul>
(8) Num lock light	On: Num lock is on.

## Buttons and fingerprint reader

 **NOTE:** Refer to the illustration that most closely matches your computer.



Component	Description
(1) TouchPad on/off button	Turns the TouchPad on and off.

Component	Description
(2)  Power button	<ul style="list-style-type: none"> <li>• When the computer is off, press the button to turn on the computer.</li> <li>• When the computer is on, press the button briefly to initiate Sleep.</li> <li>• When the computer is in the Sleep state, press the button briefly to exit Sleep.</li> <li>• When the computer is in Hibernation, press the button briefly to exit Hibernation.</li> </ul> <p>If the computer has stopped responding and Windows® shutdown procedures are ineffective, press and hold the power button for at least 5 seconds to turn off the computer.</p> <p>To learn more about your power settings:</p> <ul style="list-style-type: none"> <li>• <b>Windows 7</b>—Select <b>Start &gt; Control Panel &gt; System and Security &gt; Power Options</b>.</li> <li>• <b>Windows Vista</b>—Select <b>Start &gt; Control Panel &gt; System and Maintenance &gt; Power Options</b></li> <li>• Or refer to the <i>HP Notebook Reference Guide</i>.</li> </ul>
(3)  Wireless button	Turns the wireless feature on or off but does not establish a wireless connection.
(4)  QuickWeb button	<ul style="list-style-type: none"> <li>• When the computer is off or in Hibernation, press the button to open HP QuickWeb.</li> <li>• When the computer is in Microsoft Windows, press the button to open the default Web browser.</li> <li>• When the computer is in HP QuickWeb, press the button to open the default Web browser.</li> </ul> <p><b>NOTE:</b> For more information, refer to “HP QuickWeb” in this guide and to the HP QuickWeb software Help. If your computer does not have HP QuickWeb software, the button does not perform any action or function.</p>
(5)  Volume mute button	Mutes and restores speaker sound.
(6)  Calculator button (select models only)	Opens the Windows calculator function.
(7) Fingerprint reader (select models only)	Allows a fingerprint logon to Windows, instead of a password logon.

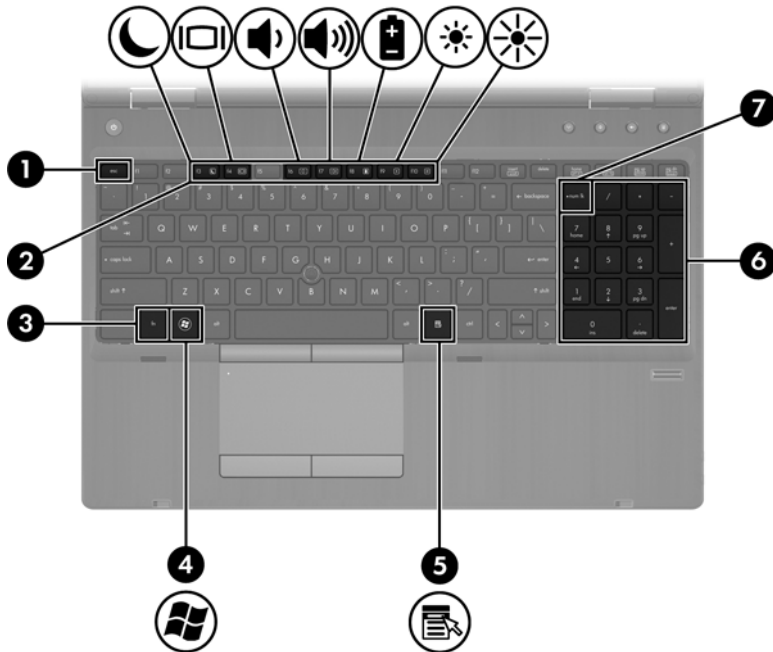
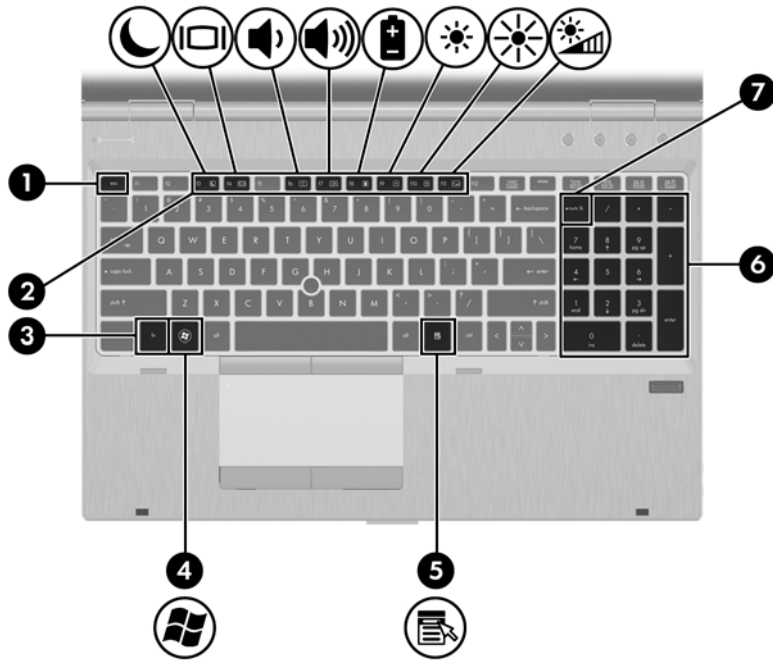

# Keys

 **NOTE:** Refer to the illustration that most closely matches your computer.



Component	Description
(1) <code>esc</code> key	Displays system information when pressed in combination with the <code>fn</code> key.
(2) Function keys	Execute frequently used system functions when pressed in combination with the <code>fn</code> key.



Component	Description
(3) <a href="#">fn</a> key	Executes frequently used system functions when pressed in combination with a function key, the <a href="#">num lk</a> key, or the <a href="#">esc</a> key.
(4)  Start key	Displays the Start menu.
(5)  Menu key	Displays the active program's shortcut menu (same as right-click menu).
(6) Integrated numeric keypad	When the keypad has been enabled, the keys can be used like an external numeric keypad.
(7) <a href="#">num lk</a> key	Enables/disables the embedded numeric keypad when pressed in combination with the <a href="#">fn</a> key.

# Front

 **NOTE:** Refer to the illustration that most closely matches your computer.

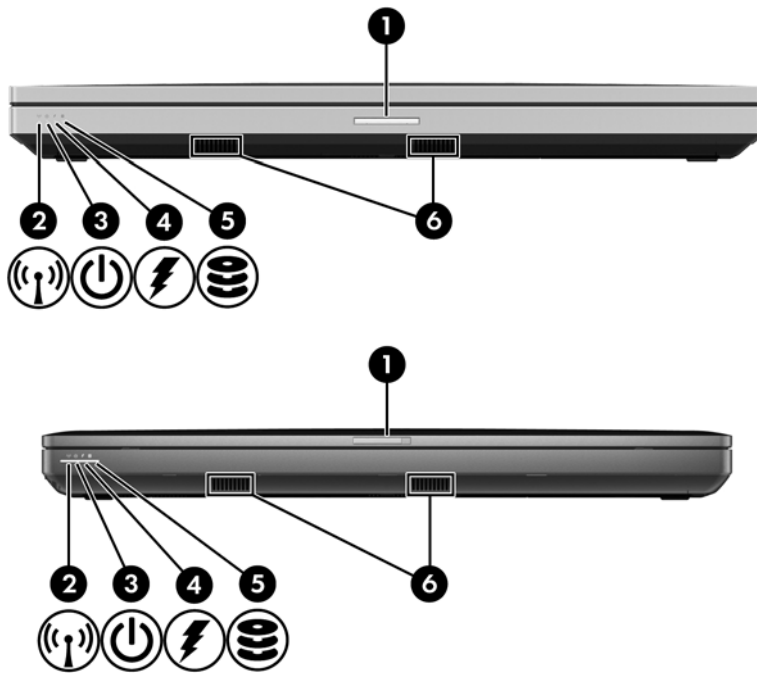

Component	Description
(1) Display release latch	Opens the computer.
(2) Wireless light	<ul style="list-style-type: none"> <li>White: An integrated wireless device, such as a wireless local area network (WLAN) device and/or a Bluetooth® device, is on.</li> <li>Amber: All wireless devices are off.</li> </ul>
(3) Power light	<ul style="list-style-type: none"> <li>On: The computer is on.</li> <li>Blinking: The computer is in the Sleep state.</li> <li>Off: The computer is off or in Hibernation.</li> </ul>
(4) Battery light	<ul style="list-style-type: none"> <li>Amber: The computer is connected to external power and the battery is charged from 0 – 90%.</li> <li>White: The computer is connected to external power and the battery is charged from 90 – 99%.</li> <li>Blinking amber: A battery that is the only available power source has reached a low battery level. When the battery reaches a critical battery level, the battery light begins blinking rapidly.</li> <li>Off: The battery is fully charged.</li> </ul>





Component	Description
(5) Hard drive light	<ul style="list-style-type: none"> <li>Blinking turquoise: The hard drive or optical drive is being accessed.</li> <li>Amber: HP 3D DriveGuard has temporarily parked the hard drive.</li> </ul>
(6) Speakers (2)	Produce SRS Premium sound (select models only).

**NOTE:** To use the SRS Premium sound software, select **Start > All Programs > SRS Premium Sound**.

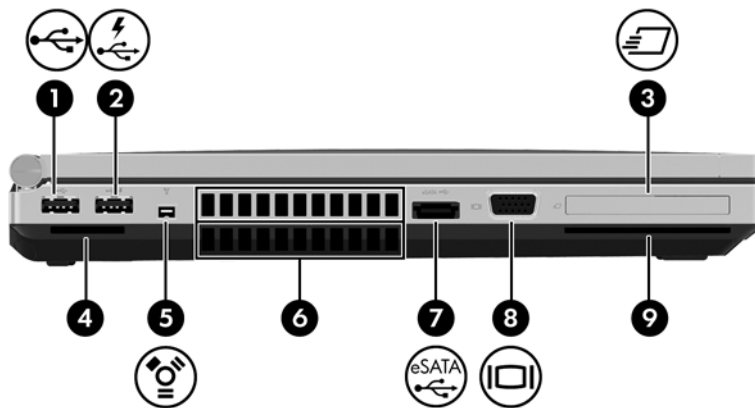

## Left

 **NOTE:** Refer to the illustration that most closely matches your computer.





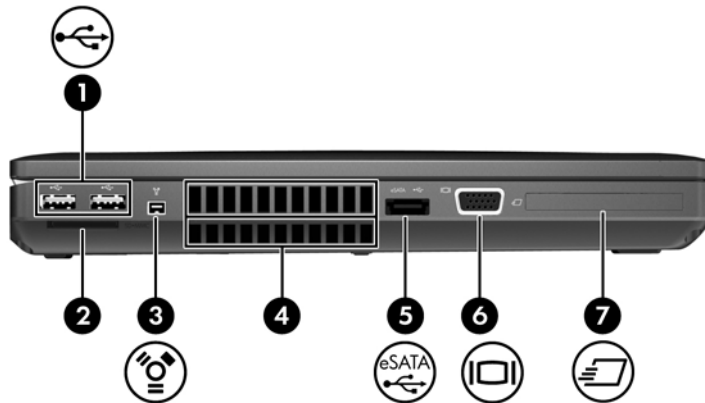

Component	Description
(1)  USB port	Connects an optional USB device.
(2)  USB powered/charging port	Connects an optional USB device.
(3)  ExpressCard slot (select models only)	Supports optional ExpressCards.
(4) Media Card Reader	Supports the following digital card formats: <ul style="list-style-type: none"> <li>Secure Digital (SD) Card</li> <li>MultiMediaCard (MMC)</li> </ul>
(5)  1394 port	Connects an optional IEEE 1394 or 1394a device, such as a camcorder.
(6) Vents (2)	Enable airflow to cool internal components.

**NOTE:** The computer fan starts up automatically to cool internal components and prevent overheating. It is normal for the internal fan to cycle on and off during routine operation.

Component	Description
(7)  eSATA/USB port	Connects a high-performance eSATA component, such as an eSATA external hard drive, or connects an optional USB device.
(8)  External monitor port	Connects an external VGA monitor or projector.
(9) Smart Card reader slot (select models only)	Supports optional Smart Cards.





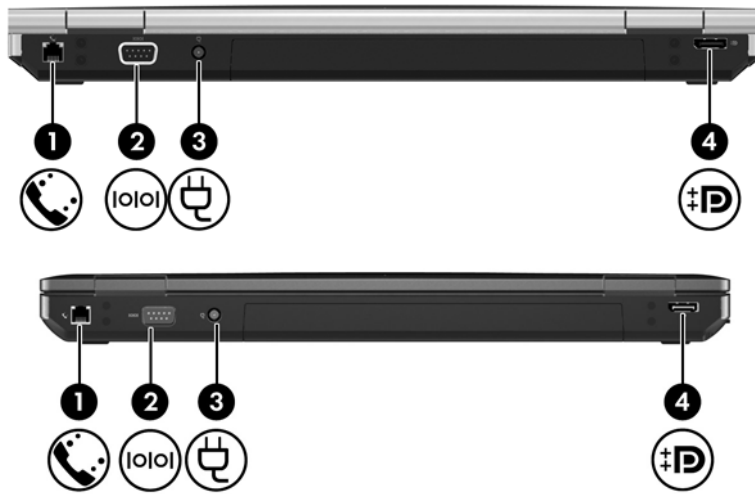

Component	Description
(1)  USB ports (2)	Connects an optional USB device.
(2) Media Card Reader	Supports the following digital card formats: <ul style="list-style-type: none"> <li>• Secure Digital (SD) Card</li> <li>• MultiMediaCard (MMC)</li> </ul>
(3)  1394 port	Connects an optional IEEE 1394 or 1394a device, such as a camcorder.
(4) Vents (2)	Enable airflow to cool internal components.  <b>NOTE:</b> The computer fan starts up automatically to cool internal components and prevent overheating. It is normal for the internal fan to cycle on and off during routine operation.
(5)  eSATA/USB port	Connects a high-performance eSATA component, such as an eSATA external hard drive, or connects an optional USB device.
(6)  External monitor port	Connects an external VGA monitor or projector.
(7)  ExpressCard slot or Smart Card reader slot (depending on configuration)	Supports optional ExpressCards or Smart Cards.

# Rear

 **NOTE:** Refer to the illustration that most closely matches your computer.







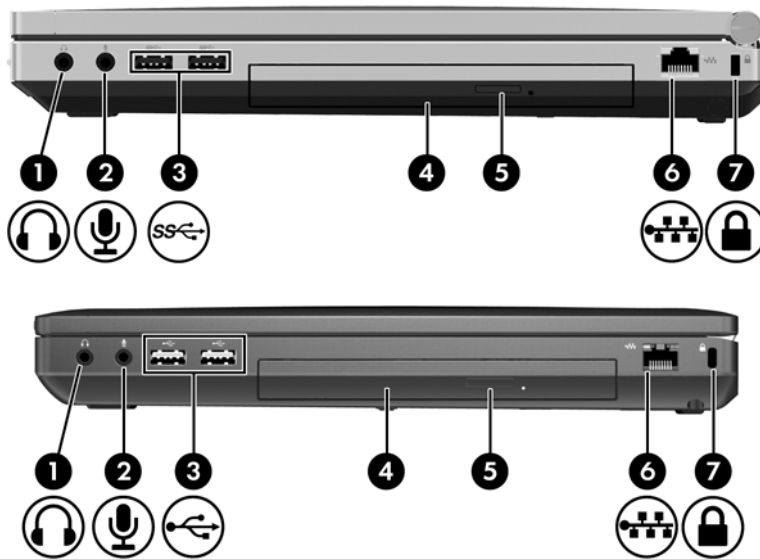

Component	Description
(1) 	RJ-11 (modem) jack Connects a modem cable.
(2) 	Serial port Connects an optional device such as a serial modem, mouse, or printer.
(3) 	Power connector Connects an AC adapter.
(4) 	DisplayPort Connects an optional digital display device, such as a high-performance monitor or projector.

# Right

 **NOTE:** Refer to the illustration that most closely matches your computer.





Component	Description
(1) 	Audio-out (headphone) jack Produces sound when connected to optional powered stereo speakers, headphones, ear buds, a headset, or television audio. <b>NOTE:</b> When a device is connected to the headphone jack, the computer speakers are disabled.
(2) 	Audio-in (microphone) jack Connects an optional computer headset microphone, stereo array microphone, or monaural microphone.
(3) 	SuperSpeed USB ports (2) Connect optional USB devices.
	USB ports (2) Connect optional USB devices.
(4)	Optical drive Reads and writes (select models only) to an optical disc.
(5)	Optical drive eject button Ejects the optical drive.
(6) 	RJ-45 (network) jack Connects a network cable.
(7) 	Security cable slot Attaches an optional security cable to the computer. <b>NOTE:</b> The security cable is designed to act as a deterrent, but it may not prevent the computer from being mishandled or stolen.

# Bottom

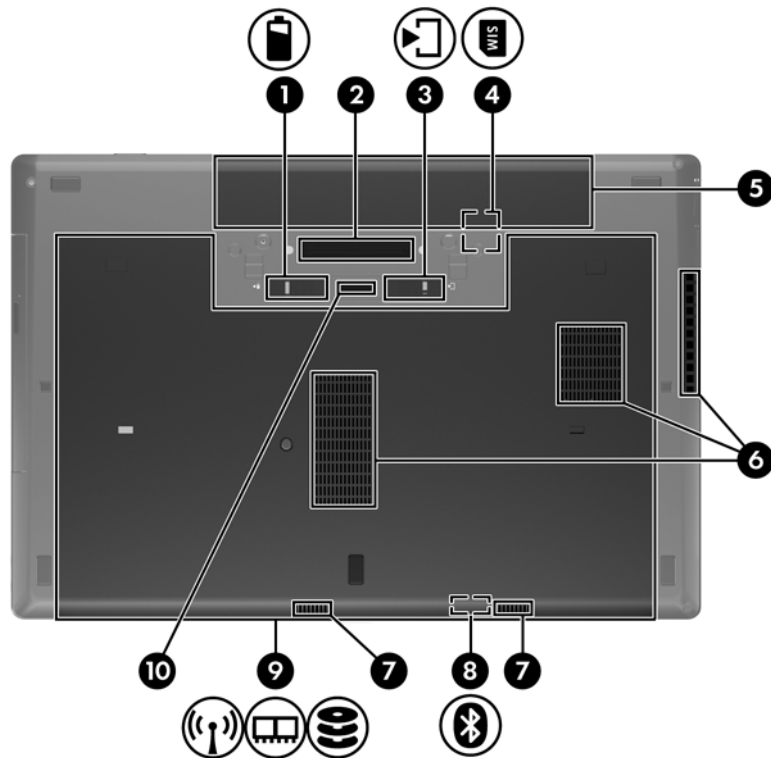
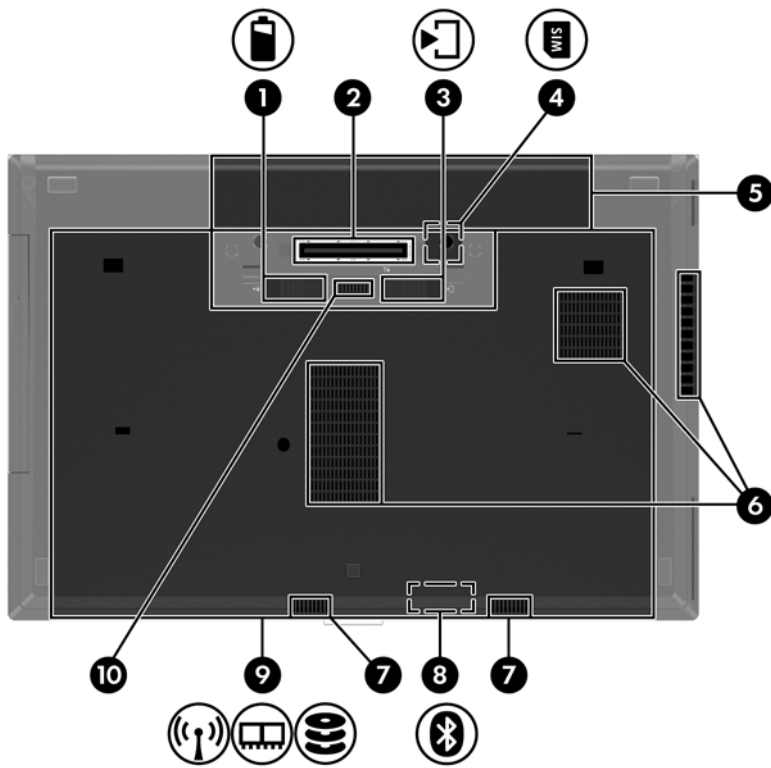
 **NOTE:** Refer to the illustration that most closely matches your computer.



Component	Description
(1)  Battery release latch	Releases the battery from the battery bay.
(2) Docking connector	Connects an optional docking device.
(3) Bottom cover release latch	Releases or locks the bottom cover.
(4) SIM slot	Contains a wireless subscriber identity module (SIM). The SIM slot is located inside the battery bay.
(5) Battery bay	Holds the battery.
(6) Vents (3)	<p>Enable airflow to cool internal components.</p> <p><b>NOTE:</b> The computer fan starts up automatically to cool internal components and prevent overheating. It is normal for the internal fan to cycle on and off during routine operation.</p>
(7) Speakers (2)	Produce sound.
(8) Bluetooth compartment	Contains a Bluetooth device.
(9)  Wireless and memory module compartments and hard drive bay	<p>Hold an HP Mobile Broadband Module, the memory modules, and the hard drive.</p> <p><b>NOTE:</b> To prevent an unresponsive system, replace the wireless module only with a wireless module authorized for use in the computer by the governmental agency that regulates wireless devices in your country or region. If you replace the module and then receive a warning message, remove the module to restore computer functionality, and then contact technical support through Help and Support.</p>
(10) Accessory battery connector	Connects an optional accessory battery.



---

## 3 Illustrated parts catalog

### Service tag

When ordering parts or requesting information, provide the computer serial number and model description provided on the service tag.

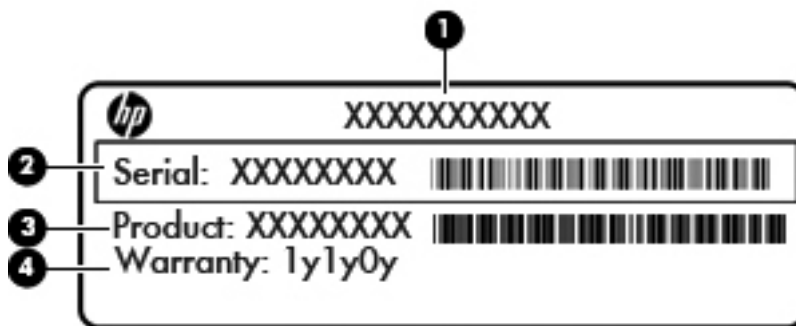

- Product name **(1)**. This is the product name affixed to the front of the computer.
- Serial number (s/n) **(2)**. This is an alphanumeric identifier that is unique to each product.
- Part number/Product number (p/n) **(3)**. This number provides specific information about the product's hardware components. The part number helps a service technician to determine what components and parts are needed.
- Warranty period **(4)**. This number describes the duration (in years) of the warranty period for the computer.

# Computer major components

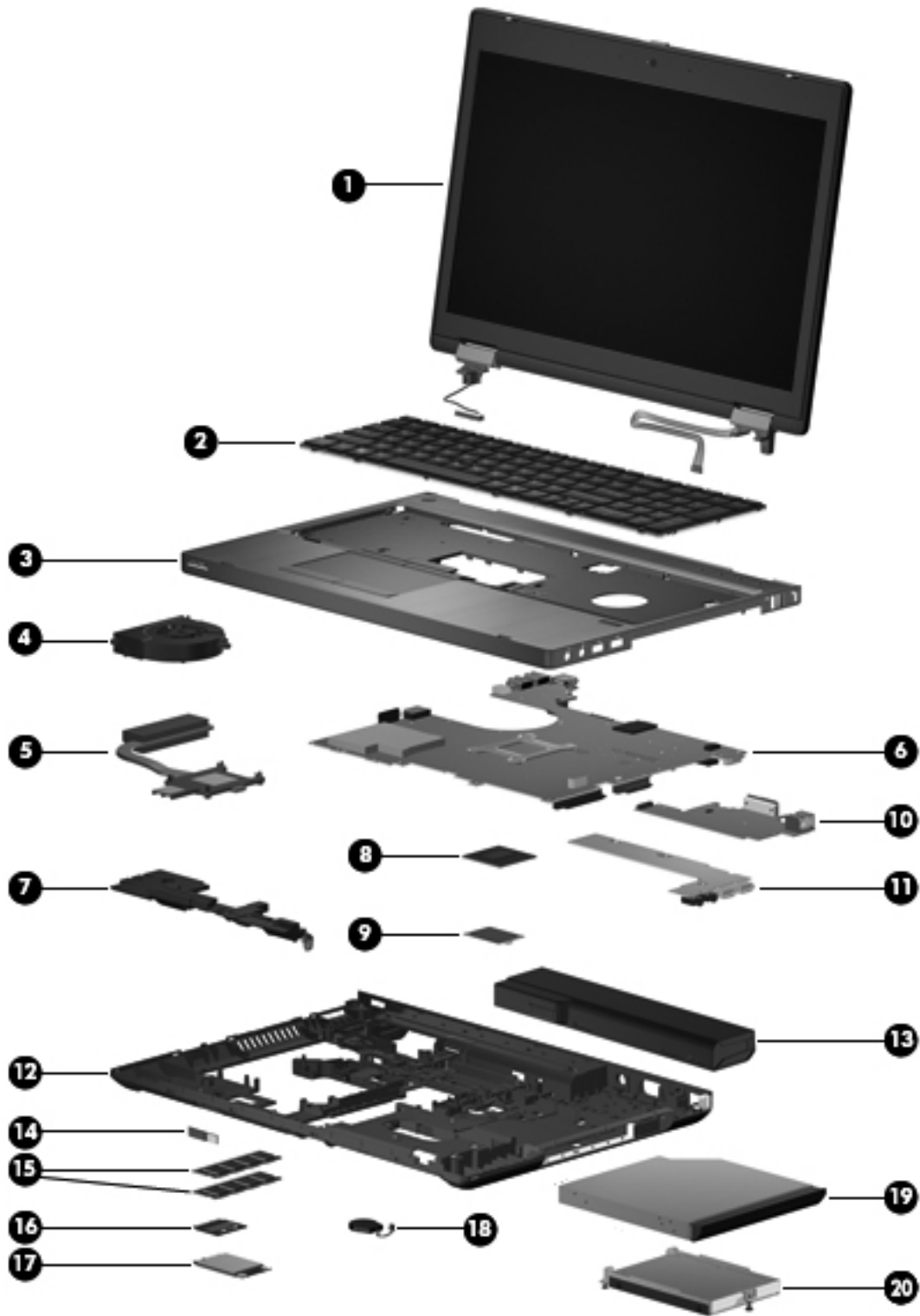

Item	Description	Spare part number
(1)	<b>Display assembly</b>	not spared
	<b>NOTE:</b> For a list of individual parts spared in the display panel, see <a href="#">Display components on page 34</a> .	
(2)	<b>Keyboard</b> (includes cable)	
	<b>NOTE:</b> For a detailed list of available keyboards, see <a href="#">Sequential part number listing on page 40</a> .	
	For use in HP ProBook 6560b models without a pointing stick	641180-xxx
	For use in HP ProBook 6560b models with a pointing stick	641179-xxx
	For use in HP EliteBook 8560p models	641181-xxx
(3)	<b>Top cover</b>	
	For use in model 6560b:	
	• Includes only touchpad	641203-001
	• Includes fingerprint reader, without pointing stick	641204-001
	• Includes fingerprint reader and pointing stick	641205-001
	• Includes pointing stick, without fingerprint reader	641206-001
	For use in model 8560p:	
	• Includes fingerprint reader and pointing stick	641207-001
	• Includes pointing stick, no fingerprint reader	641208-001
(4)	<b>Fan</b>	641183-001
(5)	<b>Heat sink</b> (includes replacement thermal material)	
	For use in models with discrete graphics	647604-001
	For use in models with UMA graphics	647603-001
(6)	<b>System board</b> (includes replacement thermal material and VGA support bracket)	
	For use in HP ProBook 6560b models with discrete graphics:	
	• HM65 with WWAN	
	For use in all countries and regions except for Russia and the People's Republic of China	646963-001
	For use in Russia and the People's Republic of China	653785-001
	• QM67 with WWAN	
	For use in all countries and regions except for Russia and the People's Republic of China	646965-001
	For use in Russia and the People's Republic of China	653787-001
	For use in HP ProBook 6560b models with UMA graphics:	
	• HM65 with WWAN	
	For use in all countries and regions except for Russia and the People's Republic of China	646962-001
	For use in Russia and the People's Republic of China	653784-001

Item	Description	Spare part number
	<ul style="list-style-type: none"> <li>HM65 without WWAN</li> </ul>	
	For use in all countries and regions except for Russia and the People's Republic of China	654129-001
	For use in Russia and the People's Republic of China	654305-001
	<ul style="list-style-type: none"> <li>QM67 with WWAN</li> </ul>	
	For use in all countries and regions except for Russia and the People's Republic of China	646964-001
	For use in Russia and the People's Republic of China	653786-001
	For use in HP EliteBook 8560p models:	
	<ul style="list-style-type: none"> <li>Discrete graphics, QM67</li> </ul>	
	For use in all countries and regions except for Russia and the People's Republic of China	646967-001
	For use in Russia and the People's Republic of China	653789-001
	<ul style="list-style-type: none"> <li>UMA graphics, QM67</li> </ul>	
	For use in all countries and regions except for Russia and the People's Republic of China	646966-001
	For use in Russia and the People's Republic of China	653788-001
(7)	<b>Speaker assembly</b>	641186-001
(8)	<b>Processor</b>	
	<b>Intel Core i7 processors, Quad Core</b>	
	2720QM, 2.2-GHz (turbo up to 3.3-GHz) processor 6-MB L3 cache	631254-005
	2630QM, 2.0-GHz (turbo up to 2.9-GHz) processor 6-MB L3 cache	635501-005
	<b>Intel Core i7 processors, Dual Core</b>	
	2620M, 2.7-GHz (turbo up to 3.4-GHz) processor 4-MB L3 cache	631252-005
	<b>Intel Core i5 processors, Dual Core</b>	
	2540M, 2.6-GHz (turbo up to 3.3-GHz) processor 3-MB L3 cache	
	<ul style="list-style-type: none"> <li>Includes thermal grease</li> </ul>	631255-005
	2520M, 2.5-GHz (turbo up to 3.2-GHz) processor 3-MB L3 cache	
	<ul style="list-style-type: none"> <li>Includes thermal grease</li> </ul>	631253-005
	2410M, 2.3-GHz (turbo up to 2.9-GHz) processor 3-MB L3 cache	638039-005
	<b>Intel Core i3 processors, Dual Core</b>	
	2310M, 2.1-GHz processor 3-MB L3 cache	
	<b>NOTE:</b> At temperatures above 30° C (86° F), the Intel Core i3-2310M Processor may run at decreased performance.	
	<ul style="list-style-type: none"> <li>Includes thermal grease</li> </ul>	638037-005
	<b>Intel Celeron processor, Dual Core</b>	

Item	Description	Spare part number
	B810, 1.6-GHz, with 2-MB L3 cache	646760-005
(9)	<b>Modem module</b>  <b>NOTE:</b> The modem module spare part kit does not include a modem module cable. The modem module cable is included in the Cable Kit, spare part number 646968-001 for use in 6560b models, 641188-001 for use in 8560p models. See <a href="#">Cable Kit on page 37</a> for more Cable Kit spare part number information.	628824-001
(10)	<b>Function board</b> (includes cable)	641187-001
(11)	<b>USB board</b> (includes Mylar)	
	USB 2.0 board for use only in 6560b models	641184-001
	USB 3.0 board for use only in 8560p models	641185-001
(12)	<b>Bottom cover</b> (includes rubber feet)  <b>NOTE:</b> Make sure to remove the modem plug from the slot in the bottom cover if the repaired unit includes a modem.	
	For use with HP ProBook 6560b computer models	644695-001
	For use with HP EliteBook 8560p computer models	641182-001
(13)	<b>Battery, Li-ion</b>	
	9-cell (100 WHr, 3.0 Ah)	631243-001
	9-cell (73 WHr, 2.2 Ah)	634089-001
	6-cell (62 WHr, 2.8 Ah)	628668-001
	6-cell (55 WHr, 2.8 Ah, long life)	628670-001
	6-cell (55 WHr, 2.5 Ah)	628666-001
	3-cell (31 WHr, 2.8 Ah)	628664-001
(14)	<b>Bluetooth module</b> (does not include Bluetooth module cable)  <b>NOTE:</b> The Bluetooth module spare part kit does not include a Bluetooth module cable. The Bluetooth module cable is included in the Cable Kit, spare part number 646968-001 for 6560b models and 641188-001 for 8560p models. See <a href="#">Cable Kit on page 37</a> for more Cable Kit spare part number information.	537921-001
(15)	<b>Memory modules</b> (PC3-10600, 1333-MHz, DDR3)	
	8-GB	634091-001
	4-GB	621569-001
	2-GB	621565-001
(16)	<b>WLAN module</b>	

Item	Description	Spare part number
	Intel Wi-Fi Link 6300, 802.11a/b/g/n for use in Andorra, Antigua and Barbuda, Argentina, Aruba, Australia, Austria, Azerbaijan, Bahamas, Bahrain, Barbados, Belgium, Bermuda, Bolivia, Bosnia and Herzegovina, Brazil, Brunei, Bulgaria, Canada, Cayman Islands, Chile, the People's Republic of China, Colombia, Costa Rica, Croatia, Cyprus, Czech Republic, Denmark, Dominican Republic, Ecuador, Egypt, El Salvador, Estonia, Finland, France, French Guiana, Georgia, Germany, Ghana, Greece, Guadeloupe, Guam, Guatemala, Haiti, Honduras, Hong Kong, Hungary, Iceland, India, Indonesia, Ireland, Israel, Italy, Ivory Coast, Jamaica, Japan, Jordan, Kenya, South Korea, Kuwait, Kyrgyzstan, Latvia, Lebanon, Martinique, US Virgin Islands, Puerto Rico, Nether Antilles, Liechtenstein, Lithuania, Luxembourg, Malawi, Malaysia, Malta, Mauritius, Mexico, Monaco, Montenegro, Morocco, the Netherlands, New Zealand, Nicaragua, Nigeria, Norway, Oman, Pakistan, Panama, Paraguay, Peru, Philippines, Poland, Portugal, Qatar, Romania, San Marino, Saudi Arabia, Senegal, Singapore, Slovakia, Slovenia, South Africa, Spain, Sri Lanka, Sweden, Switzerland, Taiwan, Tanzania, Thailand, Trinidad and Tobago, Turkey, the United Arab Emirates, the United Kingdom, the United States, Uruguay, Venezuela, and Vietnam	572511-001
	Broadcom 43224AGN 802.11a/b/g/draft-n WiFi Adapter for use in Antigua and Barbuda, Aruba, the Bahamas, Barbados, Belize, Canada, Guam, Guinea, Haiti, Jamaica, the Nether Antilles, Puerto Rico, St. Kitts and Nevis, St. Lucia, St. Vincent and the Grenadines, Suriname, the US Virgin Islands, and the United States	582564-001
	Broadcom 43224AGN 802.11a/b/g/draft-n WiFi Adapter for use in Albania, Algeria, Andorra, Angola, Argentina, Armenia, Australia, Austria, Azerbaijan, Bahrain, Belarus, Belgium, Benin, Bermuda, Bhutan, Bolivia, Bosnia and Herzegovina, Botswana, Brazil, the British Virgin Islands, Brunei, Bulgaria, Burkina Faso, Burundi, Cambodia, Cameroon, Cape Verde, the Cayman Islands, Central African Republic, Chad, Chile, People's Republic of China, Colombia, Comoros, Congo, Costa Rica, Croatia, Cyprus, the Czech Republic, Denmark, Djibouti, Dominica, the Dominican Republic, East Timor, Ecuador, Egypt, El Salvador, Equatorial Guinea, Eritrea, Estonia, Ethiopia, Fiji Finland, France, French Guiana, Gabon, Gambia, Georgia, Germany, Ghana, Gibraltar, Greece, Grenada, Guadeloupe, Guatemala, Guinea, Guinea-Bissa, Honduras, Hong Kong, Hungary, Iceland, India, Ireland, Italy, Ivory Coast, Japan, Jordan, Kazakhstan, Kenya, Kiribati, Kuwait, Kyrgyzstan, Laos, Latvia, Lebanon, Lesotho, Liberia, Liechtenstein, Lithuania, Luxembourg, Macedonia, Madagascar, Malawi, Malaysia Maldives, Mali, Malta, Marshall Islands, Martinique, Mauritania, Mauritius, Mexico, Micronesia, Monaco, Mongolia, Montenegro, Morocco, Mozambique, Namibia, Nauru, Nepal, Netherlands, New Zealand, Nicaragua, Niger, Nigeria, Norway, Oman, Palau, Panama, Papua New Guinea, Paraguay, Peru, Philippines, Poland, Portugal, Qatar, Republic of Moldova, Romania, Rwanda, Samoa, San Marino, Sao Tome and Principe, Saudi Arabia, Senegal, Serbia and Montenegro, Seychelles, Sierra Leone, Singapore, Slovakia, Slovenia, Solomon Islands, Somalia, South Africa, South Korea, Spain, Sri Lanka, Swaziland, Sweden, Switzerland, Taiwan, Tajikistan, Tanzania, Thailand, Togo, Tonga, Trinidad and Tobago, Tunisia, Turkey, Turkmenistan, Tuvalu, Uganda, United Arab Emirates, United Kingdom, Uruguay, Uzbekistan, Vanuatu, Venezuela, Vietnam, Yemen, Zaire, Zambia, and Zimbabwe	582564-002

Item	Description	Spare part number
	Broadcom 4313AGN 802.11a/b/g/draft-n WiFi Adapter for use in Afghanistan, Albania, Algeria, Andorra, Angola, Antigua and Barbuda, Argentina, Armenia, Aruba, Australia, Austria, Azerbaijan, Bahamas, Bahrain, Bangladesh, Barbados, Belarus, Belgium, Belize, Benin, Bermuda, Bhutan, Bolivia, Bosnia and Herzegovina, Botswana, Brazil, the British Virgin Islands, Brunei, Bulgaria, Burkina Faso, Burundi, Cambodia, Cameroon, Canada, Cape Verde, the Cayman Islands, Central African Republic, Chad, People's Republic of China, Colombia, Comoros, Congo, Costa Rica, Croatia, Cyprus, the Czech Republic, Denmark, Djibouti, Dominica, the Dominican Republic, East Timor, Ecuador, Egypt, El Salvador, Equatorial Guinea, Eritrea, Estonia, Ethiopia, Fiji, Finland, France, French Guiana, Gabon, Gambia, Georgia, Germany, Ghana, Gibraltar, Greece, Grenada, Guadeloupe, Guam, Guatemala, Guinea, Guinea-Bissa, Guyana, Haiti, Honduras, Hong Kong, Hungary, Iceland, India, Iraq, Ireland, Israel, Italy, Ivory Coast, Jamaica, Japan, Jordan, Kazakhstan, Kenya, Kiribati, Kuwait, Kyrgyzstan, Laos, Latvia, Lebanon, Lesotho, Liberia, Martinique, Liechtenstein, Lithuania, Luxembourg, Macedonia, Madagascar, Malawi, Malaysia, Maldives, Mali, Malta, Marshall Islands, Mauritania, Mauritius, Mexico, Micronesia, Monaco, Mongolia, Montenegro, Morocco, Mozambique, Namibia, Nauru, Nepal, the Nether Antilles, the Netherlands, New Zealand, Nicaragua, Niger, Nigeria, Norway, Oman, Pakistan, Palau, Panama, Papua New Guinea, Paraguay, Puerto Rico, Peru, Philippines, Poland, Portugal, Qatar, Republic of Moldova, Romania, Russia, Rwanda, Samoa, San Marino, Sao Tome and Principe, Saudi Arabia, Senegal, Serbia and Montenegro, Seychelles, Sierra Leone, Singapore, Slovakia, Slovenia, Solomon Islands, Somalia, South Africa, South Korea, Spain, Sri Lanka, St. Kitts and Nevis, St. Lucia, St. Vincent and the Grenadines, Suriname, Swaziland, Sweden, Switzerland, Syria, Taiwan, Tajikistan, Tanzania, Thailand, Togo, Tonga, Trinidad and Tobago, Tunisia, Turkey, Turkmenistan, Tuvalu, Uganda, Ukraine, the United Arab Emirates, the United Kingdom, Uruguay, the United States, the US Virgin Islands, Uzbekistan, Vanuatu, Venezuela, Vietnam, Yemen, Zaire, Zambia, and Zimbabwe	593836-001
	Intel Wi-Fi Link 1000 for use in Andorra, Antigua and Barbuda, Argentina, Aruba, Australia, Austria, Azerbaijan, Bahamas, Bahrain, Barbados, Belgium, Bermuda, Bolivia, Bosnia and Herzegovina, Brazil, Brunei, Bulgaria, Canada, the Cayman Islands, Chile, People's Republic of China, Colombia, Costa Rica, Croatia, Cyprus, the Czech Republic, Denmark, the Dominican Republic, Ecuador, Egypt, El Salvador, Estonia, Finland, France, French Guiana, Georgia, Germany, Ghana, Greece, Guadeloupe, Guam, Guatemala, Haiti, Honduras, Hong Kong, Hungary, Iceland, India, Indonesia, Ireland, Israel, Italy, Ivory Coast, Jamaica, Japan, Jordan, Kenya, Kuwait, Kyrgyzstan, Latvia, Lebanon, Liechtenstein, Lithuania, Luxembourg, Malawi, Malaysia, Malta, Martinique, Mauritius, Mexico, Monaco, Montenegro, Morocco, the Nether Antilles, Netherlands, New Zealand, Nicaragua, Nigeria, Norway, Oman, Pakistan, Panama, Paraguay, Peru, Philippines, Poland, Portugal, Puerto Rico, Qatar, Romania, San Marino, Saudi Arabia, Senegal, Singapore, Slovakia, Slovenia, South Africa, South Korea, Spain, Sri Lanka, Sweden, Switzerland, Taiwan, Tanzania, Thailand, Trinidad and Tobago, Turkey, Ukraine, United Arab Emirates, United Kingdom, Uruguay, the US Virgin Islands, the United States, Venezuela, and Vietnam	593530-001

Item	Description	Spare part number
	Atheros HB112AGN 802.11a/b/g/n 3x3 WiFi Adapter for use in Afghanistan, Albania, Algeria, Andorra, Angola, Antigua and Barbuda, Argentina, Armenia, Aruba, Australia, Austria, Azerbaijan, Bahamas, Bahrain, Bangladesh, Barbados, Belarus, Belgium, Belize, Benin, Bermuda, Bhutan, Bolivia, Bosnia and Herzegovina, Botswana, Brazil, the British Virgin Islands, Brunei, Bulgaria, Burkina Faso, Burundi, Cambodia, Cameroon, Canada, Cape Verde, the Cayman Islands, Central African Republic, Chad, People's Republic of China, Colombia, Comoros, Congo, Costa Rica, Croatia, Cyprus, the Czech Republic, Denmark, Djibouti, Dominica, the Dominican Republic, East Timor, Ecuador, Egypt, El Salvador, Equatorial Guinea, Eritrea, Estonia, Ethiopia, Fiji, Finland, France, French Guiana, Gabon, Gambia, Georgia, Germany, Ghana, Gibraltar, Greece, Grenada, Guadeloupe, Guam, Guatemala, Guinea, Guinea-Bissa, Guyana, Haiti, Honduras, Hong Kong, Hungary, Iceland, India, Iraq, Ireland, Israel, Italy, Ivory Coast, Jamaica, Japan, Jordan, Kazakhstan, Kenya, Kiribati, Kuwait, Kyrgyzstan, Laos, Latvia, Lebanon, Lesotho, Liberia, Martinique, Liechtenstein, Lithuania, Luxembourg, Macedonia, Madagascar, Malawi, Malaysia, Maldives, Mali, Malta, Marshall Islands, Mauritania, Mauritius, Mexico, Micronesia, Monaco, Mongolia, Montenegro, Morocco, Mozambique, Namibia, Nauru, Nepal, the Nether Antilles, the Netherlands, New Zealand, Nicaragua, Niger, Nigeria, Norway, Oman, Pakistan, Palau, Panama, Papua New Guinea, Paraguay, Puerto Rico, Peru, Philippines, Poland, Portugal, Qatar, Republic of Moldova, Romania, Russia, Rwanda, Samoa, San Marino, Sao Tome and Principe, Saudi Arabia, Senegal, Serbia and Montenegro, Seychelles, Sierra Leone, Singapore, Slovakia, Slovenia, Solomon Islands, Somalia, South Africa, South Korea, Spain, Sri Lanka, St. Kitts and Nevis, St. Lucia, St. Vincent and the Grenadines, Suriname, Swaziland, Sweden, Switzerland, Syria, Taiwan, Tajikistan, Tanzania, Thailand, Togo, Tonga, Trinidad and Tobago, Tunisia, Turkey, Turkmenistan, Tuvalu, Uganda, Ukraine, the United Arab Emirates, the United Kingdom, Uruguay, the United States, the US Virgin Islands, Uzbekistan, Vanuatu, Venezuela, Vietnam, Yemen, Zaire, Zambia, and Zimbabwe	630435-001
	Intel Centrino Advanced-N 6205 for use in Afghanistan, Albania, Algeria, Andorra, Angola, Antigua and Barbuda, Argentina, Armenia, Australia, Austria, Azerbaijan, Bahamas, Bahrain, Bangladesh, Barbados, Belarus, Belgium, Belize, Benin, Bermuda, Bhutan, Bolivia, Bosnia and Herzegovina, Botswana, Brazil, the British Virgin Islands, Brunei, Bulgaria, Burkina Faso, Burundi, Cambodia, Cameroon, Canada, Cape Verde, the Cayman Islands, Central African Republic, Chad, People's Republic of China, Colombia, Comoros, Congo, Costa Rica, Croatia, Cyprus, the Czech Republic, Denmark, Djibouti, Dominica, the Dominican Republic, East Timor, Ecuador, Egypt, El Salvador, Equatorial Guinea, Eritrea, Estonia, Ethiopia, Fiji, Finland, France, French Guiana, Gabon, Gambia, Georgia, Germany, Ghana, Gibraltar, Greece, Grenada, Guadeloupe, Guam, Guatemala, Guinea, Guinea-Bissa, Guyana, Haiti, Honduras, Hong Kong, Hungary, Iceland, India, Iraq, Israel, Italy, Ivory Coast, Jamaica, Japan, Jordan, Kazakhstan, Kenya, Kiribati, Kuwait, Kyrgyzstan, Laos, Latvia, Lebanon, Lesotho, Liberia, Martinique, Liechtenstein, Lithuania, Luxembourg, Macedonia, Madagascar, Malawi, Malaysia, Maldives, Mali, Malta, Marshall Islands, Mauritania, Mauritius, Mexico, Micronesia, Monaco, Mongolia, Montenegro, Morocco, Mozambique, Namibia, Nauru, Nepal, the Nether Antilles, the Netherlands, New Zealand, Nicaragua, Niger, Nigeria, Norway, Oman, Pakistan, Palau, Panama, Papua New Guinea, Paraguay, Puerto Rico, Peru, Philippines, Poland, Portugal, Qatar, Republic of Moldova, Romania, Russia, Rwanda, Samoa, San Marino, Sao Tome and Principe, Saudi Arabia, Senegal, Serbia and Montenegro, Seychelles, Sierra Leone, Singapore, Slovakia, Slovenia, Solomon Islands, Somalia, South Africa, South Korea, Spain, Sri Lanka, St. Kitts and Nevis, St. Lucia, St. Vincent and the Grenadines, Suriname, Swaziland, Sweden, Switzerland, Syria, Taiwan, Tajikistan, Tanzania, Thailand, Togo, Tonga, Trinidad and Tobago, Tunisia, Turkey, Turkmenistan, Tuvalu, Uganda, Ukraine, the United Arab Emirates, the United Kingdom, Uruguay, the United States, the US Virgin Islands, Uzbekistan, Vanuatu, Venezuela, Vietnam, Yemen, Zaire, Zambia, and Zimbabwe	631954-001
<b>(17)</b>	<b>WWAN modules</b>	
	HP hs2340 HSPA+ Mobile Broadband Module	632155-001
	HP un2430 EV-DO/HSPA Mobile Broadband Module	634400-001
<b>(18)</b>	<b>RTC battery</b>	641200-001
<b>(19)</b>	<b>Optical drive</b> (includes bracket, bezel, and screws)	



Item	Description	Spare part number
	For use in HP ProBook 6560b models:	
	<ul style="list-style-type: none"> <li>Blu-ray ROM DVD±RW SuperMulti DL Drive</li> </ul>	649655-001
	<ul style="list-style-type: none"> <li>DVD±RW and CD-RW SuperMulti DL Combo Drive</li> </ul>	649654-001
	<ul style="list-style-type: none"> <li>DVD-ROM Drive</li> </ul>	649653-001
	For use in HP EliteBook 8560p models:	
	<ul style="list-style-type: none"> <li>Blu-ray BD-R/RE DVD±RW SuperMulti DL Drive</li> </ul>	651044-001
	<ul style="list-style-type: none"> <li>Blu-ray ROM DVD±RW SuperMulti DL Drive</li> </ul>	651043-001
	<ul style="list-style-type: none"> <li>DVD±RW and CD-RW SuperMulti DL Combo Drive</li> </ul>	651042-001
	<ul style="list-style-type: none"> <li>DVD-ROM Drive</li> </ul>	651041-001
	<b>Cable Kit</b> (not illustrated; see <a href="#">Cable Kit on page 37</a> for more Cable Kit spare part number information)	
	For use in HP ProBook 6560b models	646968-001
	For use in HP EliteBook 8560p models	641188-001
<b>(20)</b>	<b>Hard drive</b>	
	750-GB, 7200-rpm	633252-001
	500-GB, 7200-rpm, for use in either the hard drive bay or the upgrade drive bay	634919-001
	320-GB, 7200-rpm, Self-Encrypting Drive (SED)	626978-001
	320-GB, 7200-rpm	641672-001
	250-GB, 7200-rpm	635225-001
	160-GB solid-state drive	649652-001
	128-GB solid-state drive	649651-001

## Display components

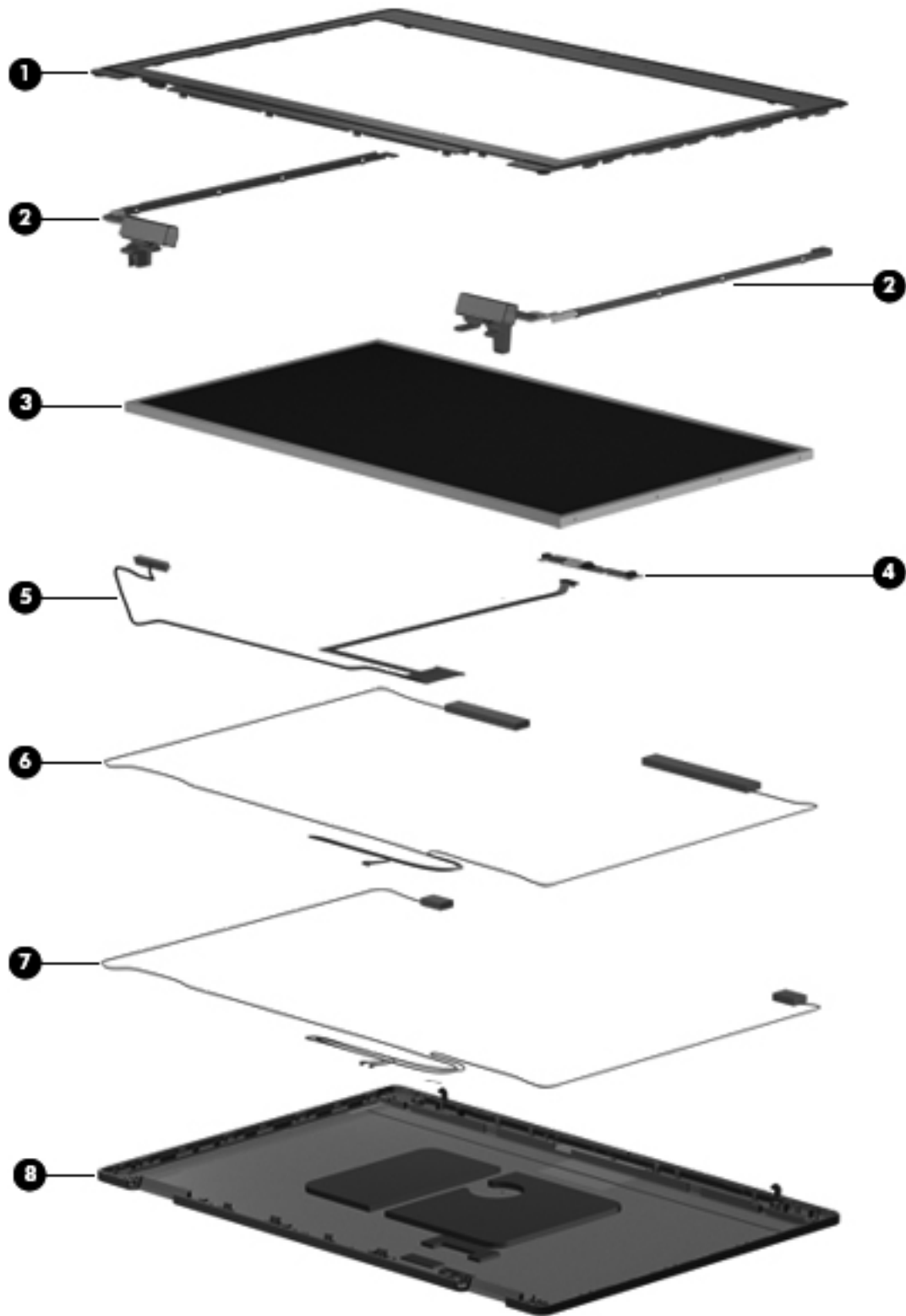

Item	Description	Spare part number
<b>(1)</b>	<b>Display bezel</b>	
	For use with HP ProBook 6560b models with a webcam (bezel includes double-sided tape)	641196-001
	For use with HP ProBook 6560b models without a webcam (bezel includes double-sided tape)	641197-001
	For use with HP EliteBook 8560p models with a webcam	641198-001
	For use with HP EliteBook 8560p models without a webcam	641199-001
<b>(2)</b>	<b>Display hinges</b> (includes left and right hinges, brackets, and covers)	
	For use with HP ProBook 6560b models	647677-001
	For use with HP EliteBook 8560p models	641193-001
<b>(3)</b>	<b>Display panel</b>	
	39.6-cm (15.6-in), HD+, anti-glare, LED, WVA, LVDS	646977-001
	39.6-cm (15.6-in), HD anti-glare, LED, SVA, LVDS	646978-001
	39.6-cm (15.6-in), FHD anti-glare, LED, WVA, LVDS	646976-001
<b>(4)</b>	<b>Webcam module</b>	
	For use with HP ProBook 6560b models	647599-001
	For use with HP EliteBook 8560p models	647601-001
	<b>Microphone module</b>	
	For use in HP ProBook 6560b models	647600-001
	For use in HP EliteBook 8560p models, includes keyboard light	647602-001
<b>(5)</b>	<b>Display Cable Kit</b>	
	For use in HP ProBook 6560b models with HD displays	646969-001
	For use in HP ProBook 6560b models with HD+ displays	646970-001
	For use in HP EliteBook 8560p models with HD displays	641194-001
	For use in HP EliteBook 8560p models with HD+ displays	641195-001
<b>(6)</b>	<b>WLAN antennas</b>	
	Included in Cable Kit, for use in HP ProBook 6560b models	646968-001
	Included in Display Panel Support Kit, for use in HP ProBook 6560b models	657831-001
	Included in Cable Kit, for use in HP EliteBook 8560p models	641188-001
	Included in Display Panel Support Kit, for use in HP ProBook 8560p models	657829-001
<b>(7)</b>	<b>WWAN antennas</b>	
	Included in Cable Kit, for use in HP ProBook 6560b models	646968-001
	Included in Display Panel Support Kit, for use in HP ProBook 6560b models	657831-001
	Included in Cable Kit, for use in HP EliteBook 8560p models	641188-001
	Included in Display Panel Support Kit, for use in HP ProBook 8560p models	657829-001

Item	Description	Spare part number
(8)	<b>Display enclosure</b>	
	For use in HP ProBook 6560b models	641202-001
	Included in Display Panel Support Kit, for use in HP ProBook 6560b models	657831-001
	For use in HP EliteBook 8560p models	641201-001
	Included in Display Panel Support Kit, for use in HP ProBook 8560p models	657829-001
	<b>Display Panel Support Kit</b> (includes WLAN antennas, WWAN antennas, and display enclosure)	
	For use in HP ProBook 8560p models	657829-001
	For use in HP ProBook 6560b models	657831-001

## Plastics Kit

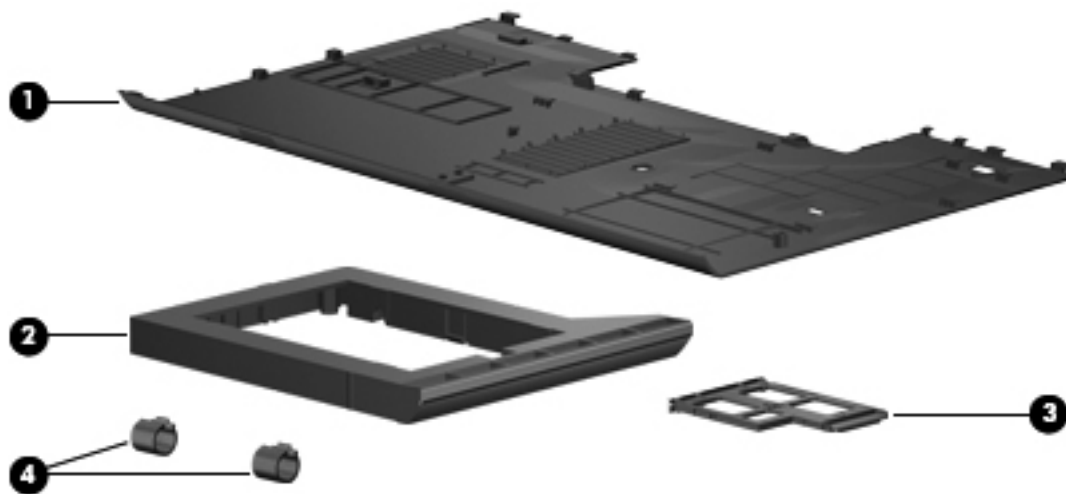

Item	Description	Spare part number
	<b>Plastics Kit</b> for use in HP ProBook 6560b models	646971-001
	<b>Plastics Kit</b> for use in HP EliteBook 8560p models	641190-001
(1)	Bottom door	
(2)	Optical drive protective insert	
(3)	ExpressCard slot protective insert	
(4)	Display cable covers	

# Cable Kit

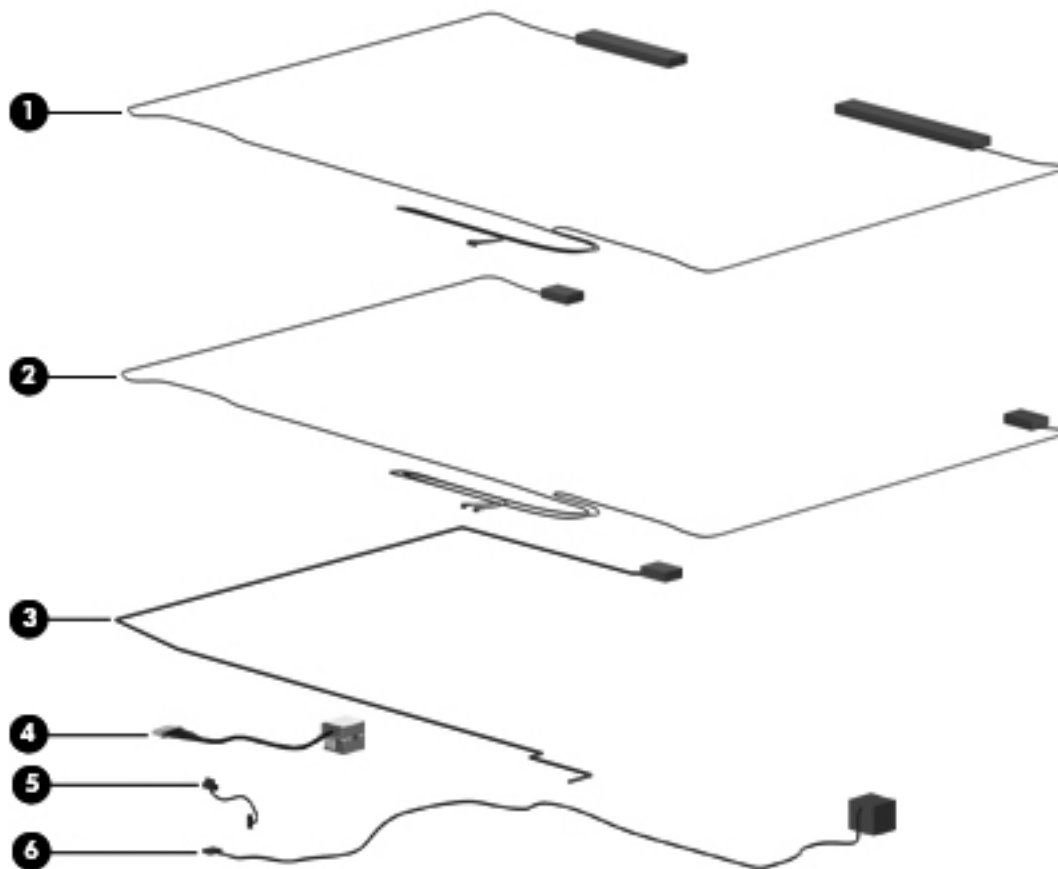

Item	Description	Spare part number
<b>Cable Kit:</b>		
	For use in HP ProBook 6560b models	646968-001
	For use in HP EliteBook 8560p models	641188-001
(1)	WWAN antennas	
(2)	WLAN antennas	
(3)	Multiple-Input Multiple-Output (MIMO) antenna	
(4)	Power connector cable	
(5)	Bluetooth module cable	
(6)	RJ-11 jack cable	

## Mass storage devices

Description	Spare part number
<b>Optical drive</b>	
For use in HP ProBook 6560b models:	
<ul style="list-style-type: none"><li>Blu-ray Disc ROM with SuperMulti DVD±R/RW DL Drive</li></ul>	649655-001
<ul style="list-style-type: none"><li>DVD±RW and CD-RW SuperMulti DL Combo Drive</li></ul>	649654-001
<ul style="list-style-type: none"><li>DVD-ROM Drive</li></ul>	649653-001
For use in HP EliteBook 8560p models:	
<ul style="list-style-type: none"><li>Blu-ray BD-R/RE DVD±RW SuperMulti DL Drive</li></ul>	651044-001
<ul style="list-style-type: none"><li>Blu-ray Disc ROM with SuperMulti DVD±R/RW DL Drive</li></ul>	651043-001
<ul style="list-style-type: none"><li>DVD±RW and CD-RW SuperMulti DL Combo Drive</li></ul>	651042-001
<ul style="list-style-type: none"><li>DVD-ROM Drive</li></ul>	651041-001
<b>Hard drive</b>	
750-GB, 7200-rpm	633252-001
500-GB, 7200-rpm, for use in either the hard drive bay or the upgrade drive bay	634919-001
320-GB, 7200-rpm, Self-Encrypting Drive (SED)	626978-001
320-GB, 7200-rpm	641672-001
250-GB, 7200-rpm	635225-001
160-GB solid-state drive	649652-001
128-GB solid-state drive	649651-001
<b>Hard Drive Hardware Kit</b> (includes hard drive bracket and screws)	644694-001

## Miscellaneous parts

Description	Spare part number
<b>Hard drive cradle</b>	652688-001
<b>Mouse, optical</b>	390632-001
<b>Mouse, USB, travel</b>	434594-001
<b>HP Basic Carrying Case</b>	455084-001
<b>Essential Carrying Case</b>	612757-001
<b>AC adapters</b>	
65-W AC adapter	609939-001
65-W AC adapter for use in India	609948-001
90-W AC adapter	609940-001
90-W AC adapter for use in India	609947-001
<b>Power cords:</b>	
For use in Argentina	490371-D01
For use in Australia	490371-011
For use in Thailand	490371-201
For use in Brazil	490371-202
For use in Denmark	490371-081
For use in Europe, the Middle East, and Africa	490371-021
For use in India	490371-D61
For use in Israel	490371-BB1
For use in Italy	490371-061
For use in Japan	490371-291
For use in the People's Republic of China	490371-AA1
For use in South Africa	490371-AR1
For use in South Korea	490371-AD1
For use in Switzerland	490371-111
For use in Taiwan	490371-AB1
For use in the United Kingdom	490371-031
For use in the United States	490371-001
<b>Rubber Kit</b> (includes rubber feet and display rubber covers)	
For use in HP ProBook 6560b models	646608-001
For use in HP EliteBook 8560p models	641192-001
<b>Screw Kit</b>	

Description	Spare part number
For use in HP ProBook 6560b models	646972-001
For use in HP EliteBook 8560p models	641191-001

## Sequential part number listing

Spare part number	Description
390632-001	Mouse, optical
434594-001	Mouse, USB, travel
455084-001	HP Basic Carrying Case
490371-001	Power cord for use in North America
490371-011	Power cord for use in Australia
490371-021	Power cord for use in Europe, the Middle East, and Africa
490371-031	Power cord for use in the United Kingdom
490371-061	Power cord for use in Italy
490371-081	Power cord for use in Denmark
490371-111	Power cord for use in Switzerland
490371-201	Power cord for use in Thailand
490371-202	Power cord for use in Brazil
490371-291	Power cord for use in Japan
490371-AA1	Power cord for use in the People's Republic of China
490371-AB1	Power cord for use in Taiwan
490371-AD1	Power cord for use in South Korea
490371-AR1	Power cord for use in South Africa
490371-BB1	Power cord for use in Israel
490371-D01	Power cord for use in Argentina
490371-D61	Power cord for use in India
537921-001	Bluetooth module



Spare part number	Description
572511-001	Intel Wi-Fi Link 6300, 802.11a/b/g/n WLAN module for use in Andorra, Antigua and Barbuda, Argentina, Aruba, Australia, Austria, Azerbaijan, Bahamas, Bahrain, Barbados, Belgium, Bermuda, Bolivia, Bosnia and Herzegovina, Brazil, Brunei, Bulgaria, Canada, Cayman Islands, Chile, the People's Republic of China, Colombia, Costa Rica, Croatia, Cyprus, Czech Republic, Denmark, Dominican Republic, Ecuador, Egypt, El Salvador, Estonia, Finland, France, French Guiana, Georgia, Germany, Ghana, Greece, Guadeloupe, Guam, Guatemala, Haiti, Honduras, Hong Kong, Hungary, Iceland, India, Indonesia, Ireland, Israel, Italy, Ivory Coast, Jamaica, Japan, Jordan, Kenya, South Korea, Kuwait, Kyrgyzstan, Latvia, Lebanon, Martinique, US Virgin Islands, Puerto Rico, Nether Antilles, Liechtenstein, Lithuania, Luxembourg, Malawi, Malaysia, Malta, Mauritius, Mexico, Monaco, Montenegro, Morocco, the Netherlands, New Zealand, Nicaragua, Nigeria, Norway, Oman, Pakistan, Panama, Paraguay, Peru, Philippines, Poland, Portugal, Qatar, Romania, San Marino, Saudi Arabia, Senegal, Singapore, Slovakia, Slovenia, South Africa, Spain, Sri Lanka, Sweden, Switzerland, Taiwan, Tanzania, Thailand, Trinidad and Tobago, Turkey, the United Arab Emirates, the United Kingdom, the United States, Uruguay, Venezuela, and Vietnam
582564-001	Broadcom 43224AGN 802.11a/b/g/draft-n WiFi Adapter for use in Antigua and Barbuda, Aruba, the Bahamas, Barbados, Belize, Canada, Guam, Guinea, Haiti, Jamaica, the Nether Antilles, Puerto Rico, St. Kitts and Nevis, St. Lucia, St. Vincent and the Grenadines, Suriname, the US Virgin Islands, and the United States
582564-002	Broadcom 43224AGN 802.11a/b/g/draft-n WiFi Adapter for use in Albania, Algeria, Andorra, Angola, Argentina, Armenia, Australia, Austria, Azerbaijan, Bahrain, Belarus, Belgium, Benin, Bermuda, Bhutan, Bolivia, Bosnia and Herzegovina, Botswana, Brazil, the British Virgin Islands, Brunei, Bulgaria, Burkina Faso, Burundi, Cambodia, Cameroon, Cape Verde, the Cayman Islands, Central African Republic, Chad, Chile, People's Republic of China, Colombia, Comoros, Congo, Costa Rica, Croatia, Cyprus, the Czech Republic, Denmark, Djibouti, Dominica, the Dominican Republic, East Timor, Ecuador, Egypt, El Salvador, Equatorial Guinea, Eritrea, Estonia, Ethiopia, Fiji, Finland, France, French Guiana, Gabon, Gambia, Georgia, Germany, Ghana, Gibraltar, Greece, Grenada, Guadeloupe, Guatemala, Guinea, Guinea-Bissau, Honduras, Hong Kong, Hungary, Iceland, India, Ireland, Italy, Ivory Coast, Japan, Jordan, Kazakhstan, Kenya, Kiribati, Kuwait, Kyrgyzstan, Laos, Latvia, Lebanon, Lesotho, Liberia, Liechtenstein, Lithuania, Luxembourg, Macedonia, Madagascar, Malawi, Malaysia, Maldives, Mali, Malta, Marshall Islands, Martinique, Mauritania, Mauritius, Mexico, Micronesia, Monaco, Mongolia, Montenegro, Morocco, Mozambique, Namibia, Nauru, Nepal, Netherlands, New Zealand, Nicaragua, Niger, Nigeria, Norway, Oman, Palau, Panama, Papua New Guinea, Paraguay, Peru, Philippines, Poland, Portugal, Qatar, Republic of Moldova, Romania, Rwanda, Samoa, San Marino, Sao Tome and Principe, Saudi Arabia, Senegal, Serbia and Montenegro, Seychelles, Sierra Leone, Singapore, Slovakia, Slovenia, Solomon Islands, Somalia, South Africa, South Korea, Spain, Sri Lanka, Swaziland, Sweden, Switzerland, Taiwan, Tajikistan, Tanzania, Thailand, Togo, Tonga, Trinidad and Tobago, Tunisia, Turkey, Turkmenistan, Tuvalu, Uganda, United Arab Emirates, United Kingdom, Uruguay, Uzbekistan, Vanuatu, Venezuela, Vietnam, Yemen, Zaire, Zambia, and Zimbabwe
593530-001	Intel Wi-Fi Link 1000 for use in Andorra, Antigua and Barbuda, Argentina, Aruba, Australia, Austria, Azerbaijan, Bahamas, Bahrain, Barbados, Belgium, Bermuda, Bolivia, Bosnia and Herzegovina, Brazil, Brunei, Bulgaria, Canada, the Cayman Islands, Chile, People's Republic of China, Colombia, Costa Rica, Croatia, Cyprus, the Czech Republic, Denmark, the Dominican Republic, Ecuador, Egypt, El Salvador, Estonia, Finland, France, French Guiana, Georgia, Germany, Ghana, Greece, Guadeloupe, Guam, Guatemala, Haiti, Honduras, Hong Kong, Hungary, Iceland, India, Indonesia, Ireland, Israel, Italy, Ivory Coast, Jamaica, Japan, Jordan, Kenya, Kuwait, Kyrgyzstan, Latvia, Lebanon, Liechtenstein, Lithuania, Luxembourg, Malawi, Malaysia, Malta, Martinique, Mauritius, Mexico, Monaco, Montenegro, Morocco, the Nether Antilles, Netherlands, New Zealand, Nicaragua, Nigeria, Norway, Oman, Pakistan, Panama, Paraguay, Peru, Philippines, Poland, Portugal, Puerto Rico, Qatar, Romania, San Marino, Saudi Arabia, Senegal, Singapore, Slovakia, Slovenia, South Africa, South Korea, Spain, Sri Lanka, Sweden, Switzerland, Taiwan, Tanzania, Thailand, Trinidad and Tobago, Turkey, Ukraine, United Arab Emirates, United Kingdom, Uruguay, the US Virgin Islands, the United States, Venezuela, and Vietnam

Spare part number	Description
593836-001	Broadcom 4313AGN 802.11a/b/g/draft-n WiFi Adapter for use in Afghanistan, Albania, Algeria, Andorra, Angola, Antigua and Barbuda, Argentina, Armenia, Aruba, Australia, Austria, Azerbaijan, Bahamas, Bahrain, Bangladesh, Barbados, Belarus, Belgium, Belize, Benin, Bermuda, Bhutan, Bolivia, Bosnia and Herzegovina, Botswana, Brazil, the British Virgin Islands, Brunei, Bulgaria, Burkina Faso, Burundi, Cambodia, Cameroon, Canada, Cape Verde, the Cayman Islands, Central African Republic, Chad, People's Republic of China, Colombia, Comoros, Congo, Costa Rica, Croatia, Cyprus, the Czech Republic, Denmark, Djibouti, Dominica, the Dominican Republic, East Timor, Ecuador, Egypt, El Salvador, Equatorial Guinea, Eritrea, Estonia, Ethiopia, Fiji, Finland, France, French Guiana, Gabon, Gambia, Georgia, Germany, Ghana, Gibraltar, Greece, Grenada, Guadeloupe, Guam, Guatemala, Guinea, Guinea-Bissau, Guyana, Haiti, Honduras, Hong Kong, Hungary, Iceland, India, Iraq, Ireland, Israel, Italy, Ivory Coast, Jamaica, Japan, Jordan, Kazakhstan, Kenya, Kiribati, Kuwait, Kyrgyzstan, Laos, Latvia, Lebanon, Lesotho, Liberia, Martinique, Liechtenstein, Lithuania, Luxembourg, Macedonia, Madagascar, Malawi, Malaysia, Maldives, Mali, Malta, Marshall Islands, Mauritania, Mauritius, Mexico, Micronesia, Monaco, Mongolia, Montenegro, Morocco, Mozambique, Namibia, Nauru, Nepal, the Nether Antilles, the Netherlands, New Zealand, Nicaragua, Niger, Nigeria, Norway, Oman, Pakistan, Palau, Panama, Papua New Guinea, Paraguay, Puerto Rico, Peru, Philippines, Poland, Portugal, Qatar, Republic of Moldova, Romania, Russia, Rwanda, Samoa, San Marino, Sao Tome and Principe, Saudi Arabia, Senegal, Serbia and Montenegro, Seychelles, Sierra Leone, Singapore, Slovakia, Slovenia, Solomon Islands, Somalia, South Africa, South Korea, Spain, Sri Lanka, St. Kitts and Nevis, St. Lucia, St. Vincent and the Grenadines, Suriname, Swaziland, Sweden, Switzerland, Syria, Taiwan, Tajikistan, Tanzania, Thailand, Togo, Tonga, Trinidad and Tobago, Tunisia, Turkey, Turkmenistan, Tuvalu, Uganda, Ukraine, the United Arab Emirates, the United Kingdom, Uruguay, the United States, the US Virgin Islands, Uzbekistan, Vanuatu, Venezuela, Vietnam, Yemen, Zaire, Zambia, and Zimbabwe
609939-001	65-W AC adapter
609940-001	90-W AC adapter
609947-001	90-W AC adapter for use in India
609948-001	65-W AC adapter for use in India
612757-001	Essential Carrying Case
621565-001	2-GB memory module (PC3-10600, 1333-MHz, DDR3)
621569-001	4-GB memory module (PC3-10600, 1333-MHz, DDR3)
626978-001	320-GB, 7200-rpm hard drive (Self-Encrypting Drive (SED))
628664-001	3-cell, 31 WHr, 2.8 Ah Li-ion battery
628666-001	6-cell, 55 WHr, 2.5 Ah Li-ion battery
628668-001	6-cell, 62 WHr, 2.8 Ah Li-ion battery
628670-001	6-cell, 55 WHr, 2.8 Ah, long life Li-ion battery
628824-001	Modem module
	<b>NOTE:</b> The modem module spare part kit does not include a modem module cable. The modem module cable is included in the Cable Kit, spare part number 646968-001 for 6560b models, 641188-001 for 8560p models. See <a href="#">Cable Kit on page 37</a> for more Cable Kit spare part number information.

Spare part number	Description
630435-001	Atheros HB112AGN 802.11a/b/g/n 3x3 WiFi Adapter for use in Afghanistan, Albania, Algeria, Andorra, Angola, Antigua and Barbuda, Argentina, Armenia, Aruba, Australia, Austria, Azerbaijan, Bahamas, Bahrain, Bangladesh, Barbados, Belarus, Belgium, Belize, Benin, Bermuda, Bhutan, Bolivia, Bosnia and Herzegovina, Botswana, Brazil, the British Virgin Islands, Brunei, Bulgaria, Burkina Faso, Burundi, Cambodia, Cameroon, Canada, Cape Verde, the Cayman Islands, Central African Republic, Chad, People's Republic of China, Colombia, Comoros, Congo, Costa Rica, Croatia, Cyprus, the Czech Republic, Denmark, Djibouti, Dominica, the Dominican Republic, East Timor, Ecuador, Egypt, El Salvador, Equatorial Guinea, Eritrea, Estonia, Ethiopia, Fiji, Finland, France, French Guiana, Gabon, Gambia, Georgia, Germany, Ghana, Gibraltar, Greece, Grenada, Guadeloupe, Guam, Guatemala, Guinea, Guinea-Bissa, Guyana, Haiti, Honduras, Hong Kong, Hungary, Iceland, India, Iraq, Ireland, Israel, Italy, Ivory Coast, Jamaica, Japan, Jordan, Kazakhstan, Kenya, Kiribati, Kuwait, Kyrgyzstan, Laos, Latvia, Lebanon, Lesotho, Liberia, Martinique, Liechtenstein, Lithuania, Luxembourg, Macedonia, Madagascar, Malawi, Malaysia, Maldives, Mali, Malta, Marshall Islands, Mauritania, Mauritius, Mexico, Micronesia, Monaco, Mongolia, Montenegro, Morocco, Mozambique, Namibia, Nauru, Nepal, the Nether Antilles, the Netherlands, New Zealand, Nicaragua, Niger, Nigeria, Norway, Oman, Pakistan, Palau, Panama, Papua New Guinea, Paraguay, Puerto Rico, Peru, Philippines, Poland, Portugal, Qatar, Republic of Moldova, Romania, Russia, Rwanda, Samoa, San Marino, Sao Tome and Principe, Saudi Arabia, Senegal, Serbia and Montenegro, Seychelles, Sierra Leone, Singapore, Slovakia, Slovenia, Solomon Islands, Somalia, South Africa, South Korea, Spain, Sri Lanka, St. Kitts and Nevis, St. Lucia, St. Vincent and the Grenadines, Suriname, Swaziland, Sweden, Switzerland, Syria, Taiwan, Tajikistan, Tanzania, Thailand, Togo, Tonga, Trinidad and Tobago, Tunisia, Turkey, Turkmenistan, Tuvalu, Uganda, Ukraine, the United Arab Emirates, the United Kingdom, Uruguay, the United States, the US Virgin Islands, Uzbekistan, Vanuatu, Venezuela, Vietnam, Yemen, Zaire, Zambia, and Zimbabwe
631243-001	9-cell, 100 WHr, 3.0 Ah Li-ion battery
631252-005	Intel Core i7 processor, 2620M, 2.7-GHz (turbo up to 3.4-GHz) processor, 4-MB L3 cache (includes thermal grease)
631253-005	Intel Core i5 processor, 2520M, 2.5-GHz (turbo up to 3.2-GHz) processor, 3-MB L3 cache (includes thermal grease)
631254-005	Intel Core i7 processor, 2720QM, 2.2-GHz (turbo up to 3.3-GHz) processor, 6-MB L3 cache (includes thermal grease)
631255-005	Intel Core i7 processor, 2540M, 2.6-GHz (turbo up to 3.3-GHz) processor, 3-MB L3 cache (includes thermal grease)
631954-001	Intel Centrino Advanced-N 6205 for use in Afghanistan, Albania, Algeria, Andorra, Angola, Antigua and Barbuda, Argentina, Armenia, Australia, Austria, Azerbaijan, Bahamas, Bahrain, Bangladesh, Barbados, Belarus, Belgium, Belize, Benin, Bermuda, Bhutan, Bolivia, Bosnia and Herzegovina, Botswana, Brazil, the British Virgin Islands, Brunei, Bulgaria, Burkina Faso, Burundi, Cambodia, Cameroon, Canada, Cape Verde, the Cayman Islands, Central African Republic, Chad, People's Republic of China, Colombia, Comoros, Congo, Costa Rica, Croatia, Cyprus, the Czech Republic, Denmark, Djibouti, Dominica, the Dominican Republic, East Timor, Ecuador, Egypt, El Salvador, Equatorial Guinea, Eritrea, Estonia, Ethiopia, Fiji, Finland, France, French Guiana, Gabon, Gambia, Georgia, Germany, Ghana, Gibraltar, Greece, Grenada, Guadeloupe, Guam, Guatemala, Guinea, Guinea-Bissa, Guyana, Haiti, Honduras, Hong Kong, Hungary, Iceland, India, Iraq, Ireland, Israel, Italy, Ivory Coast, Jamaica, Japan, Jordan, Kazakhstan, Kenya, Kiribati, Kuwait, Kyrgyzstan, Laos, Latvia, Lebanon, Lesotho, Liberia, Martinique, Liechtenstein, Lithuania, Luxembourg, Macedonia, Madagascar, Malawi, Malaysia, Maldives, Mali, Malta, Marshall Islands, Mauritania, Mauritius, Mexico, Micronesia, Monaco, Mongolia, Montenegro, Morocco, Mozambique, Namibia, Nauru, Nepal, the Nether Antilles, the Netherlands, New Zealand, Nicaragua, Niger, Nigeria, Norway, Oman, Pakistan, Palau, Panama, Papua New Guinea, Paraguay, Puerto Rico, Peru, Philippines, Poland, Portugal, Qatar, Republic of Moldova, Romania, Russia, Rwanda, Samoa, San Marino, Sao Tome and Principe, Saudi Arabia, Senegal, Serbia and Montenegro, Seychelles, Sierra Leone, Singapore, Slovakia, Slovenia, Solomon Islands, Somalia, South Africa, South Korea, Spain, Sri Lanka, St. Kitts and Nevis, St. Lucia, St. Vincent and the Grenadines, Suriname, Swaziland, Sweden, Switzerland, Syria, Taiwan, Tajikistan, Tanzania, Thailand, Togo, Tonga, Trinidad and Tobago, Tunisia, Turkey, Turkmenistan, Tuvalu, Uganda, Ukraine, the United Arab Emirates, the United Kingdom, Uruguay, the United States, the US Virgin Islands, Uzbekistan, Vanuatu, Venezuela, Vietnam, Yemen, Zaire, Zambia, and Zimbabwe
632155-001	HP hs2340 HSPA+ Mobile Broadband Module

<b>Spare part number</b>	<b>Description</b>
633252-001	750-GB, 7200-rpm hard drive
634089-001	9-cell, 73 WHr, 2.2 Ah Li-ion battery
634091-001	8-GB memory module (PC3-10600, 1333-MHz, DDR3)
634400-001	HP un2430 EV-DO/HSPA Mobile Broadband Module
634919-001	500-GB, 7200-rpm hard drive, for use in either the hard drive bay or the upgrade drive bay
635225-001	250-GB, 7200-rpm hard drive
635501-005	Intel Core i7 processor, 2630QM, 2.0-GHz (turbo up to 2.9-GHz), 6-MB L3 cache (includes thermal grease)
638037-005	Intel Core i3 processor, 2310M, 2.1-GHz, 3-MB L3 cache (includes thermal grease)
638039-005	Intel Core i5 processor, 2410M, 2.3-GHz (turbo up to 2.9-GHz), 3-MB L3 cache (includes thermal grease)
641179-001	Keyboard with pointing stick for use in HP ProBook 6560b models in the United States (includes keyboard and pointing stick cables)
641179-031	Keyboard with pointing stick for use in HP ProBook 6560b models in the United Kingdom (includes keyboard and pointing stick cables)
641179-041	Keyboard with pointing stick for use in HP ProBook 6560b models in Germany (includes keyboard and pointing stick cables)
641179-051	Keyboard with pointing stick for use in HP ProBook 6560b models in France (includes keyboard and pointing stick cables)
641179-061	Keyboard with pointing stick for use in HP ProBook 6560b models in Italy (includes keyboard and pointing stick cables)
641179-071	Keyboard with pointing stick for use in HP ProBook 6560b models in Spain (includes keyboard and pointing stick cables)
641179-081	Keyboard with pointing stick for use in HP ProBook 6560b models in Denmark (includes keyboard and pointing stick cables)
641179-091	Keyboard with pointing stick for use in HP ProBook 6560b models in Norway (includes keyboard and pointing stick cables)
641179-121	Keyboard with pointing stick for use in HP ProBook 6560b models in French Canada (includes keyboard and pointing stick cables)
641179-131	Keyboard with pointing stick for use in HP ProBook 6560b models in Portugal (includes keyboard and pointing stick cables)
641179-141	Keyboard with pointing stick for use in HP ProBook 6560b models in Turkey (includes keyboard and pointing stick cables)
641179-161	Keyboard with pointing stick for use in HP ProBook 6560b models in Latin America (includes keyboard and pointing stick cables)
641179-171	Keyboard with pointing stick for use in HP ProBook 6560b models in Saudi Arabia (includes keyboard and pointing stick cables)
641179-201	Keyboard with pointing stick for use in HP ProBook 6560b models in Brazil (includes keyboard and pointing stick cables)
641179-211	Keyboard with pointing stick for use in HP ProBook 6560b models in Hungary (includes keyboard and pointing stick cables)
641179-251	Keyboard with pointing stick for use in HP ProBook 6560b models in Russia (includes keyboard and pointing stick cables)

<b>Spare part number</b>	<b>Description</b>
641179-261	Keyboard with pointing stick for use in HP ProBook 6560b models in Bulgaria (includes keyboard and pointing stick cables)
641179-281	Keyboard with pointing stick for use in HP ProBook 6560b models in Thailand (includes keyboard and pointing stick cables)
641179-291	Keyboard with pointing stick for use in HP ProBook 6560b models in Japan (includes keyboard and pointing stick cables)
641179-A41	Keyboard with pointing stick for use in HP ProBook 6560b models in Belgium (includes keyboard and pointing stick cables)
641179-A81	Keyboard with pointing stick for use in HP ProBook 6560b models in the Czech Republic (includes keyboard and pointing stick cables)
641179-AB1	Keyboard with pointing stick for use in HP ProBook 6560b models in Taiwan (includes keyboard and pointing stick cables)
641179-AD1	Keyboard with pointing stick for use in HP ProBook 6560b models in South Korea (includes keyboard and pointing stick cables)
641179-B31	Keyboard with pointing stick for use in HP ProBook 6560b models in the Netherlands and Europe (includes keyboard and pointing stick cables)
641179-B71	Keyboard with pointing stick for use in HP ProBook 6560b models in Sweden (includes keyboard and pointing stick cables)
641179-BB1	Keyboard with pointing stick for use in HP ProBook 6560b models in Israel (includes keyboard and pointing stick cables)
641179-BG1	Keyboard with pointing stick for use in HP ProBook 6560b models in Switzerland (includes keyboard and pointing stick cables)
641179-D61	Keyboard with pointing stick for use in HP ProBook 6560b models in India (includes keyboard and pointing stick cables)
641179-DD1	Keyboard with pointing stick for use in HP ProBook 6560b models in Iceland (includes keyboard and pointing stick cables)
641179-DH1	Keyboard with pointing stick for use in HP ProBook 6560b models in the Netherlands (includes keyboard and pointing stick cables)
641179-DJ1	Keyboard with pointing stick for use in HP ProBook 6560b models in Greece (includes keyboard and pointing stick cables)
641179-DW1	Keyboard with pointing stick for use in HP ProBook 6560b models in the French Arabic region (includes keyboard and pointing stick cables)
641180-001	Keyboard without pointing stick for use in HP ProBook 6560b models in the United States (includes keyboard cable)
641180-031	Keyboard without pointing stick for use in HP ProBook 6560b models in the United Kingdom (includes keyboard cable)
641180-041	Keyboard without pointing stick for use in HP ProBook 6560b models in Germany (includes keyboard cable)
641180-051	Keyboard without pointing stick for use in HP ProBook 6560b models in France (includes keyboard cable)
641180-061	Keyboard without pointing stick for use in HP ProBook 6560b models in Italy (includes keyboard cable)
641180-071	Keyboard without pointing stick for use in HP ProBook 6560b models in Spain (includes keyboard cable)
641180-081	Keyboard without pointing stick for use in HP ProBook 6560b models in Denmark (includes keyboard cable)

<b>Spare part number</b>	<b>Description</b>
641180-091	Keyboard without pointing stick for use in HP ProBook 6560b models in Norway (includes keyboard cable)
641180-121	Keyboard without pointing stick for use in HP ProBook 6560b models in French Canada (includes keyboard cable)
641180-131	Keyboard without pointing stick for use in HP ProBook 6560b models in Portugal (includes keyboard cable)
641180-141	Keyboard without pointing stick for use in HP ProBook 6560b models in Turkey (includes keyboard cable)
641180-161	Keyboard without pointing stick for use in HP ProBook 6560b models in Latin America (includes keyboard cable)
641180-171	Keyboard without pointing stick for use in HP ProBook 6560b models in Saudi Arabia (includes keyboard cable)
641180-201	Keyboard without pointing stick for use in HP ProBook 6560b models in Brazil (includes keyboard cable)
641180-211	Keyboard without pointing stick for use in HP ProBook 6560b models in Hungary (includes keyboard cable)
641180-251	Keyboard without pointing stick for use in HP ProBook 6560b models in Russia (includes keyboard cable)
641180-261	Keyboard without pointing stick for use in HP ProBook 6560b models in Bulgaria (includes keyboard cable)
641180-281	Keyboard without pointing stick for use in HP ProBook 6560b models in Thailand (includes keyboard cable)
641180-291	Keyboard without pointing stick for use in HP ProBook 6560b models in Japan (includes keyboard cable)
641180-A41	Keyboard without pointing stick for use in HP ProBook 6560b models in Belgium (includes keyboard cable)
641180-A81	Keyboard without pointing stick for use in HP ProBook 6560b models in the Czech Republic (includes keyboard cable)
641180-AB1	Keyboard without pointing stick for use in HP ProBook 6560b models in Taiwan (includes keyboard cable)
641180-AD1	Keyboard without pointing stick for use in HP ProBook 6560b models in South Korea (includes keyboard cable)
641180-B31	Keyboard without pointing stick for use in HP ProBook 6560b models in the Netherlands and Europe (includes keyboard cable)
641180-B71	Keyboard without pointing stick for use in HP ProBook 6560b models in Sweden (includes keyboard cable)
641180-BB1	Keyboard without pointing stick for use in HP ProBook 6560b models in Israel (includes keyboard cable)
641180-BG1	Keyboard without pointing stick for use in HP ProBook 6560b models in Switzerland (includes keyboard cable)
641180-D61	Keyboard without pointing stick for use in HP ProBook 6560b models in India (includes keyboard cable)
641180-DD1	Keyboard without pointing stick for use in HP ProBook 6560b models in Iceland (includes keyboard cable)
641180-DH1	Keyboard without pointing stick for use in HP ProBook 6560b models in the Netherlands (includes keyboard cable)
641180-DJ1	Keyboard without pointing stick for use in HP ProBook 6560b models in Greece (includes keyboard cable)
641180-DW1	Keyboard without pointing stick for use in HP ProBook 6560b models in the French Arabic region (includes keyboard cable)
641181-001	Keyboard with pointing stick for use in HP EliteBook 8560p models in the United States (includes keyboard and pointing stick cables)
641181-031	Keyboard with pointing stick for use in HP EliteBook 8560p models in the United Kingdom (includes keyboard and pointing stick cables)

<b>Spare part number</b>	<b>Description</b>
641181-041	Keyboard with pointing stick for use in HP EliteBook 8560p models in Germany (includes keyboard and pointing stick cables)
641181-051	Keyboard with pointing stick for use in HP EliteBook 8560p models in France (includes keyboard and pointing stick cables)
641181-061	Keyboard with pointing stick for use in HP EliteBook 8560p models in Italy (includes keyboard and pointing stick cables)
641181-071	Keyboard with pointing stick for use in HP EliteBook 8560p models in Spain (includes keyboard and pointing stick cables)
641181-081	Keyboard with pointing stick for use in HP EliteBook 8560p models in Denmark (includes keyboard and pointing stick cables)
641181-091	Keyboard with pointing stick for use in HP EliteBook 8560p models in Norway (includes keyboard and pointing stick cables)
641181-121	Keyboard with pointing stick for use in HP EliteBook 8560p models in French Canada (includes keyboard and pointing stick cables)
641181-131	Keyboard with pointing stick for use in HP EliteBook 8560p models in Portugal (includes keyboard and pointing stick cables)
641181-141	Keyboard with pointing stick for use in HP EliteBook 8560p models in Turkey (includes keyboard and pointing stick cables)
641181-161	Keyboard with pointing stick for use in HP EliteBook 8560p models in Latin America (includes keyboard and pointing stick cables)
641181-171	Keyboard with pointing stick for use in HP EliteBook 8560p models in Saudi Arabia (includes keyboard and pointing stick cables)
641181-201	Keyboard with pointing stick for use in HP EliteBook 8560p models in Brazil (includes keyboard and pointing stick cables)
641181-211	Keyboard with pointing stick for use in HP EliteBook 8560p models in Hungary (includes keyboard and pointing stick cables)
641181-251	Keyboard with pointing stick for use in HP EliteBook 8560p models in Russia (includes keyboard and pointing stick cables)
641181-261	Keyboard with pointing stick for use in HP EliteBook 8560p models in Bulgaria (includes keyboard and pointing stick cables)
641181-281	Keyboard with pointing stick for use in HP EliteBook 8560p models in Thailand (includes keyboard and pointing stick cables)
641181-291	Keyboard with pointing stick for use in HP EliteBook 8560p models in Japan (includes keyboard and pointing stick cables)
641181-A41	Keyboard with pointing stick for use in HP EliteBook 8560p models in Belgium (includes keyboard and pointing stick cables)
641181-A81	Keyboard with pointing stick for use in HP EliteBook 8560p models in the Czech Republic (includes keyboard and pointing stick cables)
641181-AB1	Keyboard with pointing stick for use in HP EliteBook 8560p models in Taiwan (includes keyboard and pointing stick cables)
641181-AD1	Keyboard with pointing stick for use in HP EliteBook 8560p models in South Korea (includes keyboard and pointing stick cables)
641181-B31	Keyboard with pointing stick for use in HP EliteBook 8560p models in the Netherlands and Europe (includes keyboard and pointing stick cables)

<b>Spare part number</b>	<b>Description</b>
641181-B71	Keyboard with pointing stick for use in HP EliteBook 8560p models in Sweden (includes keyboard and pointing stick cables)
641181-BB1	Keyboard with pointing stick for use in HP EliteBook 8560p models in Israel (includes keyboard and pointing stick cables)
641181-BG1	Keyboard with pointing stick for use in HP EliteBook 8560p models in Switzerland (includes keyboard and pointing stick cables)
641181-D61	Keyboard with pointing stick for use in HP EliteBook 8560p models in India (includes keyboard and pointing stick cables)
641181-DD1	Keyboard with pointing stick for use in HP EliteBook 8560p models in Iceland (includes keyboard and pointing stick cables)
641181-DH1	Keyboard with pointing stick for use in HP EliteBook 8560p models in the Netherlands (includes keyboard and pointing stick cables)
641181-DJ1	Keyboard with pointing stick for use in HP EliteBook 8560p models in Greece (includes keyboard and pointing stick cables)
641181-DW1	Keyboard with pointing stick for use in HP EliteBook 8560p models in the French Arabic region (includes keyboard and pointing stick cables)
641182-001	Bottom cover for use with HP EliteBook 8560p computer models
641183-001	Fan
641184-001	USB 2.0 board for use only in 6560b models (includes Mylar)
641185-001	USB 3.0 board for use only in 8560p models (includes Mylar)
641186-001	Speaker assembly
641187-001	Function board with cable
641188-001	Cable Kit for use in HP EliteBook 8560p models (see <a href="#">Cable Kit on page 37</a> for more Cable Kit spare part information)
641190-001	Plastics Kit for use in HP EliteBook 8560p models
641191-001	Screw Kit for use in HP EliteBook 8560p models
641192-001	Rubber Kit for use with model 8560p (includes rubber feet and display rubber covers)
641193-001	Display Hinge Kit for use in HP EliteBook 8560p models (includes left and right hinges, brackets, and covers)
641194-001	Display Cable Kit for use in HP EliteBook 8560p models with HD displays
641195-001	Display Cable Kit for use in HP EliteBook 8560p models with HD+ displays
641196-001	Display bezel for use with HP ProBook 6560b models with a webcam (bezel includes double-sided tape)
641197-001	Display bezel for use with HP ProBook 6560b models without a webcam (bezel includes double-sided tape)
641198-001	Display bezel for use with HP EliteBook 8560p models with a webcam
641199-001	Display bezel for use with HP EliteBook 8560p models without a webcam
641200-001	RTC battery
641201-001	Display enclosure for use in 8560p models
641202-001	Display enclosure for use in 6560b models



<b>Spare part number</b>	<b>Description</b>
641203-001	Top cover with Touchpad for use with 6560b models
641204-001	Top cover with fingerprint reader, without pointing stick, for use with 6560b models
641205-001	Top cover with fingerprint reader and pointing stick for use with 6560b models
641206-001	Top cover with pointing stick, without fingerprint reader for use with 6560b models
641207-001	Top cover with fingerprint reader and pointing stick for use with 8560p models
641208-001	Top cover with pointing stick, without fingerprint reader for use with 8560p models
641672-001	320-GB, 7200-rpm hard drive
644694-001	Hard Drive Hardware Kit (includes hard drive bracket and screws)
644695-001	Bottom cover for use with HP ProBook 6560b computer models
646608-001	Rubber Kit for use with model 6560b (includes rubber feet and display rubber covers)
646760-005	Intel Celeron processor, B810, 1.6-GHz, 2-MB L3 cache
646962-001	System board for use in HP ProBook 6560b computers with UMA graphics, HM65 boards, and WWAN (use in all countries and regions except for Russia and the People's Republic of China)
646963-001	System board for use in HP ProBook 6560b computers with discrete graphics, HM65 boards, and WWAN (use in all countries and regions except for Russia and the People's Republic of China)
646964-001	System board for use in HP ProBook 6560b computers with UMA graphics, QM67 boards, and WWAN (use in all countries and regions except for Russia and the People's Republic of China)
646965-001	System board for use in HP ProBook 6560b computers with discrete graphics, QM67 boards, and WWAN (use in all countries and regions except for Russia and the People's Republic of China)
646966-001	System board for use in HP EliteBook 8560p computers with UMA graphics (use in all countries and regions except for Russia and the People's Republic of China)
646967-001	System board for use in HP EliteBook 8560p computers with discrete graphics (use in all countries and regions except for Russia and the People's Republic of China)
646968-001	Cable Kit for use in HP ProBook 6560b models (see <a href="#">Cable Kit on page 37</a> for more Cable Kit spare part information)
646969-001	Display Cable Kit for use in HP ProBook 6560b models with HD displays
646970-001	Display Cable Kit for use in HP ProBook 6560b models with HD+ displays
646971-001	Plastics Kit for use in HP ProBook 6560b models (see <a href="#">Plastics Kit on page 36</a> for more Plastics Kit spare part information)
646972-001	Screw Kit for use in HP ProBook 6560b models
646976-001	Display panel, 39.6-cm (15.6-in), FHD anti-glare, LED, WVA, LVDS
646977-001	Display panel, 39.6-cm (15.6-in), HD+, anti-glare, LED, LVDS
646978-001	Display panel, 39.6-cm (15.6-in), HD anti-glare, LED, SVA, LVDS
647599-001	Webcam module for use in HP ProBook 6560b models
647600-001	Microphone module for use in HP ProBook 6560b models
647601-001	Webcam module for use in HP ProBook 8560p models
647602-001	Microphone module, including keyboard light, for use in HP EliteBook 8560p models

<b>Spare part number</b>	<b>Description</b>
647603-001	Heat sink for use in computers with UMA graphics
647604-001	Heat sink for use in computers with discrete graphics
647677-001	Display hinges for use in HP ProBook 6560b models (includes left and right hinges, brackets, and covers)
649651-001	128-GB solid-state drive (SSD)
649652-001	160-GB solid-state drive (SSD)
649653-001	DVD-ROM drive for use in HP ProBook 6560b models
649654-001	DVD±RW and CD-RW SuperMulti DL combo drive for use in HP ProBook 6560b models
649655-001	Blu-ray ROM DVD±RW SuperMulti DL Drive for use in HP ProBook 6560b models
651041-001	DVD-ROM drive for use in HP EliteBook 8560p models
651042-001	DVD±RW and CD-RW SuperMulti DL combo drive for use in HP EliteBook 8560p models
651043-001	Blu-ray ROM DVD±RW SuperMulti DL Drive for use in HP EliteBook 8560p models
651044-001	Blu-ray BD-R/RE DVD±RW SuperMulti DL Drive for use in HP EliteBook 8560p models
652688-001	Hard drive cradle
653784-001	System board for use in HP ProBook 6560b computers with UMA graphics, HM65 boards, and WWAN (use in Russia and the People's Republic of China)
653785-001	System board for use in HP ProBook 6560b computers with discrete graphics, HM65 boards, and WWAN (use in Russia and the People's Republic of China)
653786-001	System board for use in HP ProBook 6560b computers with UMA graphics, QM67 boards, and WWAN (use in Russia and the People's Republic of China)
653787-001	System board for use in HP ProBook 6560b computers with discrete graphics, QM67 boards, and WWAN (use in all countries and regions except for Russia and the People's Republic of China)
653788-001	System board for use in HP EliteBook 8560p computers with UMA graphics (use in Russia and the People's Republic of China)
653789-001	System board for use in HP EliteBook 8560p computers with discrete graphics (use in Russia and the People's Republic of China)
654129-001	System board for use in HP ProBook 6560b computers with UMA graphics, HM65 boards, and no WWAN (use in all countries and regions except for Russia and the People's Republic of China)
654305-001	System board for use in HP ProBook 6560b computers with UMA graphics, HM65 boards, and no WWAN (use in Russia and the People's Republic of China)
657829-001	Display Panel Support Kit for use in HP ProBook 8560p models
657831-001	Display Panel Support Kit for use in HP ProBook 6560b models

---

# 4 Removal and replacement procedures

## Preliminary replacement requirements

### Tools required

You will need the following tools to complete the removal and replacement procedures:

- Flat-bladed screwdriver
- Phillips P0 and P1 screwdrivers
- Torx T8 screwdriver

### Service considerations

The following sections include some of the considerations that you must keep in mind during disassembly and assembly procedures.

---

 **NOTE:** As you remove each subassembly from the computer, place the subassembly (and all accompanying screws) away from the work area to prevent damage.

---

### Plastic parts

---

 **CAUTION:** Using excessive force during disassembly and reassembly can damage plastic parts. Use care when handling the plastic parts. Apply pressure only at the points designated in the maintenance instructions.

---

## Cables and connectors

---

**⚠ CAUTION:** When servicing the computer, be sure that cables are placed in their proper locations during the reassembly process. Improper cable placement can damage the computer.

---

Cables must be handled with extreme care to avoid damage. Apply only the tension required to unseat or seat the cables during removal and insertion. Handle cables by the connector whenever possible. In all cases, avoid bending, twisting, or tearing cables. Be sure that cables are routed in such a way that they cannot be caught or snagged by parts being removed or replaced. Handle flex cables with extreme care; these cables tear easily.

## Drive handling

---

**⚠ CAUTION:** Drives are fragile components that must be handled with care. To prevent damage to the computer, damage to a drive, or loss of information, observe these precautions:

---

Before removing or inserting a hard drive, shut down the computer. If you are unsure whether the computer is off or in Hibernation, turn the computer on, and then shut it down through the operating system.

Before handling a drive, be sure that you are discharged of static electricity. While handling a drive, avoid touching the connector.

Before removing a diskette drive or optical drive, be sure that a diskette or disc is not in the drive and be sure that the optical drive tray is closed.

Handle drives on surfaces covered with at least one inch of shock-proof foam.

Avoid dropping drives from any height onto any surface.

After removing a hard drive, an optical drive, or a diskette drive, place it in a static-proof bag.

Avoid exposing a hard drive to products that have magnetic fields, such as monitors or speakers.

Avoid exposing a drive to temperature extremes or liquids.

If a drive must be mailed, place the drive in a bubble pack mailer or other suitable form of protective packaging and label the package "FRAGILE."

---

# Grounding guidelines

## Electrostatic discharge damage

Electronic components are sensitive to electrostatic discharge (ESD). Circuitry design and structure determine the degree of sensitivity. Networks built into many integrated circuits provide some protection, but in many cases, ESD contains enough power to alter device parameters or melt silicon junctions.

A discharge of static electricity from a finger or other conductor can destroy static-sensitive devices or microcircuitry. Even if the spark is neither felt nor heard, damage may have occurred.

An electronic device exposed to ESD may not be affected at all and can work perfectly throughout a normal cycle. Or the device may function normally for a while, and then degrade in the internal layers, reducing its life expectancy.

**CAUTION:** To prevent damage to the computer when you are removing or installing internal components, observe these precautions:

Keep components in their electrostatic-safe containers until you are ready to install them.

Use nonmagnetic tools.

Before touching an electronic component, discharge static electricity by using the guidelines described in this section.

Avoid touching pins, leads, and circuitry. Handle electronic components as little as possible.

If you remove a component, place it in an electrostatic-safe container.

The following table shows how humidity affects the electrostatic voltage levels generated by different activities.

**CAUTION:** A product can be degraded by as little as 700 V.

Typical electrostatic voltage levels			
Event	Relative humidity		
	10%	40%	55%
Walking across carpet	35,000 V	15,000 V	7,500 V
Walking across vinyl floor	12,000 V	5,000 V	3,000 V
Motions of bench worker	6,000 V	800 V	400 V
Removing DIPS from plastic tube	2,000 V	700 V	400 V
Removing DIPS from vinyl tray	11,500 V	4,000 V	2,000 V
Removing DIPS from Styrofoam	14,500 V	5,000 V	3,500 V
Removing bubble pack from PCB	26,500 V	20,000 V	7,000 V
Packing PCBs in foam-lined box	21,000 V	11,000 V	5,000 V

## Packaging and transporting guidelines

Follow these grounding guidelines when packaging and transporting equipment:

- To avoid hand contact, transport products in static-safe tubes, bags, or boxes.
- Protect ESD-sensitive parts and assemblies with conductive or approved containers or packaging.
- Keep ESD-sensitive parts in their containers until the parts arrive at static-free workstations.
- Place items on a grounded surface before removing items from their containers.
- Always be properly grounded when touching a component or assembly.
- Store reusable ESD-sensitive parts from assemblies in protective packaging or nonconductive foam.
- Use transporters and conveyors made of antistatic belts and roller bushings. Be sure that mechanized equipment used for moving materials is wired to ground and that proper materials are selected to avoid static charging. When grounding is not possible, use an ionizer to dissipate electric charges.

## Workstation guidelines

Follow these grounding workstation guidelines:

- Cover the workstation with approved static-shielding material.
- Use a wrist strap connected to a properly grounded work surface and use properly grounded tools and equipment.
- Use conductive field service tools, such as cutters, screwdrivers, and vacuums.
- When fixtures must directly contact dissipative surfaces, use fixtures made only of static-safe materials.
- Keep the work area free of nonconductive materials, such as ordinary plastic assembly aids and Styrofoam.
- Handle ESD-sensitive components, parts, and assemblies by the case or PCM laminate. Handle these items only at static-free workstations.
- Avoid contact with pins, leads, or circuitry.
- Turn off power and input signals before inserting or removing connectors or test equipment.

## Equipment guidelines

Grounding equipment must include either a wrist strap or a foot strap at a grounded workstation.

- When seated, wear a wrist strap connected to a grounded system. Wrist straps are flexible straps with a minimum of one megohm  $\pm 10\%$  resistance in the ground cords. To provide proper ground, wear a strap snugly against the skin at all times. On grounded mats with banana-plug connectors, use alligator clips to connect a wrist strap.
- When standing, use foot straps and a grounded floor mat. Foot straps (heel, toe, or boot straps) can be used at standing workstations and are compatible with most types of shoes or boots. On conductive floors or dissipative floor mats, use foot straps on both feet with a minimum of one megohm resistance between the operator and ground. To be effective, the conductive strips must be worn in contact with the skin.

The following grounding equipment is recommended to prevent electrostatic damage:

- Antistatic tape
- Antistatic smocks, aprons, and sleeve protectors
- Conductive bins and other assembly or soldering aids
- Nonconductive foam
- Conductive tabletop workstations with ground cords of one megohm resistance
- Static-dissipative tables or floor mats with hard ties to the ground
- Field service kits
- Static awareness labels
- Material-handling packages
- Nonconductive plastic bags, tubes, or boxes
- Metal tote boxes
- Electrostatic voltage levels and protective materials

The following table lists the shielding protection provided by antistatic bags and floor mats.

Material	Use	Voltage protection level
Antistatic plastic	Bags	1,500 V
Carbon-loaded plastic	Floor mats	7,500 V
Metallized laminate	Floor mats	5,000 V

## Component replacement procedures

This chapter provides removal and replacement procedures.

There are as many as 95 screws and screw locks, in 15 different sizes, that must be removed, replaced, or loosened when servicing the computer. Make special note of each screw and screw lock size and location during removal and replacement.

### Service tag

When ordering parts or requesting information, provide the computer serial number and model description provided on the service tag.

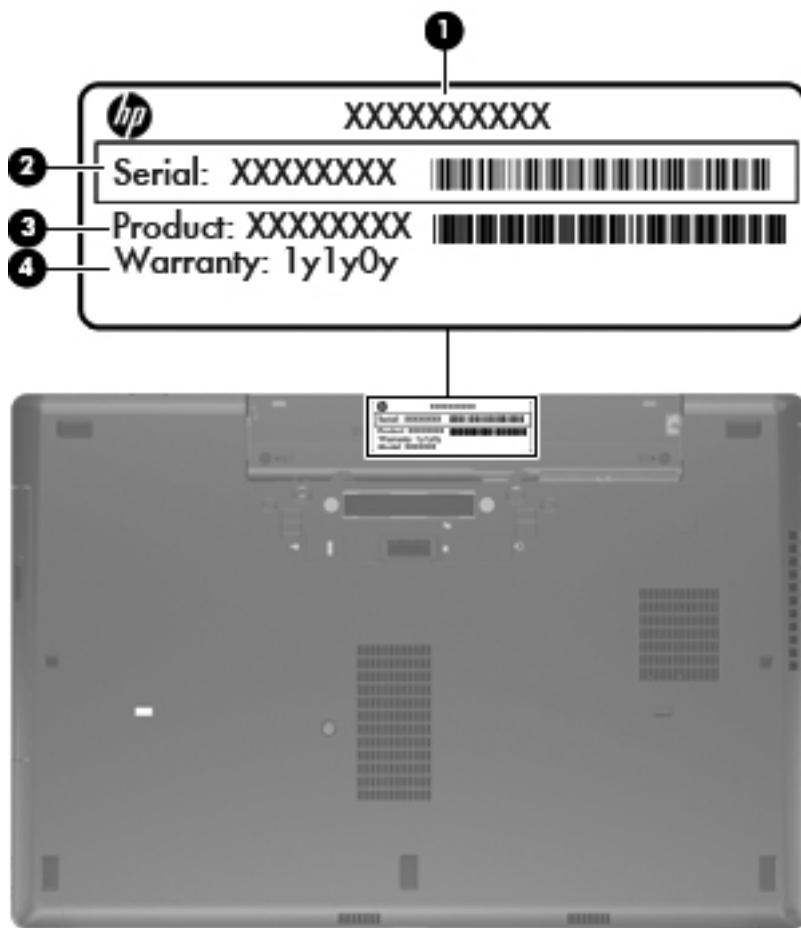

- Product name (1). This is the product name affixed to the front of the computer.
- Serial number (s/n) (2). This is an alphanumeric identifier that is unique to each product.
- Part number/Product number (p/n) (3). This number provides specific information about the product's hardware components. The part number helps a service technician to determine what components and parts are needed.
- Warranty period (4). This number describes the duration (in years) of the warranty period for the computer.



## Computer feet

The computer feet are adhesive-backed rubber pads. The feet are included in the Rubber Kit, spare part number 646608-001 for HP ProBook 6560b models and 641192-001 for HP EliteBook 8560p models. There are 5 rubber feet that attach to the bottom cover in the locations illustrated below.

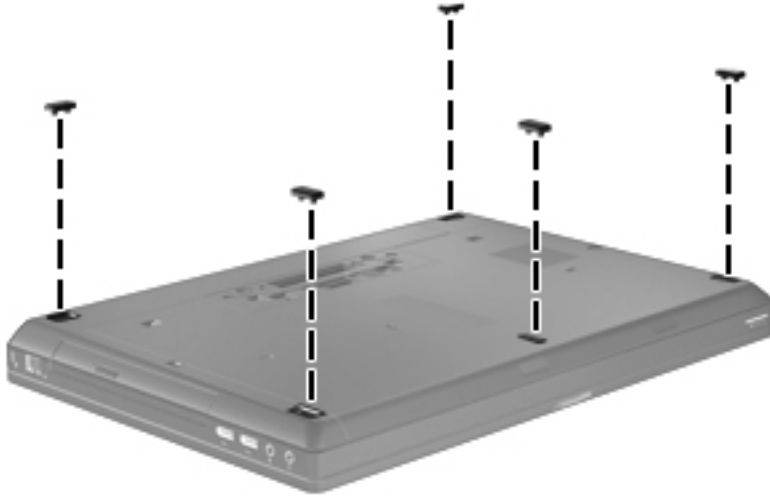

## Battery

Description	Spare part number
9-cell, 100 WHr, 3.0 Ah Li-ion battery	631243-001
9-cell, 73 WHr, 2.2 Ah Li-ion battery	634089-001
6-cell, 62 WHr, 2.8 Ah Li-ion battery	628668-001
6-cell, 55 WHr, 2.8 Ah, long life Li-ion battery	628670-001
6-cell, 55 WHr, 2.5 Ah Li-ion battery	628666-001
3-cell, 31 WHr, 2.8 Ah Li-ion battery	628664-001

Before disassembling the computer, follow these steps:

1. Shut down the computer. If you are unsure whether the computer is off or in Hibernation, turn the computer on, and then shut it down through the operating system.
2. Disconnect all external devices connected to the computer.
3. Disconnect the power from the computer by first unplugging the power cord from the AC outlet, and then unplugging the AC adapter from the computer.

Remove the battery:

1. Position the computer upside-down on a flat surface, with the battery bay toward you.
2. Slide the battery release latch **(1)** to release the battery.
3. Remove the battery **(2)** from the computer.

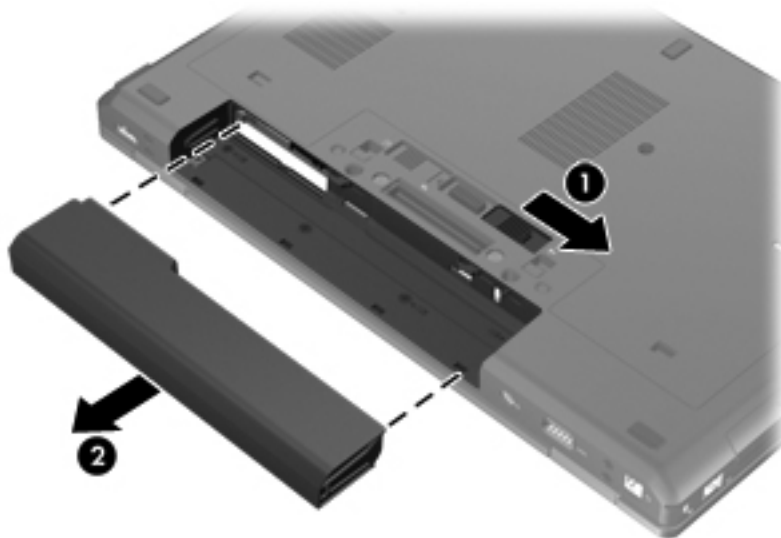

Install the battery by inserting it into the battery bay until you hear a click.

## Display assembly (panel, bezel, webcam, microphone)

All display assemblies include WLAN antenna transceivers and cables. WWAN models include 2 WWAN antenna transceivers and cables.

 **NOTE:** Full hinge-up displays are not spared.

This section describes removing components that do not require that you entirely remove the display assembly from the computer. You can remove the display bezel, webcam/microphone module, and display panel with the display assembly still attached to the computer.

To remove the remaining display components, including the display brackets, antennas, cable, and enclosure, you must remove the entire display assembly from the computer. See [Display assembly and components \(whole hinge-up, cable, antennas, hinges, enclosure\) on page 111](#) for more information about removing the remaining components.

Description	Spare part number
<b>Display panels</b>	
39.6-cm (15.6-in), FHD anti-glare, LED, WVA, LVDS	646976-001
39.6-cm (15.6-in), HD+, anti-glare, LED, WVA, LVDS	646977-001
39.6-cm (15.6-in), HD anti-glare, LED, SVA, LVDS	646978-001
<b>Display bezels</b>	
For use in HP ProBook 6560b models with a webcam (bezel includes double-sided tape)	641196-001
For use in HP ProBook 6560b models without a webcam (bezel includes double-sided tape)	641197-001
For use in HP EliteBook 8560p models with a webcam	641198-001
For use in HP EliteBook 8560p models without a webcam	641199-001
<b>Webcam module</b>	
HP ProBook 6560b models	647599-001
HP EliteBook 8560p models	647601-001
<b>Microphone module</b>	
HP ProBook 6560b models	647600-001
HP EliteBook 8560p models (includes keyboard light)	647602-001

Before removing the display assembly, follow these steps:

1. Shut down the computer. If you are unsure whether the computer is off or in Hibernation, turn the computer on, and then shut it down through the operating system.
2. Disconnect all external devices connected to the computer.
3. Disconnect the power from the computer by first unplugging the power cord from the AC outlet, and then unplugging the AC adapter from the computer.
4. Remove the battery (see [Battery on page 58](#)).

Remove the display assembly:

1. Position the computer right-side up with the front toward you.
2. Open the computer as far as possible.
3. To replace the display bezel, remove the two rubber screw covers (1) and the two Phillips PM2.5×5.0 screws (2) in the bottom corners of the display bezel.

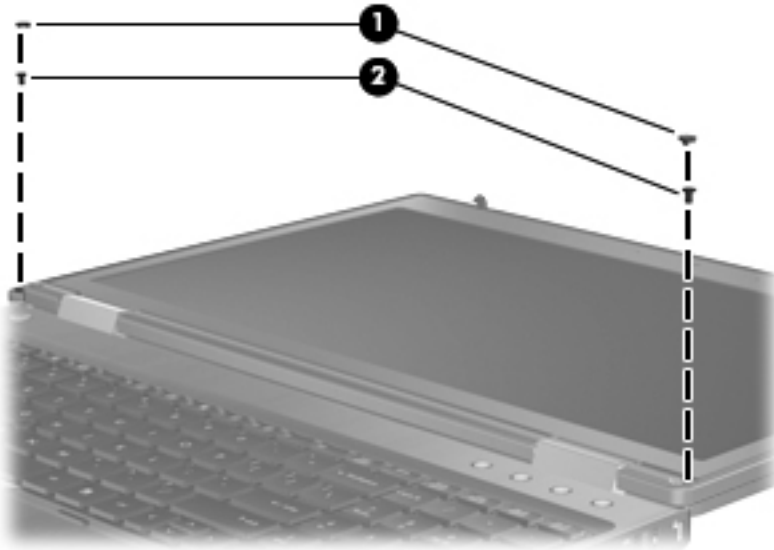

4. Flex the top (1) of the bezel, the inside edges of the left and right sides (2), and then the bottom (3) of the bezel until it disengages from the display enclosure.
5. Remove the display bezel (4).

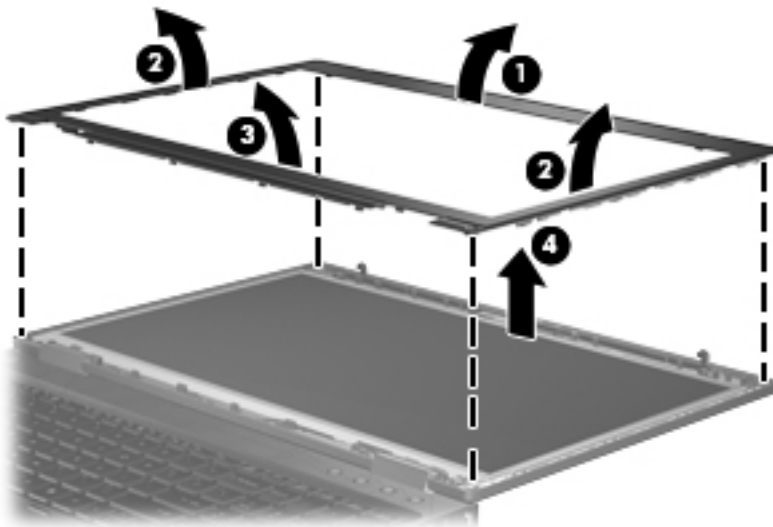

6. If it is necessary to replace the webcam module from the display enclosure, gently pull the webcam module away from the double-sided tape on the display enclosure (1), disconnect the webcam cable from the module (2), and then remove the webcam (3).

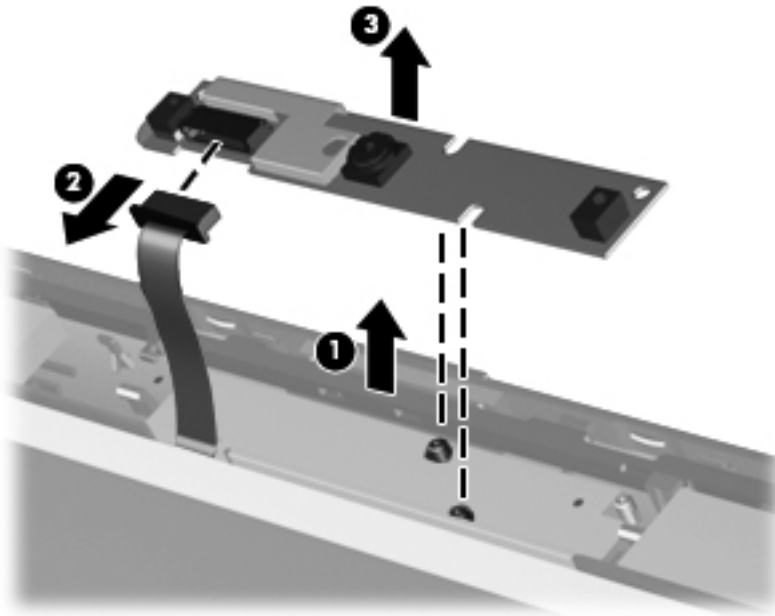

7. If it is necessary to replace the display panel, remove the six Phillips PM2.5×5.0 screws (1) at the bottom and two Phillips PM2.5×5.0 screws (2) at the top that secure the panel to the display enclosure.
8. Pivot the display panel upward until it sits at a 90 degree angle (3).

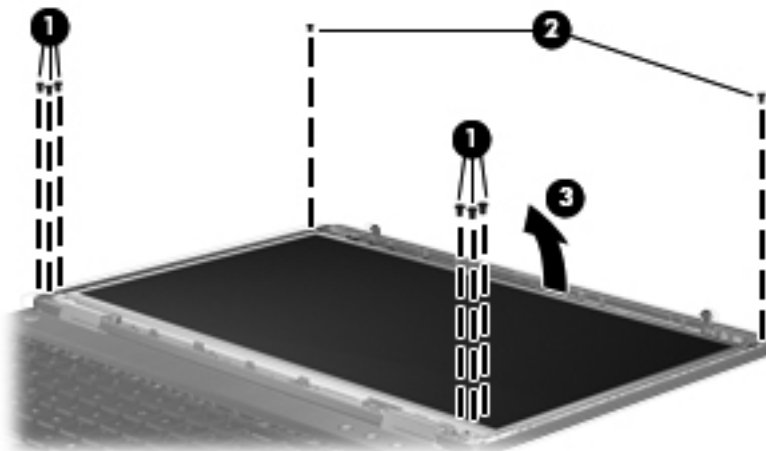

9. Disconnect the display panel cable from the back of the display panel (1).
10. Remove the eight Phillips PM2.5×4.0 screws (2) that secure the display panel to the brackets.

11. Slide the display panel up and out of the hinges (3).

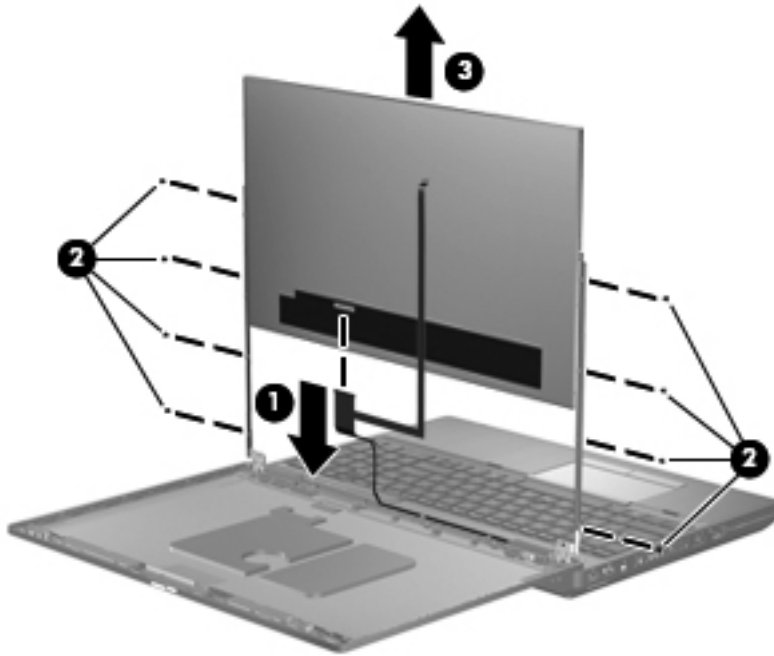

Reverse this procedure to reassemble and install the display assembly.

## SIM

 **NOTE:** This section applies only to computer models with WWAN capability.

 **NOTE:** If there is a SIM inserted in the SIM slot, it must be removed before disassembling the computer. Be sure that the SIM is reinserted in the SIM slot after reassembling the computer.

Before removing the SIM, follow these steps:

1. Shut down the computer. If you are unsure whether the computer is off or in Hibernation, turn the computer on, and then shut it down through the operating system.
2. Disconnect all external devices connected to the computer.
3. Disconnect the power from the computer by first unplugging the power cord from the AC outlet, and then unplugging the AC adapter from the computer.
4. Remove the battery (see [Battery on page 58](#)).

Remove the SIM:

1. Press in on the SIM **(1)**. (The module is partially ejected from the SIM slot.)
2. Remove the SIM **(2)** from the SIM slot.

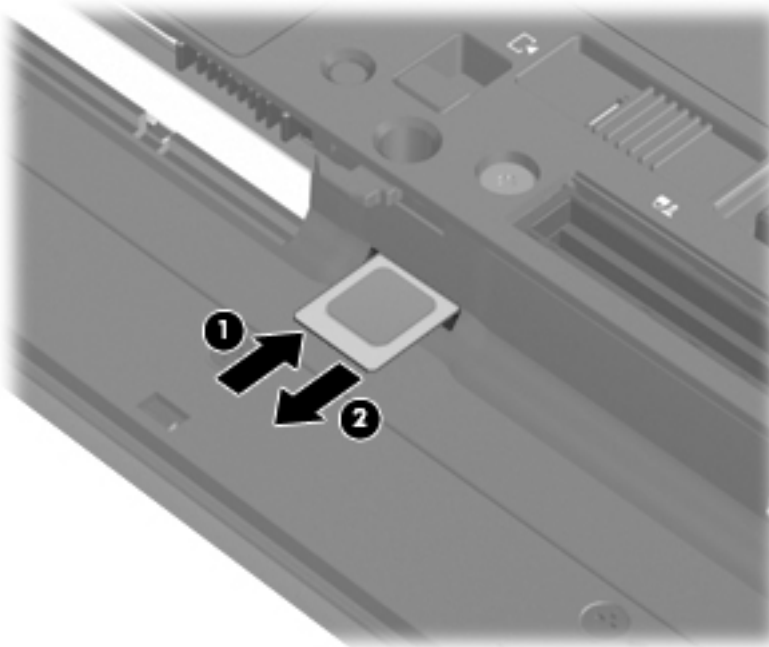

Reverse this procedure to install the SIM.

## Bottom door

The bottom door is available in the Plastics Kit, spare part number 646971-001 for HP ProBook 6560b models and 641190-001 for HP EliteBook 8560p models.

Before disassembling the computer, follow these steps:

1. Shut down the computer. If you are unsure whether the computer is off or in Hibernation, turn the computer on, and then shut it down through the operating system.
2. Disconnect all external devices connected to the computer.
3. Disconnect the power from the computer by first unplugging the power cord from the AC outlet, and then unplugging the AC adapter from the computer.
4. Remove the battery (see [Battery on page 58](#)).

Remove the bottom door:

1. Position the computer upside-down on a flat surface, with the battery bay toward you.
2. Slide the release latch **(1)** and remove the locking screw (if installed) **(2)**.
3. Slide the release latch **(3)** to disengage the door from the computer.
4. Slide the door toward the front of the computer **(4)**, and then lift the door off the computer **(5)**.

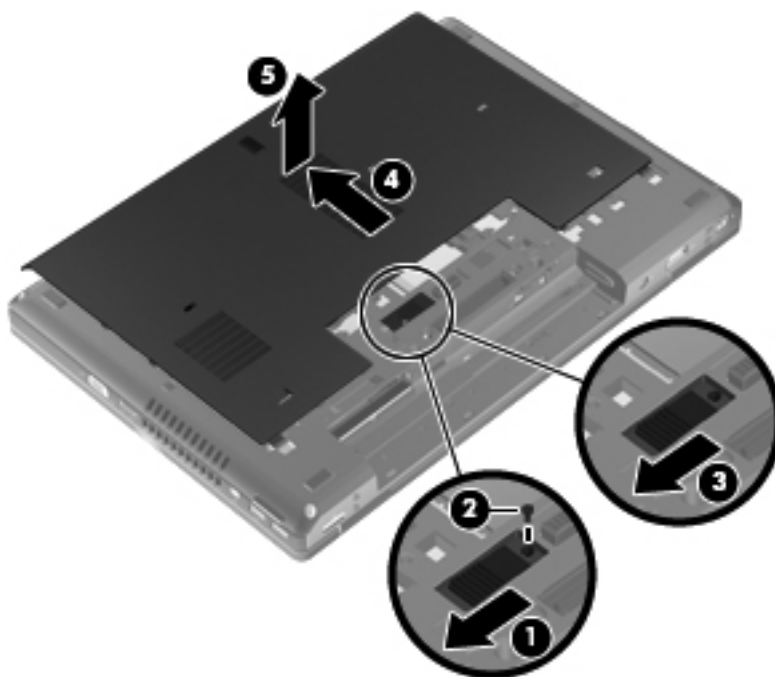

Reverse the removal procedures to install the bottom door.



## Optical drive



**NOTE:** All optical drive spare part kits include an optical drive bezel.

Description	Spare part number
<b>For use in HP ProBook 6560b models:</b>	
Blu-ray ROM DVD±RW SuperMulti DL Drive	649655-001
DVD±RW and CD-RW SuperMulti DL Combo Drive	649654-001
DVD-ROM Drive	649653-001
<b>For use in HP EliteBook 8560p models:</b>	
Blu-ray BD-R/RE DVD±RW SuperMulti DL Drive	651044-001
Blu-ray ROM DVD±RW SuperMulti DL Drive	651043-001
DVD±RW and CD-RW SuperMulti DL Combo Drive	651042-001
DVD-ROM Drive	651041-001

Before removing the optical drive, follow these steps:

1. Shut down the computer. If you are unsure whether the computer is off or in Hibernation, turn the computer on, and then shut it down through the operating system.
2. Disconnect all external devices connected to the computer.
3. Disconnect the power from the computer by first unplugging the power cord from the AC outlet, and then unplugging the AC adapter from the computer.
4. Remove the battery (see [Battery on page 58](#)).
5. Remove the bottom door (see [Bottom door on page 64](#)).

Remove the optical drive:

1. Position the computer upside-down with the right side toward you.
2. Loosen the captive Phillips screw **(1)** that secures the optical drive to the computer.
3. Push the optical drive tab **(2)** to release the optical drive from the computer.

4. Remove the optical drive **(3)** from the computer.

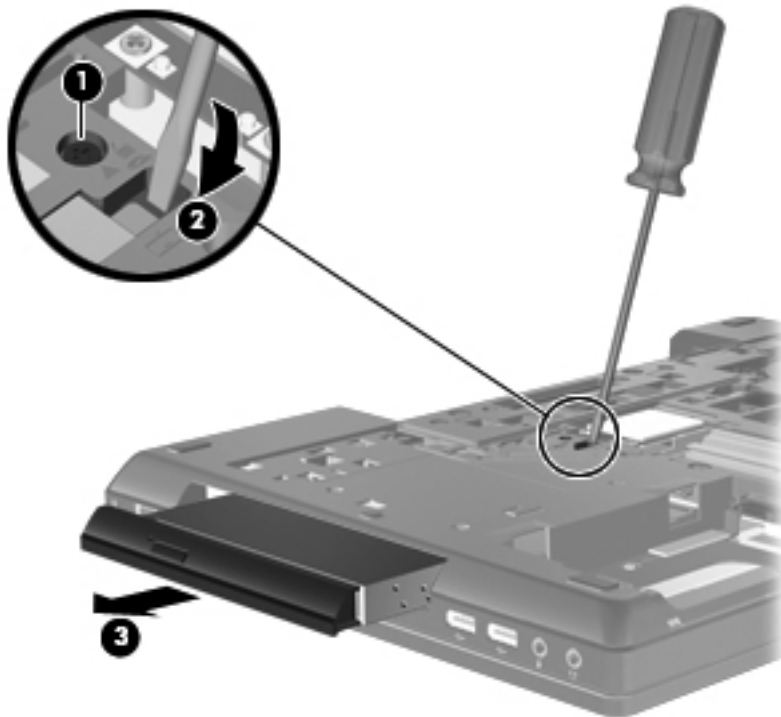

5. If it is necessary to replace the optical drive bracket, position the optical drive with the rear toward you.
6. Remove the three Phillips PM2.0×3.0 screws **(1)** that secure the optical drive bracket to the optical drive.
7. Remove the optical drive bracket **(2)**.

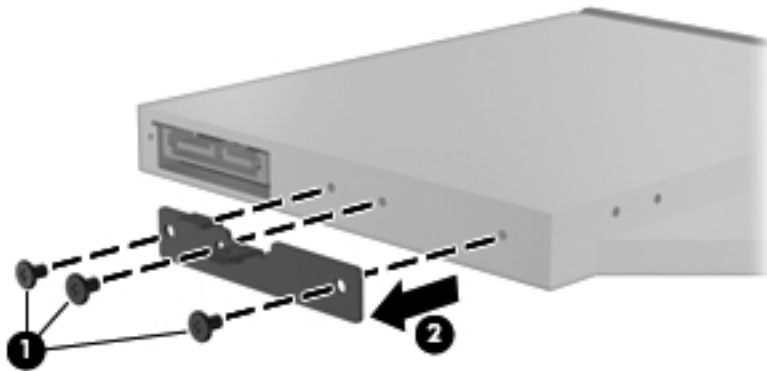

Reverse this procedure to install an optical drive.

## Upgrade bay

Description	Spare part number
500-GB, 7200-rpm hard drive	634919-001

Before removing a drive from the upgrade bay, follow these steps:

1. Shut down the computer. If you are unsure whether the computer is off or in Hibernation, turn the computer on, and then shut it down through the operating system.
2. Disconnect all external devices connected to the computer.
3. Disconnect the power from the computer by first unplugging the power cord from the AC outlet, and then unplugging the AC adapter from the computer.
4. Remove the battery (see [Battery on page 58](#)).
5. Remove the bottom door (see [Bottom door on page 64](#)).

Remove the drive from the upgrade bay:

1. Position the computer upside-down with the right side toward you.
2. Remove the four Phillips PM2.0×4.0 screws that secure the drive assembly into the upgrade bay.

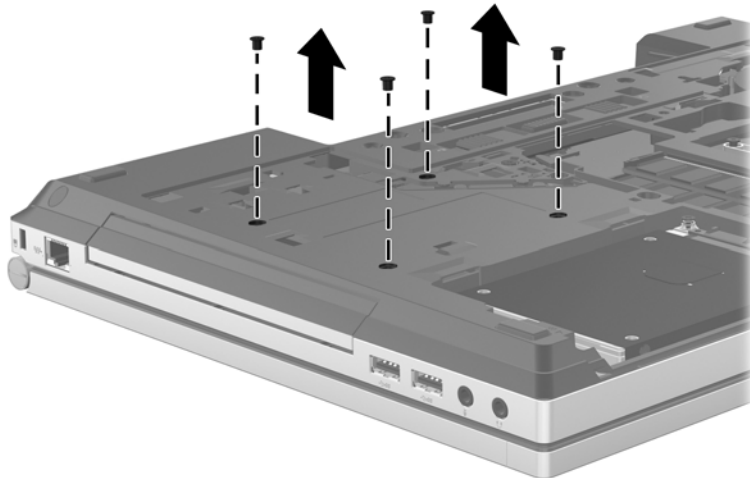

3. Loosen the captive Phillips screw that secures the drive in the bay (1).
4. Push the drive tab (2) to release the drive from the computer.

5. Remove the drive assembly (3) from the computer.

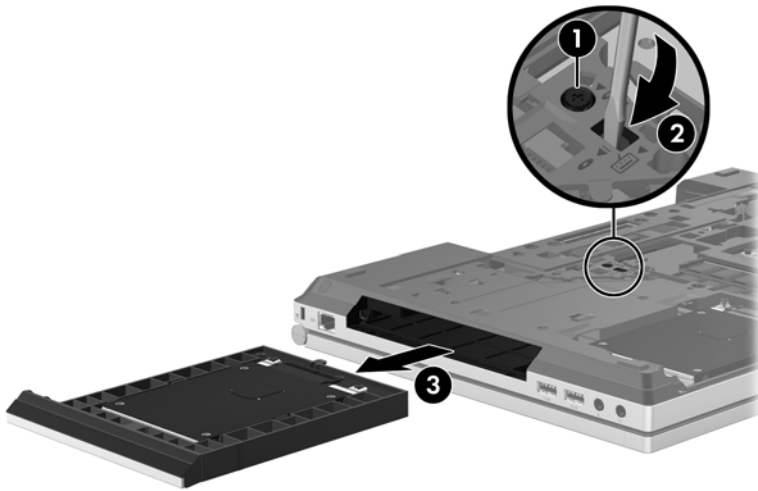

Reverse this procedure to install the drive into the upgrade bay.

## Hard drive



**NOTE:** All hard drive spare part kits include a hard drive bracket and screws.

Description	Spare part number
750-GB, 7200-rpm hard drive	633252-001
500-GB, 7200-rpm hard drive, for use in either the hard drive bay or the upgrade drive bay	634919-001
320-GB, 7200-rpm hard drive	641672-001
320-GB, 7200-rpm hard drive (Self-Encrypting Drive (SED))	626978-001
250-GB, 7200-rpm hard drive	635225-001
160-GB solid-state drive	649652-001
128-GB solid-state drive	649651-001
<b>Hard Drive Hardware Kit</b> (includes hard drive bracket and screws)	644694-001

Before disassembling the computer, follow these steps:

1. Shut down the computer. If you are unsure whether the computer is off or in Hibernation, turn the computer on, and then shut it down through the operating system.
2. Disconnect all external devices connected to the computer.
3. Disconnect the power from the computer by first unplugging the power cord from the AC outlet, and then unplugging the AC adapter from the computer.
4. Remove the battery (see [Battery on page 58](#)).
5. Remove the bottom door (see [Bottom door on page 64](#)).

Remove the hard drive:

1. Position the computer upside-down, with the battery bay toward you.
2. Loosen the three captive Phillips screws **(1)** that secure the hard drive to the computer.
3. Grasp the Mylar tab on the hard drive and slide the hard drive to the right **(2)** to disconnect it from the system board connector.

4. Remove the hard drive (3) from the hard drive bay.

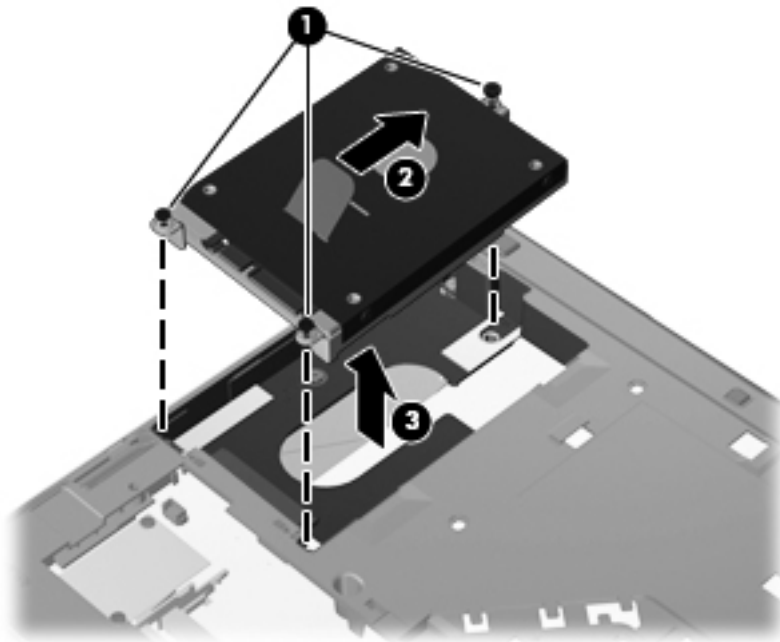

5. If it is necessary to replace the hard drive bracket, remove the two Phillips PM3.0×5.0 hard drive bracket screws (1) from each side of the hard drive (4 total screws).
6. Lift the bracket (2) straight up to remove it from the hard drive.

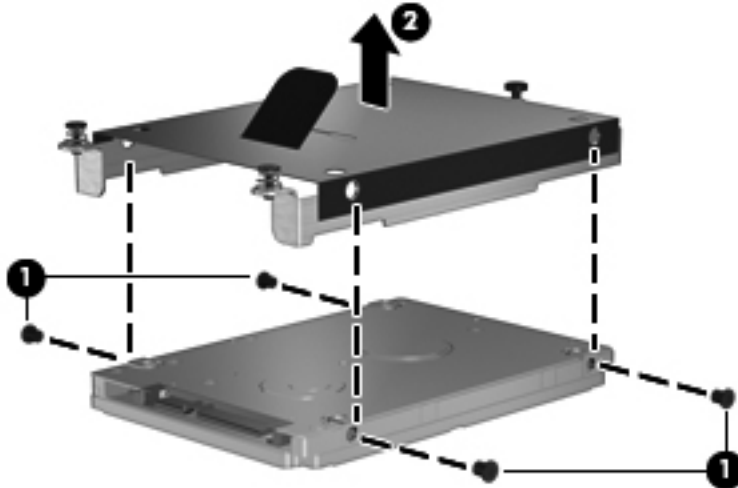

Reverse this procedure to reassemble and install the hard drive.

## RTC battery

Description	Spare part number
RTC battery	641200-001

Before removing the RTC battery, follow these steps:

1. Shut down the computer. If you are unsure whether the computer is off or in Hibernation, turn the computer on, and then shut it down through the operating system.
2. Disconnect all external devices connected to the computer.
3. Disconnect the power from the computer by first unplugging the power cord from the AC outlet, and then unplugging the AC adapter from the computer.
4. Remove the battery (see [Battery on page 58](#)).
5. Remove the bottom door (see [Bottom door on page 64](#)).

Remove the RTC battery:

1. Position the computer upside-down, with the front toward you.
2. Remove the battery from the slot as far as the attached cable will allow **(1)**.
3. Disconnect the battery cable from the system board **(2)**.

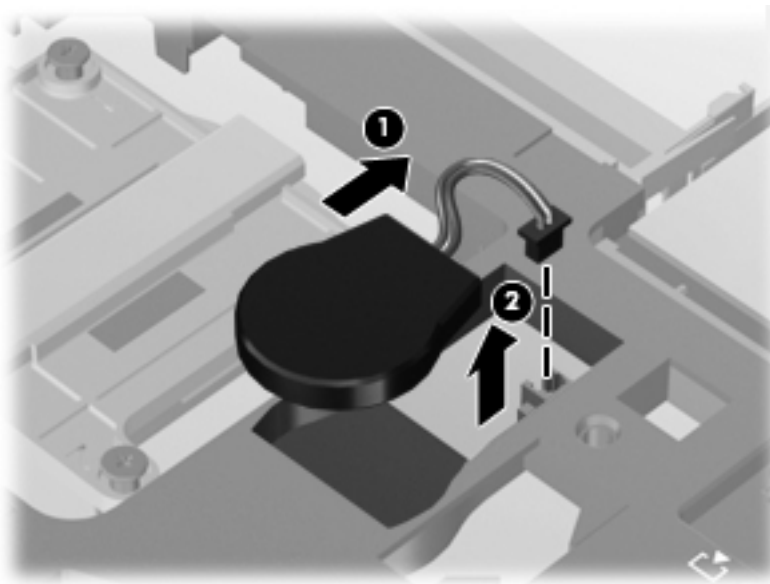

Reverse this procedure to install the RTC battery.

## Memory modules



**NOTE:** Primary and expansion memory is installed in a stacked configuration in the bottom of the computer.

Description	Spare part number
2-GB (PC3-10600, 1333-MHz, DDR3)	621565-001
4-GB (PC3-10600, 1333-MHz, DDR3)	621569-001
8-GB (PC3-10600, 1333-MHz, DDR3)	634091-001

### Update BIOS before adding memory modules

Before adding new memory, make sure you update the computer to the latest BIOS.



**CAUTION:** Failure to update the computer to the latest BIOS prior to installing new memory may result in various system problems.

To update BIOS:

1. Navigate to [www.hp.com](http://www.hp.com).
2. Click **Support & Drivers** > click **Drivers & Software**.
3. In the **Enter a product name/number** box, type the computer model information, and then click **Search**.
4. Click the link for the computer model.
5. Select the operating system, and then click **Next**.
6. Under **Step 2: Select a Download**, click the **BIOS** link.
7. Click the link for the most recent BIOS.
8. Click the **Download** button, and then follow the on-screen instructions.

Before removing the memory module, follow these steps:

1. Shut down the computer. If you are unsure whether the computer is off or in Hibernation, turn the computer on, and then shut it down through the operating system.
2. Disconnect all external devices connected to the computer.
3. Disconnect the power from the computer by first unplugging the power cord from the AC outlet, and then unplugging the AC adapter from the computer.
4. Remove the battery (see [Battery on page 58](#)).
5. Remove the bottom door (see [Bottom door on page 64](#)).

Remove the memory module:

1. Position the computer upside-down with the battery bay toward you.
2. Spread the retaining tabs **(1)** on each side of the memory module slot to release the memory module. (The edge of the module opposite the slot rises away from the computer.)



3. Remove the memory module (2) by pulling the module away from the slot at an angle.

 **NOTE:** Memory modules are designed with a notch (3) to prevent incorrect insertion into the memory module slot.

 **NOTE:** The computer uses two memory slots. The top slot houses the expansion memory module and is shown in the first image below. The bottom slot houses the primary memory module and is shown in the second image below.

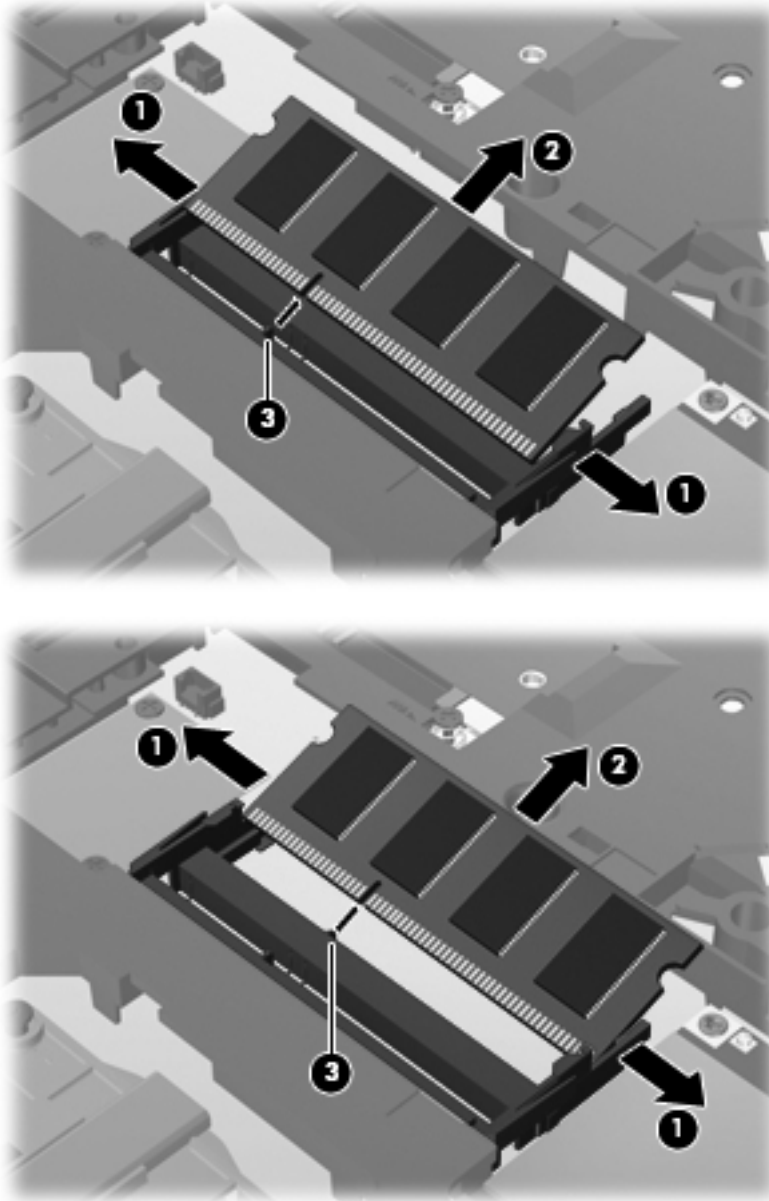

Reverse this procedure to install a memory module.

## WWAN module

 **CAUTION:** The WWAN module and the WLAN module are not interchangeable.

Description	Spare part number
HP hs2340 HSPA+ Mobile Broadband Module	632155-001
HP un2430 EV-DO/HSPA Mobile Broadband Module	634400-001

Before removing the WWAN module, follow these steps:

1. Shut down the computer. If you are unsure whether the computer is off or in Hibernation, turn the computer on, and then shut it down through the operating system.
2. Disconnect all external devices connected to the computer.
3. Disconnect the power from the computer by first unplugging the power cord from the AC outlet, and then unplugging the AC adapter from the computer.
4. Remove the battery (see [Battery on page 58](#)).
5. Remove the SIM (see [SIM on page 63](#)).
6. Remove the bottom door (see [Bottom door on page 64](#)).

Remove the WWAN module:

1. Disconnect the WWAN antenna cables **(1)** from the terminals on the WWAN module.



**NOTE:** The red WWAN antenna cable is connected to the WWAN module “Main” terminal. The blue WWAN antenna cable is connected to the WWAN module “Aux” terminal.

2. Remove the two Phillips PM2.0×3.0 screws **(2)** that secure the WWAN module to the computer. (The edge of the module opposite the slot rises away from the computer.)

3. Remove the WWAN module (3) by pulling the module away from the slot at an angle.

 **NOTE:** WWAN modules are designed with a notch (4) to prevent incorrect insertion.

**Figure 4-1** Removing the WWAN module

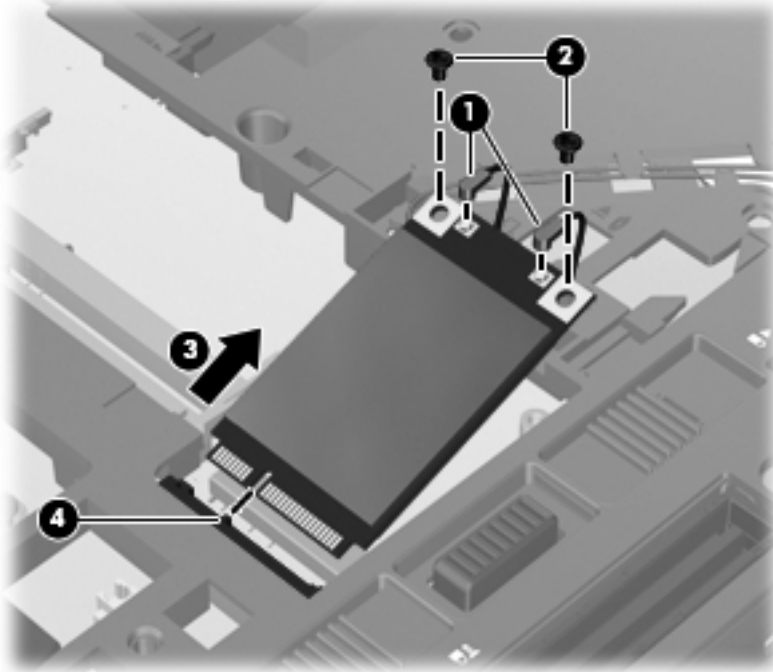

 **NOTE:** If the WWAN antennas are not connected to the terminals on the WWAN module, the protective sleeves must be installed on the antenna connectors, as shown in the following illustration.

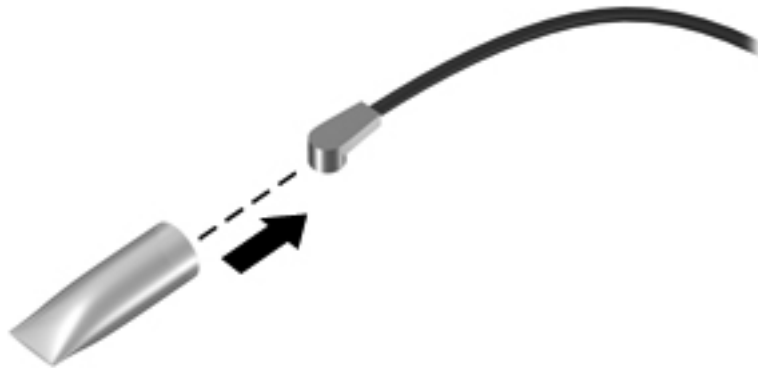

Reverse this procedure to install the WWAN module.

## WLAN module

 **CAUTION:** The WLAN module and the WWAN module are not interchangeable.

Description	Spare part number
Intel Wi-Fi Link 6300, 802.11a/b/g/n WLAN module for use in Andorra, Antigua and Barbuda, Argentina, Aruba, Australia, Austria, Azerbaijan, Bahamas, Bahrain, Barbados, Belgium, Bermuda, Bolivia, Bosnia and Herzegovina, Brazil, Brunei, Bulgaria, Canada, Cayman Islands, Chile, the People's Republic of China, Colombia, Costa Rica, Croatia, Cyprus, Czech Republic, Denmark, Dominican Republic, Ecuador, Egypt, El Salvador, Estonia, Finland, France, French Guiana, Georgia, Germany, Ghana, Greece, Guadeloupe, Guam, Guatemala, Haiti, Honduras, Hong Kong, Hungary, Iceland, India, Indonesia, Ireland, Israel, Italy, Ivory Coast, Jamaica, Japan, Jordan, Kenya, South Korea, Kuwait, Kyrgyzstan, Latvia, Lebanon, Martinique, US Virgin Islands, Puerto Rico, Nether Antilles, Liechtenstein, Lithuania, Luxembourg, Malawi, Malaysia, Malta, Mauritius, Mexico, Monaco, Montenegro, Morocco, the Netherlands, New Zealand, Nicaragua, Nigeria, Norway, Oman, Pakistan, Panama, Paraguay, Peru, Philippines, Poland, Portugal, Qatar, Romania, San Marino, Saudi Arabia, Senegal, Singapore, Slovakia, Slovenia, South Africa, Spain, Sri Lanka, Sweden, Switzerland, Taiwan, Tanzania, Thailand, Trinidad and Tobago, Turkey, the United Arab Emirates, the United Kingdom, the United States, Uruguay, Venezuela, and Vietnam	572511-001
Broadcom 43224AGN 802.11a/b/g/draft-n WiFi Adapter for use in Antigua and Barbuda, Aruba, the Bahamas, Barbados, Belize, Canada, Guam, Guinea, Haiti, Jamaica, the Nether Antilles, Puerto Rico, St. Kitts and Nevis, St. Lucia, St. Vincent and the Grenadines, Suriname, the US Virgin Islands, and the United States	582564-001
Broadcom 43224AGN 802.11a/b/g/draft-n WiFi Adapter for use in Albania, Algeria, Andorra, Angola, Argentina, Armenia, Australia, Austria, Azerbaijan, Bahrain, Belarus, Belgium, Benin, Bermuda, Bhutan, Bolivia, Bosnia and Herzegovina, Botswana, Brazil, the British Virgin Islands, Brunei, Bulgaria, Burkina Faso, Burundi, Cambodia, Cameroon, Cape Verde, the Cayman Islands, Central African Republic, Chad, Chile, People's Republic of China, Colombia, Comoros, Congo, Costa Rica, Croatia, Cyprus, the Czech Republic, Denmark, Djibouti, Dominica, the Dominican Republic, East Timor, Ecuador, Egypt, El Salvador, Equatorial Guinea, Eritrea, Estonia, Ethiopia, Fiji, Finland, France, French Guiana, Gabon, Gambia, Georgia, Germany, Ghana, Gibraltar, Greece, Grenada, Guadeloupe, Guatemala, Guinea, Guinea-Bissa, Honduras, Hong Kong, Hungary, Iceland, India, Ireland, Italy, Ivory Coast, Japan, Jordan, Kazakhstan, Kenya, Kiribati, Kuwait, Kyrgyzstan, Laos, Latvia, Lebanon, Lesotho, Liberia, Liechtenstein, Lithuania, Luxembourg, Macedonia, Madagascar, Malawi, Malaysia Maldives, Mali, Malta, Marshall Islands, Martinique, Mauritania, Mauritius, Mexico, Micronesia, Monaco, Mongolia, Montenegro, Morocco, Mozambique, Namibia, Nauru, Nepal, Netherlands, New Zealand, Nicaragua, Niger, Nigeria, Norway, Oman, Palau, Panama, Papua New Guinea, Paraguay, Peru, Philippines, Poland, Portugal, Qatar, Republic of Moldova, Romania, Rwanda, Samoa, San Marino, Sao Tome and Principe, Saudi Arabia, Senegal, Serbia and Montenegro, Seychelles, Sierra Leone, Singapore, Slovakia, Slovenia, Solomon Islands, Somalia, South Africa, South Korea, Spain, Sri Lanka, Swaziland, Sweden, Switzerland, Taiwan, Tajikistan, Tanzania, Thailand, Togo, Tonga, Trinidad and Tobago, Tunisia, Turkey, Turkmenistan, Tuvalu, Uganda, United Arab Emirates, United Kingdom, Uruguay, Uzbekistan, Vanuatu, Venezuela, Vietnam, Yemen, Zaire, Zambia, and Zimbabwe	582564-002

Description	Spare part number
Broadcom 4313AGN 802.11a/b/g/draft-n WiFi Adapter for use in Afghanistan, Albania, Algeria, Andorra, Angola, Antigua and Barbuda, Argentina, Armenia, Aruba, Australia, Austria, Azerbaijan, Bahamas, Bahrain, Bangladesh, Barbados, Belarus, Belgium, Belize, Benin, Bermuda, Bhutan, Bolivia, Bosnia and Herzegovina, Botswana, Brazil, the British Virgin Islands, Brunei, Bulgaria, Burkina Faso, Burundi, Cambodia, Cameroon, Canada, Cape Verde, the Cayman Islands, Central African Republic, Chad, People's Republic of China, Colombia, Comoros, Congo, Costa Rica, Croatia, Cyprus, the Czech Republic, Denmark, Djibouti, Dominica, the Dominican Republic, East Timor, Ecuador, Egypt, El Salvador, Equatorial Guinea, Eritrea, Estonia, Ethiopia, Fiji, Finland, France, French Guiana, Gabon, Gambia, Georgia, Germany, Ghana, Gibraltar, Greece, Grenada, Guadeloupe, Guam, Guatemala, Guinea, Guinea-Bissa, Guyana, Haiti, Honduras, Hong Kong, Hungary, Iceland, India, Iraq, Ireland, Israel, Italy, Ivory Coast, Jamaica, Japan, Jordan, Kazakhstan, Kenya, Kiribati, Kuwait, Kyrgyzstan, Laos, Latvia, Lebanon, Lesotho, Liberia, Martinique, Liechtenstein, Lithuania, Luxembourg, Macedonia, Madagascar, Malawi, Malaysia, Maldives, Mali, Malta, Marshall Islands, Mauritania, Mauritius, Mexico, Micronesia, Monaco, Mongolia, Montenegro, Morocco, Mozambique, Namibia, Nauru, Nepal, the Nether Antilles, the Netherlands, New Zealand, Nicaragua, Niger, Nigeria, Norway, Oman, Pakistan, Palau, Panama, Papua New Guinea, Paraguay, Puerto Rico, Peru, Philippines, Poland, Portugal, Qatar, Republic of Moldova, Romania, Russia, Rwanda, Samoa, San Marino, Sao Tome and Principe, Saudi Arabia, Senegal, Serbia and Montenegro, Seychelles, Sierra Leone, Singapore, Slovakia, Slovenia, Solomon Islands, Somalia, South Africa, South Korea, Spain, Sri Lanka, St. Kitts and Nevis, St. Lucia, St. Vincent and the Grenadines, Suriname, Swaziland, Sweden, Switzerland, Syria, Taiwan, Tajikistan, Tanzania, Thailand, Togo, Tonga, Trinidad and Tobago, Tunisia, Turkey, Turkmenistan, Tuvalu, Uganda, Ukraine, the United Arab Emirates, the United Kingdom, Uruguay, the United States, the US Virgin Islands, Uzbekistan, Vanuatu, Venezuela, Vietnam, Yemen, Zaire, Zambia, and Zimbabwe	593836-001
Intel Wi-Fi Link 1000 for use in Andorra, Antigua and Barbuda, Argentina, Aruba, Australia, Austria, Azerbaijan, Bahamas, Bahrain, Barbados, Belgium, Bermuda, Bolivia, Bosnia and Herzegovina, Brazil, Brunei, Bulgaria, Canada, the Cayman Islands, Chile, People's Republic of China, Colombia, Costa Rica, Croatia, Cyprus, the Czech Republic, Denmark, the Dominican Republic, Ecuador, Egypt, El Salvador, Estonia, Finland, France, French Guiana, Georgia, Germany, Ghana, Greece, Guadeloupe, Guam, Guatemala, Haiti, Honduras, Hong Kong, Hungary, Iceland, India, Indonesia, Ireland, Israel, Italy, Ivory Coast, Jamaica, Japan, Jordan, Kenya, Kuwait, Kyrgyzstan, Latvia, Lebanon, Liechtenstein, Lithuania, Luxembourg, Malawi, Malaysia, Malta, Martinique, Mauritius, Mexico, Monaco, Montenegro, Morocco, the Nether Antilles, Netherlands, New Zealand, Nicaragua, Nigeria, Norway, Oman, Pakistan, Panama, Paraguay, Peru, Philippines, Poland, Portugal, Puerto Rico, Qatar, Romania, San Marino, Saudi Arabia, Senegal, Singapore, Slovakia, Slovenia, South Africa, South Korea, Spain, Sri Lanka, Sweden, Switzerland, Taiwan, Tanzania, Thailand, Trinidad and Tobago, Turkey, Ukraine, United Arab Emirates, United Kingdom, Uruguay, the US Virgin Islands, the United States, Venezuela, and Vietnam	593530-001

Description	Spare part number
<p>Atheros HB112AGN 802.11a/b/g/n 3x3 WiFi Adapter for use in Afghanistan, Albania, Algeria, Andorra, Angola, Antigua and Barbuda, Argentina, Armenia, Aruba, Australia, Austria, Azerbaijan, Bahamas, Bahrain, Bangladesh, Barbados, Belarus, Belgium, Belize, Benin, Bermuda, Bhutan, Bolivia, Bosnia and Herzegovina, Botswana, Brazil, the British Virgin Islands, Brunei, Bulgaria, Burkina Faso, Burundi, Cambodia, Cameroon, Canada, Cape Verde, the Cayman Islands, Central African Republic, Chad, People's Republic of China, Colombia, Comoros, Congo, Costa Rica, Croatia, Cyprus, the Czech Republic, Denmark, Djibouti, Dominica, the Dominican Republic, East Timor, Ecuador, Egypt, El Salvador, Equatorial Guinea, Eritrea, Estonia, Ethiopia, Fiji, Finland, France, French Guiana, Gabon, Gambia, Georgia, Germany, Ghana, Gibraltar, Greece, Grenada, Guadeloupe, Guam, Guatemala, Guinea, Guinea-Bissa, Guyana, Haiti, Honduras, Hong Kong, Hungary, Iceland, India, Iraq, Ireland, Israel, Italy, Ivory Coast, Jamaica, Japan, Jordan, Kazakhstan, Kenya, Kiribati, Kuwait, Kyrgyzstan, Laos, Latvia, Lebanon, Lesotho, Liberia, Martinique, Liechtenstein, Lithuania, Luxembourg, Macedonia, Madagascar, Malawi, Malaysia, Maldives, Mali, Malta, Marshall Islands, Mauritania, Mauritius, Mexico, Micronesia, Monaco, Mongolia, Montenegro, Morocco, Mozambique, Namibia, Nauru, Nepal, the Nether Antilles, the Netherlands, New Zealand, Nicaragua, Niger, Nigeria, Norway, Oman, Pakistan, Palau, Panama, Papua New Guinea, Paraguay, Puerto Rico, Peru, Philippines, Poland, Portugal, Qatar, Republic of Moldova, Romania, Russia, Rwanda, Samoa, San Marino, Sao Tome and Principe, Saudi Arabia, Senegal, Serbia and Montenegro, Seychelles, Sierra Leone, Singapore, Slovakia, Slovenia, Solomon Islands, Somalia, South Africa, South Korea, Spain, Sri Lanka, St. Kitts and Nevis, St. Lucia, St. Vincent and the Grenadines, Suriname, Swaziland, Sweden, Switzerland, Syria, Taiwan, Tajikistan, Tanzania, Thailand, Togo, Tonga, Trinidad and Tobago, Tunisia, Turkey, Turkmenistan, Tuvalu, Uganda, Ukraine, the United Arab Emirates, the United Kingdom, Uruguay, the United States, the US Virgin Islands, Uzbekistan, Vanuatu, Venezuela, Vietnam, Yemen, Zaire, Zambia, and Zimbabwe</p>	630435-001
<p>Intel Centrino Advanced-N 6205 for use in Afghanistan, Albania, Algeria, Andorra, Angola, Antigua and Barbuda, Argentina, Armenia, Australia, Austria, Azerbaijan, Bahamas, Bahrain, Bangladesh, Barbados, Belarus, Belgium, Belize, Benin, Bermuda, Bhutan, Bolivia, Bosnia and Herzegovina, Botswana, Brazil, the British Virgin Islands, Brunei, Bulgaria, Burkina Faso, Burundi, Cambodia, Cameroon, Canada, Cape Verde, the Cayman Islands, Central African Republic, Chad, People's Republic of China, Colombia, Comoros, Congo, Costa Rica, Croatia, Cyprus, the Czech Republic, Denmark, Djibouti, Dominica, the Dominican Republic, East Timor, Ecuador, Egypt, El Salvador, Equatorial Guinea, Eritrea, Estonia, Ethiopia, Fiji, Finland, France, French Guiana, Gabon, Gambia, Georgia, Germany, Ghana, Gibraltar, Greece, Grenada, Guadeloupe, Guam, Guatemala, Guinea, Guinea-Bissa, Guyana, Haiti, Honduras, Hong Kong, Hungary, Iceland, India, Iraq, Ireland, Israel, Italy, Ivory Coast, Jamaica, Japan, Jordan, Kazakhstan, Kenya, Kiribati, Kuwait, Kyrgyzstan, Laos, Latvia, Lebanon, Lesotho, Liberia, Martinique, Liechtenstein, Lithuania, Luxembourg, Macedonia, Madagascar, Malawi, Malaysia, Maldives, Mali, Malta, Marshall Islands, Mauritania, Mauritius, Mexico, Micronesia, Monaco, Mongolia, Montenegro, Morocco, Mozambique, Namibia, Nauru, Nepal, the Nether Antilles, the Netherlands, New Zealand, Nicaragua, Niger, Nigeria, Norway, Oman, Pakistan, Palau, Panama, Papua New Guinea, Paraguay, Puerto Rico, Peru, Philippines, Poland, Portugal, Qatar, Republic of Moldova, Romania, Russia, Rwanda, Samoa, San Marino, Sao Tome and Principe, Saudi Arabia, Senegal, Serbia and Montenegro, Seychelles, Sierra Leone, Singapore, Slovakia, Slovenia, Solomon Islands, Somalia, South Africa, South Korea, Spain, Sri Lanka, St. Kitts and Nevis, St. Lucia, St. Vincent and the Grenadines, Suriname, Swaziland, Sweden, Switzerland, Syria, Taiwan, Tajikistan, Tanzania, Thailand, Togo, Tonga, Trinidad and Tobago, Tunisia, Turkey, Turkmenistan, Tuvalu, Uganda, Ukraine, the United Arab Emirates, the United Kingdom, Uruguay, the United States, the US Virgin Islands, Uzbekistan, Vanuatu, Venezuela, Vietnam, Yemen, Zaire, Zambia, and Zimbabwe</p>	631954-001

Before removing the WLAN module, follow these steps:

1. Shut down the computer. If you are unsure whether the computer is off or in Hibernation, turn the computer on, and then shut it down through the operating system.
2. Disconnect all external devices connected to the computer.

3. Disconnect the power from the computer by first unplugging the power cord from the AC outlet, and then unplugging the AC adapter from the computer.
4. Remove the battery (see [Battery on page 58](#)).
5. Remove the bottom door (see [Bottom door on page 64](#)).

Remove the WLAN module:

1. Position the computer right-side up with the battery bay toward you.
2. Disconnect the WLAN antenna cables **(1)** from the terminals on the WLAN module.

---

 **NOTE:** The WLAN antenna cable labeled “1” connects to the WLAN module “Main” terminal labeled “1”. The WLAN antenna cable labeled “2” connects to the WLAN module “Aux” terminal labeled “2”. If the computer is equipped with an 802.11a/b/g/n WLAN module, the yellow WLAN antenna cable connects to the middle terminal on the WLAN module.

---

3. Remove the two Phillips PM2.0×3.0 screws **(2)** that secure the WLAN module to the computer. (The edge of the module opposite the slot rises away from the computer.)

4. Remove the WLAN module (3) by pulling the module away from the slot at an angle.

 **NOTE:** WLAN modules are designed with a notch (4) to prevent incorrect insertion.

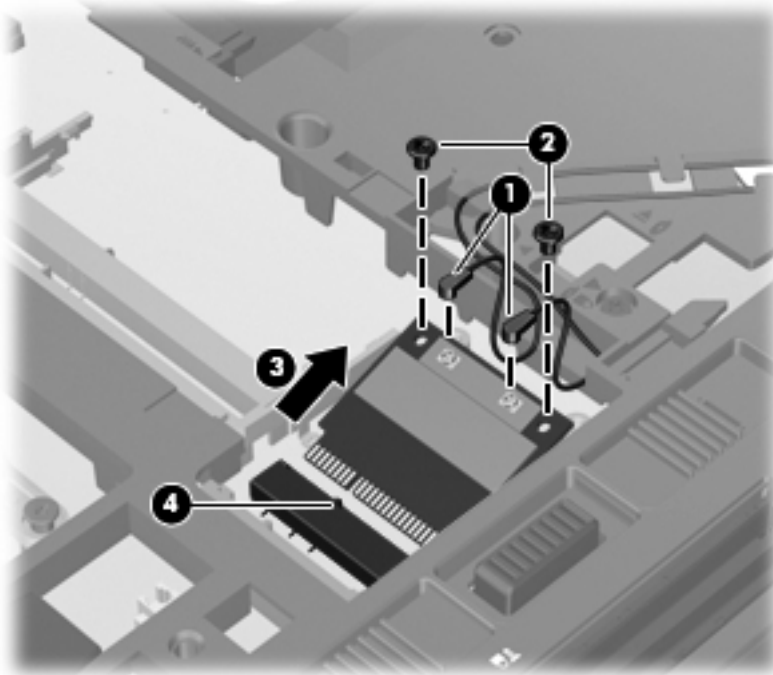

 **NOTE:** If the WLAN antennas are not connected to the terminals on the WLAN module, the protective sleeves must be installed on the antenna connectors, as shown in the following illustration.

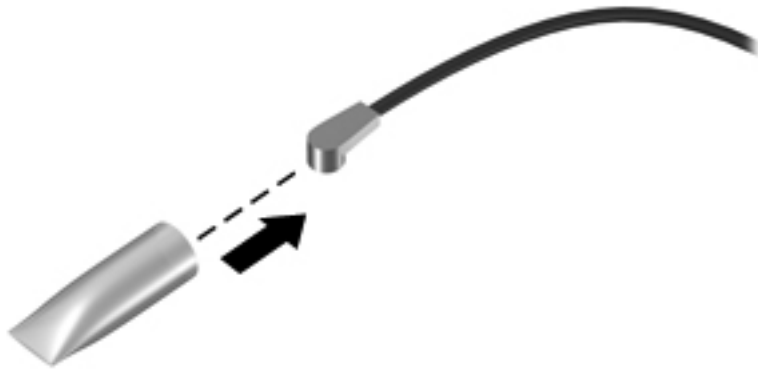

Reverse this procedure to install the WLAN module.



## Bluetooth module



**NOTE:** The Bluetooth module spare part kit does not include a Bluetooth module cable. The Bluetooth module cable is included in the Cable Kit, spare part number 646968-001 for use in 6560b models and 641188-001 for use in 8560p models. See [Cable Kit on page 37](#) for more Cable Kit spare part number information.

Description	Spare part number
Bluetooth module	537921-001

Before removing the Bluetooth module, follow these steps:

1. Shut down the computer. If you are unsure whether the computer is off or in Hibernation, turn the computer on, and then shut it down through the operating system.
2. Disconnect all external devices connected to the computer.
3. Disconnect the power from the computer by first unplugging the power cord from the AC outlet, and then unplugging the AC adapter from the computer.
4. Remove the battery (see [Battery on page 58](#)).
5. Remove the bottom door (see [Bottom door on page 64](#)).

Remove the Bluetooth module:

1. Position the computer upside-down with the front toward you.

2. Lift the module straight up out of the computer (1), and then disconnect the cable (2) from the module.

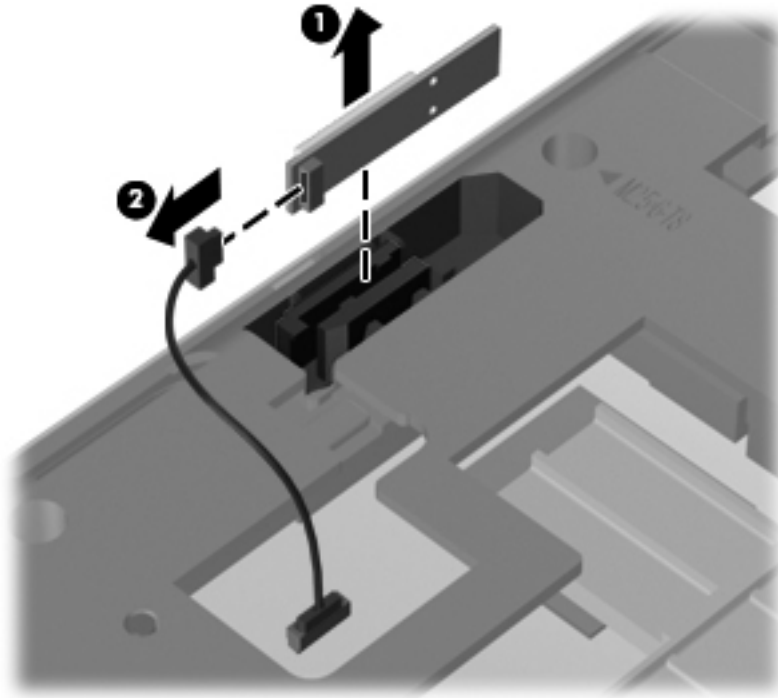

3. Remove the module from the computer.

Reverse this procedure to install the Bluetooth module.

## Modem module



**NOTE:** The modem module spare part kit does not include a modem module cable. The modem module cable is included in the Cable Kit, spare part number 646968-001 for use in 6560b models, 641188-001 for use in 8560p models. See [Cable Kit on page 37](#) for more Cable Kit spare part number information.

Description	Spare part number
Modem module	628824-001

Before removing the modem module, follow these steps:

1. Shut down the computer. If you are unsure whether the computer is off or in Hibernation, turn the computer on, and then shut it down through the operating system.
2. Disconnect all external devices connected to the computer.
3. Disconnect the power from the computer by first unplugging the power cord from the AC outlet, and then unplugging the AC adapter from the computer.
4. Remove the battery (see [Battery on page 58](#)).
5. Remove the bottom door (see [Bottom door on page 64](#)).

Remove the modem module:

1. Position the computer upside-down with the front toward you.
2. Remove the two Phillips PM2.0×3.0 screws **(1)** that secure the modem module to the system board.
3. Disconnect the modem module **(2)** from the system board by lifting it straight up.

4. Disconnect the modem module cable (3) from the modem module.

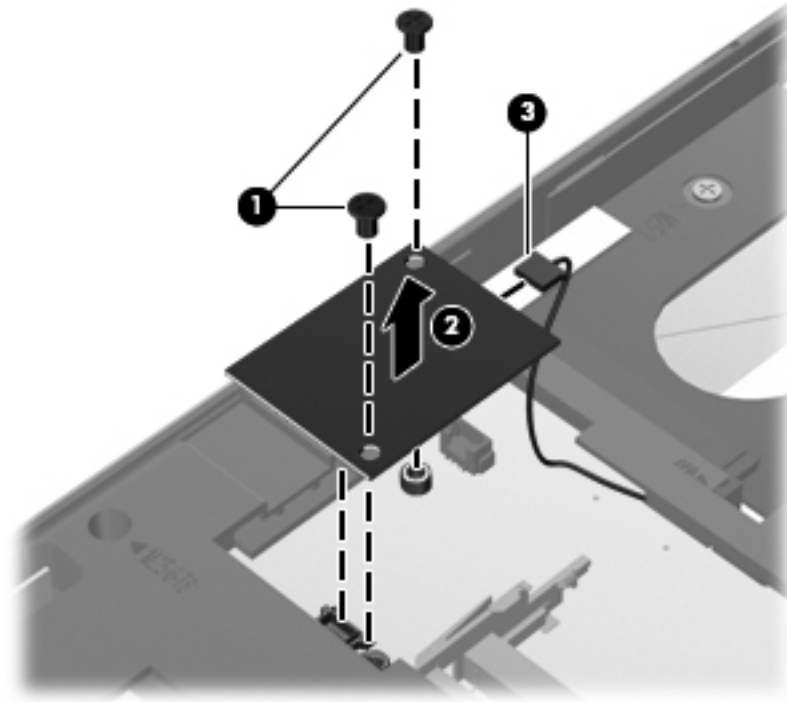

Reverse this procedure to install the modem module.

## Fan

Description	Spare part number
Fan	641183-001

Before removing the fan, follow these steps:

1. Shut down the computer. If you are unsure whether the computer is off or in Hibernation, turn the computer on, and then shut it down through the operating system.
2. Disconnect all external devices connected to the computer.
3. Disconnect the power from the computer by first unplugging the power cord from the AC outlet, and then unplugging the AC adapter from the computer.
4. Remove the battery (see [Battery on page 58](#)).
5. Remove the bottom door (see [Bottom door on page 64](#)).

Remove the fan:

1. Position the computer upside-down with the front toward you.
2. Loosen the three captive Phillips screws (1) that secure the fan to the bottom cover.
3. Rotate the right side of the fan upward at an angle (2), and then lift the fan up to gain access to the system board connector.
4. Disconnect the fan cable (3) from the system board.

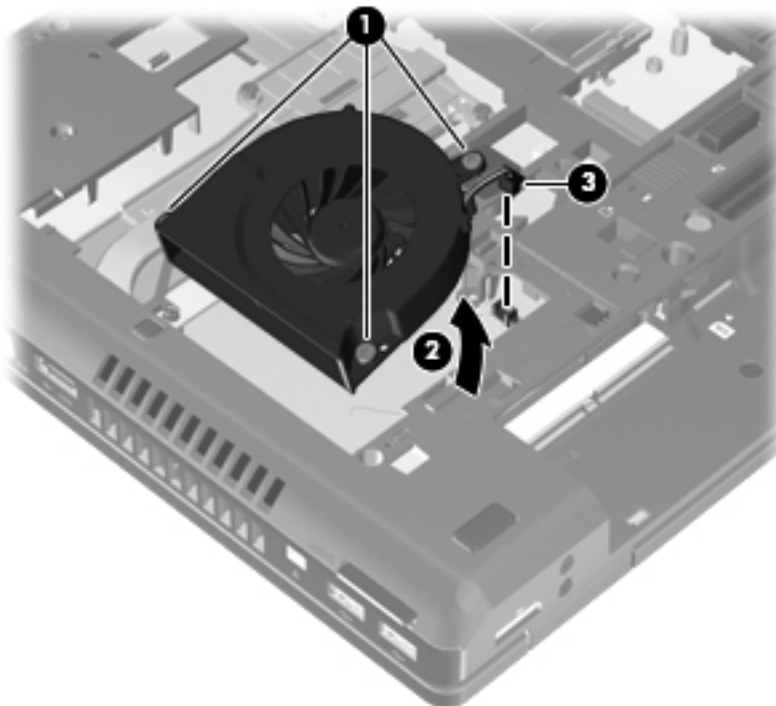

Reverse this procedure to install the fan.



**NOTE:** To properly ventilate the computer, allow at least a 7.6-cm (3-in) clearance on the left side of the computer.

The computer uses an electric fan for ventilation. The fan is controlled by a temperature sensor and is designed to turn on automatically when high temperature conditions exist. These conditions are affected by high external temperatures, system power consumption, power management/battery conservation configurations, battery fast charging, and software requirements. Exhaust air is displaced through the ventilation grill located on the left side of the computer.

## Heat sink

All heat sink spare part kits include replacement thermal material, including thermal grease and pads.

Description	Spare part number
Heat sink for use in computers with UMA graphics	647603-001
Heat sink for use in computers with discrete graphics	647604-001

Before removing the heat sink, follow these steps:

1. Shut down the computer. If you are unsure whether the computer is off or in Hibernation, turn the computer on, and then shut it down through the operating system.
2. Disconnect all external devices connected to the computer.
3. Disconnect the power from the computer by first unplugging the power cord from the AC outlet, and then unplugging the AC adapter from the computer.
4. Remove the battery (see [Battery on page 58](#)).
5. Remove the bottom door (see [Bottom door on page 64](#)).
6. Remove the fan (see [Fan on page 85](#)).

Remove the heat sink:

1. Position the computer upside-down with the front toward you.
2. If removing the discrete heat sink, in the order indicated, loosen the captive Phillips screws **(1)** that secure the heat sink to the system board.
3. Lift the heat sink up at an angle **(2)**.

4. Pull the heat sink away from the side of the computer to remove it (3).

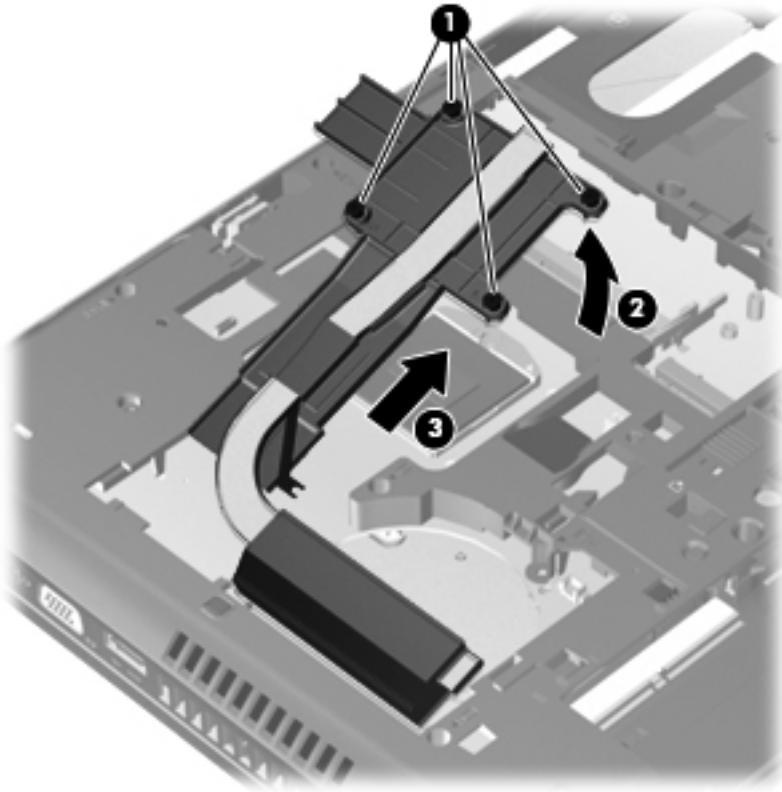

5. If removing the UMA heat sink, in the order indicated, loosen the captive Phillips screws (1) that secure the heat sink to the system board.
6. Lift the heat sink up at an angle (2).

7. Pull the heat sink away from the side of the computer to remove it **(3)**.

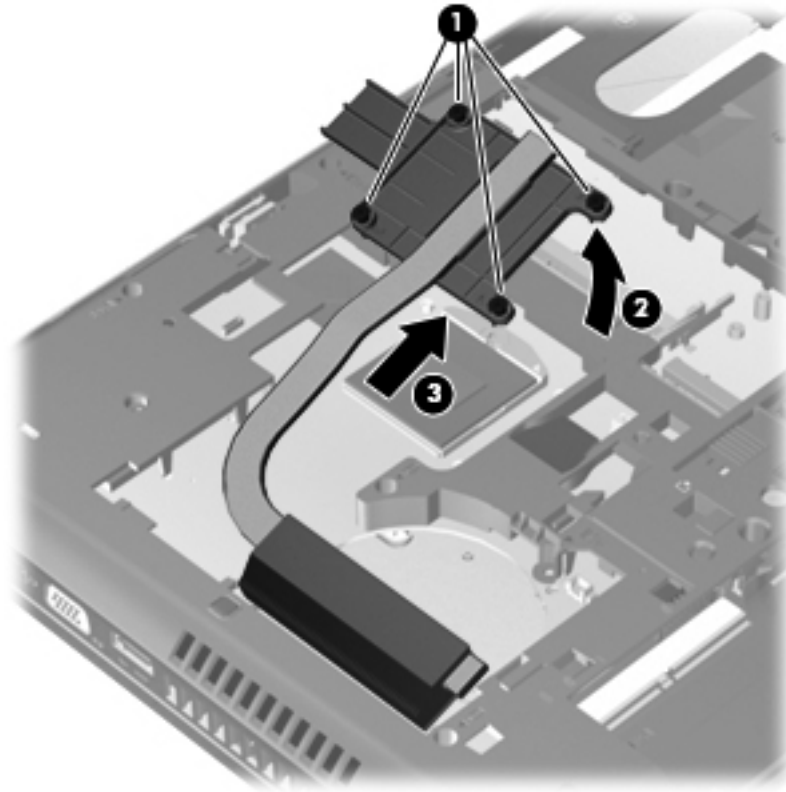

---

 **NOTE:** For discrete models, thoroughly clean thermal material from the surfaces of the system board components **(1)(3)(5)**, the heat sink **(2)(4)(6)** each time you remove the heat sink. All heat sink and processor spare part kits include thermal material.

In the following illustration, the location denoted by callout **(2)** on the heat sink uses thermal grease. The location denoted by callout **(4)** on the heat sink uses a GPU thermal pad. The location denoted by callout **(6)** on the heat sink uses a PCH thermal pad.

---



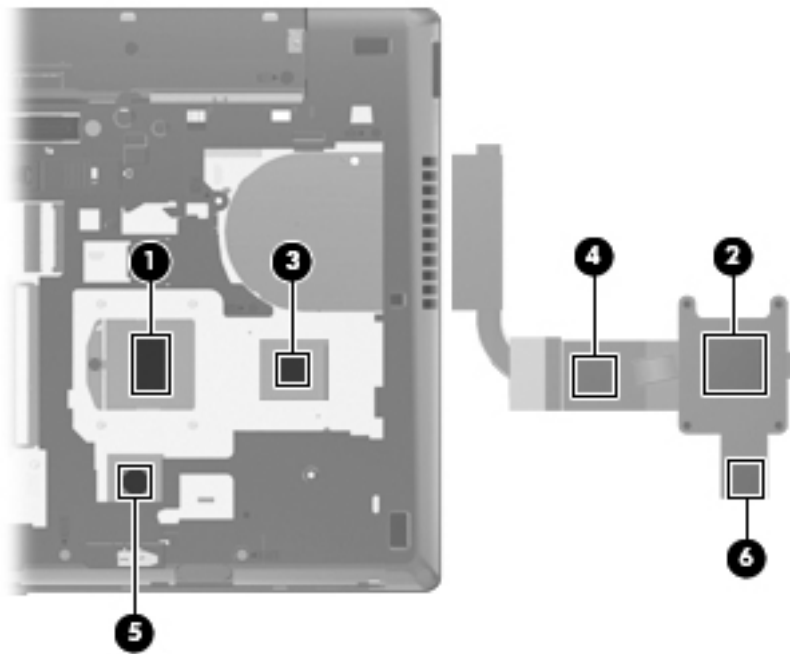

**NOTE:** For UMA models, thoroughly clean thermal material from the surfaces of the system board **(1)(3)** and heat sink **(2)(4)** each time you remove the heat sink. All heat sink and processor spare part kits include thermal material.

In the following illustration, the location denoted by callout **(2)** on the heat sink uses thermal grease. The location denoted by callout **(4)** on the heat sink uses a PCH thermal pad.

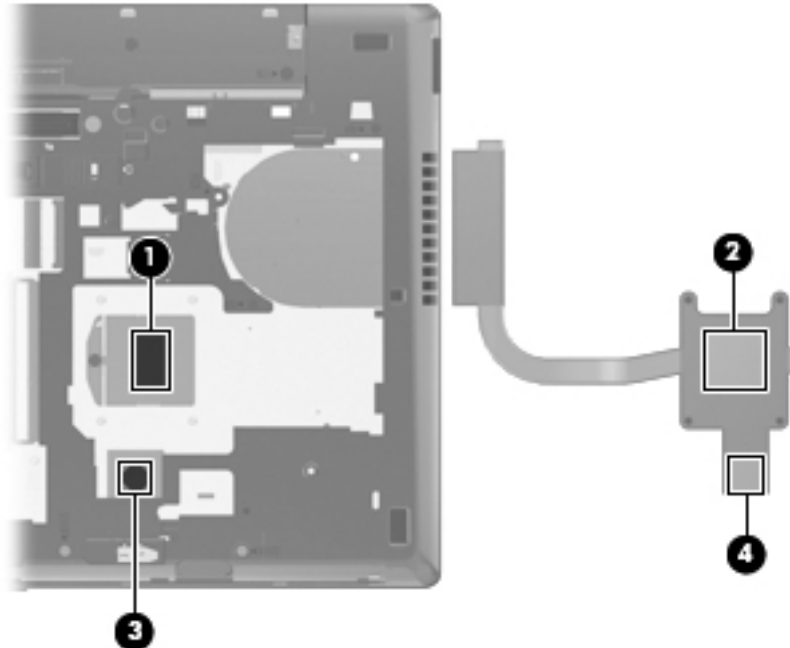

Reverse this procedure to install the heat sink.

## Processor



**NOTE:** All processor spare part kits include replacement thermal material, including thermal grease and pads.

Description	Spare part number
<b>Intel Core i7 processors, Quad Core</b>	
2720QM, 2.2-GHz (turbo up to 3.3-GHz) processor with 6-MB L3 cache (includes thermal grease)	631254-005
2630QM, 2.0-GHz (turbo up to 2.9-GHz) processor with 6-MB L3 cache (includes thermal grease)	635501-005
<b>Intel Core i7 processor, Dual Core</b>	
2620M, 2.7-GHz (turbo up to 3.4-GHz) processor with 4-MB L3 cache (includes thermal grease)	631252-005
<b>Intel Core i5 processors, Dual Core</b>	
2540M, 2.6-GHz (turbo up to 3.3-GHz) processor with 3-MB L3 cache (includes thermal grease)	631255-005
2520M, 2.5-GHz (turbo up to 3.2-GHz) processor with 3-MB L3 cache (includes thermal grease)	631253-005
2410M, 2.3-GHz (turbo up to 2.9-GHz) processor with 3-MB L3 cache (includes thermal grease)	638039-005
<b>Intel Core i3 processors, Dual Core</b>	
2310M, 2.1-GHz processor with 3-MB L3 cache (includes thermal grease)	638037-005
<b>NOTE:</b> At temperatures above 30° C (86° F), the Intel Core i3-2310M Processor may run at decreased performance.	
<b>Intel Celeron processor, Dual Core</b>	
B810, 1.6-GHz, with 2-MB L3 cache (includes thermal grease)	646760-005

Before removing the processor, follow these steps:

1. Shut down the computer. If you are unsure whether the computer is off or in Hibernation, turn the computer on, and then shut it down through the operating system.
2. Disconnect all external devices connected to the computer.
3. Disconnect the power from the computer by first unplugging the power cord from the AC outlet, and then unplugging the AC adapter from the computer.
4. Remove the battery (see [Battery on page 58](#)).
5. Remove the bottom door (see [Bottom door on page 64](#)).
6. Remove the fan (see [Fan on page 85](#)).
7. Remove the heat sink (see [Heat sink on page 86](#)).

Remove the processor:

1. Position the computer upside-down with the front toward you.
2. Use a flat-bladed screwdriver to turn the processor locking screw **(1)** one-half turn counterclockwise until you hear a click.

3. Lift the processor (2) straight up and remove it.

 **NOTE:** The gold triangle (3) on the processor must be aligned with the triangle (4) embossed on the processor slot when you install the processor.

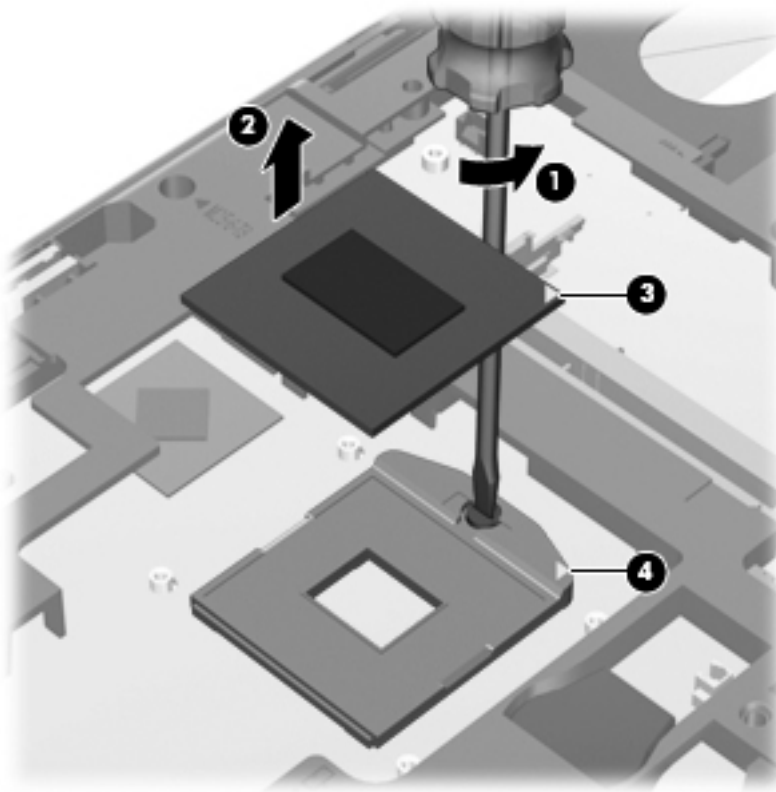

Reverse this procedure to install the processor.

## Keyboard



**NOTE:** For a detailed list of available keyboards, see [Sequential part number listing on page 40](#).

Description	Spare part number
Keyboard for use in model 6560b without a pointing stick	641180-xxx
Keyboard for use in model 6560b with a pointing stick	641179-xxx
Keyboard for use in model 8560p	641181-xxx

Before removing the keyboard, follow these steps:

1. Shut down the computer. If you are unsure whether the computer is off or in Hibernation, turn the computer on, and then shut it down through the operating system.
2. Disconnect all external devices connected to the computer.
3. Disconnect the power from the computer by first unplugging the power cord from the AC outlet, and then unplugging the AC adapter from the computer.
4. Remove the battery (see [Battery on page 58](#)).
5. Remove the bottom door (see [Bottom door on page 64](#)).
6. Remove the fan (see [Fan on page 85](#)).
7. Remove the heat sink (see [Heat sink on page 86](#)).

Remove the keyboard:

1. Position the computer upside-down with the battery bay toward you.
2. Loosen the three Phillips captive screws that secure the keyboard to the computer.

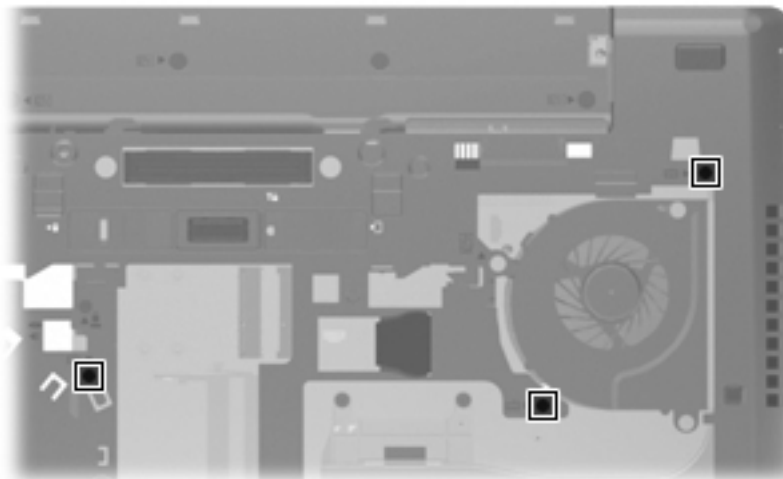

3. Using a screwdriver or similar tool, press in the gap in the left side of the battery bay to disengage the keyboard.

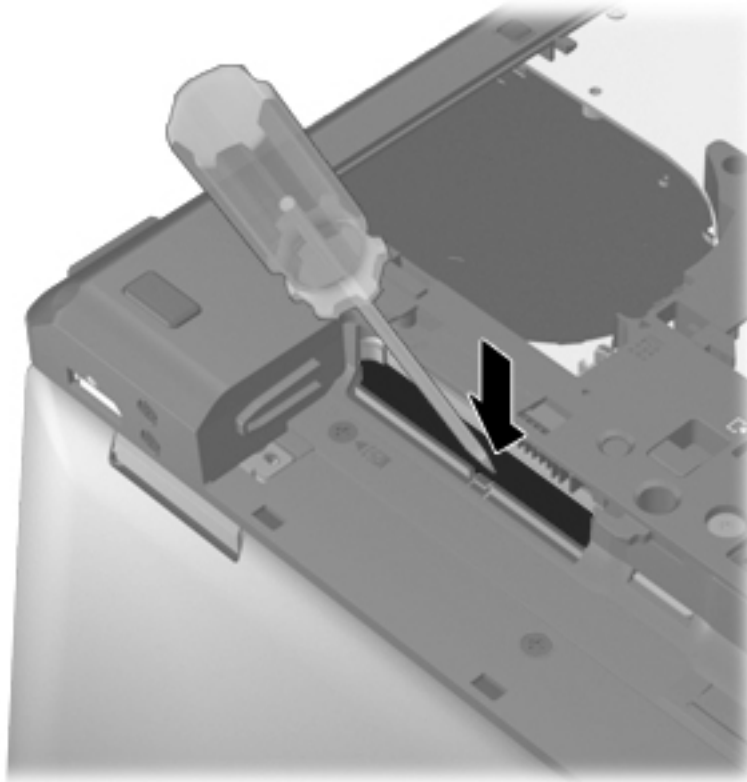

4. Position the computer right-side up with the front toward you.
5. Open the computer as far as possible.
6. Lift and rotate the keyboard upward to gain access to the cables.



7. Lift the keyboard connector latch (1), and then disconnect the keyboard cable from the system board (2).

- Lift the pointing stick connector latch (3), and then disconnect the pointing stick cable from the system board (4).

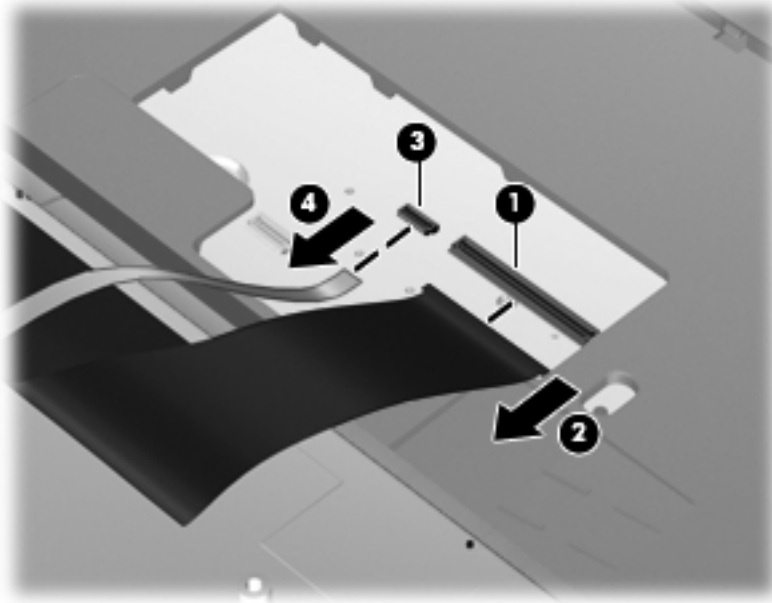

- Remove the keyboard.

Reverse this procedure to install the keyboard.

## Bottom cover



**NOTE:** Make sure to remove the modem plug from the slot in the bottom cover if the repaired unit includes a modem.

Description	Spare part number
<b>Bottom cover</b>	
For use with HP ProBook 6560b models:	644695-001
For use with HP ProBook 8560b models:	641182-001
<b>Top cover for use in 6560b models:</b>	
Includes touchpad only	641203-001
Includes fingerprint reader, without pointing stick	641204-001
Includes fingerprint reader and pointing stick	641205-001
Includes pointing stick, without a fingerprint reader	641206-001
<b>Top cover for use in 8560p models:</b>	
Includes fingerprint reader and pointing stick	641207-001
Includes pointing stick, no fingerprint reader	641208-001

Before removing the bottom cover, follow these steps:

1. Shut down the computer. If you are unsure whether the computer is off or in Hibernation, turn the computer on, and then shut it down through the operating system.
2. Disconnect all external devices connected to the computer.
3. Disconnect the power from the computer by first unplugging the power cord from the AC outlet, and then unplugging the AC adapter from the computer.
4. Remove the battery (see [Battery on page 58](#)).
5. Remove the following components:
  - a. Bottom door (see [Bottom door on page 64](#)).
  - b. Hard drive (see [Hard drive on page 69](#))
  - c. Optical drive (see [Optical drive on page 65](#))
  - d. WLAN module (see [WLAN module on page 76](#))
  - e. WWAN module (see [WWAN module on page 74](#))
  - f. Fan (see [Fan on page 85](#))
  - g. Heat sink (see [Heat sink on page 86](#))
  - h. Keyboard (see [Keyboard on page 92](#))

Remove the bottom cover:

1. Position the computer upside-down with the front toward you.

2. Remove the following covers and screws that secure the bottom cover to the computer:

- (1) 2 small rubber screw covers

- (2) 1 large rubber screw cover

- (3) 6 Torx PM2.5×6.0 screws

- (4) 4 Phillips PM2.5×3.0 screws from the battery bay

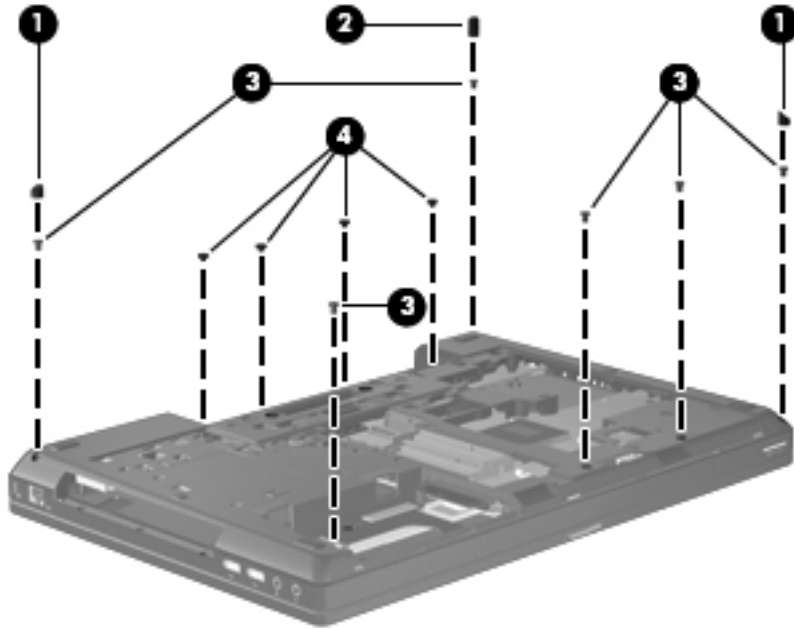

3. Remove the following screws that secure the bottom cover to the computer:

- (1): 2 Phillips PM2.0×4.0 screws from the hard drive bay

- (2): 3 Phillips PM2.0×3.0 screws from the optical drive bay

- (3): 2 Torx PM2.5×10.0 screws near the docking connector



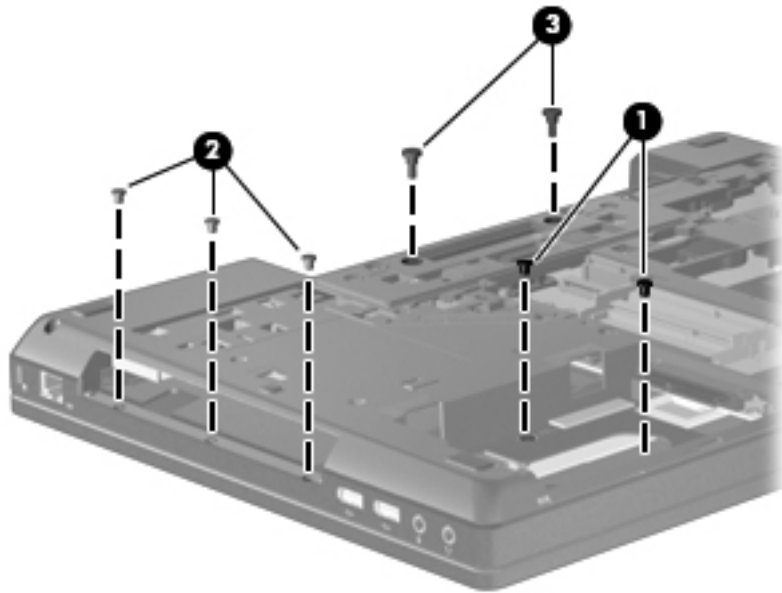

4. Remove the 4 Torx PM2.5×6.0 screws from the rear of the computer.

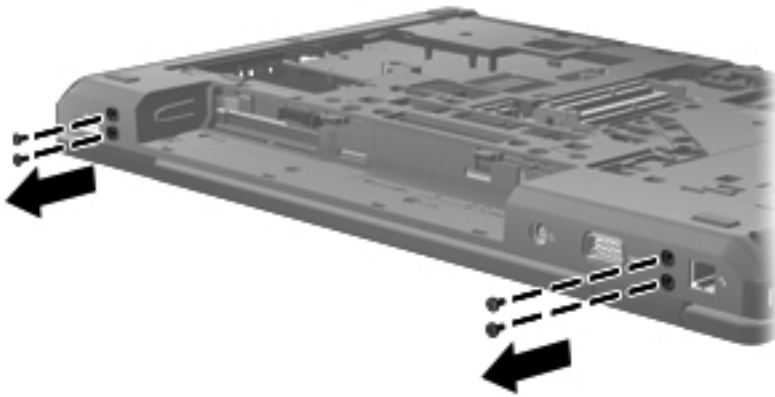

5. Remove the wireless cables from their routing path on the bottom cover (1), and disconnect the speaker cable from the system board (2).

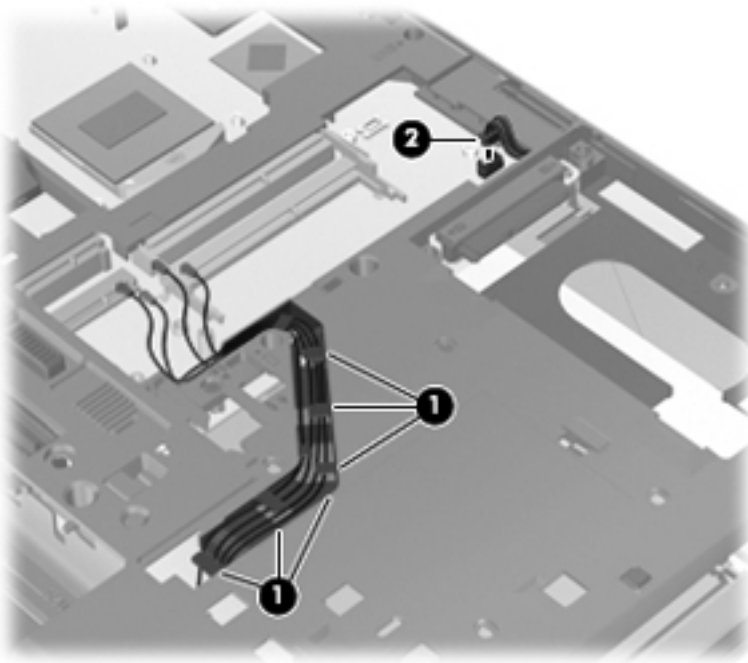

6. Press the tab in the battery bay (1) to disengage the bottom cover.
7. Remove the bottom cover from the computer (2).

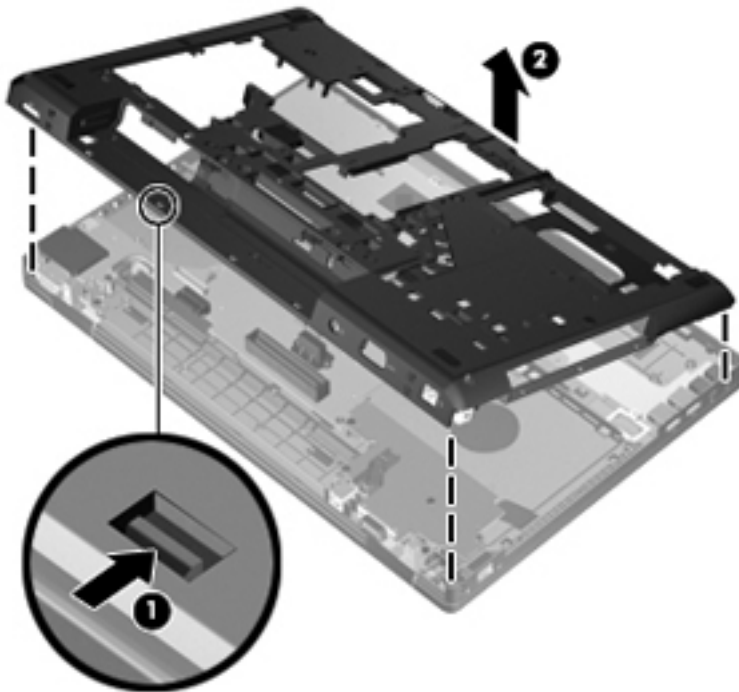

Reverse this procedure to install the bottom cover.



**NOTE:** When replacing the bottom cover, make sure to remove the modem plug from the slot in the bottom cover if the repaired unit includes a modem.

## Speaker assembly

Description	Spare part number
Speaker assembly	641186-001

Before removing the speaker assembly, follow these steps:

1. Shut down the computer. If you are unsure whether the computer is off or in Hibernation, turn the computer on, and then shut it down through the operating system.
2. Disconnect all external devices connected to the computer.
3. Disconnect the power from the computer by first unplugging the power cord from the AC outlet, and then unplugging the AC adapter from the computer.
4. Remove the battery (see [Battery on page 58](#)).
5. Remove the following components:
  - a. Bottom door (see [Bottom door on page 64](#)).
  - b. Hard drive (see [Hard drive on page 69](#))
  - c. Optical drive (see [Optical drive on page 65](#))
  - d. WLAN module (see [WLAN module on page 76](#))
  - e. WWAN module (see [WWAN module on page 74](#))
  - f. Fan (see [Fan on page 85](#))
  - g. Heat sink (see [Heat sink on page 86](#))
  - h. Keyboard (see [Keyboard on page 92](#))
  - i. Bottom cover (see [Bottom cover on page 94](#))

Remove the speaker assembly:

1. Position the bottom cover with the front toward you.
2. Remove the two Phillips PM2.0×3.0 screws (1) that secure the speaker assembly to the bottom cover.

3. Remove the speaker assembly (2) from the bottom cover.

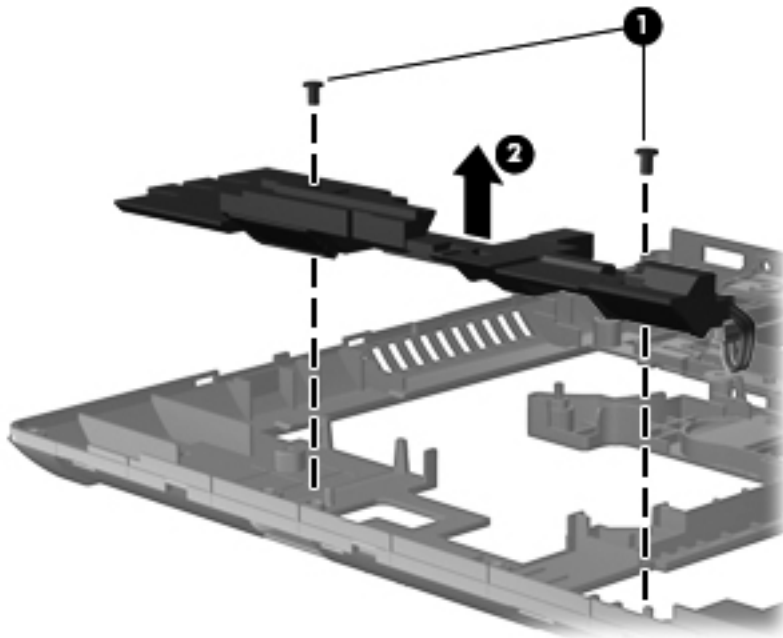

Reverse this procedure to install the speaker assembly.

## RJ-11 jack cable

 **NOTE:** The RJ-11 jack cable is included in the Cable Kit, spare part number 646968-001 for use in 6560b models, 641188-001 for use in 8560p models.

---

Before removing the RJ-11 jack cable, follow these steps:

1. Shut down the computer. If you are unsure whether the computer is off or in Hibernation, turn the computer on, and then shut it down through the operating system.
2. Disconnect all external devices connected to the computer.
3. Disconnect the power from the computer by first unplugging the power cord from the AC outlet, and then unplugging the AC adapter from the computer.
4. Remove the battery (see [Battery on page 58](#)).
5. Remove the following components:
  - a. Bottom door (see [Bottom door on page 64](#)).
  - b. Hard drive (see [Hard drive on page 69](#))
  - c. Optical drive (see [Optical drive on page 65](#))
  - d. WLAN module (see [WLAN module on page 76](#))
  - e. WWAN module (see [WWAN module on page 74](#))
  - f. Modem module (see [Modem module on page 83](#))
  - g. Fan (see [Fan on page 85](#))
  - h. Heat sink (see [Heat sink on page 86](#))
  - i. Keyboard (see [Keyboard on page 92](#))
  - j. Bottom cover (see [Bottom cover on page 94](#))

Remove the RJ-11 jack cable:

1. Position the bottom cover with the front toward you.
2. Remove the RJ-11 jack **(1)** from the clip built into the bottom cover.

3. Remove the RJ-11 jack cable from the clips and routing channel **(2)** built into the bottom cover.

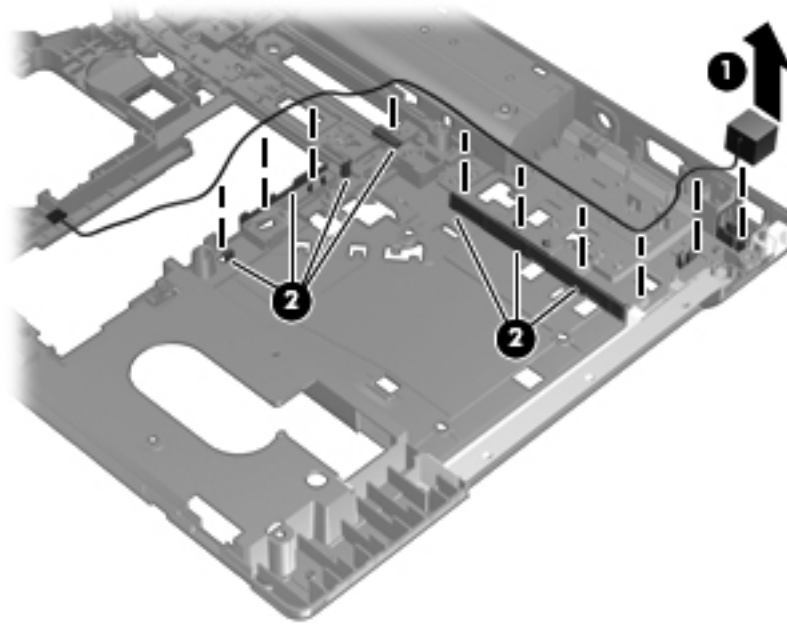

4. Remove the RJ-11 jack cable from the bottom cover.

Reverse this procedure to install the RJ-11 jack cable.

## Function board

Description	Spare part number
Function board	641187-001

Before removing the function board, follow these steps:

1. Shut down the computer. If you are unsure whether the computer is off or in Hibernation, turn the computer on, and then shut it down through the operating system.
2. Disconnect all external devices connected to the computer.
3. Disconnect the power from the computer by first unplugging the power cord from the AC outlet, and then unplugging the AC adapter from the computer.
4. Remove the battery (see [Battery on page 58](#)).
5. Remove the following components:
  - a. Bottom door (see [Bottom door on page 64](#)).
  - b. Hard drive (see [Hard drive on page 69](#))
  - c. Optical drive (see [Optical drive on page 65](#))
  - d. WLAN module (see [WLAN module on page 76](#))
  - e. WWAN module (see [WWAN module on page 74](#))
  - f. Fan (see [Fan on page 85](#))
  - g. Heat sink (see [Heat sink on page 86](#))
  - h. Keyboard (see [Keyboard on page 92](#))
  - i. Bottom cover (see [Bottom cover on page 94](#))

Remove the function board:

1. Position the computer upside-down with the front toward you.
2. Remove the wireless cable from atop the board **(1)**.

3. Remove the three Phillips PM2.5×5.0 screws (2) that secure the board to the computer, and then slide the board away from the side and lift it out of the computer (3).

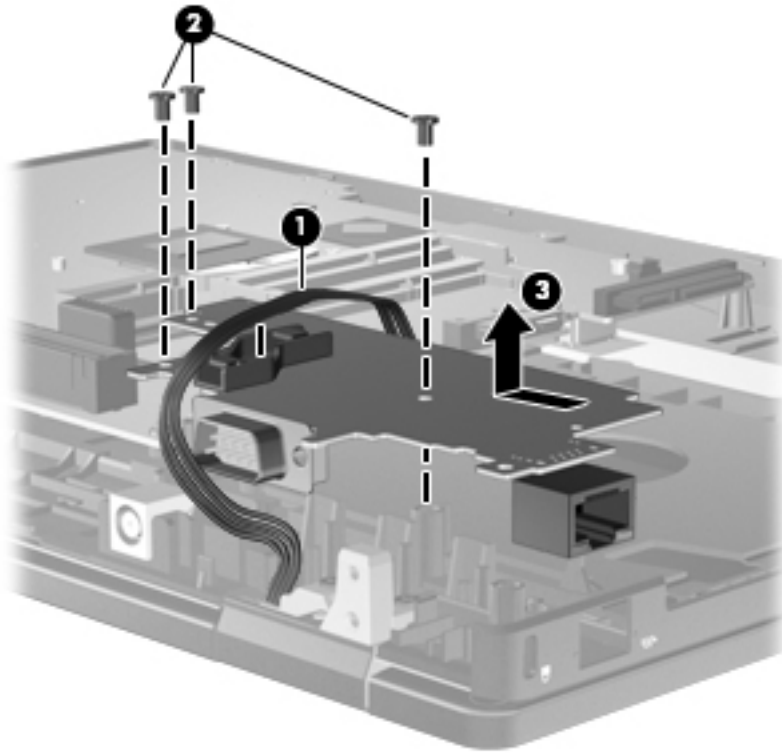

Reverse this procedure to install the function board.



## USB board

Description	Spare part number
USB 2.0 board for use only in 6560b models (includes Mylar)	641184-001
USB 3.0 board for use only in 8560p models (includes Mylar)	641185-001

Before removing the USB board, follow these steps:

1. Shut down the computer. If you are unsure whether the computer is off or in Hibernation, turn the computer on, and then shut it down through the operating system.
2. Disconnect all external devices connected to the computer.
3. Disconnect the power from the computer by first unplugging the power cord from the AC outlet, and then unplugging the AC adapter from the computer.
4. Remove the battery (see [Battery on page 58](#)).
5. Remove the following components:
  - a. Bottom door (see [Bottom door on page 64](#)).
  - b. Hard drive (see [Hard drive on page 69](#))
  - c. Optical drive (see [Optical drive on page 65](#))
  - d. WLAN module (see [WLAN module on page 76](#))
  - e. WWAN module (see [WWAN module on page 74](#))
  - f. Fan (see [Fan on page 85](#))
  - g. Heat sink (see [Heat sink on page 86](#))
  - h. Keyboard (see [Keyboard on page 92](#))
  - i. Bottom cover (see [Bottom cover on page 94](#))

Remove the USB board:

1. Position the computer upside-down with the front toward you.

2. Lift the board straight up out of the computer.

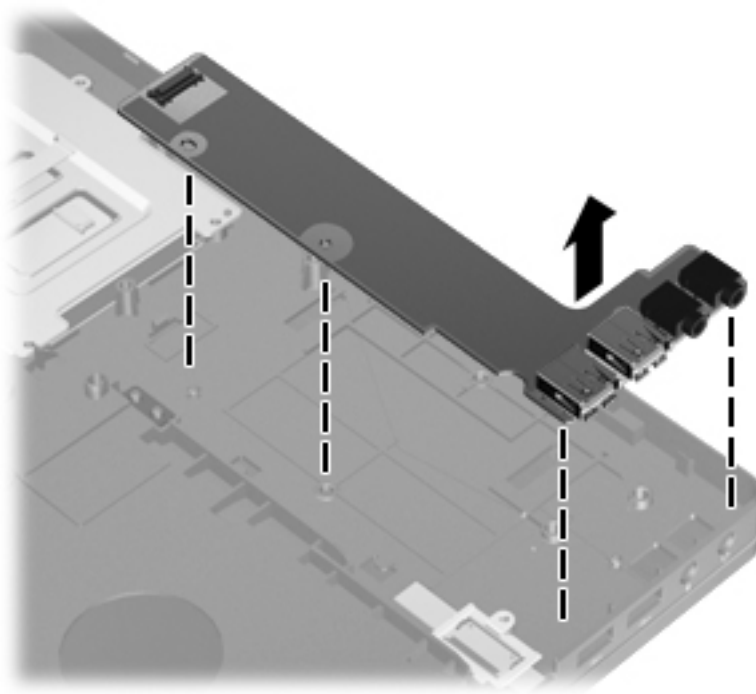

Reverse this procedure to install the USB board.

## System board



**NOTE:** All system board spare part kits include replacement thermal material.

Description	Spare part number
<b>System board for use in HP ProBook 6560b computers with discrete graphics:</b>	
HM65 with WWAN	
<ul style="list-style-type: none"> <li>For use in all countries and regions except for Russia and the People's Republic of China</li> </ul>	646963-001
<ul style="list-style-type: none"> <li>For use in Russia and the People's Republic of China</li> </ul>	653785-001
QM67 with WWAN	
<ul style="list-style-type: none"> <li>For use in all countries and regions except for Russia and the People's Republic of China</li> </ul>	646965-001
<ul style="list-style-type: none"> <li>For use in Russia and the People's Republic of China</li> </ul>	653787-001
<b>For use in HP ProBook 6560b computers with UMA graphics:</b>	
HM65 with WWAN	
<ul style="list-style-type: none"> <li>For use in all countries and regions except for Russia and the People's Republic of China</li> </ul>	646962-001
<ul style="list-style-type: none"> <li>For use in Russia and the People's Republic of China</li> </ul>	653784-001
HM65 without WWAN	
<ul style="list-style-type: none"> <li>For use in all countries and regions except for Russia and the People's Republic of China</li> </ul>	654129-001
<ul style="list-style-type: none"> <li>For use in Russia and the People's Republic of China</li> </ul>	654305-001

Description	Spare part number
QM67 with WWAN	
<ul style="list-style-type: none"> <li>For use in all countries and regions except for Russia and the People's Republic of China</li> </ul>	646964-001
<ul style="list-style-type: none"> <li>For use in Russia and the People's Republic of China</li> </ul>	653786-001
<b>System board for use in HP EliteBook 8560p computers:</b>	
Discrete graphics, QM67	
<ul style="list-style-type: none"> <li>For use in all countries and regions except for Russia and the People's Republic of China</li> </ul>	646967-001
<ul style="list-style-type: none"> <li>For use in Russia and the People's Republic of China</li> </ul>	653789-001
UMA graphics, QM67	
<ul style="list-style-type: none"> <li>For use in all countries and regions except for Russia and the People's Republic of China</li> </ul>	646966-001
<ul style="list-style-type: none"> <li>For use in Russia and the People's Republic of China</li> </ul>	653788-001

Before removing the system board, follow these steps:

1. Shut down the computer. If you are unsure whether the computer is off or in Hibernation, turn the computer on, and then shut it down through the operating system.
2. Disconnect all external devices connected to the computer.
3. Disconnect the power from the computer by first unplugging the power cord from the AC outlet, and then unplugging the AC adapter from the computer.
4. Remove the battery (see [Battery on page 58](#)).
5. Remove the following components:
  - a. Bottom door (see [Bottom door on page 64](#)).
  - b. Hard drive (see [Hard drive on page 69](#))
  - c. Optical drive (see [Optical drive on page 65](#))
  - d. Modem module (see [Modem module on page 83](#))
  - e. Fan (see [Fan on page 85](#))
  - f. Heat sink (see [Heat sink on page 86](#))
  - g. Keyboard (see [Keyboard on page 92](#))
  - h. Bottom cover (see [Bottom cover on page 94](#))

When replacing the system board, be sure that the following components are removed from the defective system board and installed on the replacement system board:

- SIM (see [SIM on page 63](#))
- Memory module (see [Memory modules on page 72](#))
- WLAN module (see [WLAN module on page 76](#))
- WWAN module (see [WWAN module on page 74](#))

- Modem module (see [Modem module on page 83](#))
- Processor (see [Processor on page 90](#))

Remove the system board:

1. Position the computer right-side up, with the front toward you.
2. Lift the Touchpad connector latch **(1)** and disconnect the Touchpad cable **(2)**.
3. Lift the fingerprint reader connector latch **(3)** and disconnect the fingerprint reader cable **(4)**.
4. Disconnect the power connector cable **(5)**.

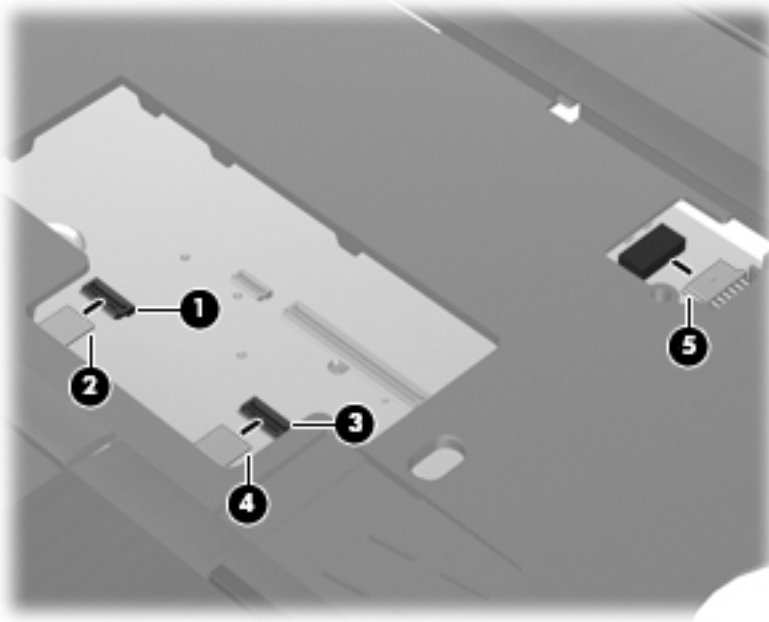

5. Remove the display cable from the rubber routing path mounted on the computer **(1)**.

6. Disconnect the display cable from the system board (2).

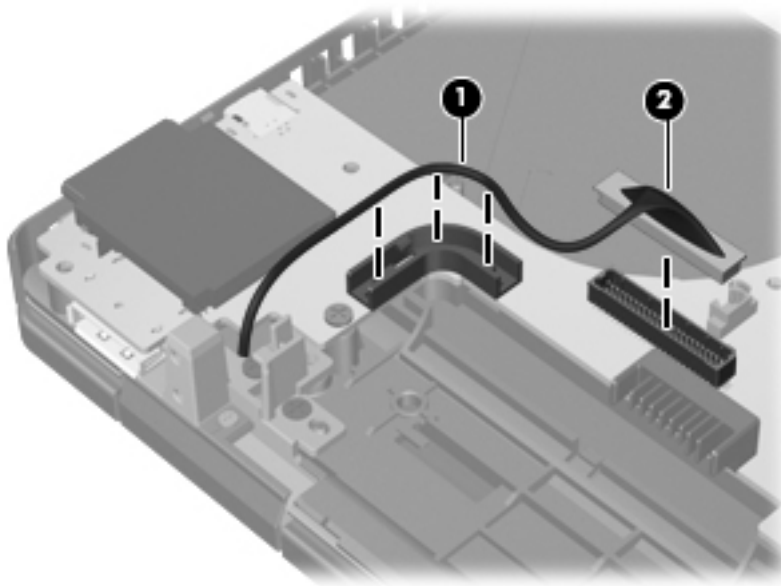

7. Remove the four Phillips PM2.5×5.0 screws that secure the system board to the bottom cover.

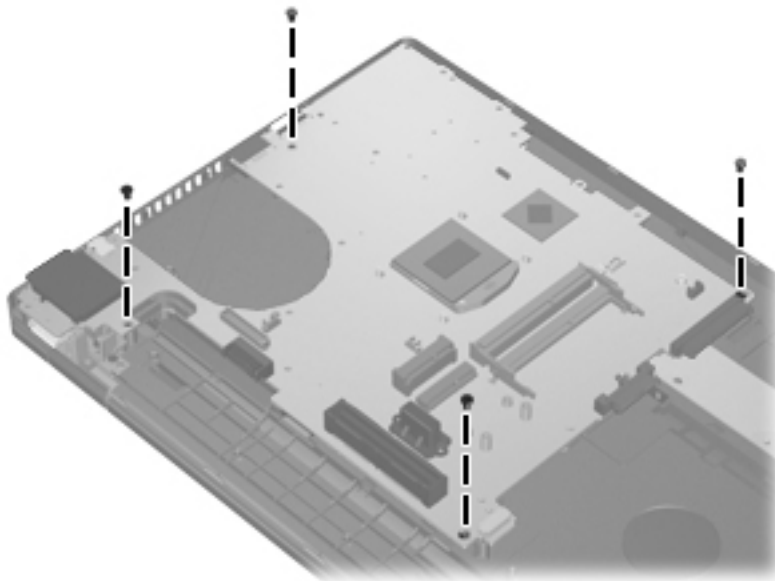

8. Lift the system board up at an angle (1), and then lift the system board up and out of the computer (2).

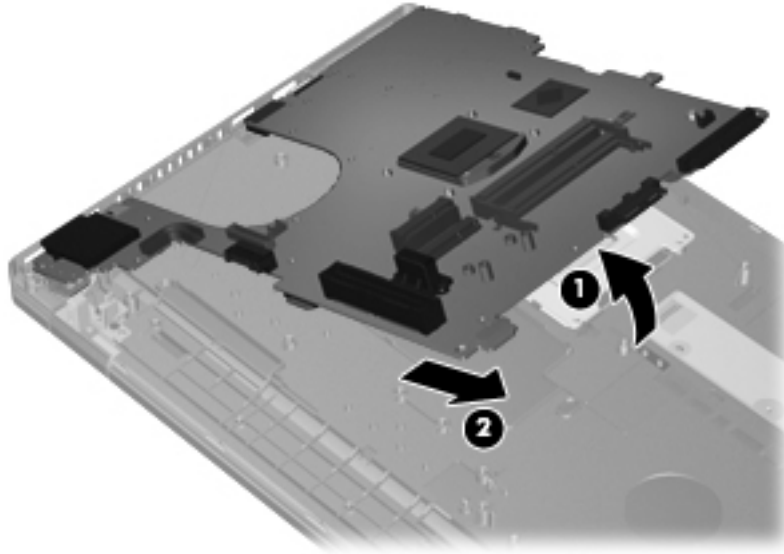

9. Remove the system board from the chassis.  
Reverse this procedure to install the system board.

## Display assembly and components (whole hinge-up, cable, antennas, hinges, enclosure)

 **NOTE:** This section describes removing components that require you to completely remove the display panel. For more information about removing display components that do not require that you remove the assembly from the computer, see [Display assembly \(panel, bezel, webcam, microphone\) on page 59](#).

All display assemblies include WLAN antenna transceivers and cables. WWAN models include 2 WWAN antenna transceivers and cables.

For a complete list of individual display spare parts, see [Display components on page 34](#).

Description	Spare part number
<b>Display bezel</b>	
For use with HP ProBook 6560b models with a webcam (bezel includes double-sided tape)	641196-001
For use with HP ProBook 6560b models without a webcam (bezel includes double-sided tape)	641197-001
For use with HP EliteBook 8560p models with a webcam	641198-001
For use with HP EliteBook 8560p models without a webcam	641199-001
<b>Display hinges</b> (includes left and right hinges, brackets, and covers)	
For use with HP ProBook 6560b models	647677-001
For use with HP EliteBook 8560p models	641193-001
<b>Display Cable Kit</b>	
For use in HP ProBook 6560b models with HD displays	646969-001
For use in HP ProBook 6560b models with HD+ displays	646970-001
For use in HP EliteBook 8560p models with HD displays	641194-001
For use in HP EliteBook 8560p models with HD+ displays	641195-001
<b>WLAN antennas</b>	
Included in Cable Kit, for use in HP ProBook 6560b models	646968-001
Included in Display Panel Support Kit, for use in HP ProBook 6560b models	657831-001
Included in Cable Kit, for use in HP EliteBook 8560p models	641188-001
Included in Display Panel Support Kit, for use in HP ProBook 8560p models	657829-001
<b>WWAN antennas</b>	
Included in Cable Kit, for use in HP ProBook 6560b models	646968-001
Included in Display Panel Support Kit, for use in HP ProBook 6560b models	657831-001
Included in Cable Kit, for use in HP EliteBook 8560p models	641188-001
Included in Display Panel Support Kit, for use in HP ProBook 8560p models	657829-001
<b>Display enclosure</b>	
For use in HP ProBook 6560b models	641202-001
Included in Display Panel Support Kit, for use in HP ProBook 6560b models	657831-001

Description	Spare part number
For use in HP EliteBook 8560p models	641201-001
Included in Display Panel Support Kit, for use in HP ProBook 8560p models	657829-001
<b>Display Panel Support Kit</b> (includes WLAN antennas, WWAN antennas, and display enclosure)	
For use in HP ProBook 6560b models	657831-001
For use in HP EliteBook 8560p models	657829-001

For a list of display spare parts, see [Display components on page 34](#).

Before removing the display assembly, follow these steps:

1. Shut down the computer. If you are unsure whether the computer is off or in Hibernation, turn the computer on, and then shut it down through the operating system.
2. Disconnect all external devices connected to the computer.
3. Disconnect the power from the computer by first unplugging the power cord from the AC outlet, and then unplugging the AC adapter from the computer.
4. Remove the battery (see [Battery on page 58](#)).
5. Remove the following components:
  - a. Bottom door (see [Bottom door on page 64](#)).
  - b. Hard drive (see [Hard drive on page 69](#))
  - c. Optical drive (see [Optical drive on page 65](#))
  - d. WLAN module (see [WLAN module on page 76](#))
  - e. WWAN module (see [WWAN module on page 74](#))
  - f. Fan (see [Fan on page 85](#))
  - g. Heat sink (see [Heat sink on page 86](#))
  - h. Modem module (see [Modem module on page 83](#))
  - i. Keyboard (see [Keyboard on page 92](#))
  - j. Bottom cover (see [Bottom cover on page 94](#))
  - k. System board (see [System board on page 106](#))

Remove the display assembly:

1. Position the computer right-side up with the front toward you.
2. Open the computer as far as possible.
3. Remove the four Phillips PM2.5×4.5 screws (1) that secure the display to the computer.



4. For reassembly, note the routing path of the wireless antennas (2) and the display cable (3).

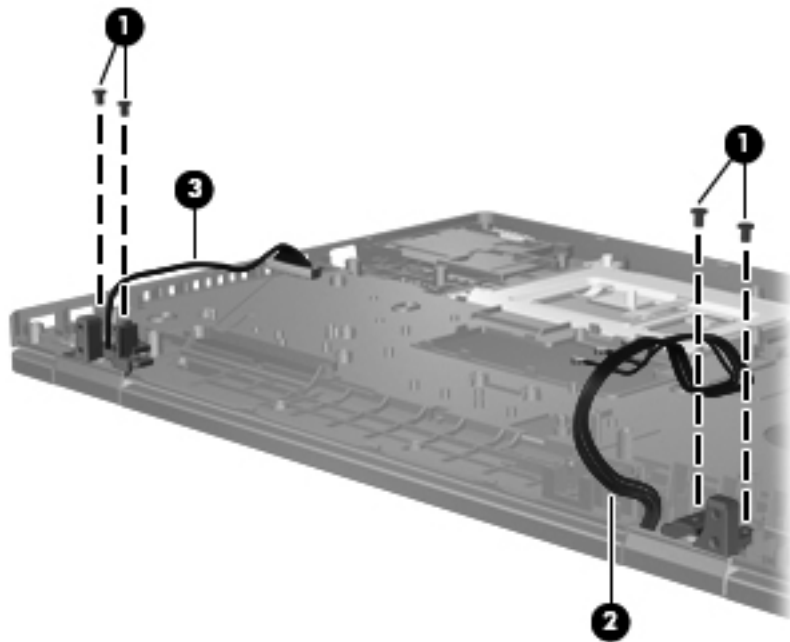

5. Lift the display assembly straight up and remove it.

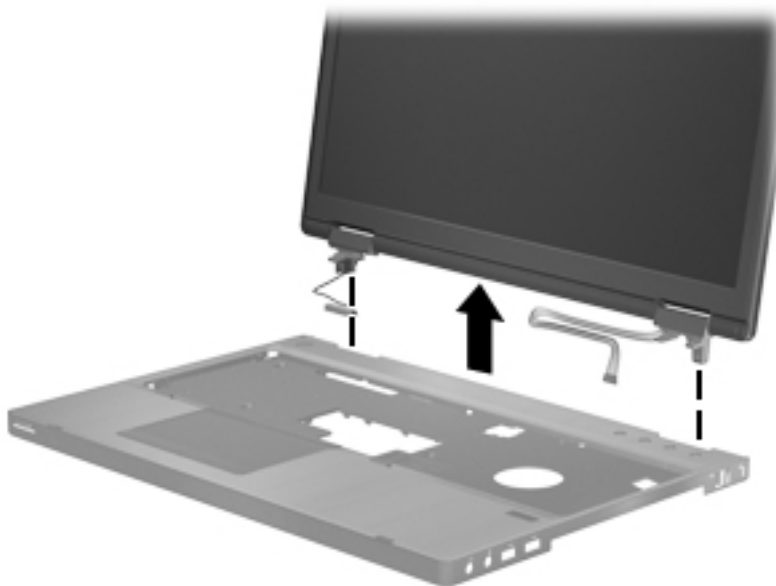

**⚠ CAUTION:** When installing the display assembly, be sure that the wireless antenna cables are routed and arranged properly.

Failure to properly route the antennas can result in degradation of the computer's WLAN and WWAN performance.

6. To replace the display bezel, remove the two rubber screw covers (1) and the two Phillips PM2.5×5.0 screws (2) in the bottom corners of the display bezel.

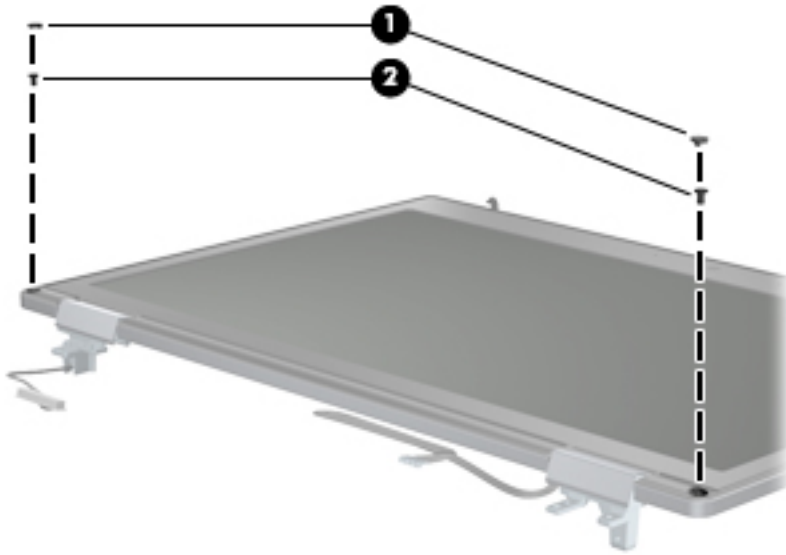

7. Flex the top (1) of the bezel, the inside edges of the left and right sides (2), and then the bottom (3) of the bezel until it disengages from the display enclosure.
8. Remove the display bezel (4).

Display bezels are available using the following spare part numbers:

641196-001 for use in HP ProBook 6560b models with a webcam (bezel includes double-sided tape)

641197-001 for use in HP ProBook 6560b models without a webcam (bezel includes double-sided tape)

641198-001 for use in HP EliteBook 8560p models with a webcam

641199-001 for use in HP EliteBook 8560p models without a webcam

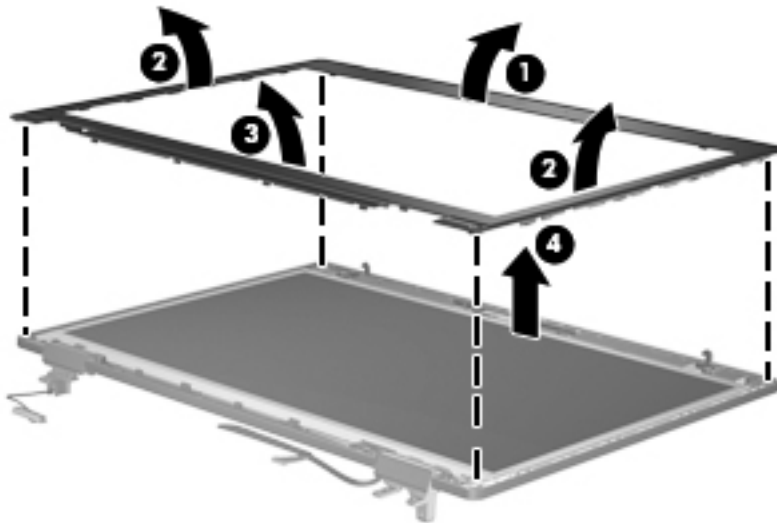

9. To remove the display panel, remove the eight Phillips PM2.5×4.0 screws (1) that secure the display panel to the brackets.
10. Rotate the top of the panel upward (2).
11. Lift the display panel as far as the display panel cable allows (3).

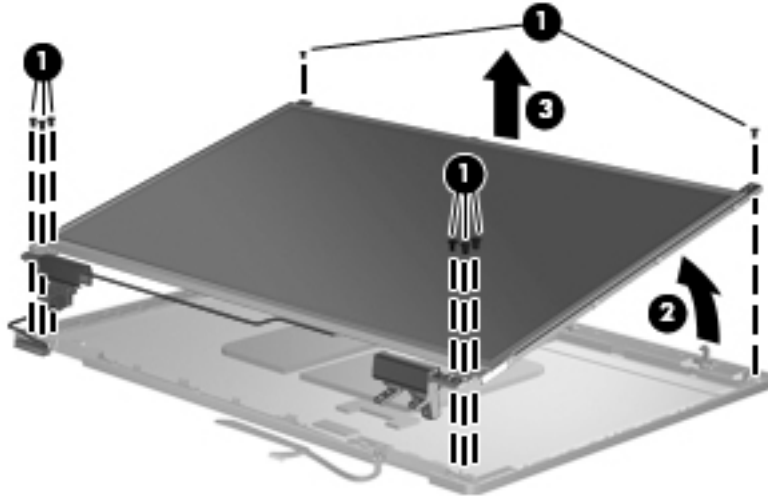

12. Disconnect the display panel cable from the back of the display panel by lifting the tape over the connector (1), and then disconnecting the cable from the panel (2).

The display cable is available using spare part numbers:

646969-001: HP ProBook 6560b HD models

646970-001: HP ProBook 6560b HD+ models

641194-001: HP ProBook 8560p HD models

641195-001: HP ProBook 8560p HD+ models

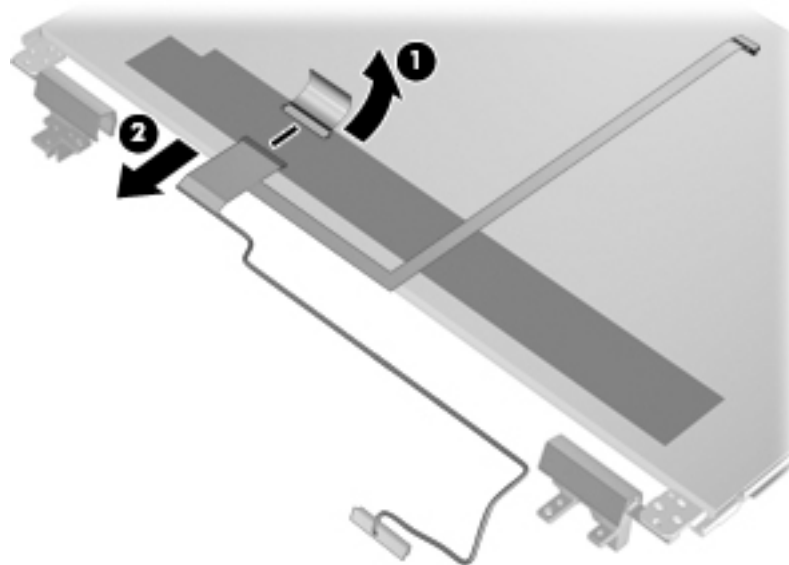

13. If it is necessary to replace the display hinges, remove the eight Phillips PM2.5×3.0 screws (1) that secure each display hinge to the display panel.
14. Remove the display hinges (2).

Display hinges are available using spare part number 647677-001 for HP ProBook 6560b models and 641193-001 for HP EliteBook 8560p models.

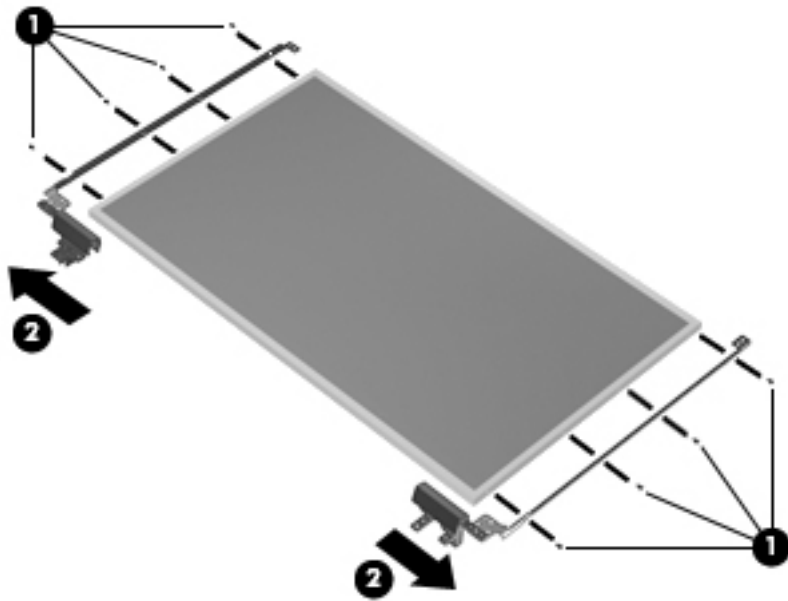

15. If you need to remove the hinge covers from the display hinges, remove the screws that secure the hinge covers (1), and then pull the hinges toward one another (2) to remove them.

Display hinge covers are available in the Display Hinge Kit, spare part number 647677-001 for HP ProBook 6560b models and 641193-001 for HP EliteBook 8560p models.

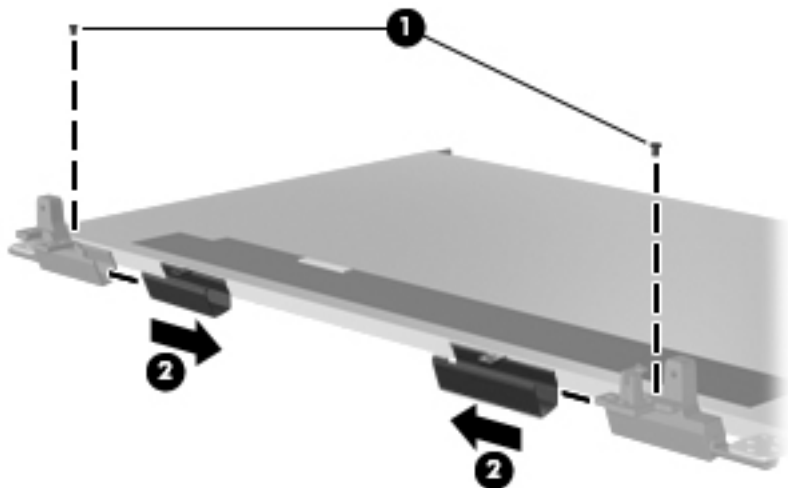

16. If you need to remove the WLAN antennas, remove the antenna cables from the clips (1) and routing paths built into the display enclosure.

17. Lift the antennas (2) and cables (3) straight up out of the display enclosure.

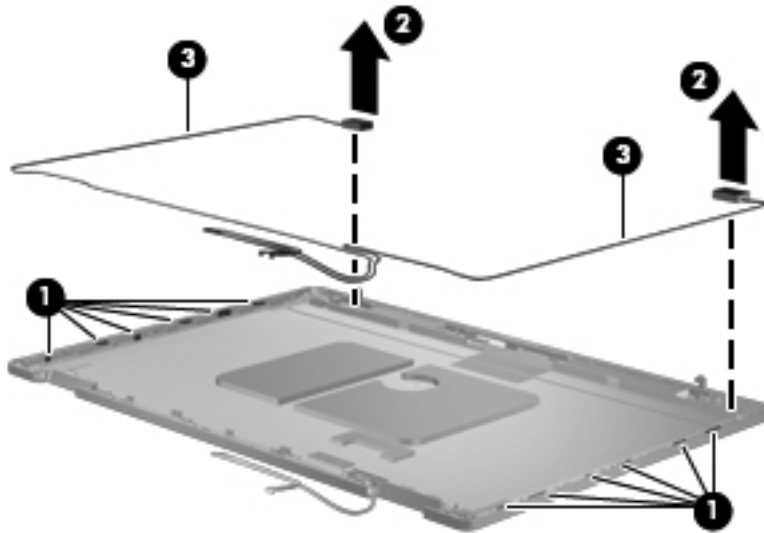

**CAUTION:** When installing the display assembly, be sure that the wireless antenna cables are routed and arranged properly.

Failure to properly route the antennas can result in degradation of the computer's WLAN performance.

18. If you need to remove the WWAN antennas, remove the antenna cables from the clips (1) and routing paths built into the display enclosure.
19. Lift the antennas (2) and cables (3) straight up out of the display enclosure.

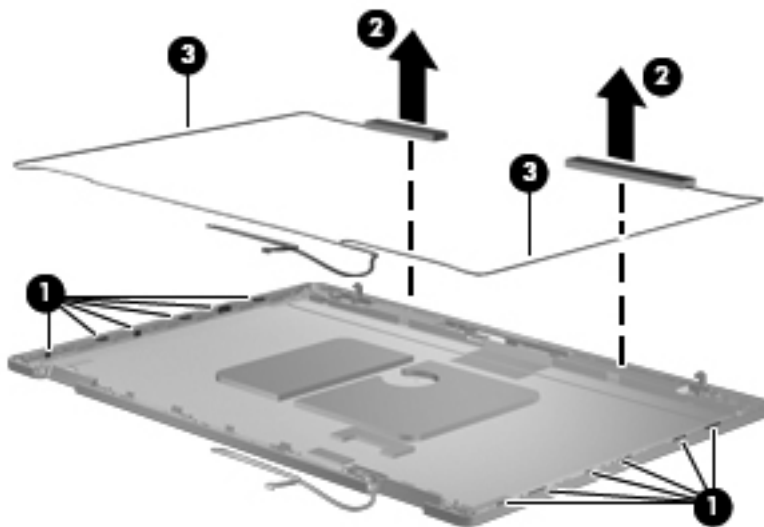

**CAUTION:** When installing the display assembly, be sure that the wireless antenna cables are routed and arranged properly.

Failure to properly route the antennas can result in degradation of the computer's WWAN performance.

Reverse this procedure to reassemble and install the display assembly.

When replacing the display panel, use the following image to determine the correct locations to insert the hinges into the display enclosure.

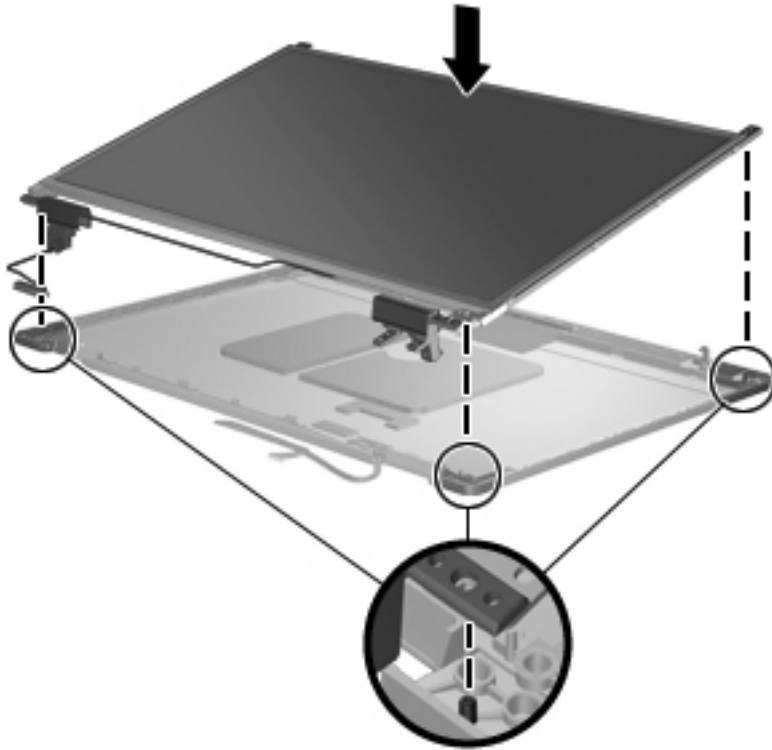

Use the following image as a reference for display cable and antenna installation:

- (1) Wireless antennas
- (2) Wireless antennas
- (3) Display cable
- (4) Webcam cable

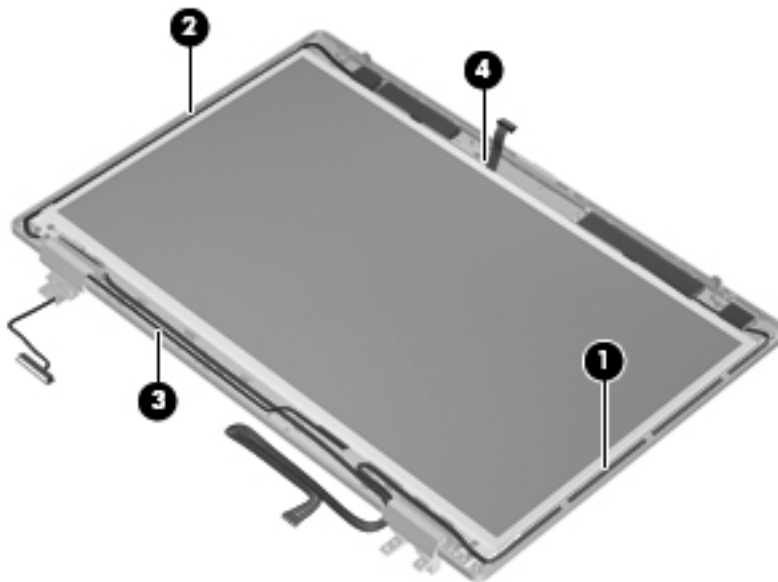

On model 6560b, 10 pieces of double-sided tape are mounted on the inside of the bezel. Note tape locations according to the following image.

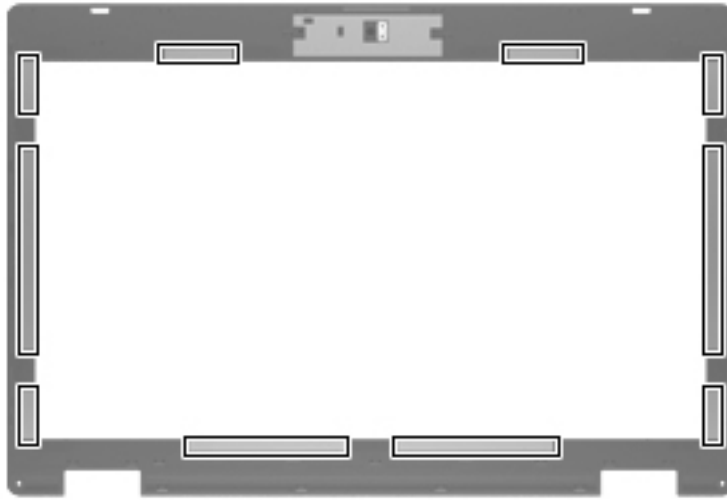

---

# 5 Computer Setup (BIOS) and System Diagnostics

## Using Computer Setup

Computer Setup, or Basic Input/Output System (BIOS), controls communication between all the input and output devices on the system (such as disk drives, display, keyboard, mouse, and printer). Computer Setup includes settings for the types of devices installed, the startup sequence of the computer, and the amount of system and extended memory.

---

 **NOTE:** Use extreme care when making changes in Computer Setup. Errors can prevent the computer from operating properly.

---

## Starting Computer Setup

---

 **NOTE:** An external keyboard or mouse connected to a USB port can be used with Computer Setup only if USB legacy support is enabled.

---

To start Computer Setup, follow these steps:

1. Turn on or restart the computer, and then press **esc** while the “Press the ESC key for Startup Menu” message is displayed at the bottom of the screen.
2. Press **f10** to enter Computer Setup.

## Navigating and selecting in Computer Setup

To navigate and select in Computer Setup, follow these steps:

1. Turn on or restart the computer, and then press **esc** while the “Press the ESC key for Startup Menu” message is displayed at the bottom of the screen.
  - To select a menu or a menu item, use the tab key and the keyboard arrow keys and then press **enter**, or use a pointing device to click the item.
  - To scroll up and down, click the up arrow or the down arrow in the upper-right corner of the screen, or use the up arrow key or the down arrow key.
  - To close open dialog boxes and return to the main Computer Setup screen, press **esc**, and then follow the on-screen instructions.

---

 **NOTE:** You can use either a pointing device (TouchPad, pointing stick, or USB mouse) or the keyboard to navigate and make selections in Computer Setup.

---

2. Press **f10** to enter Computer Setup.



To exit Computer Setup menus, choose one of the following methods:

- To exit Computer Setup menus without saving your changes:

Click the **Exit** icon in the lower-left corner of the screen, and then follow the on-screen instructions.

– or –

Use the tab key and the arrow keys to select **File > Ignore Changes and Exit**, and then press [enter](#).

- To save your changes and exit Computer Setup menus:

Click the **Save** icon in the lower-left corner of the screen, and then follow the on-screen instructions.

– or –

Use the tab key and the arrow keys to select **File > Save Changes and Exit**, and then press [enter](#).

Your changes go into effect when the computer restarts.

## Restoring factory settings in Computer Setup



---

**NOTE:** Restoring defaults will not change the hard drive mode.

---

To return all settings in Computer Setup to the values that were set at the factory, follow these steps:

1. Turn on or restart the computer, and then press [esc](#) while the “Press the ESC key for Startup Menu” message is displayed at the bottom of the screen.
2. Press [f10](#) to enter Computer Setup.
3. Use a pointing device or the arrow keys to select **File > Restore Defaults**.
4. Follow the on-screen instructions.
5. To save your changes and exit, click the **Save** icon in the lower-left corner of the screen, and then follow the on-screen instructions.

– or –

Use the arrow keys to select **File > Save Changes and Exit**, and then press [enter](#).

Your changes go into effect when the computer restarts.



---

**NOTE:** Your password settings and security settings are not changed when you restore the factory settings.

---

## Updating the BIOS

Updated versions of the BIOS may be available on the HP Web site.

Most BIOS updates on the HP Web site are packaged in compressed files called *SoftPaqs*.

Some download packages contain a file named *Readme.txt*, which contains information regarding installing and troubleshooting the file.

### Determining the BIOS version

To determine whether available BIOS updates contain later BIOS versions than those currently installed on the computer, you need to know the version of the system BIOS currently installed.

BIOS version information (also known as *ROM date* and *System BIOS*) can be displayed by pressing **fn+esc** (if you are already in Windows) or by using Computer Setup.

1. Start Computer Setup.
2. Use a pointing device or the arrow keys to select **File > System Information**.
3. To exit Computer Setup without saving your changes, click the **Exit** icon in the lower-left corner of the screen, and then follow the on-screen instructions.

– or –

Use the tab key and the arrow keys to select **File > Ignore Changes and Exit**, and then press **enter**.

### Downloading a BIOS update

 **CAUTION:** To reduce the risk of damage to the computer or an unsuccessful installation, download and install a BIOS update only when the computer is connected to reliable external power using the AC adapter. Do not download or install a BIOS update while the computer is running on battery power, docked in an optional docking device, or connected to an optional power source. During the download and installation, follow these instructions:

Do not disconnect power from the computer by unplugging the power cord from the AC outlet.

Do not shut down the computer or initiate Sleep or Hibernation.

Do not insert, remove, connect, or disconnect any device, cable, or cord.

1. Select **Start > Help and Support > Maintain**.
2. Follow the on-screen instructions to identify your computer and access the BIOS update you want to download.
3. At the download area, follow these steps:
  - a. Identify the BIOS update that is later than the BIOS version currently installed on your computer. Make a note of the date, name, or other identifier. You may need this information to locate the update later, after it has been downloaded to your hard drive.
  - b. Follow the on-screen instructions to download your selection to the hard drive.

Make a note of the path to the location on your hard drive where the BIOS update is downloaded. You will need to access this path when you are ready to install the update.

---

 **NOTE:** If you connect your computer to a network, consult the network administrator before installing any software updates, especially system BIOS updates.

---

BIOS installation procedures vary. Follow any instructions that are displayed on the screen after the download is complete. If no instructions are displayed, follow these steps:

1. Open Windows Explorer by selecting **Start > Computer**.
2. Double-click your hard drive designation. The hard drive designation is typically Local Disk (C:).
3. Using the hard drive path you recorded earlier, open the folder on your hard drive that contains the update.
4. Double-click the file that has an .exe extension (for example, *filename.exe*).

The BIOS installation begins.

5. Complete the installation by following the on-screen instructions.

---

 **NOTE:** After a message on the screen reports a successful installation, you can delete the downloaded file from your hard drive.

---

## Using System Diagnostics

System Diagnostics allows you to run diagnostic tests to determine if the computer hardware is functioning properly. The following diagnostic tests are available in System Diagnostics:

- **Start-up test**—This test analyzes the main computer components that are required to start the computer.
- **Run-in test**—This test repeats the start-up test and checks for intermittent problems that the start-up test does not detect.
- **Hard disk test**—This test analyzes the physical condition of the hard drive, and then checks all data in every sector of the hard drive. If the test detects a damaged sector, it attempts to move the data to a good sector.
- **Memory test**—This test analyzes the physical condition of the memory modules. If it reports an error, replace the memory modules immediately.
- **Battery test**—This test analyzes the condition of the battery. If the battery fails the test, contact HP Customer Support to report the issue and purchase a replacement battery.

You can also view system information and error logs in the System Diagnostics window.

To start System Diagnostics:

1. Turn on or restart the computer. While the “Press the ESC key for Startup Menu” message is displayed in the lower-left corner of the screen, press **esc**. When the Startup Menu is displayed, press **f2**.
2. Click the diagnostic test you want to run, and then follow the on-screen instructions.

---

 **NOTE:** If you need to stop a diagnostics test while it is running, press **esc**.

---

# 6 Specifications

## Computer specifications

	Metric	U.S.
<b>Dimensions</b>		
Length	25.2 cm	9.9 in
Width	37.4 cm	14.7 in
Height (front to rear)	3.4 to 3.6 cm	1.35 to 1.43 in
<b>Weight</b> (equipped with UMA graphics, optical drive, 1 SODIMM, hard drive, WLAN module, 3 cell battery)	2.57 kg	5.66 lbs
<b>Input power</b>		
Operating voltage	19.0 V dc @ 4.74 A – 90 W	
Operating current	4.74 A	
<b>Temperature</b>		
Operating (not writing to optical disc)	0°C to 35°C	32°F to 95°F
Operating (writing to optical disc)	5°C to 35°C	41°F to 95°F
Nonoperating	-20°C to 60°C	-4°F to 140°F
<b>Relative humidity</b>		
Operating	10% to 90%	
Nonoperating	5% to 95%	
<b>Maximum altitude</b> (unpressurized)		
Operating (14.7 to 10.1 psia)	-15 m to 3,048 m	50 ft to 10,000 ft
Nonoperating (14.7 to 4.4 psia)	-15 m to 12,192 m	-50 ft to 40,000 ft
<b>Shock</b>		
Operating	125 g, 2 ms, half-sine	
Nonoperating	200 g, 2 ms, half-sine	
<b>Random vibration</b>		
Operating	0.75 g zero-to-peak, 10 Hz to 500 Hz, 0.25 oct/min sweep rate	

	Metric	U.S.
Nonoperating	1.50 g zero-to-peak, 10 Hz to 500 Hz, 0.5 oct/min sweep rate	

**NOTE:** Applicable product safety standards specify thermal limits for plastic surfaces. The computer operates well within this range of temperatures.

## 39.6-cm (15.6-in), HD display specifications

	Metric	U.S.
<b>Dimensions</b>		
Height	21.0 cm	8.25 in
Width	35.9 cm	14.15 in
Diagonal	39.6 cm	15.6 in
<b>Surface treatment</b>	Anti-glare	
<b>Contrast ratio</b>	300:1 (typical)	
<b>Refresh rate</b>	60 Hz	
<b>Brightness</b>	200 nits (typical)	
<b>Pixel resolution</b>		
Pitch	0.252 mm	
Format	1366 × 768	
Configuration	RGB stripe	
<b>Backlight</b>	LED	
<b>PPI</b>	101 ppi	
<b>Viewing angle</b>	+/-30 horizontal (minimum), +/-10° vertical (minimum) 30/30/20/10 (Left/Right/Down/Up) (minimum) or 45/45/35/25 (Left/Right/Down/Up) (typical)	

## 39.6-cm (15.6-in), HD+ display specifications

	<b>Metric</b>	<b>U.S.</b>
<b>Dimensions</b>		
Height	20.9 cm	8.25 in
Width	35.9 cm	14.15 in
Diagonal	39.6 cm	15.6 in
<b>Surface treatment</b>	Anti-glare	
<b>Contrast ratio</b>	300:1 (typical)	
<b>Refresh rate</b>	60 Hz	
<b>Brightness</b>	200 nits (typical)	
<b>Pixel resolution</b>		
Pitch	0.2151 mm	
Format	1600 × 900	
Configuration	RGB stripe	
<b>Backlight</b>	LED	
<b>PPI</b>	118 ppi	
<b>Viewing angle</b>	30/30/20/10 (Left/Right/Down/Up) (minimum) or 45/45/35/25 (Left/Right/Down/Up) (typical)	

## Hard drive specifications

	750-GB*	500-GB*	320-GB*	250-GB*
<b>Dimensions</b>				
Height	9.5 mm	9.5 mm	9.5 mm	9.5 mm
Width	70 mm	70 mm	70 mm	70 mm
Weight	115 g	101 g	101 g	101 g
<b>Interface type</b>	SATA	SATA	SATA	SATA
<b>Transfer rate</b>	100 MB/sec	100 MB/sec	100 MB/sec	100 MB/sec
<b>Security</b>	ATA security	ATA security	ATA security	ATA security
<b>Seek times</b> (typical read, including setting)				
Single track	1.5 ms	3 ms	3 ms	3 ms
Average	11 ms	13 ms	13 ms	13 ms
Maximum	14 ms	24 ms	24 ms	24 ms
<b>Logical blocks</b>	1,465,149,168	1,048,576,000	625,141,400	488,397,168
<b>Disc rotational speed</b>	7200 rpm			
<b>Operating temperature</b>	5°C to 55°C (41°F to 131°F)			
*1 GB = 1 billion bytes when referring to hard drive storage capacity. Actual accessible capacity is less. Actual drive specifications may differ slightly.				
<b>NOTE:</b> Certain restrictions and exclusions apply. Contact technical support for details.				

## Blu-ray BD-R/RE + DVDSM DL Drive

Applicable disc	Read:	Write:	
	CD-DA, CD+(E)G, CD-MIDI, CD-TEXT, CD-ROM, CD-ROM XA, MIXED MODE CD, CD-I, CD-I Bridge (Photo-CD, Video CD), Multisession CD (Photo-CD, CD-EXTRA, Portfolio, CD-R, CD-RW), CD-R, CD-RW, DVD-ROM (DVD-5, DVD-9, DVD-10, DVD-18), DVD-R, DVD-RW, DVD+R, DVD+RW, DVD-RAM, BD-ROM, BD-R, BD-RE	CD-R, CD-RW, DVD+R, DVD+R(9), DVD+RW, DVD-R, DVD-R(9), DVD-RW, DVD-RAM, BD-R, BD-RE	
Access time	CD	DVD	BD-ROM
Random	<180 ms	<180 ms	<230 ms
Maximum Media Capacity (read)	50 GB		
Maximum Media Capacity (write)	8.5 GB		
Data transfer rate			
24X CD-ROM	3,600 KB/sec		
8X DVD	10,800 KB/sec		
2X BD-ROM	9,000 KB/sec		
16X CD-R	3,600 KB/sec		
16X CD-RW	2,400 KB/sec		
8X DVD+R	10,800 KB/sec		
6X DVD+RW	8,100 KB/sec		
8X DVD-R	10,800 KB/sec		
6X DVD-RW	8,100 KB/sec		
4X DVD+R Dual Layer	5,400 KB/sec		
4X DVD-R Dual Layer	5,400 KB/sec		
5X DVD-RAM	6,750 KB/sec		
2X BD-R	9,000 KB/sec		
2X BD-RE	9,000 KB/sec		



# DVD±RW and CD-RW SuperMulti DL Combo Drive specifications

<b>Applicable disc</b>	<b>Read:</b> CD-DA, CD+(E)G, CD-MIDI, CD-TEXT, CD-ROM, CD-ROM XA, MIXED MODE CD, CD-I, CD-I Bridge (Photo-CD, Video CD), Multisession CD (Photo-CD, CD-EXTRA, Portfolio, CD-R, CD-RW), CD-R, CD-RW, DVD-ROM (DVD-5, DVD-9, DVD-10, DVD-18), DVD-R, DVD-RW, DVD+R, DVD+RW, DVD-RAM	<b>Write:</b> CD-R and CD-RW DVD+R, DVD+RW, DVD-R, DVD-RW, DVD-RAM
<b>Center hole diameter</b>	1.5 cm (0.59 in)	
<b>Disc diameter</b>		
Standard disc	12 cm (4.72 in)	
Mini disc	8 cm (3.15 in)	
<b>Disc thickness</b>	1.2 mm (0.047 in)	
<b>Track pitch</b>	0.74 μm	
<b>Access time</b>	<b>CD</b>	<b>DVD</b>
Random	< 175 ms	< 230 ms
Full stroke	< 285 ms	< 335 ms
<b>Audio output level</b>	Line-out, 0.7 Vrms	
<b>Cache buffer</b>	2 MB	
<b>Data transfer rate</b>		
24X CD-ROM	3,600 KB/sec	
8X DVD-ROM	10,800 KB/sec	
24X CD-R	3,600 KB/sec	
16X CD-RW	2,400 KB/sec	
8X DVD+R	10,800 KB/sec	
4X DVD+RW	5,400 KB/sec	
8X DVD-R	10,800 KB/sec	
4X DVD-RW	5,400 KB/sec	
2.4X DVD+R(9)	2,700 KB/sec	
5X DVD-RAM	6,750 KB/sec	
<b>Transfer mode</b>	Multiword DMA Mode	
<b>Startup time</b>	< 15 seconds	
<b>Stop time</b>	< 6 seconds	

## Blu-ray Disc ROM with SuperMulti DVD±R/RW DL Drive

Applicable disc	Read:	Write:		
	CD-DA, CD+(E)G, CD-MIDI, CDTEXT, CD-ROM, CD-ROM XA, MIXED MODE CD, CD-I, CD-I Bridge (Photo-CD, Video CD), Multisession CD (Photo-CD, CD-EXTRA, Portfolio, CD-R, CD-RW), CD-R, CD-RW, DVDROM (DVD-5, DVD-9, DVD-10, DVD-18), DVD-R, DVD-RW, DVD+R, DVD+RW, DVD-RAM, HD-ROM (Single Layer), HD-ROM (Dual Layer), HD DVD-R, HD DVD-R for Dual Layer, HD DVD-RW	CD-R and CD-RW DVD+R, DVD+R(9), DVD+RW, DVD-R, DVD-R(9), DVD-RW, DVD-RAM		
Access time	CD	DVD	HD	
Random	170 ms	170 ms	230 ms	
Cache buffer	8 MB			
Data transfer rate				
24X CD-ROM	3,600 KB/sec			
8X DVD	10,800 KB/sec			
24X CD-R	3,600 KB/sec			
16X CD-RW	2,400 KB/sec			
8X DVD+R	10,800 KB/sec			
4X DVD+RW	5,400 KB/sec			
8X DVD-R	10,800 KB/sec			
4X DVD-RW	5,400 KB/sec			
2.4X DVD+R(9)	2,700 KB/sec			
5X DVD-RAM	6,750 KB/sec			
1X BD-ROM	4,500 KB/sec			
1X BD-R read	4,500 KB/sec			
1X BD-RE read	4,500 KB/sec			
Transfer mode	Multiword DMA Mode			

## DVD-ROM Drive specifications

<b>Applicable disc</b>	DVD-ROM (DVD-5, DVD-9, DVD-10, DVD-18, CD-ROM (Mode 1 and 2), CD Digital Audio, CD-XA ready (Mode 2, Form 1 and Form 2), CD-I (Mode 2, Form 1 and Form 2), CD-R, CD-RW, Photo CD (single and multisession), CD-Bridge	
<b>Center hole diameter</b>	1.5 cm (0.59 in)	
<b>Disc diameter</b>		
Standard disc	12 cm (4.72 in)	
Mini disc	8 cm (3.15 in)	
<b>Disc thickness</b>	1.2 mm (0.047 in)	
<b>Track pitch</b>	0.74 $\mu$ m	
<b>Access time</b>	<b>CD</b>	<b>DVD</b>
Random	< 100 ms	< 125 ms
Full stroke	< 175 ms	< 225 ms
<b>Audio output level</b>	Line-out, 0.7 Vrms	
<b>Cache buffer</b>	512 KB	
<b>Data transfer rate</b>		
CD-R (24X)	3600 KB/s (150 KB/s at 1X CD rate)	
CD-RW (10X)	1500 KB/s (150 KB/s at 1X CD rate)	
CD-ROM (24X)	3600 KB/s (150 KB/s at 1X CD rate)	
DVD (8X)	10,800 KB/s (1,352 KB/s at 1X DVD rate)	
Multiword DMA mode 2	16.6 MB/s	
<b>Startup time</b>	< 10 seconds	
<b>Stop time</b>	< 3 seconds	

## Specification information in Device Manager

Device Manager allows you to view and control the hardware attached to the computer, as well as provides hardware specification information.

You can also add hardware or modify device configurations using Device Manager.



---

**NOTE:** Windows 7 and Windows Vista include the User Account Control feature to improve the security of your computer. You may be prompted for your permission or password for tasks such as installing software, running utilities, or changing Windows settings. Refer to Windows Help and Support for more information.

---

After you open Device Manager, drill-down to a device and double-click it to access its properties.

### To access Device Manager in Windows 7:

1. Select **Start > Computer > System properties**.
2. In the left pane, click **Device Manager**.

### To access Device Manager in Windows Vista:

1. Select **Start > Computer > System properties**.
2. In the left pane, click **Device Manager**.

### To access Device Manager in Windows XP:

1. Select **Start > My Computer**.
2. In the left pane of the System Tasks window, select **View system information**.
3. Select **Hardware tab > Device Manager**.

---

# 7 Backup and recovery

## Windows 7

- [Backing up your information](#)
- [Performing a system recovery](#)

To protect your information, use Windows Backup and Restore to back up individual files and folders, back up your entire hard drive (select models only), create system repair discs (select models only) by using the installed optical drive (select models only) or an optional external optical drive, or create system restore points. In case of system failure, you can use the backup files to restore the contents of your computer.

Windows Backup and Restore provides the following options:

- Creating a system repair disc (select models only) by using the installed optical drive (select models only) or an optional external optical drive
- Backing up your information
- Creating a system image (select models only)
- Scheduling automatic backups (select models only)
- Creating system restore points
- Recovering individual files
- Restoring the computer to a previous state
- Recovering information using recovery tools

---

 **NOTE:** For detailed instructions, perform a search for these topics in Help and Support.

In case of system instability, HP recommends that you print the recovery procedures and save them for later use.

 **NOTE:** Windows includes the User Account Control feature to improve the security of your computer. You may be prompted for your permission or password for tasks such as installing software, running utilities, or changing Windows settings. Refer to Help and Support for more information.

---

## Backing up your information

Recovery after a system failure is as good as your most recent backup. You should create system repair discs (select models only) by using the installed optical drive (select models only) or an optional external optical drive, and your initial backup immediately after software setup. As you add

new software and data files, you should continue to back up your system on a regular basis to maintain a reasonably current backup. The system repair discs (select models only) are used to start up (boot) the computer and repair the operating system in case of system instability or failure. Your initial and subsequent backups allow you to restore your data and settings if a failure occurs.

You can back up your information to an optional external hard drive, a network drive, or discs.

Note the following when backing up:

- Store personal files in the Documents library, and back it up regularly.
- Back up templates that are stored in their associated programs.
- Save customized settings that appear in a window, toolbar, or menu bar by taking a screen shot of your settings. The screen shot can be a time-saver if you have to reset your preferences.
- When backing up to discs, use any of the following types of discs (purchased separately): CD-R, CD-RW, DVD+R, DVD+R DL, DVD-R, DVD-R DL, or DVD±RW. The discs you use will depend on the type of optical drive installed in your computer or the type of external optical drive you are using.

---

 **NOTE:** DVDs and DVDs with double-layer (DL) support store more information than CDs, so using them for backup reduces the number of recovery discs required.

---

- When backing up to discs, number each disc before inserting it into the optical drive of the computer.

To create a backup using Backup and Restore:

---

 **NOTE:** Be sure that the computer is connected to AC power before you start the backup process.

---

 **NOTE:** The backup process may take over an hour, depending on file size and the speed of the computer.

---

1. Select **Start > All Programs > Maintenance > Backup and Restore**.
2. Follow the on-screen instructions to set up your backup, create a system image (select models only), or create a system repair disc (select models only).

## Performing a system recovery

In case of system failure or instability, the computer provides the following tools to recover your files:

- Windows recovery tools: You can use Windows Backup and Restore to recover information you have previously backed up. You can also use Windows Startup Repair to fix problems that might prevent Windows from starting correctly.
- **f11** recovery tools: You can use the **f11** recovery tools to recover your original hard drive image. The image includes the Windows operating system and software programs installed at the factory.

---

 **NOTE:** If you are unable to boot (start up) your computer and you cannot use the system repair discs you previously created (select models only), you must purchase a Windows 7 operating system DVD to reboot the computer and repair the operating system. For additional information, refer to [Using a Windows 7 operating system DVD \(purchased separately\) on page 136](#).

---

## Using the Windows recovery tools

To recover information you previously backed up:

1. Select **Start > All Programs > Maintenance > Backup and Restore**.
2. Follow the on-screen instructions to recover your system settings, your computer (select models only), or your files.

To recover your information using Startup Repair, follow these steps:

---

 **CAUTION:** Using Startup Repair completely erases hard drive contents and reformats the hard drive. All files you have created and any software installed on the computer are permanently removed. When reformatting is complete, the recovery process restores the operating system, as well as the drivers, software, and utilities from the backup used for recovery.

---

1. If possible, back up all personal files.
2. If possible, check for the presence of the Windows partition and the HP Recovery partition.

To check for the Windows partition, select **Start > Computer**.

To check for the HP Recovery partition, click **Start**, right-click **Computer**, click **Manage**, and then click **Disk Management**.

---

 **NOTE:** If the Windows partition and the HP Recovery partition are not listed, you must recover your operating system and programs using the Windows 7 operating system DVD and the *Driver Recovery* disc (both purchased separately). For additional information, refer to [Using a Windows 7 operating system DVD \(purchased separately\) on page 136](#).

---

3. If the Windows partition and the HP Recovery partition are listed, restart the computer, and then press **f8** before the Windows operating system loads.
4. Select **Startup Repair**.
5. Follow the on-screen instructions.

---

 **NOTE:** For additional information on recovering information using the Windows tools, perform a search for these topics in Help and Support.

---

## Using f11 recovery tools

---

 **CAUTION:** Using **f11** completely erases hard drive contents and reformats the hard drive. All files you have created and any software installed on the computer are permanently removed. The **f11** recovery tool reinstalls the operating system and HP programs and drivers that were installed at the factory. Software not installed at the factory must be reinstalled.

---

To recover the original hard drive image using **f11**:

1. If possible, back up all personal files.
2. If possible, check for the presence of the HP Recovery partition: click **Start**, right-click **Computer**, click **Manage**, and then click **Disk Management**.

---

 **NOTE:** If the HP Recovery partition is not listed, you must recover your operating system and programs using the Windows 7 operating system DVD and the *Driver Recovery* disc (both purchased separately). For additional information, refer to [Using a Windows 7 operating system DVD \(purchased separately\) on page 136](#).

---

3. If the HP Recovery partition is listed, restart the computer, and then press **esc** while the “Press the ESC key for Startup Menu” message is displayed at the bottom of the screen.
4. Press **f11** while the “Press <F11> for recovery” message is displayed on the screen.
5. Follow the on-screen instructions.

## Using a Windows 7 operating system DVD (purchased separately)

To order a Windows 7 operating system DVD, go to <http://www.hp.com/support>, select your country or region, and follow the on-screen instructions. You can also order the DVD by calling technical support. For contact information, refer to the *Worldwide Telephone Numbers* booklet included with the computer.

---

 **CAUTION:** Using a Windows 7 operating system DVD completely erases hard drive contents and reformats the hard drive. All files you have created and any software installed on the computer are permanently removed. When reformatting is complete, the recovery process helps you restore the operating system, as well as drivers, software, and utilities.

---

To initiate recovery using a Windows 7 operating system DVD:

---

 **NOTE:** This process takes several minutes.

---

1. If possible, back up all personal files.
2. Restart the computer, and then insert the Windows 7 operating system DVD into the optical drive before the Windows operating system loads.
3. When prompted, press any keyboard key.
4. Follow the on-screen instructions.
5. Click **Next**.
6. Select **Repair your computer**.
7. Follow the on-screen instructions.



# Windows Vista

To protect your information, use the Backup and Restore Center to back up individual files and folders, back up your entire hard drive (select models only), or create system restore points. In case of system failure, you can use the backup files to restore the contents of your computer.

The Backup and Restore Center provides the following options:

- Backing up individual files and folders
- Backing up the entire hard drive (select models only)
- Scheduling automatic backups (select models only)
- Creating system restore points
- Recovering individual files
- Restoring the computer to a previous state
- Recovering information using recovery tools

---

 **NOTE:** For detailed instructions, perform a search for these topics in Help and Support.

 **NOTE:** In case of system instability, HP recommends that you print the recovery procedures and save them for later use.

 **NOTE:** Windows® includes the User Account Control feature to improve the security of your computer. You may be prompted for your permission or password for tasks such as installing software, running utilities, or changing Windows settings. Refer to Help and Support for more information.

---

## Backing up your information

Recovery after a system failure is as complete as your most current backup. You should create your initial backup immediately after software setup. As you add new software and data files, you should continue to back up your system on a regular basis to maintain a reasonably current backup.

You can back up your information to an optional external hard drive, a network drive, or discs.

Note the following when backing up:

- Store personal files in the Documents folder, and back it up regularly.
- Back up templates that are stored in their associated programs.
- Save customized settings that appear in a window, toolbar, or menu bar by taking a screen shot of your settings. The screen shot can be a time-saver if you have to reset your preferences.
- When backing up to discs, use any of the following types of discs (purchased separately): CD-R, CD-RW, DVD+R, DVD+R DL, DVD-R, DVD-R DL, or DVD±RW. The discs you use will depend on the type of optical drive installed in your computer.

---

 **NOTE:** DVDs and DVDs with double-layer (DL) support store more information than CDs, so using them for backup reduces the number of recovery discs required.

---

- When backing up to discs, number each disc before inserting it into the optical drive of the computer.

To create a backup using Backup and Restore Center:

---

 **NOTE:** Be sure that the computer is connected to AC power before you start the backup process.

 **NOTE:** The backup process may take over an hour, depending on file size and the speed of the computer.

---

1. Select **Start > All Programs > Maintenance > Backup and Restore Center**.
2. Follow the on-screen instructions to back up your entire computer (select models only) or your files.

## Performing a recovery

In case of system failure or instability, the computer provides the following tools to recover your files:

- Windows recovery tools: You can use the Backup and Restore Center to recover information you have previously backed up. You can also use Windows Startup Repair to fix problems that might prevent Windows from starting correctly.
- **f11** recovery tools: You can use the **f11** recovery tools to recover your original hard drive image. The image includes the Windows operating system and software programs installed at the factory.

---

 **NOTE:** If you are unable to boot (start up) your computer, you must purchase a Windows Vista® operating system DVD to reboot the computer and repair the operating system. For additional information, refer to [Using a Windows Vista operating system DVD \(purchased separately\) on page 139](#).

---

## Using the Windows recovery tools

To recover information you previously backed up:

1. Select **Start > All Programs > Maintenance > Backup and Restore Center**.
2. Follow the on-screen instructions to recover your entire computer (select models only) or your files.

To recover your information using Startup Repair, follow these steps:

---

 **CAUTION:** Using Startup Repair completely erases hard drive contents and reformats the hard drive. All files you have created and any software installed on the computer are permanently removed. When reformatting is complete, the recovery process restores the operating system, as well as the drivers, software, and utilities from the backup used for recovery.

---

1. If possible, back up all personal files.
2. If possible, check for the presence of the Windows partition and the HP Recovery partition. To find the partitions, select **Start > Computer**.

---

 **NOTE:** If the Windows partition and the HP Recovery partition have been deleted, you must recover your operating system and programs using the Windows Vista operating system DVD and the *Driver Recovery* disc (both purchased separately). For additional information, refer to [Using a Windows Vista operating system DVD \(purchased separately\) on page 139](#).

---

3. Restart the computer, and then press **f8** before the Windows operating system loads.

4. Select **Repair your computer**.
5. Follow the on-screen instructions.

 **NOTE:** For additional information on recovering information using the Windows tools, perform a search for these topics in Help and Support.

---

## Using f11 recovery tools

 **CAUTION:** Using **f11** completely erases hard drive contents and reformats the hard drive. All files you have created and any software installed on the computer are permanently removed. The **f11** recovery tool reinstalls the operating system and HP programs and drivers that were installed at the factory. Software not installed at the factory must be reinstalled. Personal files must be restored from a backup.

 **NOTE:** If your computer includes a solid-state drive (SSD), you may not have a recovery partition. Recovery discs have been included for computers that do not have a partition. Use these discs to recover your operating system and software. To check for the presence of a recovery partition, select **Start > Computer**. If the partition is present, an HP Recovery drive is listed in the Hard Disk Drives section of the window.

---

To recover the original hard drive image using **f11**, follow these steps:

1. If possible, back up all personal files.
2. If possible, check for the presence of the HP Recovery partition. To find the partition, select **Start > Computer**.

 **NOTE:** If the HP Recovery partition has been deleted, you must recover your operating system and programs using the Windows Vista operating system DVD and the *Driver Recovery* disc (both purchased separately). For additional information, refer to [Using a Windows Vista operating system DVD \(purchased separately\) on page 139](#).

---

3. Turn on or restart the computer, and then press **esc** while the “Press the ESC key for Startup Menu” message is displayed at the bottom of the screen.
4. Press **f11** while the “Press <F11> for recovery” message is displayed on the screen.
5. Follow the on-screen instructions.

## Using a Windows Vista operating system DVD (purchased separately)

To order a Windows Vista operating system DVD, go to <http://www.hp.com/support>, select your country or region, and follow the on-screen instructions. You can also order the DVD by calling technical support. For contact information, refer to the *Worldwide Telephone Numbers* booklet included with the computer.

 **CAUTION:** Using a Windows Vista operating system DVD completely erases hard drive contents and reformats the hard drive. All files you have created and any software installed on the computer are permanently removed. When reformatting is complete, the recovery process helps you restore the operating system, as well as drivers, software, and utilities.

---

To initiate recovery using a Windows Vista operating system DVD:



---

**NOTE:** This process takes several minutes.

---

1. If possible, back up all personal files.
2. Restart the computer, and then insert the Windows Vista operating system DVD into the optical drive before the Windows operating system loads.
3. When prompted, press any keyboard key.
4. Follow the on-screen instructions.
5. Click **Next**.
6. Select **Repair your computer**.
7. Follow the on-screen instructions.

---

## 8 Power cord set requirements

The wide range input feature of the computer permits it to operate from any line voltage from 100 to 120 volts AC, or from 220 to 240 volts AC.

The 3-conductor power cord set included with the computer meets the requirements for use in the country or region where the equipment is purchased.

Power cord sets for use in other countries and regions must meet the requirements of the country or region where the computer is used.

### Requirements for all countries and regions

The requirements listed below are applicable to all countries and regions:

- The length of the power cord set must be at least 1.5 m (5.0 ft) and no more than 2.0 m (6.5 ft).
- All power cord sets must be approved by an acceptable accredited agency responsible for evaluation in the country or region where the power cord set will be used.
- The power cord sets must have a minimum current capacity of 10 amps and a nominal voltage rating of 125 or 250 V AC, as required by the power system of each country or region.
- The appliance coupler must meet the mechanical configuration of an EN 60 320/IEC 320 Standard Sheet C13 connector for mating with the appliance inlet on the back of the computer.

## Requirements for specific countries and regions

Country/region	Accredited agency	Applicable note number
Australia	EANSW	1
Austria	OVE	1
Belgium	CEBC	1
Canada	CSA	2
Denmark	DEMKO	1
Finland	FIMKO	1
France	UTE	1
Germany	VDE	1
Italy	IMQ	1
Japan	METI	3
The Netherlands	KEMA	1
Norway	NEMKO	1
The People's Republic of China	CCC	5
South Korea	EK	4
Sweden	SEMKO	1
Switzerland	SEV	1
Taiwan	BSMI	4
The United Kingdom	BSI	1
The United States	UL	2

1. The flexible cord must be Type HO5VV-F, 3-conductor, 1.0-mm<sup>2</sup> conductor size. Power cord set fittings (appliance coupler and wall plug) must bear the certification mark of the agency responsible for evaluation in the country or region where it will be used.
2. The flexible cord must be Type SPT-3 or equivalent, No. 18 AWG, 3-conductor. The wall plug must be a two-pole grounding type with a NEMA 5-15P (15 A, 125 V) or NEMA 6-15P (15 A, 250 V) configuration.
3. The appliance coupler, flexible cord, and wall plug must bear a "T" mark and registration number in accordance with the Japanese Dentori Law. The flexible cord must be Type VCT or VCTF, 3-conductor, 1.00-mm<sup>2</sup> conductor size. The wall plug must be a two-pole grounding type with a Japanese Industrial Standard C8303 (7 A, 125 V) configuration.
4. The flexible cord must be Type RVV, 3-conductor, 0.75-mm<sup>2</sup> conductor size. Power cord set fittings (appliance coupler and wall plug) must bear the certification mark of the agency responsible for evaluation in the country or region where it will be used.
5. The flexible cord must be Type VCTF, 3-conductor, 0.75-mm<sup>2</sup> conductor size. Power cord set fittings (appliance coupler and wall plug) must bear the certification mark of the agency responsible for evaluation in the country or region where it will be used.

---

# 9 Recycling

## Battery

When a battery has reached the end of its useful life, do not dispose of the battery in general household waste. Follow the local laws and regulations in your area for computer battery disposal.

## Display

---

**⚠ WARNING!** The backlight contains mercury. Exercise caution when removing and handling the backlight to avoid damaging this component and causing exposure to the mercury.

**⚠ CAUTION:** The procedures in this chapter can result in damage to display components. The only components intended for recycling purposes are the LCD panel and the backlight. When you remove these components, handle them carefully.

**📝 NOTE: Materials Disposal.** This HP product contains mercury in the backlight in the display assembly that might require special handling at end-of-life. Disposal of mercury may be regulated because of environmental considerations. For disposal or recycling information, contact your local authorities, or see the Electronic Industries Alliance (EIA) Web site at <http://www.eiae.org>.

---

This section provides disassembly instructions for the display assembly. The display assembly must be disassembled to gain access to the backlight (**1**) and the liquid crystal display (LCD) panel (**2**).



---

**📝 NOTE:** The procedures provided in this chapter are general disassembly instructions. Specific details, such as screw sizes, quantities, and locations, and component shapes and sizes, can vary from one computer model to another.

---

Perform the following steps to disassemble the display assembly:

1. Remove all screw covers (1) and screws (2) that secure the display bezel to the display assembly.

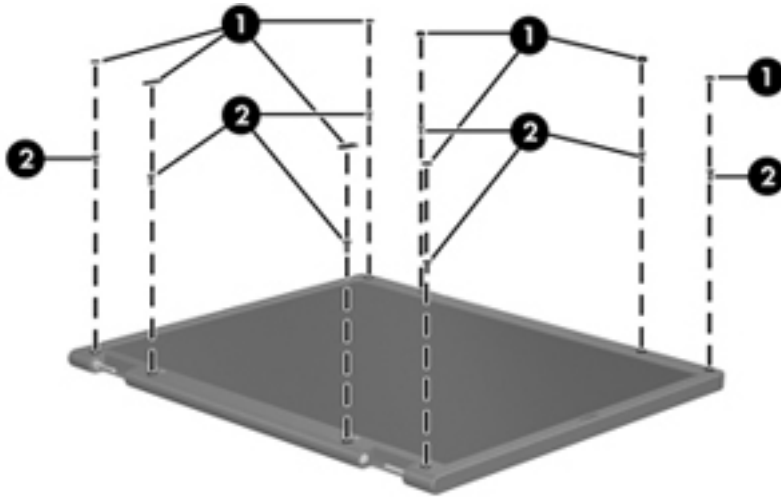

2. Lift up and out on the left and right inside edges (1) and the top and bottom inside edges (2) of the display bezel until the bezel disengages from the display assembly.
3. Remove the display bezel (3).

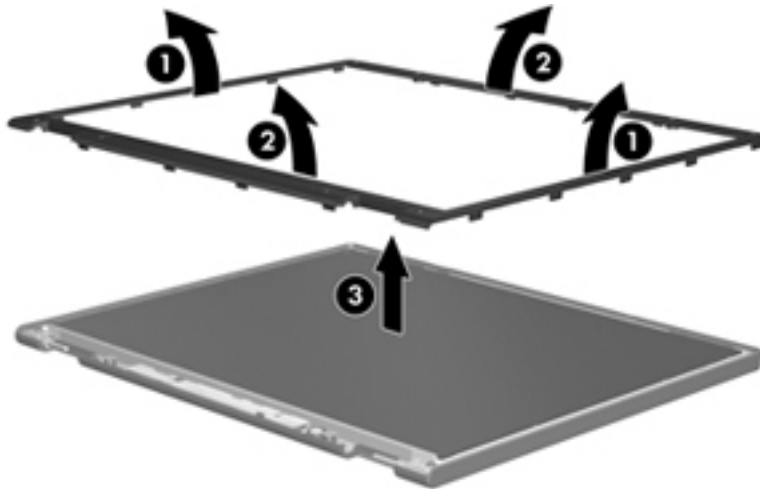



4. Disconnect all display panel cables (1) from the display inverter and remove the inverter (2).

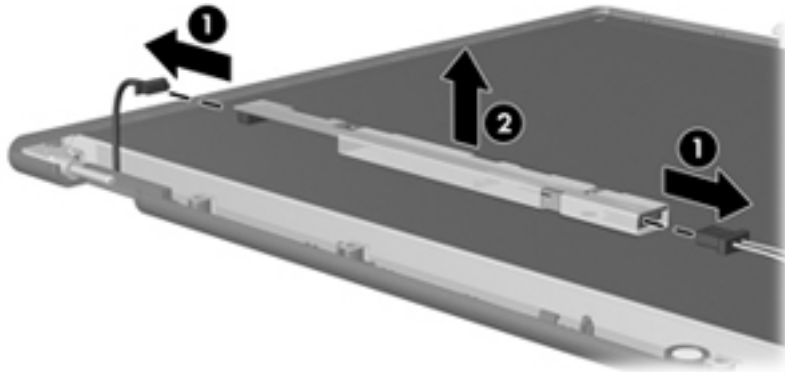

5. Remove all screws (1) that secure the display panel assembly to the display enclosure.
6. Remove the display panel assembly (2) from the display enclosure.

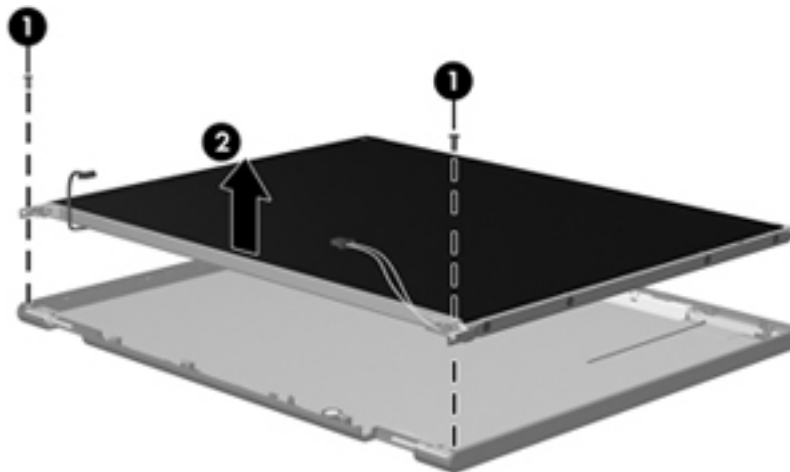

7. Position the display panel assembly upside-down.
8. Remove all screws that secure the display panel frame to the display panel.

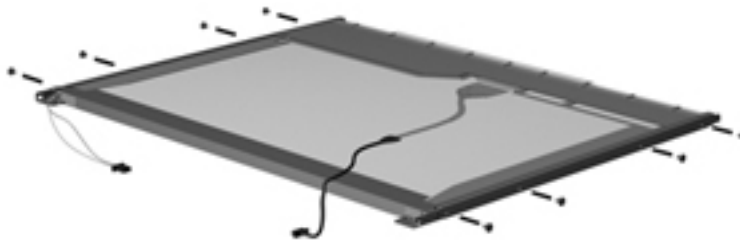

9. Use a sharp-edged tool to cut the tape (1) that secures the sides of the display panel to the display panel frame.

10. Remove the display panel frame (2) from the display panel.

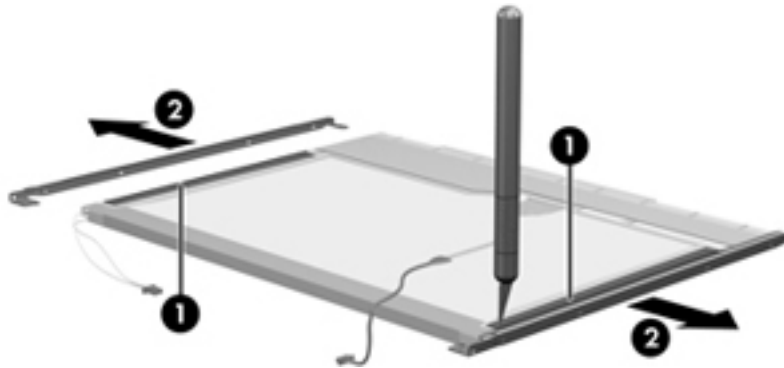

11. Remove the screws (1) that secure the backlight cover to the display panel.
12. Lift the top edge of the backlight cover (2) and swing it outward.

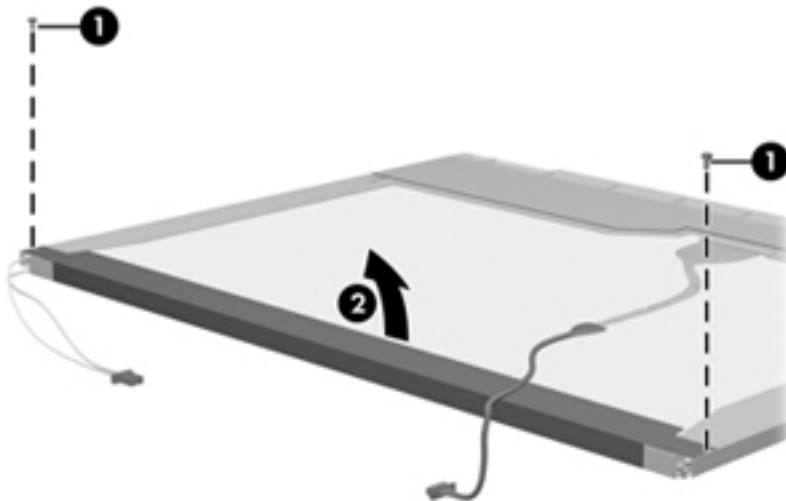

13. Remove the backlight cover.
14. Position the display panel right-side up.

15. Remove the backlight cables (1) from the clip (2) in the display panel.

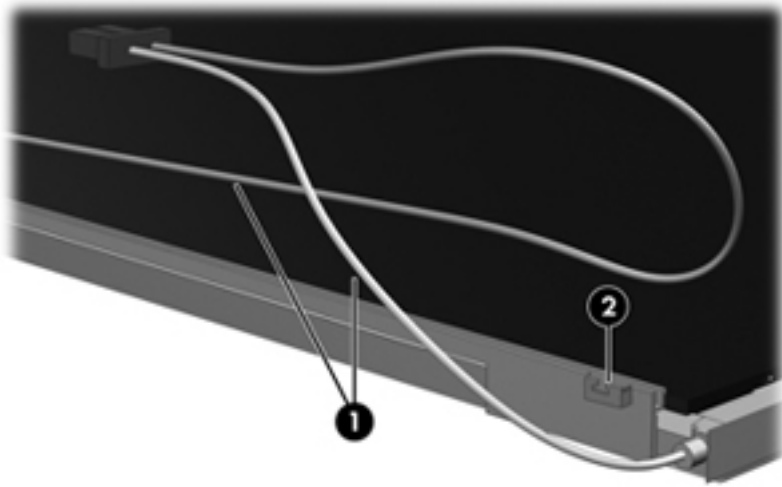

16. Position the display panel upside-down.

**⚠ WARNING!** The backlight contains mercury. Exercise caution when removing and handling the backlight to avoid damaging this component and causing exposure to the mercury.

17. Remove the backlight frame from the display panel.

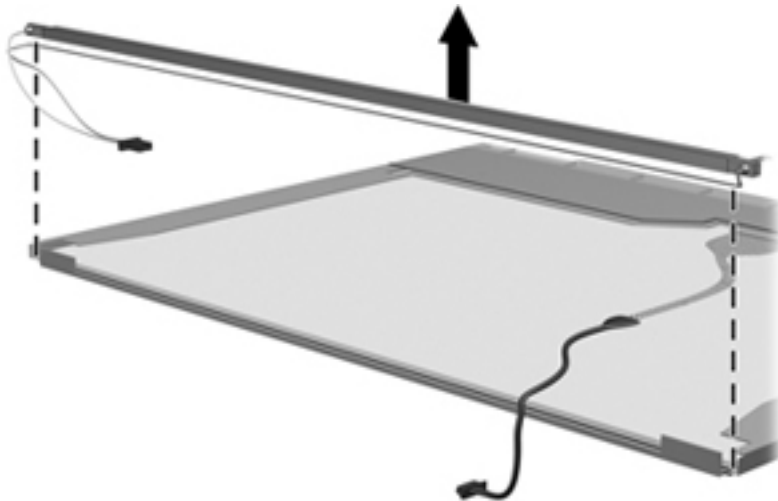

18. Remove the backlight from the backlight frame.

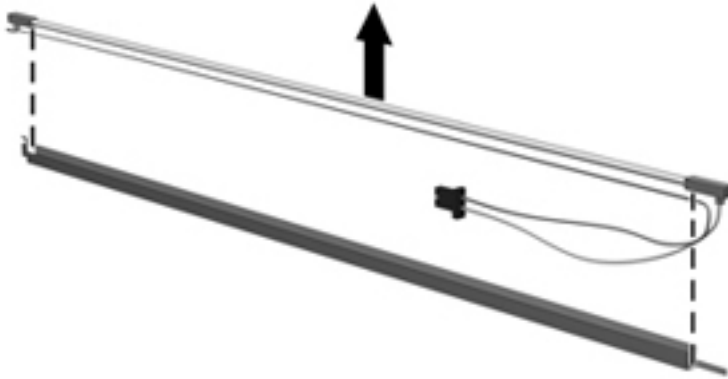

19. Disconnect the display panel cable (1) from the LCD panel.  
20. Remove the screws (2) that secure the LCD panel to the display rear panel.  
21. Release the LCD panel (3) from the display rear panel.  
22. Release the tape (4) that secures the LCD panel to the display rear panel.

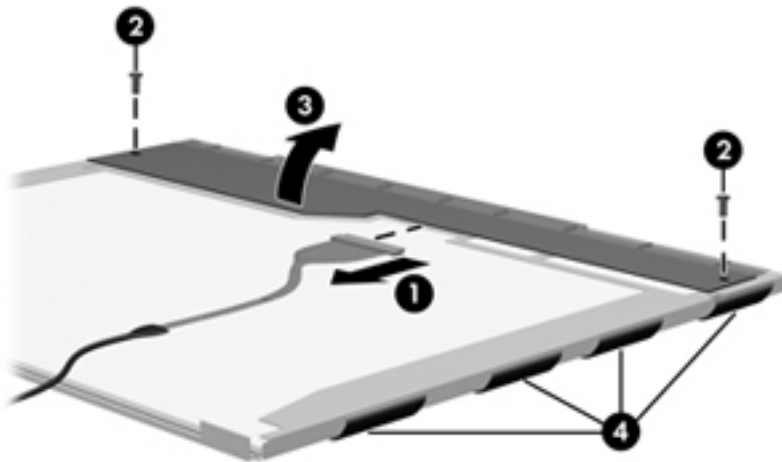

23. Remove the LCD panel.

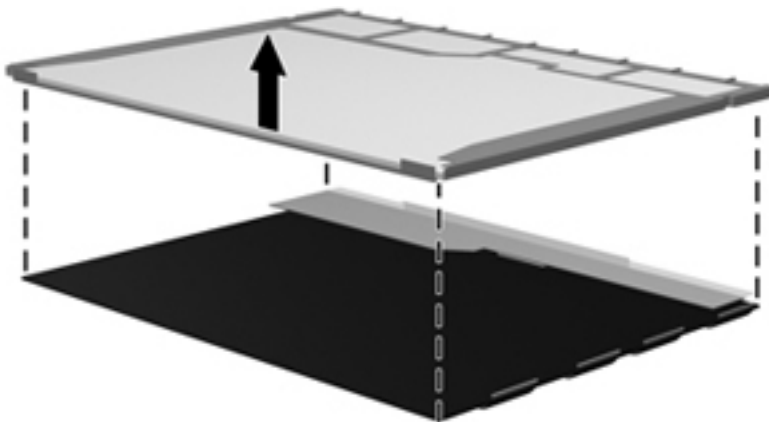

24. Recycle the LCD panel and backlight.

---

# Index

## Symbols/Numerics

1394 port, identifying 19, 20

## A

AC adapter, spare part numbers 39, 42

accessory battery connector, identifying 24

ambient light sensor, identifying 10

antennas, disconnecting 74, 79

audio, product description 3

audio-in (microphone) jack 22

audio-out (headphone) jack 22

## B

Backup and Restore 134

Backup and Restore Center 137, 138

battery

removal 58

spare part number 29, 58

battery bay 24

battery light 18

battery release latch 24

BIOS

determining version 122

downloading an update 122

updating 122

Blu-ray BD-R/RE + DVDSM DL Drive 128

Blu-ray ROM DVD±RW SuperMulti DL Drive

removal 65

spare part number 33, 38, 50, 65

specifications 130

Bluetooth cable, illustrated 37

Bluetooth compartment, identifying 24

Bluetooth module

removal 81

spare part number 29, 40, 81

bottom cover

removal 94

spare part number 29, 49, 94

bottom cover release latch,

identifying 24

bottom door

illustrated 36

removal 64

spare part number 64

buttons

calculator 15

left pointing stick button 11

left TouchPad 11

optical drive eject 22

power 15

QuickWeb 15

right pointing stick button 12

right TouchPad 12

TouchPad 14

TouchPad on/off 11

volume mute 15

wireless 15

## C

Cable Kit

contents 37

spare part number 33, 37, 48, 49

cables, service considerations 52

calculator button, identifying 15

calculator light 13

caps lock light, identifying 12

chipset, product description 1

components

bottom 23

display 9

front 18

left side 19

rear 21

right side 22

top 11

computer feet

locations 57

spare part number 57

Computer Setup

navigating and selecting 120

restoring factory settings 121

computer specifications 124

connector, power 21

connectors, service

considerations 52

## D

display assembly

removal 59, 111

spare part numbers 59, 111

display bezel

removal 60, 114

spare part numbers 35, 48, 111

display cable covers, illustrated 36

display component recycling 143

display components, spare part numbers 34

display enclosure, spare part number 36, 48, 111

display hinge

removal 116

spare part number 50

Display Hinge Kit, spare part

number 35, 48, 111

- display panel
  - product description 1
  - removal 115
  - spare part number 35, 49
- Display Panel Support Kit, spare part number 36, 50, 112
- display release latch 18
- display specifications 125, 126
- DisplayPort, identifying 21
- docking support, product description 5
- drives, preventing damage 52
- DVD-ROM Drive
  - precautions 52
  - removal 65
  - spare part number 33, 38, 50, 65
  - specifications 131
- DVD±RW and CD-RW SuperMulti DL Combo Drive
  - precautions 52
  - removal 65
  - spare part number 33, 38, 50, 65

**E**

- electrostatic discharge 53
- eSATA port, identifying 20
- esc key, identifying 16
- Ethernet, product description 3
- ExpressCard slot 19, 20
- ExpressCard slot insert, illustrated 36
- external media cards, product description 4
- external monitor port 20

**F**

- f11 recovery 135, 139
- fan
  - removal 85
  - spare part number 27, 48, 85
- feet
  - locations 57
  - spare part number 57
- fingerprint reader, identifying 15
- fn key, identifying 17

- function board
  - removal 103
  - spare part number 29, 48, 103
- function keys, identifying 16

**G**

- graphics, product description 1
- grounding equipment and methods 55

**H**

- hard drive
  - precautions 52
  - product description 2
  - removal 69
  - spare part numbers 33, 38, 44, 49, 69
  - specifications 127
- hard drive bracket, removal 70
- hard drive cradle, spare part number 39, 50
- Hard Drive Hardware Kit, spare part number 38, 49, 69
- hard drive light 19
- hard drive recovery 135, 139
- heat sink
  - removal 86
  - spare part number 27, 50, 86
- hinge
  - removal 116
  - spare part number 50
- HP QuickWeb light 13

**I**

- integrated numeric keypad, identifying 17
- integrated webcam light, identifying 10
- internal display switch 9, 10
- internal microphones, identifying 9, 10

**J**

- jacks
  - audio-in (microphone) 22
  - audio-out (headphone) 22
  - network 22
  - RJ-11 (modem) 21
  - RJ-45 (network) 22

**K**

- keyboard
  - product description 5
  - removal 92
  - spare part numbers 27, 44, 45, 46, 92
- keypad, integrated numeric 17
- keys
  - esc 16
  - fn 17
  - function 16
  - menu 17
  - num lk 17
  - start 17

**L**

- latch, battery release 24
- legacy support, USB 120
- light sensor, identifying 10
- lights
  - battery 18
  - calculator 13
  - caps lock 12
  - hard drive 19
  - HP QuickWeb 13
  - mute 13
  - num lock 13
  - power 13, 18
  - TouchPad on/off 12
  - webcam 10
  - wireless 13, 18

**M**

- mass storage devices, spare part numbers 38
- Media Card Reader, identifying 19, 20
- memory module
  - product description 2
  - removal 72
  - spare part numbers 29, 72
- memory module compartment, identifying 24
- menu key, identifying 17
- microphone (audio-in) jack
  - product description 3
- MIMO antenna, illustrated 37
- Mobile Broadband Module, identifying 24
- model name 1

- modem module
  - product description 3
  - removal 83
  - spare part number 29, 42, 83
- mute light, identifying 13
- N**
- network jack, identifying 22
- num lk key, identifying 17
- num lock light 13
- O**
- operating system, product
  - description 6
- optical drive
  - identifying 22
  - precautions 52
  - product description 3
  - removal 65
  - spare part numbers 32, 38, 65
  - specifications 128, 129, 130, 131
- optical drive eject button,
  - identifying 22
- optical drive protective insert
  - illustrated 36
- P**
- packing guidelines 54
- plastic parts 51
- Plastics Kit, spare part number
  - 36, 49
- pointing device, product
  - description 5
- pointing stick 11
- ports
  - 1394 19, 20
  - DisplayPort 21
  - eSATA 20
  - external monitor 20
  - product description 4
  - serial 21
  - USB 19, 20, 22
- power button, identifying 15
- power connector cable,
  - illustrated 37
- power connector, identifying 21
- power cord
  - set requirements 141
  - spare part numbers 39, 40
- power light 13, 18
- power requirements, product
  - description 5
- processor
  - product description 1
  - removal 90
  - spare part numbers 28, 90
- product description
  - audio 3
  - chipset 1
  - display panel 1
  - docking support 5
  - Ethernet 3
  - external media cards 4
  - graphics 1
  - hard drives 2
  - keyboard 5
  - memory module 2
  - microphone 3
  - modem module 3
  - operating system 6
  - optical drives 3
  - pointing devices 5
  - ports 4
  - power requirements 5
  - processors 1
  - product name 1
  - security 5
  - serviceability 7
  - webcam 3
  - wireless 3
- product name 1
- Q**
- QuickWeb button, identifying 15
- R**
- recovery partition 135, 139
- removal/replacement
  - preliminaries 51
  - procedures 56
- restoring the hard drive 135, 139
- RJ-11 (modem) jack, identifying
  - 21
- RJ-11 jack cable
  - illustrated 37
  - removal 101
- RJ-45 (network) jack, identifying
  - 22
- RTC battery
  - removal 71
  - spare part number 32, 48, 71
- Rubber Kit, spare part number 49
- S**
- Screw Kit, spare part number
  - 39, 48, 49
- security cable slot, identifying 22
- security, product description 5
- serial port, identifying 21
- service considerations 51
- service tag 25, 56
- serviceability, product
  - description 7
- setup utility
  - navigating and selecting 120
  - restoring factory settings 121
- SIM slot, identifying 24
- SIM, removal 63
- slots
  - ExpressCard 19, 20
  - security cable 22
  - Smart Card 20
- Smart Card slot 20
- solid-state drive, spare part
  - numbers 33, 38, 50, 69
- speaker assembly
  - removal 99
  - spare part number 28, 48, 99
- speakers, identifying 19
- specifications
  - Blu-ray BD-R/RE + DVDSM DL Drive 128
  - Blu-ray ROM DVD±RW SuperMulti DL Drive 130
  - computer 124
  - display 125, 126
  - DVD-ROM Drive 131
  - DVD±RW and CD-RW SuperMulti DL Combo Drive 129
  - hard drive 127
- start key, identifying 17
- static-shielding materials 55
- system board
  - removal 106
  - spare part number 27
  - spare part numbers 49, 50, 106

system repair disc 133  
system restore points 133

## T

thermal material, replacement  
88, 89  
tools required 51  
top cover, spare part numbers  
27, 49  
TouchPad  
buttons 11, 12  
identifying 11  
TouchPad on/off button 11  
TouchPad on/off button,  
identifying 14  
TouchPad on/off light 12  
transporting guidelines 54

## U

upgrade bay  
removal 67  
spare part number 67  
USB board  
removal 105  
spare part number 29, 105  
USB legacy support 120  
USB port, identifying 19, 20  
USB ports, identifying 19, 22

## V

vents, identifying 19, 20, 24  
volume mute button, identifying  
15

## W

webcam  
identifying 10, 11  
product description 3  
spare part number 35, 49  
webcam light, identifying 10  
Windows 7 operating system  
DVD 136  
Windows Backup and Restore  
133  
Windows Vista operating system  
DVD 139  
wireless antennas  
disconnecting 74, 79  
identifying 9, 10  
wireless button, identifying 15  
wireless lights 13, 18

wireless, identifying 24  
wireless, product description 3  
WLAN antennas  
identifying 9, 10  
illustrated 37  
spare part number 35, 111  
WLAN module  
removal 76  
spare part numbers 29, 41, 76  
workstation guidelines 54  
WWAN antennas  
identifying 9, 10  
illustrated 37  
spare part number 35, 111  
WWAN module  
removal 74  
spare part number 32, 43, 74