

User Guide

HP Notebook

© Copyright 2011 Hewlett-Packard Development Company, L.P.

Bluetooth is a trademark owned by its proprietor and used by Hewlett-Packard Company under license. AMD is a trademark of Advanced Micro Devices, Inc. Intel is a trademark of Intel Corporation in the U.S. and other countries. Microsoft and Windows are U.S. registered trademarks of Microsoft Corporation. SD Logo is a trademark of its proprietor.

The information contained herein is subject to change without notice. The only warranties for HP products and services are set forth in the express warranty statements accompanying such products and services. Nothing herein should be construed as constituting an additional warranty. HP shall not be liable for technical or editorial errors or omissions contained herein.

First Edition: August 2011

Document Part Number: 659983-001

Product notice

This guide describes features that are common to most models. Some features may not be available on your computer.

Software terms

By installing, copying, downloading, or otherwise using any software product preinstalled on this computer, you agree to be bound by the terms of the HP End User License Agreement (EULA). If you do not accept these license terms, your sole remedy is to return the entire unused product (hardware and software) within 14 days for a refund subject to the refund policy of your place of purchase.

For any further information or to request a full refund of the computer, please contact your local point of sale (the seller).

Safety warning notice

 **WARNING!** To reduce the possibility of heat-related injuries or of overheating the computer, do not place the computer directly on your lap or obstruct the computer air vents. Use the computer only on a hard, flat surface. Do not allow another hard surface, such as an adjoining optional printer, or a soft surface, such as pillows or rugs or clothing, to block airflow. Also, do not allow the AC adapter to come into contact with the skin or a soft surface, such as pillows or rugs or clothing, during operation. The computer and the AC adapter comply with the user-accessible surface temperature limits defined by the International Standard for Safety of Information Technology Equipment (IEC 60950).

Table of contents

1 Introduction	1
Important first steps	1
Finding information	2
2 Getting to know your computer	4
Top	4
TouchPad	4
Lights	5
Buttons and fingerprint reader	6
Keys	8
Front	9
Right side	10
Left side	11
Display	12
Bottom	13
Labels	14
3 HP QuickWeb	15
Getting started	15
Starting HP QuickWeb	16
4 Networking	17
Using an Internet service provider	18
Creating a wireless connection	19
Identifying wireless and network status icons	19
Turning wireless devices on or off	20
Using HP Connection Manager (select models only)	20
Using operating system controls	20
Using a WLAN	20
Connecting to an existing WLAN	21
Setting up a new WLAN network	21

Configuring a wireless router	22
Protecting your WLAN	22
Roaming to another network	23
Using Bluetooth wireless devices	23
Bluetooth and Internet Connection Sharing (ICS)	23
Connecting to a wired network	24
Connecting to a local area network (LAN)	24
5 Pointing devices and keyboard	25
Using pointing devices	25
Setting pointing device preferences	25
Using the TouchPad	25
Turning the TouchPad off or on	26
Navigating	27
Selecting	27
Using TouchPad gestures	28
Scrolling	29
Pinching/Zooming	29
Using the keyboard	30
Using the action keys	30
Using the hotkeys	32
6 Multimedia and other features	33
Using the media activity controls	33
Audio	33
Adjusting the volume	34
Checking audio functions on the computer	34
Intel Wireless Display	35
Using Beats Audio (select models only)	35
Webcam	36
Video	36
VGA	36
HDMI	37
Configuring audio for HDMI	37
Using CyberLink PowerDVD (select models only)	38
7 Power management	39
Inserting or removing the battery	39
Inserting the battery	39
Removing the battery	40

Shutting down the computer	41
Setting power options	41
Using power-saving states	41
Initiating and exiting Sleep	42
Initiating and exiting Hibernation	42
Using the power meter	43
Using power plans	43
Viewing the current power plan	43
Selecting a different power plan	43
Customizing power plans	43
Setting password protection on wakeup	44
Using HP Power Manager (select models only)	44
Using battery power	45
Finding battery information	45
Using Battery Check	45
Displaying the remaining battery charge	46
Maximizing battery discharge time	46
Managing low battery levels	46
Identifying low battery levels	46
Resolving a low battery level	47
Resolving a low battery level when external power is available	47
Resolving a low battery level when a charged battery is available ...	47
Resolving a low battery level when no power source is available ...	47
Resolving a low battery level when the computer cannot exit	
Hibernation	47
Conserving battery power	48
Storing a battery	48
Disposing of a used battery	48
Replacing the battery	48
Using external AC power	49
Testing an AC adapter	50
Switchable graphics/dual graphics (select models only)	51
Using switchable graphics (select models only)	51
Using dual graphics (select models only)	52
Refreshing your software content (select models only)	52
8 External cards and devices	53
Using Digital Media Slot cards (select models only)	53
Inserting a digital card	53
Removing a digital card	54
Using a USB device	54

Connecting a USB device	55
Removing a USB device	55
Using optional external devices	56
Using optional external drives	56
9 Drives	57
Handling drives	57
Using hard drives	58
Improving hard drive performance	58
Using Disk Defragmenter	58
Using Disk Cleanup	58
Using HP 3D DriveGuard (select models only)	59
Identifying HP 3D DriveGuard status	59
Managing power with a parked hard drive	60
Using HP 3D DriveGuard software	60
Adding or replacing a hard drive	61
Removing the hard drive	61
Installing a hard drive	63
Using optical drives	65
Identifying the installed optical drive	65
Inserting an optical disc	65
Removing an optical disc	66
When the disc tray opens normally	66
When the disc tray fails to open normally	67
Sharing optical drives	68
10 Memory modules	69
Adding or replacing memory modules	69
11 Securing your computer and information	74
Locating your security software (select models only)	75
Using passwords	75
Setting Windows passwords	76
Setting passwords in Setup Utility (BIOS)	76
Using the fingerprint reader	77
Registering fingerprints	77
Using your registered fingerprint to log on to Windows	77
Using Internet security software	78
Using antivirus software	78
Using firewall software	78

Installing software updates	79
Installing Windows security updates	79
Installing HP and third-party software updates	79
Securing your wireless network	79
Backing up your software applications and information	80
Using an optional security cable lock	80
12 Backup and recovery	81
Restoring the system	82
Creating restore media	82
Performing a system recovery	83
Using the dedicated recovery partition	83
Restoring using the restore media	84
Changing the computer boot order	84
Backing up and recovering your information	85
Using Windows Backup and Restore	86
Using Windows system restore points	86
When to create restore points	86
Create a system restore point	87
Restore to a previous date and time	87
13 Setup Utility (BIOS) and System Diagnostics	88
Using Setup Utility (BIOS)	88
Starting Setup Utility (BIOS)	88
Changing the language of Setup Utility (BIOS)	88
Navigating and selecting in Setup Utility (BIOS)	89
Displaying system information	89
Restoring factory settings in Setup Utility (BIOS)	90
Exiting Setup Utility (BIOS)	90
Updating the BIOS	91
Determining the BIOS version	91
Downloading a BIOS update	92
Using System Diagnostics	93
Appendix A Troubleshooting and support	94
Troubleshooting	94
The computer is unable to start up	94
The computer screen is blank	94
Software is functioning abnormally	94
The computer is on but not responding	95

The computer is unusually warm	95
An external device is not working	95
The wireless network connection is not working	96
The optical disc tray does not open for removal of a disc	97
The computer does not detect the disc drive	98
A disc does not play	99
The process of burning a disc does not begin, or it stops before completion	100
Contacting customer support	100
Appendix B Cleaning your computer	101
Cleaning the display	101
Cleaning the sides and cover	101
Cleaning the TouchPad and keyboard	101
Appendix C Traveling with the computer	102
Appendix D Updating programs and drivers	104
Appendix E Electrostatic Discharge	105
Appendix F Specifications	106
Input power	106
DC plug of external HP power supply	106
Operating environment	107
Index	108

1 Introduction

This guide contains details about your computer's components, such as ports and jacks. It describes multimedia and other features. And it provides important security, backup, and recovery information.



NOTE: Some of the features described in this guide may not be available on your computer.

Important first steps

After you set up and register the computer, it is important to take the following steps:

1. Set up your wired or wireless network. For more information, refer to [Networking on page 17](#).
2. Update your antivirus software. For more information, refer to [Securing your computer and information on page 74](#).
3. Create recovery discs or a recovery flash drive. For instructions, refer to [Backup and recovery on page 81](#).
4. Get to know your computer. Refer to [Getting to know your computer on page 4](#) and [Pointing devices and keyboard on page 25](#) for additional information.
5. Discover the software that is already installed on the computer by selecting **Start > All Programs**.

Finding information

The computer comes with several resources to help you perform various tasks.

Resource	Contents
<i>Setup Instructions</i>	<ul style="list-style-type: none">• How to set up the computer• Identification of computer components
<i>User Guide</i>	<ul style="list-style-type: none">• Computer features
To access this guide: Select Start > Help and Support > User Guides .	<ul style="list-style-type: none">• Power management features• Instructions for the following:<ul style="list-style-type: none">◦ Connecting to a wireless network◦ Using the keyboard and pointing devices◦ Using the multimedia features of the computer◦ Maximizing battery life◦ Replacing or upgrading the hard drive and memory modules◦ Protecting the computer◦ Performing a backup and a recovery◦ Contacting customer support◦ Caring for the computer◦ Updating the software• Computer specifications
Help and Support	<ul style="list-style-type: none">• Operating system information
To access Help and Support, select Start > Help and Support . NOTE: For country- or region-specific support, go to http://www.hp.com/support , select your country or region, and follow the on-screen instructions.	<ul style="list-style-type: none">• Software, driver, and BIOS updates• Troubleshooting tools• Instructions for contacting customer support
<i>Regulatory, Safety and Environmental Notices</i>	<ul style="list-style-type: none">• Regulatory and safety information
To access this guide: Select Start > Help and Support > User Guides .	<ul style="list-style-type: none">• Battery disposal information
<i>Safety & Comfort Guide</i>	<ul style="list-style-type: none">• Proper workstation setup
To access this guide: Select Start > Help and Support > User Guides . – or – Go to http://www.hp.com/ergo .	<ul style="list-style-type: none">• Guidelines for posture and work habits that maximize your comfort and decrease your risk of injury• Electrical and mechanical safety information
<i>Worldwide Telephone Numbers</i> booklet This booklet is provided with your computer.	HP customer support telephone numbers

Resource	Contents
<p>HP Web site</p> <p>To access this Web site, go to http://www.hp.com/support.</p>	<ul style="list-style-type: none"> • Customer support information • Information for ordering parts • Software, driver, and BIOS updates • Information about accessories for the computer
<p><i>Limited Warranty*</i></p> <p>To access the warranty:</p> <p>Select Start > Help and Support > User Guides.</p> <p>– or –</p> <p>Go to http://www.hp.com/go/orderdocuments.</p>	<p>Warranty information</p>
<p>*You can find the expressly provided HP Limited Warranty applicable to your product located with the electronic guides on your computer and/or on the CD/DVD provided in the box. In some countries/regions, HP may provide a printed HP Limited Warranty in the box. For some countries/regions where the warranty is not provided in printed format, you may request a printed copy from http://www.hp.com/go/orderdocuments or write to:</p>	
<ul style="list-style-type: none"> • North America: Hewlett-Packard, MS POD, 11311 Chinden Blvd, Boise, ID 83714, USA • Europe, Middle East, Africa: Hewlett-Packard, POD, Via G. Di Vittorio, 9, 20063, Cernusco s/Naviglio (MI), Italy • Asia Pacific: Hewlett-Packard, POD, P.O. Box 200, Alexandra Post Office, Singapore 911507 	
<p>Please include your product number, warranty period (found on your serial number label), name, and postal address.</p>	
<p>IMPORTANT: Do NOT return your HP product to the addresses above. For product support, refer to your product home page at http://www.hp.com/go/contactHP.</p>	

2 Getting to know your computer

Top



TouchPad

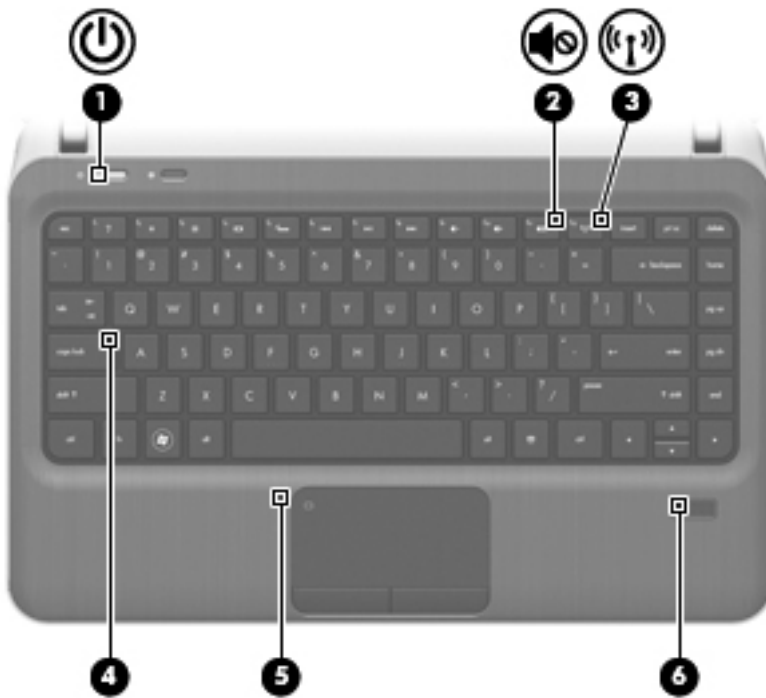

Component	Description
(1) TouchPad light	<ul style="list-style-type: none">• On: The TouchPad is off.• Off: The TouchPad is on.
(2) TouchPad on/off button	Turns the TouchPad on or off.
(3) TouchPad zone	Moves the pointer and selects or activates items on the screen.
(4) Left TouchPad button	Functions like the left button on an external mouse.
(5) Right TouchPad button	Functions like the right button on an external mouse.

Lights



Component	Description
(1)  Power light	<ul style="list-style-type: none"> • White: The computer is on. • Blinking white: The computer is in the Sleep state. • Off: The computer is off or in Hibernation.
(2)  Mute light	<ul style="list-style-type: none"> • Amber: Computer sound is off. • Off: Computer sound is on.
(3)  Wireless light	<ul style="list-style-type: none"> • White: An integrated wireless device, such as a wireless local area network (WLAN) device and/or a Bluetooth® device, is on. • Amber: All wireless devices are off.
(4) Caps lock light	On: Caps lock is on.
(5) TouchPad light	<ul style="list-style-type: none"> • On: The TouchPad is off. • Off: The TouchPad is on.
(6) Fingerprint reader light	<ul style="list-style-type: none"> • White: The fingerprint was read. • Amber: The fingerprint was not read.

Buttons and fingerprint reader





Component	Description
(1)  Power button	<ul style="list-style-type: none">• When the computer is off, press the button to turn on the computer.• When the computer is on, press the button briefly to initiate Sleep.• When the computer is in the Sleep state, press the button briefly to exit Sleep.• When the computer is in Hibernation, press the button briefly to exit Hibernation. <p>If the computer has stopped responding and Windows® shutdown procedures are ineffective, press and hold the power button for at least 5 seconds to turn off the computer.</p> <p>To learn more about your power settings, select Start > Control Panel > System and Security > Power Options, or refer to Setting power options on page 41.</p>

Component	Description
(2)  QuickWeb button	<p>Opens QuickWeb (select models only).</p> <ul style="list-style-type: none"> • When the computer is off or in Hibernation, press the button to open HP QuickWeb. • When the computer is in Microsoft Windows, press the button to open the default Web browser. • When the computer is in HP QuickWeb, press the button to open the Web browser. <p>QuickWeb allows you to browse the Internet, communicate with Skype, and explore other HP QuickWeb programs. When the computer is off or in Hibernation, you can press the QuickWeb button to access these features without waiting for the operating system to start.</p> <p>NOTE: For more information, refer to HP QuickWeb on page 15 and to the HP QuickWeb software Help. If your computer does not have HP QuickWeb software, the button opens the Web browser.</p>
(3) Fingerprint reader	Allows a fingerprint logon to Windows, instead of a password logon.

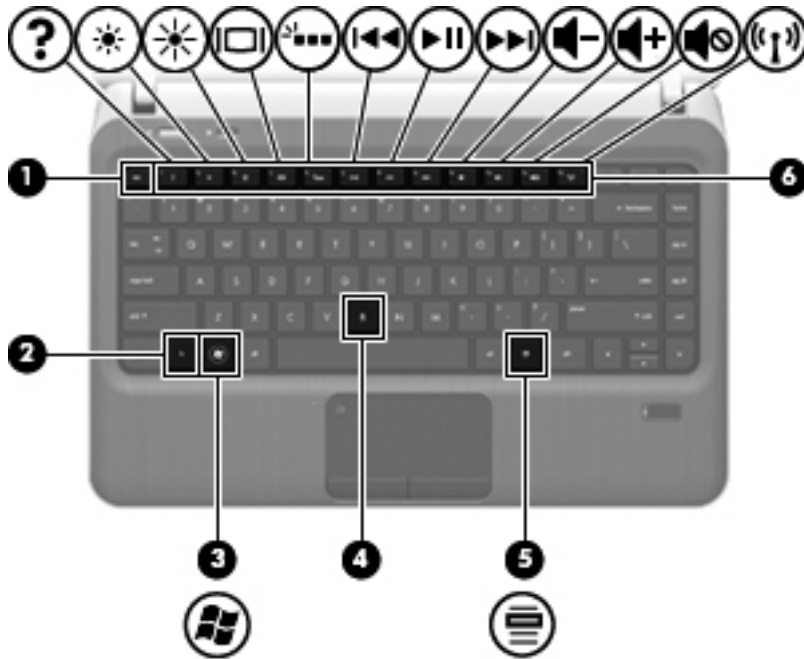
Keys



Component	Description
(1) <code>esc</code> key	Displays system information when pressed in combination with the <code>fn</code> key.
(2) <code>fn</code> key	Executes frequently used system functions when pressed in combination with the <code>b</code> key or the <code>esc</code> key.
(3)  Windows logo key	Displays the Windows Start menu.
(4) <code>b</code> key	<p>Enables or disables the Beats Audio bass settings (select models only) when pressed in combination with the <code>fn</code> key.</p> <p>Beats Audio is an enhanced audio profile that provides a deep, controlled bass while maintaining a clear sound. Beats Audio is enabled by default.</p> <p>You can view and control the bass settings through the Windows operating system. To view and control the bass properties:</p> <p>Select Start > Control Panel > Hardware and Sound > Beats Audio Control Panel.</p>
(5)  Windows applications key	Displays a shortcut menu for items beneath the pointer.
(6) Action keys	Execute frequently used system functions.



Front



Component	Description
(1) Digital Media Slot	Supports the following digital card formats: <ul style="list-style-type: none"><li data-bbox="839 541 1209 569">• Secure Digital (SD) Memory Card<li data-bbox="839 590 1422 617">• Secure Digital Extended Capacity (SDxC) Memory Card<li data-bbox="839 638 1382 665">• Secure Digital High Capacity (SDHC) Memory Card<li data-bbox="839 686 1334 714">• Ultra High Speed MultiMediaCard (UHS/MMC)
(2) Speakers (2)	Produce sound.

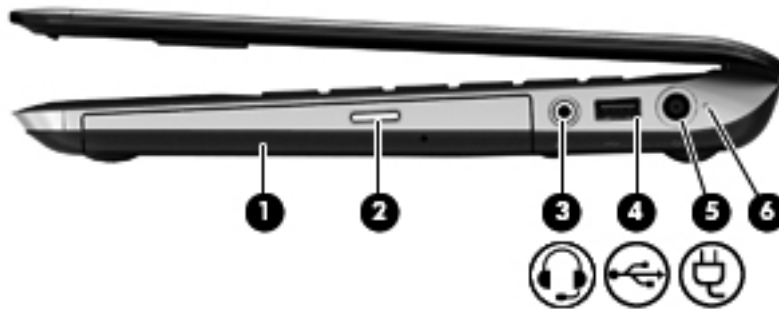





Right side

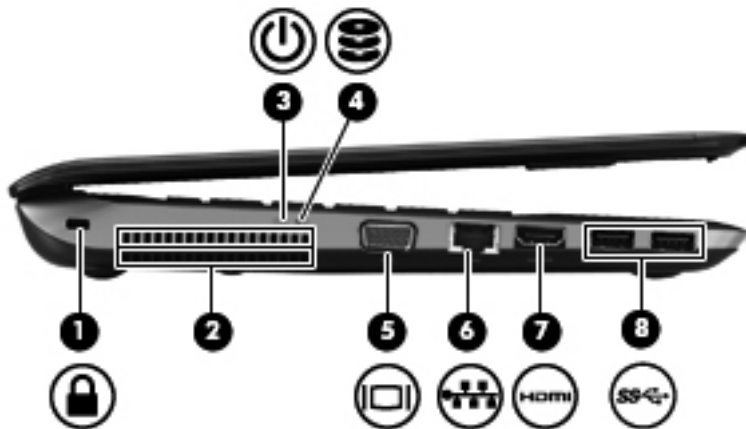

Component	Description
(1) Optical drive	Reads and writes (select models only) to an optical disc.
(2) Optical drive eject button	Ejects the optical disc.
(3)  Audio-out (headphone) jack/audio-in (microphone) jack	<p>Connects optional powered stereo speakers, headphones, earbuds, a headset, or television audio. Also connects an optional headset microphone.</p> <p>WARNING! To reduce the risk of personal injury, adjust the volume before putting on headphones, earbuds, or a headset. For additional safety information, refer to the <i>Regulatory, Safety and Environmental Notices</i>.</p> <p>NOTE: When a device is connected to the jack, the computer speakers are disabled.</p> <p>NOTE: The microphone function is operational only when used with a headphone/microphone unit that has a 4-conductor audio connector..</p>
(4)  USB 2.0 port	Connects optional USB devices.
(5)  Power connector	Connects an AC adapter.
(6) Battery light	<ul style="list-style-type: none">• White: The computer is connected to external power and the battery is fully charged.• Amber: A battery is charging.• Blinking white: The battery charge level is 12% or less (recharge the battery as soon as possible).• Off: The computer is not connected to external power.

Left side



Component	Description
(1) 	<p>Security cable slot</p> <p>Attaches an optional security cable to the computer.</p> <p>NOTE: The security cable is designed to act as a deterrent, but it may not prevent the computer from being mishandled or stolen.</p>
(2)	<p>Vents</p> <p>Enable airflow to cool internal components.</p> <p>NOTE: The computer fan starts up automatically to cool internal components and prevent overheating. It is normal for the internal fan to cycle on and off during routine operation.</p>
(3) 	<p>Power light</p> <ul style="list-style-type: none"> White: The computer is on. Blinking white: The computer is in the Sleep state. Off: The computer is off or in Hibernation.
(4) 	<p>Hard drive light</p> <ul style="list-style-type: none"> Blinking white: The hard drive is being accessed. Amber: HP 3D DriveGuard has temporarily parked the hard drive. <p>NOTE: For information on HP 3D DriveGuard, refer to Using HP 3D DriveGuard (select models only) on page 59.</p>
(5) 	<p>External monitor port</p> <p>Connects an external VGA monitor or projector.</p>
(6) 	<p>RJ-45 (network) jack</p> <p>Connects a network cable.</p>
(7) 	<p>HDMI port</p> <p>Connects an optional video or audio device, such as a high-definition television, or any compatible digital or audio device.</p>
(8) 	<p>USB 3.0 ports (2)</p> <p>Connect optional USB 3.0 devices and provide enhanced USB power performance.</p> <p>NOTE: The USB 3.0 port is also compatible with USB 1.0 and USB 2.0 devices.</p>

Display





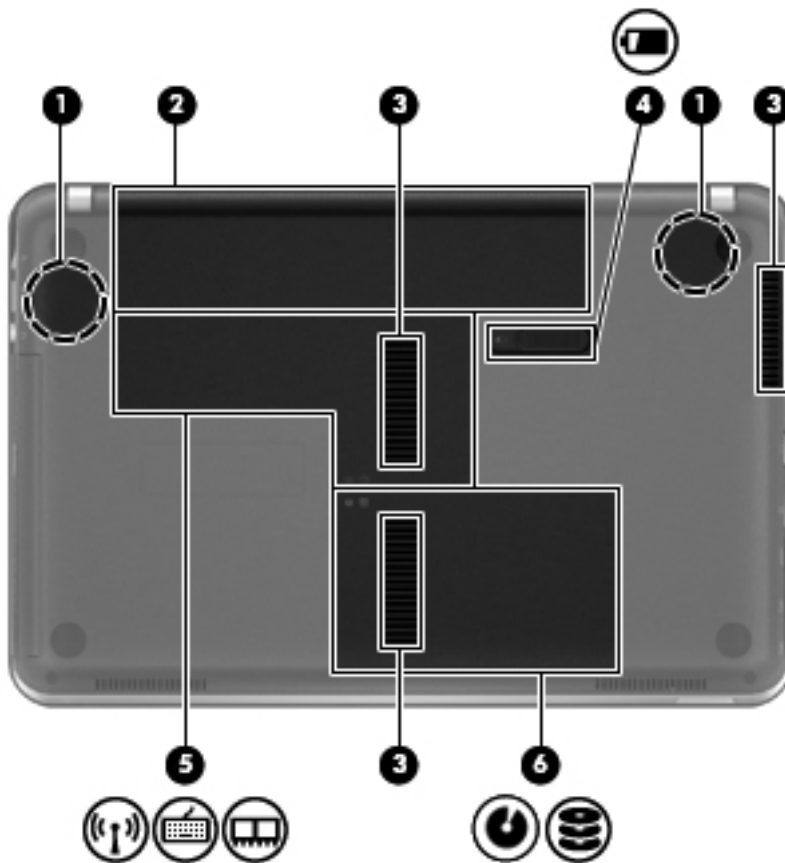

Component	Description
(1) WLAN antennas (2)*	Send and receive wireless signals to communicate with wireless local area networks (WLANs).
(2) Internal microphones (2)	Record sound.
(3) Webcam light	On: The webcam is in use.
(4) Webcam	Records video and captures still photographs. To use the webcam, select Start > All Programs > Communication and Chat > CyberLink YouCam .

*The antennas are not visible from the outside of the computer. For optimal transmission, keep the areas immediately around the antennas free from obstructions. To see wireless regulatory notices, refer to the section of the *Regulatory, Safety, and Environmental Notices* that applies to your country or region. These notices are located in Help and Support.

Bottom



Component	Description
(1) HP Triple Bass Reflex Subwoofers	Provide superior bass sound
(2) Battery bay	Holds the battery.
(3) Vents (3)	Enable airflow to cool internal components.
(4)  Battery release latch	NOTE: The computer fan starts up automatically to cool internal components and prevent overheating. It is normal for the internal fan to cycle on and off during routine operation.
(5)    Memory module compartment	Contains the memory module slots, the wireless LAN (WLAN) module, and the mSATA drive (select models only).
(6)  Hard drive bay	Holds the hard drive.

Labels

The labels affixed to the computer provide information you may need when you troubleshoot system problems or travel internationally with the computer:

- Serial number label—Provides important information, including the following:

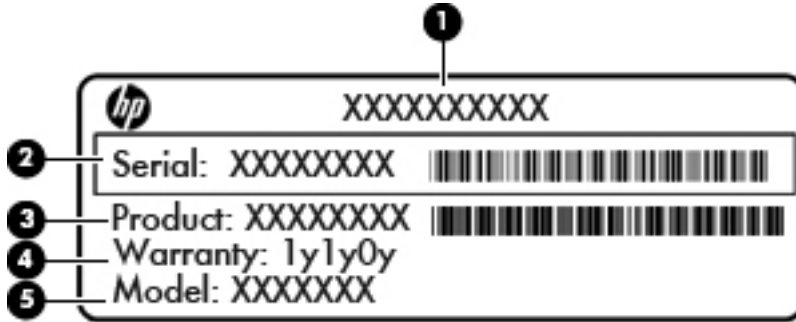

Component	
(1)	Product name
(2)	Serial number
(3)	Product part number
(4)	Warranty period
(5)	Model description

Have this information available when you contact customer support. The serial number label is affixed inside the battery bay.

- Microsoft® Certificate of Authenticity—Contains the Windows Product Key. You may need the Product Key to update or troubleshoot the operating system. The Microsoft Certificate of Authenticity is located on the bottom of the computer.
- Regulatory label—Provides regulatory information about the computer. The regulatory label is affixed inside the battery bay.
- Wireless certification label or labels (select models only)—Provide information about optional wireless devices and the approval markings of some of the countries or regions in which the devices have been approved for use. You may need this information when traveling internationally. If your computer model includes one or more wireless devices, one or more certification labels are included with your computer. Wireless certification labels are affixed to the bottom of the computer.

3 HP QuickWeb

Getting started

The HP QuickWeb environment provides a fun and engaging way to perform many of your favorite activities. Your computer is ready to go within seconds of starting QuickWeb, allowing you to rapidly access the Internet, widgets, and communication programs. To use QuickWeb, press the QuickWeb button, and then start browsing the Web, communicating with others using Skype, and exploring other HP QuickWeb programs.

Your HP QuickWeb Home screen includes the following features:

- Web browser—Search and browse the Internet, and create links to your favorite Web sites.
- Skype (select models only)—Communicate using Skype, an application that uses voice over Internet protocol (VoIP). Skype lets you make conference calls or have video chats with one or more people at a time. You can also make long-distance phone calls to land lines.
- Widgets—Start using widgets for news, weather, social networking, stocks, a calculator, sticky notes, and more. You can also use Widget Manager to add more widgets to the HP QuickWeb Home screen.



NOTE: For additional information about using HP QuickWeb, refer to the HP QuickWeb software Help.

Starting HP QuickWeb

- ▲ To start HP QuickWeb, press the QuickWeb button when the computer is off or in Hibernation.

The following table explains the different behaviors of the QuickWeb button.

Button	Behavior
QuickWeb button	<ul style="list-style-type: none">• When the computer is off or in Hibernation, press the button to open HP QuickWeb.• When the computer is in Microsoft Windows, press the button to open the default Web browser.• When the computer is in HP QuickWeb, press the button to open the Web browser. <p>NOTE: If your computer does not have HP QuickWeb software, the button opens the Web browser.</p>



NOTE: For more information, refer to the HP QuickWeb software Help.

4 Networking

Your computer supports two types of Internet access:

- **Wireless**—Refer to [Creating a wireless connection on page 19](#).
- **Wired**—Refer to [Connecting to a wired network on page 24](#).



NOTE: You must set up Internet service before you can connect to the Internet.

Using an Internet service provider

Before you can connect to the Internet, you must establish an account with an Internet service provider (ISP). To purchase Internet service and a modem, contact a local ISP. The ISP will help set up the modem, install a network cable to connect your wireless computer to the modem, and test the Internet service.

 **NOTE:** Your ISP will give you a user ID and password to access the Internet. Record this information and store it in a safe place.

The following features will help you set up a new Internet account or configure the computer to use an existing account:

- **Internet Services & Offers (available in some locations)**—This utility assists with signing up for a new Internet account and configuring the computer to use an existing account. To access this utility, select **Start > All Programs > Online Services > Get Online**.
- **ISP-provided icons (available in some locations)**—These icons may be displayed either individually on the Windows desktop or grouped in a desktop folder named Online Services. To set up a new Internet account or configure the computer to use an existing account, double-click an icon, and then follow the on-screen instructions.
- **Windows Connect to the Internet Wizard**—This wizard allows you to connect to the Internet in any of the following situations:
 - You already have an account with an ISP.
 - You do not have an Internet account and want to select an ISP from the list provided within the wizard. (The list of ISP providers is not available in all regions.)
 - You have selected an unlisted ISP, and the ISP has provided you with information such as a specific IP address and POP3 and SMTP settings.

To access the Windows Connect to the Internet Wizard and instructions for using it, select **Start > Control Panel > Network and Internet > Network and Sharing Center**.

 **NOTE:** If you are prompted within the wizard to choose between enabling or disabling Windows Firewall, choose to enable the firewall.







Creating a wireless connection

Your computer may be equipped with one or more of the following wireless devices:

- Wireless local area network (WLAN) device
- Bluetooth® device

For more information on wireless technology, refer to the information and Web site links provided in Help and Support.

Identifying wireless and network status icons

Icon	Name	Description
	HP Connection Manager	Opens HP Connection Manager, which enables you to create and manage WLAN, and Bluetooth connections.
	Wired network (connected)	Indicates that one or more network devices are connected to the network.
	Network (disabled/ disconnected)	Indicates that all network devices are disabled in Windows Control Panel.
	Network (connected)	Indicates that one or more network devices are connected to a network.
	Network (disconnected)	Indicates that network devices are not connected to a network.
	Network (disabled/ disconnected)	Indicates that no wireless connections are available.

Turning wireless devices on or off

You can use the wireless key or HP Connection Manager (select models only) to turn on and turn off wireless devices. Refer to [Using the action keys on page 30](#) for information on identifying the location of the wireless key on your computer.

To turn off wireless devices using HP Connection Manager:

- ▲ Right-click the HP Connection Manager icon in the notification area, at the far right of the taskbar, and then click the power button next to the desired device.

– or –

Select **Start > All Programs > HP Help and Support > HP Connection Manager**, and then click the power button next to the desired device.

Using HP Connection Manager (select models only)

HP Connection Manager provides a central location for managing your wireless devices. HP Connection Manager allows you to manage the following devices:

- Wireless local area network (WLAN)/Wi-Fi
- Bluetooth®

HP Connection Manager provides information and notifications on connection status and power status. Status information and notifications are provided in the notification area, at the far right of the taskbar.

To open HP Connection Manager:

- ▲ Click the HP Connection Manager icon in the notification area, at the far right of the taskbar.

– or –

Select **Start > All Programs > HP Help and Support > HP Connection Manager**.

For more information, refer to the HP Connection Manager software Help.

Using operating system controls

The Network and Sharing Center allows you to set up a connection or network, connect to a network, manage wireless networks, and diagnose and repair network problems.

To use operating system controls:

- ▲ Select **Start > Control Panel > Network and Internet > Network and Sharing Center**.

For more information, select **Start > Help and Support**.

Using a WLAN

A wireless connection connects the computer to Wi-Fi networks, or WLANs. A WLAN is composed of other computers and accessories that are linked by a wireless router or a wireless access point.

Connecting to an existing WLAN

To connect to an existing WLAN:

1. Be sure that the WLAN device is on. (Refer to [Turning wireless devices on or off on page 20.](#))
2. Click the network icon in the notification area, at the far right of the taskbar.
3. Select your WLAN from the list.
4. Click **Connect**.

If the network is a security-enabled WLAN, you are prompted to enter a network security code. Type the code, and then click **OK** to complete the connection.

 **NOTE:** If no WLANs are listed, you are out of range of a wireless router or access point.

 **NOTE:** If you do not see the WLAN you want to connect to, click **Open Network and Sharing Center**, and then click **Set up a new connection or network**. A list of options is displayed. You can choose to manually search for and connect to a network or to create a new network connection.

After the connection is made, you can place the mouse pointer over the network icon in the notification area, at the far right of the taskbar, to verify the name and status of the connection.

 **NOTE:** The functional range (how far your wireless signals travel) depends on WLAN implementation, router manufacturer, and interference from other electronic devices or structural barriers such as walls and floors.

Setting up a new WLAN network

Required equipment:

- A broadband modem (either DSL or cable) **(1)** and high-speed Internet service purchased from an Internet service provider (ISP)
- A wireless router (purchased separately) **(2)**
- Your new wireless computer **(3)**

 **NOTE:** Some modems have a built-in wireless router. Check with your ISP to determine what type of modem you have.

The illustration shows an example of a completed WLAN network installation that is connected to the Internet. As your network grows, additional wireless and wired computers can be connected to the network to access the Internet.



Configuring a wireless router

For help in setting up a WLAN, refer to the information provided by your router manufacturer or your ISP.

The Windows operating system also provides tools to help you set up a new wireless network. To use the Windows tools to set up your network, select **Start > Control Panel > Network and Internet > Network and Sharing Center > Set up a new connection or network > Set up a new network**. Then follow the on-screen instructions.



NOTE: It is recommended that you initially connect your new wireless computer to the router by using the network cable provided with the router. When the computer successfully connects to the Internet, you can disconnect the cable, and then access the Internet through your wireless network.

Protecting your WLAN

When you set up a WLAN or access an existing WLAN, always enable security features to protect your network from unauthorized access. WLANs in public areas (hotspots) like coffee shops and airports may not provide any security. If you are concerned about the security of your computer in a hotspot, limit your network activities to e-mail that is not confidential and basic Internet surfing.

Wireless radio signals travel outside the network, so other WLAN devices can pick up unprotected signals. You can take the following precautions to protect your WLAN:

- **Firewall**—A firewall checks both data and requests for data that are sent to your network, and discards any suspicious items. Firewalls are available in both software and hardware. Some networks use a combination of both types.
- **Wireless encryption**—Your computer supports three encryption protocols:
 - Wi-Fi Protected Access (WPA)
 - Wi-Fi Protected Access II (WPA2)
 - Wired Equivalent Privacy (WEP)



NOTE: HP recommends that you select WPA2, which is the most advanced of the three encryption protocols. The use of WEP encryption is not recommended, because it can be overcome with little effort.

- Wi-Fi Protected Access (WPA) and Wi-Fi Protected Access II (WPA2) use security standards to encrypt and decrypt data transmitted over the network. Both WPA and WPA2 dynamically generate a new key for every packet, and they also generate a different set of keys for each computer network. To accomplish this:
 - WPA uses Advanced Encryption Standard (AES) and Temporal Key Integrity Protocol (TKIP)
 - WPA2 uses Cipher Block Chaining Message Authentication Code Protocol (CCMP), which is a new AES protocol.
- Wired Equivalent Privacy (WEP) encrypts data with a WEP key before it is transmitted. Without the correct key, others will not be able to use the WLAN.

Roaming to another network

When you move your computer within range of another WLAN, Windows attempts to connect to that network. If the attempt is successful, your computer is automatically connected to the new network. If Windows does not recognize the new network, follow the same procedure you used initially to connect to your WLAN.

Using Bluetooth wireless devices

A Bluetooth device provides short-range wireless communications that replace the physical cable connections that traditionally link electronic devices such as the following:

- Computers
- Phones
- Imaging devices (cameras and printers)
- Audio devices
- Mouse

Bluetooth devices provide peer-to-peer capability that allows you to set up a personal area network (PAN) of Bluetooth devices. For information on configuring and using Bluetooth devices, refer to the Bluetooth software Help.

Bluetooth and Internet Connection Sharing (ICS)

HP does **not** recommend setting up one computer with Bluetooth as a host and using it as a gateway through which other computers may connect to the Internet. When two or more computers are connected using Bluetooth, and Internet Connection Sharing (ICS) is enabled on one of the computers, the other computers may not be able to connect to the Internet using the Bluetooth network.

The strength of Bluetooth is in synchronizing information transfers between your computer and wireless devices including cellular phones, printers, cameras, and PDAs. The inability to consistently connect two or more computers to share the Internet through Bluetooth is a limitation of Bluetooth and the Windows operating system.

Connecting to a wired network

Connecting to a local area network (LAN)

Connecting to a local area network (LAN) requires an 8-pin, RJ-45 network cable (purchased separately). If the network cable contains noise suppression circuitry **(1)**, which prevents interference from TV and radio reception, orient the circuitry end of the cable **(2)** toward the computer.



To connect the network cable:

1. Plug the network cable into the network jack **(1)** on the computer.
2. Plug the other end of the network cable into a network wall jack **(2)** or router.

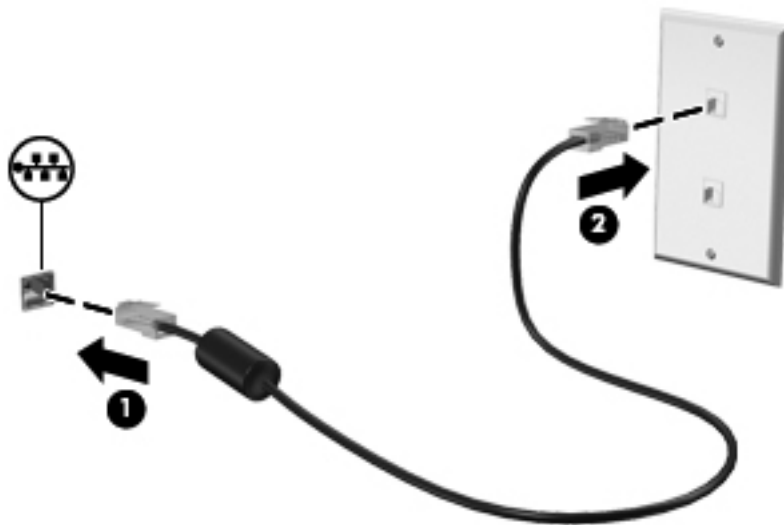

⚠ WARNING! To reduce the risk of electric shock, fire, or damage to the equipment, do not plug a modem cable or telephone cable into an RJ-45 (network) jack.

5 Pointing devices and keyboard

Using pointing devices

 **NOTE:** In addition to the pointing devices included with your computer, you can use an external USB mouse (purchased separately) by connecting it to one of the USB ports on the computer.

Setting pointing device preferences

Use Mouse Properties in Windows® to customize pointing device settings, button configuration, click speed, and pointer options.

To access Mouse Properties, select **Start > Devices and Printers**. Then right-click the listing that represents your computer, and select **Mouse settings**.

Using the TouchPad

 **NOTE:** The TouchPad on your computer may look slightly different from the illustrations in this section. Refer to [Getting to know your computer on page 4](#) for specific information about the TouchPad on your computer.

To move the pointer, slide one finger across the TouchPad in the direction you want the pointer to go. Use the left and right TouchPad buttons as you would use the buttons on an external mouse.



Turning the TouchPad off or on

To turn the TouchPad off or on, quickly double-tap the TouchPad on/off button.

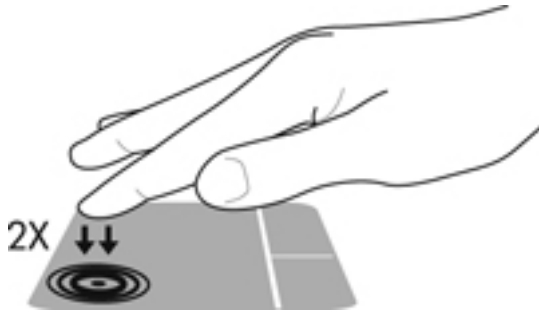
 **NOTE:** The TouchPad light is off when the TouchPad is on.



The TouchPad light and onscreen display icons indicate the TouchPad status when the TouchPad is turned off or on. The following table shows and describes the TouchPad display icons.

TouchPad light	Icon	Description
Amber		Indicates that the TouchPad is off.
Off		Indicates that the TouchPad is on.

Navigating

To move the pointer, slide one finger across the TouchPad in the direction you want the pointer to go.

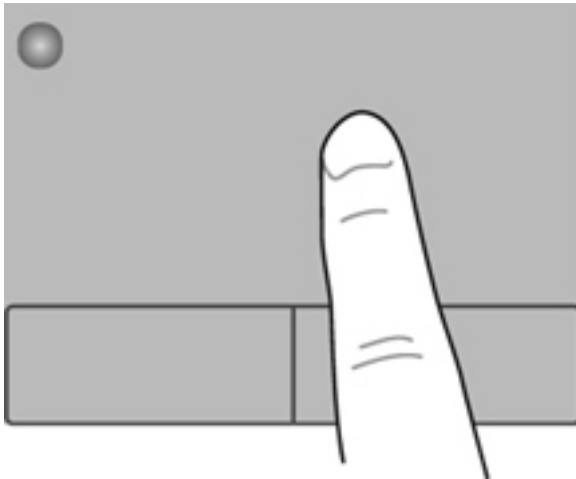

Selecting

Use the left and right TouchPad buttons as you would use the corresponding buttons on an external mouse.

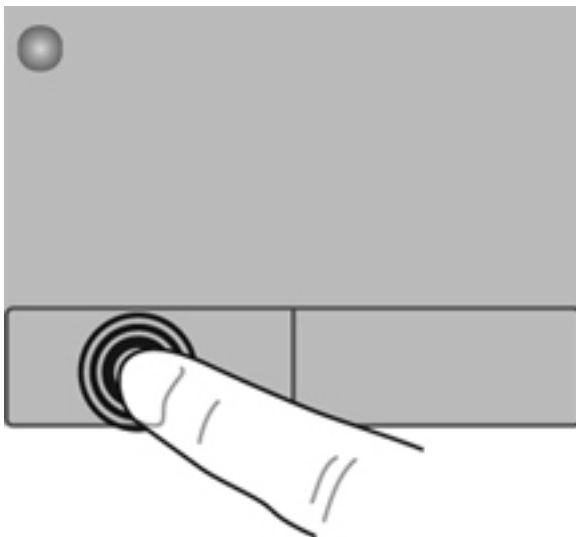

Using TouchPad gestures

The TouchPad supports a variety of gestures. To use TouchPad gestures, place two fingers on the TouchPad at the same time.



NOTE: TouchPad gestures are not supported in all programs.

To view the demonstration of a gesture:

1. Select **Start > Control Panel > Hardware and Sound > Synaptics TouchPad**.
2. Click a gesture to activate the demonstration.

To turn the gestures on or off:

1. Select **Start > Control Panel > Hardware and Sound > Synaptics TouchPad**.
2. Select the check box next to the gesture that you want to turn on or off.
3. Click **Apply**, and then click **OK**.

Scrolling

Scrolling is useful for moving up, down, or sideways on a page or image. To scroll, place two fingers slightly apart on the TouchPad, and then drag them across the TouchPad in an up, down, left, or right motion.

 **NOTE:** Scrolling speed is controlled by finger speed.

 **NOTE:** Two-finger scrolling is enabled at the factory.

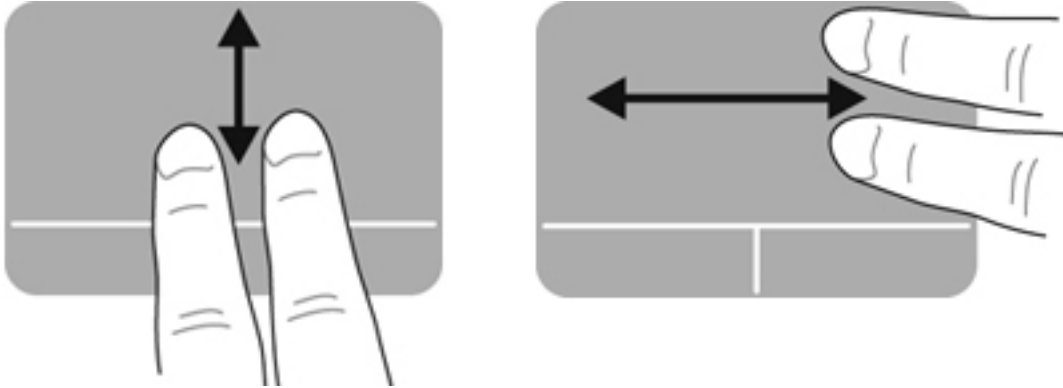

Pinching/Zooming

Pinching allows you to zoom in or out on images or text.

- Zoom in by placing two fingers together on the TouchPad, and then moving them apart.
- Zoom out by placing two fingers apart on the TouchPad, and then moving them together.

 **NOTE:** Pinching/zooming is enabled at the factory.

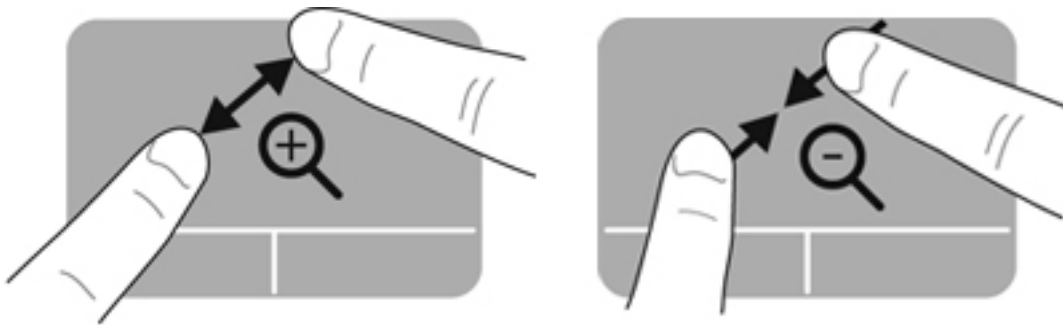

Using the keyboard

Using the action keys









An action key performs an assigned function. The icon on each of the **f1** through **f4** keys and **f6** through **f12** keys illustrates the assigned function for that key.





To use an action key function, press and hold the key.

The action key feature is enabled at the factory. You can disable this feature in Setup Utility (BIOS) and revert back to standard settings by pressing the **fn** key and an action key to activate the assigned function. Refer to [Using Setup Utility \(BIOS\) on page 88](#) for instructions.

CAUTION: Use extreme care when making changes in Setup Utility. Errors can prevent the computer from operating properly.



Icon	Key	Description
	f1	Opens Help and Support, which provides tutorials, information about your Windows operating system and computer, answers to questions, and updates to your computer. Help and Support also provides automated troubleshooting tools and access to customer support.
	f2	Decreases the screen brightness level incrementally as long as you hold down the key.
	f3	Increases the screen brightness level incrementally as long as you hold down the key.
	f4	Switches the screen image among display devices connected to the system. For example, if a monitor is connected to the computer, pressing this key alternates the screen image from the computer display to the monitor display to a simultaneous display on both the computer and the monitor. Most external monitors receive video information from the computer using the external VGA video standard. This action key can also alternate images among other devices that are receiving video information from the computer.
	f5	Turns the keyboard backlight on or off (select models only). NOTE: The keyboard backlight is turned on at the factory. To extend battery life, turn off the keyboard backlight.
	f6	Plays the previous track of an audio CD or the previous section of a DVD or a BD.
	f7	Plays, pauses, or resumes a track of an audio CD or a section of a DVD or a BD.
	f8	Plays the next track of an audio CD or the next section of a DVD or a BD.

Icon	Key	Description
	f9	Decreases speaker volume incrementally as long as you hold down the key.
	f10	Increases speaker volume incrementally as long as you hold down the key.
	f11	Mutes or restores speaker sound.
	f12	Turns the wireless feature on or off.

NOTE: A wireless network must be set up before a wireless connection is possible.

Using the hotkeys

A hotkey is a combination of the **fn** key (1), and either the **esc** key (2) or the **b** key (3).

To use a hotkey:

- ▲ Briefly press the **fn** key, and then briefly press the second key of the hotkey combination.

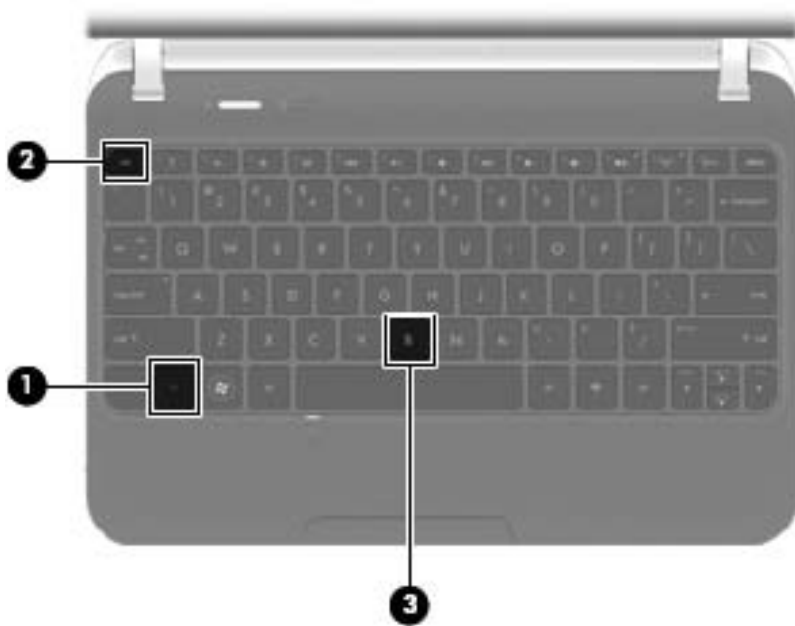

Function	Hotkey	Description
Display system information.	fn+esc	Displays information about system hardware components and the system BIOS version number.
Control the bass settings (select models only).	fn+b	<p>Enables or disables the Beats Audio bass settings (select models only).</p> <p>Beats Audio is an enhanced audio profile that provides a deep, controlled bass while maintaining a clear sound. Beats Audio is enabled by default.</p> <p>You can also view and control the bass settings through the Windows operating system. To view and control the bass properties:</p> <p>Select Start > Control Panel > Hardware and Sound > Beats Audio Control Panel.</p>

6 Multimedia and other features

Your computer includes the following:

- Two integrated speakers and two subwoofers
- Two integrated microphones
- Integrated webcam
- Preinstalled multimedia software
- Multimedia keys

Using the media activity controls

Your computer has media action keys that allow you to play, pause, fast forward, or rewind a media file. Refer to [Using the action keys on page 30](#) for information about your computer's media activity controls.

Audio

Your computer provides a variety of audio-related opportunities:

- Play music.
- Record sound.
- Download music from the Internet.
- Create multimedia presentations.
- Transmit sound and images with instant messaging programs.
- Stream radio programs.
- Create (burn) audio CDs using the installed optical drive (select models only) or on an optional external optical drive (purchased separately).

Adjusting the volume

You can adjust the volume using the volume keys. Refer to [Using the action keys on page 30](#) for more information.

 **WARNING!** To reduce the risk of personal injury, adjust the volume before putting on headphones, earbuds, or a headset. For additional safety information, refer to the *Regulatory, Safety and Environmental Notices*.

 **NOTE:** Volume can also be controlled through the operating system and some programs.

Checking audio functions on the computer

 **NOTE:** For best results when recording, speak directly into the microphone and record sound in a setting free of background noise.

To check the audio functions on your computer, follow these steps:

1. Select **Start > Control Panel > Hardware and Sound > Sound**.
2. When the Sound window opens, click the **Sounds** tab. Under Program Events, select any sound event, such as a beep or alarm, and click the **Test** button.

You should hear sound through the speakers or through connected headphones.

To check the recording functions on your computer, follow these steps:

1. Select **Start > All Programs > Accessories > Sound Recorder**.
2. Click **Start Recording** and speak into the microphone. Save the file to your desktop.
3. Open a multimedia program and play back the sound.

To confirm or change the audio settings on your computer, select **Start > Control Panel > Hardware and Sound > Sound**.

Intel Wireless Display

Intel® Wireless Display allows you to share your computer content wirelessly on your TV. To experience wireless display, a wireless third-party TV adapter (purchased separately) is required. Content that asserts output protection, such as Blu-ray discs, will not play on Intel Wireless Display. For details about using the wireless adapter, refer to the device manufacturer's instructions.

 **NOTE:** Be sure that wireless is enabled on your computer before using the wireless display.

 **NOTE:** Intel Wireless Display does not support 3D playback on external display devices.

Using Beats Audio (select models only)

Beats Audio is an enhanced audio profile that provides a deep, controlled bass while maintaining a clear sound. Beats Audio is enabled by default.



To enable or disable the Beats Audio bass settings:

- Press **fn+b**.

– or –

- Select **Start > Control Panel > Hardware and Sound > Beats Audio Control Panel**.

The following table shows and describes the Beats Audio icons.

Icon	Description
	Beats Audio is enabled.
	Beats Audio is disabled.

Webcam

Your computer includes an integrated webcam, located at the top of the display. With the preinstalled software, you can use the webcam to take a photo or record a video. You can preview and save the photo or video recording.

The webcam software enables you to experiment with the following features:

- Capturing and sharing video
- Streaming video with instant message software
- Taking still photos

To access the webcam, select **Start > All Programs > Communication and Chat > CyberLink YouCam**.

For information on using the webcam, select **Start > Help and Support**.

Video

Your computer has the following external video ports:

- VGA
- HDMI

VGA

The external monitor port, or VGA port, is an analog display interface that connects an external VGA display device such as an external VGA monitor or a VGA projector to the computer.

- ▲ To connect a VGA display device, connect the device cable to the external monitor port.

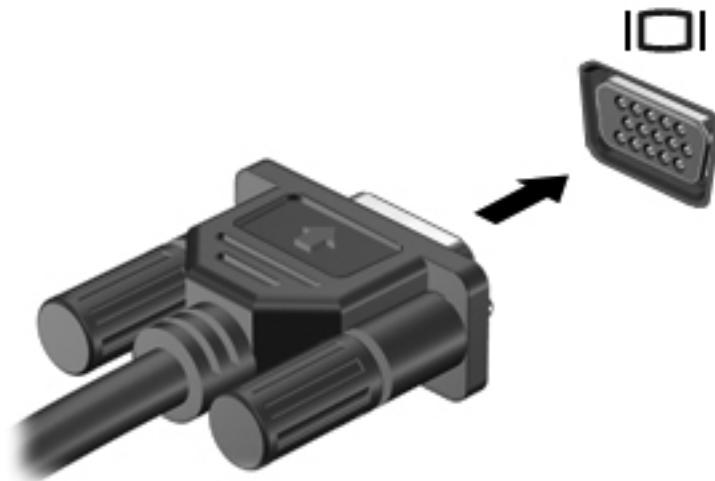

 **NOTE:** For more information on switching the screen image, refer to [Using the action keys on page 30](#).

HDMI

The HDMI (High Definition Multimedia Interface) port connects the computer to an optional video or audio device, such as a high-definition television, or to any compatible digital or audio component.

 **NOTE:** To transmit video and/or audio signals through the HDMI port, you need an HDMI cable (purchased separately).

One HDMI device can be connected to the HDMI port on the computer. The information displayed on the computer screen can be simultaneously displayed on the HDMI device.

To connect a video or audio device to the HDMI port:

1. Connect one end of the HDMI cable to the HDMI port on the computer.

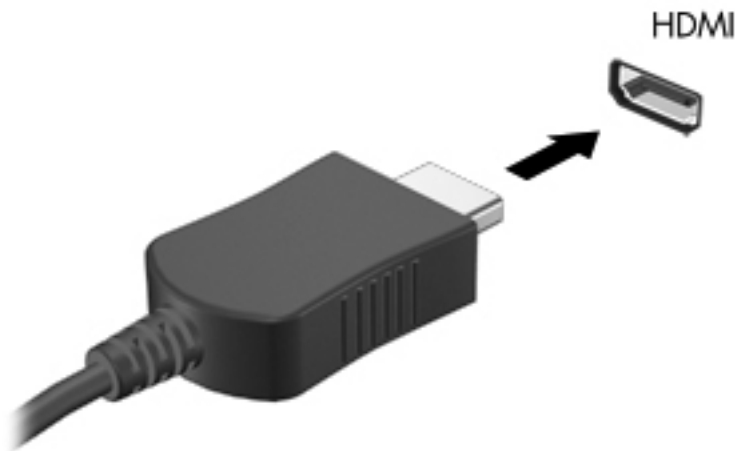

2. Connect the other end of the cable to the video device, and then refer to the device manufacturer's instructions for additional information.

 **NOTE:** For more information on switching the screen image, refer to [Using the action keys on page 30](#).

Configuring audio for HDMI

To configure HDMI audio, first connect an audio or video device, such as a high-definition TV, to the HDMI port on your computer. Then configure the default audio playback device as follows:

1. Right-click the **Speakers** icon in the notification area, at the far right of the taskbar, and then click **Playback devices**.
2. On the Playback tab, click either **Digital Output** or **Digital Output Device (HDMI)**.
3. Click **Set Default**, and then click **OK**.

To return audio to the computer speakers, follow these steps:

1. Right-click the **Speakers** icon in the notification area, at the far right of the taskbar, and then click **Playback devices**.
2. On the Playback tab, click **Speakers**.
3. Click **Set Default**, and then click **OK**.

Using CyberLink PowerDVD (select models only)

CyberLink PowerDVD turns your computer into a mobile entertainment center. With CyberLink PowerDVD, you can enjoy music CDs and DVD and Blu-ray Disc (BD) movies. You can also manage and edit your photo collections.

- ▲ To start CyberLink PowerDVD, select **Start > All Programs > Music, Photos and Videos**, and then click **CyberLink PowerDVD 10**.

For more information on using CyberLink PowerDVD, refer to the PowerDVD software Help.

7 Power management

Inserting or removing the battery

 **NOTE:** For additional information on using the battery, refer to [Using battery power on page 45](#).

Inserting the battery

1. Turn the computer upside down on a flat surface, with the battery bay toward you.
2. Align the battery (1) with the outer edge of the battery bay, and then rotate the battery into the battery bay (2) until it is firmly seated.

The battery release latch automatically locks the battery into place.

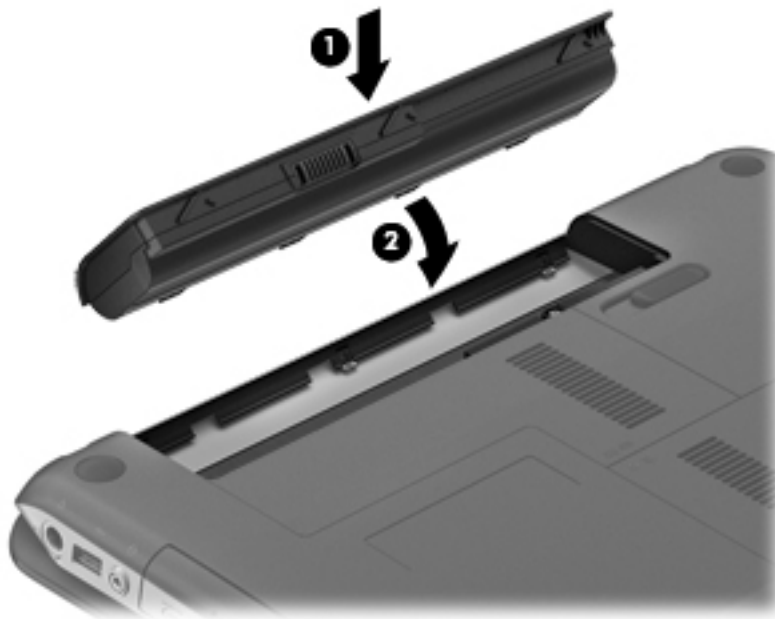

Removing the battery

CAUTION: Removing a battery that is the sole power source for the computer can cause loss of information. To prevent loss of information, save your work and initiate Hibernation or shut down the computer through Windows before removing the battery.

1. Turn the computer upside down on a flat surface.
2. Slide the battery release latch **(1)** to release the battery.

NOTE: The battery release latch automatically returns to its original position.

3. Pivot the battery **(2)** upward and remove it from the computer.

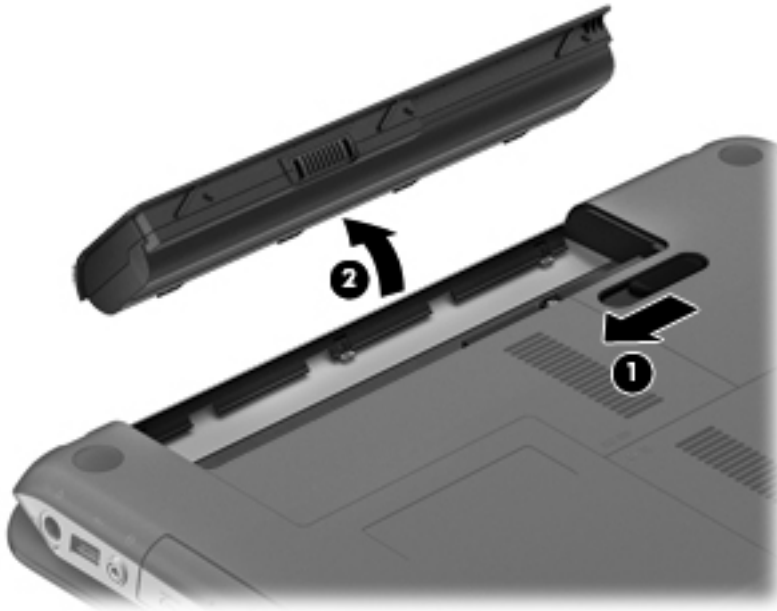

Shutting down the computer

 **CAUTION:** Unsaved information is lost when the computer shuts down.

The Shut down command closes all open programs, including the operating system, and then turns off the display and computer.

Shut down the computer under any of the following conditions:

- When you need to replace the battery or access components inside the computer
- When the computer will be unused and disconnected from external power for an extended period

Although you can shut down the computer with the power button, the recommended procedure is to use the Windows Shut down command:

 **NOTE:** If the computer is in the Sleep state or in Hibernation, you must first exit Sleep or Hibernation before shutdown is possible.

1. Save your work and close all open programs.
2. Select **Start > Shut down**.

If the computer is unresponsive and you are unable to use the preceding shutdown procedures, try the following emergency procedures in the sequence provided:

- Press **ctrl+alt+delete**, and then click the **Power** button.
- Press and hold the power button for at least 5 seconds.
- Disconnect the computer from external power and remove the battery.

Setting power options

Using power-saving states

The computer has two power-saving states that are enabled at the factory: Sleep and Hibernation.

When Sleep is initiated, the power lights blink and the screen clears. Your work is saved to memory, letting you exit Sleep faster than exiting Hibernation. If the computer is in the Sleep state for an extended period or if the battery reaches a critical battery level while in the Sleep state, the computer initiates Hibernation.

When Hibernation is initiated, your work is saved to a hibernation file on the hard drive and the computer turns off.

 **CAUTION:** To reduce the risk of possible audio and video degradation, loss of audio or video playback functionality, or loss of information, do not initiate Sleep or Hibernation while reading from or writing to a disc or an external media card.

 **NOTE:** You cannot initiate any type of networking connection or perform any computer functions while the computer is in the Sleep state or in Hibernation.

Initiating and exiting Sleep

The system is set at the factory to initiate Sleep after a period of inactivity when running on battery power or on external power.

Power settings and timeouts can be changed using Power Options in Windows® Control Panel.

With the computer on, you can initiate Sleep in any of the following ways:

- Briefly press the power button.
- Close the display.
- Select **Start**, click the arrow next to the Shut down button, and then click **Sleep**.

To exit Sleep:

- Briefly press the power button.
- If the display is closed, open the display.
- Press a key on the keyboard.
- Tap or swipe the TouchPad.

When the computer exits Sleep, the power lights turn on and your work returns to the screen where you stopped working.



NOTE: If you have set a password to be required on wakeup, you must enter your Windows password before your work will return to the screen.

Initiating and exiting Hibernation

The system is set at the factory to initiate Hibernation after a period of inactivity when running on battery power or on external power, or when the battery reaches a critical battery level.

Power settings and timeouts can be changed in Windows Control Panel.

To initiate Hibernation:

- ▲ Select **Start**, click the arrow next to the Shut down button, and then click **Hibernate**.

To exit Hibernation:

- ▲ Briefly press the power button.

The power lights turn on and your work returns to the screen where you stopped working.



NOTE: If you have set a password to be required on wakeup, you must enter your Windows password before your work will return to the screen.

Using the power meter

The power meter is located in the notification area, at the far right of the taskbar. The power meter allows you to quickly access power settings and view the remaining battery charge.

- To display the percentage of remaining battery charge and the current power plan, move the pointer over the power meter icon.
- To access Power Options, or to change the power plan, click the power meter icon and select an item from the list.

Different power meter icons indicate whether the computer is running on battery or external power. The icon also displays a message if the battery has reached a low or critical battery level.

Using power plans

A power plan is a collection of system settings that manages how the computer uses power. Power plans can help you conserve power or maximize performance.

Viewing the current power plan

Use any of the following methods:

- Click the power meter icon in the notification area, at the far right of the taskbar.
- Select **Start > Control Panel > System and Security > Power Options**.

Selecting a different power plan

Use any of the following methods:

- Click the power meter icon in the notification area, and then select a power plan from the list.
- Select **Start > Control Panel > System and Security > Power Options**, and then select an item from the list.

Customizing power plans

To customize a power plan:

1. Click the power meter icon in the notification area, and then click **More power options**.
– or –
Select **Start > Control Panel > System and Security > Power Options**.
2. Select a power plan, and then click **Change plan settings**.
3. Change the settings as needed.
4. To change additional settings, click **Change advanced power settings** and make your changes.

Setting password protection on wakeup

To set the computer to prompt for a password when the computer exits Sleep or Hibernation, follow these steps:

1. Select **Start > Control Panel > System and Security > Power Options**.
2. In the left pane, click **Require a password on wakeup**.
3. Click **Change Settings that are currently unavailable**.
4. Click **Require a password (recommended)**.



NOTE: If you need to create a user account password or change your current user account password, click **Create or change your user account password**, and then follow the on-screen instructions. If you do not need to create or change a user account password, go to step 5.

5. Click **Save changes**.

Using HP Power Manager (select models only)

Power Manager allows you to select a power plan to optimize your computer's power consumption and battery charge. The following power plans are available:

- Power saver
- HP Recommended
- High performance

To start Power Manager when Windows is running:

- ▲ Select **Start > Control Panel > Hardware and Sound > HP Power Manager**.

Using battery power

When a charged battery is in the computer and the computer is not plugged into external power, the computer runs on battery power. When the computer is plugged into external AC power, the computer runs on AC power.

If the computer contains a charged battery and is running on external AC power, the computer switches to battery power if the AC adapter is disconnected from the computer.

 **NOTE:** When you disconnect AC power, the display brightness is automatically decreased to save battery life. For information on increasing or decreasing display brightness, refer to [Using the action keys on page 30](#).

You can keep a battery in the computer or in storage, depending on how you work. Keeping the battery in the computer whenever the computer is plugged into AC power charges the battery and also protects your work in case of a power outage. However, a battery in the computer slowly discharges when the computer is off and unplugged from external power.

 **WARNING!** To reduce potential safety issues, use only the battery provided with the computer, a replacement battery provided by HP, or a compatible battery purchased from HP.

Computer battery life varies, depending on power management settings, programs running on the computer, display brightness, external devices connected to the computer, and other factors.

Finding battery information

Help and Support provides the following tools and information about the battery:

- Battery Check tool to test battery performance
- Information on calibration, power management, and proper care and storage to maximize battery life
- Information on battery types, specifications, life cycles, and capacity

To access battery information:

- ▲ Select **Start > Help and Support > Learn > Power Plans: Frequently Asked Questions**.

Using Battery Check

Battery Check in Help and Support provides information on the status of the battery installed in the computer.

To run Battery Check:

1. Connect the AC adapter to the computer.

 **NOTE:** The computer must be connected to external power for Battery Check to work properly.

2. Select **Start > Help and Support > Troubleshoot > Power, Thermal and Mechanical**.
3. Click the **Power** tab, and then click **Battery Check**.

Battery Check examines the battery and its cells to see if they are functioning properly, and then reports the results of the examination.

Displaying the remaining battery charge

- ▲ Move the pointer over the power meter icon in the notification area, at the far right of the taskbar.

Maximizing battery discharge time

Battery discharge time varies depending on the features you use while on battery power. Maximum discharge time gradually decreases as the battery storage capacity naturally degrades.

Tips for maximizing battery discharge time:

- Lower the brightness on the display.
- Select the **Power saver** setting in Power Options.
- Remove the battery from the computer when it is not being used or charged.
- Store the battery in a cool, dry location.

Managing low battery levels

The information in this section describes the alerts and system responses set at the factory. Some low-battery alerts and system responses can be changed using Power Options in Windows Control Panel. Preferences set using Power Options do not affect lights.

Identifying low battery levels

When a battery that is the sole power source for the computer reaches a low or critical battery level, the following behavior occurs:

- The battery light (select models only) indicates a low or critical battery level.

 **NOTE:** For additional information about the battery light, refer to [Getting to know your computer on page 4](#).

– or –

- The power meter icon in the notification area shows a low or critical battery notification.

 **NOTE:** For additional information about the power meter, refer to [Using the power meter on page 43](#).

The computer takes the following actions for a critical battery level:

- If Hibernation is enabled and the computer is on or in the Sleep state, the computer initiates Hibernation.
- If Hibernation is disabled and the computer is on or in the Sleep state, the computer remains briefly in the Sleep state, and then shuts down and loses any unsaved information.

Resolving a low battery level

Resolving a low battery level when external power is available

- ▲ Connect one of the following devices:
 - AC adapter
 - Optional docking or expansion device
 - Optional power adapter purchased as an accessory from HP

Resolving a low battery level when a charged battery is available

1. Turn off the computer or initiate Hibernation.
2. Replace the discharged battery with a charged battery.
3. Turn on the computer.

Resolving a low battery level when no power source is available

- Initiate Hibernation.
- Save your work and shut down the computer.

Resolving a low battery level when the computer cannot exit Hibernation

When the computer lacks sufficient power to exit Hibernation, follow these steps:

1. Replace the discharged battery with a charged battery, or connect the AC adapter to the computer and to external power.
2. Exit Hibernation by pressing the power button.

Conserving battery power

- Select low power-use settings through Power Options in Windows Control Panel.
- Turn off wireless and local area network (LAN) connections and exit modem applications when you are not using them.
- Disconnect unused external devices that are not plugged into an external power source.
- Stop, disable, or remove any external media cards that you are not using.
- Decrease screen brightness.
- Before you leave your work, initiate Sleep or Hibernation, or shut down the computer.

Storing a battery

 **CAUTION:** To reduce the risk of damage to a battery, do not expose it to high temperatures for extended periods of time.

If a computer will be unused and unplugged from external power for more than 2 weeks, remove the battery and store it separately.

To prolong the charge of a stored battery, place it in a cool, dry place.

 **NOTE:** A stored battery should be checked every 6 months. If the capacity is less than 50 percent, recharge the battery before returning it to storage.

Calibrate a battery before using it if it has been stored for one month or more.

Disposing of a used battery

 **WARNING!** To reduce the risk of fire or burns, do not disassemble, crush, or puncture; do not short external contacts; do not dispose of in fire or water.

Refer to the *Regulatory, Safety and Environmental Notices* for proper battery disposal.

Replacing the battery

In Windows 7, Battery Check in Help and Support notifies you to replace the battery when an internal cell is not charging properly or when the battery storage capacity has reached a weak condition. If the battery is possibly covered by an HP warranty, instructions include a warranty ID. A message refers you to the HP Web site for more information about ordering a replacement battery.

Using external AC power

 **NOTE:** For information on connecting to AC power, refer to the *Setup Instructions* poster provided in the computer box.

External AC power is supplied through an approved AC adapter or an optional docking or expansion device.

 **WARNING!** To reduce potential safety issues, use only the AC adapter provided with the computer, a replacement AC adapter provided by HP, or a compatible AC adapter purchased from HP.

Connect the computer to external AC power under any of the following conditions:

 **WARNING!** Do not charge the computer battery while you are onboard aircraft.

- When charging or calibrating a battery
- When installing or modifying system software
- When writing information to a CD, a DVD, or a BD (select models only)
- When running Disk Defragmenter
- When performing a backup or recovery

When you connect the computer to external AC power, the following events occur:

- The battery begins to charge.
- If the computer is turned on, the power meter icon in the notification area changes appearance.

When you disconnect external AC power, the following events occur:

- The computer switches to battery power.
- The display brightness is automatically decreased to save battery life.

Testing an AC adapter

Test the AC adapter if the computer exhibits any of the following symptoms when it is connected to AC power:

- The computer does not turn on.
- The display does not turn on.
- The power lights are off.

To test the AC adapter:

1. Shut down the computer.
2. Remove the battery from the computer.
3. Connect the AC adapter to the computer, and then plug it into an AC outlet.
4. Turn on the computer.
 - If the power lights turn *on*, the AC adapter is working properly.
 - If the power lights remain *off*, check the connection from the AC adapter to the computer and the connection from the AC adapter to the AC outlet to make sure the connections are secure.
 - If the connections are secure and the power lights remain *off*, the AC adapter is not functioning and should be replaced.

Contact customer support for information on obtaining a replacement AC power adapter.

Switchable graphics/dual graphics (select models only)

Select computers are equipped with either switchable graphics or dual graphics.

- Switchable graphics—Supported by both AMD and Intel. If your computer has switchable graphics, it offers both fixed and dynamic schemes.
- Dual graphics—Supported only by AMD. If your computer has AMD dual graphics, it is based on the dynamic scheme with a specific AMD chipset configuration.

 **NOTE:** To determine if your computer supports switchable graphics or dual graphics, refer to the Power sections within either the Catalyst Control Center (for Intel CPUs) or the AMD VISION Engine Control Center (for AMD CPUs).

Using switchable graphics (select models only)

Switchable graphics are only available with Windows 7 Professional, Windows 7 Home Premium, and Windows 7 Home Basic operating systems.

To manage your switchable graphics settings:

- ▲ Right-click on the desktop, and then select **Configure Switchable Graphics** or **AMD PowerXpress**.

 **NOTE:** Based on power requirements, Individual applications will be assigned to either Performance mode or Power Saving mode. You can manually modify the settings for an individual application by locating the application in the **Recent Applications** drop-down menu, or by clicking **Browse**, located beneath the **Other Applications** drop-down menu.

There are two different modes (Performance and Power Saving) that allow you to switch between different graphic configurations as follows:

- Fixed scheme (manual or triggered by AC/DC power transitions)—Allows you to switch between Performance mode and Power Saving mode. Once the desired mode is selected, all other applications operate in that mode.
- Dynamic scheme (Automatic)—Automatically assigns individual applications to either Performance mode or Power Saving mode, based on GPU rendering requirements. You can also manually modify the settings for an individual application by locating the application in the **Recent Applications** drop-down menu, or by clicking **Browse**, located under the **Other Applications** drop-down menu.

 **NOTE:** Switchable graphics are only available with Windows 7 Professional, Windows 7 Home Premium, and Windows 7 Home Basic operating systems.

 **NOTE:** There may be some instances when you may not be allowed to switch modes. In other instances, you may be prompted to switch modes. You may also be required to close all applications before switching. For more information, refer to the switchable graphics software Help.

Using dual graphics (select models only)

If your system is equipped with dual graphics (two or more added Graphics Processing Units (GPUs)), you can enable AMD Crossfire™ to increase application power and performance for fullscreen applications that use DirectX version 10 or 11. For more information about DirectX, refer to <http://www.microsoft.com/directx>.



NOTE: Dual graphics systems only support automatic selection based on power requirements, and automatically assign Performance mode or Power Saving mode for individual applications. However, you can manually modify the settings for a particular application.

To enable or disable AMD Crossfire™, select or deselect the check box in the AMD Crossfire™ section, which is located in the **Performance** tab in the Catalyst Control Center.



NOTE: For more information, refer to the AMD software Help.

Refreshing your software content (select models only)

When the computer is in the Sleep state, Intel® Smart Connect Technology periodically causes the computer to exit Sleep. Smart Connect then updates the content for certain open applications and reinitiates Sleep. As a result, your work is immediately available to you as soon as you exit Sleep. You do not have to wait while updates are downloaded and installed.

- ▲ To open Intel Smart Connect to disable this feature or manually adjust the settings, select **Start > All Programs > Intel > Intel Smart Connect Technology**.

For additional information and a list of supported applications, see the software Help.

8 External cards and devices

Using Digital Media Slot cards (select models only)

Optional digital cards provide secure data storage and convenient data sharing. These cards are often used with digital media–equipped cameras and PDAs as well as with other computers.

To determine the digital card formats that are supported on your computer, refer to [Front on page 9](#).

Inserting a digital card

⚠ CAUTION: To reduce the risk of damage to the digital card connectors, use minimal force to insert a digital card.

1. Hold the card label-side up, with the connectors facing the computer.
2. Insert the card into the Digital Media Slot, and then press in on the card until it is firmly seated.

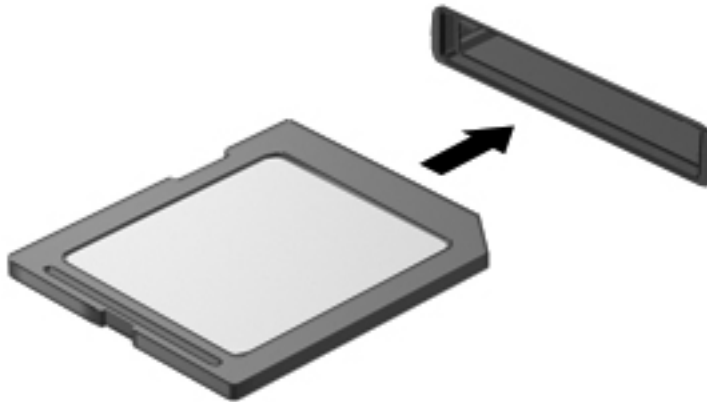

You will hear a sound when the device has been detected, and a menu of options may be displayed.

Removing a digital card

CAUTION: To reduce the risk of loss of data or an unresponsive system, use the following procedure to safely remove the digital card.

1. Save your information and close all programs associated with the digital card.
2. Click the remove hardware icon in the notification area, at the far right of the taskbar. Then follow the on-screen instructions.
3. Press in on the card (1), and then remove it from the slot (2).

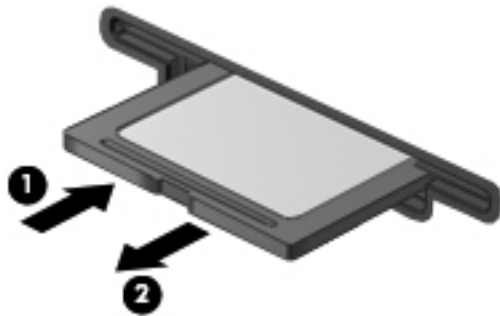

NOTE: If the card does not eject, pull the card out of the slot.

Using a USB device

Universal Serial Bus (USB) is a hardware interface that can be used to connect an optional external device, such as a USB keyboard, mouse, drive, printer, scanner, or hub.

Some USB devices may require additional support software, which is usually included with the device. For more information about device-specific software, refer to the manufacturer's instructions. These instructions may be provided with the software, on disc, or on the manufacturer's Web site.

Your computer has 3 USB ports that support USB 1.0 and 2.0 devices.

NOTE: Depending on your computer model, your computer may be equipped with 2 USB 3.0 ports, which connect optional USB 3.0 devices and provide enhanced USB power performance. USB 3.0 ports are also compatible with USB 1.0 and 2.0 devices.

An optional docking device or USB hub provides additional USB ports that can be used with the computer.

Connecting a USB device

CAUTION: To reduce the risk of damage to a USB connector, use minimal force to connect the device.

- ▲ Connect the USB cable for the device to the USB port.

NOTE: The USB port on your computer may look slightly different from the illustration in this section.



You will hear a sound when the device has been detected.

NOTE: The first time you connect a USB device, a message in the notification area lets you know that the device is recognized by the computer.

Removing a USB device

CAUTION: To reduce the risk of damage to a USB connector, do not pull on the cable to remove the USB device.

CAUTION: To reduce the risk of loss of information or an unresponsive system, use the following procedure to safely remove the USB device.

1. To remove a USB device, save your information and close all programs associated with the device.
2. Click the remove hardware icon in the notification area, at the far right of the taskbar, and then follow the on-screen instructions.
3. Remove the device.

Using optional external devices



NOTE: For more information about required software and drivers, or to learn which computer port to use, refer to the manufacturer's instructions.

To connect an external device to the computer:



CAUTION: To reduce the risk of damage to the equipment when connecting a powered device, be sure that the device is turned off and the AC power cord is unplugged.

1. Connect the device to the computer.
2. If you are connecting a powered device, plug the device power cord into a grounded AC outlet.
3. Turn on the device.

To disconnect an unpowered external device, turn off the device, and then disconnect it from the computer. To disconnect a powered external device, turn off the device, disconnect it from the computer, and then unplug the AC power cord.

Using optional external drives

Removable external drives expand your options for storing and accessing information. A USB drive can be added by connecting the drive to a USB port on the computer.

USB drives include the following types:

- 1.44-megabyte diskette drive
- Hard drive module (a hard drive with an adapter attached)
- External optical drive (CD, DVD, and Blu-ray)
- MultiBay device

9 Drives

Handling drives

 **CAUTION:** Drives are fragile computer components that must be handled with care. Refer to the following cautions before handling drives. Additional cautions are included with the procedures to which they apply.

Observe these precautions:

- Before you move a computer that is connected to an external hard drive, initiate Sleep and allow the screen to clear, or properly disconnect the external hard drive.
- Before handling a drive, discharge static electricity by touching the unpainted metal surface of the drive.
- Do not touch the connector pins on a removable drive or on the computer.
- Handle a drive carefully; do not drop a drive or place items on it.
- Before removing or inserting a drive, shut down the computer. If you are unsure whether the computer is off, in the Sleep state, or in Hibernation, turn the computer on, and then shut it down through the operating system.
- Do not use excessive force when inserting a drive into a drive bay.
- Do not type on the keyboard or move the computer while an optical drive is writing to a disc. The write process is sensitive to vibration.
- When the battery is the only source of power, be sure that the battery is sufficiently charged before writing to media.
- Avoid exposing a drive to temperature or humidity extremes.
- Avoid exposing a drive to liquids. Do not spray the drive with cleaning products.
- Remove media from a drive before removing the drive from the drive bay, or traveling with, shipping, or storing a drive.
- If a drive must be mailed, place the drive in a bubble-pack mailer or other suitable protective packaging and label the package “FRAGILE.”
- Avoid exposing a drive to magnetic fields. Security devices with magnetic fields include airport walk-through devices and security wands. Airport conveyer belts and similar security devices that check carry-on baggage use X-rays instead of magnetism and do not damage drives.

Using hard drives

Improving hard drive performance

Using Disk Defragmenter

As you use the computer, files on the hard drive become fragmented. Disk Defragmenter consolidates the fragmented files and folders on the hard drive so that the system can run more efficiently.



NOTE: It is not necessary to run Disk Defragmenter on solid-state drives.

After you start Disk Defragmenter, it works without supervision. Depending on the size of your hard drive and the number of fragmented files, Disk Defragmenter may take more than an hour to complete. You may want to set it to run during the night or at another time when you do not need access to your computer.

HP recommends defragmenting your hard drive at least once a month. You may set Disk Defragmenter to run on a monthly schedule, but you can defragment your computer manually at any time.

To run Disk Defragmenter:

1. Connect the computer to AC power.
2. Select **Start > All Programs > Accessories > System Tools > Disk Defragmenter**.
3. Click **Defragment disk**.



NOTE: Windows includes the User Account Control feature to improve the security of your computer. You may be prompted for your permission or password for tasks such as installing software, running utilities, or changing Windows settings. Refer to Help and Support for more information.

For additional information, access the Disk Defragmenter software Help.

Using Disk Cleanup

Disk Cleanup searches the hard drive for unnecessary files that you can safely delete to free up disk space and help the computer to run more efficiently.

To run Disk Cleanup:

1. Select **Start > All Programs > Accessories > System Tools > Disk Cleanup**.
2. Follow the on-screen instructions.

Using HP 3D DriveGuard (select models only)

HP 3D DriveGuard protects a hard drive by parking the drive and halting data requests under either of the following conditions:

- You drop the computer.
- You move the computer with the display closed while the computer is running on battery power.

A short time after the end of one of these events, HP 3D DriveGuard returns the hard drive to normal operation.

 **NOTE:** Because solid-state drives (SSD) lack moving parts, HP 3D DriveGuard is unnecessary.

 **NOTE:** Hard drives in the primary hard drive bay or in the secondary hard drive bay are protected by HP 3D DriveGuard. Hard drives connected to USB ports are not covered by HP 3D DriveGuard.

For more information, refer to the HP 3D DriveGuard software Help.

Identifying HP 3D DriveGuard status

The drive light on the computer changes color to show that a drive in the primary hard drive bay or a drive in the secondary hard drive bay (select models only) is parked. To determine whether drives are currently protected or whether a drive is parked, select **Start > Control Panel > Hardware and Sound > Windows Mobility Center**:

- If HP 3D DriveGuard is enabled, a green check mark is superimposed over the hard drive icon.
- If HP 3D DriveGuard is disabled, a red symbol is superimposed over the hard drive icon.
- If the drives are parked, a yellow moon is superimposed over the hard drive icon.

The icon in the Mobility Center may not show the most up-to-date status for the drive. For immediate updates after a change in status, you need to enable the notification area icon.

To enable the notification area icon:

1. Select **Start > Control Panel > Hardware and Sound > HP 3D DriveGuard**.

 **NOTE:** If prompted by User Account Control, click **Yes**.

2. On the **Icon in System Tray** row, click **Show**.
3. Click **OK**.

Managing power with a parked hard drive

If HP 3D DriveGuard has parked the drive, the computer behaves in the following ways:

- The computer will not shut down.
- The computer will not initiate Sleep or Hibernation, except as described in the following Note.

 **NOTE:** If the computer is running on battery power and reaches a critical battery level, HP 3D DriveGuard allows the computer to initiate Hibernation.

Before you move the computer, HP recommends that you either shut it down or initiate Sleep or Hibernation.

Using HP 3D DriveGuard software

The HP 3D DriveGuard software can be enabled or disabled by an Administrator.

 **NOTE:** Depending on your user privileges, you may be unable to enable or disable HP 3D DriveGuard. Privileges for non-Administrator users can be changed by members of an Administrator group.

To open the software and change settings, follow these steps:

1. In Mobility Center, click the hard drive icon to open the HP 3D DriveGuard window.

– or –

Select **Start > Control Panel > Hardware and Sound > HP 3D DriveGuard**.

 **NOTE:** If prompted by User Account Control, click **Yes**.

2. Click the appropriate button to change settings.
3. Click **OK**.

Adding or replacing a hard drive

⚠ CAUTION: To prevent information loss or an unresponsive system:

Shut down the computer before removing the hard drive from the hard drive bay. Do not remove the hard drive while the computer is on, in the Sleep state, or in Hibernation.

If you are not sure whether the computer is off or in Hibernation, turn the computer on by pressing the power button. Then shut down the computer through the operating system.

Removing the hard drive

1. Save your work and shut down the computer.
2. Disconnect all external devices connected to the computer.
3. Unplug the power cord from the AC outlet.
4. Turn the computer upside down on a flat surface.
5. Remove the battery (refer to [Inserting or removing the battery on page 39](#)).
6. Loosen the screw **(1)** on the memory module compartment cover.
7. Slide the memory module compartment cover backwards **(2)**, and then remove the cover **(3)**.

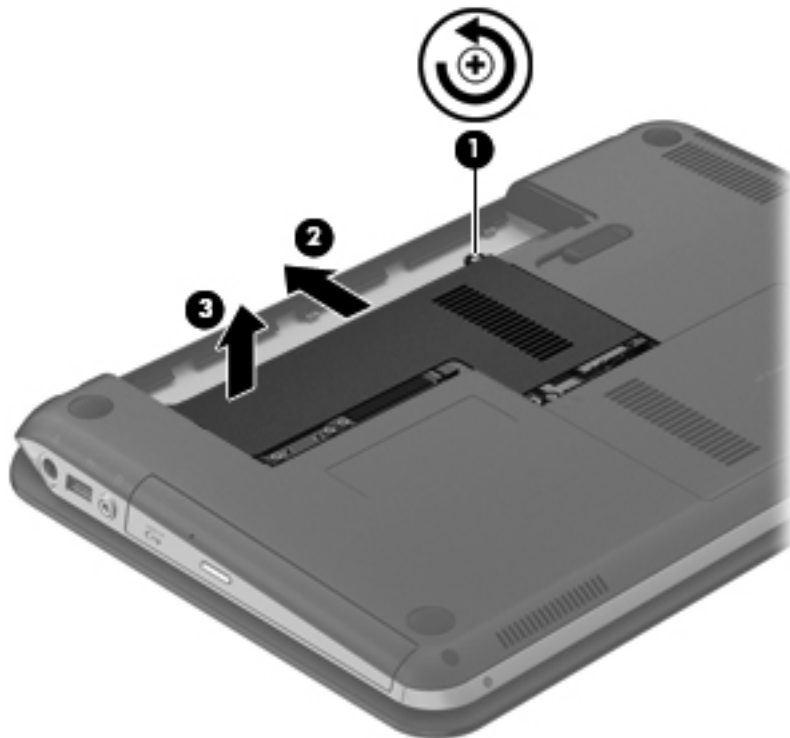

8. Loosen the screw **(1)** on the hard drive service door.

9. Remove the hard drive service door (2).

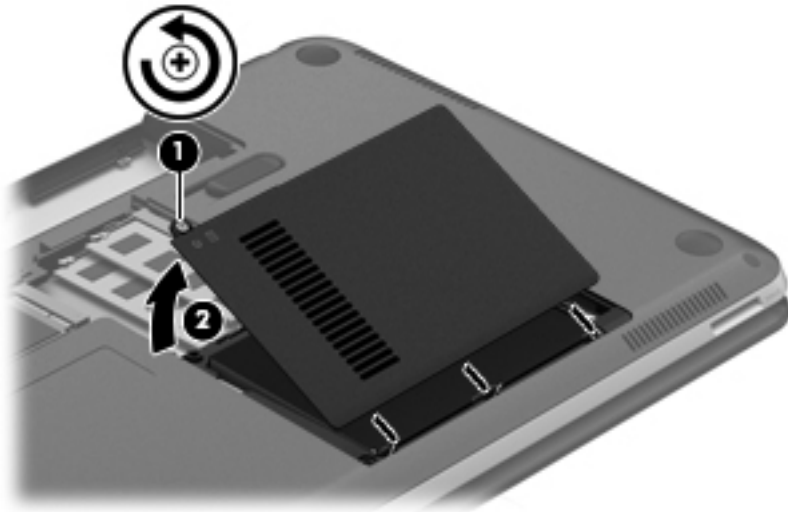

10. Remove the 3 screws securing the hard drive (1), and then pull the hard drive tab (2) to lift the hard drive out of the hard drive bay.
11. Disconnect the hard drive cable (3), and remove the hard drive.

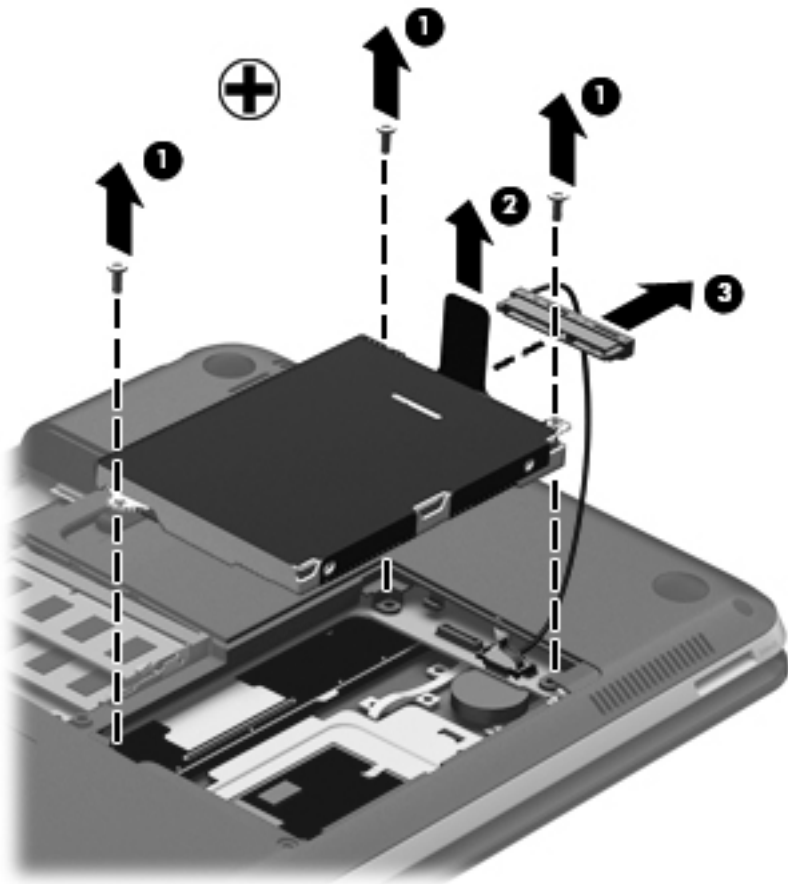

Installing a hard drive

1. Connect the hard drive cable to the hard drive (1), and then insert the hard drive into the hard drive bay (2).
2. Tighten the 3 hard drive screws to secure the drive (3).

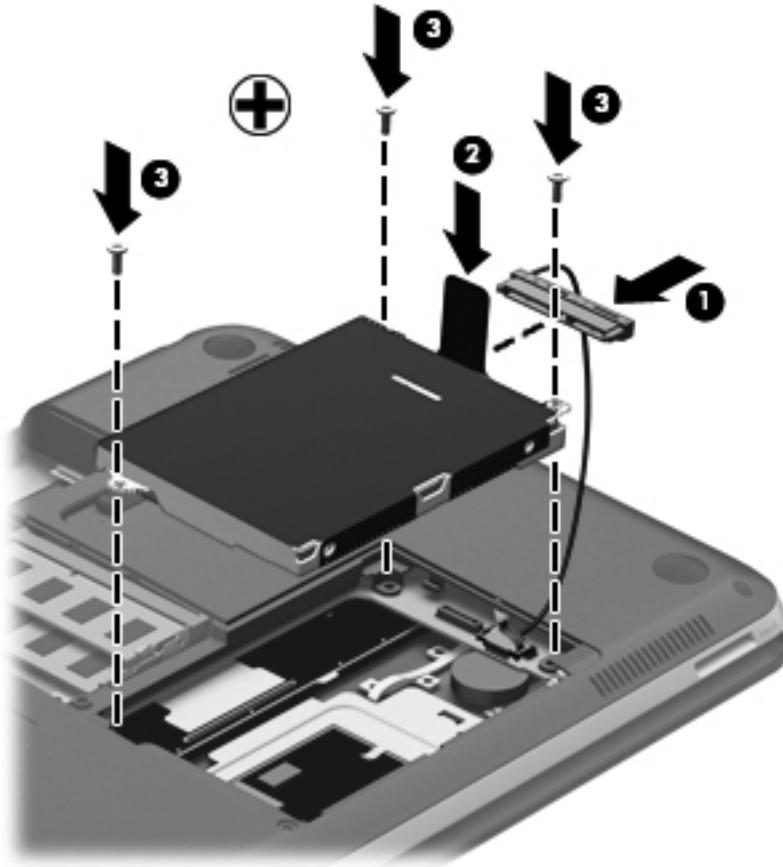

3. Align the tabs (1) on the hard drive service door with the notches on the computer.
4. Close the hard drive service door (2).

5. Tighten the screw **(3)** on the hard drive service door.

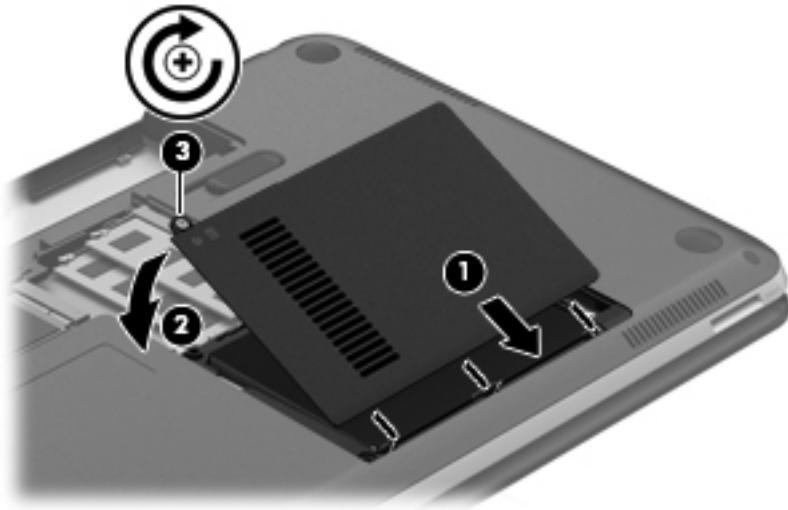

6. Align the tabs **(1)** on the memory module compartment cover with the notches on the computer.
7. Slide the cover forward **(2)**.
8. Tighten the screw **(3)** on the memory module compartment cover.

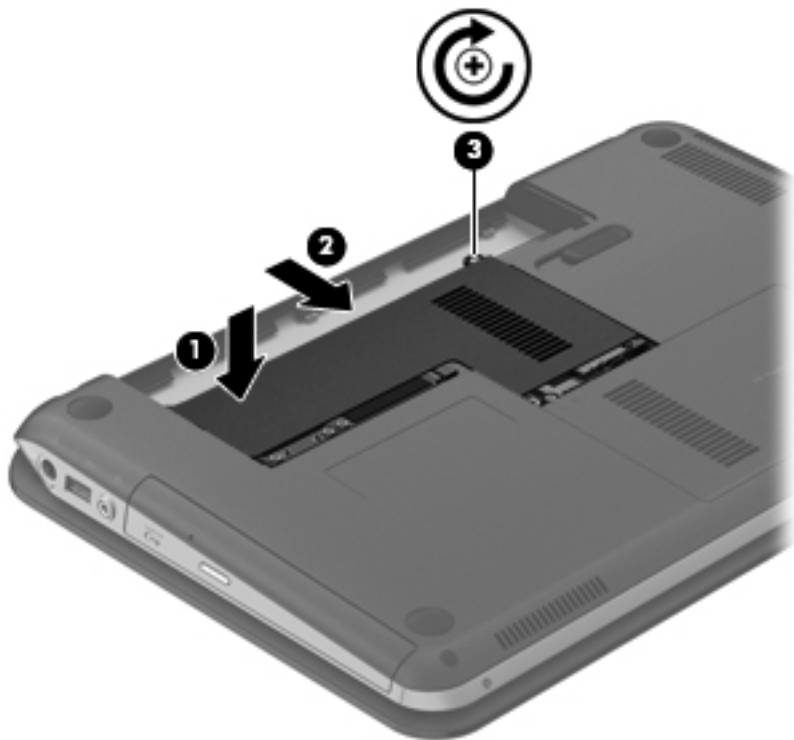

9. Replace the battery.
10. Reconnect external power and external devices.
11. Turn on the computer.

Using optical drives

Optical drives include the following:

- CD
- DVD
- Blu-ray (BD)

Identifying the installed optical drive

▲ Select **Start > Computer**.

A list of all drives installed in your computer, including your optical drive, is displayed.

Inserting an optical disc

1. Turn on the computer.
2. Press the release button (1) on the drive bezel to release the disc tray.
3. Pull out the tray (2).
4. Hold the disc by the edges to avoid touching the flat surfaces and position the disc label-side up over the tray spindle.

 **NOTE:** If the tray is not fully accessible, tilt the disc carefully to position it over the spindle.

5. Gently press the disc (3) down onto the tray spindle until the disc snaps into place.

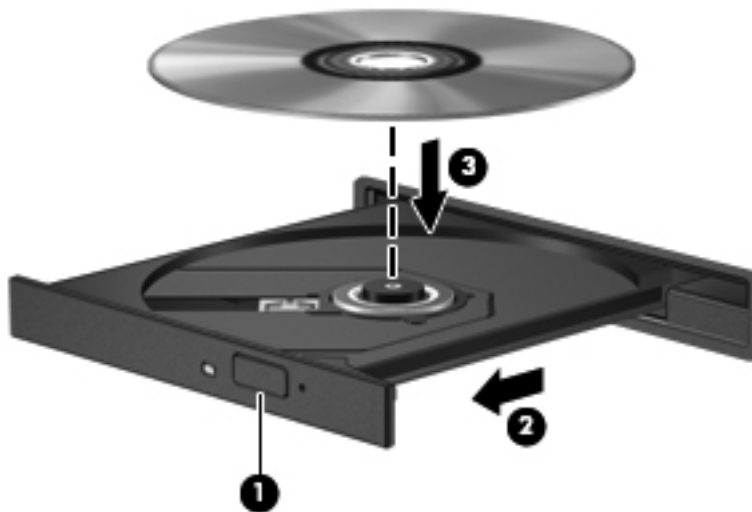

6. Close the disc tray.

 **NOTE:** After you insert a disc, a short pause is normal. If you have not selected a media player, an AutoPlay dialog box opens. It prompts you to select how you want to use the media content.

Removing an optical disc

There are 2 ways to remove a disc, depending on whether the disc tray opens normally or not.

When the disc tray opens normally

1. Press the release button **(1)** on the drive bezel to release the disc tray, and then gently pull out the tray **(2)** until it stops.
2. Remove the disc **(3)** from the tray by gently pressing down on the spindle while lifting the outer edges of the disc. Hold the disc by the edges and avoid touching the flat surfaces.

 **NOTE:** If the tray is not fully accessible, tilt the disc carefully as you remove it.

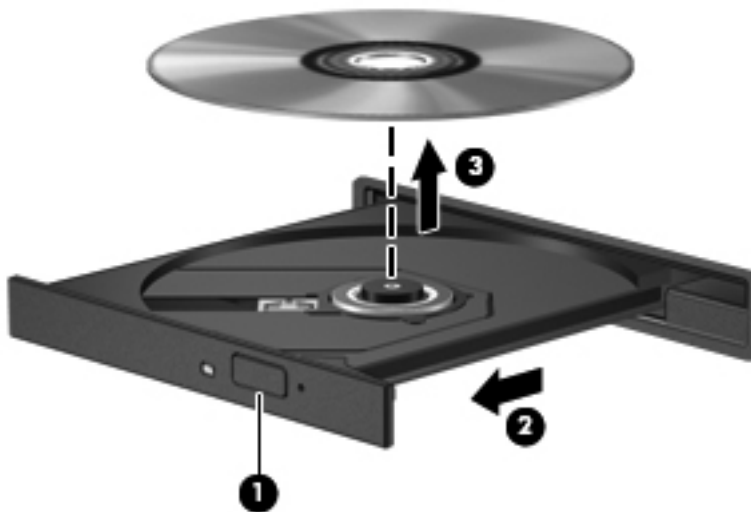

3. Close the disc tray and place the disc in a protective case.

When the disc tray fails to open normally

1. Insert the end of a paper clip (1) into the release access in the front bezel of the drive.
2. Press in gently on the paper clip until the tray is released, and then pull out the tray (2) until it stops.
3. Remove the disc (3) from the tray by gently pressing down on the spindle while lifting the outer edges of the disc. Hold the disc by the edges and avoid touching the flat surfaces.

 **NOTE:** If the tray is not fully accessible, tilt the disc carefully as you remove it.

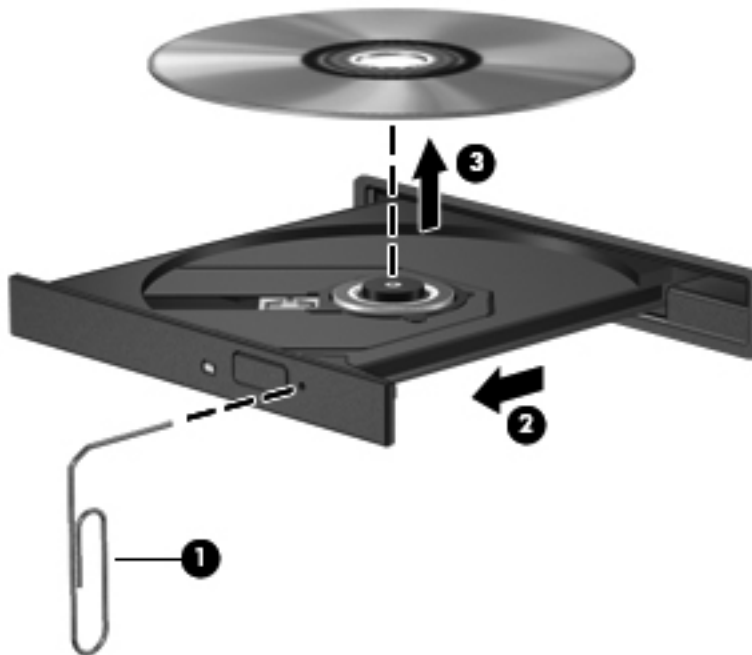

4. Close the disc tray and place the disc in a protective case.

Sharing optical drives

Although your computer may not have an integrated optical drive, you can access software and data, and install applications, by sharing an optical drive connected to another computer in your network. Sharing drives is a feature of the Windows operating system that allows a drive on one computer to be accessible to other computers on the same network.



NOTE: You must have a network set up in order to share an optical drive; refer to [Networking on page 17](#) for additional information on setting up a network.



NOTE: Some discs, such as DVD movies and game discs, may be copy-protected and therefore unusable through DVD or CD drive sharing.

To share an optical drive:

1. From the computer with the optical drive you are sharing, select **Start > Computer**.
2. Right-click the optical drive you want to share, and click **Properties**.
3. Select the **Sharing** tab > **Advanced Sharing**.
4. Select the **Share this folder** check box.
5. Type a name for the optical drive in the Share name text box.
6. Click **Apply**, and then click **OK**.
7. To view the shared optical drive:

Select **Start > Control Panel > Network and Internet > Network and Sharing Center**.

10 Memory modules

Adding or replacing memory modules

The computer has two memory module slots. The capacity of the computer can be upgraded by adding a memory module to the vacant expansion memory module slot or by upgrading the existing memory module in the primary memory module slot.

 **WARNING!** To reduce the risk of electric shock and damage to the equipment, unplug the power cord and remove all batteries before installing a memory module.

 **CAUTION:** Electrostatic discharge (ESD) can damage electronic components. Before beginning any procedure, ensure that you are discharged of static electricity by touching a grounded metal object.

 **NOTE:** To use a dual-channel configuration with a second memory module, be sure that both memory modules are identical.

To add or replace a memory module:

 **CAUTION:** To prevent information loss or an unresponsive system:

Shut down the computer before adding or replacing memory modules. Do not remove a memory module while the computer is on, in the Sleep state, or in Hibernation.

If you are not sure whether the computer is off or in Hibernation, turn the computer on by pressing the power button. Then shut down the computer through the operating system.

1. Save your work and shut down the computer.
2. Disconnect all external devices connected to the computer.
3. Unplug the power cord from the AC outlet and remove the battery.
4. Loosen the screw **(1)** on the memory module compartment cover.

5. Slide the cover backwards (2), and then remove the cover (3).

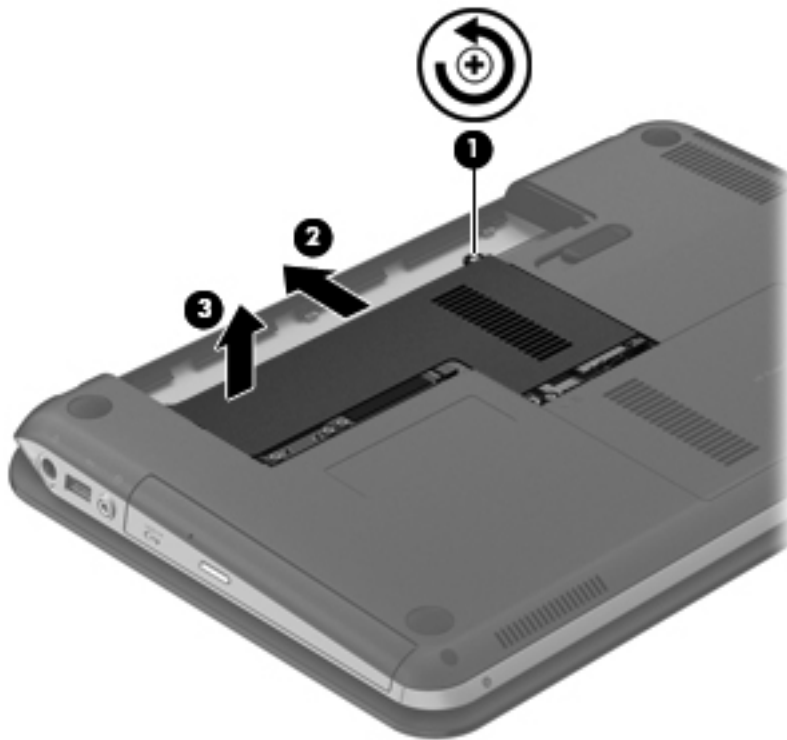

6. If you are replacing a memory module, remove the existing memory module:
 - a. Pull away the retention clips (1) on each side of the memory module. The memory module tilts up.

- b. Grasp the edge of the memory module **(2)**, and then gently pull the memory module out of the memory module slot.

⚠ CAUTION: To prevent damage to the memory module, hold the memory module by the edges only. Do not touch the components on the memory module.

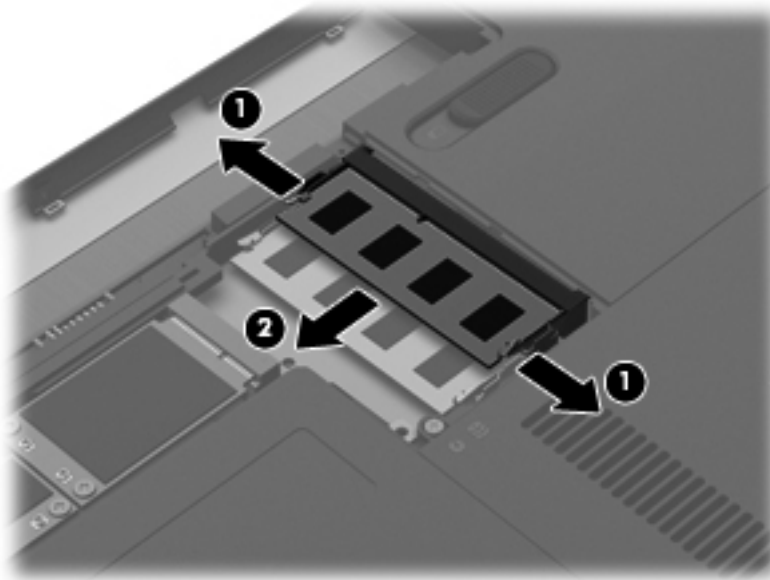

To protect a memory module after removal, place it in an electrostatic-safe container.

7. Insert a new memory module:

⚠ CAUTION: To prevent damage to the memory module, hold the memory module by the edges only. Do not touch the components on the memory module.

- a. Align the notched edge **(1)** of the memory module with the tab in the memory module slot.
- b. With the memory module at a 45-degree angle from the surface of the memory module compartment, press the module into the memory module slot **(2)** until it is seated.

- c. Gently press the memory module **(3)** down, applying pressure to both the left and right edges of the module, until the retention clips snap into place.

⚠ CAUTION: To prevent damage to the memory module, be sure that you do not bend the module.

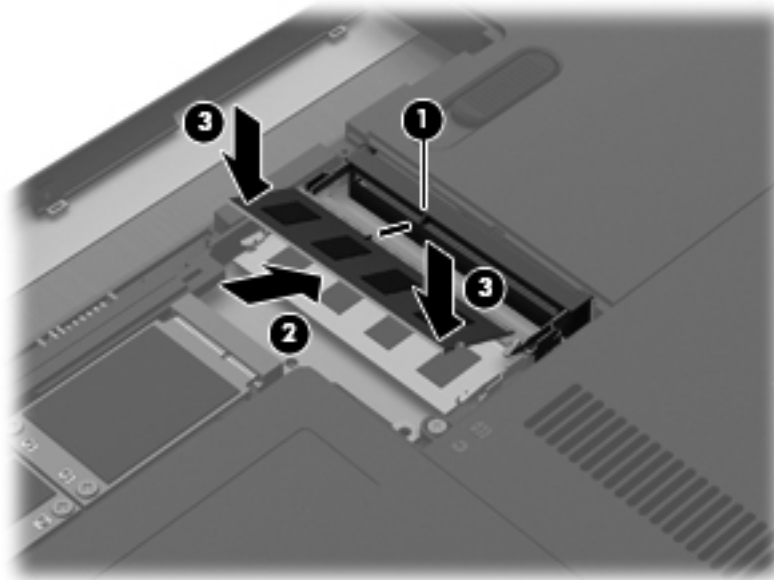

8. Align the tabs **(1)** on the memory module compartment cover with the notches on the computer.
9. Close the cover **(2)**.
10. Tighten the screw **(3)** on the memory module compartment cover.

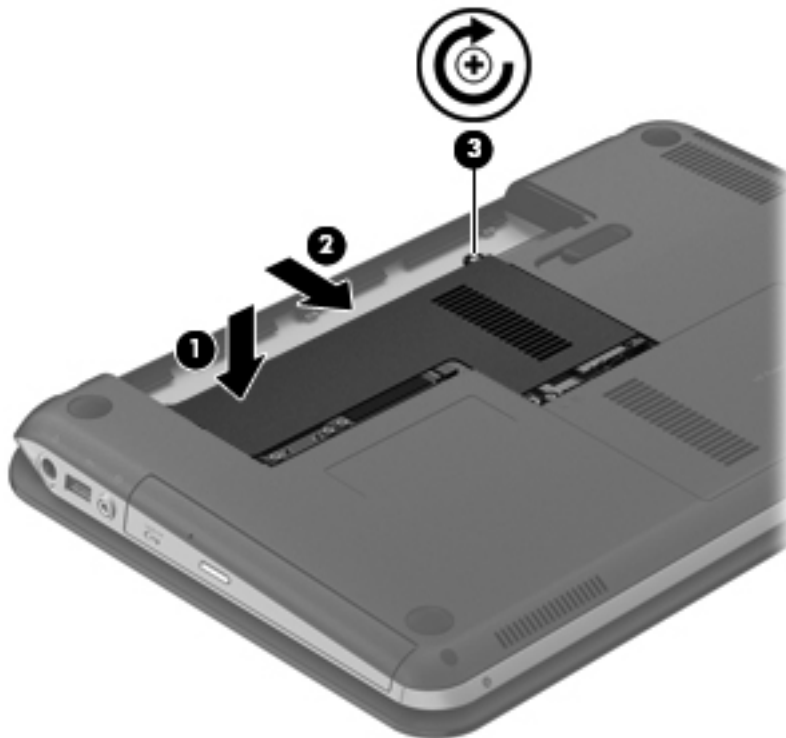

11. Replace the battery.
12. Reconnect external power and external devices.
13. Turn on the computer.

11 Securing your computer and information

Computer security is essential for protecting the confidentiality, integrity, and availability of your information. Standard security solutions provided by the Windows® operating system, HP applications, the non-Windows Setup Utility (BIOS), and other third-party software can help protect your computer from a variety of risks, such as viruses, worms, and other types of malicious code.



IMPORTANT: Some security features listed in this chapter may not be available on your computer.

Computer risk	Security feature
Unauthorized use of the computer	<ul style="list-style-type: none">• Power-on password• Fingerprint reader
Computer viruses	Antivirus software
Unauthorized access to data	Firewall software
Unauthorized access to Setup Utility (BIOS) settings and other system identification information	Administrator password
Ongoing or future threats to the computer	Software updates
Unauthorized access to a Windows user account	User password
Unauthorized removal of the computer	Security cable lock

Locating your security software (select models only)

HP Security Assistant provides a starting location for you to quickly access a collection of security software applications that are organized by task. Instead of searching for each application through the Start menu and Control Panel, HP Security Assistant allows you to access the applications for the following security tasks:

- Set up Internet and anti-virus security
- Back up and recover files
- Manage passwords, user accounts, and parental controls
- Maintain your computer and install the latest HP and Windows updates
- Set up the fingerprint reader (select models only)

To open HP Security Assistant, select **Start > All Programs > Security and Protection > HP Security Assistant**.

Using passwords

A password is a group of characters that you choose to secure your computer information and to have safer online transactions. Several types of passwords can be set. For example, when you set up your computer for the first time, you were asked to set up a user password to secure your computer. Additional passwords can be set in Windows or in the HP Setup Utility (BIOS) that is preinstalled on your computer.

You may find it helpful to use the same password for a Setup Utility (BIOS) feature and for a Windows security feature.

Use the following tips for creating and saving passwords:

- To reduce the risk of being locked out of the computer, record each password and store it in a secure place away from the computer. Do not store passwords in a file on the computer.
- When creating passwords, follow requirements set by the program.
- Change your passwords at least every three months.
- An ideal password is long and has letters, punctuation, symbols, and numbers.
- Before you send your computer for service, back up your files, delete confidential files, and then remove all password settings.

For additional information about Windows passwords, such as screen-saver passwords, select **Start > Help and Support**.

Setting Windows passwords

Password	Function
User password	Protects access to a Windows user account. It also must be entered when you exit Sleep or Hibernation.
Administrator password	Protects administrator-level access to computer contents. NOTE: This password cannot be used to access Setup Utility (BIOS) contents.

Setting passwords in Setup Utility (BIOS)

Password	Function
Administrator password*	<ul style="list-style-type: none">• Must be entered each time you access Setup Utility (BIOS).• If you forget your administrator password, you cannot access Setup Utility (BIOS). <p>NOTE: The administrator password can be used in place of the power-on password.</p> <p>NOTE: Your administrator password is not interchangeable with an administrator password set in Windows, nor is it displayed as it is set, entered, changed, or deleted.</p> <p>NOTE: If you enter the power-on password at the first password check before the “Press the ESC key for Startup Menu” message is displayed, you must enter the administrator password to access Setup Utility (BIOS).</p>
Power-on password*	<ul style="list-style-type: none">• Must be entered each time you turn on or restart the computer, or exit Hibernation.• If you forget your power-on password, you cannot turn on or restart the computer, or exit Hibernation. <p>NOTE: The administrator password can be used in place of the power-on password.</p> <p>NOTE: A power-on password is not displayed as it is set, entered, changed, or deleted.</p>

To set, change, or delete an administrator or power-on password in Setup Utility (BIOS):

1. Open Setup Utility (BIOS) by turning on or restarting the computer. While the “Press the ESC key for Startup Menu” message is displayed in the lower-left corner of the screen, press **esc**.
2. Use the arrow keys and follow the on-screen instructions. When the Startup Menu is displayed, press **f10**.
3. Use the arrow keys to select **Security**, and then follow the on-screen instructions.

Your changes take effect when the computer restarts.

Using the fingerprint reader

Integrated fingerprint readers are available on select computer models. In order to use the fingerprint reader, you must set up a user account and password on the computer. This account allows you to log on to your computer with a swipe of a designated finger. You may also use the fingerprint reader to fill in password fields on Web sites and other programs that require a logon. For instructions, see the fingerprint reader software Help.

After you register your computer, you can set up a single sign-on service that allows you to use your fingerprint reader to create credentials for any application that requires a user name and password.

For the location of the fingerprint reader on your computer, see “Getting to know your computer.”

Registering fingerprints

A Fingerprint Reader allows you to log on to Windows using a fingerprint that you have registered using HP SimplePass software, instead of using a Windows password.

To register one or more fingerprints:

1. Select **Start > Security and Protection > HP SimplePass**.
2. **Have you found your fingerprint sensor?**—Click **Yes**.
3. **Are you ready to enroll?**—Click **Yes**.
4. Select a finger.
5. **Create Windows password**—Enter your password and confirm your password.
6. Swipe your finger 3 times. The finger displays green if it is registered successfully. Otherwise, a warning message is displayed.
7. Select another finger or click > to continue.
8. Click **Register now** or **Register later**.
9. Click **Advanced** to launch a selected website when you swipe your registered finger.

Repeat steps 1 through 9 for each additional user.

Using your registered fingerprint to log on to Windows

To log on to Windows using your fingerprint:

1. After you register your fingerprints, restart Windows.
2. Swipe any of your registered fingers to log on to Windows.

Using Internet security software

When you use your computer to access email, a network, or the Internet, you potentially expose your computer to computer viruses, spyware, and other online threats. To help protect your computer, Internet security software that includes antivirus and firewall features may be preinstalled on your computer as a trial offer. To provide ongoing protection against newly discovered viruses and other security risks, security software must be kept up to date. It is strongly recommended that you upgrade the security software trial offer or purchase the software of your choice in order to fully protect your computer.

Using antivirus software

Computer viruses can disable programs, utilities, or the operating system, or cause them to function abnormally. Antivirus software can detect most viruses, destroy them, and in most cases, repair any damage they have caused.

For more information about computer viruses, type `viruses` in the Search box in Help and Support.

Using firewall software

Firewalls are designed to prevent unauthorized access to a system or network. A firewall can be software you install on your computer and/or network, or it can be a combination of both hardware and software.

There are two types of firewalls to consider:

- Host-based firewalls—Software that protects only the computer it is installed on.
- Network-based firewalls—Installed between your DSL or cable modem and your home network to protect all the computers on the network.

When a firewall is installed on a system, all data sent to and from the system is monitored and compared with a set of user-defined security criteria. Any data that does not meet those criteria is blocked.

Installing software updates

HP, Microsoft Windows, and third-party software installed on your computer should be regularly updated to correct security problems and improve software performance.

Installing Windows security updates

Updates to the operating system and other software may have become available after the computer left the factory. Microsoft® sends out alerts regarding critical updates. To protect the computer from security breaches and computer viruses, install all critical updates from Microsoft as soon as you receive an alert.

To be sure that all available updates are installed on the computer, observe these guidelines:

- Run Windows Update as soon as possible after you set up your computer. Select **Start > All Programs > Windows Update**.
- Run Windows Update monthly thereafter.
- Obtain updates to Windows and other Microsoft programs, as they are released, from the Microsoft website and through the updates link in Help and Support.

Installing HP and third-party software updates

HP recommends that you regularly update the software and drivers that were originally installed on your computer. To download the latest versions, go to <http://www.hp.com/support>. At this location, you can also register to receive automatic update notifications when they become available.

If you have installed third-party software after you purchased your computer, regularly update the software. Software companies provide software updates to their products to correct security problems and improve functionality of the software.

Securing your wireless network

When you set up your wireless network, always enable security features. For more information, see “Protecting your WLAN” in the Networking chapter.

Backing up your software applications and information

Regularly back up your software applications and information to protect them from being permanently lost or damaged through a virus attack or a software or hardware failure. For more information, see “Backup and recovery.”

Using an optional security cable lock

A security cable lock, which is purchased separately, is designed to act as a deterrent, but it may not prevent the computer from being mishandled or stolen. Security cable locks are only one of several methods that should be employed as part of a complete security solution to help maximize theft protection.

The security cable slot on your computer may look slightly different from the illustration in this section. For the location of the security cable slot on your computer, see “Getting to know your computer.”

1. Loop the security cable lock around a secured object.
2. Insert the key (1) into the security cable lock (2).
3. Insert the security cable lock into the security cable slot on the computer (3), and then lock the security cable lock with the key.

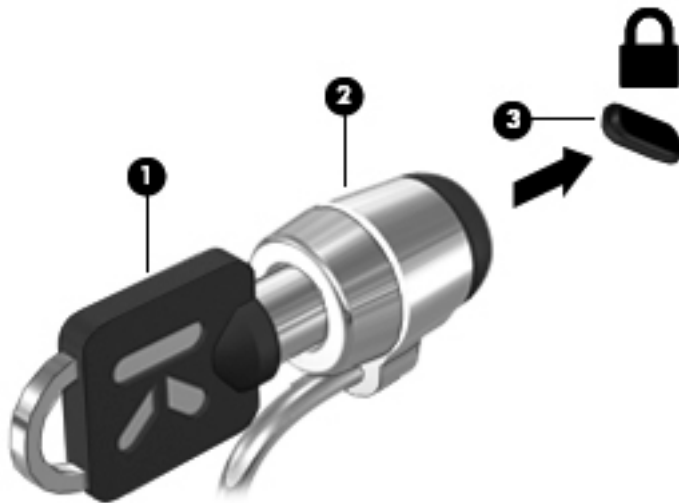

4. Remove the key and keep it in a safe place.

12 Backup and recovery

Your computer includes tools provided by the operating system and HP to help you safeguard your information and restore it if ever needed.

This chapter provides information on the following topics:

- Creating a set of recovery discs or a recovery flash drive (HP Recovery Manager software feature)
- Performing a system restore (from the partition, recovery discs, or a recovery flash drive)
- Backing up your information
- Recovering a program or driver

Restoring the system

If the computer hard drive fails, you must use a set of recovery discs or a recovery flash drive to restore your system to its factory image. Ideally, you have already used HP Recovery Manager to create these tools immediately after software setup.

For issues other than hard drive failure, you can restore your system by using the HP Recovery partition, rather than by using recovery discs or a recovery flash drive. To check for the presence of a recovery partition, click **Start**, right-click **Computer**, click **Manage**, and then click **Disk Management**. If the recovery partition is present, a Recovery drive is listed in the window.

 **CAUTION:** HP Recovery Manager (partition or discs/flash drive) restores only software that was preinstalled at the factory. Software not provided with this computer must be reinstalled manually.

Creating restore media

HP recommends that you create either a set of recovery discs or a recovery flash drive so that you can restore your computer to its original factory state if the hard drive fails, or if for any reason you cannot restore using the recovery partition tools. Create these discs or the flash drive after setting up the computer for the first time.

 **NOTE:** HP Recovery Manager allows the creation of only one set of recovery discs or one recovery flash drive. Handle these recovery tools carefully, and keep them in a safe place.

 **NOTE:** If your computer does not include an integrated optical drive, you can use an optional external optical drive (purchased separately) to create recovery discs, or you can purchase recovery discs for your computer from the HP Web site. If you use an external optical drive, it must be connected directly to a USB port on the computer, not to a USB port on an external device, such as a USB hub.

Guidelines:

- Purchase high-quality DVD-R, DVD+R, DVD-R DL, or DVD+R DL discs.

 **NOTE:** Read-write discs, such as CD-RW, DVD±RW, double-layer DVD±RW, and BD-RE (rewritable Blu-ray) discs, are not compatible with the HP Recovery Manager software.

- The computer must be connected to AC power during this process.
- Only one set of recovery discs or one recovery flash drive can be created per computer.

 **NOTE:** If you are creating recovery discs, number each disc before inserting it into the optical drive.

- If necessary, you can exit the program before you have finished creating the recovery discs or recovery flash drive. The next time you open HP Recovery Manager, you will be prompted to continue the backup creation process.

To create a set of recovery discs or a recovery flash drive:

1. Select **Start > All Programs > Security and Protection > HP Recovery Manager > HP Recovery Media Creation**.
2. Follow the on-screen instructions.

Performing a system recovery

HP Recovery Manager software allows you to repair or restore the computer to its original factory state. HP Recovery Manager works from recovery discs, a recovery flash drive, or from a dedicated recovery partition on the hard drive.



NOTE: A system restore must be performed if the computer hard drive fails or if all attempts to correct any functional computer issues fail. A system restore should be used as a final attempt to correct computer issues.

Note the following when performing a system restore:

- You can restore only the system that you have previously backed up. HP recommends that you use HP Recovery Manager to create either a set of recovery discs or a recovery flash drive as soon as you set up the computer.
- Windows has its own built-in repair features, such as System Restore. If you have not already tried these features, try them before using HP Recovery Manager to restore your system.
- HP Recovery Manager restores only software that was installed at the factory. For software not provided with this computer, you must either download the software from the manufacturer's Web site or reinstall the software from the disc provided by the manufacturer.

Using the dedicated recovery partition

When using the dedicated recovery partition, there is an option to back up pictures, music and other audio, videos and movies, recorded TV shows, documents, spreadsheets and presentations, e-mails, Internet favorites and settings during this process.

To restore the computer from the recovery partition, follow these steps:

1. Access HP Recovery Manager in either of the following ways:
 - Select **Start > All Programs > Security and Protection > HP Recovery Manager > HP Recovery Manager**.
 - or –
 - Turn on or restart the computer, and then press **esc** while the “Press the ESC key for Startup Menu” message is displayed at the bottom of the screen. Then, press **f11** while the “F11 (System Recovery)” message is displayed on the screen.
2. Click **System Recovery** in the **HP Recovery Manager** window.
3. Follow the on-screen instructions.

Restoring using the restore media

1. If possible, back up all personal files.
2. Insert the first recovery disc into the optical drive on your computer or an optional external optical drive, and then restart the computer.

– or –

Insert the recovery flash drive into a USB port on your computer, and then restart the computer.



NOTE: If the computer does not automatically restart in the HP Recovery Manager, the computer boot order needs to be changed.

3. Press **f9** at system bootup.
4. Select the optical drive or the flash drive.
5. Follow the on-screen instructions.

Changing the computer boot order

To change the boot order for recovery discs:

1. Restart the computer.
2. Press **esc** while the computer is restarting, and then press **f9** for boot options.
3. Select **Internal CD/DVD ROM Drive** from the boot options window.

To change the boot order for recovery flash drive:

1. Insert the flash drive into a USB port.
2. Restart the computer.
3. Press **esc** while the computer is restarting, and then press **f9** for boot options.
4. Select the flash drive from the boot options window.

Backing up and recovering your information

It is very important to back up your files and keep any new software in a safe place. As you add new software and data files, continue to create backups on a regular basis.

How completely you are able to recover your system depends on how recent your backup is.

 **NOTE:** A recovery from your most recent backup needs to be performed if the computer has a virus attack or if any major system components fail. In order to correct computer issues, a recovery should first be attempted before a system restore is attempted.

You can back up your information to an optional external hard drive, a network drive, or discs. Back up your system at the following times:

- At regularly scheduled times

 **TIP:** Set reminders to back up your information periodically.

- Before the computer is repaired or restored
- Before you add or modify hardware or software

Guidelines:

- Create system restore points using the Windows® System Restore feature, and periodically copy them to an optical disc or an external hard drive. For more information on using system restore points, refer to [Using Windows system restore points on page 86](#).
- Store personal files in the Documents library and back up this folder periodically.
- Save customized settings in a window, toolbar, or menu bar by taking a screen shot of your settings. The screen shot can be a time-saver if you have to re-enter your preferences.

To create a screen shot:

1. Display the screen you want to save.
2. Copy the screen image:
To copy only the active window, press **alt+prt sc**.
To copy the entire screen, press **prt sc**.
3. Open a word-processing document, and then select **Edit > Paste**. The screen image is added to the document.
4. Save and print the document.

Using Windows Backup and Restore

Guidelines:

- Be sure that the computer is connected to AC power before you start the backup process.
- Allow enough time to complete the backup process. Depending on file sizes, it may take over an hour.

To create a backup:

1. Select **Start > Control Panel > System and Security > Backup and Restore**.
2. Follow the on-screen instructions to schedule and create a backup.



NOTE: Windows® includes the User Account Control feature to improve the security of the computer. You may be prompted for your permission or password for tasks such as installing software, running utilities, or changing Windows settings. Refer to Help and Support for more information.

Using Windows system restore points

A system restore point allows you to save and name a snapshot of your hard drive at a specific point in time. You can then recover back to that point if you want to reverse subsequent changes.



NOTE: Recovering to an earlier restore point does not affect data files saved or e-mails created since the last restore point.

You also can create additional restore points to provide increased protection for your files and settings.

When to create restore points

- Before you add or modify software or hardware
- Periodically, whenever the computer is functioning optimally



NOTE: If you revert to a restore point and then change your mind, you can reverse the restoration.

Create a system restore point

1. Select **Start > Control Panel > System and Security > System**.
2. In the left pane, click **System Protection**.
3. Click the **System Protection** tab.
4. Click **Create**, and then follow the on-screen instructions.

Restore to a previous date and time

To revert to a restore point (created at a previous date and time), when the computer was functioning optimally, follow these steps:

1. Select **Start > Control Panel > System and Security > System**.
2. In the left pane, click **System Protection**.
3. Click the **System Protection** tab.
4. Click **System Restore**.
5. Follow the on-screen instructions.

13 Setup Utility (BIOS) and System Diagnostics

Using Setup Utility (BIOS)

Setup Utility, or Basic Input/Output System (BIOS), controls communication between all the input and output devices on the system (such as disk drives, display, keyboard, mouse, and printer). Setup Utility (BIOS) includes settings for the types of devices installed, the startup sequence of the computer, and the amount of system and extended memory.

 **NOTE:** Use extreme care when making changes in Setup Utility (BIOS). Errors can prevent the computer from operating properly.

Starting Setup Utility (BIOS)

To start Setup Utility (BIOS), follow these steps:

1. Turn on or restart the computer, and then press **esc** while the “Press the ESC key for Startup Menu” message is displayed at the bottom of the screen.
2. Press **f10** to enter Setup Utility (BIOS).

Changing the language of Setup Utility (BIOS)

1. Start Setup Utility (BIOS).
2. Use the arrow keys to select **System Configuration > Language**, and then press **enter**.
3. Use the arrow keys to select a language, and then press **enter**.
4. When a confirmation prompt with your language selected is displayed, press **enter**.
5. To save your change and exit Setup Utility (BIOS), use the arrow keys to select **Exit > Exit Saving Changes**, and then press **enter**.

Your change takes effect immediately.

Navigating and selecting in Setup Utility (BIOS)

To navigate and select in Setup Utility (BIOS), follow these steps:

1. Turn on or restart the computer, and then press **esc** while the “Press the ESC key for Startup Menu” message is displayed at the bottom of the screen.
 - To select a menu or a menu item, use the tab key and the keyboard arrow keys and then press **enter**.
 - To scroll up and down, use the up arrow key or the down arrow key.
 - To close open dialog boxes and return to the main Setup Utility (BIOS) screen, press **esc**, and then follow the on-screen instructions.
2. Press **f10** to enter Setup Utility (BIOS).

To exit Setup Utility (BIOS) menus, choose one of the following methods:

- To exit Setup Utility (BIOS) menus without saving your changes, press the **esc** key, and then follow the on-screen instructions.
– or –
Use the arrow keys to select **Exit > Exit Discarding Changes**, and then press **enter**.
– or –
- To save your changes and exit Setup Utility (BIOS) menus, press **f10**, and then follow the on-screen instructions.
– or –
Use the arrow keys to select **Exit > Exit Saving Changes**, and then press **enter**.

Your changes go into effect when the computer restarts.

Displaying system information

1. Start Setup Utility (BIOS).
2. Select the **Main** menu. System information such as the system time and date, and identification information about the computer is displayed.
3. To exit Setup Utility (BIOS) without changing any settings, use the arrow keys to select **Exit > Exit Discarding Changes**, and then press **enter**.

Restoring factory settings in Setup Utility (BIOS)



NOTE: Restoring defaults will not change the hard drive mode.

To return all settings in Setup Utility (BIOS) to the values that were set at the factory, follow these steps:

1. Turn on or restart the computer, and then press **esc** while the “Press the ESC key for Startup Menu” message is displayed at the bottom of the screen.
2. Press **f10** to enter Setup Utility (BIOS).
3. Use the arrow keys to select **Exit > Load Setup Defaults**. Press **enter**.
4. Follow the on-screen instructions.
5. To save your changes and exit, press **f10**, and then follow the on-screen instructions.

– or –

Use the arrow keys to select **Exit > Exit Saving Changes**, and then press **enter**.

Your changes go into effect when the computer restarts.



NOTE: Your password settings and security settings are not changed when you restore the factory settings.

Exiting Setup Utility (BIOS)

- To exit Setup Utility (BIOS) and save your changes from the current session:
If the Setup Utility (BIOS) menus are not visible, press **esc** to return to the menu display. Then use the arrow keys to select **Exit > Exit Saving Changes**, and then press **enter**.
- To exit Setup Utility (BIOS) without saving your changes from the current session:
If the Setup Utility (BIOS) menus are not visible, press **esc** to return to the menu display. Then use the arrow keys to select **Exit > Exit Discarding Changes**, and then press **enter**.

Updating the BIOS

Updated versions of the BIOS may be available on the HP Web site.

Most BIOS updates on the HP Web site are packaged in compressed files called *SoftPaqs*.

Some download packages contain a file named *Readme.txt*, which contains information regarding installing and troubleshooting the file.

Determining the BIOS version

To determine whether available BIOS updates contain later BIOS versions than those currently installed on the computer, you need to know the version of the system BIOS currently installed.

BIOS version information (also known as *ROM date* and *System BIOS*) can be displayed by pressing **fn+esc** (if you are already in Windows) or by using Setup Utility (BIOS).

1. Start Setup Utility (BIOS).
2. Use the arrow keys to select **Main**. Press **enter**.
3. To exit Setup Utility (BIOS) without saving your changes, use the tab key and the arrow keys to select **Exit > Exit Discarding Changes**, and then press **enter**.

Downloading a BIOS update

 **CAUTION:** To reduce the risk of damage to the computer or an unsuccessful installation, download and install a BIOS update only when the computer is connected to reliable external power using the AC adapter. Do not download or install a BIOS update while the computer is running on battery power, docked in an optional docking device, or connected to an optional power source. During the download and installation, follow these instructions:

Do not disconnect power from the computer by unplugging the power cord from the AC outlet.

Do not shut down the computer or initiate Sleep or Hibernation.

Do not insert, remove, connect, or disconnect any device, cable, or cord.

1. Select **Start > Help and Support > Maintain**.
2. Click **Refresh**.
3. Follow the on-screen instructions to identify your computer and access the BIOS update you want to download.
4. At the download area, follow these steps:
 - a. Identify the BIOS update that is later than the BIOS version currently installed on your computer. Make a note of the date, name, or other identifier. You may need this information to locate the update later, after it has been downloaded to your hard drive.
 - b. Follow the on-screen instructions to download your selection to the hard drive.

Make a note of the path to the location on your hard drive where the BIOS update is downloaded. You will need to access this path when you are ready to install the update.

 **NOTE:** If you connect your computer to a network, consult the network administrator before installing any software updates, especially system BIOS updates.

BIOS installation procedures vary. Follow any instructions that are displayed on the screen after the download is complete. If no instructions are displayed, follow these steps:

1. Open Windows Explorer by selecting **Start > Computer**.
2. Double-click your hard drive designation. The hard drive designation is typically Local Disk (C:).
3. Using the hard drive path you recorded earlier, open the folder on your hard drive that contains the update.
4. Double-click the file that has an .exe extension (for example, *filename.exe*).

The BIOS installation begins.

5. Complete the installation by following the on-screen instructions.

 **NOTE:** After a message on the screen reports a successful installation, you can delete the downloaded file from your hard drive.

Using System Diagnostics

System Diagnostics allows you to run diagnostic tests to determine if the computer hardware is functioning properly. Depending on your computer, the following diagnostic tests may be available in System Diagnostics:

- Start-up test—This test analyzes the main computer components that are required to start the computer.
- Run-in test—This test repeats the start-up test and checks for intermittent problems that the start-up test does not detect.
- Hard disk test—This test analyzes the physical condition of the hard drive, and then checks all data in every sector of the hard drive. If the test detects a damaged sector, it attempts to move the data to a good sector.
- Memory test—This test analyzes the physical condition of the memory modules. If it reports an error, replace the memory modules immediately.
- Battery test—This test analyzes the condition of the battery. If the battery fails the test, contact customer support to report the issue and purchase a replacement battery.

You can also view system information and error logs in the System Diagnostics window.

To start System Diagnostics:

1. Turn on or restart the computer. While the “Press the ESC key for Startup Menu” message is displayed in the lower-left corner of the screen, press **esc**. When the Startup Menu is displayed, press **f2**.
2. Click the diagnostic test you want to run, and then follow the on-screen instructions.



NOTE: If you need to stop a diagnostics test while it is running, press **esc**.

A Troubleshooting and support

Troubleshooting

The computer is unable to start up

If the computer does not turn on when you press the power button, the following suggestions may help you determine why the computer will not start up:

- If the computer is plugged into an AC outlet, plug another electrical device into the outlet to be sure that the outlet is providing adequate power.



NOTE: Use only the AC adapter provided with the computer or one approved by HP for this computer.

- If the computer is running on battery power or is plugged into an external power source other than an AC outlet, plug the computer into an AC outlet using the AC adapter. Be sure that the power cord and AC adapter connections are secure.

The computer screen is blank

If the screen is blank, but the computer is on and the power light is on, the computer may not be set to display the image on the computer screen. To transfer the image to the computer screen, press the **f4** action key.

Software is functioning abnormally

If the software is unresponsive or responds abnormally, follow these suggestions:

- Restart the computer by selecting **Start > Shut down > Restart**.

If you cannot restart the computer using this procedure, refer to the next section, [The computer is on but not responding on page 95](#).

- Run a virus scan. For information about using the antivirus resources on the computer, refer to [Securing your computer and information on page 74](#).

The computer is on but not responding

If the computer is on but is not responding to software or keyboard commands, try the following emergency shutdown procedures in the sequence provided:

 **CAUTION:** Emergency shutdown procedures result in the loss of unsaved information.

- Press **ctrl+alt+delete**, and then click the **Power** button.
- Press and hold the power button for at least 5 seconds.
- Disconnect the computer from external power and remove the battery.

The computer is unusually warm

It is normal for the computer to feel warm to the touch while it is in use. But if the computer feels *unusually* warm, it may be overheating because a vent is blocked. If you suspect that the computer is overheating, allow the computer to cool to room temperature. Then be sure to keep all vents free from obstructions while you are using the computer.

 **WARNING!** To reduce the possibility of heat-related injuries or of overheating the computer, do not place the computer directly on your lap or obstruct the computer air vents. Use the computer only on a hard, flat surface. Do not allow another hard surface, such as an adjoining optional printer, or a soft surface, such as pillows or rugs or clothing, to block airflow. Also, do not allow the AC adapter to contact the skin or a soft surface, such as pillows or rugs or clothing, during operation. The computer and the AC adapter comply with the user-accessible surface temperature limits defined by the International Standard for Safety of Information Technology Equipment (IEC 60950).

 **NOTE:** The fan in the computer starts up automatically to cool internal components and prevent overheating. It is normal for the internal fan to cycle on and off during operation.

An external device is not working

Follow these suggestions if an external device does not function as expected:

- Turn on the device according to the manufacturer's instructions.
- Be sure that all device connections are secure.
- Be sure that the device is receiving electrical power.
- Be sure that the device, especially if it is older, is compatible with the operating system.
- Be sure that the correct drivers are installed and updated.

The wireless network connection is not working

If a wireless network connection is not working as expected, follow these suggestions:

- Be sure that the wireless light on your computer is on (white). If the wireless light is off, press the [f12](#) action key to turn it on.
- Be sure that the device wireless antennas are free from obstructions.
- Be sure that the DSL or the cable modem and its power cord are properly connected and the lights are on.
- Be sure that the wireless router or access point is properly connected to its power adapter and the DSL or cable modem, and that the lights are on.
- Disconnect and then reconnect all cables, and turn the power off and then back on.



NOTE: For more information on wireless technology, refer to the relevant help topics and Web site links in Help and Support.



NOTE: For information on activating mobile broadband service (select models only), refer to the mobile network operator information included with your computer.

The optical disc tray does not open for removal of a disc

1. Insert the end of a paper clip into the release access in the front bezel of the drive **(1)**.
2. Press in gently on the paper clip until the disc tray is released, and then pull out the tray until it stops **(2)**.
3. Remove the disc from the tray by gently pressing down on the spindle while lifting the outer edges of the disc **(3)**. Hold the disc by the edges and avoid touching the flat surfaces.

 **NOTE:** If the tray is not fully accessible, tilt the disc carefully as you remove it.

4. Close the disc tray, and then place the disc in a protective case.

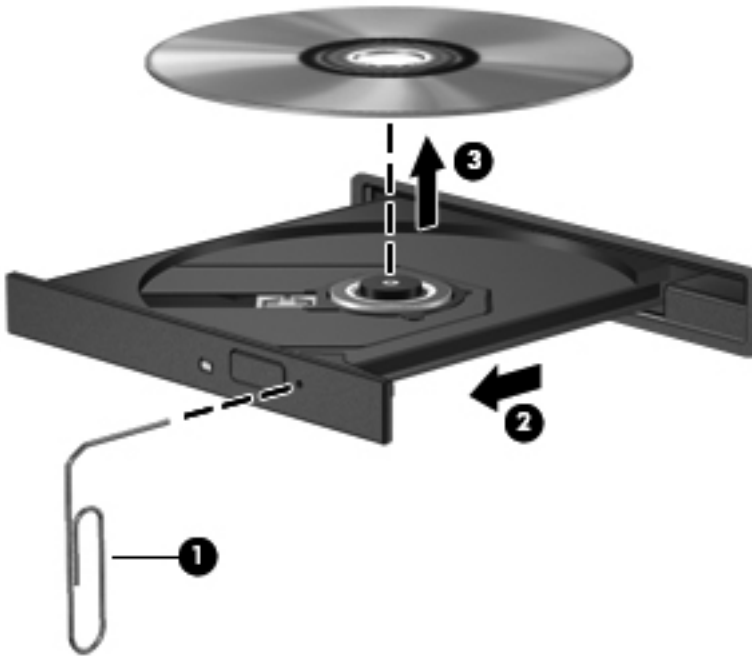

The computer does not detect the disc drive

If Windows does not detect an installed device, the device driver software might be missing or corrupted. If you suspect that the optical drive is not being detected, verify that the optical drive is listed in the Device Manager utility by:

1. Removing any discs from the optical drive.
2. Selecting **Start > Control Panel > System and Security**.
3. In the **System** area, clicking **Device Manager**.
4. In the Device Manager window, clicking the arrow next to DVD/CD-ROM drives to expand the list to show all of the installed drives.
5. Right-clicking the optical device listing to perform the following tasks:
 - Update the driver software
 - Disable
 - Uninstall
 - Scan for hardware changes. Windows scans your system for installed hardware and installs any required drivers
 - Click **Properties** to verify that the device is working properly
 - The Properties window provides details about the device to help you troubleshoot issues
 - Click the **Driver** tab to update, disable, or uninstall drivers for this device

A disc does not play

To play a CD, DVD, or BD:

- Save your work and close all open programs before playing a disc.
- Log off the Internet before playing a disc.
- Be sure that you insert the disc properly.
- Be sure that the disc is clean. If necessary, clean the disc with filtered water and a lint-free cloth. Wipe from the center of the disc to the outer edge.
- Check the disc for scratches. If you find scratches, treat the disc with an optical disc repair kit available at many electronics stores.
- Disable Sleep before playing the disc.

Do not initiate Hibernation or Sleep while playing a disc. Otherwise, you might see a warning message asking if you want to continue. If this message appears, click **No**. After clicking No, the computer might:

- Resume playback.
- Close the playback window in the multimedia program. To return to playing the disc, click the **Play** button in your multimedia program. In some cases, you might need to exit the program, and then restart it.
- Increase system resources.
 - Shut down printers and scanners, and unplug cameras and portable handheld devices. Disconnecting these Plug and Play devices frees up valuable system resources and results in better playback performance.
 - Change desktop color properties. Because the human eye cannot easily tell the difference between colors beyond 16 bits, you should not notice any loss of color while watching a movie if you lower system color properties to 16-bit color by:
 1. Right-clicking on a blank area of the computer desktop, and selecting **Screen resolution**.
 2. Selecting **Advanced Settings > Monitor** tab.
 3. Selecting **High Color (16 bit)**, if this setting is not already selected.
 4. Clicking **OK**.

The process of burning a disc does not begin, or it stops before completion

- Be sure that all other programs are closed.
- Disable Sleep and Hibernation.
- Be sure that you are using the right kind of disc for your drive.
- Be sure that the disc is inserted properly.
- Select a slower write speed and try again.
- If copying a disc, save the information on the source disc to your hard drive before trying to burn the contents to a new disc, and then burn from the hard drive.
- Reinstall the disc-burning device driver located in the DVD/CD-ROM drives category in Device Manager.

Contacting customer support

If the information provided in this user guide or in Help and Support does not address your questions, you can contact customer support at:

<http://www.hp.com/go/contactHP>



NOTE: For worldwide support, click **Contact HP worldwide** on the left side of the page, or go to http://welcome.hp.com/country/us/en/wwcontact_us.html.

At this location, you have the following choices:

- Chat online with an HP technician.



NOTE: When technical support chat is not available in a particular language, it is available in English.

- E-mail customer support.
- Find customer support worldwide telephone numbers.
- Locate an HP service center.

B Cleaning your computer

Cleaning the display

Gently wipe the display using a soft, lint-free cloth moistened with an *alcohol-free* glass cleaner. Be sure that the display is dry before closing the display.

Cleaning the sides and cover

To clean and disinfect the sides and cover, use a soft microfiber cloth or a static-free cloth without oil (such as a chamois) moistened with an *alcohol-free* glass cleaner or use an acceptable germicidal disposable wipe.



NOTE: When cleaning the cover of the computer, use a circular motion to aid in removing dirt and debris.

Cleaning the TouchPad and keyboard



CAUTION: When cleaning the TouchPad and keyboard, do not let liquids drip between the keys. This can permanently damage internal components.

- To clean and disinfect the TouchPad and keyboard, use a soft microfiber cloth or a static-free cloth without oil (such as a chamois) moistened with an *alcohol-free* glass cleaner or use an acceptable germicidal disposable wipe.
- To prevent keys from sticking and to remove dust, lint, and particles from the keyboard, use a can of compressed air with a straw extension.



WARNING! To reduce the risk of electric shock or damage to internal components, do not use a vacuum cleaner attachment to clean the keyboard. A vacuum cleaner can deposit household debris on the keyboard surface.

C Traveling with the computer

For best results, follow these traveling and shipping tips:

- Prepare the computer for traveling or shipping:

- Back up your information.
- Remove all discs and all external media cards, such as digital cards.

⚠ CAUTION: To reduce the risk of damage to the computer, damage to a drive, or loss of information, remove the media from a drive before removing the drive from a drive bay and before shipping, storing, or traveling with a drive.

- Turn off and then disconnect all external devices.
 - Shut down the computer.
- Take along a backup of your information. Keep the backup separate from the computer.
 - When traveling by air, carry the computer as hand luggage; do not check it in with the rest of your bags.

⚠ CAUTION: Avoid exposing a drive to magnetic fields. Security devices with magnetic fields include airport walk-through devices and security wands. Airport conveyer belts and similar security devices that check carry-on baggage use X-rays instead of magnetism and do not damage drives.

- In-flight computer use is at the discretion of the airline. If you plan to use the computer during a flight, check with the airline in advance.
- If the computer will be unused and disconnected from external power for more than 2 weeks, remove the battery and store it separately.
- If you are shipping the computer or a drive, use suitable protective packaging and label the package “FRAGILE.”
- If the computer has a wireless device or an HP Mobile Broadband Module installed, such as an 802.11b/g device, a Global System for Mobile Communications (GSM) device, or a General Packet Radio Service (GPRS) device, the use of these devices may be restricted in some environments. Such restrictions may apply onboard aircraft, in hospitals, near explosives, and in

hazardous locations. If you are uncertain of the policy that applies to the use of a particular device, ask for authorization to use it before you turn it on.

- If you are traveling internationally, follow these suggestions:
 - Check the computer-related customs regulations for each country or region on your itinerary.
 - Check the power cord and adapter requirements for each location in which you plan to use the computer. Voltage, frequency, and plug configurations vary.

 **WARNING!** To reduce the risk of electric shock, fire, or damage to the equipment, do not attempt to power the computer with a voltage converter kit sold for appliances.

D Updating programs and drivers

HP recommends that you update your programs and drivers on a regular basis to the latest versions. Go to <http://www.hp.com/support> to download the latest versions. You can also register to receive automatic update notifications when they become available.

E Electrostatic Discharge

Electrostatic discharge is the release of static electricity when two objects come into contact—for example, the shock you receive when you walk across the carpet and touch a metal door knob.

A discharge of static electricity from fingers or other electrostatic conductors may damage electronic components. To prevent damage to the computer, damage to a drive, or loss of information, observe these precautions:

- If removal or installation instructions direct you to unplug the computer, unplug it after being properly grounded and before removing a cover.
- Keep components in their electrostatic-safe containers until you are ready to install them.
- Avoid touching pins, leads, and circuitry. Handle electronic components as little as possible.
- Use nonmagnetic tools.
- Before handling components, discharge static electricity by touching an unpainted metal surface of the component.
- If you remove a component, place it in an electrostatic-safe container.

If you need more information about static electricity or assistance with component removal or installation, contact customer support.

F Specifications

Input power

The power information in this section may be helpful if you plan to travel internationally with the computer.

The computer operates on DC power, which can be supplied by an AC or a DC power source. The AC power source must be rated at 100–240 V, 50–60 Hz. Although the computer can be powered from a standalone DC power source, it should be powered only with an AC adapter or a DC power source supplied and approved by HP for use with this computer.

The computer can operate on DC power within the following specifications.

Input power	Rating
Operating voltage and current	18.5 V dc @ 3.5 A - 65 W
	18.5 V dc @ 3.5 A - 65 W, Slim Adapter
	19.0 V dc @ 4.74 A - 90 W
	19.0 V dc @ 4.74 A - 90 W Slim Adapter

DC plug of external HP power supply



 **NOTE:** This product is designed for IT power systems in Norway with phase-to-phase voltage not exceeding 240 V rms.

 **NOTE:** The computer operating voltage and current can be found on the system regulatory label.

Operating environment

Factor	Metric	U.S.
Temperature		
Operating	5°C to 35°C	41°F to 95°F
Nonoperating	-20°C to 60°C	-4°F to 140°F
Relative humidity (noncondensing)		
Operating	10% to 90%	10% to 90%
Nonoperating	5% to 95%	5% to 95%
Maximum altitude (unpressurized)		
Operating	-15 m to 3,048 m	-50 ft to 10,000 ft
Nonoperating	-15 m to 12,192 m	-50 ft to 40,000 ft

Index

- A**
- AC adapter, testing 50
 - action keys
 - decrease screen brightness 30
 - Help and Support 30
 - identifying 8
 - increase screen brightness 30
 - keyboard backlight 30
 - next track or section 30
 - play, pause, resume 30
 - previous track or section 30
 - switch screen image 30
 - volume 34
 - volume down 31
 - volume mute 31
 - volume up 31
 - wireless 31
 - airport security devices 57
 - antivirus software 78
 - audio functions, checking 34
 - audio-in (microphone) jack, identifying 10
 - audio-out (headphone) jack, identifying 10
- B**
- b key, identifying 8
 - backing up
 - customized window, toolbar, and menu bar settings 85
 - personal files 85
 - bass settings hotkey 32
 - battery
 - conserving power 48
 - discharging 46
 - displaying remaining charge 46
 - disposing 48
 - low battery levels 46
 - replacing 48
 - storing 48
 - battery bay 13, 14
 - Battery Check 45
 - battery information, finding 45
 - battery light 10
 - battery power 45
 - battery release latch 13
 - battery temperature 48
 - battery, replacing 39
 - Beats Audio 8, 32, 35
 - BIOS
 - determining version 91
 - downloading an update 92
 - updating 91
 - Bluetooth device 19, 23
 - Bluetooth label 14
 - buttons
 - left TouchPad 4
 - media 33
 - optical drive eject 10
 - power 6
 - QuickWeb 7
 - right TouchPad 4
 - volume 34
- C**
- cables
 - USB 55
 - caps lock light, identifying 5
 - caring for your computer 101
 - CD
 - burning 100
 - Certificate of Authenticity label 14
 - checking audio functions 34
 - cleaning your computer 101
 - components
 - bottom 13
 - display 12
 - front 9
 - left side 11
 - right side 10
 - top 4
 - computer, traveling 48, 102
 - configuring audio for HDMI 37
 - connecting to a wired network 24
 - connecting to an existing wireless network 21
 - Connection Manager 20
 - connector, power 10
 - conservation, power 48
 - creating a wireless connection 19
 - critical battery level 41, 46
 - CyberLink PowerDVD 38
- D**
- DC plug of external HP power supply 106
 - digital card
 - inserting 53
 - removing 54
 - supported formats 53
 - Digital Media Slot, identifying 9
 - Disk Cleanup software 58
 - Disk Defragmenter software 58
 - drive light 11, 59
 - drive media 41
 - drives
 - external 56
 - handling 57
 - hard 56
 - optical 56
 - using 58
 - DVD
 - burning 100

E

- electrostatic discharge 105
- esc key, identifying 8
- existing wireless network,
connecting to 21
- external AC power, using 49
- external devices 56
- external drive 56
- external monitor port 11, 36

F

- f11 83
- fingerprint reader light 5
- firewall software 22, 78
- fn key, identifying 8, 32

G

- graphics modes, switching 51

H

- hard drive
 - external 56
 - HP 3D DriveGuard 59
 - installing 63
 - removing 61
- hard drive bay, identifying 13
- HDMI
 - configuring audio 37
- HDMI port, connecting 37
- HDMI port, identifying 11
- headphone (audio-out) jack 10
- Hibernation
 - exiting 42
 - initiated during critical battery
level 46
 - initiating 42
- high-definition devices,
connecting 37
- hotkeys
 - bass settings 32
 - description 32
 - display system information 32
 - using 32
- HP 3D DriveGuard 59
- HP Connection Manager 20
- HP Recovery Manager 83
- HP USB Ethernet Adapter,
connecting 24
- hubs 54

I

- icons
 - network 19
 - wireless 19
- input power 106
- installing
 - optional security cable 80
 - software updates 79
- integrated webcam light,
identifying 12
- internal microphones, identifying
12
- Internet connection setup 21
- Internet security software 78
- ISP, using 18

J

- jacks
 - audio-in (microphone) 10
 - audio-out (headphone) 10
 - network 11
 - RJ-45 (network) 11

K

- keyboard hotkeys, identifying 32
- keys
 - action 8
 - b 8
 - esc 8
 - fn 8
 - media 33
 - volume 34
 - Windows applications 8
 - Windows logo 8

L

- labels
 - Bluetooth 14
 - Microsoft Certificate of
Authenticity 14
 - regulatory 14
 - serial number 14
 - wireless certification 14
 - WLAN 14
- latch, battery release 13
- lights
 - battery/AC 10
 - caps lock 5
 - fingerprint reader 5
 - hard drive 11
 - mute 5

- power 5
- TouchPad 4, 5
- webcam 12
- wireless 5

- lights, drive 59
- local area network (LAN)
 - cable required 24
 - connecting cable 24
- low battery level 46

M

- maintenance
 - Disk Cleanup 58
 - Disk Defragmenter 58
- media action keys 33
- media activity controls 33
- media hotkeys 33
- memory module
 - inserting 71
 - removing 70
 - replacing 69
- memory module compartment
cover
 - removing 70
 - replacing 64, 72
- memory module compartment,
identifying 13
- microphone (audio-in) jack,
identifying 10
- Microsoft Certificate of Authenticity
label 14
- mouse, external
 - setting preferences 25
- mute light, identifying 5

N

- network cable, connecting 24
- network icon 19
- network jack, identifying 11

O

- operating environment 107
- operating system
 - Microsoft Certificate of
Authenticity label 14
 - Product Key 14
- operating system controls 20
- optical disc
 - inserting 65
 - removing 66
- optical drive 56

- optical drive eject button, identifying 10
- optical drive, identifying 10
- optional external devices, using 56

P

- passwords
 - set in Setup Utility (BIOS) 76
 - set in Windows 76
- pinching TouchPad gesture 29
- pointing devices, setting preferences 25
- ports
 - external monitor 11, 36
 - HDMI 11, 37
 - USB 10, 11
 - VGA 36
- power
 - battery 45
 - conserving 48
 - options 41
- power button, identifying 6
- power connector, identifying 10
- power lights, identifying 5
- power meter 43
- power plans
 - customizing 43
 - selecting 43
 - viewing current 43
- power-saving states 41
- PowerDVD 38
- Product Key 14
- product name and number, computer 14
- protecting your wireless network 22

Q

- QuickWeb
 - Home Screen 16
 - starting 16
- QuickWeb button, identifying 7
- QuickWeb software 15

R

- readable media 41
- recovering from the dedicated recovery partition 83
- recovering from the recovery discs 84

- recovery discs 82
- recovery, system 83
- regulatory information
 - regulatory label 14
 - wireless certification labels 14
- restore points 86
- RJ-45 (network) jack, identifying 11
- roaming to another network 23

S

- scrolling TouchPad gesture 29
- security cable slot, identifying 11
- security cable, installing 80
- security, wireless 22
- serial number 14
- serial number, computer 14
- setting password protection on wakeup 44
- setting power options 41
- setup of WLAN 21
- Setup Utility (BIOS)
 - changing the language 88
 - displaying system information 89
 - exiting 90
 - navigating and selecting 89
 - passwords set in 76
 - restoring factory settings 90
- sharing optical drives 68
- shutdown 41
- Sleep
 - exiting 42
 - initiating 42
- slots
 - Digital Media 9
 - security cable 11
- software
 - CyberLink PowerDVD 38
 - Disk Cleanup 58
 - Disk Defragmenter 58
 - HP 3D DriveGuard 60
 - HP Connection Manager 20
- software updates, installing 79
- speakers, identifying 9
- storing a battery 48
- supported discs 82
- switchable graphics 51
- system information hotkey 32
- system information, displaying 89

- system recovery 83
- system restore points 86

T

- temperature 48
- testing an AC adapter 50
- TouchPad
 - buttons 4
 - using 25
- TouchPad gestures
 - pinching 29
 - scrolling 29
 - zooming 29
- TouchPad light 4, 5
- TouchPad on/off button 4
- TouchPad zone, identifying 4
- traveling with the computer 14, 48, 102
- troubleshooting
 - burning discs 100
 - computer is unable to start up 94
 - computer on but not responding 95
 - computer screen is blank 94
 - computer unusually warm 95
 - disc play 99
 - external device 95
 - optical disc tray 97
 - optical drive detection 98
 - software functioning
 - abnormally 94
 - wireless network connection 96
- troubleshooting and support 94
- turning off the computer 41
- turning wireless devices on or off 20

U

- unresponsive system 41
- USB cable, connecting 55
- USB devices
 - connecting 55
 - description 54
 - removing 55
- USB hubs 54
- USB ports, identifying 10, 11
- using external AC power 49
- using passwords 75

- using power plans 43
- using power-saving states 41
- using system restore 86
- using the power meter 43

V

- vents, identifying 11, 13
- VGA port, connecting 36
- video 36
- volume
 - adjusting 34
 - buttons 34
 - keys 34

W

- webcam 36
- webcam light, identifying 12
- webcam, identifying 12
- Windows applications key, identifying 8
- Windows logo key, identifying 8
- Windows, passwords set in 76
- wireless
 - icons 19
 - protecting 22
- wireless certification label 14
- wireless connection, creating 19
- wireless devices, turning on or off 20
- wireless encryption 22
- wireless light 5
- wireless network (WLAN)
 - connecting to existing 21
 - security 22
- wireless network (WLAN), equipment needed 21
- wireless router, configuring 22
- wireless set up 21
- WLAN antennas, identifying 12
- WLAN device 14
- WLAN label 14
- writable media 41

Z

- zooming TouchPad gesture 29