



HP ProBook 4535s Notebook PC

Maintenance and Service Guide

© Copyright 2011 Hewlett-Packard
Development Company, L.P.

Bluetooth is a trademark owned by its proprietor and used by Hewlett-Packard Company under license. Advanced Micro Devices, Inc. AMD are trademarks of Advanced Micro Devices, Inc. Microsoft, Windows, and Windows Vista are either trademarks or registered trademarks of Microsoft Corporation in the United States and/or other countries. SD Logo is a trademark of its proprietor.

The information contained herein is subject to change without notice. The only warranties for HP products and services are set forth in the express warranty statements accompanying such products and services. Nothing herein should be construed as constituting an additional warranty. HP shall not be liable for technical or editorial errors or omissions contained herein.

Third Edition: December 2011

First Edition: June 2011

Document Part Number: 656969-003

Safety warning notice

 **WARNING!** To reduce the possibility of heat-related injuries or of overheating the computer, do not place the computer directly on your lap or obstruct the computer air vents. Use the computer only on a hard, flat surface. Do not allow another hard surface, such as an adjoining optional printer, or a soft surface, such as pillows or rugs or clothing, to block airflow. Also, do not allow the AC adapter to contact the skin or a soft surface, such as pillows or rugs or clothing, during operation. The computer and the AC adapter comply with the user-accessible surface temperature limits defined by the International Standard for Safety of Information Technology Equipment (IEC 60950).

Table of contents

1 Product description	1
2 External component identification	7
Display	7
Top	8
TouchPad	8
Lights	9
Buttons and fingerprint reader (select models only)	10
Keys	12
Front	14
Left	15
Right	16
Bottom	17
3 Illustrated parts catalog	18
Service tag	18
Computer major components	19
Display components	25
Plastics Kit	26
Cable Kit	27
Mass storage devices	27
Miscellaneous parts	28
Sequential part number listing	29
4 Removal and replacement procedures	35
Preliminary replacement requirements	35
Tools required	35
Service considerations	35
Plastic parts	35
Cables and connectors	36
Drive handling	36

Grounding guidelines	37
Electrostatic discharge damage	37
Packaging and transporting guidelines	38
Workstation guidelines	38
Equipment guidelines	39
Component replacement procedures	40
Service tag	40
Battery	41
SIM	42
Bottom door	43
Optical drive	44
Hard drive	46
Memory modules	48
WWAN module	50
WLAN/Bluetooth combo card	52
Keyboard	57
Top cover	59
Card reader board	64
Speaker assembly	65
Quick Launch board	67
Power button board	68
Modem module	70
Lid switch	72
USB board	73
RJ-11 jack cable	75
System board	76
RTC battery	79
Fan	81
Heat sink	83
Processor	85
Power cable	87
Display assembly	89
5 Computer Setup (BIOS) and System Diagnostics	98
Using Computer Setup	98
Starting Computer Setup	98
Navigating and selecting in Computer Setup	98
Restoring factory settings in Computer Setup	99
Updating the BIOS	100
Determining the BIOS version	100
Downloading a BIOS update	100

Using System Diagnostics	101
6 Specifications	102
Computer specifications	102
39.6-cm (15.6-in), HD display specifications	103
Hard drive specifications	104
Blu-ray BD-R/RE DVD±RW SuperMulti DL Drive specifications	105
DVD±RW and CD-RW SuperMulti DL Combo Drive specifications	106
Blu-ray Disc ROM with SuperMulti DVD±R/RW DL Drive	107
DVD-ROM Drive specifications	108
Specification information in Device Manager	109
7 Backup and recovery	110
Windows 7	110
Backing up your information	110
Performing a system recovery	111
Using the Windows recovery tools	112
Using f11 recovery tools	112
Using a Windows 7 operating system DVD (purchased separately)	113
Windows Vista	114
Backing up your information	114
Performing a recovery	115
Using the Windows recovery tools	115
Using f11 recovery tools	116
Using a Windows Vista operating system DVD (purchased separately)	116
8 Power cord set requirements	118
Requirements for all countries and regions	118
Requirements for specific countries and regions	119
9 Recycling	120
Battery	120
Display	120
Index	126

1 Product description

Category	Description	UMA	Discrete
Product Name	HP ProBook 4535s Notebook PC	√	√
Processors (Accelerated Processing Unit [APU])	AMD A6-3420M, 2.30-GHz Max/1.4-GHz Base, 4-MB L2 cache, quad-core, 45W Graphics: HD 6520G	√	√
	AMD A6-3400M, 2.30-GHz Max/1.4-GHz Base, 4-MB L2 cache, quad-core, 45W Graphics: HD 6520G	√	√
	AMD A4-3320M, 2.60-GHz Max/2.0-GHz Base, 2-MB L2 cache, dual-core, 45W Graphics: HD 6480G	√	√
	AMD A4-3305M, 2.50-GHz Max/1.9-GHz Base, 1-MB L2 cache, dual-core, 45W Graphics: HD 6480G	√	√
	AMD A4-3300M, 2.50-GHz Max/1.9-GHz Base, 2-MB L2 cache, dual-core, 45W Graphics: HD 6480G	√	√
	AMD E2-3000M, 2.40-GHz Max/1.8-GHz Base, 1-MB L2 cache, dual-core, 35W Graphics: HD 6380G	√	√
Fusion Controller Hub (Chipset)	AMD A70M FCH	√	√
Graphics	AMD UMA Processor-specific, see Processors .	√	
	AMD Discrete Graphics: A6 3400M - Graphic branding HD 6540G2 A4 3300M - Graphic branding HD 6510G2 512MB DDR3 - 900 MHz (64Mx16/32Mx32, Qty 4) -or- 1GB DDR3 - 900 MHz (128Mx16/64Mx32, Qty 4)		√
Panel	All display assemblies include 2 wireless local area network (WLAN) antennas All displays are LED backlit	√	√
	39.6-cm (15.6-inch) HD, 1366x768	√	√

Category	Description	UMA	Discrete
	39.6-cm (15.6-inch) HD, 1366x768, includes camera	√	√
	39.6-cm (15.6-inch) HD, 1366x768, includes camera and WWAN	√	
	39.6-cm (15.6-inch) HD, BrightView, 1366x768	√	√
	39.6-cm (15.6-inch) HD, BrightView, 1366x768, includes camera	√	√
	39.6-cm (15.6-inch) HD, BrightView, 1366x768, includes camera and WWAN	√	
	Support privacy filter	√	√
Memory	Two customer-accessible/upgradeable memory module slots supporting up to 8 GB of RAM	√	√
	Supports dual-channel memory	√	√
	PC3-10600, 1333-MHz, DDR3	√	√
	Supports the following configurations:	√	√
	<ul style="list-style-type: none"> • 8192 (4096 × 2) • 4096 (2048 × 2) • 4096 (4096 × 1) • 3072 (2048 + 1024) • 2048 (2048 × 1) • 2048 (1024 × 2) • 1024 (1024 × 1) 		
Hard drives	Supports 7-mm/9.5-mm/12.7-mm, 2.5-in SATA hard drives with HP 3D DriveGuard	√	√
	Customer-accessible	√	√
	Supports the following drives:	√	√
	<ul style="list-style-type: none"> • 750-GB, 7200-rpm • 750-GB, 5400-rpm • 640-GB, 5400-rpm • 500-GB, 7200-rpm • 500-GB, 5400-rpm • 320-GB, 7200-rpm • 320-GB, 5400-rpm • 250-GB, 7200-rpm • 250-GB, 5400-rpm 		

Category	Description	UMA	Discrete
Fixed optical drives	Supports the following 12.7-mm SATA optical drives: <ul style="list-style-type: none"> DVD-ROM DVD+/-RW SuperMulti DL Blu-ray ROM DVD+/-RW SuperMulti DL 	√	√
	Supports no optical drive option	√	√
Audio/Visual	Integrated dual-array microphone (webcam models only)	√	√
	Integrated mono (non-webcam models)	√	√
	Stereo speakers (2)	√	√
	Integrated webcam (720p HD)	√	√
	Supports no camera option	√	√
	Headphone and microphone jacks	√	√
Modem	56K V.92 MDC data/fax modem	√	√
	Modem cable not included	√	√
	Supports "No Modem" option	√	√
Ethernet	Realtek RTL8151EH-CG 10/100/1000	√	√
	S3/S4/S5 wake on LAN (AC mode only)	√	√
	Ethernet cable not included	√	√
Wireless	Integrated WLAN options by way of wireless module:	√	√
	Two WLAN antennas built into display assembly	√	√
	Supports "no WLAN" option	√	√
	Supports the following WLAN formats: <ul style="list-style-type: none"> Ralink 802.11 b/g/n 1×1 Realtek 802.11 b/g/n 1×1 Atheros 802.11 b/g/n +BT Combo Ralink 802.11 a/b/g/n +BT Combo Realtek 802.11 b/g/n +BT Combo 	√	√
	Integrated WWAN options by way of wireless module:	√	
	Two WWAN antennas built into display assembly (world-wide 5 band, configured with panels on all units)	√	
	Subscriber identity module (SIM) security (customer-accessible in battery bay)	√	
	Supports "no WWAN" option	√	

Category	Description	UMA	Discrete
	Supports the following WWAN modules: <ul style="list-style-type: none"> Gobi 3000: HP un2430 EV-DO/HSPA Mobile Broadband Ericsson: HP hs2340 HSPA+ Mobile Broadband Ericsson F3307-900 	√	
	Integrated personal area network (PAN) options by way of Bluetooth® module:	√	√
	Bluetooth 3.0 only supported by combo card	√	√
External media card	One ExpressCard 34mm slot	√	√
	6-in-1 Digital Media Reader Slot	√	√
Ports	Audio-in (stereo microphone)	√	√
	Audio-out (stereo headphone)	√	√
	RJ-11 (modem)	√	√
	RJ-45 (Ethernet, includes link and activity lights)	√	√
	USB 3.0 (1)	√	√
	USB 2.0 (3)	√	√
	VGA (Dsub 15-pin) supporting 1600 × 1200 external resolution at 75-GHz (hot plug/unplug with auto-detect)	√	√
	HDMI	√	√
	Multi-pin AC port	√	√
Keyboard/ pointing devices	Full-sized keyboard with numeric keypad	√	√
	Touchpad includes: supports 2-way scroll with legend, taps enabled by default, 2-finger scrolling and zoom enabled by default	√	√
Power requirements	Smart AC adapter with localized cable plug support (3-wire plug with ground pin):	√	√
	90-W		√
	65-W	√	
	L-shape battery	√	√
	9-cell, 93-Wh Li-ion battery	√	√
	6-cell, 55 WHr HP Long Life Li-ion battery	√	√
	6-cell, 47-Wh Li-ion battery	√	√
Security	Integrated fingerprint reader	√	√
	Intel AT support	√	√
	Support Kensington security lock	√	√
	Support no fingerprint reader option	√	√
Operating system	Preinstalled:		

Category	Description	UMA	Discrete
	Windows 7 Professional 32 with Microsoft® Basics	√	√
	Windows 7 Professional 64 with Microsoft Basics	√	√
	Windows 7 Home Premium 64 with Microsoft Basics	√	√
	Windows 7 Home Premium 32 with Microsoft Basics	√	√
	Novell™: SuSE Linux™ – SLED 11 (not available with WWAN)	√	√
	FreeDOS	√	√
	Preinstalled with Microsoft Office:		
	Windows 7 Professional 32 with Microsoft Office 2010 Starter	√	√
	Windows 7 Professional 32 with Microsoft Office 2010 Starter MSNA	√	√
	Windows 7 Professional 32 with Microsoft Office 2010 Starter EDGI	√	√
	Windows 7 Professional 32 with Microsoft Office 2010 Personal	√	√
	Windows 7 Professional 32 with Microsoft Office 2010 Home & Business	√	√
	Windows 7 Professional 32 with Microsoft Office 2010 Professional	√	√
	Windows 7 Professional 64 with Microsoft Office 2010 Starter MSNA	√	√
	Windows 7 Professional 64 with Microsoft Office 2010 Starter EDGI	√	√
	Windows 7 Professional 64 with Microsoft Office 2010 Starter	√	√
	Windows 7 Professional 64 with Microsoft Office 2010 Personal	√	√
	Windows 7 Professional 64 with Microsoft Office 2010 Home & Business	√	√
	Windows 7 Professional 64 with Microsoft Office 2010 Professional	√	√
	Windows 7 Home Premium 32 with Microsoft Office 2010 Starter EDGI	√	√
	Windows 7 Home Premium 32 with Microsoft Office 2010 Starter	√	√
	Windows 7 Home Premium 32 with Microsoft Office 2010 Personal	√	√
	Windows 7 Home Premium 32 with Microsoft Office 2010 Home & Business	√	√
	Windows 7 Home Premium 32 with Microsoft Office 2010 Professional	√	√
	Windows 7 Home Premium 64 with Microsoft Office 2010 Starter EDGI	√	√
	Windows 7 Home Premium 64 with Microsoft Office 2010 Starter	√	√
	Windows 7 Premium 64 with Microsoft Office 2010 Personal	√	√
	Windows 7 Premium 64 with Microsoft Office 2010 Home & Business	√	√
	Windows 7 Premium 64 with Microsoft Office 2010 Professional	√	√
	Windows 7 Starter with Microsoft Office 2010 Starter	√	√
	Windows 7 Home Basic 32 with Microsoft Office 2010 Starter EDGI	√	√
	Windows 7 Home Basic 32 with Microsoft Office 2010 Starter	√	√
	Windows 7 Home Basic 32 with Microsoft Office 2010 Starter - EDGI	√	√
	Restore Media:		

Category	Description	UMA	Discrete
	Windows 7 Professional 64	√	√
	Windows 7 Professional 32	√	√
	Windows 7 Home Basic 32	√	√
	Windows 7 Home Premium 64	√	√
	Windows 7 Home Premium 32	√	√
	Windows 7 Starter	√	√
	DRDVD Windows 7	√	√
	Windows Vista – through Service only	√	√
	Web-only support:		
	Windows XP Professional	√	√
	Windows Vista Home Basic 32	√	√
	Certified:		
	Microsoft WHQL	√	√
Serviceability	End-user replaceable parts:		
	AC adapter	√	√
	Battery (system)	√	√
	Hard drive	√	√
	Memory module	√	√
	Optical drive	√	√
	WLAN module	√	√
	WWAN module, SIM	√	√
	Keyboard	√	√

2 External component identification

Display

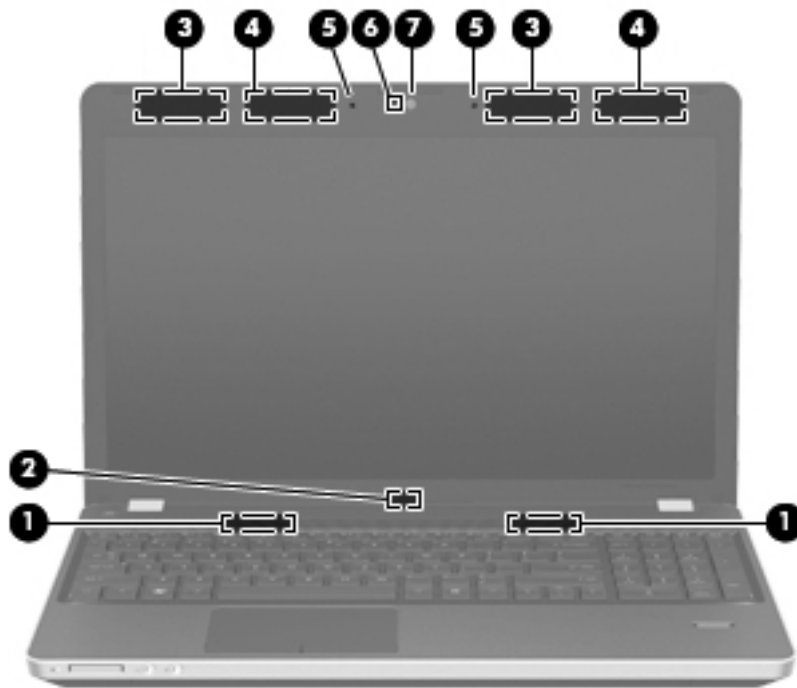

Component	Description
(1) Speakers (2)	Produce sound.
(2) Internal display switch	Turns off the display or initiates Sleep if the display is closed while the power is on. NOTE: The display switch is not visible from the outside of the computer.
(3) WWAN antennas (2)* (select models only)	Send and receive wireless signals to communicate with wireless wide area networks (WWAN).
(4) WLAN antennas (2)*	Send and receive wireless signals to communicate with wireless local area networks (WLAN).
(5) Internal microphone(s) (1 or 2 depending on model)	Record sound.
(6) Webcam light (select models only)	On: The webcam is in use.

Component	Description
(7) Webcam (select models only)	Records video and captures still photographs. To use the webcam, select Start > All Programs > ArcSoft TotalMedia Suite > WebCam Companion .

*The antennas are not visible from the outside of the computer. For optimal transmission, keep the areas immediately around the antennas free from obstructions. To see wireless regulatory notices, refer to the section of the *Regulatory, Safety, and Environmental Notices* that applies to your country or region. These notices are located in Help and Support.

Top

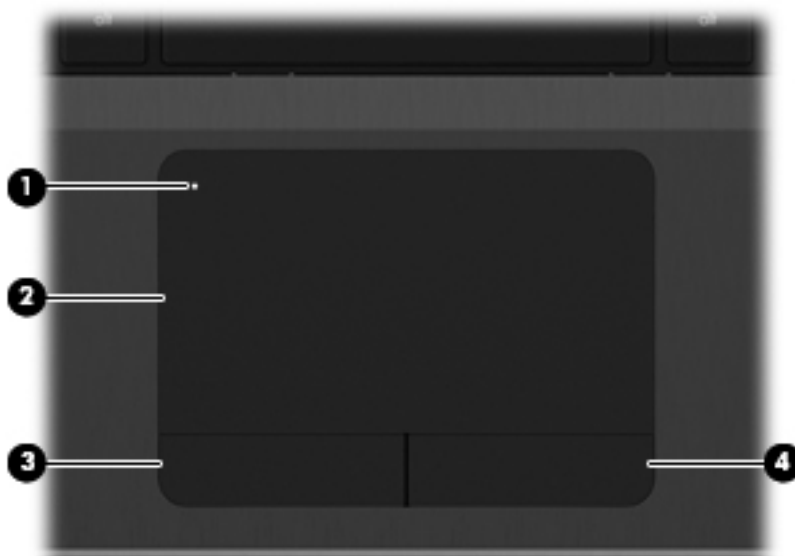

TouchPad

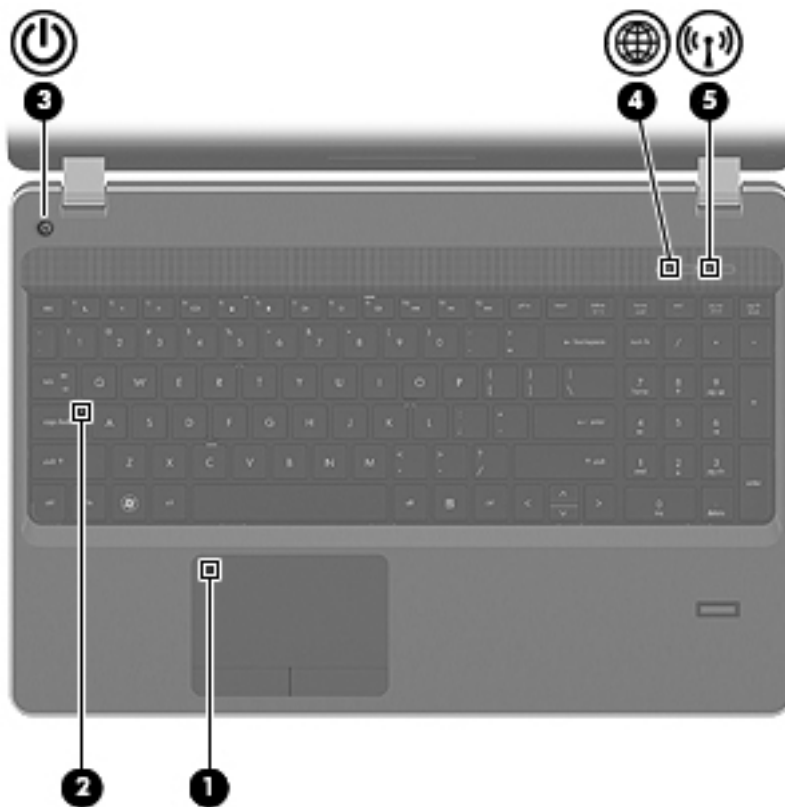

Component	Description
(1) TouchPad on/off button	Turns the TouchPad on and off.
(2) TouchPad	Moves the pointer and selects or activates items on the screen.
(3) Left TouchPad button	Functions like the left button on an external mouse.
(4) Right TouchPad button	Functions like the right button on an external mouse.

Lights



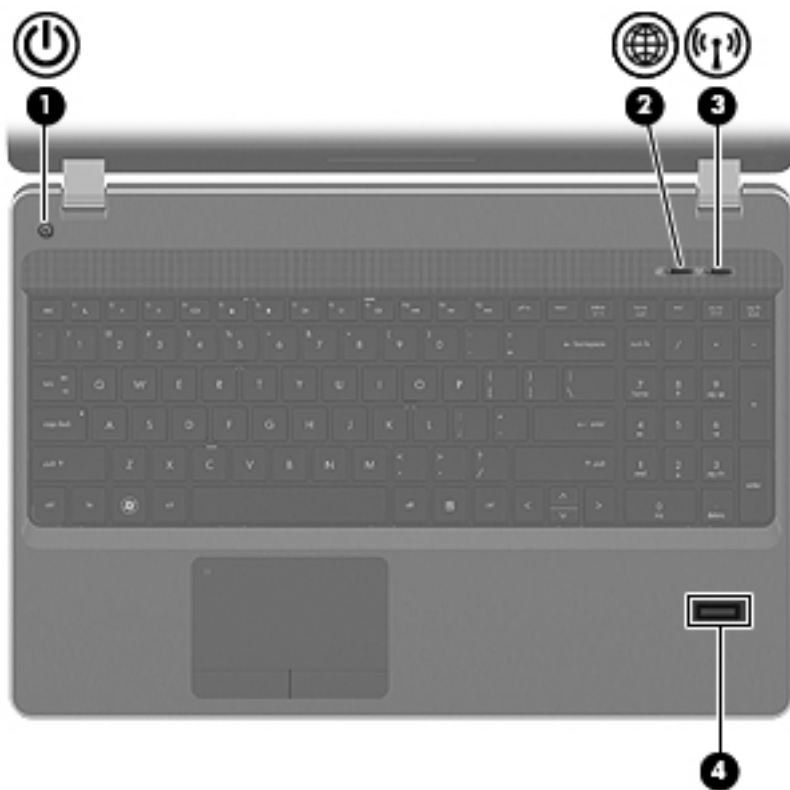

Component	Description
(1) TouchPad light	<ul style="list-style-type: none"> Amber: The TouchPad is off. Off: The TouchPad is on.
(2) Caps lock light	<ul style="list-style-type: none"> White: Caps lock is on. Off: Caps lock is off.
(3)  Power light	<ul style="list-style-type: none"> On: The computer is on. Blinking: The computer is in the Sleep state. Off: The computer is off or in Hibernation.
(4)  QuickWeb light	<ul style="list-style-type: none"> Blinking: QuickWeb is on. Off: QuickWeb is off. <p>NOTE: For more information, refer to the HP QuickWeb software Help.</p>
(5)  Wireless light	<ul style="list-style-type: none"> White: An integrated wireless device, such as a wireless local area network (WLAN) device and/or a Bluetooth® device, is on. Amber: All wireless devices are off.

Buttons and fingerprint reader (select models only)





Component	Description
(1)  Power button	<ul style="list-style-type: none">• When the computer is off, press the button to turn on the computer.• When the computer is on, press the button briefly to initiate Sleep.• When the computer is in the Sleep state, press the button briefly to exit Sleep.• When the computer is in Hibernation, press the button briefly to exit Hibernation. <p>If the computer has stopped responding and Windows® shutdown procedures are ineffective, press and hold the power button for at least 5 seconds to turn off the computer.</p> <p>To learn more about your power settings:</p> <ul style="list-style-type: none">• Windows 7—Select Start > Control Panel > System and Security > Power Options.• Windows Vista—Select Start > Control Panel > System and Maintenance > Power Options• Or refer to the <i>HP Notebook Reference Guide</i>.

Component	Description
(2)  QuickWeb button	<ul style="list-style-type: none"> • When the computer is off or in Hibernation, press the button to open HP QuickWeb. • When the computer is in Microsoft Windows, press the button to open the default Web browser. • When the computer is in HP QuickWeb, press the button to open the default Web browser. <p>NOTE: For more information, refer to the HP QuickWeb software Help. If your computer does not have HP QuickWeb software, the button does not perform any action or function.</p>
(3)  Wireless button	Turns the wireless feature on or off but does not establish a wireless connection.
(4)  Fingerprint reader (select models only)	Allows a fingerprint logon to Windows, instead of a password logon.

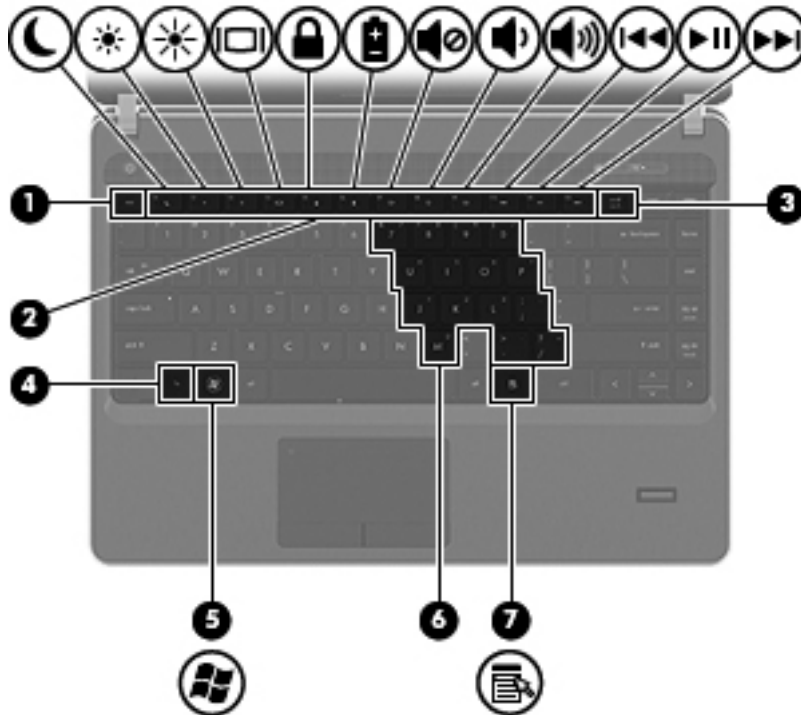

Keys

 **NOTE:** Refer to the illustration that most closely matches your computer.



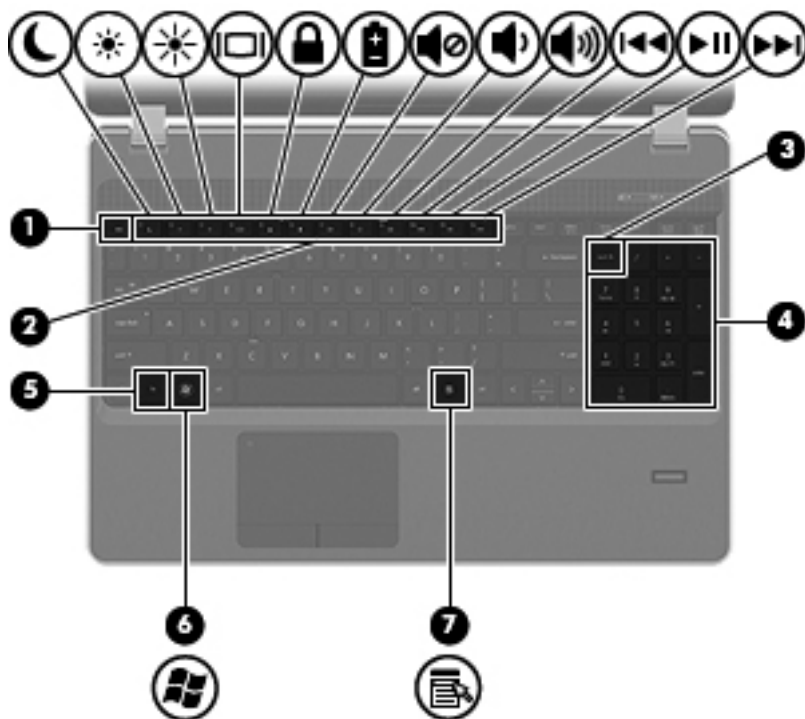

Component	Description
(1) <code>esc</code> key	Displays system information when pressed in combination with the <code>fn</code> key.
(2) Function keys	Execute frequently used system functions when pressed in combination with the <code>fn</code> key.
(3) <code>num lk</code> key (select models only)	Turns the embedded numeric keypad on and off when pressed in combination with the <code>fn</code> key. NOTE: The keypad function that is active when the computer is turned off is reinstated when the computer is turned back on.
(4) <code>fn</code> key	Executes frequently used system functions when pressed in combination with a function key, the <code>num lk</code> key, or the <code>esc</code> key.
(5)  Windows logo key	Displays the Windows Start menu.
(6) Embedded numeric keypad (select models only)	When the keypad is turned on, it can be used like an external numeric keypad. Each key on the keypad performs the function indicated by the icon in the upper-right corner of the key.
(7)  Windows applications key	Displays a shortcut menu for items beneath the cursor.



Component	Description
(1) esc key	Displays system information when pressed in combination with the fn key.
(2) Function keys	Execute frequently used system functions when pressed in combination with the fn key.
(3) num lk key (select models only)	Alternates between the navigational and numeric functions on the integrated numeric keypad. NOTE: The keypad function that is active when the computer is turned off remains on when the computer is turned back on.
(4) Integrated numeric keypad (select models only)	When the num lk has been enabled, it can be used like an external numeric keypad.
(5) fn key	Executes frequently used system functions when pressed in combination with a function key or the esc key.
(6)  Windows logo key	Displays the Windows Start menu.
(7)  Windows applications key	Displays a shortcut menu for items beneath the cursor.







Front

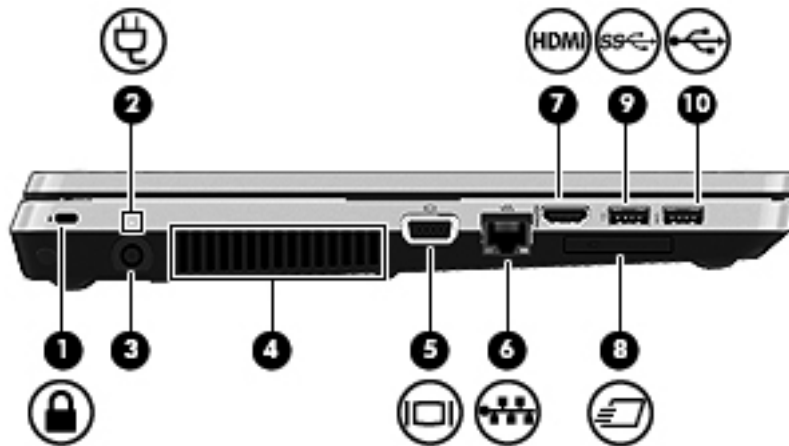



Component	Description
(1)  Hard drive light	<ul style="list-style-type: none">• Blinking White: The hard drive is being accessed.• Amber: HP 3D DriveGuard has temporarily parked the hard drive. <p>NOTE: For information on HP 3D DriveGuard, refer to the <i>HP Notebook Reference Guide</i>.</p>
(2) 6-in-1 Media Card Reader	Supports the following digital card formats: <ul style="list-style-type: none">• Memory Stick Pro• Memory Stick Duo Pro• MultiMediaCard• MultiMediaCard Micro• Secure Digital (SD) Card• Secure Digital (SD) Card Micro
(3)  Audio-out (headphone) jack	Connects optional powered speakers, headphones, earbuds, a headset, or television audio. <p>WARNING! To reduce the risk of personal injury, adjust the volume before putting on headphones, earbuds, or a headset. For additional safety information, refer to the <i>Regulatory, Safety, and Environmental Notices</i></p> <p>NOTE: When a device is connected to the jack, the computer speakers are disabled.</p>
(4)  Audio-in (microphone) jack	Connects an optional computer headset microphone, stereo array microphone, or monaural microphone.

Left





Component	Description
(1)  Security cable slot	Attaches an optional security cable to the computer. NOTE: The security cable is designed to act as a deterrent, but it may not prevent the computer from being mishandled or stolen.
(2)  Battery light	<ul style="list-style-type: none"> Amber: The computer is connected to external power and the battery is 0 to 90% charged. White: The computer is connected to external power and the battery is 90 to 99% charged. Blinking amber: A battery that is the only available power source has reached a low battery level. When the battery reaches a critical battery level, the battery light begins blinking rapidly. Off: The battery is fully charged.
(3) Power connector	Connects an AC adapter.
(4) Vent	Enables airflow to cool internal components. NOTE: The computer fan starts up automatically to cool internal components and prevent overheating. It is normal for the internal fan to cycle on and off during routine operation.
(5)  External monitor port	Connects an external VGA monitor or projector.
(6)  RJ-45 (network) jack	Connects a network cable.
(7)  HDMI port	Connects an optional video or audio device, such as a high-definition television, or any compatible digital or audio component.
(8)  ExpressCard slot	Reads and writes to ExpressCards.

Component	Description
(9)  USB 3.0 port	Connects an optional USB device. NOTE: Some models may show a slightly different icon.
(10)  USB 2.0 port	Connects an optional USB device.

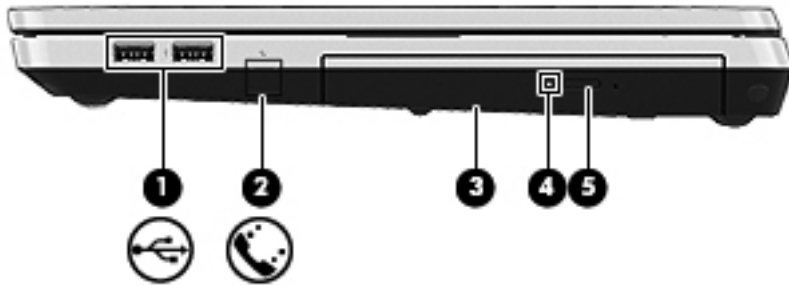

Right

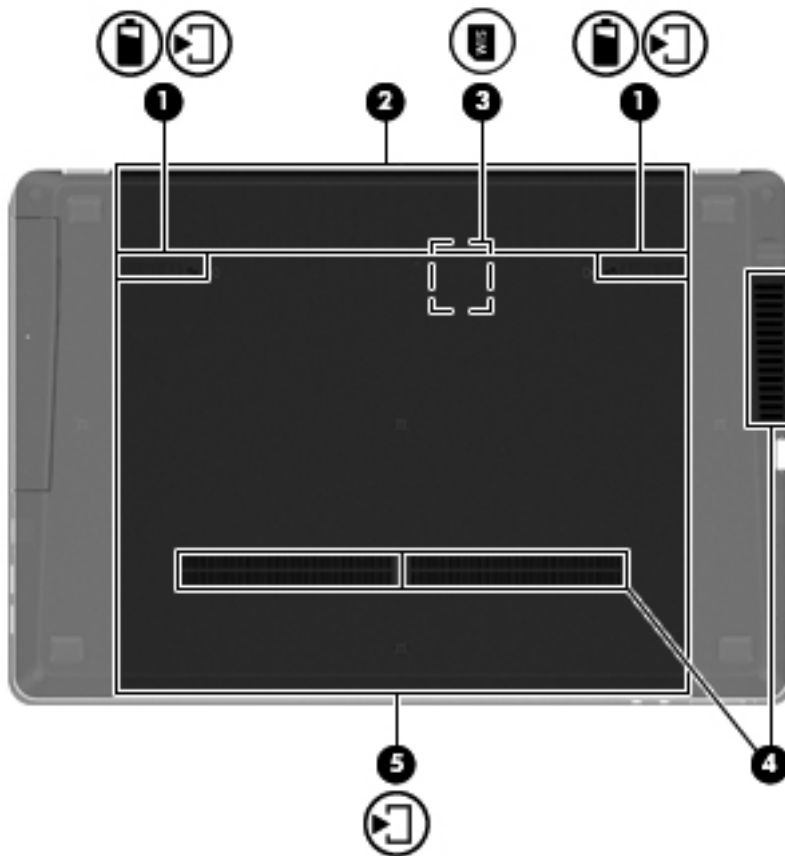

Component	Description
(1)  USB 2.0 ports (2)	Connect optional USB devices.
(2)  RJ-11 (modem) jack (select models only)	Connects a modem cable.
(3) Optical drive (select models only)	Reads and writes (select models only) to an optical disc.
(4) Optical drive light	Lights when the optical drive is active.
(5) Optical drive eject button	Releases the optical drive disc tray.

Bottom



Component	Description
(1) 	Battery and access cover release latches Release the battery from the battery bay and the access cover from the computer.
(2)	Battery bay Holds the battery.
(3) 	SIM slot Supports a wireless subscriber identity module (SIM) (select models only). The SIM slot is located inside the battery bay.
(4)	Vents (2) Enable airflow to cool internal components. NOTE: The computer fan starts up automatically to cool internal components and prevent overheating. It is normal for the internal fan to cycle on and off during routine operation.
(5) 	Hard drive bay and wireless and memory module compartments Holds the hard drive, and also contains the wireless LAN module slot and the memory module slot. CAUTION: To prevent an unresponsive system, replace the wireless module only with a wireless module authorized for use in the computer by the governmental agency that regulates wireless devices in your country or region. If you replace the module and then receive a warning message, remove the module to restore computer functionality, and then contact technical support through Help and Support.

3 Illustrated parts catalog

Service tag

When ordering parts or requesting information, provide the computer serial number and model description provided on the service tag.

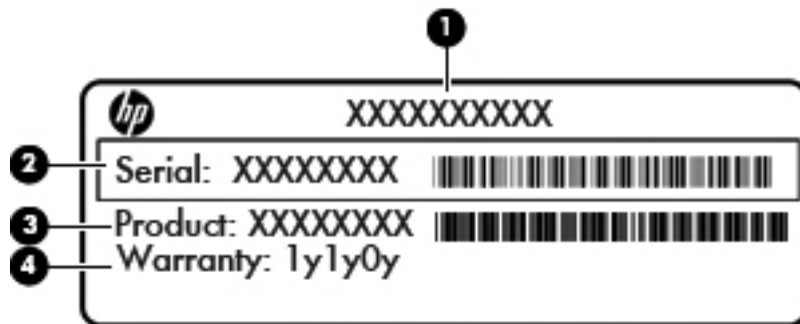

- Product name **(1)**. This is the product name affixed to the front of the computer.
- Serial number (s/n) **(2)**. This is an alphanumeric identifier that is unique to each product.
- Part number/Product number (p/n) **(3)**. This number provides specific information about the product's hardware components. The part number helps a service technician to determine what components and parts are needed.
- Warranty period **(4)**. This number describes the duration (in years) of the warranty period for the computer.

Computer major components

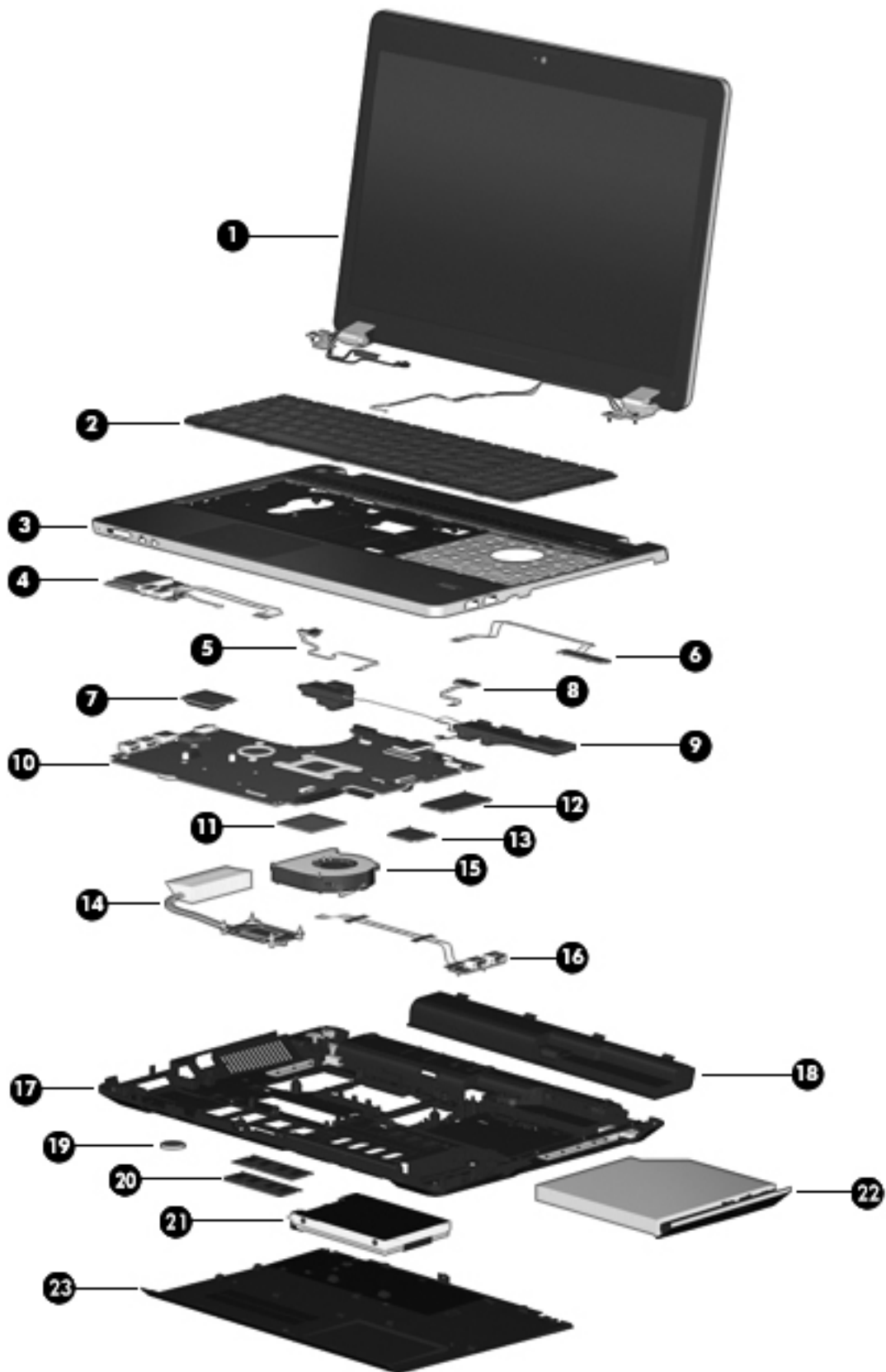

Item	Description	Spare part number
(1)	Display panel	
	39.6-cm (15.6-inch) HD, anti-glare, without webcam	654315-001
	39.6-cm (15.6-inch) HD, anti-glare, with webcam	654313-001
	39.6-cm (15.6-inch) HD, anti-glare, with webcam and WWAN	654317-001
	39.6-cm (15.6-inch) HD, BrightView, without webcam	654321-001
	39.6-cm (15.6-inch) HD, BrightView, with webcam	654319-001
	39.6-cm (15.6-inch) HD, BrightView, with webcam and WWAN	654323-001
(2)	Keyboard (includes cable)	646300-xxx
	NOTE: For a detailed list of available keyboards, see Sequential part number listing on page 29 .	
(3)	Top cover (includes Touchpad board)	
	With a fingerprint reader board	646251-001
	With a fingerprint reader board and no USB logo	679919-001
	Without a fingerprint reader board	646253-001
	Without a fingerprint reader board and no USB logo	679920-001
(4)	Card reader board	646292-001
(5)	Power button board	646294-001
(6)	Quick Launch board	646296-001
(7)	Modem module	628824-001
	NOTE: The modem module spare part kit does not include a modem module cable. The modem module cable is included in the Cable Kit, spare part number 646303-001. See Cable Kit on page 27 for more Cable Kit spare part number information.	
(8)	Lid switch board	646289-001
(9)	Speaker assembly (includes housing)	646298-001
(10)	System board (includes replacement thermal material)	
	For use in models with 1-GB of discrete memory	654306-001
	For use in models with 512-MB of discrete memory	654307-001
	For use in models with UMA graphics with WWAN	654309-001
	For use in models with UMA graphics without WWAN	654308-001
(11)	Processor (includes thermal material)	
	AMD E2-3000M APU (2.4-GHz/1.8-GHz, 1-MB L2 cache)	653351-001
	AMD A6-3420M (2.4-GHz/1.5-GHz, 4-MB L2 cache)	669688-001
	AMD A6-3400M (2.3-GHz/1.4-GHz, 4-MB L2 cache)	653349-001
	AMD A4-3320M (2.6-GHz/2.0-GHz, 2-MB L2 cache)	669686-001
	AMD A4-3305M (2.5-GHz/1.9-GHz, 1-MB L2 cache)	672093-001

Item	Description	Spare part number
	AMD A4-3300M (2.5-GHz/1.9-GHz, 2-MB L2 cache)	653348-001
(12)	WWAN modules	
	HP Ic2010 HSPA Mobile Broadband Module	632155-001
	HP un2430 EV-DO/HSPA Mobile Broadband Module	634400-001
	HP Ic2010 HSPA Mobile Broadband Module	612600-001
(13)	WLAN module	
	Atheros AR9002WB-1NGB 802.11b/g/n 1x1 WiFi and Bluetooth 2.1+EDR Combo Adapter for use in Afghanistan, Albania, Algeria, Andorra, Angola, Antigua and Barbuda, Argentina, Armenia, Aruba, Australia, Austria, Azerbaijan, Bahamas, Bahrain, Bangladesh, Barbados, Belarus, Belgium, Belize, Benin, Bermuda, Bhutan, Bolivia, Bosnia and Herzegovina, Botswana, Brazil, the British Virgin Islands, Brunei, Bulgaria, Burkina Faso, Burundi, Cambodia, Cameroon, Canada, Cape Verde, the Cayman Islands, Central African Republic, Chad, Chile, People's Republic of China, Colombia, Comoros, Congo, Costa Rica, Croatia, Cyprus, the Czech Republic, Denmark, Djibouti, Dominica, the Dominican Republic, East Timor, Ecuador, Egypt, El Salvador, Equatorial Guinea, Eritrea, Estonia, Ethiopia, Fiji, Finland, France, French Guiana, Gabon, Gambia, Georgia, Germany, Ghana, Gibraltar, Greece, Grenada, Guadeloupe, Guam, Guatemala, Guinea, Guinea-Bissa, Guyana, Haiti, Honduras, Hong Kong, Hungary, Iceland, India, Indonesia, Ireland, Israel, Italy, Ivory Coast, Jamaica, Japan, Jordan, Kazakhstan, Kenya, Kiribati, Kuwait, Kyrgyzstan, Laos, Latvia, Lebanon, Lesotho, Liberia, Liechtenstein, Lithuania, Luxembourg, Macedonia, Madagascar, Malawi, Malaysia, Maldives, Mali, Malta, Marshall Islands, Martinique, Mauritania, Mauritius, Mexico, Micronesia, Monaco, Mongolia, Montenegro, Morocco, Mozambique, Namibia, Nauru, Nepal, the Nether Antilles, the Netherlands, New Zealand, Nicaragua, Niger, Nigeria, Norway, Oman, Pakistan, Palau, Panama, Papua New Guinea, Paraguay, Puerto Rico, Peru, Philippines, Poland, Portugal, Qatar, Republic of Moldova, Romania, Russia, Rwanda, Samoa, San Marino, Sao Tome and Principe, Saudi Arabia, Senegal, Serbia and Montenegro, Seychelles, Sierra Leone, Singapore, Slovakia, Slovenia, Solomon Islands, Somalia, South Africa, South Korea, Spain, Sri Lanka, St. Kitts and Nevis, St. Lucia, St. Vincent and the Grenadines, Suriname, Swaziland, Sweden, Switzerland, Syria, Taiwan, Tajikistan, Tanzania, Thailand, Togo, Tonga, Trinidad and Tobago, Tunisia, Turkey, Turkmenistan, Tuvalu, Uganda, Ukraine, the United Arab Emirates, the United Kingdom, Uruguay, the United States, the US Virgin Islands, Uzbekistan, Vanuatu, Venezuela, Vietnam, Yemen, Zaire, Zambia, and Zimbabwe	593127-001

Item	Description	Spare part number
	Realtek 8188BC8 802.11a/b/g/n 2x2 WiFi and Bluetooth 3.0+HS Combo Adapter for use in Afghanistan, Albania, Algeria, Andorra, Angola, Antigua and Barbuda, Argentina, Armenia, Aruba, Australia, Austria, Azerbaijan, Bahamas, Bahrain, Baltics, Bangladesh, Barbados, Belarus, Belgium, Belize, Benin, Bermuda, Bhutan, Bolivia, Bosnia and Herzegovina, Botswana, Brazil, the British Virgin Islands, Brunei, Bulgaria, Burkina Faso, Burundi, Cambodia, Cameroon, Canada, Cape Verde, the Cayman Islands, Central African Republic, Chad, Chile, People's Republic of China, Colombia, Comoros, Congo, Costa Rica, Croatia, Cyprus, the Czech Republic, Denmark, Djibouti, Dominica, the Dominican Republic, East Timor, Ecuador, Egypt, El Salvador, Equatorial Guinea, Eritrea, Estonia, Ethiopia, Fiji, Finland, France, French Guiana, Gabon, Gambia, Georgia, Germany, Ghana, Gibraltar, Greece, Grenada, Guadeloupe, Guam, Guatemala, Guinea, Guinea-Bissa, Guyana, Haiti, Honduras, Hong Kong, Hungary, Iceland, India, Indonesia, Iraq, Ireland, Israel, Italy, Ivory Coast, Jamaica, Japan, Jordan, Kazakhstan, Kenya, Kiribati, Kuwait, Kyrgyzstan, Laos, Latvia, Lebanon, Lesotho, Liberia, Liechtenstein, Lithuania, Luxembourg, Macedonia, Madagascar, Malawi, Malaysia, Maldives, Mali, Malta, Marshall Islands, Martinique, Mauritania, Mauritius, Mexico, Micronesia, Monaco, Mongolia, Montenegro, Morocco, Mozambique, Namibia, Nauru, Nepal, the Nether Antilles, the Netherlands, New Zealand, Nicaragua, Niger, Nigeria, Norway, Oman, Pakistan, Palau, Panama, Papua New Guinea, Paraguay, Puerto Rico, Peru, Philippines, Poland, Portugal, Qatar, Republic of Moldova, Romania, Russia, Rwanda, Samoa, San Marino, Sao Tome and Principe, Saudi Arabia, Senegal, Serbia and Montenegro, Seychelles, Sierra Leone, Singapore, Slovakia, Slovenia, Solomon Islands, Somalia, South Africa, South Korea, Spain, Sri Lanka, St. Kitts and Nevis, St. Lucia, St. Vincent and the Grenadines, Suriname, Swaziland, Sweden, Switzerland, Syria, Taiwan, Tajikistan, Tanzania, Thailand, Togo, Tonga, Trinidad and Tobago, Tunisia, Turkey, Turkmenistan, Tuvalu, Uganda, Ukraine, the United Arab Emirates, the United Kingdom, Uruguay, the United States, the US Virgin Islands, Uzbekistan, Vanuatu, Venezuela, Vietnam, Yemen, Zaire, Zambia, and Zimbabwe	602993-001
	Ralink 5390GN 802.11b/g/n 1x1 WiFi Adapter for use in Afghanistan, Albania, Algeria, Andorra, Angola, Antigua and Barbuda, Argentina, Armenia, Aruba, Australia, Austria, Azerbaijan, Bahamas, Bahrain, Baltics, Bangladesh, Barbados, Belarus, Belgium, Belize, Benin, Bermuda, Bhutan, Bolivia, Bosnia and Herzegovina, Botswana, Brazil, the British Virgin Islands, Brunei, Bulgaria, Burkina Faso, Burundi, Cambodia, Cameroon, Canada, Cape Verde, the Cayman Islands, Central African Republic, Chad, Chile, People's Republic of China, Colombia, Comoros, Congo, Costa Rica, Croatia, Cyprus, the Czech Republic, Denmark, Djibouti, Dominica, the Dominican Republic, East Timor, Ecuador, Egypt, El Salvador, Equatorial Guinea, Eritrea, Estonia, Ethiopia, Fiji, Finland, France, French Guiana, Gabon, Gambia, Georgia, Germany, Ghana, Gibraltar, Greece, Grenada, Guadeloupe, Guam, Guatemala, Guinea, Guinea-Bissa, Guyana, Haiti, Honduras, Hong Kong, Hungary, Iceland, India, Indonesia, Iraq, Ireland, Israel, Italy, Ivory Coast, Jamaica, Japan, Jordan, Kazakhstan, Kenya, Kiribati, Kuwait, Kyrgyzstan, Laos, Latvia, Lebanon, Lesotho, Liberia, Liechtenstein, Lithuania, Luxembourg, Macedonia, Madagascar, Malawi, Malaysia, Maldives, Mali, Malta, Marshall Islands, Martinique, Mauritania, Mauritius, Mexico, Micronesia, Monaco, Mongolia, Montenegro, Morocco, Mozambique, Namibia, Nauru, Nepal, the Nether Antilles, the Netherlands, New Zealand, Nicaragua, Niger, Nigeria, Norway, Oman, Pakistan, Palau, Panama, Papua New Guinea, Paraguay, Puerto Rico, Peru, Philippines, Poland, Portugal, Qatar, Republic of Moldova, Romania, Russia, Rwanda, Samoa, San Marino, Sao Tome and Principe, Saudi Arabia, Senegal, Serbia and Montenegro, Seychelles, Sierra Leone, Singapore, Slovakia, Slovenia, Solomon Islands, Somalia, South Africa, South Korea, Spain, Sri Lanka, St. Kitts and Nevis, St. Lucia, St. Vincent and the Grenadines, Suriname, Swaziland, Sweden, Switzerland, Syria, Taiwan, Tajikistan, Tanzania, Thailand, Togo, Tonga, Trinidad and Tobago, Tunisia, Turkey, Turkmenistan, Tuvalu, Uganda, Ukraine, the United Arab Emirates, the United Kingdom, Uruguay, the United States, the US Virgin Islands, Uzbekistan, Vanuatu, Venezuela, Vietnam, Yemen, Zaire, Zambia, and Zimbabwe	630703-001

Item	Description	Spare part number
	Ralink 8190BC8 802.11b/g/n 2x2 WiFi and Bluetooth 3.0+HS Combo Adapter for use in Afghanistan, Albania, Algeria, Andorra, Angola, Antigua and Barbuda, Argentina, Armenia, Aruba, Australia, Austria, Azerbaijan, Bahamas, Bahrain, Baltics, Bangladesh, Barbados, Belarus, Belgium, Belize, Benin, Bermuda, Bhutan, Bolivia, Bosnia and Herzegovina, Botswana, Brazil, the British Virgin Islands, Brunei, Bulgaria, Burkina Faso, Burundi, Cambodia, Cameroon, Canada, Cape Verde, the Cayman Islands, Central African Republic, Chad, Chile, People's Republic of China, Colombia, Comoros, Congo, Costa Rica, Croatia, Cyprus, the Czech Republic, Denmark, Djibouti, Dominica, the Dominican Republic, East Timor, Ecuador, Egypt, El Salvador, Equatorial Guinea, Eritrea, Estonia, Ethiopia, Fiji, Finland, France, French Guiana, Gabon, Gambia, Georgia, Germany, Ghana, Gibraltar, Greece, Grenada, Guadeloupe, Guam, Guatemala, Guinea, Guinea-Bissau, Guyana, Haiti, Honduras, Hong Kong, Hungary, Iceland, India, Indonesia, Iraq, Ireland, Israel, Italy, Ivory Coast, Jamaica, Japan, Jordan, Kazakhstan, Kenya, Kiribati, Kuwait, Kyrgyzstan, Laos, Latvia, Lebanon, Lesotho, Liberia, Liechtenstein, Lithuania, Luxembourg, Macedonia, Madagascar, Malawi, Malaysia, Maldives, Mali, Malta, Marshall Islands, Martinique, Mauritania, Mauritius, Mexico, Micronesia, Monaco, Mongolia, Montenegro, Morocco, Mozambique, Namibia, Nauru, Nepal, the Nether Antilles, the Netherlands, New Zealand, Nicaragua, Niger, Nigeria, Norway, Oman, Pakistan, Palau, Panama, Papua New Guinea, Paraguay, Puerto Rico, Peru, Philippines, Poland, Portugal, Qatar, Republic of Moldova, Romania, Russia, Rwanda, Samoa, San Marino, Sao Tome and Principe, Saudi Arabia, Senegal, Serbia and Montenegro, Seychelles, Sierra Leone, Singapore, Slovakia, Slovenia, Solomon Islands, Somalia, South Africa, South Korea, Spain, Sri Lanka, St. Kitts and Nevis, St. Lucia, St. Vincent and the Grenadines, Suriname, Swaziland, Sweden, Switzerland, Syria, Taiwan, Tajikistan, Tanzania, Thailand, Togo, Tonga, Trinidad and Tobago, Tunisia, Turkey, Turkmenistan, Tuvalu, Uganda, Ukraine, the United Arab Emirates, the United Kingdom, Uruguay, the United States, the US Virgin Islands, Uzbekistan, Vanuatu, Venezuela, Vietnam, Yemen, Zaire, Zambia, and Zimbabwe	630813-001
	Realtek 8188GN 802.11b/g/n 1x1 WiFi Adapter for use in Afghanistan, Albania, Algeria, Andorra, Angola, Antigua and Barbuda, Argentina, Armenia, Aruba, Australia, Austria, Azerbaijan, Bahamas, Bahrain, Baltics, Bangladesh, Barbados, Belarus, Belgium, Belize, Benin, Bermuda, Bhutan, Bolivia, Bosnia and Herzegovina, Botswana, Brazil, the British Virgin Islands, Brunei, Bulgaria, Burkina Faso, Burundi, Cambodia, Cameroon, Canada, Cape Verde, the Cayman Islands, Central African Republic, Chad, Chile, People's Republic of China, Colombia, Comoros, Congo, Costa Rica, Croatia, Cyprus, the Czech Republic, Denmark, Djibouti, Dominica, the Dominican Republic, East Timor, Ecuador, Egypt, El Salvador, Equatorial Guinea, Eritrea, Estonia, Ethiopia, Fiji, Finland, France, French Guiana, Gabon, Gambia, Georgia, Germany, Ghana, Gibraltar, Greece, Grenada, Guadeloupe, Guam, Guatemala, Guinea, Guinea-Bissau, Guyana, Haiti, Honduras, Hong Kong, Hungary, Iceland, India, Indonesia, Iraq, Ireland, Israel, Italy, Ivory Coast, Jamaica, Japan, Jordan, Kazakhstan, Kenya, Kiribati, Kuwait, Kyrgyzstan, Laos, Latvia, Lebanon, Lesotho, Liberia, Liechtenstein, Lithuania, Luxembourg, Macedonia, Madagascar, Malawi, Malaysia, Maldives, Mali, Malta, Marshall Islands, Martinique, Mauritania, Mauritius, Mexico, Micronesia, Monaco, Mongolia, Montenegro, Morocco, Mozambique, Namibia, Nauru, Nepal, the Nether Antilles, the Netherlands, New Zealand, Nicaragua, Niger, Nigeria, Norway, Oman, Pakistan, Palau, Panama, Papua New Guinea, Paraguay, Puerto Rico, Peru, Philippines, Poland, Portugal, Qatar, Republic of Moldova, Romania, Russia, Rwanda, Samoa, San Marino, Sao Tome and Principe, Saudi Arabia, Senegal, Serbia and Montenegro, Seychelles, Sierra Leone, Singapore, Slovakia, Slovenia, Solomon Islands, Somalia, South Africa, South Korea, Spain, Sri Lanka, St. Kitts and Nevis, St. Lucia, St. Vincent and the Grenadines, Suriname, Swaziland, Sweden, Switzerland, Syria, Taiwan, Tajikistan, Tanzania, Thailand, Togo, Tonga, Trinidad and Tobago, Tunisia, Turkey, Turkmenistan, Tuvalu, Uganda, Ukraine, the United Arab Emirates, the United Kingdom, Uruguay, the United States, the US Virgin Islands, Uzbekistan, Vanuatu, Venezuela, Vietnam, Yemen, Zaire, Zambia, and Zimbabwe	640926-001
(14)	Heat sink (includes replacement thermal material)	
	For use in models with discrete graphics	654310-001
	For use in models with UMA graphics	654311-001
(15)	Fan	646285-001

Item	Description	Spare part number
(16)	USB board	646287-001
(17)	Base enclosure	646261-001
(18)	Battery, Li-ion	
	9-cell (93 WHr, 2.8 Ah)	633809-001
	6-cell (55 WHr, 2.8 Ah)	650938-001
	6-cell (47 WHr, 2.2 Ah)	633805-001
(19)	RTC battery	449137-001
(20)	Memory modules (PC3-10600, 1333-MHz, DDR3)	
	4-GB	621569-001
	2-GB	621565-001
	1-GB	639736-001
(21)	Hard drive	
	750-GB, 7200-rpm	633252-001
	750-GB, 5400-rpm	634250-001
	640-GB, 5400-rpm	603785-001
	500-GB, 7200-rpm	634925-001
	500-GB, 5400-rpm	634638-001
	320-GB, 5400-rpm (2.5 in)	622643-001
	320-GB, 5400-rpm (7 mm)	645193-001
	320-GB, 7200-rpm (2.5 in)	641672-001
	320-GB, 7200-rpm (7 mm)	634862-001
	250-GB, 7200-rpm (2.5 in)	635225-001
	250-GB, 7200-rpm (7 mm)	634861-001
	250-GB, 5400-rpm (2.5 in)	622641-001
	250-GB, 5400-rpm (7 mm)	645191-001
(22)	Optical drive (includes bracket, bezel, and screws)	
	Blu-ray BD-R/RE DVD±RW SuperMulti DL Drive	647951-001
	Blu-ray ROM DVD±RW SuperMulti DL Drive	647952-001
	DVD±RW and CD-RW SuperMulti DL Combo Drive	647950-001
	DVD-ROM Drive	647949-001
(23)	Bottom door	646263-001

Display components

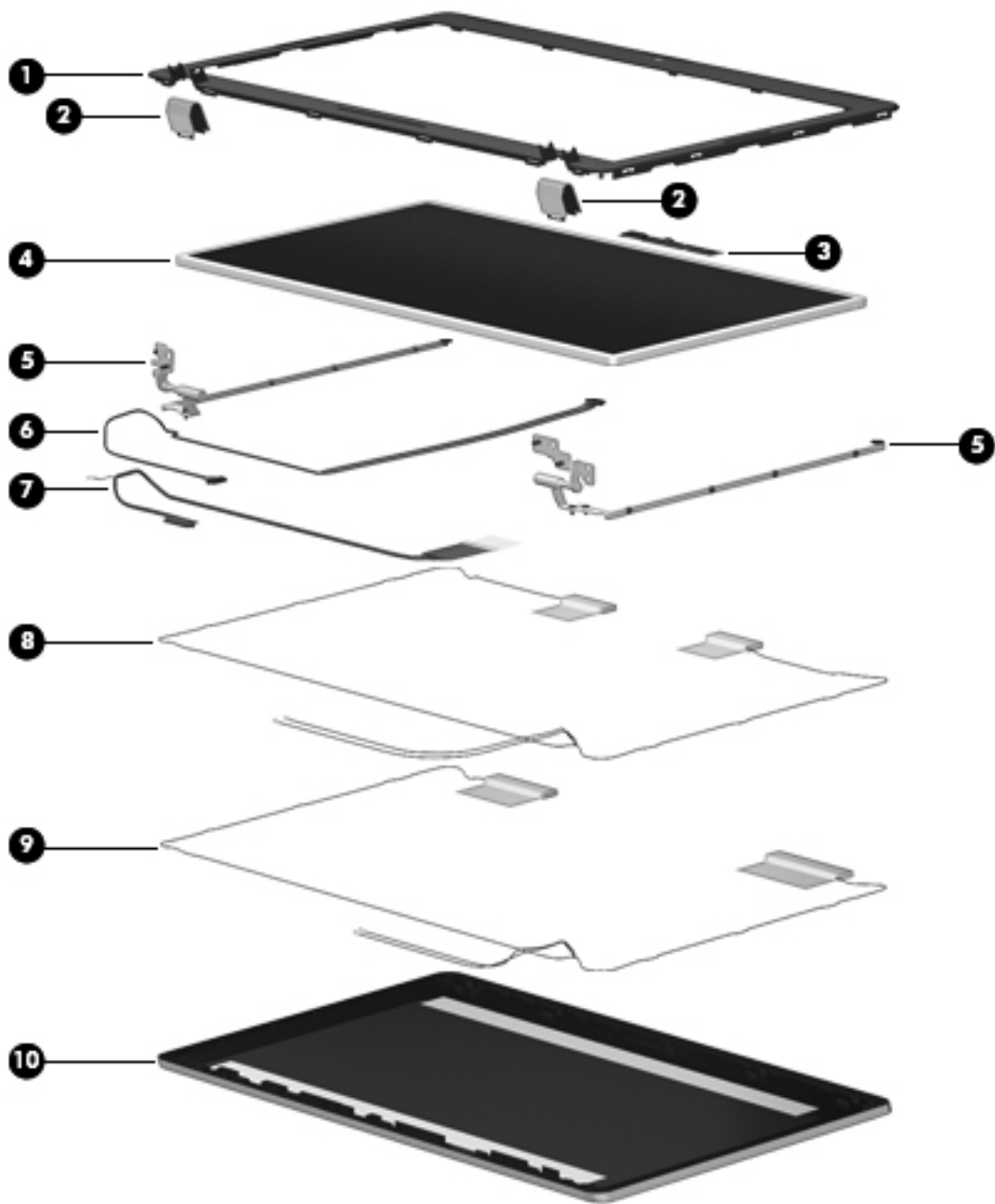

Item	Description	Spare part number
(1)	Display bezel	
	For use with models with a webcam	646266-001
	For use with models without a webcam	646265-001
(2)	Display hinge covers	646281-001
(3)	Webcam module	642795-001
	Microphone module (not illustrated)	642797-001

Item	Description	Spare part number
(4)	Display panel	
	39.6-cm (15.6-inch) HD, anti-glare	646311-001
	39.6-cm (15.6-inch) HD, BrightView	646312-001
(5)	Display hinges (includes left and right hinges)	646279-001
(6)	Webcam cable	646275-001
(7)	Display Cable Kit	
	For use in models without a webcam	605766-001
	For use in models with a webcam	646273-001
(8)	WLAN antennas	646276-001
(9)	WWAN antennas	646278-001
(10)	Display enclosure	646269-001

Plastics Kit



Item	Description	Spare part number
	Plastics Kit	646309-001
(1)	RJ-11 holder	
(2)	Secure Digital card protective insert	
(3)	ExpressCard slot protective insert	
(4)	Optical drive protective insert	

Cable Kit



Item	Description	Spare part number
	Cable Kit	646303-001
(1)	Battery connector cable	
(2)	Power connector cable	
(3)	RJ-11 connector cable	

Mass storage devices

Description	Spare part number
Optical drives	
Blu-ray BD-R/RE DVD±RW SuperMulti DL Drive	647951-001
Blu-ray Disc ROM with SuperMulti DVD±R/RW DL Drive	647952-001
DVD±RW and CD-RW SuperMulti DL Combo Drive	647950-001
DVD-ROM Drive	647949-001
Hard drives	
750-GB, 7200-rpm	633252-001
750-GB, 5400-rpm	634250-001
640-GB, 5400-rpm	603785-001
500-GB, 7200-rpm	634925-001
500-GB, 5400-rpm	634638-001
320-GB, 5400-rpm (2.5 in)	622643-001
320-GB, 5400-rpm (7 mm)	645193-001
320-GB, 7200-rpm (2.5 in)	641672-001
320-GB, 7200-rpm (7 mm)	634862-001
250-GB, 7200-rpm (2.5 in)	635225-001
250-GB, 7200-rpm (7 mm)	634861-001
250-GB, 5400-rpm (2.5 in)	622641-001

Description	Spare part number
250-GB, 5400-rpm (7 mm)	645191-001
Hard Drive Hardware Kit (includes hard drive bracket, insulator, and screws)	647944-001

Miscellaneous parts

Description	Spare part number
AC adapters	
65-W AC adapter	609939-001
90-W AC adapter	609940-001
Power cords:	
For use in Argentina	490371-D01
For use in Brazil	490371-202
For use in Denmark	490371-081
For use in Europe, the Middle East, and Africa	490371-021
For use in Israel	490371-BB1
For use in Italy	490371-061
For use in South Africa	490371-AR1
For use in Switzerland	490371-111
For use in the United Kingdom	490371-031
For use in the United States	490371-001
Rubber Kit (includes SIM bumper and feet)	646307-001
Screw Kit	646305-001
HP keyed cable lock	626729-001
Mouse , optical, 2-button	390632-001
HP optical travel mouse	434594-001
HP basic carrying case	455084-001
Professional slim, top load case	592923-001
Notebook combination lock	591699-001
Nylon case	612757-001

Sequential part number listing

Spare part number	Description
390632-001	Mouse, optical, 2-button
434594-001	HP optical travel mouse
449137-001	RTC battery
455084-001	HP basic carrying case
490371-001	Power cord for use in North America
490371-021	Power cord for use in Europe, the Middle East, and Africa
490371-031	Power cord for use in the United Kingdom
490371-061	Power cord for use in Italy
490371-081	Power cord for use in Denmark
490371-111	Power cord for use in Switzerland
490371-202	Power cord for use in Brazil
490371-AR1	Power cord for use in South Africa
490371-BB1	Power cord for use in Israel
490371-D01	Power cord for use in Argentina
591699-001	Notebook combination lock
592923-001	Professional slim, top load case
593127-001	Atheros AR9002WB-1NGB 802.11b/g/n 1x1 WiFi and Bluetooth 2.1+EDR Combo Adapter for use in Afghanistan, Albania, Algeria, Andorra, Angola, Antigua and Barbuda, Argentina, Armenia, Aruba, Australia, Austria, Azerbaijan, Bahamas, Bahrain, Bangladesh, Barbados, Belarus, Belgium, Belize, Benin, Bermuda, Bhutan, Bolivia, Bosnia and Herzegovina, Botswana, Brazil, the British Virgin Islands, Brunei, Bulgaria, Burkina Faso, Burundi, Cambodia, Cameroon, Canada, Cape Verde, the Cayman Islands, Central African Republic, Chad, Chile, People's Republic of China, Colombia, Comoros, Congo, Costa Rica, Croatia, Cyprus, the Czech Republic, Denmark, Djibouti, Dominica, the Dominican Republic, East Timor, Ecuador, Egypt, El Salvador, Equatorial Guinea, Eritrea, Estonia, Ethiopia, Fiji, Finland, France, French Guiana, Gabon, Gambia, Georgia, Germany, Ghana, Gibraltar, Greece, Grenada, Guadeloupe, Guam, Guatemala, Guinea, Guinea-Bissau, Guyana, Haiti, Honduras, Hong Kong, Hungary, Iceland, India, Indonesia, Ireland, Israel, Italy, Ivory Coast, Jamaica, Japan, Jordan, Kazakhstan, Kenya, Kiribati, Kuwait, Kyrgyzstan, Laos, Latvia, Lebanon, Lesotho, Liberia, Liechtenstein, Lithuania, Luxembourg, Macedonia, Madagascar, Malawi, Malaysia, Maldives, Mali, Malta, Marshall Islands, Martinique, Mauritania, Mauritius, Mexico, Micronesia, Monaco, Mongolia, Montenegro, Morocco, Mozambique, Namibia, Nauru, Nepal, the Nether Antilles, the Netherlands, New Zealand, Nicaragua, Niger, Nigeria, Norway, Oman, Pakistan, Palau, Panama, Papua New Guinea, Paraguay, Puerto Rico, Peru, Philippines, Poland, Portugal, Qatar, Republic of Moldova, Romania, Russia, Rwanda, Samoa, San Marino, Sao Tome and Principe, Saudi Arabia, Senegal, Serbia and Montenegro, Seychelles, Sierra Leone, Singapore, Slovakia, Slovenia, Solomon Islands, Somalia, South Africa, South Korea, Spain, Sri Lanka, St. Kitts and Nevis, St. Lucia, St. Vincent and the Grenadines, Suriname, Swaziland, Sweden, Switzerland, Syria, Taiwan, Tajikistan, Tanzania, Thailand, Togo, Tonga, Trinidad and Tobago, Tunisia, Turkey, Turkmenistan, Tuvalu, Uganda, Ukraine, the United Arab Emirates, the United Kingdom, Uruguay, the United States, the US Virgin Islands, Uzbekistan, Vanuatu, Venezuela, Vietnam, Yemen, Zaire, Zambia, and Zimbabwe

Spare part number	Description
602993-001	Realtek 8188BC8 802.11a/b/g/n 2x2 WiFi and Bluetooth 3.0+HS Combo Adapter for use in Afghanistan, Albania, Algeria, Andorra, Angola, Antigua and Barbuda, Argentina, Armenia, Aruba, Australia, Austria, Azerbaijan, Bahamas, Bahrain, Baltics, Bangladesh, Barbados, Belarus, Belgium, Belize, Benin, Bermuda, Bhutan, Bolivia, Bosnia and Herzegovina, Botswana, Brazil, the British Virgin Islands, Brunei, Bulgaria, Burkina Faso, Burundi, Cambodia, Cameroon, Canada, Cape Verde, the Cayman Islands, Central African Republic, Chad, Chile, People's Republic of China, Colombia, Comoros, Congo, Costa Rica, Croatia, Cyprus, the Czech Republic, Denmark, Djibouti, Dominica, the Dominican Republic, East Timor, Ecuador, Egypt, El Salvador, Equatorial Guinea, Eritrea, Estonia, Ethiopia, Fiji, Finland, France, French Guiana, Gabon, Gambia, Georgia, Germany, Ghana, Gibraltar, Greece, Grenada, Guadeloupe, Guam, Guatemala, Guinea, Guinea-Bissa, Guyana, Haiti, Honduras, Hong Kong, Hungary, Iceland, India, Indonesia, Iraq, Ireland, Israel, Italy, Ivory Coast, Jamaica, Japan, Jordan, Kazakhstan, Kenya, Kiribati, Kuwait, Kyrgyzstan, Laos, Latvia, Lebanon, Lesotho, Liberia, Liechtenstein, Lithuania, Luxembourg, Macedonia, Madagascar, Malawi, Malaysia, Maldives, Mali, Malta, Marshall Islands, Martinique, Mauritania, Mauritius, Mexico, Micronesia, Monaco, Mongolia, Montenegro, Morocco, Mozambique, Namibia, Nauru, Nepal, the Nether Antilles, the Netherlands, New Zealand, Nicaragua, Niger, Nigeria, Norway, Oman, Pakistan, Palau, Panama, Papua New Guinea, Paraguay, Puerto Rico, Peru, Philippines, Poland, Portugal, Qatar, Republic of Moldova, Romania, Russia, Rwanda, Samoa, San Marino, Sao Tome and Principe, Saudi Arabia, Senegal, Serbia and Montenegro, Seychelles, Sierra Leone, Singapore, Slovakia, Slovenia, Solomon Islands, Somalia, South Africa, South Korea, Spain, Sri Lanka, St. Kitts and Nevis, St. Lucia, St. Vincent and the Grenadines, Suriname, Swaziland, Sweden, Switzerland, Syria, Taiwan, Tajikistan, Tanzania, Thailand, Togo, Tonga, Trinidad and Tobago, Tunisia, Turkey, Turkmenistan, Tuvalu, Uganda, Ukraine, the United Arab Emirates, the United Kingdom, Uruguay, the United States, the US Virgin Islands, Uzbekistan, Vanuatu, Venezuela, Vietnam, Yemen, Zaire, Zambia, and Zimbabwe
603785-001	640-GB, 5400-rpm hard drive
605766-001	Display Cable Kit for use in models without a webcam
609939-001	65-W AC adapter
609940-001	90-W AC adapter
612600-001	HP Ic2010 HSPA Mobile Broadband Module
612757-001	Nylon case
621565-001	2-GB memory module (PC3-10600, 1333-MHz, DDR3)
621569-001	4-GB memory module (PC3-10600, 1333-MHz, DDR3)
622641-001	250-GB, 5400-rpm hard drive (2.5 in)
622643-001	320-GB, 5400-rpm hard drive (2.5 in)
626729-001	HP keyed cable lock
628824-001	Modem module
	NOTE: The modem module spare part kit does not include a modem module cable. The modem module cable is included in the Cable Kit, spare part number 646303-001. See Cable Kit on page 27 for more Cable Kit spare part number information.

Spare part number	Description
630703-001	Ralink 5390GN 802.11b/g/n 1x1 WiFi Adapter for use in Afghanistan, Albania, Algeria, Andorra, Angola, Antigua and Barbuda, Argentina, Armenia, Aruba, Australia, Austria, Azerbaijan, Bahamas, Bahrain, Baltics, Bangladesh, Barbados, Belarus, Belgium, Belize, Benin, Bermuda, Bhutan, Bolivia, Bosnia and Herzegovina, Botswana, Brazil, the British Virgin Islands, Brunei, Bulgaria, Burkina Faso, Burundi, Cambodia, Cameroon, Canada, Cape Verde, the Cayman Islands, Central African Republic, Chad, Chile, People's Republic of China, Colombia, Comoros, Congo, Costa Rica, Croatia, Cyprus, the Czech Republic, Denmark, Djibouti, Dominica, the Dominican Republic, East Timor, Ecuador, Egypt, El Salvador, Equatorial Guinea, Eritrea, Estonia, Ethiopia, Fiji, Finland, France, French Guiana, Gabon, Gambia, Georgia, Germany, Ghana, Gibraltar, Greece, Grenada, Guadeloupe, Guam, Guatemala, Guinea, Guinea-Bissa, Guyana, Haiti, Honduras, Hong Kong, Hungary, Iceland, India, Indonesia, Iraq, Ireland, Israel, Italy, Ivory Coast, Jamaica, Japan, Jordan, Kazakhstan, Kenya, Kiribati, Kuwait, Kyrgyzstan, Laos, Latvia, Lebanon, Lesotho, Liberia, Liechtenstein, Lithuania, Luxembourg, Macedonia, Madagascar, Malawi, Malaysia, Maldives, Mali, Malta, Marshall Islands, Martinique, Mauritania, Mauritius, Mexico, Micronesia, Monaco, Mongolia, Montenegro, Morocco, Mozambique, Namibia, Nauru, Nepal, the Nether Antilles, the Netherlands, New Zealand, Nicaragua, Niger, Nigeria, Norway, Oman, Pakistan, Palau, Panama, Papua New Guinea, Paraguay, Puerto Rico, Peru, Philippines, Poland, Portugal, Qatar, Republic of Moldova, Romania, Russia, Rwanda, Samoa, San Marino, Sao Tome and Principe, Saudi Arabia, Senegal, Serbia and Montenegro, Seychelles, Sierra Leone, Singapore, Slovakia, Slovenia, Solomon Islands, Somalia, South Africa, South Korea, Spain, Sri Lanka, St. Kitts and Nevis, St. Lucia, St. Vincent and the Grenadines, Suriname, Swaziland, Sweden, Switzerland, Syria, Taiwan, Tajikistan, Tanzania, Thailand, Togo, Tonga, Trinidad and Tobago, Tunisia, Turkey, Turkmenistan, Tuvalu, Uganda, Ukraine, the United Arab Emirates, the United Kingdom, Uruguay, the United States, the US Virgin Islands, Uzbekistan, Vanuatu, Venezuela, Vietnam, Yemen, Zaire, Zambia, and Zimbabwe
630813-001	Ralink 8190BC8 802.11b/g/n 2x2 WiFi and Bluetooth 3.0+HS Combo Adapter for use in Afghanistan, Albania, Algeria, Andorra, Angola, Antigua and Barbuda, Argentina, Armenia, Aruba, Australia, Austria, Azerbaijan, Bahamas, Bahrain, Baltics, Bangladesh, Barbados, Belarus, Belgium, Belize, Benin, Bermuda, Bhutan, Bolivia, Bosnia and Herzegovina, Botswana, Brazil, the British Virgin Islands, Brunei, Bulgaria, Burkina Faso, Burundi, Cambodia, Cameroon, Canada, Cape Verde, the Cayman Islands, Central African Republic, Chad, Chile, People's Republic of China, Colombia, Comoros, Congo, Costa Rica, Croatia, Cyprus, the Czech Republic, Denmark, Djibouti, Dominica, the Dominican Republic, East Timor, Ecuador, Egypt, El Salvador, Equatorial Guinea, Eritrea, Estonia, Ethiopia, Fiji, Finland, France, French Guiana, Gabon, Gambia, Georgia, Germany, Ghana, Gibraltar, Greece, Grenada, Guadeloupe, Guam, Guatemala, Guinea, Guinea-Bissa, Guyana, Haiti, Honduras, Hong Kong, Hungary, Iceland, India, Indonesia, Iraq, Ireland, Israel, Italy, Ivory Coast, Jamaica, Japan, Jordan, Kazakhstan, Kenya, Kiribati, Kuwait, Kyrgyzstan, Laos, Latvia, Lebanon, Lesotho, Liberia, Liechtenstein, Lithuania, Luxembourg, Macedonia, Madagascar, Malawi, Malaysia, Maldives, Mali, Malta, Marshall Islands, Martinique, Mauritania, Mauritius, Mexico, Micronesia, Monaco, Mongolia, Montenegro, Morocco, Mozambique, Namibia, Nauru, Nepal, the Nether Antilles, the Netherlands, New Zealand, Nicaragua, Niger, Nigeria, Norway, Oman, Pakistan, Palau, Panama, Papua New Guinea, Paraguay, Puerto Rico, Peru, Philippines, Poland, Portugal, Qatar, Republic of Moldova, Romania, Russia, Rwanda, Samoa, San Marino, Sao Tome and Principe, Saudi Arabia, Senegal, Serbia and Montenegro, Seychelles, Sierra Leone, Singapore, Slovakia, Slovenia, Solomon Islands, Somalia, South Africa, South Korea, Spain, Sri Lanka, St. Kitts and Nevis, St. Lucia, St. Vincent and the Grenadines, Suriname, Swaziland, Sweden, Switzerland, Syria, Taiwan, Tajikistan, Tanzania, Thailand, Togo, Tonga, Trinidad and Tobago, Tunisia, Turkey, Turkmenistan, Tuvalu, Uganda, Ukraine, the United Arab Emirates, the United Kingdom, Uruguay, the United States, the US Virgin Islands, Uzbekistan, Vanuatu, Venezuela, Vietnam, Yemen, Zaire, Zambia, and Zimbabwe
632155-001	HP Ic2010 HSPA Mobile Broadband Module
633252-001	750-GB, 7200-rpm hard drive
633805-001	6-cell, 47 WHr, 2.2 Ah Li-ion battery
633809-001	9-cell, 93 WHr, 2.8 Ah Li-ion battery
634250-001	750-GB, 5400-rpm hard drive
634400-001	HP un2430 EV-DO/HSPA Mobile Broadband Module
634638-001	500-GB, 5400-rpm hard drive
634861-001	250-GB, 7200-rpm (7 mm)

Spare part number	Description
634862-001	320-GB, 7200-rpm hard drive (7 mm)
634925-001	500-GB, 7200-rpm hard drive
635225-001	250-GB, 7200-rpm hard drive (2.5 in)
639736-001	1-GB memory module (PC3-10600, 1333-MHz, DDR3)
640926-001	Realtek 8188GN 802.11b/g/n 1x1 WiFi Adapter for use in Afghanistan, Albania, Algeria, Andorra, Angola, Antigua and Barbuda, Argentina, Armenia, Aruba, Australia, Austria, Azerbaijan, Bahamas, Bahrain, Baltics, Bangladesh, Barbados, Belarus, Belgium, Belize, Benin, Bermuda, Bhutan, Bolivia, Bosnia and Herzegovina, Botswana, Brazil, the British Virgin Islands, Brunei, Bulgaria, Burkina Faso, Burundi, Cambodia, Cameroon, Canada, Cape Verde, the Cayman Islands, Central African Republic, Chad, Chile, People's Republic of China, Colombia, Comoros, Congo, Costa Rica, Croatia, Cyprus, the Czech Republic, Denmark, Djibouti, Dominica, the Dominican Republic, East Timor, Ecuador, Egypt, El Salvador, Equatorial Guinea, Eritrea, Estonia, Ethiopia, Fiji, Finland, France, French Guiana, Gabon, Gambia, Georgia, Germany, Ghana, Gibraltar, Greece, Grenada, Guadeloupe, Guam, Guatemala, Guinea, Guinea-Bissau, Guyana, Haiti, Honduras, Hong Kong, Hungary, Iceland, India, Indonesia, Iraq, Ireland, Israel, Italy, Ivory Coast, Jamaica, Japan, Jordan, Kazakhstan, Kenya, Kiribati, Kuwait, Kyrgyzstan, Laos, Latvia, Lebanon, Lesotho, Liberia, Liechtenstein, Lithuania, Luxembourg, Macedonia, Madagascar, Malawi, Malaysia, Maldives, Mali, Malta, Marshall Islands, Martinique, Mauritania, Mauritius, Mexico, Micronesia, Monaco, Mongolia, Montenegro, Morocco, Mozambique, Namibia, Nauru, Nepal, the Nether Antilles, the Netherlands, New Zealand, Nicaragua, Niger, Nigeria, Norway, Oman, Pakistan, Palau, Panama, Papua New Guinea, Paraguay, Puerto Rico, Peru, Philippines, Poland, Portugal, Qatar, Republic of Moldova, Romania, Russia, Rwanda, Samoa, San Marino, Sao Tome and Principe, Saudi Arabia, Senegal, Serbia and Montenegro, Seychelles, Sierra Leone, Singapore, Slovakia, Slovenia, Solomon Islands, Somalia, South Africa, South Korea, Spain, Sri Lanka, St. Kitts and Nevis, St. Lucia, St. Vincent and the Grenadines, Suriname, Swaziland, Sweden, Switzerland, Syria, Taiwan, Tajikistan, Tanzania, Thailand, Togo, Tonga, Trinidad and Tobago, Tunisia, Turkey, Turkmenistan, Tuvalu, Uganda, Ukraine, the United Arab Emirates, the United Kingdom, Uruguay, the United States, the US Virgin Islands, Uzbekistan, Vanuatu, Venezuela, Vietnam, Yemen, Zaire, Zambia, and Zimbabwe
641672-001	320-GB, 7200-rpm (2.5 in)
642795-001	Webcam module
642797-001	Microphone module
645191-001	250-GB, 5400-rpm (7 mm)
645193-001	320-GB, 5400-rpm (7 mm)
646251-001	Top cover for use in models with a fingerprint reader (includes fingerprint reader board)
646253-001	Top cover for use in models without a fingerprint reader
646261-001	Base enclosure
646263-001	Bottom door
646265-001	Display bezel for use with models without a webcam
646266-001	Display bezel for use with models with a webcam
646269-001	Display enclosure
646273-001	Display Cable Kit for use in models with a webcam
646275-001	Webcam cable
646276-001	WLAN antennas
646278-001	WWAN antennas
646279-001	Display hinges (includes left and right hinges)

Spare part number	Description
646281-001	Display hinge covers
646282-001	Display hinge covers
646285-001	Fan
646287-001	USB board
646289-001	Lid switch board
646292-001	Card reader board
646294-001	Power button board
646296-001	Quick Launch board
646298-001	Speaker assembly (includes housing)
646300-001	Keyboard for use in the United States
646300-031	Keyboard for use in the United Kingdom
646300-041	Keyboard for use in Germany
646300-051	Keyboard for use in France
646300-061	Keyboard for use in Italy
646300-071	Keyboard for use in Spain
646300-121	Keyboard for use in French Canada
646300-131	Keyboard for use in Portugal
646300-141	Keyboard for use in Turkey
646300-161	Keyboard for use in Latin America
646300-171	Keyboard for use in Saudi Arabia
646300-211	Keyboard for use Hungary
646300-251	Keyboard for use in Russia
646300-261	Keyboard for use in Bulgaria
646300-A41	Keyboard for use in Belgium
646300-A81	Keyboard for use in the Czech Republic
646300-B31	Keyboard for use in the Netherlands and Europe
646300-BA1	Keyboard for use in Slovakia
646300-BB1	Keyboard for use in Israel
646300-BG1	Keyboard for use in Switzerland
646300-DD1	Keyboard for use in Iceland
646300-DH1	Keyboard for use in the Netherlands
646300-DJ1	Keyboard for use in Greece
646300-DW1	Keyboard for use in the French Arabic region
646303-001	Cable Kit (see Cable Kit on page 27 for more Cable Kit spare part information)

Spare part number	Description
646305-001	Screw Kit
646307-001	Rubber Kit (includes SIM bumper and feet)
646309-001	Plastics Kit
646311-001	Display panel, 39.6-cm (15.6-inch) HD, anti-glare
646312-001	Display panel, 39.6-cm (15.6-inch) HD, BrightView
647944-001	Hard Drive Hardware Kit (includes hard drive bracket, insulator, and screws)
647949-001	DVD-ROM drive (includes bracket, bezel, and screws)
647950-001	DVD±RW and CD-RW SuperMulti DL combo drive (includes bracket, bezel, and screws)
647951-001	Blu-ray BD-R/RE DVD±RW SuperMulti DL Drive (includes bracket, bezel, and screws)
647952-001	Blu-ray ROM DVD±RW SuperMulti DL Drive (includes bracket, bezel, and screws)
650938-001	6-cell, 55 WHr, 2.8 Ah Li-ion battery
653348-001	AMD A4-3300M APU (2.5-GHz/1.9-GHz, 2-MB L2 cache)
653349-001	AMD A6-3400M APU (2.3-GHz/1.4-GHz, 4-MB L2 cache)
653351-001	AMD E2-3000M APU (2.4-GHz/1.8-GHz, 1-MB L2 cache)
654306-001	System board for use in models with 1-GB of discrete memory
654307-001	System board for use in models with 512-MB of discrete memory
654308-001	System board for use in models with UMA graphics without WWAN
654309-001	System board for use in models with UMA graphics with WWAN
654310-001	Heat sink for use in computers with discrete graphics
654311-001	Heat sink for use in computers with UMA graphics
654313-001	39.6-cm (15.6-inch) display assembly, HD, anti-glare, with webcam
654315-001	39.6-cm (15.6-inch) display assembly, HD, anti-glare, without webcam
654317-001	39.6-cm (15.6-inch) display assembly, HD, anti-glare, with webcam and WWAN
654319-001	39.6-cm (15.6-inch) display assembly, HD, BrightView, with webcam
654321-001	39.6-cm (15.6-inch) display assembly, HD, BrightView, without webcam
654323-001	39.6-cm (15.6-inch) display assembly, HD, BrightView, with webcam and WWAN
679919-001	Top cover for use in models with a fingerprint reader and no USB logo (includes fingerprint reader board)
679920-001	Top cover for use in models without a fingerprint reader and no USB logo
669686-001	AMD A4-3320M APU (2.6-GHz/2.0-GHz, 2-MB L2 cache)
669688-001	AMD A6-3420M APU (2.4-GHz/1.5-GHz, 4-MB L2 cache)
672093-001	AMD A4-3305M APU (2.5-GHz/1.9-GHz, 1-MB L2 cache)

4 Removal and replacement procedures

Preliminary replacement requirements

Tools required

You will need the following tools to complete the removal and replacement procedures:

- Flat-bladed screwdriver
- Phillips P0 and P1 screwdrivers
- Torx T8 screwdriver

Service considerations

The following sections include some of the considerations that you must keep in mind during disassembly and assembly procedures.

 **NOTE:** As you remove each subassembly from the computer, place the subassembly (and all accompanying screws) away from the work area to prevent damage.

Plastic parts

 **CAUTION:** Using excessive force during disassembly and reassembly can damage plastic parts. Use care when handling the plastic parts. Apply pressure only at the points designated in the maintenance instructions.

Cables and connectors

⚠ CAUTION: When servicing the computer, be sure that cables are placed in their proper locations during the reassembly process. Improper cable placement can damage the computer.

Cables must be handled with extreme care to avoid damage. Apply only the tension required to unseat or seat the cables during removal and insertion. Handle cables by the connector whenever possible. In all cases, avoid bending, twisting, or tearing cables. Be sure that cables are routed in such a way that they cannot be caught or snagged by parts being removed or replaced. Handle flex cables with extreme care; these cables tear easily.

Drive handling

⚠ CAUTION: Drives are fragile components that must be handled with care. To prevent damage to the computer, damage to a drive, or loss of information, observe these precautions:

Before removing or inserting a hard drive, shut down the computer. If you are unsure whether the computer is off or in Hibernation, turn the computer on, and then shut it down through the operating system.

Before handling a drive, be sure that you are discharged of static electricity. While handling a drive, avoid touching the connector.

Before removing a diskette drive or optical drive, be sure that a diskette or disc is not in the drive and be sure that the optical drive tray is closed.

Handle drives on surfaces covered with at least one inch of shock-proof foam.

Avoid dropping drives from any height onto any surface.

After removing a hard drive, an optical drive, or a diskette drive, place it in a static-proof bag.

Avoid exposing a hard drive to products that have magnetic fields, such as monitors or speakers.

Avoid exposing a drive to temperature extremes or liquids.

If a drive must be mailed, place the drive in a bubble pack mailer or other suitable form of protective packaging and label the package "FRAGILE."

Grounding guidelines

Electrostatic discharge damage

Electronic components are sensitive to electrostatic discharge (ESD). Circuitry design and structure determine the degree of sensitivity. Networks built into many integrated circuits provide some protection, but in many cases, ESD contains enough power to alter device parameters or melt silicon junctions.

A discharge of static electricity from a finger or other conductor can destroy static-sensitive devices or microcircuitry. Even if the spark is neither felt nor heard, damage may have occurred.

An electronic device exposed to ESD may not be affected at all and can work perfectly throughout a normal cycle. Or the device may function normally for a while, and then degrade in the internal layers, reducing its life expectancy.

CAUTION: To prevent damage to the computer when you are removing or installing internal components, observe these precautions:

Keep components in their electrostatic-safe containers until you are ready to install them.

Use nonmagnetic tools.

Before touching an electronic component, discharge static electricity by using the guidelines described in this section.

Avoid touching pins, leads, and circuitry. Handle electronic components as little as possible.

If you remove a component, place it in an electrostatic-safe container.

The following table shows how humidity affects the electrostatic voltage levels generated by different activities.

CAUTION: A product can be degraded by as little as 700 V.

Typical electrostatic voltage levels			
Event	Relative humidity		
	10%	40%	55%
Walking across carpet	35,000 V	15,000 V	7,500 V
Walking across vinyl floor	12,000 V	5,000 V	3,000 V
Motions of bench worker	6,000 V	800 V	400 V
Removing DIPS from plastic tube	2,000 V	700 V	400 V
Removing DIPS from vinyl tray	11,500 V	4,000 V	2,000 V
Removing DIPS from Styrofoam	14,500 V	5,000 V	3,500 V
Removing bubble pack from PCB	26,500 V	20,000 V	7,000 V
Packing PCBs in foam-lined box	21,000 V	11,000 V	5,000 V

Packaging and transporting guidelines

Follow these grounding guidelines when packaging and transporting equipment:

- To avoid hand contact, transport products in static-safe tubes, bags, or boxes.
- Protect ESD-sensitive parts and assemblies with conductive or approved containers or packaging.
- Keep ESD-sensitive parts in their containers until the parts arrive at static-free workstations.
- Place items on a grounded surface before removing items from their containers.
- Always be properly grounded when touching a component or assembly.
- Store reusable ESD-sensitive parts from assemblies in protective packaging or nonconductive foam.
- Use transporters and conveyors made of antistatic belts and roller bushings. Be sure that mechanized equipment used for moving materials is wired to ground and that proper materials are selected to avoid static charging. When grounding is not possible, use an ionizer to dissipate electric charges.

Workstation guidelines

Follow these grounding workstation guidelines:

- Cover the workstation with approved static-shielding material.
- Use a wrist strap connected to a properly grounded work surface and use properly grounded tools and equipment.
- Use conductive field service tools, such as cutters, screwdrivers, and vacuums.
- When fixtures must directly contact dissipative surfaces, use fixtures made only of static-safe materials.
- Keep the work area free of nonconductive materials, such as ordinary plastic assembly aids and Styrofoam.
- Handle ESD-sensitive components, parts, and assemblies by the case or PCM laminate. Handle these items only at static-free workstations.
- Avoid contact with pins, leads, or circuitry.
- Turn off power and input signals before inserting or removing connectors or test equipment.

Equipment guidelines

Grounding equipment must include either a wrist strap or a foot strap at a grounded workstation.

- When seated, wear a wrist strap connected to a grounded system. Wrist straps are flexible straps with a minimum of one megohm $\pm 10\%$ resistance in the ground cords. To provide proper ground, wear a strap snugly against the skin at all times. On grounded mats with banana-plug connectors, use alligator clips to connect a wrist strap.
- When standing, use foot straps and a grounded floor mat. Foot straps (heel, toe, or boot straps) can be used at standing workstations and are compatible with most types of shoes or boots. On conductive floors or dissipative floor mats, use foot straps on both feet with a minimum of one megohm resistance between the operator and ground. To be effective, the conductive strips must be worn in contact with the skin.

The following grounding equipment is recommended to prevent electrostatic damage:

- Antistatic tape
- Antistatic smocks, aprons, and sleeve protectors
- Conductive bins and other assembly or soldering aids
- Nonconductive foam
- Conductive tabletop workstations with ground cords of one megohm resistance
- Static-dissipative tables or floor mats with hard ties to the ground
- Field service kits
- Static awareness labels
- Material-handling packages
- Nonconductive plastic bags, tubes, or boxes
- Metal tote boxes
- Electrostatic voltage levels and protective materials

The following table lists the shielding protection provided by antistatic bags and floor mats.

Material	Use	Voltage protection level
Antistatic plastic	Bags	1,500 V
Carbon-loaded plastic	Floor mats	7,500 V
Metallized laminate	Floor mats	5,000 V

Component replacement procedures

This chapter provides removal and replacement procedures.

There are as many as 95 screws and screw locks, in 15 different sizes, that must be removed, replaced, or loosened when servicing the computer. Make special note of each screw and screw lock size and location during removal and replacement.

Service tag

When ordering parts or requesting information, provide the computer serial number and model description provided on the service tag.

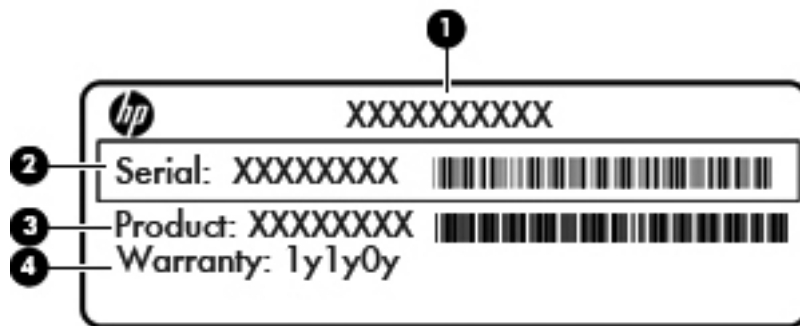

- Product name (1). This is the product name affixed to the front of the computer.
- Serial number (s/n) (2). This is an alphanumeric identifier that is unique to each product.
- Part number/Product number (p/n) (3). This number provides specific information about the product's hardware components. The part number helps a service technician to determine what components and parts are needed.
- Warranty period (4). This number describes the duration (in years) of the warranty period for the computer.

Battery

Description	Spare part number
9-cell, 93 WHr, 2.8 Ah Li-ion battery	633809-001
6-cell, 55 WHr, 2.8 Ah Li-ion battery	650938-001
6-cell, 47 WHr, 2.2 Ah Li-ion battery	633805-001

Before disassembling the computer, follow these steps:

1. Shut down the computer. If you are unsure whether the computer is off or in Hibernation, turn the computer on, and then shut it down through the operating system.
2. Disconnect all external devices connected to the computer.
3. Disconnect the power from the computer by first unplugging the power cord from the AC outlet, and then unplugging the AC adapter from the computer.

Remove the battery:

1. Position the computer upside-down on a flat surface with the battery bay toward you.
2. Slide the battery release latches (1) to release the battery.
3. Pivot the battery (2) upward to remove it from the computer (3).



Install the battery by inserting it into the battery bay until you hear a click.

SIM

 **NOTE:** This section applies only to computer models with WWAN capability.

 **NOTE:** If there is a SIM inserted in the SIM slot, it must be removed before disassembling the computer. Be sure that the SIM is reinserted in the SIM slot after reassembling the computer.

Before removing the SIM, follow these steps:

1. Shut down the computer. If you are unsure whether the computer is off or in Hibernation, turn the computer on, and then shut it down through the operating system.
2. Disconnect all external devices connected to the computer.
3. Disconnect the power from the computer by first unplugging the power cord from the AC outlet, and then unplugging the AC adapter from the computer.
4. Remove the battery (see [Battery on page 41](#)).

Remove the SIM:

1. Position the computer upside-down with the battery bay toward you.
2. Press in on the SIM **(1)**. (The module is partially ejected from the SIM slot.)
3. Remove the SIM **(2)** from the SIM slot.

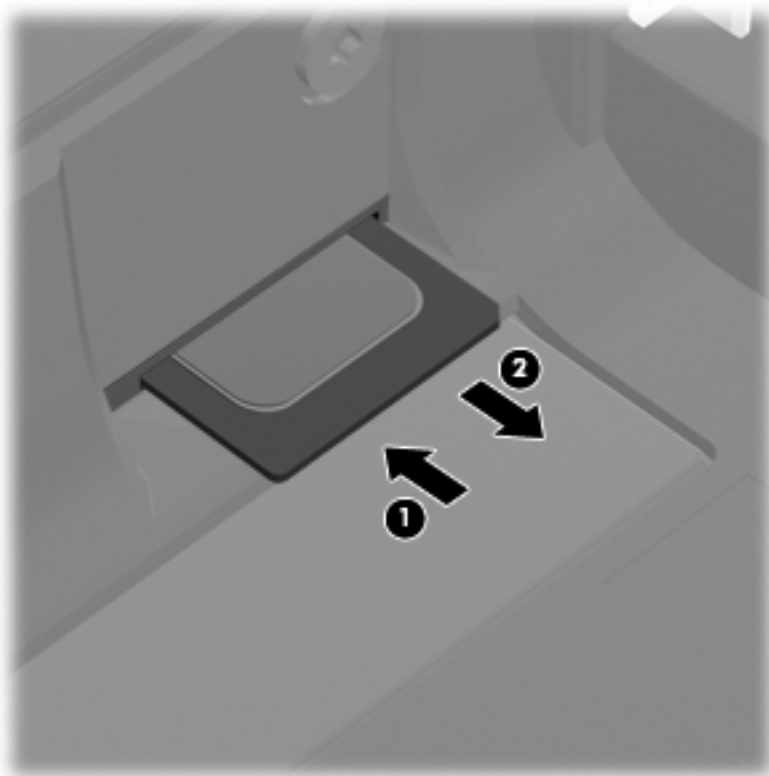

Reverse this procedure to install the SIM.

Bottom door

Description	Spare part number
Bottom door	646263-001

Before disassembling the computer, follow these steps:

1. Shut down the computer. If you are unsure whether the computer is off or in Hibernation, turn the computer on, and then shut it down through the operating system.
2. Disconnect all external devices connected to the computer.
3. Disconnect the power from the computer by first unplugging the power cord from the AC outlet, and then unplugging the AC adapter from the computer.
4. Remove the battery (see [Battery on page 41](#)).

Remove the bottom door:

1. Position the computer upside-down on a flat surface with the battery bay toward you.
2. Remove the locking screw (if installed) **(1)** and slide the bottom door release latches **(2)** to release the door.
3. Slide the door toward the front of the computer **(3)**, and then lift the door off the computer **(4)**.

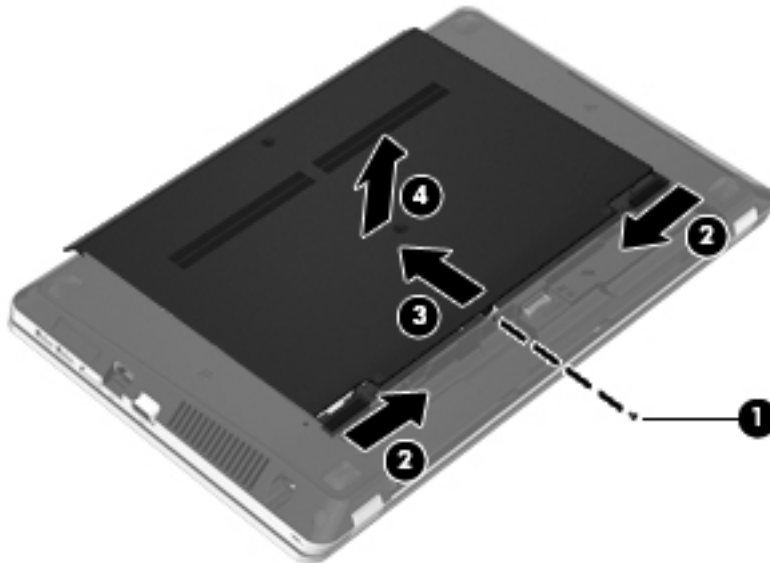

Reverse the removal procedures to install the bottom door.

Optical drive



NOTE: All optical drive spare part kits include an optical drive bezel.

Description	Spare part number
Blu-ray BD-R/RE DVD±RW SuperMulti DL Drive	647951-001
Blu-ray ROM DVD±RW SuperMulti DL Drive	647952-001
DVD±RW and CD-RW SuperMulti DL Combo Drive	647950-001
DVD-ROM Drive	647949-001

Before removing the optical drive, follow these steps:

1. Shut down the computer. If you are unsure whether the computer is off or in Hibernation, turn the computer on, and then shut it down through the operating system.
2. Disconnect all external devices connected to the computer.
3. Disconnect the power from the computer by first unplugging the power cord from the AC outlet, and then unplugging the AC adapter from the computer.
4. Remove the battery (see [Battery on page 41](#)).
5. Remove the bottom door (see [Bottom door on page 43](#)).

Remove the optical drive:

1. Position the computer upside-down with the battery bay toward you.
2. Remove the Phillips PM2.5×5.0 screw (1) that secures the optical drive to the computer.
3. Push the optical drive tab (2) to release the optical drive from the computer.
4. Remove the optical drive (3) from the computer.

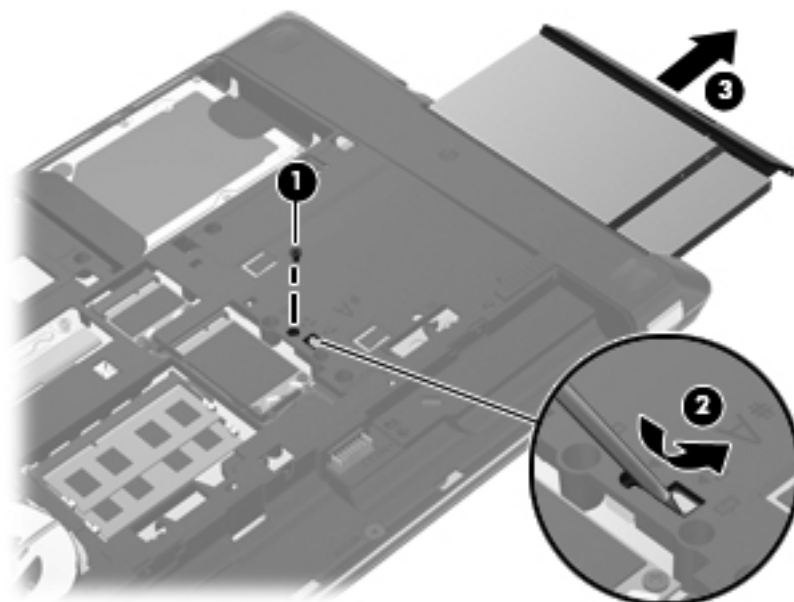

5. If it is necessary to replace the optical drive bracket, position the optical drive with the rear toward you.
6. Remove the two Phillips PM2.0×3.0 screws (1) that secure the optical drive bracket to the optical drive.
7. Remove the optical drive bracket (2).

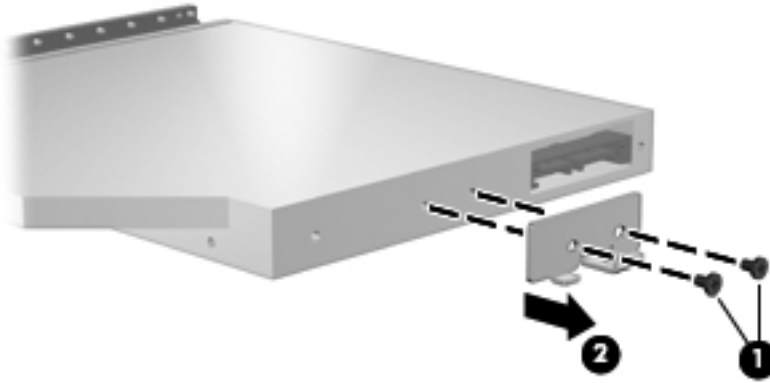

Reverse this procedure to install an optical drive.

Hard drive



NOTE: All hard drive spare part kits include a hard drive bracket and screws.

Description	Spare part number
750-GB, 7200-rpm hard drive	633252-001
750-GB, 5400-rpm hard drive	634250-001
640-GB, 5400-rpm hard drive	603785-001
500-GB, 7200-rpm hard drive	634925-001
500-GB, 5400-rpm hard drive	634638-001
320-GB, 7200-rpm hard drive (7 mm)	634862-001
320-GB, 7200-rpm (2.5 in)	641672-001
320-GB, 5400-rpm (7 mm)	645193-001
320-GB, 5400-rpm hard drive (2.5 in)	622643-001
250-GB, 7200-rpm hard drive (2.5 in)	635225-001
250-GB, 7200-rpm (7 mm)	634861-001
250-GB, 5400-rpm hard drive (2.5 in)	622641-001
250-GB, 5400-rpm (7 mm)	645191-001
Hard Drive Hardware Kit (includes hard drive bracket, insulator, and screws)	647944-001

Before disassembling the computer, follow these steps:

1. Shut down the computer. If you are unsure whether the computer is off or in Hibernation, turn the computer on, and then shut it down through the operating system.
2. Disconnect all external devices connected to the computer.
3. Disconnect the power from the computer by first unplugging the power cord from the AC outlet, and then unplugging the AC adapter from the computer.
4. Remove the battery (see [Battery on page 41](#)).
5. Remove the bottom door (see [Bottom door on page 43](#)).

Remove the hard drive:

1. Position the computer upside-down with the front toward you.
2. Remove the four Phillips PM2.0×4.0 screws **(1)** that secure the hard drive to the computer.
3. Grasp the Mylar tabs on the hard drive and slide the hard drive to the right **(2)** to disconnect it from the system board connector.

4. Remove the hard drive (3) from the hard drive bay.

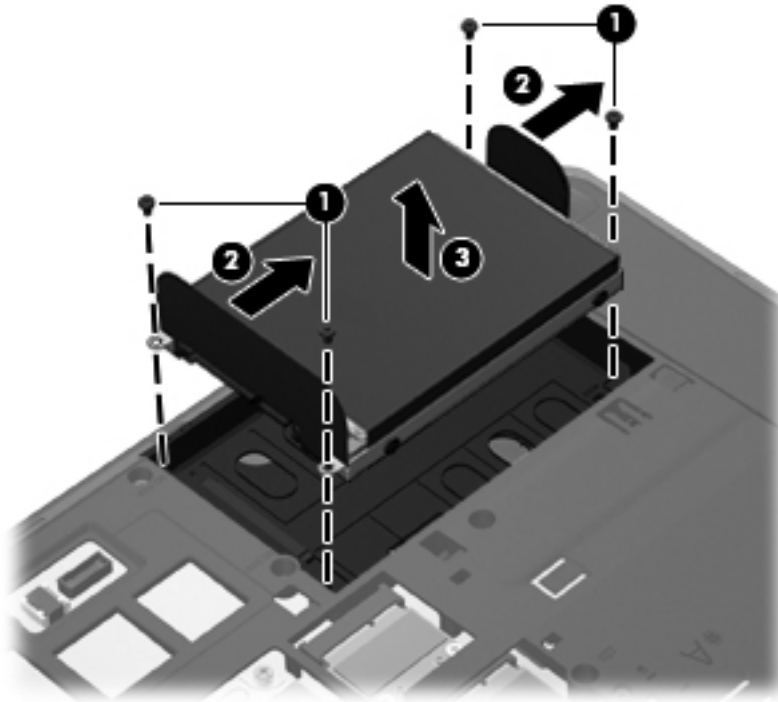

5. If it is necessary to replace the hard drive bracket, remove the tape (1) that secures the Mylar cover down onto the bracket, and then lift to open the Mylar cover (2).
6. Remove the two Phillips PM3.0×3.0 hard drive bracket screws (3) from each side of the hard drive (4 total screws).
7. Rotate the hard drive upward and remove it from the bracket (4).

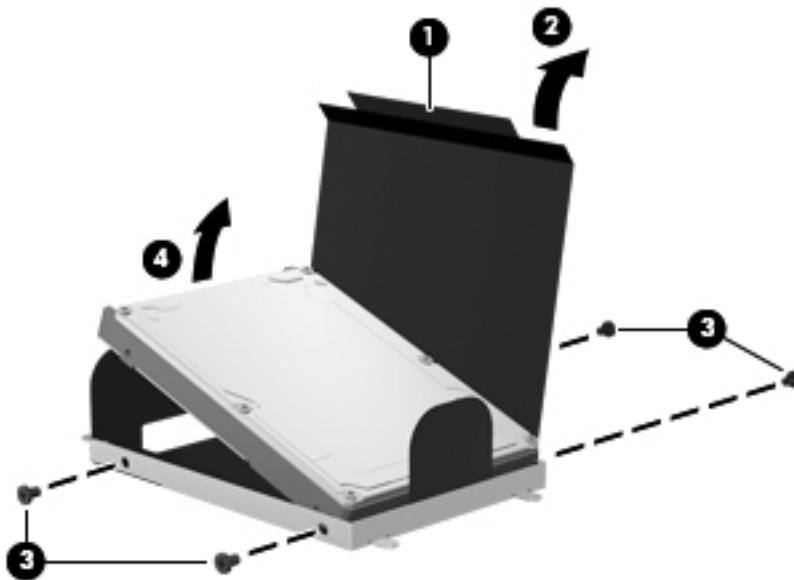

Reverse this procedure to reassemble and install the hard drive.

Memory modules



NOTE: Primary and expansion memory is installed in a stacked configuration in the bottom of the computer.

Description	Spare part number
1-GB (PC3-10600, 1333-MHz, DDR3)	639736-001
2-GB (PC3-10600, 1333-MHz, DDR3)	621565-001
4-GB (PC3-10600, 1333-MHz, DDR3)	621569-001

Update BIOS before adding memory modules

Before adding new memory, make sure you update the computer to the latest BIOS.



CAUTION: Failure to update the computer to the latest BIOS prior to installing new memory may result in various system problems.

To update BIOS:

1. Navigate to www.hp.com.
2. Click **Support & Drivers** > click **Drivers & Software**.
3. In the **Enter a product name/number** box, type the computer model information, and then click **Search**.
4. Click the link for the computer model.
5. Select the operating system, and then click **Next**.
6. Under **Step 2: Select a Download**, click the **BIOS** link.
7. Click the link for the most recent BIOS.
8. Click the **Download** button, and then follow the on-screen instructions.

Before removing the memory module, follow these steps:

1. Shut down the computer. If you are unsure whether the computer is off or in Hibernation, turn the computer on, and then shut it down through the operating system.
2. Disconnect all external devices connected to the computer.
3. Disconnect the power from the computer by first unplugging the power cord from the AC outlet, and then unplugging the AC adapter from the computer.
4. Remove the battery (see [Battery on page 41](#)).
5. Remove the bottom door (see [Bottom door on page 43](#)).

Remove the memory module:

1. Position the computer upside-down with the battery bay toward you.
2. Spread the retaining tabs **(1)** on each side of the memory module slot to release the memory module. (The edge of the module opposite the slot rises away from the computer.)

3. Remove the memory module (2) by pulling the module away from the slot at an angle.

 **NOTE:** Memory modules are designed with a notch (3) to prevent incorrect insertion into the memory module slot.

 **NOTE:** The computer uses two memory sockets. The top socket houses the expansion memory module and is shown in the following image. The bottom socket houses the primary memory module. The removal procedure is the same for both memory sockets.

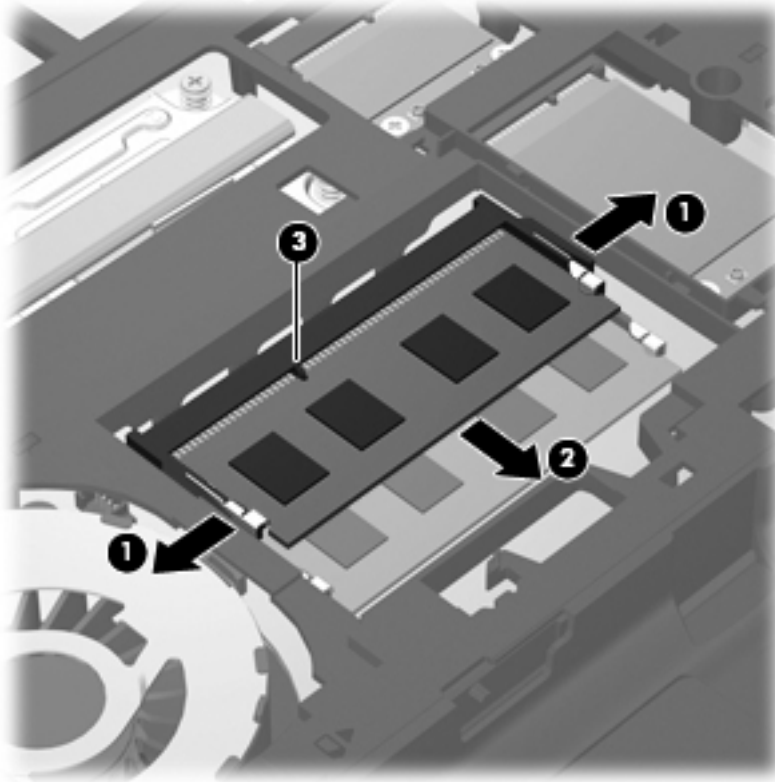

Reverse this procedure to install a memory module.

WWAN module

 **CAUTION:** The WWAN module and the WLAN module are not interchangeable.

Description	Spare part number
HP Ic2010 HSPA Mobile Broadband Module	632155-001
HP un2430 EV-DO/HSPA Mobile Broadband Module	634400-001
HP Ic2010 HSPA Mobile Broadband Module	612600-001

Before removing the WWAN module, follow these steps:

1. Shut down the computer. If you are unsure whether the computer is off or in Hibernation, turn the computer on, and then shut it down through the operating system.
2. Disconnect all external devices connected to the computer.
3. Disconnect the power from the computer by first unplugging the power cord from the AC outlet, and then unplugging the AC adapter from the computer.
4. Remove the battery (see [Battery on page 41](#)).
5. Remove the SIM (see [SIM on page 42](#)).
6. Remove the bottom door (see [Bottom door on page 43](#)).

Remove the WWAN module:

1. Position the computer upside-down with the battery bay toward you.
2. Disconnect the WWAN antenna cables **(1)** from the terminals on the WWAN module.

 **NOTE:** The red WWAN antenna cable is connected to the WWAN module “Main” terminal. The blue WWAN antenna cable is connected to the WWAN module “Aux” terminal.

3. Remove the two Phillips PM2.0×3.0 screws **(2)** that secure the WWAN module to the computer. (The edge of the module opposite the slot rises away from the computer.)

4. Remove the WWAN module (3) by pulling the module away from the slot at an angle.



 **NOTE:** WWAN modules are designed with a notch (4) to prevent incorrect insertion.

Figure 4-1 Removing the WWAN module



 **NOTE:** If the WWAN antennas are not connected to the terminals on the WWAN module, the protective sleeves must be installed on the antenna connectors, as shown in the following illustration.

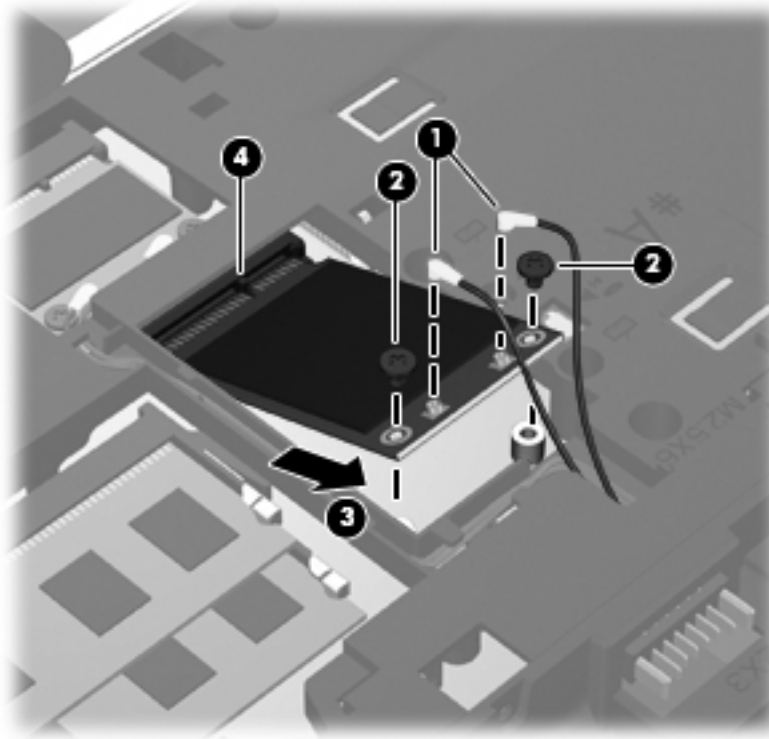

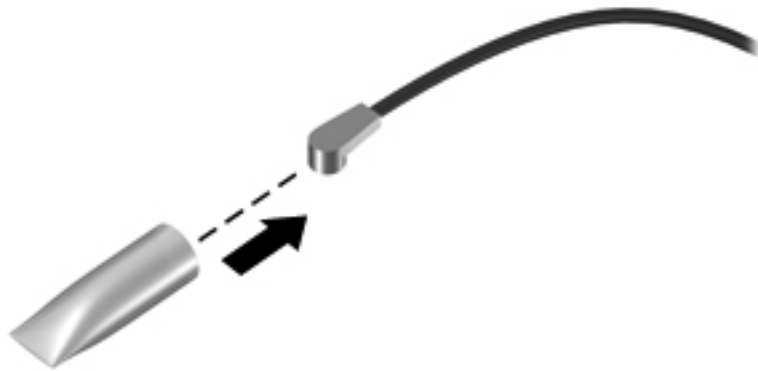
Reverse this procedure to install the WWAN module.

WLAN/Bluetooth combo card

The computer uses a card that provides both WLAN and Bluetooth functionality.

 **CAUTION:** The WLAN module and the WWAN module are not interchangeable.

Description	Spare part number
<p>Atheros AR9002WB-1NGB 802.11b/g/n 1x1 WiFi and Bluetooth 2.1+EDR Combo Adapter for use in Afghanistan, Albania, Algeria, Andorra, Angola, Antigua and Barbuda, Argentina, Armenia, Aruba, Australia, Austria, Azerbaijan, Bahamas, Bahrain, Bangladesh, Barbados, Belarus, Belgium, Belize, Benin, Bermuda, Bhutan, Bolivia, Bosnia and Herzegovina, Botswana, Brazil, the British Virgin Islands, Brunei, Bulgaria, Burkina Faso, Burundi, Cambodia, Cameroon, Canada, Cape Verde, the Cayman Islands, Central African Republic, Chad, Chile, People's Republic of China, Colombia, Comoros, Congo, Costa Rica, Croatia, Cyprus, the Czech Republic, Denmark, Djibouti, Dominica, the Dominican Republic, East Timor, Ecuador, Egypt, El Salvador, Equatorial Guinea, Eritrea, Estonia, Ethiopia, Fiji, Finland, France, French Guiana, Gabon, Gambia, Georgia, Germany, Ghana, Gibraltar, Greece, Grenada, Guadeloupe, Guam, Guatemala, Guinea, Guinea-Bissa, Guyana, Haiti, Honduras, Hong Kong, Hungary, Iceland, India, Indonesia, Ireland, Israel, Italy, Ivory Coast, Jamaica, Japan, Jordan, Kazakhstan, Kenya, Kiribati, Kuwait, Kyrgyzstan, Laos, Latvia, Lebanon, Lesotho, Liberia, Liechtenstein, Lithuania, Luxembourg, Macedonia, Madagascar, Malawi, Malaysia, Maldives, Mali, Malta, Marshall Islands, Martinique, Mauritania, Mauritius, Mexico, Micronesia, Monaco, Mongolia, Montenegro, Morocco, Mozambique, Namibia, Nauru, Nepal, the Nether Antilles, the Netherlands, New Zealand, Nicaragua, Niger, Nigeria, Norway, Oman, Pakistan, Palau, Panama, Papua New Guinea, Paraguay, Puerto Rico, Peru, Philippines, Poland, Portugal, Qatar, Republic of Moldova, Romania, Russia, Rwanda, Samoa, San Marino, Sao Tome and Principe, Saudi Arabia, Senegal, Serbia and Montenegro, Seychelles, Sierra Leone, Singapore, Slovakia, Slovenia, Solomon Islands, Somalia, South Africa, South Korea, Spain, Sri Lanka, St. Kitts and Nevis, St. Lucia, St. Vincent and the Grenadines, Suriname, Swaziland, Sweden, Switzerland, Syria, Taiwan, Tajikistan, Tanzania, Thailand, Togo, Tonga, Trinidad and Tobago, Tunisia, Turkey, Turkmenistan, Tuvalu, Uganda, Ukraine, the United Arab Emirates, the United Kingdom, Uruguay, the United States, the US Virgin Islands, Uzbekistan, Vanuatu, Venezuela, Vietnam, Yemen, Zaire, Zambia, and Zimbabwe</p>	593127-001
<p>Realtek 8188BC8 802.11a/b/g/n 2x2 WiFi and Bluetooth 3.0+HS Combo Adapter for use in Afghanistan, Albania, Algeria, Andorra, Angola, Antigua and Barbuda, Argentina, Armenia, Aruba, Australia, Austria, Azerbaijan, Bahamas, Bahrain, Baltics, Bangladesh, Barbados, Belarus, Belgium, Belize, Benin, Bermuda, Bhutan, Bolivia, Bosnia and Herzegovina, Botswana, Brazil, the British Virgin Islands, Brunei, Bulgaria, Burkina Faso, Burundi, Cambodia, Cameroon, Canada, Cape Verde, the Cayman Islands, Central African Republic, Chad, Chile, People's Republic of China, Colombia, Comoros, Congo, Costa Rica, Croatia, Cyprus, the Czech Republic, Denmark, Djibouti, Dominica, the Dominican Republic, East Timor, Ecuador, Egypt, El Salvador, Equatorial Guinea, Eritrea, Estonia, Ethiopia, Fiji, Finland, France, French Guiana, Gabon, Gambia, Georgia, Germany, Ghana, Gibraltar, Greece, Grenada, Guadeloupe, Guam, Guatemala, Guinea, Guinea-Bissa, Guyana, Haiti, Honduras, Hong Kong, Hungary, Iceland, India, Indonesia, Iraq, Ireland, Israel, Italy, Ivory Coast, Jamaica, Japan, Jordan, Kazakhstan, Kenya, Kiribati, Kuwait, Kyrgyzstan, Laos, Latvia, Lebanon, Lesotho, Liberia, Liechtenstein, Lithuania, Luxembourg, Macedonia, Madagascar, Malawi, Malaysia, Maldives, Mali, Malta, Marshall Islands, Martinique, Mauritania, Mauritius, Mexico, Micronesia, Monaco, Mongolia, Montenegro, Morocco, Mozambique, Namibia, Nauru, Nepal, the Nether Antilles, the Netherlands, New Zealand, Nicaragua, Niger, Nigeria, Norway, Oman, Pakistan, Palau, Panama, Papua New Guinea, Paraguay, Puerto Rico, Peru, Philippines, Poland, Portugal, Qatar, Republic of Moldova, Romania, Russia, Rwanda, Samoa, San Marino, Sao Tome and Principe, Saudi Arabia, Senegal, Serbia and Montenegro, Seychelles, Sierra Leone, Singapore, Slovakia, Slovenia, Solomon Islands, Somalia, South Africa, South Korea, Spain, Sri Lanka, St. Kitts and Nevis, St. Lucia, St. Vincent and the Grenadines, Suriname, Swaziland, Sweden, Switzerland, Syria, Taiwan, Tajikistan, Tanzania, Thailand, Togo, Tonga, Trinidad and Tobago, Tunisia, Turkey, Turkmenistan, Tuvalu, Uganda, Ukraine, the United Arab Emirates, the United Kingdom, Uruguay, the United States, the US Virgin Islands, Uzbekistan, Vanuatu, Venezuela, Vietnam, Yemen, Zaire, Zambia, and Zimbabwe</p>	602993-001

Description	Spare part number
Ralink 5390GN 802.11b/g/n 1x1 WiFi Adapter for use in Afghanistan, Albania, Algeria, Andorra, Angola, Antigua and Barbuda, Argentina, Armenia, Aruba, Australia, Austria, Azerbaijan, Bahamas, Bahrain, Baltics, Bangladesh, Barbados, Belarus, Belgium, Belize, Benin, Bermuda, Bhutan, Bolivia, Bosnia and Herzegovina, Botswana, Brazil, the British Virgin Islands, Brunei, Bulgaria, Burkina Faso, Burundi, Cambodia, Cameroon, Canada, Cape Verde, the Cayman Islands, Central African Republic, Chad, Chile, People's Republic of China, Colombia, Comoros, Congo, Costa Rica, Croatia, Cyprus, the Czech Republic, Denmark, Djibouti, Dominica, the Dominican Republic, East Timor, Ecuador, Egypt, El Salvador, Equatorial Guinea, Eritrea, Estonia, Ethiopia, Fiji, Finland, France, French Guiana, Gabon, Gambia, Georgia, Germany, Ghana, Gibraltar, Greece, Grenada, Guadeloupe, Guam, Guatemala, Guinea, Guinea-Bissau, Guyana, Haiti, Honduras, Hong Kong, Hungary, Iceland, India, Indonesia, Iraq, Ireland, Israel, Italy, Ivory Coast, Jamaica, Japan, Jordan, Kazakhstan, Kenya, Kiribati, Kuwait, Kyrgyzstan, Laos, Latvia, Lebanon, Lesotho, Liberia, Liechtenstein, Lithuania, Luxembourg, Macedonia, Madagascar, Malawi, Malaysia, Maldives, Mali, Malta, Marshall Islands, Martinique, Mauritania, Mauritius, Mexico, Micronesia, Monaco, Mongolia, Montenegro, Morocco, Mozambique, Namibia, Nauru, Nepal, the Nether Antilles, the Netherlands, New Zealand, Nicaragua, Niger, Nigeria, Norway, Oman, Pakistan, Palau, Panama, Papua New Guinea, Paraguay, Puerto Rico, Peru, Philippines, Poland, Portugal, Qatar, Republic of Moldova, Romania, Russia, Rwanda, Samoa, San Marino, Sao Tome and Principe, Saudi Arabia, Senegal, Serbia and Montenegro, Seychelles, Sierra Leone, Singapore, Slovakia, Slovenia, Solomon Islands, Somalia, South Africa, South Korea, Spain, Sri Lanka, St. Kitts and Nevis, St. Lucia, St. Vincent and the Grenadines, Suriname, Swaziland, Sweden, Switzerland, Syria, Taiwan, Tajikistan, Tanzania, Thailand, Togo, Tonga, Trinidad and Tobago, Tunisia, Turkey, Turkmenistan, Tuvalu, Uganda, Ukraine, the United Arab Emirates, the United Kingdom, Uruguay, the United States, the US Virgin Islands, Uzbekistan, Vanuatu, Venezuela, Vietnam, Yemen, Zaire, Zambia, and Zimbabwe	630703-001

Description	Spare part number
<p>Ralink 8190BC8 802.11b/g/n 2x2 WiFi and Bluetooth 3.0+HS Combo Adapter for use in Afghanistan, Albania, Algeria, Andorra, Angola, Antigua and Barbuda, Argentina, Armenia, Aruba, Australia, Austria, Azerbaijan, Bahamas, Bahrain, Baltics, Bangladesh, Barbados, Belarus, Belgium, Belize, Benin, Bermuda, Bhutan, Bolivia, Bosnia and Herzegovina, Botswana, Brazil, the British Virgin Islands, Brunei, Bulgaria, Burkina Faso, Burundi, Cambodia, Cameroon, Canada, Cape Verde, the Cayman Islands, Central African Republic, Chad, Chile, People's Republic of China, Colombia, Comoros, Congo, Costa Rica, Croatia, Cyprus, the Czech Republic, Denmark, Djibouti, Dominica, the Dominican Republic, East Timor, Ecuador, Egypt, El Salvador, Equatorial Guinea, Eritrea, Estonia, Ethiopia, Fiji, Finland, France, French Guiana, Gabon, Gambia, Georgia, Germany, Ghana, Gibraltar, Greece, Grenada, Guadeloupe, Guam, Guatemala, Guinea, Guinea-Bissa, Guyana, Haiti, Honduras, Hong Kong, Hungary, Iceland, India, Indonesia, Iraq, Ireland, Israel, Italy, Ivory Coast, Jamaica, Japan, Jordan, Kazakhstan, Kenya, Kiribati, Kuwait, Kyrgyzstan, Laos, Latvia, Lebanon, Lesotho, Liberia, Liechtenstein, Lithuania, Luxembourg, Macedonia, Madagascar, Malawi, Malaysia, Maldives, Mali, Malta, Marshall Islands, Martinique, Mauritania, Mauritius, Mexico, Micronesia, Monaco, Mongolia, Montenegro, Morocco, Mozambique, Namibia, Nauru, Nepal, the Nether Antilles, the Netherlands, New Zealand, Nicaragua, Niger, Nigeria, Norway, Oman, Pakistan, Palau, Panama, Papua New Guinea, Paraguay, Puerto Rico, Peru, Philippines, Poland, Portugal, Qatar, Republic of Moldova, Romania, Russia, Rwanda, Samoa, San Marino, Sao Tome and Principe, Saudi Arabia, Senegal, Serbia and Montenegro, Seychelles, Sierra Leone, Singapore, Slovakia, Slovenia, Solomon Islands, Somalia, South Africa, South Korea, Spain, Sri Lanka, St. Kitts and Nevis, St. Lucia, St. Vincent and the Grenadines, Suriname, Swaziland, Sweden, Switzerland, Syria, Taiwan, Tajikistan, Tanzania, Thailand, Togo, Tonga, Trinidad and Tobago, Tunisia, Turkey, Turkmenistan, Tuvalu, Uganda, Ukraine, the United Arab Emirates, the United Kingdom, Uruguay, the United States, the US Virgin Islands, Uzbekistan, Vanuatu, Venezuela, Vietnam, Yemen, Zaire, Zambia, and Zimbabwe</p>	630813-001
<p>Realtek 8188GN 802.11b/g/n 1x1 WiFi Adapter for use in Afghanistan, Albania, Algeria, Andorra, Angola, Antigua and Barbuda, Argentina, Armenia, Aruba, Australia, Austria, Azerbaijan, Bahamas, Bahrain, Baltics, Bangladesh, Barbados, Belarus, Belgium, Belize, Benin, Bermuda, Bhutan, Bolivia, Bosnia and Herzegovina, Botswana, Brazil, the British Virgin Islands, Brunei, Bulgaria, Burkina Faso, Burundi, Cambodia, Cameroon, Canada, Cape Verde, the Cayman Islands, Central African Republic, Chad, Chile, People's Republic of China, Colombia, Comoros, Congo, Costa Rica, Croatia, Cyprus, the Czech Republic, Denmark, Djibouti, Dominica, the Dominican Republic, East Timor, Ecuador, Egypt, El Salvador, Equatorial Guinea, Eritrea, Estonia, Ethiopia, Fiji, Finland, France, French Guiana, Gabon, Gambia, Georgia, Germany, Ghana, Gibraltar, Greece, Grenada, Guadeloupe, Guam, Guatemala, Guinea, Guinea-Bissa, Guyana, Haiti, Honduras, Hong Kong, Hungary, Iceland, India, Indonesia, Iraq, Ireland, Israel, Italy, Ivory Coast, Jamaica, Japan, Jordan, Kazakhstan, Kenya, Kiribati, Kuwait, Kyrgyzstan, Laos, Latvia, Lebanon, Lesotho, Liberia, Liechtenstein, Lithuania, Luxembourg, Macedonia, Madagascar, Malawi, Malaysia, Maldives, Mali, Malta, Marshall Islands, Martinique, Mauritania, Mauritius, Mexico, Micronesia, Monaco, Mongolia, Montenegro, Morocco, Mozambique, Namibia, Nauru, Nepal, the Nether Antilles, the Netherlands, New Zealand, Nicaragua, Niger, Nigeria, Norway, Oman, Pakistan, Palau, Panama, Papua New Guinea, Paraguay, Puerto Rico, Peru, Philippines, Poland, Portugal, Qatar, Republic of Moldova, Romania, Russia, Rwanda, Samoa, San Marino, Sao Tome and Principe, Saudi Arabia, Senegal, Serbia and Montenegro, Seychelles, Sierra Leone, Singapore, Slovakia, Slovenia, Solomon Islands, Somalia, South Africa, South Korea, Spain, Sri Lanka, St. Kitts and Nevis, St. Lucia, St. Vincent and the Grenadines, Suriname, Swaziland, Sweden, Switzerland, Syria, Taiwan, Tajikistan, Tanzania, Thailand, Togo, Tonga, Trinidad and Tobago, Tunisia, Turkey, Turkmenistan, Tuvalu, Uganda, Ukraine, the United Arab Emirates, the United Kingdom, Uruguay, the United States, the US Virgin Islands, Uzbekistan, Vanuatu, Venezuela, Vietnam, Yemen, Zaire, Zambia, and Zimbabwe</p>	640926-001

Before removing the WLAN module, follow these steps:

1. Shut down the computer. If you are unsure whether the computer is off or in Hibernation, turn the computer on, and then shut it down through the operating system.
2. Disconnect all external devices connected to the computer.

3. Disconnect the power from the computer by first unplugging the power cord from the AC outlet, and then unplugging the AC adapter from the computer.
4. Remove the battery (see [Battery on page 41](#)).
5. Remove the bottom door (see [Bottom door on page 43](#)).

Remove the WLAN module:

1. Position the computer upside-down with the battery bay toward you.
2. Disconnect the WLAN antenna cables (1) from the terminals on the WLAN module.





NOTE: The WLAN antenna cable labeled “1” connects to the WLAN module “Main” terminal labeled “1”. The WLAN antenna cable labeled “2” connects to the WLAN module “Aux” terminal labeled “2”. If the computer is equipped with an 802.11a/b/g/n WLAN module, the yellow WLAN antenna cable connects to the middle terminal on the WLAN module.

3. Remove the two Phillips PM2.0×3.0 screws (2) that secure the WLAN module to the computer. (The edge of the module opposite the slot rises away from the computer.)

4. Remove the WLAN module (3) by pulling the module away from the slot at an angle.

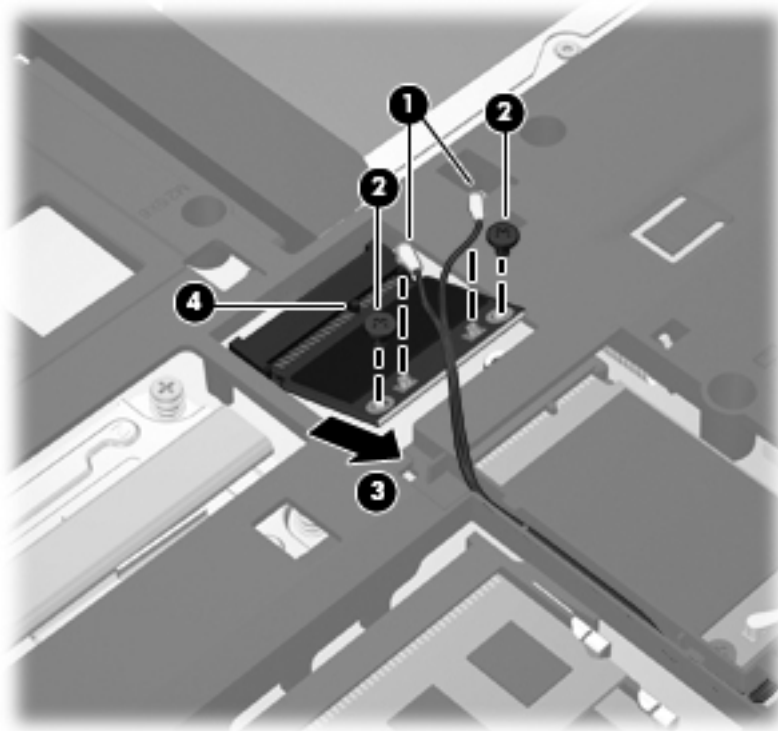
 **NOTE:** WLAN modules are designed with a notch (4) to prevent incorrect insertion.



 **NOTE:** If the WLAN antennas are not connected to the terminals on the WLAN module, the protective sleeves must be installed on the antenna connectors, as shown in the following illustration.

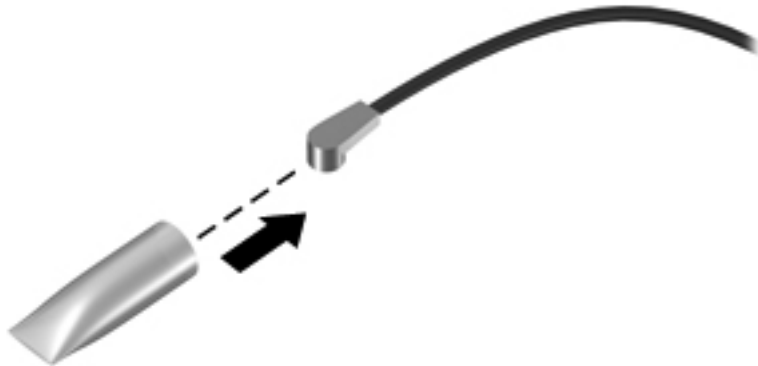

Reverse this procedure to install the WLAN module.

Keyboard



NOTE: For a detailed list of available keyboards, see [Sequential part number listing on page 29](#).

Description	Spare part number
Keyboard	646300-xxx

Before removing the keyboard, follow these steps:

1. Shut down the computer. If you are unsure whether the computer is off or in Hibernation, turn the computer on, and then shut it down through the operating system.
2. Disconnect all external devices connected to the computer.
3. Disconnect the power from the computer by first unplugging the power cord from the AC outlet, and then unplugging the AC adapter from the computer.
4. Remove the battery (see [Battery on page 41](#)).
5. Remove the bottom door (see [Bottom door on page 43](#)).

Remove the keyboard:

1. Position the computer upside-down with the front toward you.
2. Remove the two Phillips PM2.5×7.0 screws that secure the keyboard to the computer.

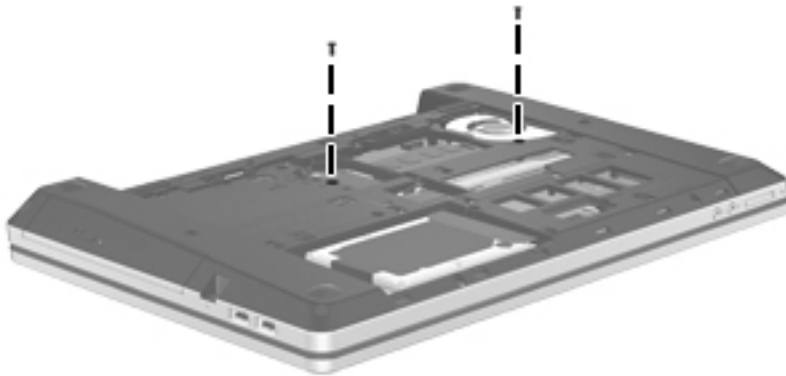

3. Position the computer on its side with the bottom facing you and the computer open.

4. Insert a screwdriver or similar tool into the gap near the WWAN module compartment and push to disengage the keyboard.

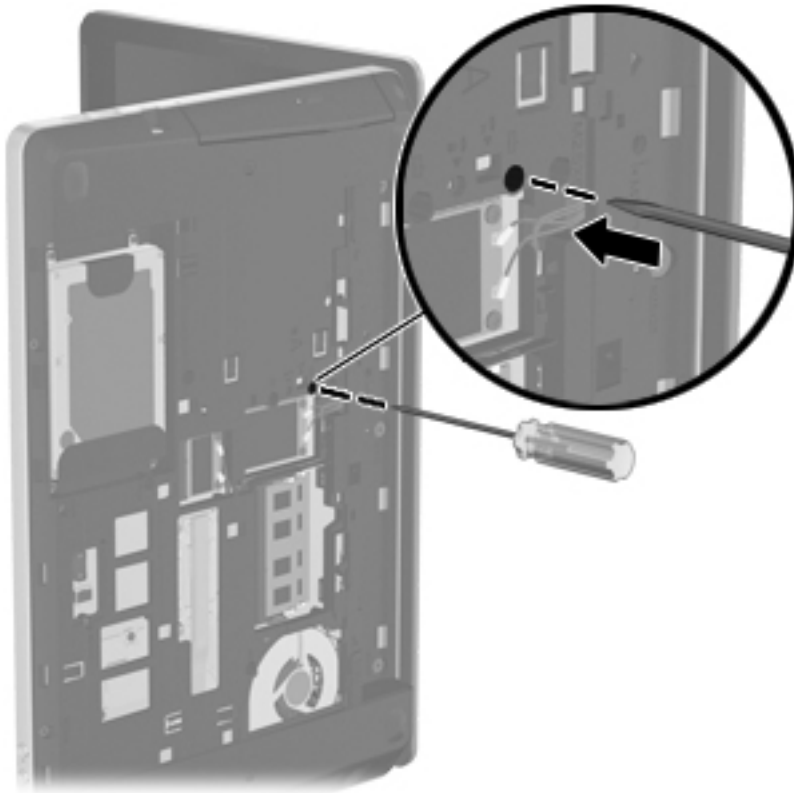

5. Position the computer upright with the front toward you.
6. Open the computer as far as possible.
7. Lift and rotate the keyboard (1) until it rests on the palm rest (2).

 **NOTE:** Some units have double-sided tape securing the keyboard to the top cover.



8. Lift the keyboard connector latch (1).
9. Disconnect the keyboard cable from the system board (2)

10. Remove the keyboard (3).

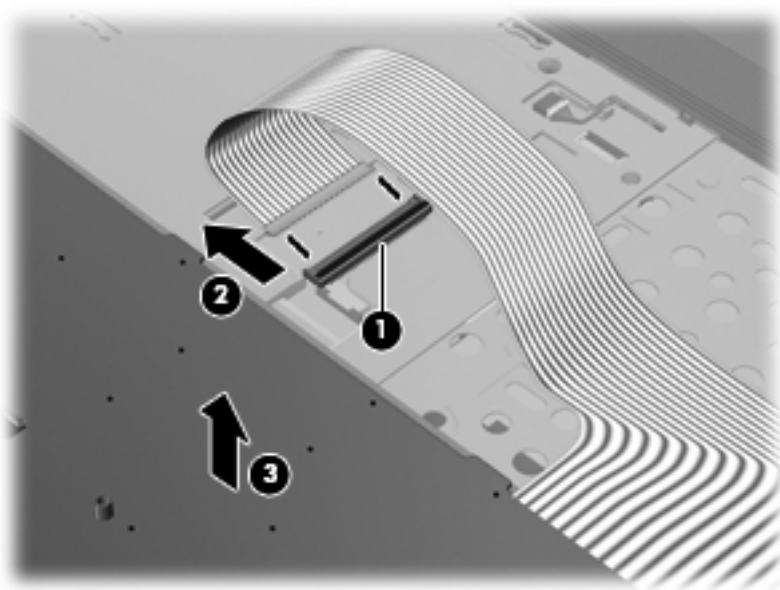

Reverse this procedure to install the keyboard.

Top cover

Description	Spare part number
For use in models with a fingerprint reader	646251-001
For use in models with a fingerprint reader and no USB logo	679919-001
For use in models without a fingerprint reader	646253-001
For use in models without a fingerprint reader and no USB logo	679920-001

Before removing the top cover, follow these steps:

1. Shut down the computer. If you are unsure whether the computer is off or in Hibernation, turn the computer on, and then shut it down through the operating system.
2. Disconnect all external devices connected to the computer.
3. Disconnect the power from the computer by first unplugging the power cord from the AC outlet, and then unplugging the AC adapter from the computer.
4. Remove the battery (see [Battery on page 41](#)).
5. Remove the following components:
 - a. Bottom door (see [Bottom door on page 43](#)).
 - b. Optical drive (see [Optical drive on page 44](#))
 - c. Keyboard (see [Keyboard on page 57](#))

Remove the top cover:

1. Position the computer upside-down with the front toward you.
2. Remove the following covers and screws that secure the top cover to the computer:

(1) 4 rubber screw covers

(2) 10 Torx T8M2.5×6.0 screws

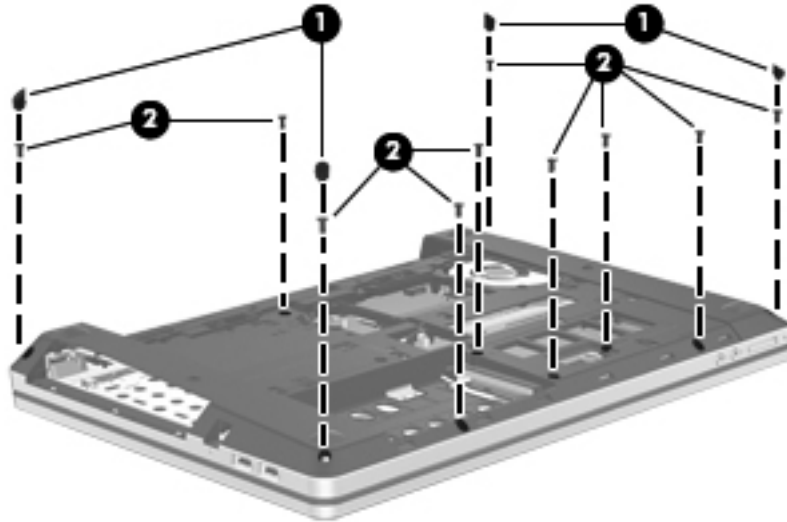

3. Remove the following screws that secure the top cover to the computer:

(1) 3 Phillips PM2.0×4.0 screws from the optical drive bay

(2) 3 Phillips PM2.5×2.5 broadhead screws from the battery bay

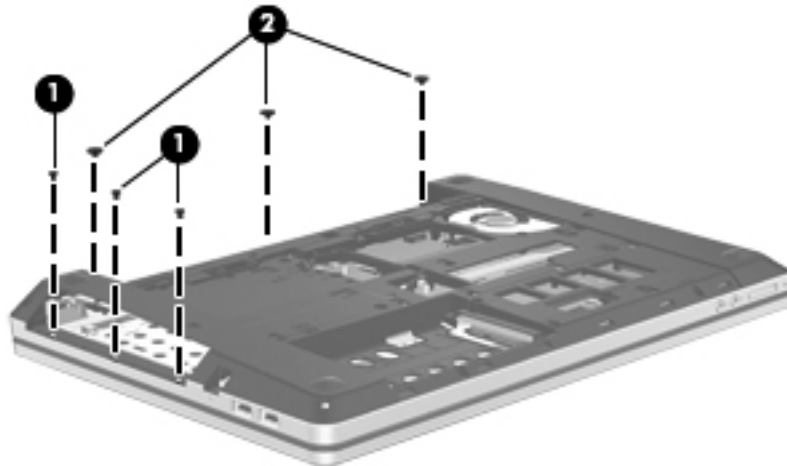

4. Turn the computer upright and open it as far as possible.

5. Remove the 6 Torx T8M2.5×6.0 screws that secure the top cover to the computer.

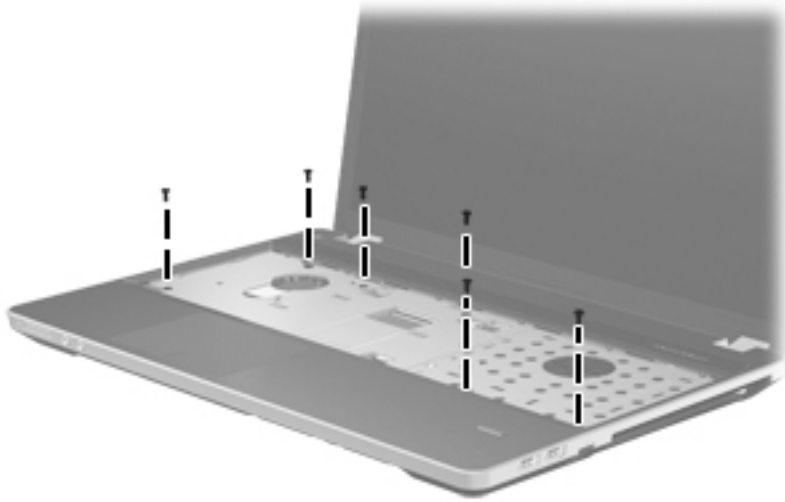

6. Remove the following cables from the system board:
- Lift the connector latch **(1)** and disconnect the function board cable **(2)**
 - Disconnect the speaker cable **(3)**
 - Lift the connector latch **(4)** and disconnect the power button board cable **(5)**
 - Lift the connector latch **(6)** and disconnect the fingerprint reader board cable **(7)**

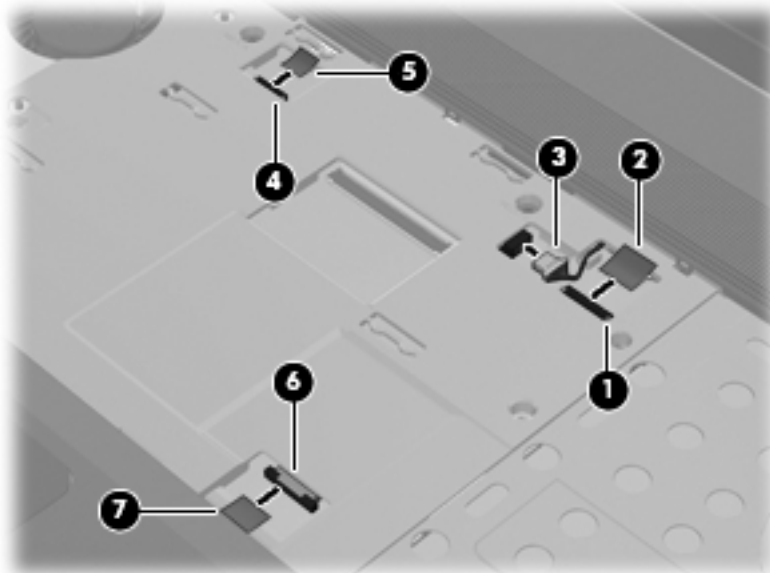

7. Position the computer on its side with the display open.

8. Insert a screwdriver through the holes in the battery bay and press to disengage the top cover from the computer.

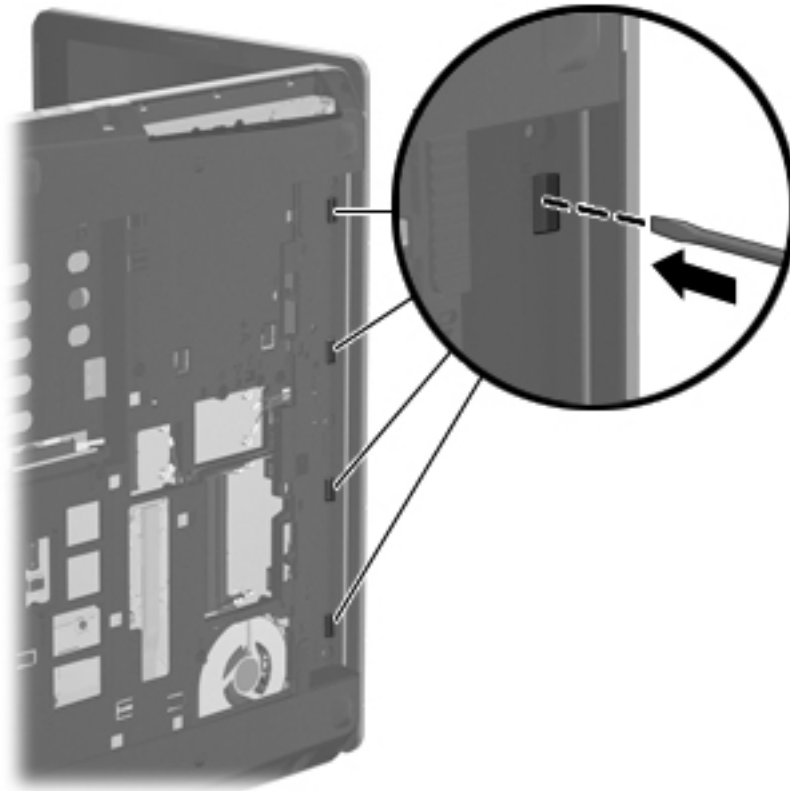

9. Position the computer upright with the front toward you.
10. To remove the top cover, pull up on the top of the top cover (1), pull upward on the left (2) and right sides (3), and then lift the bottom of the top cover (4) to remove it enough to access the card reader underneath.

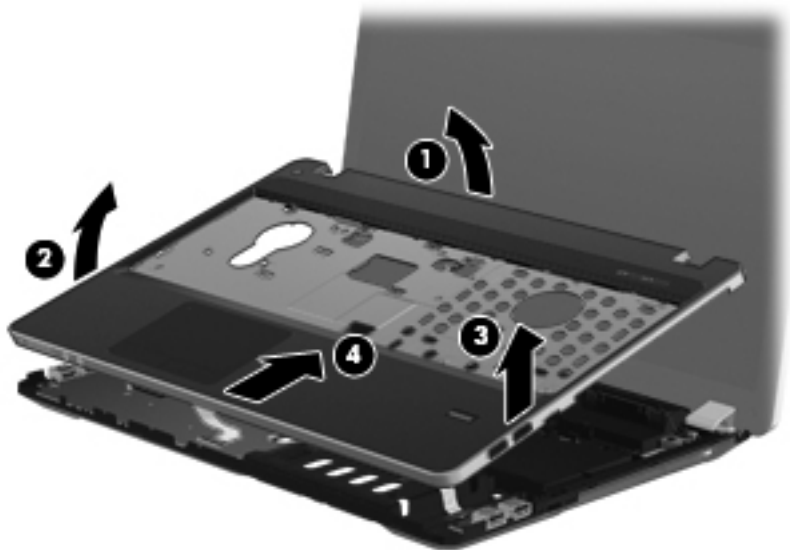

11. Lift the front of the top cover slightly to gain access to the cable and connector underneath.

12. Lift the connector latch (1), disconnect the card reader cable (2), and then lift the top cover from the computer (3).

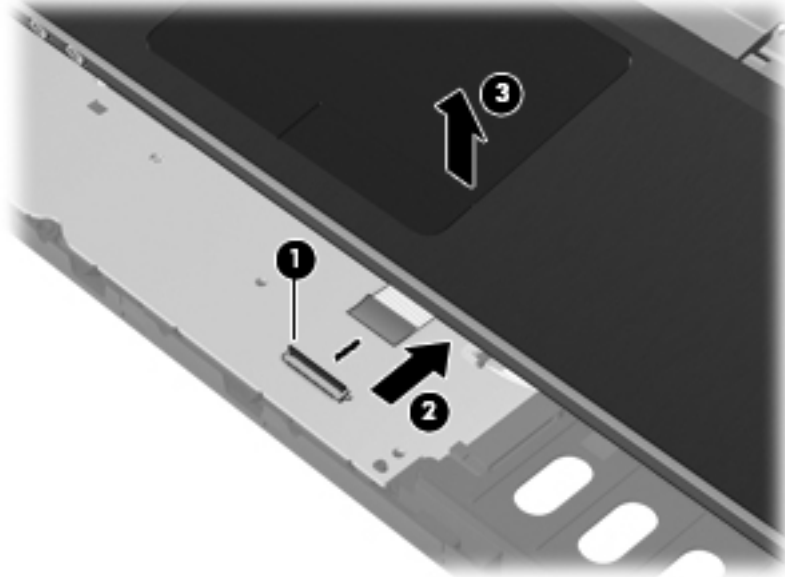

Reverse this procedure to install the top cover.

Card reader board

Description	Spare part number
Card reader board	646292-001

Before removing the card reader, follow these steps:

1. Shut down the computer. If you are unsure whether the computer is off or in Hibernation, turn the computer on, and then shut it down through the operating system.
2. Disconnect all external devices connected to the computer.
3. Disconnect the power from the computer by first unplugging the power cord from the AC outlet, and then unplugging the AC adapter from the computer.
4. Remove the battery (see [Battery on page 41](#)).
5. Remove the following components:
 - a. Bottom door (see [Bottom door on page 43](#)).
 - b. Optical drive (see [Optical drive on page 44](#))
 - c. Keyboard (see [Keyboard on page 57](#))
 - d. Top cover (see [Top cover on page 59](#))

Remove the card reader:

1. Position the top cover upside-down with the front toward you.
2. Remove the tape that secures the cable to the Touchpad button board **(1)**.
3. Disconnect the cable from the connector on the Touchpad button board **(2)**.
4. Remove the Phillips PM2.5×5.0 screw **(3)** that secures the card reader board to the top cover.

5. Rotate the Touchpad button board upward (4), and then remove it (5).

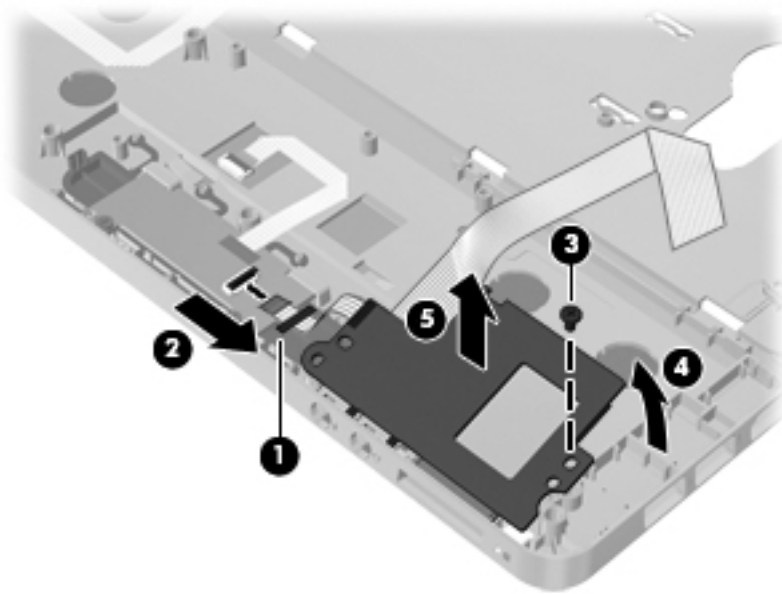

Reverse this procedure to install the card reader.

Speaker assembly

Description	Spare part number
Speaker assembly (includes housing)	646298-001

Before removing the speaker assembly, follow these steps:

1. Shut down the computer. If you are unsure whether the computer is off or in Hibernation, turn the computer on, and then shut it down through the operating system.
2. Disconnect all external devices connected to the computer.
3. Disconnect the power from the computer by first unplugging the power cord from the AC outlet, and then unplugging the AC adapter from the computer.
4. Remove the battery (see [Battery on page 41](#)).
5. Remove the following components:
 - a. Bottom door (see [Bottom door on page 43](#)).
 - b. Optical drive (see [Optical drive on page 44](#))
 - c. Keyboard (see [Keyboard on page 57](#))
 - d. Top cover (see [Top cover on page 59](#))

Remove the speaker assembly:

1. Position the top cover upside-down with the front toward you.
2. Remove the Quick Launch board cable from atop the right speaker (1).
3. Remove the power button board cable from atop the left speaker (2).
4. Remove the four Phillips PM2.0×4.0 screws (3) that secure the speakers to the computer.
5. Lift the speaker from the top cover (4) while removing the cable from its routing path in the top cover (5).

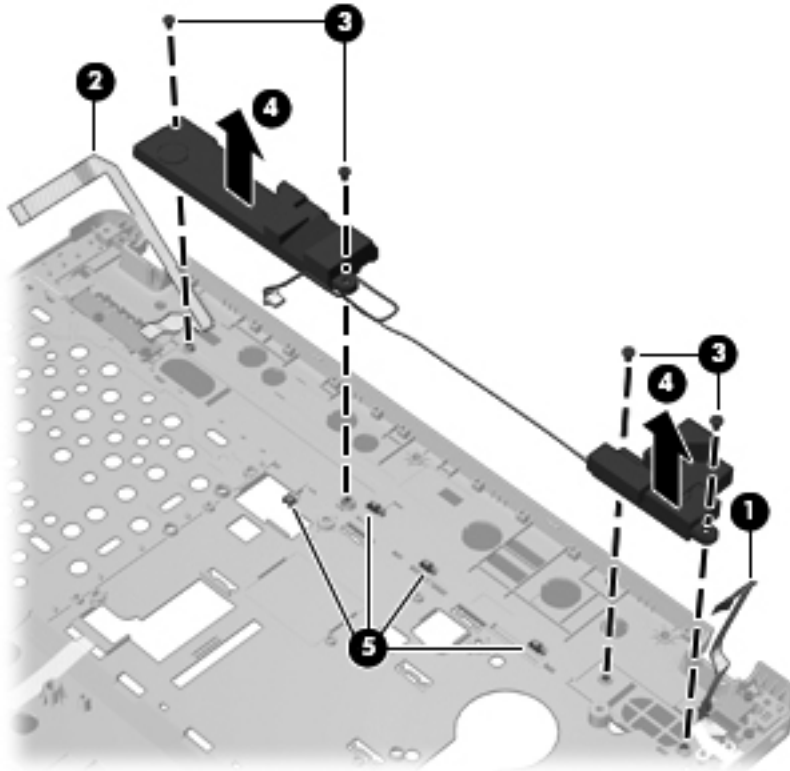

Reverse this procedure to install the speaker assembly.

Quick Launch board

Description	Spare part number
Quick Launch board	646296-001

Before removing the Quick Launch board, follow these steps:

1. Shut down the computer. If you are unsure whether the computer is off or in Hibernation, turn the computer on, and then shut it down through the operating system.
2. Disconnect all external devices connected to the computer.
3. Disconnect the power from the computer by first unplugging the power cord from the AC outlet, and then unplugging the AC adapter from the computer.
4. Remove the battery (see [Battery on page 41](#)).
5. Remove the following components:
 - a. Bottom door (see [Bottom door on page 43](#)).
 - b. Optical drive (see [Optical drive on page 44](#))
 - c. Keyboard (see [Keyboard on page 57](#))
 - d. Top cover (see [Top cover on page 59](#))
 - e. Speakers (see [Speaker assembly on page 65](#))

Remove the Quick Launch board:

1. Position the top cover upside-down with the front toward you.
2. Remove the two Phillips PM2.5×5.0 screws **(1)** that secure the board to the top cover.
3. Remove the cable **(2)** from the adhesive that secures it to the top cover.

4. Lift the side of the board (3), slide it out from under the tab, and then remove the board from the top cover (4).

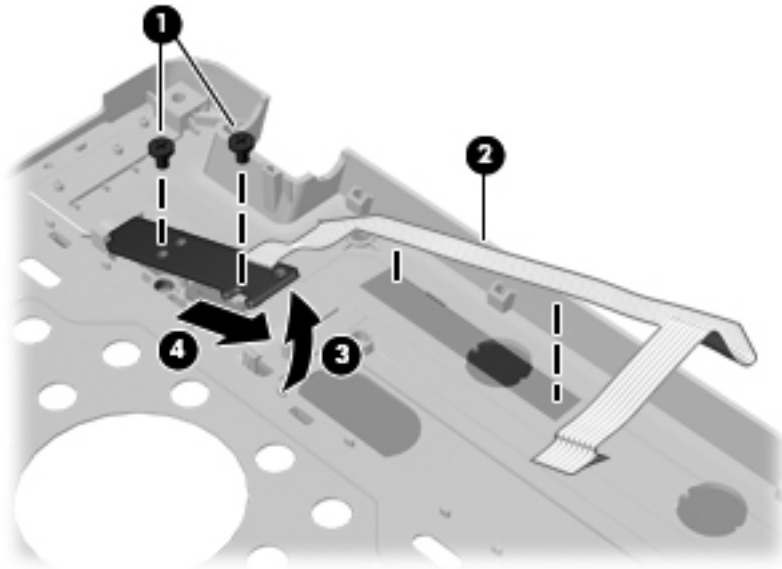

Reverse this procedure to install the Quick Launch board.

Power button board

Description	Spare part number
Power button board	646294-001

Before removing the power button board, follow these steps:

1. Shut down the computer. If you are unsure whether the computer is off or in Hibernation, turn the computer on, and then shut it down through the operating system.
2. Disconnect all external devices connected to the computer.
3. Disconnect the power from the computer by first unplugging the power cord from the AC outlet, and then unplugging the AC adapter from the computer.
4. Remove the battery (see [Battery on page 41](#)).
5. Remove the following components:
 - a. Bottom door (see [Bottom door on page 43](#)).
 - b. Optical drive (see [Optical drive on page 44](#))
 - c. Keyboard (see [Keyboard on page 57](#))
 - d. Top cover (see [Top cover on page 59](#))

Remove the power button board:

1. Position the top cover upside-down with the front toward you.
2. Remove the two Phillips PM2.0×4.0 screws (1) that secure the board to the top cover.
3. Lift the board up at an angle (2), and then remove it from the top cover (3).

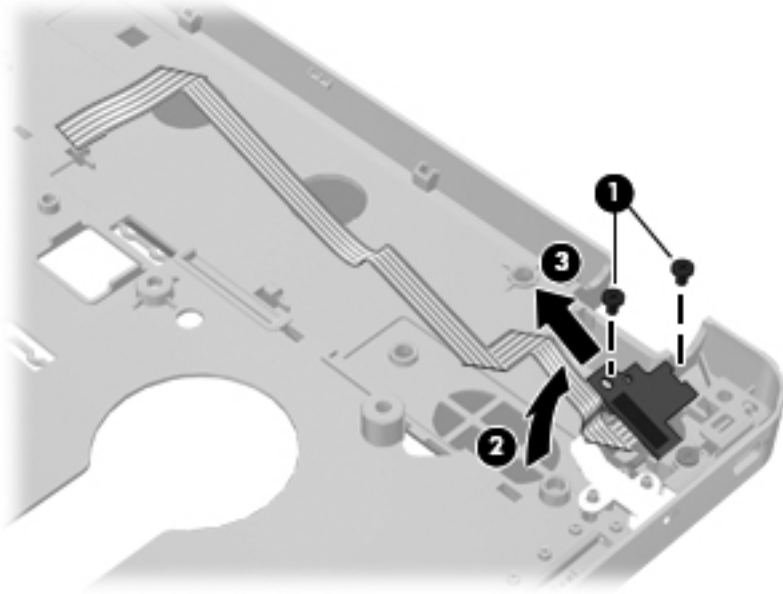

Reverse this procedure to install the power button board.

Modem module



NOTE: The modem module spare part kit does not include a modem module cable. The modem module cable is included in the Cable Kit, spare part number 646303-001. See [Cable Kit on page 27](#) for more Cable Kit spare part number information.

Description	Spare part number
Modem module	628824-001

Before removing the modem module, follow these steps:

1. Shut down the computer. If you are unsure whether the computer is off or in Hibernation, turn the computer on, and then shut it down through the operating system.
2. Disconnect all external devices connected to the computer.
3. Disconnect the power from the computer by first unplugging the power cord from the AC outlet, and then unplugging the AC adapter from the computer.
4. Remove the battery (see [Battery on page 41](#)).
5. Remove the following components:
 - a. Bottom door (see [Bottom door on page 43](#)).
 - b. Optical drive (see [Optical drive on page 44](#))
 - c. Keyboard (see [Keyboard on page 57](#))
 - d. Top cover (see [Top cover on page 59](#))

Remove the modem module:

1. Position the computer upright with the front toward you.
2. Remove the two Phillips PM2.5×5.0 screws **(1)** that secures the modem module to the system board.
3. Disconnect the modem module **(2)** from the system board by lifting it straight up.

4. Disconnect the modem module cable (3) from the modem module.

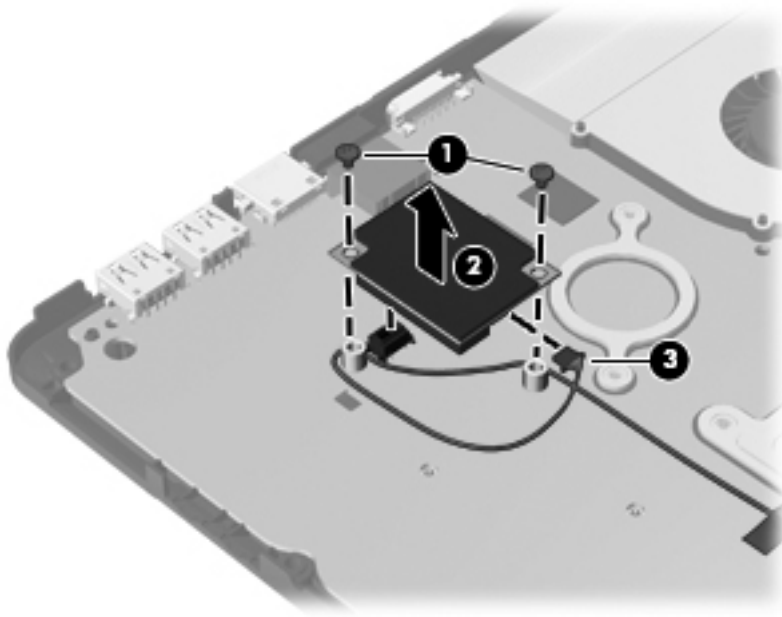

Reverse this procedure to install the modem module.

Lid switch

Description	Spare part number
Lid switch board	646289-001

Before removing the lid switch, follow these steps:

1. Shut down the computer. If you are unsure whether the computer is off or in Hibernation, turn the computer on, and then shut it down through the operating system.
2. Disconnect all external devices connected to the computer.
3. Disconnect the power from the computer by first unplugging the power cord from the AC outlet, and then unplugging the AC adapter from the computer.
4. Remove the battery (see [Battery on page 41](#)).
5. Remove the following components:
 - a. Bottom door (see [Bottom door on page 43](#)).
 - b. Optical drive (see [Optical drive on page 44](#))
 - c. Keyboard (see [Keyboard on page 57](#))
 - d. Top cover (see [Top cover on page 59](#))

Remove the lid switch:

1. Position the computer upright with the front toward you.
2. Lift the system board connector latch(1), and then disconnect the cable (2).
3. Lift the board from the computer (3).

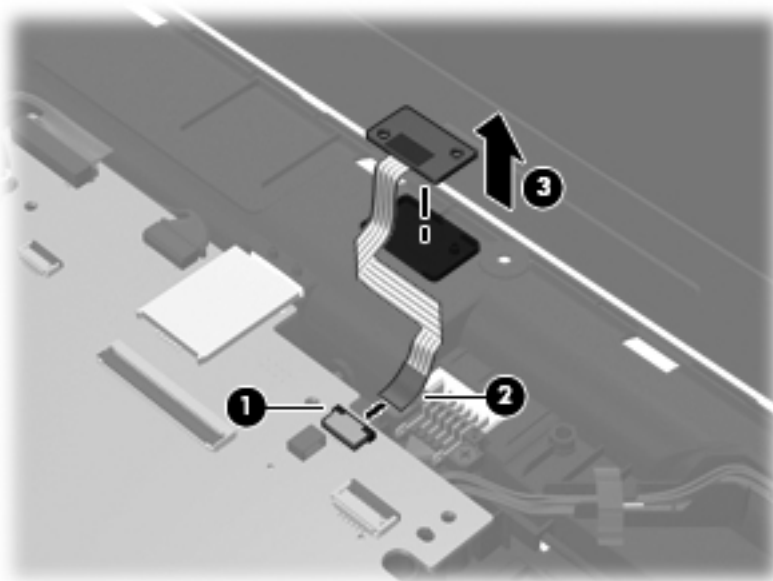

Reverse this procedure to install the lid switch.

USB board

Description	Spare part number
USB board	646287-001

Before removing the USB board, follow these steps:

1. Shut down the computer. If you are unsure whether the computer is off or in Hibernation, turn the computer on, and then shut it down through the operating system.
2. Disconnect all external devices connected to the computer.
3. Disconnect the power from the computer by first unplugging the power cord from the AC outlet, and then unplugging the AC adapter from the computer.
4. Remove the battery (see [Battery on page 41](#)).
5. Remove the following components:
 - a. Bottom door (see [Bottom door on page 43](#)).
 - b. Optical drive (see [Optical drive on page 44](#))
 - c. Keyboard (see [Keyboard on page 57](#))
 - d. Top cover (see [Top cover on page 59](#))

Remove the USB board:

1. Position the computer upright with the front toward you.
2. Lift the system board connector latch **(1)**, and then disconnect the USB board cable from the system board **(2)**.
3. Remove the two Phillips PM2.5×5.0 screws **(3)** that secure the USB board to the computer.

4. Lift the board and cable straight up out of the computer (4)

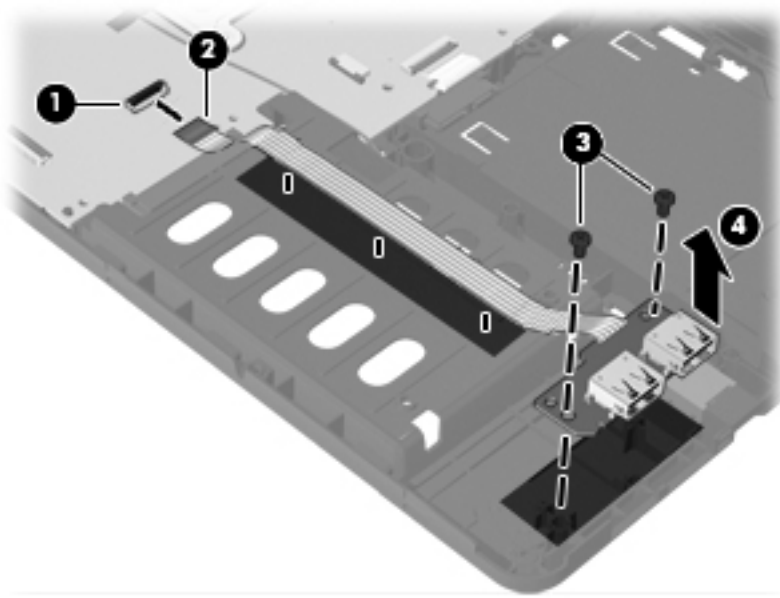

Reverse this procedure to install the USB board.

RJ-11 jack cable



NOTE: The RJ-11 jack cable is included in the Cable Kit, spare part number 646303-001.

Before removing the RJ-11 jack cable, follow these steps:

1. Shut down the computer. If you are unsure whether the computer is off or in Hibernation, turn the computer on, and then shut it down through the operating system.
2. Disconnect all external devices connected to the computer.
3. Disconnect the power from the computer by first unplugging the power cord from the AC outlet, and then unplugging the AC adapter from the computer.
4. Remove the battery (see [Battery on page 41](#)).
5. Remove the following components:
 - a. Bottom door (see [Bottom door on page 43](#)).
 - b. Optical drive (see [Optical drive on page 44](#))
 - c. Modem module (see [Modem module on page 70](#))
 - d. Keyboard (see [Keyboard on page 57](#))
 - e. Top cover (see [Top cover on page 59](#))
 - f. USB board (see [USB board on page 73](#))

Remove the RJ-11 jack cable:

1. Position the computer upright with the front toward you.
2. Remove the tape **(1)** that secures the cable to the computer.
3. Remove the RJ-11 jack cable from the clips and routing channel **(2)** built into the base enclosure.

4. Remove the RJ-11 jack from the clip built into the base enclosure (3).

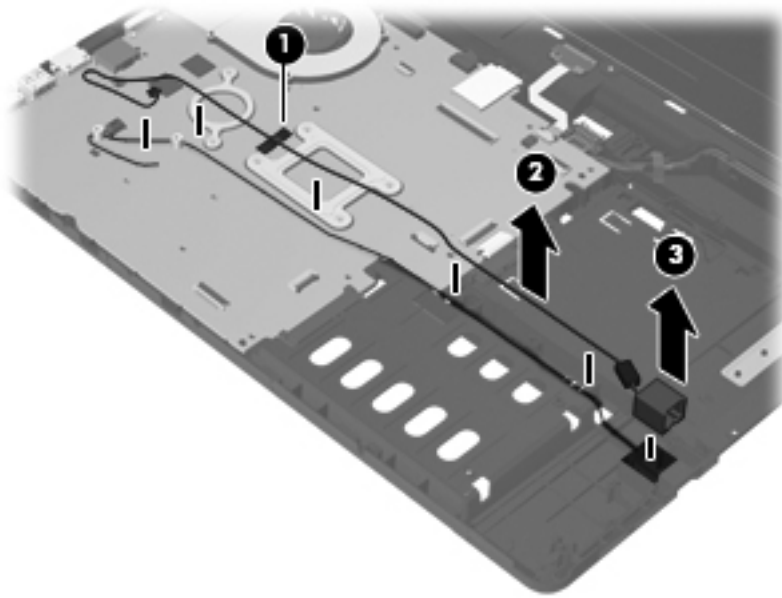

Reverse this procedure to install the RJ-11 jack cable.

System board



NOTE: All system board spare part kits include replacement thermal material.

Description	Spare part number
System board for use in models with 1-GB of discrete memory	654306-001
System board for use in models with 512-MB of discrete memory	654307-001
System board for use in models with UMA graphics with WWAN	654309-001
System board for use in models with UMA graphics without WWAN	654308-001

Before removing the system board, follow these steps:

1. Shut down the computer. If you are unsure whether the computer is off or in Hibernation, turn the computer on, and then shut it down through the operating system.
2. Disconnect all external devices connected to the computer.
3. Disconnect the power from the computer by first unplugging the power cord from the AC outlet, and then unplugging the AC adapter from the computer.
4. Remove the battery (see [Battery on page 41](#)).
5. Remove the following components:
 - a. Bottom door (see [Bottom door on page 43](#)).
 - b. Hard drive (see [Hard drive on page 46](#))

- c. Optical drive (see [Optical drive on page 44](#))
- d. Modem module (see [Modem module on page 70](#))
- e. Keyboard (see [Keyboard on page 57](#))
- f. Top cover (see [Top cover on page 59](#))

When replacing the system board, be sure to remove the following components from the defective system board and install on the replacement system board:

- SIM (see [SIM on page 42](#))
- Memory module (see [Memory modules on page 48](#))
- WLAN module (see [WLAN/Bluetooth combo card on page 52](#))
- WWAN module (see [WWAN module on page 50](#))
- Modem module (see [Modem module on page 70](#))
- Processor (see [Processor on page 85](#))

Remove the system board:

1. Position the computer upright with the front toward you.
2. Disconnect the webcam cable (1) and the display cable (2) from the system board, and remove the cables from the routing clip (3).

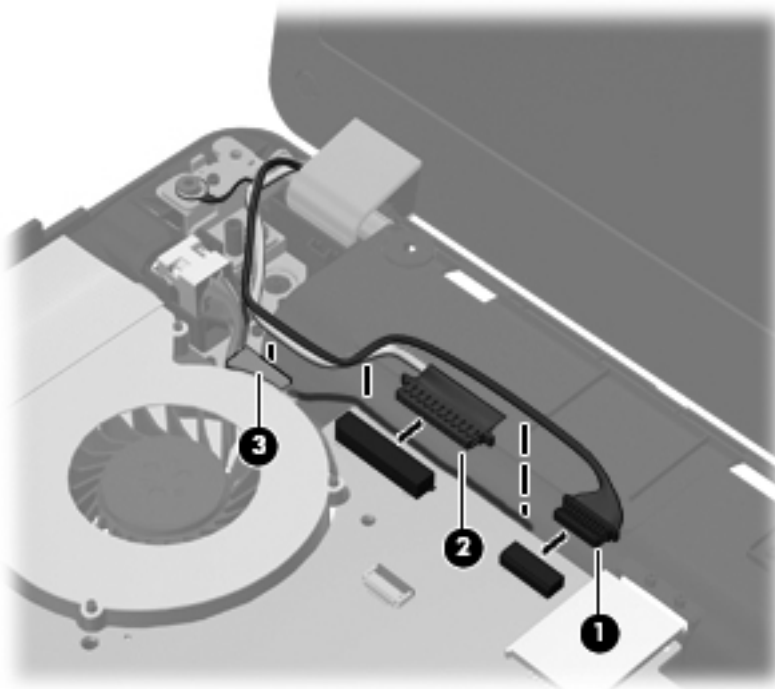

3. Remove the Phillips PM2.5×5.0 screw (1) that secures the system board to the base enclosure.
4. Lift the optical drive connector latch (2), and then disconnect the optical drive cable (3).

5. Lift the system board up at an angle (4) to gain access to the cables underneath.

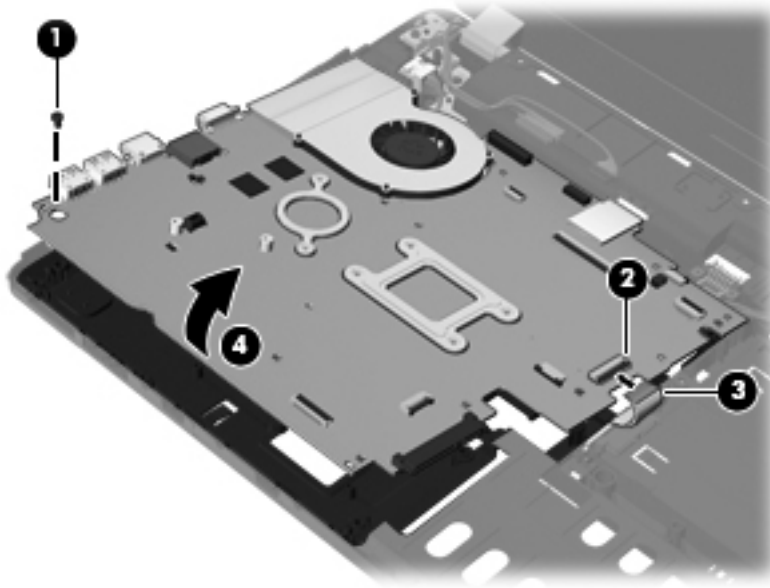

6. On the bottom of the system board, disconnect the battery connector cable (1) from the system board.
7. Disconnect the smaller power cable (2) and the larger power cable (3) from the system board.
8. Lift the system board out of the computer (4).

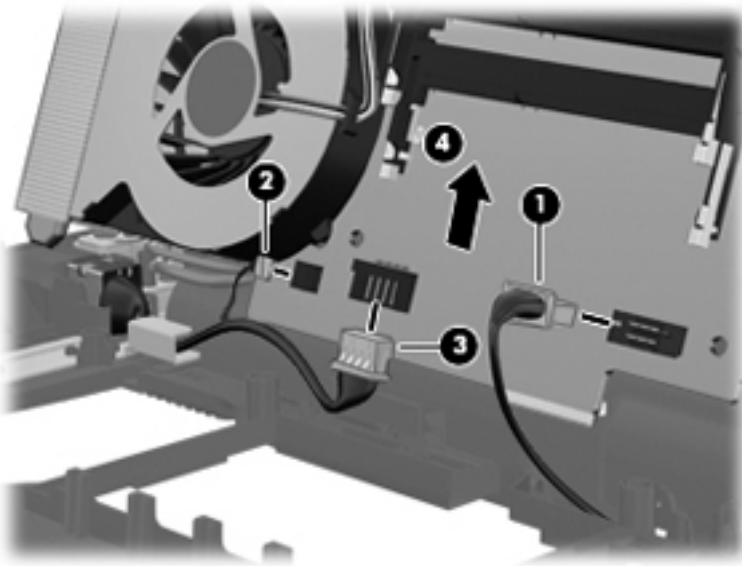

Reverse this procedure to install the system board.

RTC battery

Description	Spare part number
RTC battery	449137-001

Before removing the RTC battery, follow these steps:

1. Shut down the computer. If you are unsure whether the computer is off or in Hibernation, turn the computer on, and then shut it down through the operating system.
2. Disconnect all external devices connected to the computer.
3. Disconnect the power from the computer by first unplugging the power cord from the AC outlet, and then unplugging the AC adapter from the computer.
4. Remove the battery (see [Battery on page 41](#)).
5. Remove the following components:
 - a. Bottom door (see [Bottom door on page 43](#)).
 - b. Hard drive (see [Hard drive on page 46](#))
 - c. Optical drive (see [Optical drive on page 44](#))
 - d. WLAN module (see [WLAN/Bluetooth combo card on page 52](#))
 - e. WWAN module (see [WWAN module on page 50](#))
 - f. Fan (see [Fan on page 81](#))
 - g. Heat sink (see [Heat sink on page 83](#))
 - h. Keyboard (see [Keyboard on page 57](#))
 - i. Top cover (see [Top cover on page 59](#))
 - j. System board (see [System board on page 76](#))

Remove the RTC battery:

1. Position the computer upside-down with the front toward you.
2. Use a screwdriver to loosen the battery from the slot **(1)**.

3. Lift the battery from the system board (2).

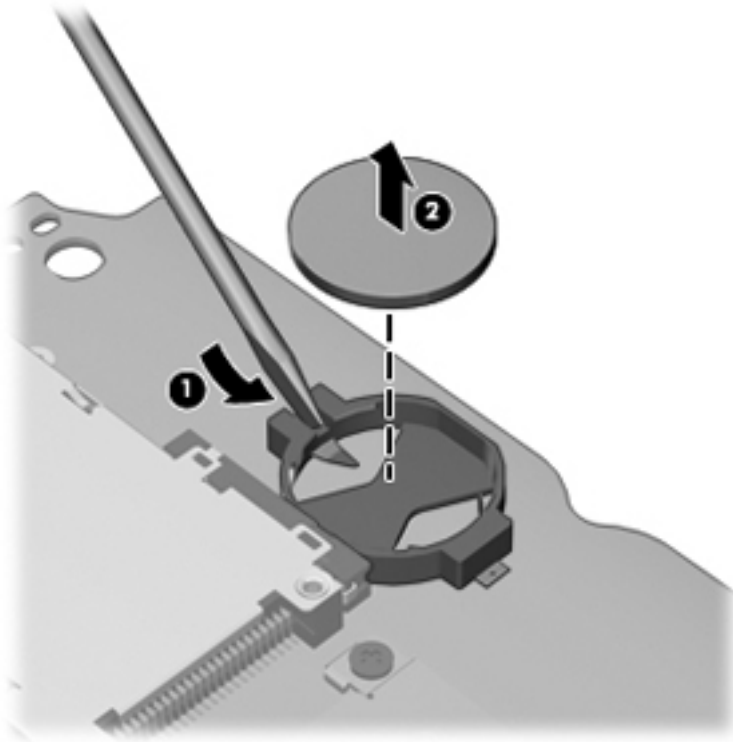

Reverse this procedure to install the RTC battery.

Fan

Description	Spare part number
Fan	646285-001

Before removing the fan, follow these steps:

1. Shut down the computer. If you are unsure whether the computer is off or in Hibernation, turn the computer on, and then shut it down through the operating system.
2. Disconnect all external devices connected to the computer.
3. Disconnect the power from the computer by first unplugging the power cord from the AC outlet, and then unplugging the AC adapter from the computer.
4. Remove the battery (see [Battery on page 41](#)).
5. Remove the following components:
 - a. Bottom door (see [Bottom door on page 43](#)).
 - b. Hard drive (see [Hard drive on page 46](#))
 - c. Optical drive (see [Optical drive on page 44](#))
 - d. WLAN module (see [WLAN/Bluetooth combo card on page 52](#))
 - e. WWAN module (see [WWAN module on page 50](#))
 - f. Fan (see [Fan on page 81](#))
 - g. Heat sink (see [Heat sink on page 83](#))
 - h. Keyboard (see [Keyboard on page 57](#))
 - i. Top cover (see [Top cover on page 59](#))
 - j. System board (see [System board on page 76](#))

Remove the fan:

1. Position the system board upright.
2. Disconnect the fan cable **(1)** from the system board.
3. Remove the Phillips PM2.5×5.0 screw **(2)** that secures the fan to the system board.

4. Remove the fan from the system board (3).

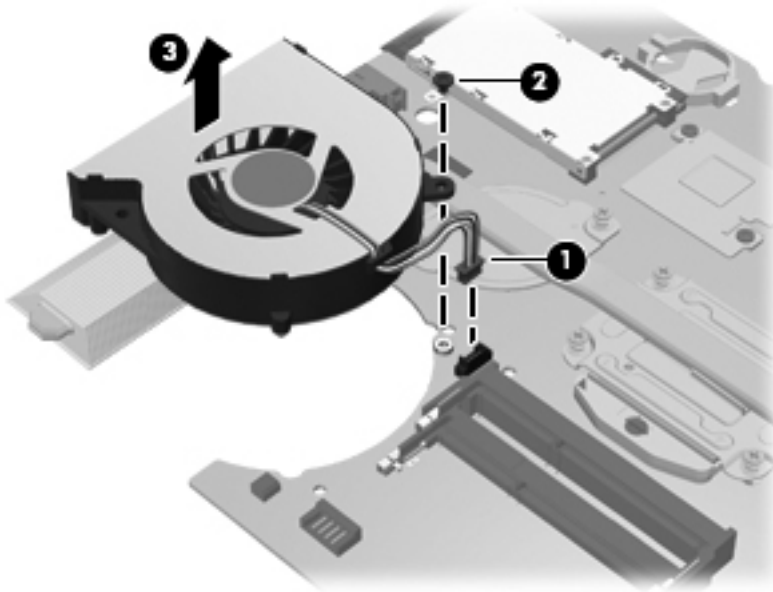

Reverse this procedure to install the fan.

 **NOTE:** To properly ventilate the computer, allow at least a 7.6-cm (3-in) clearance on the left side of the computer.

The computer uses an electric fan for ventilation. The fan is controlled by a temperature sensor and is designed to turn on automatically when high temperature conditions exist. These conditions are affected by high external temperatures, system power consumption, power management/battery conservation configurations, battery fast charging, and software requirements. Exhaust air is displaced through the ventilation grill located on the left side of the computer.

Heat sink

All heat sink spare part kits include replacement thermal material.

Description	Spare part number
Heat sink for use in computers with discrete graphics	654310-001
Heat sink for use in computers with UMA graphics	654311-001

Before removing the heat sink, follow these steps:

1. Shut down the computer. If you are unsure whether the computer is off or in Hibernation, turn the computer on, and then shut it down through the operating system.
2. Disconnect all external devices connected to the computer.
3. Disconnect the power from the computer by first unplugging the power cord from the AC outlet, and then unplugging the AC adapter from the computer.
4. Remove the battery (see [Battery on page 41](#)).
5. Remove the following components:
 - a. Bottom door (see [Bottom door on page 43](#)).
 - b. Hard drive (see [Hard drive on page 46](#))
 - c. Optical drive (see [Optical drive on page 44](#))
 - d. WLAN module (see [WLAN/Bluetooth combo card on page 52](#))
 - e. WWAN module (see [WWAN module on page 50](#))
 - f. Fan (see [Fan on page 81](#))
 - g. Heat sink (see [Heat sink on page 83](#))
 - h. Keyboard (see [Keyboard on page 57](#))
 - i. Top cover (see [Top cover on page 59](#))
 - j. System board (see [System board on page 76](#))
 - k. Fan (see [Fan on page 81](#))

Remove the heat sink:

1. Position the system board upright.
2. To remove the UMA heat sink, in the order indicated, loosen the four captive Phillips screws **(1)** — **(4)** that secure the heat sink to the system board.

3. Remove the heat sink from the system board (5).

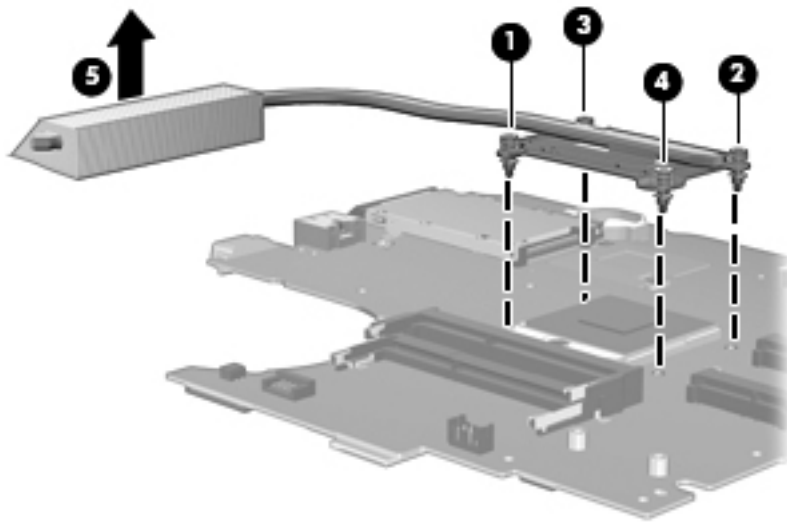

 **NOTE:** For UMA models, thoroughly clean thermal material from the surface of the system board (1) and heat sink (2) each time you remove the heat sink. All heat sink and processor spare part kits include thermal material.

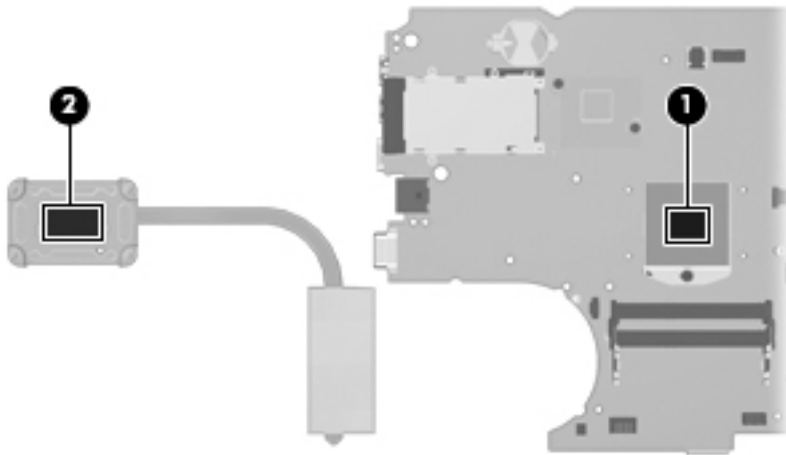

Reverse this procedure to install the heat sink.

Processor



NOTE: All processor spare part kits include replacement thermal material.

Description	Spare part number
AMD E2-3000M APU (2.4-GHz/1.8-GHz, 1-MB L2 cache)	653351-001
AMD A6-3420M APU (2.4-GHz/1.5-GHz, 4-MB L2 cache)	669688-001
AMD A6-3400M APU (2.3-GHz/1.4-GHz, 4-MB L2 cache)	653349-001
AMD A4-3320M APU (2.6-GHz/2.0-GHz, 2-MB L2 cache)	669688-001
AMD A4-3305M APU (2.5-GHz/1.9-GHz, 1-MB L2 cache)	672093-001
AMD A4-3300M APU (2.5-GHz/1.9-GHz, 2-MB L2 cache)	653348-001

Before removing the processor, follow these steps:

1. Shut down the computer. If you are unsure whether the computer is off or in Hibernation, turn the computer on, and then shut it down through the operating system.
2. Disconnect all external devices connected to the computer.
3. Disconnect the power from the computer by first unplugging the power cord from the AC outlet, and then unplugging the AC adapter from the computer.
4. Remove the battery (see [Battery on page 41](#)).
5. Remove the following components:
 - a. Bottom door (see [Bottom door on page 43](#)).
 - b. Hard drive (see [Hard drive on page 46](#))
 - c. Optical drive (see [Optical drive on page 44](#))
 - d. WLAN module (see [WLAN/Bluetooth combo card on page 52](#))
 - e. WWAN module (see [WWAN module on page 50](#))
 - f. Fan (see [Fan on page 81](#))
 - g. Heat sink (see [Heat sink on page 83](#))
 - h. Keyboard (see [Keyboard on page 57](#))
 - i. Top cover (see [Top cover on page 59](#))
 - j. System board (see [System board on page 76](#))
 - k. Fan (see [Fan on page 81](#))
 - l. Heat sink (see [Heat sink on page 83](#))

Remove the processor:

1. Position the computer upside-down with the front toward you.
2. Use a flat-bladed screwdriver to turn the processor locking screw **(1)** one-half turn counterclockwise until you hear a click.
3. Lift the processor **(2)** straight up and remove it.

 **NOTE:** The gold triangle **(3)** on the processor must be aligned with the triangle **(4)** embossed on the processor slot when you install the processor.

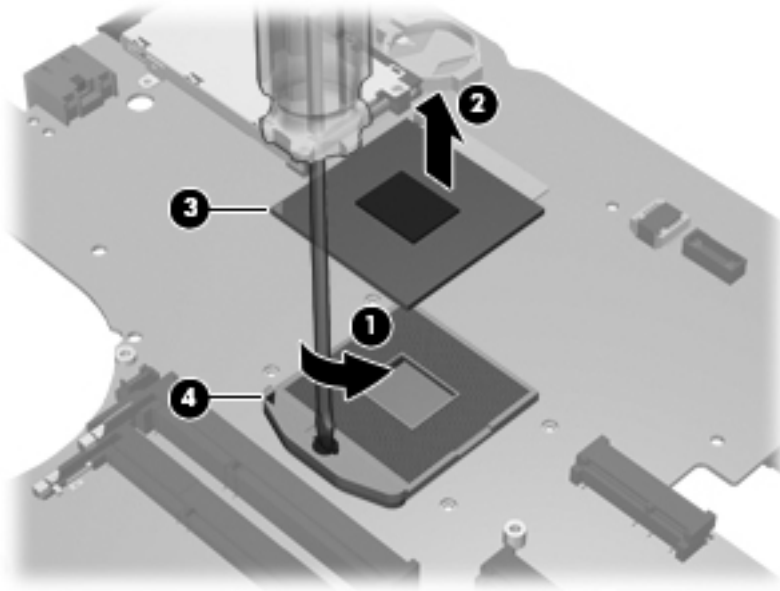

Reverse this procedure to install the processor.

Power cable

The power cable is included in the Cable Kit, spare part number 646303-001.

Before removing the power cable, follow these steps:

1. Shut down the computer. If you are unsure whether the computer is off or in Hibernation, turn the computer on, and then shut it down through the operating system.
2. Disconnect all external devices connected to the computer.
3. Disconnect the power from the computer by first unplugging the power cord from the AC outlet, and then unplugging the AC adapter from the computer.
4. Remove the battery (see [Battery on page 41](#)).
5. Remove the following components:
 - a. Bottom door (see [Bottom door on page 43](#)).
 - b. Hard drive (see [Hard drive on page 46](#))
 - c. Optical drive (see [Optical drive on page 44](#))
 - d. WLAN module (see [WLAN/Bluetooth combo card on page 52](#))
 - e. WWAN module (see [WWAN module on page 50](#))
 - f. Fan (see [Fan on page 81](#))
 - g. Heat sink (see [Heat sink on page 83](#))
 - h. Keyboard (see [Keyboard on page 57](#))
 - i. Top cover (see [Top cover on page 59](#))
 - j. System board (see [System board on page 76](#))

Remove the power cable:

1. Position the computer upright with the front toward you.
2. Remove the cable from the routing clamp **(1)**.

3. Lift the power cable assembly from the computer (2).

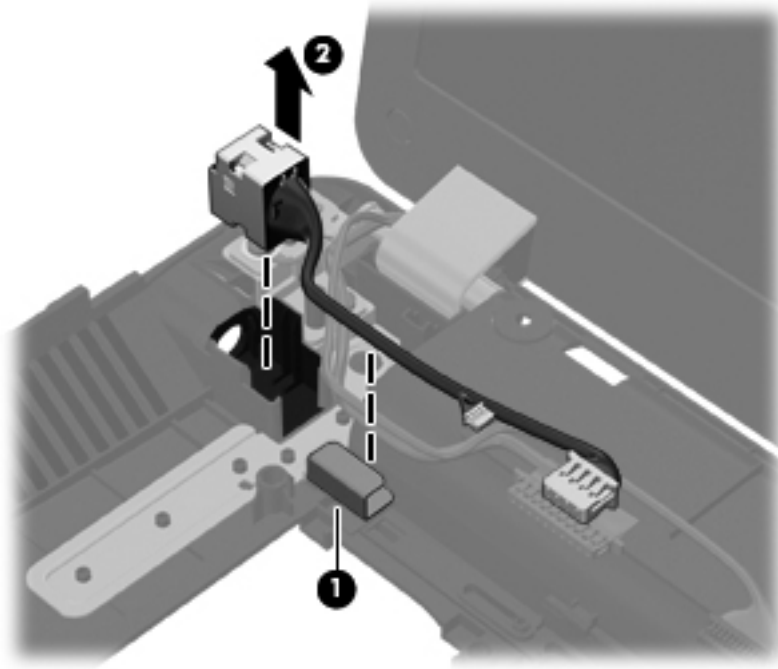

Reverse this procedure to install the power cable.

Display assembly

All display assemblies include WLAN antenna transceivers and cables. WWAN models include 2 WWAN antenna transceivers and cables.

For a list of individual display spare parts, see [Display components on page 25](#).

Description	Spare part number
39.6-cm (15.6-inch) HD, anti-glare, without webcam	654315-001
39.6-cm (15.6-inch) HD, anti-glare, with webcam	654313-001
39.6-cm (15.6-inch) HD, anti-glare, with webcam and WWAN	654317-001
39.6-cm (15.6-inch) HD, BrightView, without webcam	654321-001
39.6-cm (15.6-inch) HD, BrightView, with webcam	654319-001
39.6-cm (15.6-inch) HD, BrightView, with webcam and WWAN	654323-001

Before removing the display assembly, follow these steps:

1. Shut down the computer. If you are unsure whether the computer is off or in Hibernation, turn the computer on, and then shut it down through the operating system.
2. Disconnect all external devices connected to the computer.
3. Disconnect the power from the computer by first unplugging the power cord from the AC outlet, and then unplugging the AC adapter from the computer.
4. Remove the battery (see [Battery on page 41](#)).
5. Remove the following components:
 - a. Bottom door (see [Bottom door on page 43](#)).
 - b. WLAN module (see [WLAN/Bluetooth combo card on page 52](#))
 - c. WWAN module (see [WWAN module on page 50](#))
 - d. Keyboard (see [Keyboard on page 57](#))
 - e. Top cover (see [Top cover on page 59](#))

Remove the display assembly:

1. Position the computer upright with the front toward you.
2. Open the computer as far as possible.

3. If necessary, disconnect the webcam cable (1) and display cable (2) from the system board, and then remove the cables from the clip (3).

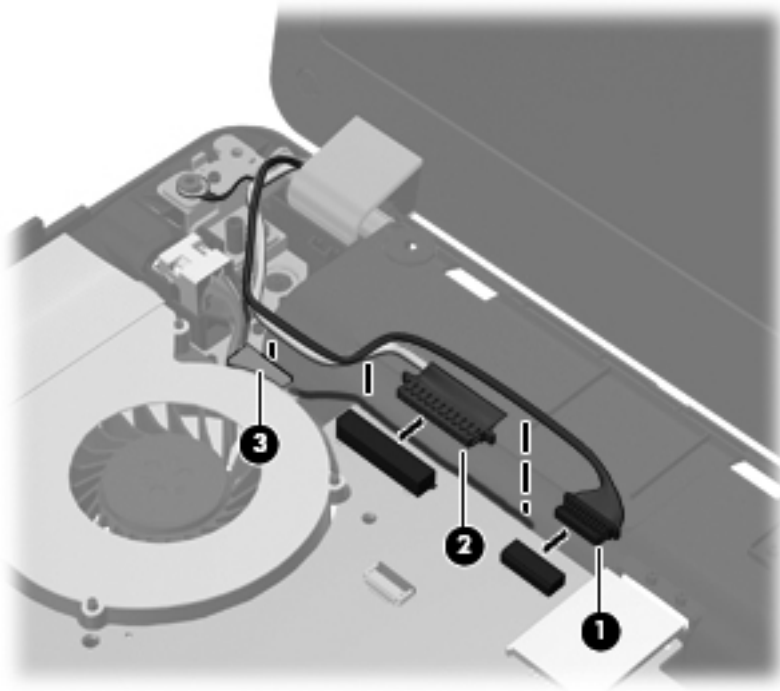

4. Remove the four Phillips PM2.5×7.0 screws (1) from the hinges, noting the grounding wire connected to the screw in the left hinge (2).

5. Lift the display from the computer (3).

When installing the display assembly, be sure that the wireless antenna cables are routed and arranged properly.

Failure to properly route the antennas can result in degradation of the computer's WLAN and WWAN performance.

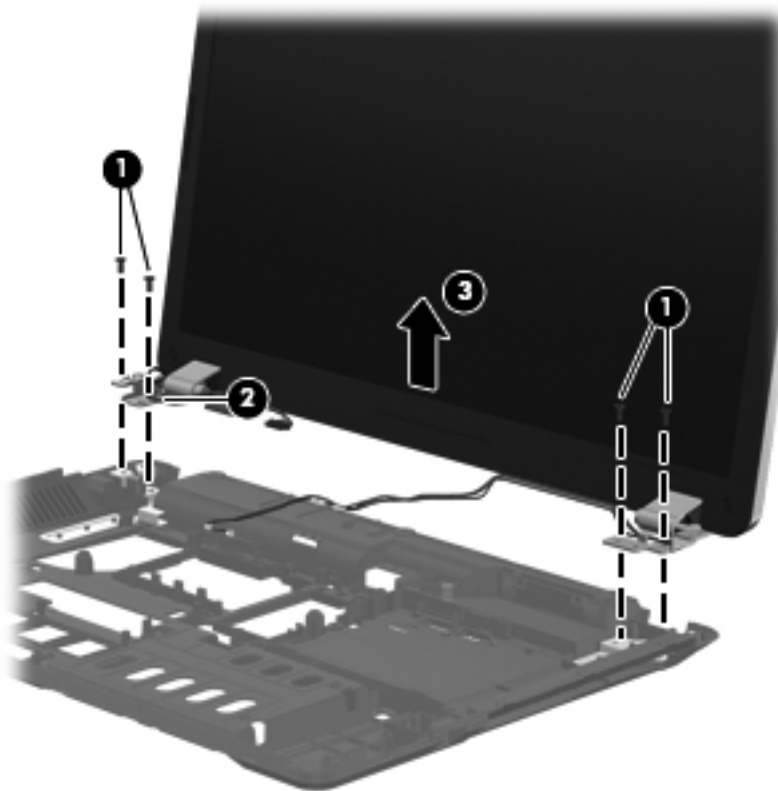

6. If you need to remove the hinge covers from the display hinges, pull the hinges straight up and off the display to remove them.

Display hinge covers are available using spare part number 646281-001.

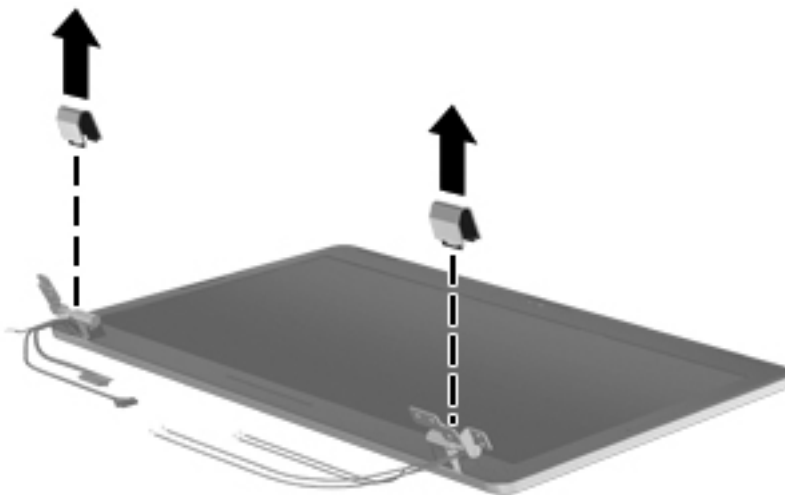

7. To replace the display bezel, remove the two rubber screw covers **(1)** and the two Torx T8M2.5×6.0 screws **(2)** in the bottom corners of the display bezel.
8. Flex the top **(3)** of the bezel, the inside edges of the left and right sides **(4)**, and then the bottom **(5)** of the bezel until it disengages from the display enclosure.

The bezel is available using the following spare part numbers:

646265-001: models without a webcam

646266-001: models with a webcam

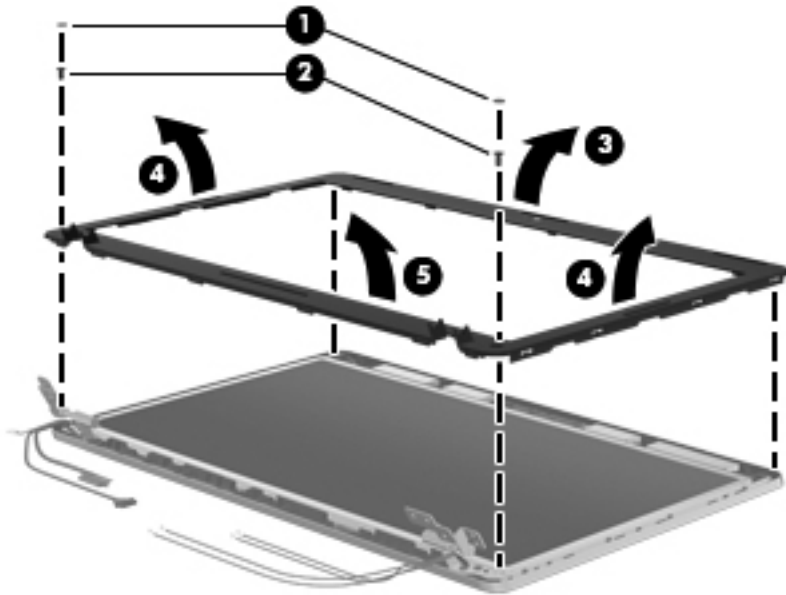

9. Remove the display bezel.

10. If it is necessary to replace the webcam module (shown in the following image) or microphone module from the display enclosure, disconnect the cable from the module **(1)**, and then gently pull the module away from the double-sided tape on the display enclosure **(2)**.

The webcam module is available using spare part number 642795-001.

The microphone module is removed using the same procedure and is available using spare part number 642797-001.

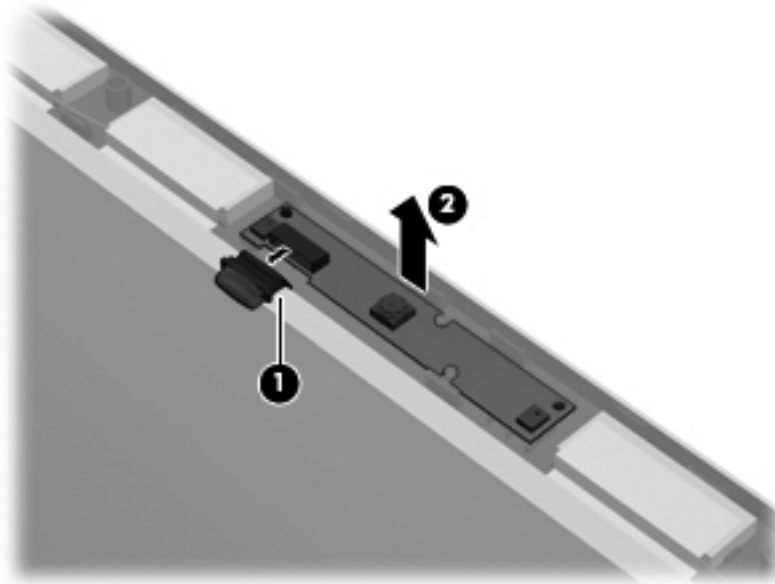

11. If it is necessary to replace the display panel, remove the four Phillips PM2.5×5.0 screws **(1)** at the bottom and two Phillips PM2.5×5.0 broadhead screws **(2)** at the top that secure the panel to the display enclosure.
12. Rotate the top of the panel upward **(3)**.

The display panel is available using the following spare part numbers:

- 646311-001: 39.6-cm (15.6-inch) HD, anti-glare
- 646312-001: 39.6-cm (15.6-inch) HD, Brightview

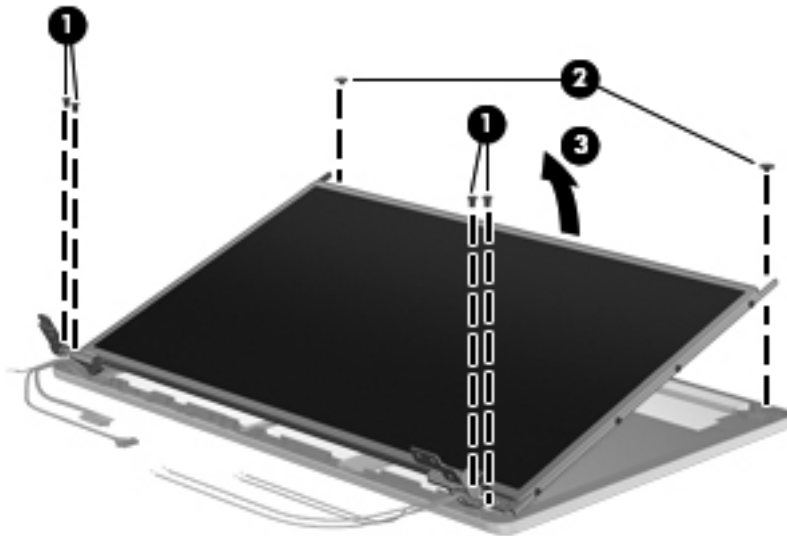

13. Disconnect the display panel cable from the back of the display panel by lifting the tape over the connector (1), and then disconnecting the cable from the panel (2).

The display cable is available using spare part number 605766-001 for models without a webcam, 646273-001 for models with a webcam.

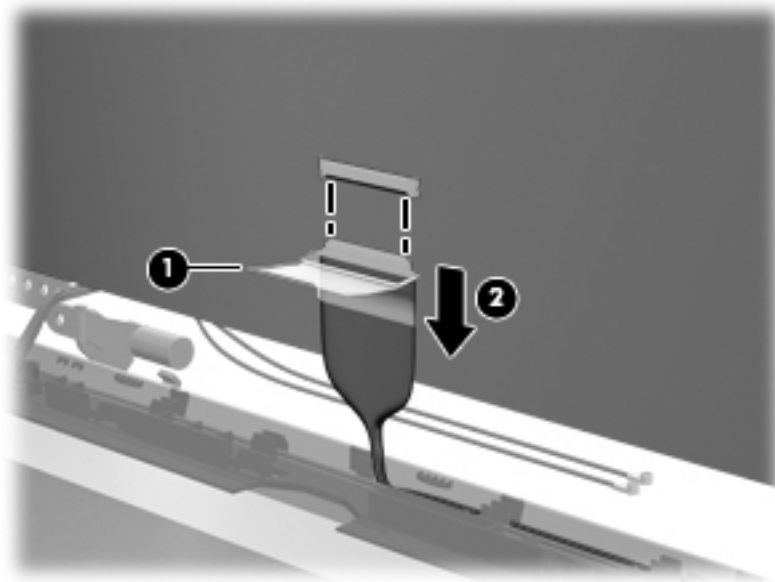

14. If it is necessary to replace the display hinges, remove the four Phillips PM2.5×3.0 screws (1) that secure each display hinge to the display panel.

15. Remove the display hinges (2).

Display hinges are available using spare part number 646279-001.

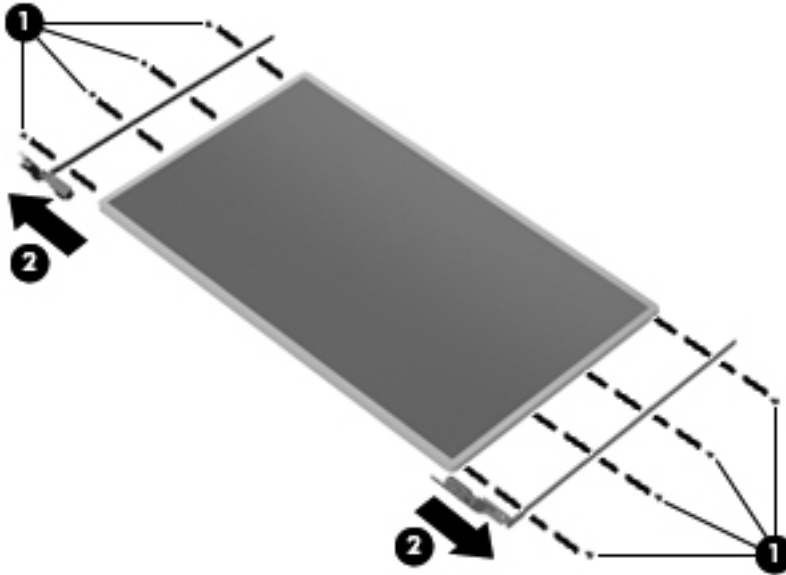

16. If you need to remove the WLAN or WWAN antennas, lift the WLAN antenna cables (1) or WWAN antenna cables (2) from the clips and routing paths (3) built into the display enclosure.

The WLAN antennas are available using spare part number 646276-001, and the WWAN antennas are available using spare part number 646278-001.

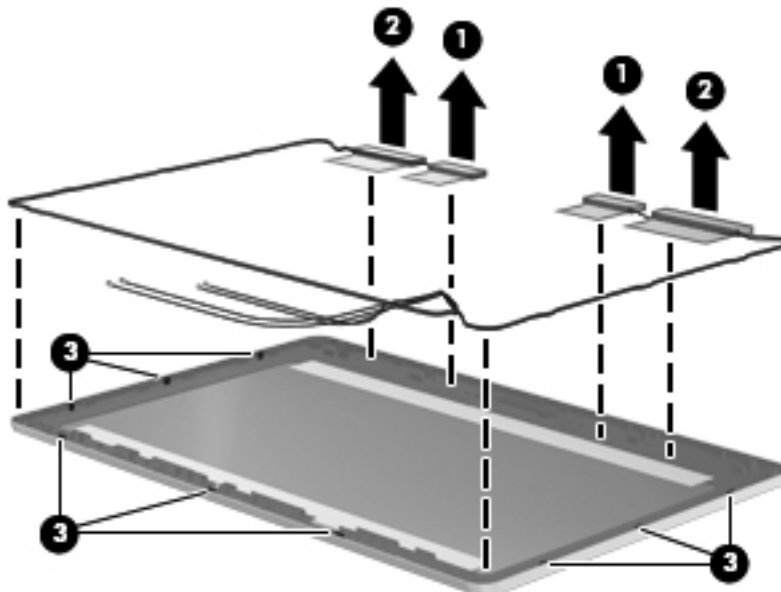

CAUTION: When installing the display assembly, be sure that the wireless antenna cables are routed and arranged properly.

Failure to properly route the antennas can result in degradation of the computer's wireless performance.

17. To remove the display cable (1) or webcam cable (2) from the display enclosure, remove the cable from the clips (3) and routing paths in the display enclosure.

The display cable is available using spare part number 605766-001 for models without a webcam, 646273-001 for models with a webcam. The webcam cable is available using spare part number 646275-001.

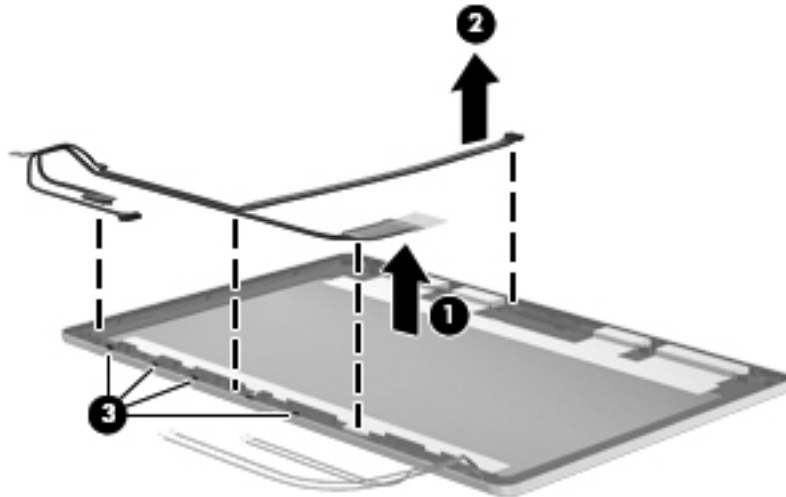

Reverse this procedure to reassemble and install the display assembly.

Note the correct cable routing paths for the antenna cables. Make sure you properly route all cables when assembling the computer as shown in the following images.

Cable routing path – top

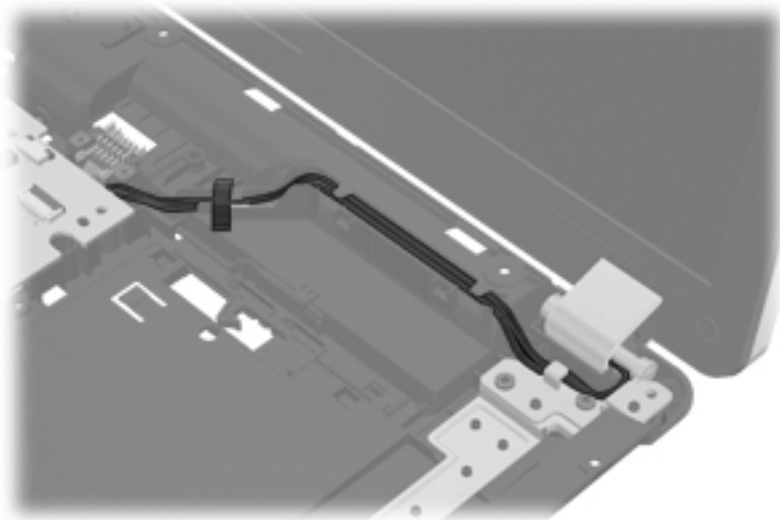

Cable routing path – bottom

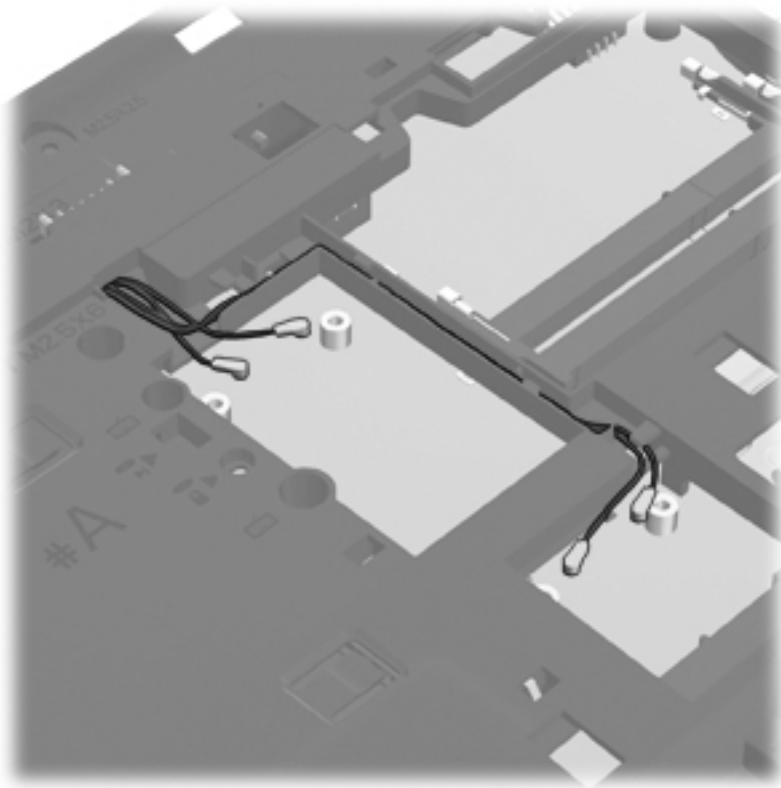

5 Computer Setup (BIOS) and System Diagnostics

Using Computer Setup

Computer Setup, or Basic Input/Output System (BIOS), controls communication between all the input and output devices on the system (such as disk drives, display, keyboard, mouse, and printer). Computer Setup includes settings for the types of devices installed, the startup sequence of the computer, and the amount of system and extended memory.

 **NOTE:** Use extreme care when making changes in Computer Setup. Errors can prevent the computer from operating properly.

Starting Computer Setup

 **NOTE:** An external keyboard or mouse connected to a USB port can be used with Computer Setup only if USB legacy support is enabled.

To start Computer Setup, follow these steps:

1. Turn on or restart the computer, and then press **esc** while the “Press the ESC key for Startup Menu” message is displayed at the bottom of the screen.
2. Press **f10** to enter Computer Setup.

Navigating and selecting in Computer Setup

To navigate and select in Computer Setup, follow these steps:

1. Turn on or restart the computer, and then press **esc** while the “Press the ESC key for Startup Menu” message is displayed at the bottom of the screen.
 - To select a menu or a menu item, use the tab key and the keyboard arrow keys and then press **enter**, or use a pointing device to click the item.
 - To scroll up and down, click the up arrow or the down arrow in the upper-right corner of the screen, or use the up arrow key or the down arrow key.
 - To close open dialog boxes and return to the main Computer Setup screen, press **esc**, and then follow the on-screen instructions.

 **NOTE:** You can use either a pointing device (TouchPad, pointing stick, or USB mouse) or the keyboard to navigate and make selections in Computer Setup.

2. Press **f10** to enter Computer Setup.

To exit Computer Setup menus, choose one of the following methods:

- To exit Computer Setup menus without saving your changes:

Click the **Exit** icon in the lower-left corner of the screen, and then follow the on-screen instructions.

– or –

Use the tab key and the arrow keys to select **File > Ignore Changes and Exit**, and then press [enter](#).

- To save your changes and exit Computer Setup menus:

Click the **Save** icon in the lower-left corner of the screen, and then follow the on-screen instructions.

– or –

Use the tab key and the arrow keys to select **File > Save Changes and Exit**, and then press [enter](#).

Your changes go into effect when the computer restarts.

Restoring factory settings in Computer Setup



NOTE: Restoring defaults will not change the hard drive mode.

To return all settings in Computer Setup to the values that were set at the factory, follow these steps:

1. Turn on or restart the computer, and then press [esc](#) while the “Press the ESC key for Startup Menu” message is displayed at the bottom of the screen.
2. Press [f10](#) to enter Computer Setup.
3. Use a pointing device or the arrow keys to select **File > Restore Defaults**.
4. Follow the on-screen instructions.
5. To save your changes and exit, click the **Save** icon in the lower-left corner of the screen, and then follow the on-screen instructions.

– or –

Use the arrow keys to select **File > Save Changes and Exit**, and then press [enter](#).

Your changes go into effect when the computer restarts.



NOTE: Your password settings and security settings are not changed when you restore the factory settings.

Updating the BIOS

Updated versions of the BIOS may be available on the HP Web site.

Most BIOS updates on the HP Web site are packaged in compressed files called *SoftPaqs*.

Some download packages contain a file named *Readme.txt*, which contains information regarding installing and troubleshooting the file.

Determining the BIOS version

To determine whether available BIOS updates contain later BIOS versions than those currently installed on the computer, you need to know the version of the system BIOS currently installed.

BIOS version information (also known as *ROM date* and *System BIOS*) can be displayed by pressing **fn+esc** (if you are already in Windows) or by using Computer Setup.

1. Start Computer Setup.
2. Use a pointing device or the arrow keys to select **File > System Information**.
3. To exit Computer Setup without saving your changes, click the **Exit** icon in the lower-left corner of the screen, and then follow the on-screen instructions.

– or –

Use the tab key and the arrow keys to select **File > Ignore Changes and Exit**, and then press **enter**.

Downloading a BIOS update

 **CAUTION:** To reduce the risk of damage to the computer or an unsuccessful installation, download and install a BIOS update only when the computer is connected to reliable external power using the AC adapter. Do not download or install a BIOS update while the computer is running on battery power, docked in an optional docking device, or connected to an optional power source. During the download and installation, follow these instructions:

Do not disconnect power from the computer by unplugging the power cord from the AC outlet.

Do not shut down the computer or initiate Sleep or Hibernation.

Do not insert, remove, connect, or disconnect any device, cable, or cord.

1. Select **Start > Help and Support > Maintain**.
2. Follow the on-screen instructions to identify your computer and access the BIOS update you want to download.
3. At the download area, follow these steps:
 - a. Identify the BIOS update that is later than the BIOS version currently installed on your computer. Make a note of the date, name, or other identifier. You may need this information to locate the update later, after it has been downloaded to your hard drive.
 - b. Follow the on-screen instructions to download your selection to the hard drive.

Make a note of the path to the location on your hard drive where the BIOS update is downloaded. You will need to access this path when you are ready to install the update.

 **NOTE:** If you connect your computer to a network, consult the network administrator before installing any software updates, especially system BIOS updates.

BIOS installation procedures vary. Follow any instructions that are displayed on the screen after the download is complete. If no instructions are displayed, follow these steps:

1. Open Windows Explorer by selecting **Start > Computer**.
2. Double-click your hard drive designation. The hard drive designation is typically Local Disk (C:).
3. Using the hard drive path you recorded earlier, open the folder on your hard drive that contains the update.
4. Double-click the file that has an .exe extension (for example, *filename.exe*).

The BIOS installation begins.

5. Complete the installation by following the on-screen instructions.

 **NOTE:** After a message on the screen reports a successful installation, you can delete the downloaded file from your hard drive.

Using System Diagnostics

System Diagnostics allows you to run diagnostic tests to determine if the computer hardware is functioning properly. The following diagnostic tests are available in System Diagnostics:

- **Start-up test**—This test analyzes the main computer components that are required to start the computer.
- **Run-in test**—This test repeats the start-up test and checks for intermittent problems that the start-up test does not detect.
- **Hard disk test**—This test analyzes the physical condition of the hard drive, and then checks all data in every sector of the hard drive. If the test detects a damaged sector, it attempts to move the data to a good sector.
- **Memory test**—This test analyzes the physical condition of the memory modules. If it reports an error, replace the memory modules immediately.
- **Battery test**—This test analyzes the condition of the battery. If the battery fails the test, contact HP Customer Support to report the issue and purchase a replacement battery.

You can also view system information and error logs in the System Diagnostics window.

To start System Diagnostics:

1. Turn on or restart the computer. While the “Press the ESC key for Startup Menu” message is displayed in the lower-left corner of the screen, press **esc**. When the Startup Menu is displayed, press **f2**.
2. Click the diagnostic test you want to run, and then follow the on-screen instructions.

 **NOTE:** If you need to stop a diagnostics test while it is running, press **esc**.

6 Specifications

Computer specifications

	Metric	U.S.
Length	25.6 cm	10.1 in
Width	37.5 cm	14.8 in
Height (front to rear)	2.9 to 3.6 cm	1.1 to 1.4 in
Weight (equipped with optical drive, 1 DIMM, hard drive, optical drive, WLAN module, 6 cell battery)	2.5 kg	5.5 lbs
Input power		
Operating voltage	19.0 V dc @ 4.74 A – 90 W or 18.5 V dc @ 3.5 A - 65 W	
Operating current	4.74 A or 3.5 A	
Temperature		
Operating (not writing to optical disc)	5°C to 35°C	41°F to 95°F
Nonoperating	-20°C to 60°C	-4°F to 140°F
Relative humidity (noncondensing)		
Operating	10% to 90%	
Nonoperating	5% to 95%	
Maximum altitude (unpressurized)		
Operating	-15 m to 3,048 m	50 ft to 10,000 ft
Nonoperating	-15 m to 12,192 m	-50 ft to 40,000 ft
Shock		
Operating	125 g, 2 ms, half-sine	
Nonoperating	200 g, 2 ms, half-sine	
Random vibration		
Operating	0.75 g zero-to-peak, 10 Hz to 500 Hz, 0.25 oct/min sweep rate	
Nonoperating	1.50 g zero-to-peak, 10 Hz to 500 Hz, 0.5 oct/min sweep rate	
NOTE: Applicable product safety standards specify thermal limits for plastic surfaces. The computer operates well within this range of temperatures.		

39.6-cm (15.6-in), HD display specifications

	Metric	U.S.
Active diagonal size	39.6-cm	15.6-in
Resolution	1366x768 (HD)	
Active area	344.232x193.536	
PPI	100	
Surface treatment	Anti-glare or BrightView	
Contrast ratio	300:1 (typical) – Anti-glare 500:1 – BrightView	
Response time	8 ms	
Brightness	200 nits (typical)	
Viewing angle	SVA	
Backlight	LED	
Luminance uniformity @ 13 points	1.4 (typ), 1.6 (max)	
Lifetime (1/2 luminance)	12,000 hours	
Color coordinate (white)	(0.313, 0.329)	
Color tolerance (White)	+/- 0.02	
Color tolerance (R, G, B)	+/- 0.03	
Color gamut	60% (typical)	

Hard drive specifications

	750-GB*	640-GB*	500-GB*	320-GB*	250-GB*
Dimensions					
Height	9.5 mm	9.5 mm	9.5 mm	9.5 mm	9.5 mm
Width	70 mm	70 mm	70 mm	70 mm	70 mm
Weight	115 g	101 g	101 g	101 g	101 g
Interface type	SATA	SATA	SATA	SATA	SATA
Transfer rate	100 MB/sec	100 MB/sec	100 MB/sec	100 MB/sec	100 MB/sec
Security	ATA security	ATA security	ATA security	ATA security	ATA security
Seek times (typical read, including setting)					
Single track	1.5 ms	2 ms	3 ms	3 ms	3 ms
Average	11 ms	12 ms	13 ms	13 ms	13 ms
Maximum	14 ms	22 ms	24 ms	24 ms	24 ms
Logical blocks	1,465,149,168	1,250,263,728	1,048,576,000	625,141,400	488,397,168
Disc rotational speed	7200 rpm	7200 rpm or 5400 rpm			
Operating temperature	5°C to 55°C (41°F to 131°F)				
*1 GB = 1 billion bytes when referring to hard drive storage capacity. Actual accessible capacity is less. Actual drive specifications may differ slightly.					
NOTE: Certain restrictions and exclusions apply. Contact technical support for details.					

Blu-ray BD-R/RE DVD±RW SuperMulti DL Drive specifications

Applicable disc	Read:	Write:	
	CD-DA, CD+(E)G, CD-MIDI, CD-TEXT, CD-ROM, CD-ROM XA, MIXED MODE CD, CD-I, CD-I Bridge (Photo-CD, Video CD), Multisession CD (Photo-CD, CD-EXTRA, Portfolio, CD-R, CD-RW), CD-R, CD-RW, DVD-ROM (DVD-5, DVD-9, DVD-10, DVD-18), DVD-R, DVD-RW, DVD+R, DVD+RW, DVD-RAM, BD-ROM, BD-R, BD-RE	CD-R, CD-RW, DVD+R, DVD+R(9), DVD+RW, DVD-R, DVD-R(9), DVD-RW, DVD-RAM, BD-R, BD-RE	
Access time	CD	DVD	BD-ROM
Random	<180 ms	<180 ms	<230 ms
Maximum Media Capacity (read)	50 GB		
Maximum Media Capacity (write)	8.5 GB		
Data transfer rate			
24X CD-ROM	3,600 KB/sec		
8X DVD	10,800 KB/sec		
2X BD-ROM	9,000 KB/sec		
16X CD-R	3,600 KB/sec		
16X CD-RW	2,400 KB/sec		
8X DVD+R	10,800 KB/sec		
6X DVD+RW	8,100 KB/sec		
8X DVD-R	10,800 KB/sec		
6X DVD-RW	8,100 KB/sec		
4X DVD+R Dual Layer	5,400 KB/sec		
4X DVD-R Dual Layer	5,400 KB/sec		
5X DVD-RAM	6,750 KB/sec		
2X BD-R	9,000 KB/sec		
2X BD-RE	9,000 KB/sec		

DVD±RW and CD-RW SuperMulti DL Combo Drive specifications

Applicable disc	Read:	Write:
	CD-DA, CD+(E)G, CD-MIDI, CD-TEXT, CD-ROM, CD-ROM XA, MIXED MODE CD, CD-I, CD-I Bridge (Photo-CD, Video CD), Multisession CD (Photo-CD, CD-EXTRA, Portfolio, CD-R, CD-RW), CD-R, CD-RW, DVD-ROM (DVD-5, DVD-9, DVD-10, DVD-18), DVD-R, DVD-RW, DVD+R, DVD+RW, DVD-RAM	CD-R and CD-RW DVD+R, DVD+RW, DVD-R, DVD-RW, DVD-RAM
Center hole diameter	1.5 cm (0.59 in)	
Disc diameter		
Standard disc	12 cm (4.72 in)	
Mini disc	8 cm (3.15 in)	
Disc thickness	1.2 mm (0.047 in)	
Track pitch	0.74 µm	
Access time	CD	DVD
Random	< 175 ms	< 230 ms
Full stroke	< 285 ms	< 335 ms
Audio output level	Line-out, 0.7 Vrms	
Cache buffer	2 MB	
Data transfer rate		
24X CD-ROM	3,600 KB/sec	
8X DVD-ROM	10,800 KB/sec	
24X CD-R	3,600 KB/sec	
16X CD-RW	2,400 KB/sec	
8X DVD+R	10,800 KB/sec	
4X DVD+RW	5,400 KB/sec	
8X DVD-R	10,800 KB/sec	
4X DVD-RW	5,400 KB/sec	
2.4X DVD+R(9)	2,700 KB/sec	
5X DVD-RAM	6,750 KB/sec	
Transfer mode	Multiword DMA Mode	
Startup time	< 15 seconds	
Stop time	< 6 seconds	

Blu-ray Disc ROM with SuperMulti DVD±R/RW DL Drive

Applicable disc	Read:	Write:	
	CD-DA, CD+(E)G, CD-MIDI, CDTEXT, CD-ROM, CD-ROM XA, MIXED MODE CD, CD-I, CD-I Bridge (Photo-CD, Video CD), Multisession CD (Photo-CD, CD-EXTRA, Portfolio, CD-R, CD-RW), CD-R, CD-RW, DVDROM (DVD-5, DVD-9, DVD-10, DVD-18), DVD-R, DVD-RW, DVD+R, DVD+RW, DVD-RAM, HD-ROM (Single Layer), HD-ROM (Dual Layer), HD DVD-R, HD DVD-R for Dual Layer, HD DVD-RW	CD-R and CD-RW DVD+R, DVD+R(9), DVD+RW, DVD-R, DVD-R(9), DVD-RW, DVD-RAM	
Access time	CD	DVD	HD
Random	170 ms	170 ms	230 ms
Cache buffer	8 MB		
Data transfer rate			
24X CD-ROM	3,600 KB/sec		
8X DVD	10,800 KB/sec		
24X CD-R	3,600 KB/sec		
16X CD-RW	2,400 KB/sec		
8X DVD+R	10,800 KB/sec		
4X DVD+RW	5,400 KB/sec		
8X DVD-R	10,800 KB/sec		
4X DVD-RW	5,400 KB/sec		
2.4X DVD+R(9)	2,700 KB/sec		
5X DVD-RAM	6,750 KB/sec		
1X BD-ROM	4,500 KB/sec		
1X BD-R read	4,500 KB/sec		
1X BD-RE read	4,500 KB/sec		
Transfer mode	Multiword DMA Mode		

DVD-ROM Drive specifications

Applicable disc	DVD-ROM (DVD-5, DVD-9, DVD-10, DVD-18, CD-ROM (Mode 1 and 2), CD Digital Audio, CD-XA ready (Mode 2, Form 1 and Form 2), CD-I (Mode 2, Form 1 and Form 2), CD-R, CD-RW, Photo CD (single and multisession), CD-Bridge	
Center hole diameter	1.5 cm (0.59 in)	
Disc diameter		
Standard disc	12 cm (4.72 in)	
Mini disc	8 cm (3.15 in)	
Disc thickness	1.2 mm (0.047 in)	
Track pitch	0.74 μ m	
Access time	CD	DVD
Random	< 100 ms	< 125 ms
Full stroke	< 175 ms	< 225 ms
Audio output level	Line-out, 0.7 Vrms	
Cache buffer	512 KB	
Data transfer rate		
CD-R (24X)	3600 KB/s (150 KB/s at 1X CD rate)	
CD-RW (10X)	1500 KB/s (150 KB/s at 1X CD rate)	
CD-ROM (24X)	3600 KB/s (150 KB/s at 1X CD rate)	
DVD (8X)	10,800 KB/s (1,352 KB/s at 1X DVD rate)	
Multiword DMA mode 2	16.6 MB/s	
Startup time	< 10 seconds	
Stop time	< 3 seconds	

Specification information in Device Manager

Device Manager allows you to view and control the hardware attached to the computer, as well as provides hardware specification information.

You can also add hardware or modify device configurations using Device Manager.



NOTE: Windows 7 and Windows Vista include the User Account Control feature to improve the security of your computer. You may be prompted for your permission or password for tasks such as installing software, running utilities, or changing Windows settings. Refer to Windows Help and Support for more information.

After you open Device Manager, drill-down to a device and double-click it to access its properties.

To access Device Manager in Windows 7:

1. Select **Start > Computer > System properties**.
2. In the left pane, click **Device Manager**.

To access Device Manager in Windows Vista:

1. Select **Start > Computer > System properties**.
2. In the left pane, click **Device Manager**.

To access Device Manager in Windows XP:

1. Select **Start > My Computer**.
2. In the left pane of the System Tasks window, select **View system information**.
3. Select **Hardware** tab > **Device Manager**.

7 Backup and recovery

Windows 7

- [Backing up your information](#)
- [Performing a system recovery](#)

To protect your information, use Windows Backup and Restore to back up individual files and folders, back up your entire hard drive (select models only), create system repair discs (select models only) by using the installed optical drive (select models only) or an optional external optical drive, or create system restore points. In case of system failure, you can use the backup files to restore the contents of your computer.

Windows Backup and Restore provides the following options:

- Creating a system repair disc (select models only) by using the installed optical drive (select models only) or an optional external optical drive
- Backing up your information
- Creating a system image (select models only)
- Scheduling automatic backups (select models only)
- Creating system restore points
- Recovering individual files
- Restoring the computer to a previous state
- Recovering information using recovery tools



NOTE: For detailed instructions, perform a search for these topics in Help and Support.

In case of system instability, HP recommends that you print the recovery procedures and save them for later use.



NOTE: Windows includes the User Account Control feature to improve the security of your computer. You may be prompted for your permission or password for tasks such as installing software, running utilities, or changing Windows settings. Refer to Help and Support for more information.

Backing up your information

Recovery after a system failure is as good as your most recent backup. You should create system repair discs (select models only) by using the installed optical drive (select models only) or an optional external optical drive, and your initial backup immediately after software setup. As you add

new software and data files, you should continue to back up your system on a regular basis to maintain a reasonably current backup. The system repair discs (select models only) are used to start up (boot) the computer and repair the operating system in case of system instability or failure. Your initial and subsequent backups allow you to restore your data and settings if a failure occurs.

You can back up your information to an optional external hard drive, a network drive, or discs.

Note the following when backing up:

- Store personal files in the Documents library, and back it up regularly.
- Back up templates that are stored in their associated programs.
- Save customized settings that appear in a window, toolbar, or menu bar by taking a screen shot of your settings. The screen shot can be a time-saver if you have to reset your preferences.
- When backing up to discs, use any of the following types of discs (purchased separately): CD-R, CD-RW, DVD+R, DVD+R DL, DVD-R, DVD-R DL, or DVD±RW. The discs you use will depend on the type of external optical drive you are using.



NOTE: DVDs and DVDs with double-layer (DL) support store more information than CDs, so using them for backup reduces the number of recovery discs required.

- When backing up to discs, number each disc before inserting it into the external drive.

To create a backup using Backup and Restore:



NOTE: Be sure that the computer is connected to AC power before you start the backup process.



NOTE: The backup process may take over an hour, depending on file size and the speed of the computer.

1. Select **Start > All Programs > Maintenance > Backup and Restore**.
2. Follow the on-screen instructions to set up your backup, create a system image (select models only), or create a system repair disc (select models only).

Performing a system recovery

In case of system failure or instability, the computer provides the following tools to recover your files:

- Windows recovery tools: You can use Windows Backup and Restore to recover information you have previously backed up. You can also use Windows Startup Repair to fix problems that might prevent Windows from starting correctly.
- **f11** recovery tools: You can use the **f11** recovery tools to recover your original hard drive image. The image includes the Windows operating system and software programs installed at the factory.



NOTE: If you are unable to boot (start up) your computer and you cannot use the system repair discs you previously created (select models only), you must purchase a Windows 7 operating system DVD to reboot the computer and repair the operating system. For additional information, refer to [Using a Windows 7 operating system DVD \(purchased separately\) on page 113](#).

Using the Windows recovery tools

To recover information you previously backed up:

1. Select **Start > All Programs > Maintenance > Backup and Restore**.
2. Follow the on-screen instructions to recover your system settings, your computer (select models only), or your files.

To recover your information using Startup Repair, follow these steps:

 **CAUTION:** Using Startup Repair completely erases hard drive contents and reformats the hard drive. All files you have created and any software installed on the computer are permanently removed. When reformatting is complete, the recovery process restores the operating system, as well as the drivers, software, and utilities from the backup used for recovery.

1. If possible, back up all personal files.
2. If possible, check for the presence of the Windows partition and the HP Recovery partition.

To check for the Windows partition, select **Start > Computer**.

To check for the HP Recovery partition, click **Start**, right-click **Computer**, click **Manage**, and then click **Disk Management**.

 **NOTE:** If the Windows partition and the HP Recovery partition are not listed, you must recover your operating system and programs using the Windows 7 operating system DVD and the *Driver Recovery* disc (both purchased separately). For additional information, refer to [Using a Windows 7 operating system DVD \(purchased separately\) on page 113](#).

3. If the Windows partition and the HP Recovery partition are listed, restart the computer, and then press **F8** before the Windows operating system loads.
4. Select **Startup Repair**.
5. Follow the on-screen instructions.

 **NOTE:** For additional information on recovering information using the Windows tools, perform a search for these topics in Help and Support.

Using f11 recovery tools

 **CAUTION:** Using **F11** completely erases hard drive contents and reformats the hard drive. All files you have created and any software installed on the computer are permanently removed. The **F11** recovery tool reinstalls the operating system and HP programs and drivers that were installed at the factory. Software not installed at the factory must be reinstalled.

To recover the original hard drive image using **F11**:

1. If possible, back up all personal files.
2. If possible, check for the presence of the HP Recovery partition: click **Start**, right-click **Computer**, click **Manage**, and then click **Disk Management**.

 **NOTE:** If the HP Recovery partition is not listed, you must recover your operating system and programs using the Windows 7 operating system DVD and the *Driver Recovery* disc (both purchased separately). For additional information, refer to [Using a Windows 7 operating system DVD \(purchased separately\) on page 113](#).

3. If the HP Recovery partition is listed, restart the computer, and then press **esc** while the “Press the ESC key for Startup Menu” message is displayed at the bottom of the screen.
4. Press **f11** while the “Press <F11> for recovery” message is displayed on the screen.
5. Follow the on-screen instructions.

Using a Windows 7 operating system DVD (purchased separately)

To order a Windows 7 operating system DVD, go to <http://www.hp.com/support>, select your country or region, and follow the on-screen instructions. You can also order the DVD by calling technical support. For contact information, refer to the *Worldwide Telephone Numbers* booklet included with the computer.

 **CAUTION:** Using a Windows 7 operating system DVD completely erases hard drive contents and reformats the hard drive. All files you have created and any software installed on the computer are permanently removed. When reformatting is complete, the recovery process helps you restore the operating system, as well as drivers, software, and utilities.

To initiate recovery using a Windows 7 operating system DVD:

 **NOTE:** This process takes several minutes.

1. If possible, back up all personal files.
2. Restart the computer, and then insert the Windows 7 operating system DVD into the optical drive before the Windows operating system loads.
3. When prompted, press any keyboard key.
4. Follow the on-screen instructions.
5. Click **Next**.
6. Select **Repair your computer**.
7. Follow the on-screen instructions.

After the repair is completed:

1. Eject the Windows 7 operating system DVD, and then insert the *Driver Recovery* disc.
2. Install the Hardware Enabling Drivers first, and then install Recommended Applications.

Windows Vista

To protect your information, use the Backup and Restore Center to back up individual files and folders, back up your entire hard drive (select models only), or create system restore points. In case of system failure, you can use the backup files to restore the contents of your computer.

The Backup and Restore Center provides the following options:

- Backing up individual files and folders
- Backing up the entire hard drive (select models only)
- Scheduling automatic backups (select models only)
- Creating system restore points
- Recovering individual files
- Restoring the computer to a previous state
- Recovering information using recovery tools

 **NOTE:** For detailed instructions, perform a search for these topics in Help and Support.

 **NOTE:** In case of system instability, HP recommends that you print the recovery procedures and save them for later use.

 **NOTE:** Windows® includes the User Account Control feature to improve the security of your computer. You may be prompted for your permission or password for tasks such as installing software, running utilities, or changing Windows settings. Refer to Help and Support for more information.

Backing up your information

Recovery after a system failure is as complete as your most current backup. You should create your initial backup immediately after software setup. As you add new software and data files, you should continue to back up your system on a regular basis to maintain a reasonably current backup.

You can back up your information to an optional external hard drive, a network drive, or discs.

Note the following when backing up:

- Store personal files in the Documents folder, and back it up regularly.
- Back up templates that are stored in their associated programs.
- Save customized settings that appear in a window, toolbar, or menu bar by taking a screen shot of your settings. The screen shot can be a time-saver if you have to reset your preferences.
- When backing up to discs, use any of the following types of discs (purchased separately): CD-R, CD-RW, DVD+R, DVD+R DL, DVD-R, DVD-R DL, or DVD±RW. The discs you use will depend on the type of optical drive installed in your computer.

 **NOTE:** DVDs and DVDs with double-layer (DL) support store more information than CDs, so using them for backup reduces the number of recovery discs required.

- When backing up to discs, number each disc before inserting it into the optical drive of the computer.

To create a backup using Backup and Restore Center:

 **NOTE:** Be sure that the computer is connected to AC power before you start the backup process.

 **NOTE:** The backup process may take over an hour, depending on file size and the speed of the computer.

1. Select **Start > All Programs > Maintenance > Backup and Restore Center**.
2. Follow the on-screen instructions to back up your entire computer (select models only) or your files.

Performing a recovery

In case of system failure or instability, the computer provides the following tools to recover your files:

- Windows recovery tools: You can use the Backup and Restore Center to recover information you have previously backed up. You can also use Windows Startup Repair to fix problems that might prevent Windows from starting correctly.
- f11 recovery tools: You can use the f11 recovery tools to recover your original hard drive image. The image includes the Windows operating system and software programs installed at the factory.

 **NOTE:** If you are unable to boot (start up) your computer, you must purchase a Windows Vista® operating system DVD to reboot the computer and repair the operating system. For additional information, refer to [Using a Windows Vista operating system DVD \(purchased separately\) on page 116](#).

Using the Windows recovery tools

To recover information you previously backed up:

1. Select **Start > All Programs > Maintenance > Backup and Restore Center**.
2. Follow the on-screen instructions to recover your entire computer (select models only) or your files.

To recover your information using Startup Repair, follow these steps:

 **CAUTION:** Using Startup Repair completely erases hard drive contents and reformats the hard drive. All files you have created and any software installed on the computer are permanently removed. When reformatting is complete, the recovery process restores the operating system, as well as the drivers, software, and utilities from the backup used for recovery.

1. If possible, back up all personal files.
2. If possible, check for the presence of the Windows partition and the HP Recovery partition. To find the partitions, select **Start > Computer**.

 **NOTE:** If the Windows partition and the HP Recovery partition have been deleted, you must recover your operating system and programs using the Windows Vista operating system DVD and the *Driver Recovery* disc (both purchased separately). For additional information, refer to [Using a Windows Vista operating system DVD \(purchased separately\) on page 116](#).

3. Restart the computer, and then press **f8** before the Windows operating system loads.

4. Select **Repair your computer**.
5. Follow the on-screen instructions.

 **NOTE:** For additional information on recovering information using the Windows tools, perform a search for these topics in Help and Support.

Using f11 recovery tools

 **CAUTION:** Using **f11** completely erases hard drive contents and reformats the hard drive. All files you have created and any software installed on the computer are permanently removed. The **f11** recovery tool reinstalls the operating system and HP programs and drivers that were installed at the factory. Software not installed at the factory must be reinstalled. Personal files must be restored from a backup.

 **NOTE:** If your computer includes a solid-state drive (SSD), you may not have a recovery partition. Recovery discs have been included for computers that do not have a partition. Use these discs to recover your operating system and software. To check for the presence of a recovery partition, select **Start > Computer**. If the partition is present, an HP Recovery drive is listed in the Hard Disk Drives section of the window.

To recover the original hard drive image using **f11**, follow these steps:

1. If possible, back up all personal files.
2. If possible, check for the presence of the HP Recovery partition. To find the partition, select **Start > Computer**.

 **NOTE:** If the HP Recovery partition has been deleted, you must recover your operating system and programs using the Windows Vista operating system DVD and the *Driver Recovery* disc (both purchased separately). For additional information, refer to [Using a Windows Vista operating system DVD \(purchased separately\) on page 116](#).

3. Turn on or restart the computer, and then press **esc** while the “Press the ESC key for Startup Menu” message is displayed at the bottom of the screen.
4. Press **f11** while the “Press <F11> for recovery” message is displayed on the screen.
5. Follow the on-screen instructions.

Using a Windows Vista operating system DVD (purchased separately)

To order a Windows Vista operating system DVD, go to <http://www.hp.com/support>, select your country or region, and follow the on-screen instructions. You can also order the DVD by calling technical support. For contact information, refer to the *Worldwide Telephone Numbers* booklet included with the computer.

 **CAUTION:** Using a Windows Vista operating system DVD completely erases hard drive contents and reformats the hard drive. All files you have created and any software installed on the computer are permanently removed. When reformatting is complete, the recovery process helps you restore the operating system, as well as drivers, software, and utilities.

To initiate recovery using a Windows Vista operating system DVD:



NOTE: This process takes several minutes.

1. If possible, back up all personal files.
2. Restart the computer, and then insert the Windows Vista operating system DVD into the optical drive before the Windows operating system loads.
3. When prompted, press any keyboard key.
4. Follow the on-screen instructions.
5. Click **Next**.
6. Select **Repair your computer**.
7. Follow the on-screen instructions.

After the repair is completed:

1. Eject the Windows Vista operating system DVD, and then insert the *Driver Recovery* disc.
2. Install the Hardware Enabling Drivers first, and then install Recommended Applications.

8 Power cord set requirements

The wide range input feature of the computer permits it to operate from any line voltage from 100 to 120 volts AC, or from 220 to 240 volts AC.

The 3-conductor power cord set included with the computer meets the requirements for use in the country or region where the equipment is purchased.

Power cord sets for use in other countries and regions must meet the requirements of the country or region where the computer is used.

Requirements for all countries and regions

The requirements listed below are applicable to all countries and regions:

- The length of the power cord set must be at least 1.5 m (5.0 ft) and no more than 2.0 m (6.5 ft).
- All power cord sets must be approved by an acceptable accredited agency responsible for evaluation in the country or region where the power cord set will be used.
- The power cord sets must have a minimum current capacity of 10 amps and a nominal voltage rating of 125 or 250 V AC, as required by the power system of each country or region.
- The appliance coupler must meet the mechanical configuration of an EN 60 320/IEC 320 Standard Sheet C13 connector for mating with the appliance inlet on the back of the computer.

Requirements for specific countries and regions

Country/region	Accredited agency	Applicable note number
Australia	EANSW	1
Austria	OVE	1
Belgium	CEBC	1
Canada	CSA	2
Denmark	DEMKO	1
Finland	FIMKO	1
France	UTE	1
Germany	VDE	1
Italy	IMQ	1
Japan	METI	3
The Netherlands	KEMA	1
Norway	NEMKO	1
The People's Republic of China	CCC	5
South Korea	EK	4
Sweden	SEMKO	1
Switzerland	SEV	1
Taiwan	BSMI	4
The United Kingdom	BSI	1
The United States	UL	2

1. The flexible cord must be Type HO5VV-F, 3-conductor, 1.0-mm² conductor size. Power cord set fittings (appliance coupler and wall plug) must bear the certification mark of the agency responsible for evaluation in the country or region where it will be used.
2. The flexible cord must be Type SPT-3 or equivalent, No. 18 AWG, 3-conductor. The wall plug must be a two-pole grounding type with a NEMA 5-15P (15 A, 125 V) or NEMA 6-15P (15 A, 250 V) configuration.
3. The appliance coupler, flexible cord, and wall plug must bear a "T" mark and registration number in accordance with the Japanese Dentori Law. The flexible cord must be Type VCT or VCTF, 3-conductor, 1.00-mm² conductor size. The wall plug must be a two-pole grounding type with a Japanese Industrial Standard C8303 (7 A, 125 V) configuration.
4. The flexible cord must be Type RVV, 3-conductor, 0.75-mm² conductor size. Power cord set fittings (appliance coupler and wall plug) must bear the certification mark of the agency responsible for evaluation in the country or region where it will be used.
5. The flexible cord must be Type VCTF, 3-conductor, 0.75-mm² conductor size. Power cord set fittings (appliance coupler and wall plug) must bear the certification mark of the agency responsible for evaluation in the country or region where it will be used.

9 Recycling

Battery

When a battery has reached the end of its useful life, do not dispose of the battery in general household waste. Follow the local laws and regulations in your area for computer battery disposal.

Display

⚠ WARNING! The backlight contains mercury. Exercise caution when removing and handling the backlight to avoid damaging this component and causing exposure to the mercury.

⚠ CAUTION: The procedures in this chapter can result in damage to display components. The only components intended for recycling purposes are the LCD panel and the backlight. When you remove these components, handle them carefully.

📄 NOTE: Materials Disposal. This HP product contains mercury in the backlight in the display assembly that might require special handling at end-of-life. Disposal of mercury may be regulated because of environmental considerations. For disposal or recycling information, contact your local authorities, or see the Electronic Industries Alliance (EIA) Web site at <http://www.eiae.org>.

This section provides disassembly instructions for the display assembly. The display assembly must be disassembled to gain access to the backlight **(1)** and the liquid crystal display (LCD) panel **(2)**.



📄 NOTE: The procedures provided in this chapter are general disassembly instructions. Specific details, such as screw sizes, quantities, and locations, and component shapes and sizes, can vary from one computer model to another.

Perform the following steps to disassemble the display assembly:

1. Remove all screw covers (1) and screws (2) that secure the display bezel to the display assembly.

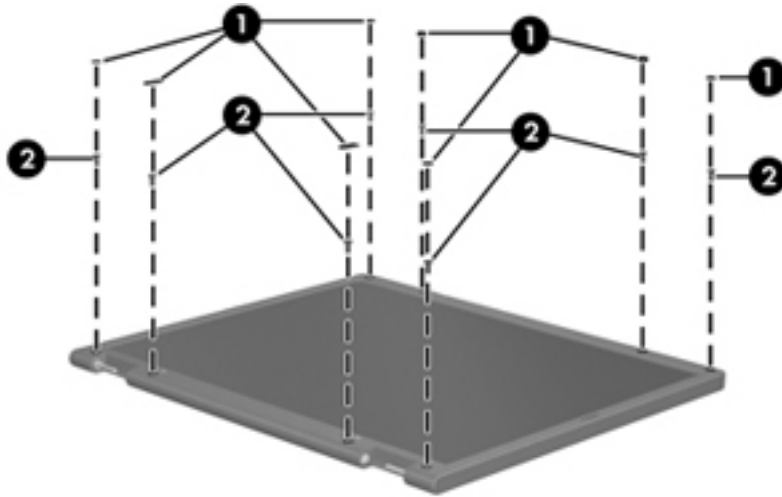

2. Lift up and out on the left and right inside edges (1) and the top and bottom inside edges (2) of the display bezel until the bezel disengages from the display assembly.
3. Remove the display bezel (3).

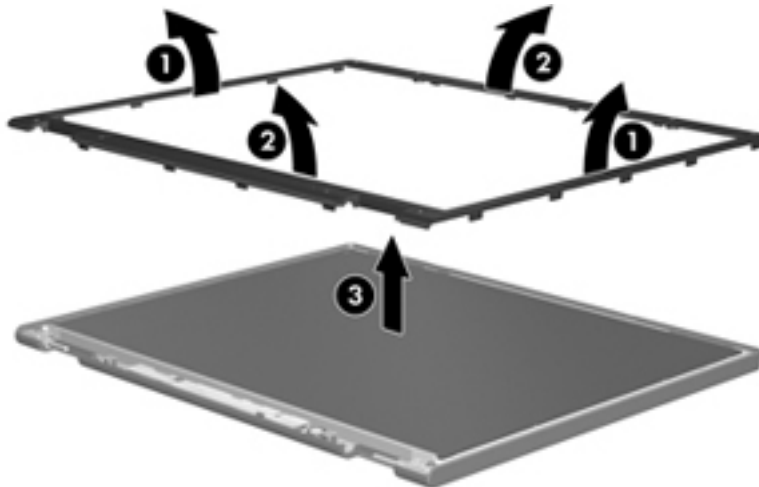

4. Disconnect all display panel cables (1) from the display inverter and remove the inverter (2).

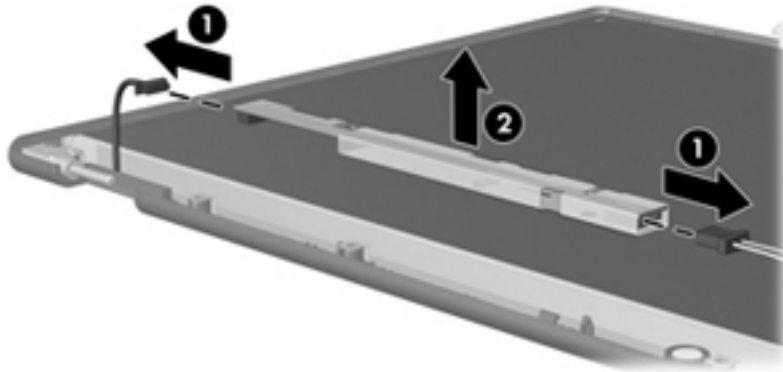

5. Remove all screws (1) that secure the display panel assembly to the display enclosure.
6. Remove the display panel assembly (2) from the display enclosure.

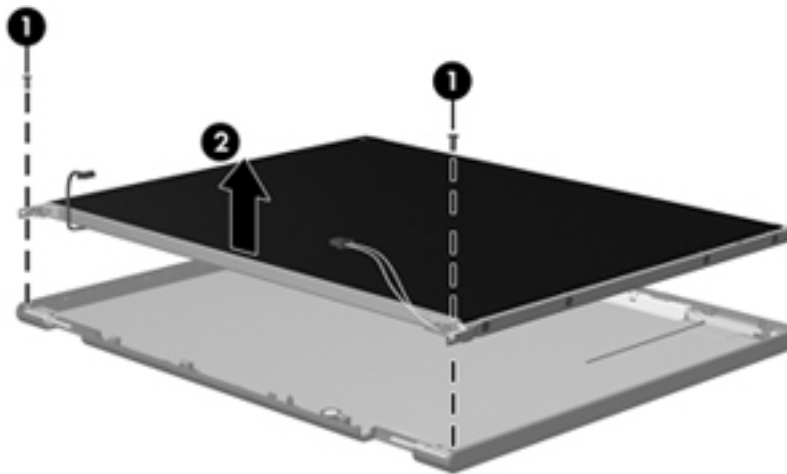

7. Position the display panel assembly upside-down.
8. Remove all screws that secure the display panel frame to the display panel.

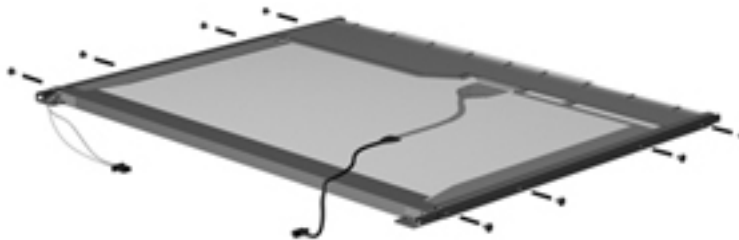

9. Use a sharp-edged tool to cut the tape (1) that secures the sides of the display panel to the display panel frame.

10. Remove the display panel frame (2) from the display panel.

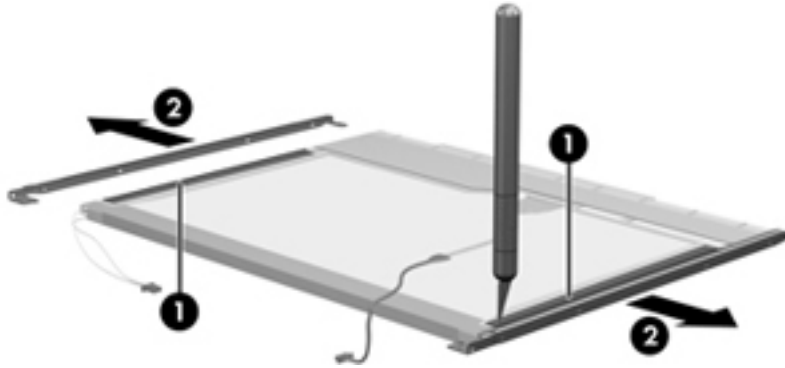

11. Remove the screws (1) that secure the backlight cover to the display panel.
12. Lift the top edge of the backlight cover (2) and swing it outward.

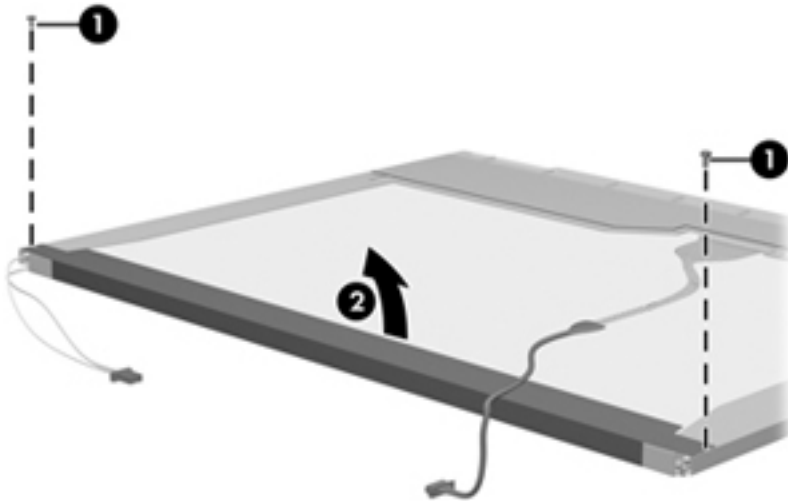

13. Remove the backlight cover.
14. Position the display panel right-side up.

15. Remove the backlight cables (1) from the clip (2) in the display panel.

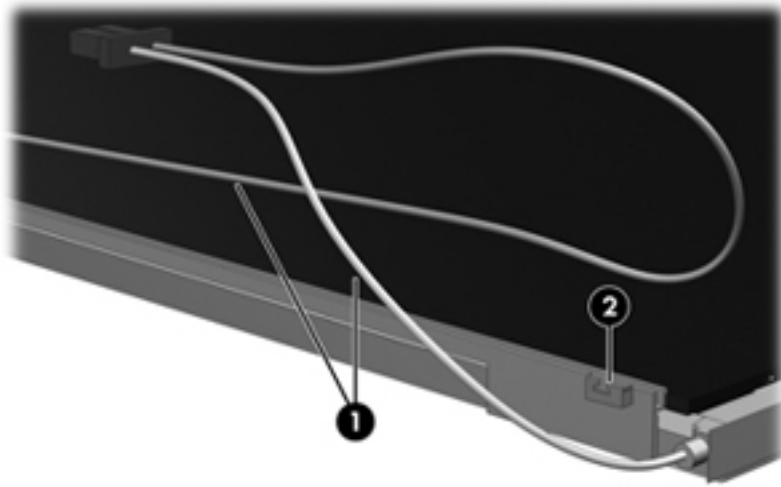

16. Position the display panel upside-down.

⚠ WARNING! The backlight contains mercury. Exercise caution when removing and handling the backlight to avoid damaging this component and causing exposure to the mercury.

17. Remove the backlight frame from the display panel.

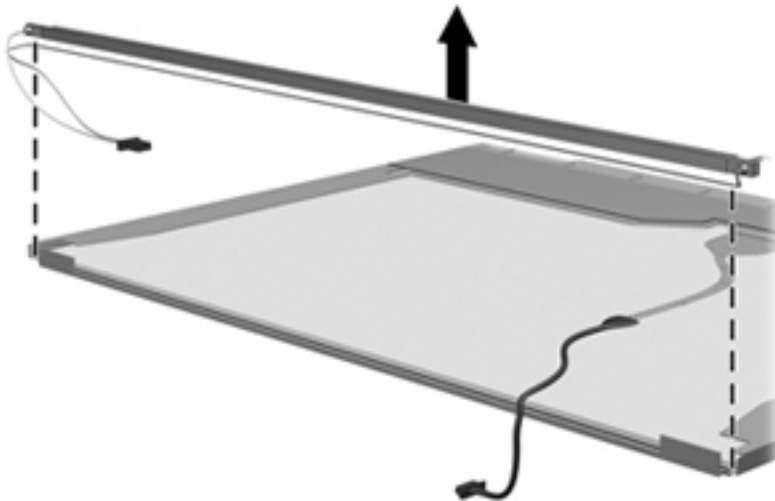

18. Remove the backlight from the backlight frame.

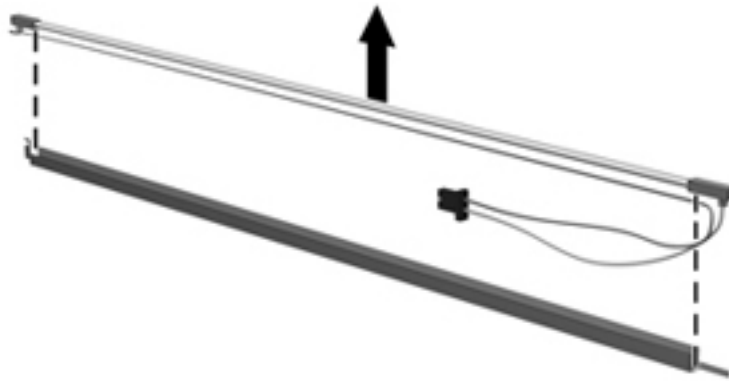

19. Disconnect the display panel cable (1) from the LCD panel.
20. Remove the screws (2) that secure the LCD panel to the display rear panel.
21. Release the LCD panel (3) from the display rear panel.
22. Release the tape (4) that secures the LCD panel to the display rear panel.

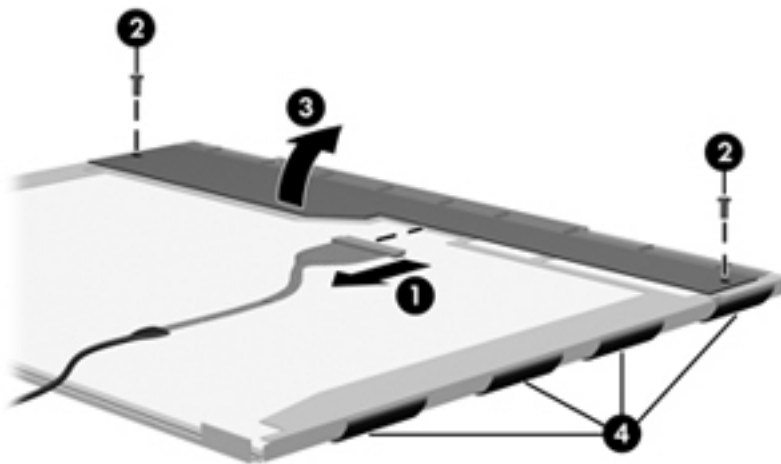

23. Remove the LCD panel.

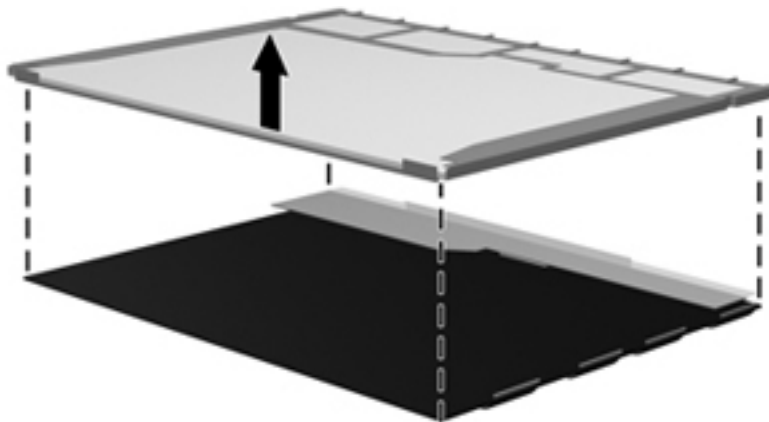

24. Recycle the LCD panel and backlight.

Index

Symbols/Numerics

6-in-1 Media Card Reader 14

A

AC adapter, spare part numbers 28, 30

access cover release latches 17

antennas

 disconnecting 50, 55

audio, product description 3

audio-in (microphone) jack 14

audio-out (headphone) jack 14

B

Backup and Restore 111

Backup and Restore Center 114, 115

base enclosure, spare part number 24, 32

battery

 removal 41

 spare part number 24, 41

battery bay 17

battery connector cable, illustrated 27

Battery light 15

battery release latches 17

BIOS

 determining version 100

 downloading an update 100

 updating 100

Blu-ray BD-R/RE DVD±RW

 SuperMulti DL Drive 105

 spare part number 24, 34, 44

Blu-ray Disc ROM with SuperMulti DVD±R/RW DL Drive

 spare part number 24, 27, 34, 44

 specifications 107

Bluetooth card

 spare part number 52

bottom door

 removal 43

 spare part number 24, 32, 43

buttons

 left TouchPad 8

 optical drive eject 16

 power 10

 QuickWeb 11

 right TouchPad 8

 TouchPad on/off 8

 wireless 11

C

Cable Kit

 contents 27

 spare part number 27, 33

cables, service considerations 36

caps lock light, identifying 9

card reader board

 removal 64

 spare part number 20, 33, 64

chipset, product description 1

components

 bottom 17

 display 7

 front 14

 left side 15

 right side 16

 top 8

Computer Setup

 navigating and selecting 98

 restoring factory settings 99

computer specifications 102

connectors, service

 considerations 36

D

diskette drive

 precautions 36

display assembly

 removal 89

 spare part numbers 89

display bezel

 removal 92

 spare part numbers 25, 32

display component recycling 120

display components, spare part numbers 25

display enclosure, spare part number 26, 32

display hinge

 removal 94

 spare part number 34

display hinge cover

 spare part numbers 25, 33

Display Hinge Kit

 spare part number 26

display panel

 product description 1

 removal 93

 spare part number 26, 34

display specifications 103

drives

 optical 16

 preventing damage 36

DVD-ROM Drive

 precautions 36

 removal 44

 spare part number 24, 27, 34, 44

 specifications 108

DVD±RW and CD-RW SuperMulti

 DL Combo Drive

 precautions 36

- removal 44
- spare part number 24, 27, 34, 44

E

- electrostatic discharge 37
- embedded numeric keypad, identifying 12
- esc key, identifying 12, 13
- Ethernet, product description 3
- ExpressCard slot insert, illustrated illustrated 26
- ExpressCard slot, identifying 15
- external media cards, product description 4
- external monitor port 15

F

- f11 recovery 112, 116
- fan
 - removal 81
 - spare part number 23, 33, 81
- fingerprint reader, identifying 11
- fn key, identifying 12, 13
- function keys
 - identifying 12, 13

G

- graphics, product description 1
- grounding equipment and methods 39

H

- hard drive
 - precautions 36
 - product description 2
 - removal 46
 - spare part numbers 24, 27, 32, 46
 - specifications 104
- hard drive bay, identifying 17
- hard drive bracket, removal 47
- Hard Drive Hardware Kit, spare part number 28, 34, 46
- hard drive light 14
- hard drive recovery 112, 116
- HDMI port, identifying 15
- heat sink
 - removal 83
 - spare part number 23, 83

- hinge
 - removal 94
 - spare part number 34

I

- integrated numeric keypad, identifying 13
- integrated webcam light, identifying 7
- internal display switch 7
- internal microphones, identifying 7

J

- jacks
 - audio-in (microphone) 14
 - audio-out (headphone) 14
 - network 15
 - RJ-11 (modem) 16
 - RJ-45 (network) 15

K

- keyboard
 - product description 4
 - removal 57
 - spare part numbers 20, 33, 57
- keypad, embedded numeric 12
- keypad, integrated numeric 13
- keys
 - esc 12, 13
 - fn 12, 13
 - function 12, 13
 - num lk 12, 13
 - Windows Applications 12, 13
 - Windows logo 12, 13

L

- legacy support, USB 98
- lid switch
 - removal 72
 - spare part number 20, 33, 72
- lights
 - Battery 15
 - caps lock 9
 - hard drive 14
 - optical drive 16
 - power 9
 - QuickWeb 9
 - TouchPad 9
 - webcam 7
 - wireless 9

M

- mass storage devices, spare part numbers 27
- Media Card Reader 14
- memory module
 - product description 2
 - removal 48
 - spare part numbers 24, 48
- memory module compartment, identifying 17
- microphone (audio-in) jack
 - product description 3
- microphone module
 - spare part number 32
- model name 1
- modem module
 - product description 3
 - removal 70
 - spare part number 20, 30, 70

N

- network jack, identifying 15
- num lk key, identifying 12, 13

O

- operating system, product description 4
- optical drive 16
 - precautions 36
 - product description 3
 - removal 44
 - spare part numbers 24, 27, 44
 - specifications 105, 106, 107, 108
- optical drive eject button 16
- optical drive light 16
- optical drive protective insert illustrated 26

P

- packing guidelines 38
- plastic parts 35
- Plastics Kit, spare part number 26, 34
- pointing device, product description 4
- ports
 - external monitor 15
 - HDMI 15
 - product description 4
 - USB 16

- power button board
 - removal 68
 - spare part number 20, 33, 68
- power button, identifying 10
- power cable
 - removal 87
 - spare part number 87
- power connector cable,
 - illustrated 27
- power connector, identifying 15
- power cord
 - set requirements 118
 - spare part numbers 28, 29
- power light 9
- power requirements, product
 - description 4
- processor
 - product description 1
 - removal 85
 - spare part numbers 20, 85
- product description
 - audio 3
 - chipset 1
 - display panel 1
 - Ethernet 3
 - external media cards 4
 - graphics 1
 - hard drives 2
 - keyboard 4
 - memory module 2
 - microphone 3
 - modem module 3
 - operating system 4
 - optical drives 3
 - pointing devices 4
 - ports 4
 - power requirements 4
 - processors 1
 - product name 1
 - security 4
 - serviceability 6
 - webcam 3
 - wireless 3
- product name 1
- Q**
- Quick Launch board
 - removal 67
 - spare part number 20, 33, 67
- QuickWeb button, identifying 11
- QuickWeb light 9
- R**
- recovery partition 112, 116
- release latches
 - access cover 17
 - battery 17
- removal/replacement
 - preliminaries 35
 - procedures 40
- restoring the hard drive 112, 116
- RJ-11 (modem) jack, identifying 16
- RJ-11 connector cable
 - illustrated 27
- RJ-11 holder, illustrated
 - illustrated 26
- RJ-11 jack cable
 - removal 75
- RJ-45 (network) jack, identifying 15
- RTC battery
 - removal 79
 - spare part number 24, 29, 79
- Rubber Kit, spare part number 34
- S**
- Screw Kit, spare part number 28, 34
- Secure Digital card insert,
 - illustrated 26
- security cable slot, identifying 15
- security, product description 4
- service considerations 35
- service tag 18, 40
- serviceability, product
 - description 6
- setup utility
 - navigating and selecting 98
 - restoring factory settings 99
- SIM slot, identifying 17
- SIM, removal 42
- slots
 - ExpressCard 15
 - security cable 15
 - SIM 17
- speaker assembly
 - removal 65
 - spare part number 20, 33, 65
- speakers, identifying 7
- specifications
 - Blu-ray BD-R/RE DVD±RW SuperMulti DL Drive 105
 - Blu-ray Disc ROM with SuperMulti DVD±R/RW DL Drive 107
 - computer 102
 - display 103
 - DVD-ROM Drive 108
 - DVD±RW and CD-RW SuperMulti DL Combo Drive 106
 - hard drive 104
 - optical drive 105, 106, 107, 108
- static-shielding materials 39
- system board
 - removal 76
 - spare part numbers 20, 34, 76
- system repair disc 110
- system restore points 110
- T**
- thermal material, replacement 84
- tools required 35
- top cover
 - removal 59
 - spare part number 20, 32, 34, 59
- TouchPad
 - buttons 8
 - identifying 8
- TouchPad light, identifying 9
- TouchPad on/off button 8
- transporting guidelines 38
- U**
- USB board
 - removal 73
 - spare part number 24, 73
- USB legacy support 98
- USB ports, identifying 16
- V**
- vents, identifying 15, 17
- W**
- webcam 8
 - identifying 8

- product description 3
- spare part number 25, 32
- webcam light, identifying 7
- Windows 7 operating system
 - DVD 113
- Windows Applications key,
 - identifying 12, 13
- Windows Backup and Restore
 - 110
- Windows logo key, identifying 12,
 - 13
- Windows Vista operating system
 - DVD 116
- wireless antennas
 - disconnecting 50, 55
 - identifying 7
- wireless button, identifying 11
- wireless compartment,
 - identifying 17
- wireless light 9
- wireless, product description 3
- WLAN antennas
 - spare part number 26, 32
- WLAN antennas, identifying 7
- WLAN/Bluetooth combo card
 - removal 52
 - spare part number 21, 29, 52
- workstation guidelines 38
- WWAN antennas
 - identifying 7
 - spare part number 26, 32
- WWAN module
 - removal 50
 - spare part number 21, 31, 50