



Compaq Presario CQ57 Notebook PC
Maintenance and Service Guide

© Copyright 2011 Hewlett-Packard
Development Company, L.P.

AMD, the AMD Arrow logo, and combinations thereof, are trademarks of Advanced Micro Devices, Inc. Bluetooth is a trademark owned by its proprietor and used by Hewlett-Packard Company under license. Intel, Celeron, and Pentium are trademarks of Intel Corporation in the U.S. and other countries. Microsoft and Windows are U.S. registered trademarks of Microsoft Corporation. SD Logo is a trademark of its proprietor.

The information contained herein is subject to change without notice. The only warranties for HP products and services are set forth in the express warranty statements accompanying such products and services. Nothing herein should be construed as constituting an additional warranty. HP shall not be liable for technical or editorial errors or omissions contained herein.

Fourth Edition: December 2011

First Edition: March 2011

Document Part Number: 638662-004

Safety warning notice

 **WARNING!** To reduce the possibility of heat-related injuries or of overheating the device, do not place the device directly on your lap or obstruct the device air vents. Use the device only on a hard, flat surface. Do not allow another hard surface, such as an adjoining optional printer, or a soft surface, such as pillows or rugs or clothing, to block airflow. Also, do not allow the AC adapter to contact the skin or a soft surface, such as pillows or rugs or clothing, during operation. The device and the AC adapter comply with the user-accessible surface temperature limits defined by the International Standard for Safety of Information Technology Equipment (IEC 60950).

Table of contents

1 Product description	1
2 External component identification	7
Display	7
Button	8
Keys	9
Lights	10
TouchPad	11
Left side	12
Right side	13
Bottom	14
3 Illustrated parts catalog	15
Service tag	15
Computer major components	17
Cable Kit	22
Display assembly subcomponents	23
Mass storage devices	24
Miscellaneous parts	25
Plastics Kit	26
Sequential part number listing	27
4 Removal and replacement procedures	33
Preliminary replacement requirements	33
Tools required	33
Service considerations	33
Plastic parts	33
Cables and connectors	33
Drive handling	34
Grounding guidelines	34
Electrostatic discharge damage	34

Packaging and transporting guidelines	36
Component replacement procedures	38
Service tag	38
Computer feet	39
Battery	40
Optical drive (select models only)	41
WLAN module	43
Memory module	45
Hard drive	46
Keyboard	49
Top cover	52
Power button board	56
TouchPad button board	57
USB board	59
Power connector cable	60
Speakers	62
Optical drive connector cable	63
Display assembly	64
System board	71
RTC battery	74
Fan/heat sink assembly	76
Processor	82
5 Setup Utility (BIOS) and System Diagnostics	84
Using Setup Utility	84
Starting Setup Utility	84
Changing the language of Setup Utility	84
Navigating and selecting in Setup Utility	85
Displaying system information	85
Restoring factory settings in Setup Utility	86
Exiting Setup Utility	86
Updating the BIOS	86
Determining the BIOS version	87
Downloading a BIOS update	87
Using System Diagnostics	88
6 Specifications	89
Computer specifications	89
15.6-inch display specifications	90
Hard drive specifications	91

7 Backup and recovery	92
Restore	92
Creating restore media	93
Performing a system restore	94
Restoring using the dedicated recovery partition (select models only)	94
Restoring using the restore media	95
Changing the computer boot order	95
Backing up and recovering your information	96
Using Windows Backup and Restore	97
Using Windows system restore points	97
When to create restore points	97
Create a system restore point	98
Restore to a previous date and time	98
8 Power cord set requirements	99
Requirements for all countries	99
Requirements for specific countries and regions	100
9 Recycling	101
Battery	101
Display	101
Index	107

1 Product description

Category	Description	Computer models equipped with an AMD processor	Computer models equipped with an Intel processor
Product Name	Compaq Presario CQ57 Notebook PC	√	√
Processors	AMD® E450 1.65-GHz processor (dual core, 18 W)	√	
	AMD E350 1.60-GHz processor (dual core, 18 W)	√	
	AMD E300 1.30-GHz processor (dual core, 18 W)	√	
	AMD C50 1.00-GHz processor (1.0-MB L2 cache, dual core, 9 W)	√	
	Intel Core i5-2450M 2.50-GHz processor (1333-MHz FSB, 3.0-MB L3 cache, dual core, 35 W; not supported on computer models equipped with Windows 7 Starter 32-bit operating system)		√
	Intel Core i5-2430M 2.40-GHz processor (1333-MHz FSB, 3.0-MB L3 cache, dual core, 35 W; not supported on computer models equipped with Windows 7 Starter 32-bit operating system)		√
	Intel Core i3-2330M 2.20-GHz processor (1333-MHz FSB, 3.0-MB L3 cache, dual core, 35 W; not supported on computer models equipped with Windows 7 Starter 32-bit operating system)		√
	Intel Core i3-370M 2.40-GHz processor (1066-MHz FSB, 3.0-MB L3 cache, dual core, 35 W; not supported on computer models equipped with Windows 7 Starter 32-bit operating system)		√
	Intel Pentium P6300 2.26-GHz processor (3.0-MB L3 cache, dual core, 35 W)		√
	Intel Pentium P6200 2.13-GHz processor (3.0-MB L3 cache, dual core, 35 W)		√
	Intel Pentium B970 2.30-GHz processor (2.0-MB L2 cache, dual core, 35 W; not supported on computer models equipped with Windows 7 Starter 32-bit operating system)		√

Category	Description	Computer models equipped with an AMD processor	Computer models equipped with an Intel processor
	Intel Pentium B960 2.20-GHz processor (2.0-MB L2 cache, dual core, TJ85, 35 W; not supported on computer models equipped with Windows 7 Starter 32-bit operating system)		√
	Intel Pentium B950 2.10-GHz processor (2.0-MB L2 cache, dual core, TJ85, 35 W; not supported on computer models equipped with Windows 7 Starter 32-bit operating system)		√
	Intel Celeron B815 1.60-GHz processor (2.0-MB L3 cache, dual core, 35 W)		√
	Intel Celeron B800 1.50-GHz processor (2.0-MB L3 cache, dual core, 35 W)		√
	Intel Celeron B710 1.50-GHz processor (1.0-MB L3 cache, single core, 35 W)		√
	Intel Celeron DC T3500 2.10-GHz processor (1.0-MB L2 cache, 800-MHz FSB)		√
	Intel Celeron DC T3300 2.00-GHz processor (1.0-MB L2 cache, 800-MHz FSB)		√
	Intel Celeron SC C925 2.30-GHz processor (1.0-MB L2 cache, 800-MHz FSB)		√
	Intel Celeron SC C900 2.20-GHz processor (1.0-MB L2 cache, 800-MHz FSB)		√
Chipset	AMD A50M fusion controller hub (FCH)	√	
	Northbridge:		√
	<ul style="list-style-type: none"> Intel HM65 Express Chipset Intel HM55 Express Chipset 		
Graphics	AMD Radeon™ HD 6320M discrete-class graphics supporting DX11	√	
	AMD Radeon™ HD 6310M discrete-class graphics supporting DX11		
	Support for high-definition DVD playback with HD-decode and DX10 and DX11 support		
	Internal graphics:		√
	<ul style="list-style-type: none"> Intel HD 3000 graphics on computer models equipped with an Intel Core i5 or i3 processor Intel HD graphics on computer models equipped with an Intel Celeron or Pentium processor 		
	Discrete graphics: AMD Radeon HD 6370M Graphics with 512-MB of discrete video memory (64M×16 DDR3 900 MHz × 4 PCs)		√

Category	Description	Computer models equipped with an AMD processor	Computer models equipped with an Intel processor
	Switchable discrete graphics (not supported on computer models equipped with Windows 7 Starter OS); AMD Radeon HD 6470M Graphics with 512-MB of discrete video memory (64M×16 DDR3 900 MHz × 4 PCs) or AMD Radeon HD 6470M Graphics with 1024-MB of discrete video memory (128M×16 DDR3 900 MHz × 4 PCs)		√
	Support for high-definition DVD playback with HD-decode ,and DX10 (UMA) and DX11 (discrete) support		√
Panel	15.6-in, high-definition (HD), light-emitting diode (LED), SVA BrightView (1366×768) display; typical brightness: 200 nits All display assemblies include 1 or 2 wireless local area network (WLAN) antenna cables Supports 16:9 ultra wide aspect ratio	√	√
Memory	2 customer-accessible/upgradable memory module slots	√	√
	Supports dual-channel memory	√	√
	Supports up to 8192 GB of system RAM	√	√
	DDR3/1333-MHz	√	√
	Supports the following configurations: <ul style="list-style-type: none"> 8192-MB total system memory (4096×2; not supported on a 32-bit operating system) 4096-MB total system memory (4096×1 or 2048×2; not supported with Windows® 7 Starter OS) 3072-MB total system memory (2048×1 + 1024×1; not supported with Windows® 7 Starter OS) 2048-MB total system memory (2048×1 or 1024×2) 1024-MB total system memory (1024×1; not supported on a 64-bit operating system) 	√	√
Hard drives	Supports 6.35-cm (2.5-in) hard drives in 9.5-mm (.37-in) and 7.0-mm (.28-in) thicknesses	√	√
	Customer-accessible	√	√
	Serial ATA	√	√

Category	Description	Computer models equipped with an AMD processor	Computer models equipped with an Intel processor
	Supports the following hard drives: <ul style="list-style-type: none"> • 500-GB, 5400-rpm • 320-GB, 5400-rpm • 250-GB, 5400-rpm 	√	√
Optical drive (select models only)	Fixed	√	√
	Serial ATA	√	√
	12.7-mm tray load	√	√
	Support for the following optical drives (select models only): <ul style="list-style-type: none"> • DVD±RW and CD-RW Super Multi Double-Layer Combo Drive with LightScribe • DVD±RW and CD-RW Drive • DVD-ROM Drive 	√	√
Audio and video	Single digital microphone	√	√
	HD audio	√	√
	Presario-branded Altec/Lansing speakers	√	√
	Supports Microsoft Premium requirements	√	√
	HP VGA webcam (select models only, fixed, no tilt with activity LED, 640×480 by 24 frames per second)	√	√
Ethernet	Integrated 10/100 network interface card (NIC)	√	√
Wireless	Integrated wireless local area network (WLAN) options by way of wireless module	√	√
	One or two WLAN antennas built into display assembly	√	√

Category	Description	Computer models equipped with an AMD processor	Computer models equipped with an Intel processor
	Support for the following WLAN formats: <ul style="list-style-type: none"> Atheros 9485GN 802.11b/g/n 1×1 WiFi and 3012 Bluetooth 4.0 Combo Adapter Atheros AR9002WB-1NGB 802.11b/g/n 1×1 WiFi and Bluetooth 2.1+EDR Combo Adapter (BT3.0+HS ready) Broadcom 4313GN 802.11b/g/n 1×1 WiFi and 20702 Bluetooth 4.0 Combo Adapter Ralink 5390GN 802.11b/g/n 1×1 WiFi Adapter Realtek 8188BC8 802.11a/b/g/n 2×2 WiFi and Bluetooth 3.0+HS Combo Adapter Realtek 8188GN 802.11b/g/n 1×1 WiFi Adapter 	√	√
External media card	HP Multi-Format Digital Media Reader supports the following digital card formats: <ul style="list-style-type: none"> MultiMediaCard (MMC) Secure Digital (SD) Memory Card Secure Digital High Capacity (SDHC) Memory Card 	√	√
Ports	<ul style="list-style-type: none"> 3-pin AC power Audio-in (mono microphone) Audio-out (stereo headphone) HDMI version 1.4 supporting 1920 ×1200 @ 60Hz RJ-45 (Ethernet, includes link and activity lights) USB 2.0 (3 ports) VGA (Dsub 15 pin) supporting 2048×1536 external resolution @ 85 Hz, 1920 ×1200 external resolution @ 60Hz, hot plug and unplug and auto-detection for correct output to wide-aspect vs. standard aspect video 	√	√
Keyboard/pointing devices	Full-size 14-in, textured, pocket, keyboard with full numeric keypad	√	√
	TouchPad with multi-touch gestures, 2-finger scrolling, and pinch-zoom enabled	√	√
	Taps enabled by default	√	√

Category	Description	Computer models equipped with an AMD processor	Computer models equipped with an Intel processor
Power requirements	65-W RC V HP Smart AC adapter with localized cable plug support (3-wire plug with ground pin, supports 3-pin DC connector)	√	
	90-W PFC RC V EM HP Smart AC adapter with localized cable plug support (3-wire plug with ground pin, supports 3-pin DC connector)		√
	90-W PFC RC V HP Smart AC adapter with localized cable plug support (3-wire plug with ground pin, supports 3-pin DC connector)		
	65-W RC V EM HP Smart AC adapter with localized cable plug support (3-wire plug with ground pin, supports 3-pin DC connector)		
	Support for the following batteries:	√	√
	<ul style="list-style-type: none"> 6-cell, 55-Whr, 2.55-Ah Li-ion battery 6-cell, 47-Whr, 2.20-Ah Li-ion battery 		
Security	Security cable slot	√	√
Operating system	Preinstalled:	√	√
	<ul style="list-style-type: none"> Windows 7 Home Basic (64- and 32-bit) Windows 7 Home Premium (64-bit) Windows 7 Professional (64-bit) Windows 7 Starter (32-bit, not supported on computer models equipped with a 500-GB hard drive) FreeDOS 		
Serviceability	End-user replaceable parts:	√	√
	<ul style="list-style-type: none"> AC adapter Battery Hard drive Memory modules (2) Optical drive WLAN module 		

2 External component identification

Display

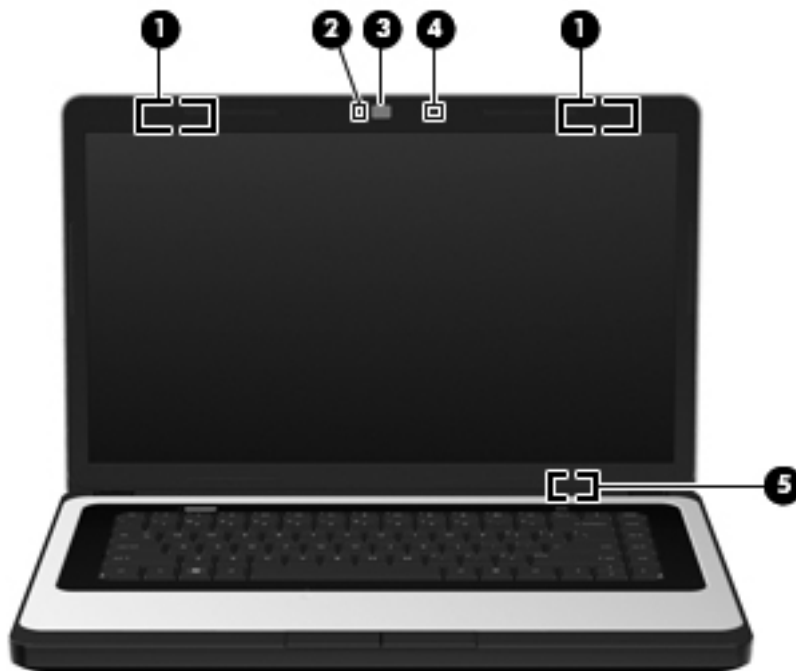

Item	Component	Description
(1)	WLAN antennas (2)*	Send and receive wireless signals to communicate with WLANs. NOTE: Select computer models only have one WLAN antenna.
(2)	Webcam light	On: The webcam is in use.
(3)	Webcam	Records video and captures still photographs. To use the webcam, select Start > All Programs > HP > HP MediaSmart > HP MediaSmart Webcam .
(4)	Internal microphone	Records sound.

Item	Component	Description
(5)	Internal display switch	Turns off the display and initiates Sleep if the display is closed while the power is on. NOTE: The internal display switch is not visible from the outside of the computer.

*The antennas are not visible from the outside of the computer. For optimal transmission, keep the areas immediately around the antennas free from obstructions. To see wireless regulatory notices, refer to the section of the *Regulatory, Safety, and Environmental Notices* that applies to your country or region. These notices are located in Help and Support.

Button



Component	Description
Power button	<ul style="list-style-type: none"> • When the computer is off, press the button to turn on the computer. • When the computer is on, press the button briefly to initiate Sleep. • When the computer is in the Sleep state, press the button briefly to exit Sleep. • When the computer is in Hibernation, press the button briefly to exit Hibernation. <p>If the computer has stopped responding and Windows shutdown procedures are ineffective, press and hold the power button for at least 5 seconds to turn off the computer.</p> <p>To learn more about your power settings, select Start > Control Panel > System and Security > Power Options, or refer to the <i>HP Notebook Reference Guide</i>.</p>

Keys

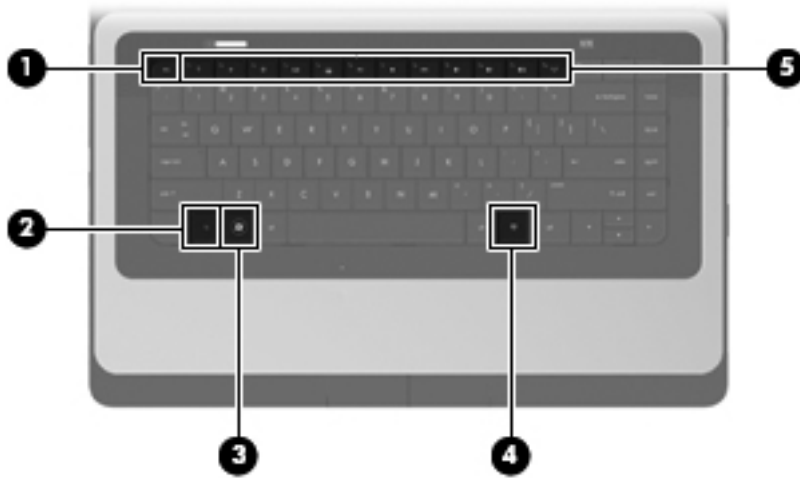

Item	Component	Description
(1)	esc key	Displays system information when pressed in combination with the <code>fn</code> key.
(2)	fn key	Displays system information when pressed in combination with the <code>esc</code> key.
(3)	Windows logo key	Displays the Windows Start menu.
(4)	Windows applications key	Displays a shortcut menu for items beneath the pointer.
(5)	Action keys	Execute frequently used system functions.

Lights

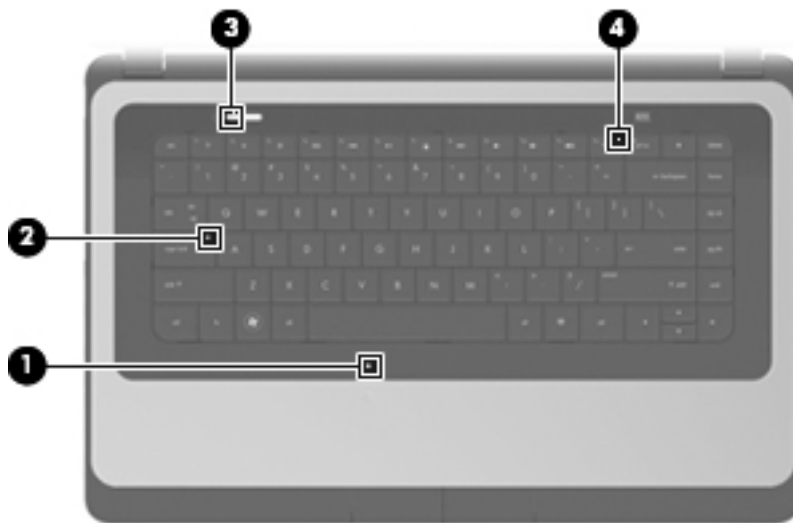

Item	Component	Description
(1)	TouchPad light	<ul style="list-style-type: none">• Amber: The TouchPad is off.• Off: The TouchPad is on.
(2)	Caps lock light	<ul style="list-style-type: none">• White: Caps lock is on.• Off: Caps lock is off.
(3)	Power light	<ul style="list-style-type: none">• White: The computer is on.• Blinking white: The computer is in the Sleep state.• Off: The computer is off.
(4)	Wireless light	<ul style="list-style-type: none">• White: An integrated wireless device, such as a WLAN device and/or a Bluetooth device, is on.• Amber: All wireless devices are off.

TouchPad

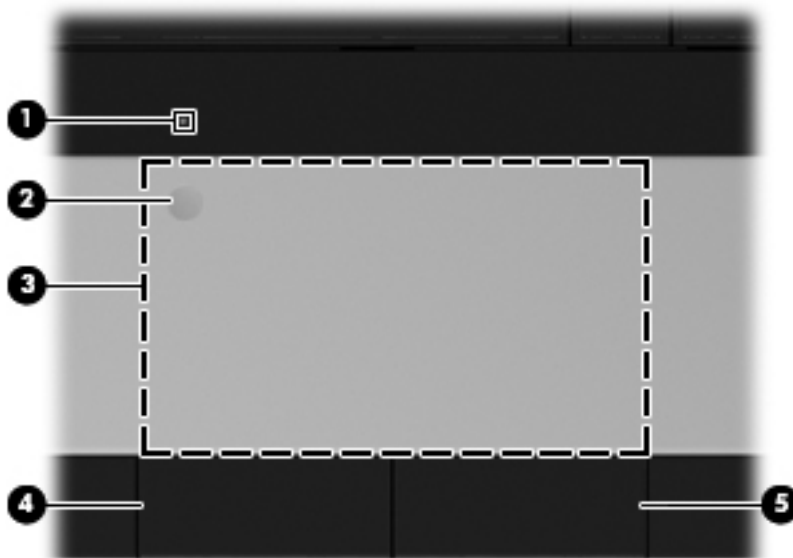

Item	Component	Description
(1)	TouchPad light	<ul style="list-style-type: none">• Amber: The TouchPad is off.• On: The TouchPad is on.
(2)	TouchPad on/off button	Turns the TouchPad on and off. Quickly double-tap the TouchPad on/off button to turn the TouchPad on and off.
(3)	TouchPad zone	Moves the pointer and selects or activates items on the screen.
(4)	Left TouchPad button	Functions like the left button on an external mouse.
(5)	Right TouchPad button	Functions like the right button on an external mouse.

Left side



Item	Component	Description
(1)	External monitor port	Connects an external VGA monitor or projector.
(2)	Vents (2)	Enable airflow to cool internal components. NOTE: The computer fan starts up automatically to cool internal components and prevent overheating. It is normal for the internal fan to cycle on and off during routine operation.
(3)	RJ-45 (network) jack	Connects a network cable.
(4)	HDMI port (select models only)	Connects an optional video or audio device, such as a high-definition television, or any compatible digital or audio component.
(5)	USB port	Connect optional USB devices.
(6)	Audio-in (microphone) jack	Connects an optional computer headset microphone, stereo array microphone, or monaural microphone.
(7)	Audio-out (headphone) jack	Produce sound when connected to optional powered stereo speakers, headphones, ear buds, a headset, or television audio. WARNING! To reduce the risk of personal injury, adjust the volume before putting on headphones, earbuds, or a headset. For additional safety information, refer to the <i>Regulatory, Safety, and Environmental Notices</i> . When a device is connected to the jack, the computer speakers are disabled.
(8)	Digital Media Slot	Supports the following digital card formats: <ul style="list-style-type: none"> • MultiMediaCard • Secure Digital (SD) Memory Card • Secure Digital High Capacity (SDHC) Memory Card
(9)	Drive light	Blinking white: The hard drive is being accessed.
(10)	Power light	<ul style="list-style-type: none"> • White: The computer is on. • Blinking white: The computer is in the Sleep state. • Off: The computer is off.

Right side



Item	Component	Description
(1)	Optical drive (select models only)	Reads and writes to an optical disc.
(2)	Optical drive light	<ul style="list-style-type: none">• On: The optical drive is in use.• Off: The optical drive is idle.
(3)	USB ports (2)	Connect optional USB devices.
(4)	Power connector	Connects an AC adapter.
(5)	AC adapter light	<ul style="list-style-type: none">• White: The computer is connected to external power and the battery is fully charged.• Amber: A battery is charging.
(6)	Security cable slot	Attaches an optional security cable to the computer. NOTE: The security cable is designed to act as a deterrent, but it may not prevent the computer from being mishandled or stolen.

Bottom

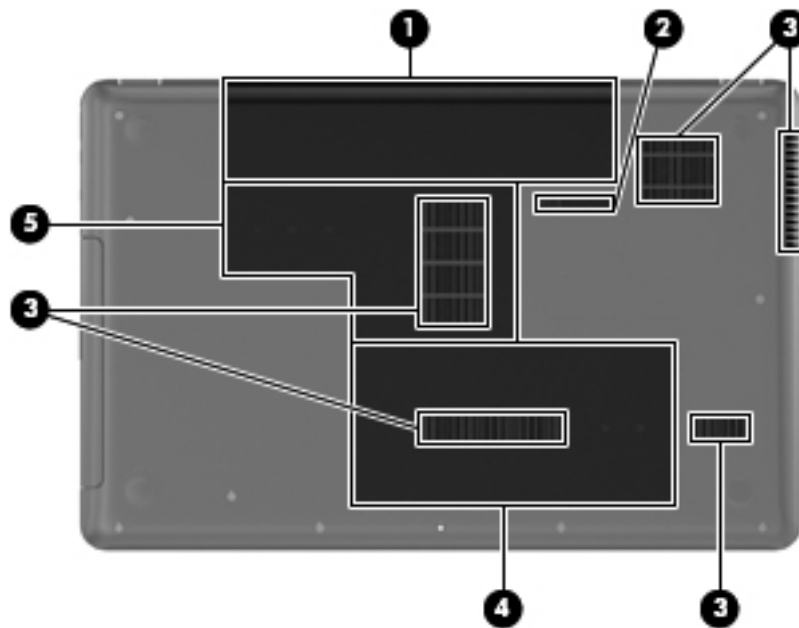

Item	Component	Description
(1)	Battery bay	Holds the battery.
(2)	Battery release latch	Releases the battery from the battery bay.
(3)	Vents (5)	Enable airflow to cool internal components. NOTE: The computer fan starts up automatically to cool internal components and prevent overheating. It is normal for the internal fan to cycle on and off during routine operation.
(4)	Hard drive bay	Holds the hard drive.
(5)	Memory module compartment	Contains the memory module slots.

3 Illustrated parts catalog

Service tag

When ordering parts or requesting information, provide the computer serial number and model description provided on the service tag.

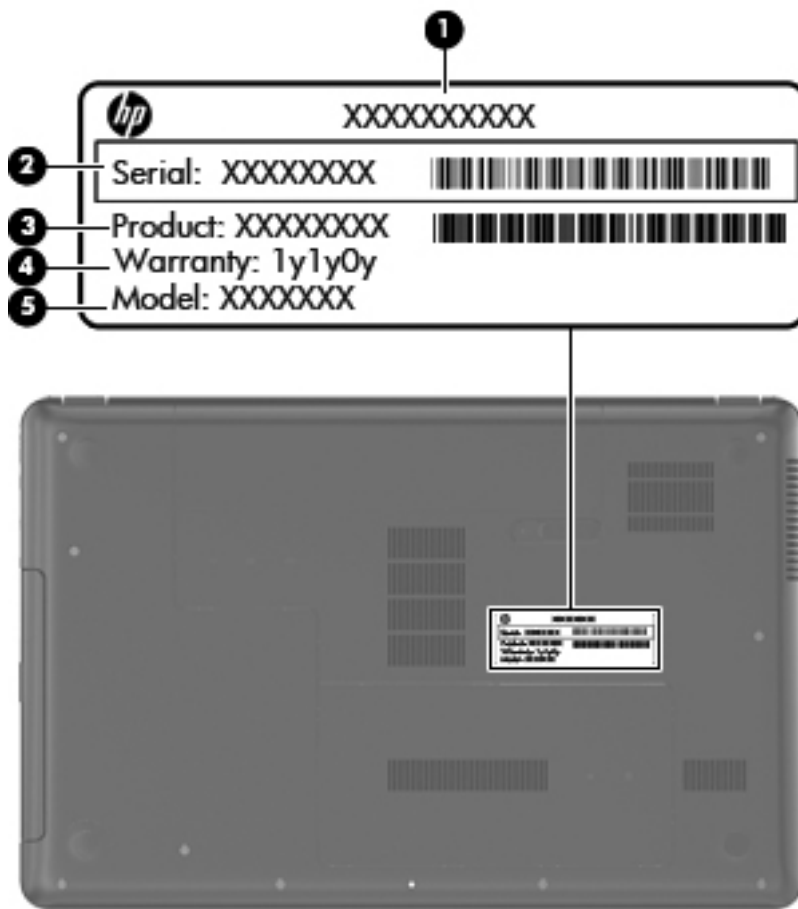

Item	Component	Description
(1)	Product name	This is the product name affixed to the front of the computer.
(2)	Serial number (s/n)	This is an alphanumeric identifier that is unique to each product.

Item	Component	Description
(3)	Part number/Product number (p/n)	This number provides specific information about the product's hardware components. The part number helps a service technician determine what components and parts are needed.
(4)	Warranty period	This number describes the duration of the warranty period for the computer.
(5)	Model description	This is the alphanumeric identifier used to locate documents, drivers, and support for the computer.

Computer major components

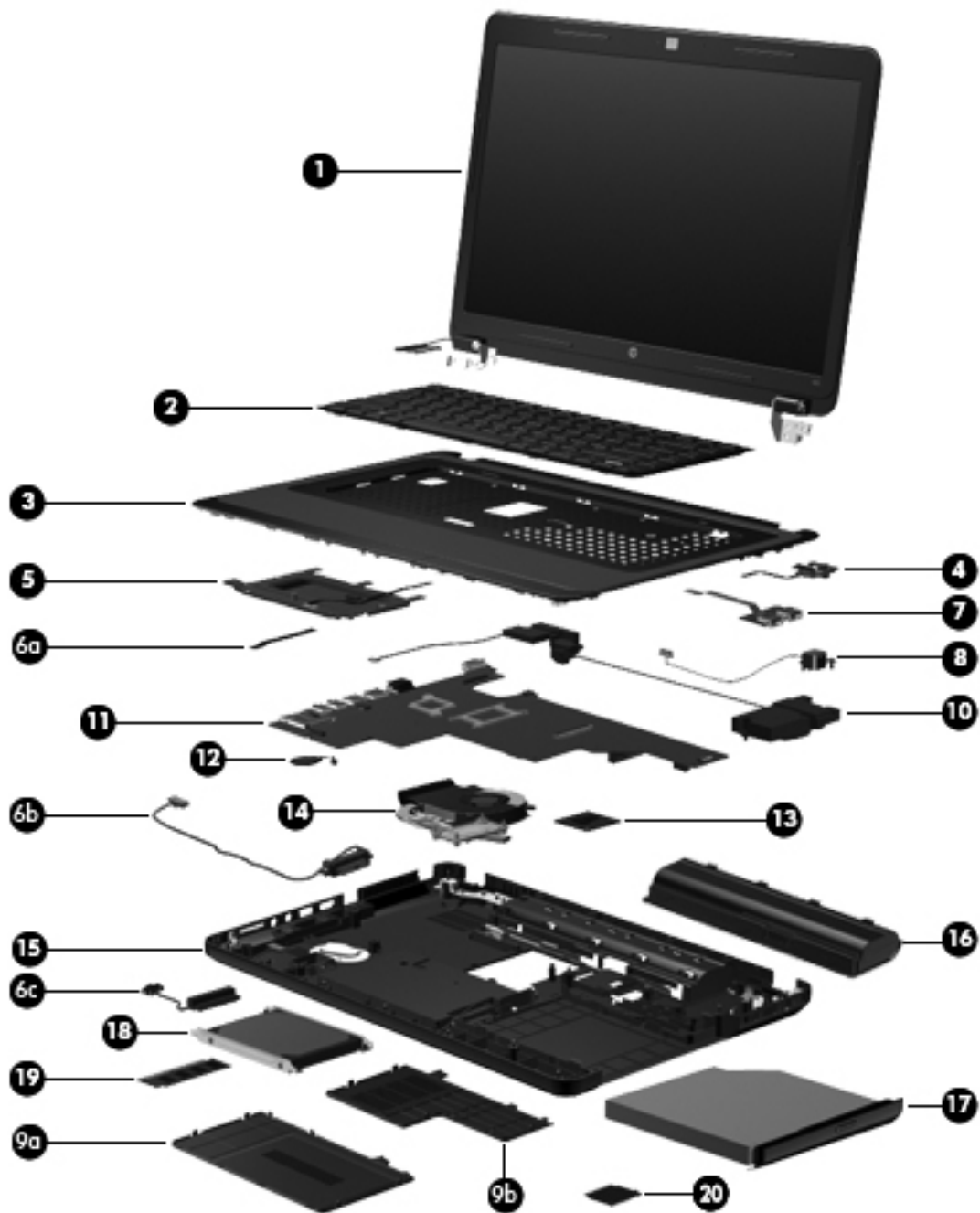

Item	Component	Spare part number
(1)	15.6-in, high definition (HD), light-emitting diode (LED), BrightView display assembly (includes microphone and wireless antenna transceivers and cables):	
	Equipped with webcam	645095-001
	Not equipped with webcam	645094-001
NOTE: For more display assembly spare part information, see Display assembly subcomponents on page 23 .		

Item	Component	Spare part number
(2)	Keyboard (includes keyboard cable):	
	For use with all computer models:	
	For use in Belgium	646125-A41
	For use in Bulgaria	646125-261
	For use in Canada	646125-121
	For use in the Czech Republic	646125-221
	For use in Denmark, Finland, and Norway	646125-DH1
	For use in France	646125-051
	For use in Germany	646125-041
	For use in Greece	646125-DJ1
	For use in Hungary	646125-211
	For use in Israel	646125-BB1
	For use in Italy	646125-061
	For use in Latin America	646125-161
	For use in the Netherlands	646125-B31
	For use in Portugal	646125-131
	For use in Russia	646125-251
	For use in Saudi Arabia	646125-171
	For use in Slovenia	646125-BA1
	For use in Spain	646125-071
	For use in Switzerland	646125-BG1
	For use in Turkey	646125-141
	For use in the United Kingdom	646125-031
	For use in the United States	646125-001
	For use only with computer models equipped with an Intel processor:	
	For use in India	646125-D61
	For use in Japan	646125-291
	For use in South Korea	646125-AD1
	For use in Taiwan	646125-AB1
(3)	Top cover (includes TouchPad and TouchPad cable)	646136-001
(4)	Power button board (includes cable)	646129-001
(5)	TouchPad button board (includes bracket and cable)	646130-001
	Cable Kit , includes:	646119-001
(6a)	TouchPad cable	

Item	Component	Spare part number
(6b)	Optical drive connector cable	
(6c)	Hard drive connector cable	
	NOTE: See Cable Kit on page 22 for more Cable Kit spare part information.	
(7)	USB board (includes cable)	646128-001
(8)	Power connector cable	646121-001
	Plastics Kit , includes:	646131-001
(9a)	Hard drive compartment cover (includes one captive screw, secured by a C-clip)	
(9b)	Memory module/wireless module compartment cover (includes one captive screw, secured by a C-clip)	
	NOTE: See Plastics Kit on page 26 for more Plastics Kit spare part information.	
(10)	Speaker Kit (includes left and right speakers and cable)	647315-001
(11)	System board (includes replacement thermal material):	
	For use only with computer models equipped with an AMD E450 1.65-GHz processor (dual core, 18 W) and a graphics subsystem with UMA video memory	657323-001
	For use only with computer models equipped with an AMD E350 1.60-GHz processor (dual core, 18 W) and a graphics subsystem with UMA video memory (for use only with computer models in the United States)	647320-001
	For use only with computer models equipped with an AMD E300 1.30-GHz processor (dual core, 18 W) and a graphics subsystem with UMA video memory	657324-001
	For use only with computer models equipped with an AMD E240 1.50-GHz processor (dual core, 18 W) and a graphics subsystem with UMA video memory (for use only with computer models in the United States)	647322-001
	For use only with computer models equipped with an AMD C50 1.00-GHz processor (1.0-MB L2 cache, dual core, 9 W) and a graphics subsystem with UMA video memory (for use only with computer models in the United States)	653985-001
	For use only with computer models equipped with an Intel Core i5 or i3 processor and a graphics subsystem with discrete video memory	646179-001
	For use only with computer models equipped with an Intel Core i5 or i3 processor and a graphics subsystem with UMA video memory	646177-001
	For use only with computer models equipped with an Intel Pentium processor and a graphics subsystem with discrete video memory	646176-001
	For use only with computer models equipped with an Intel Pentium processor and a graphics subsystem with UMA video memory	646175-001
	For use only with computer models equipped with an Intel Celeron processor	646174-001
	Thermal Material Kit (includes replacement thermal paste and pads):	
	For use only with computer models equipped with an AMD processor	650277-001
	For use only with computer models equipped with an Intel processor	646135-001
(12)	RTC battery (includes cable and double-sided tape)	646132-001
(13)	Processor (includes replacement thermal material):	
	Intel Core i5-2450M 2.50-GHz processor (1333-MHz FSB, 3.0-MB L3 cache, dual core, 35 W; not supported on computer models equipped with Windows 7 Starter 32-bit operating system)	676359-001

Item	Component	Spare part number
	Intel Core i5-2430M 2.40-GHz processor (1333-MHz FSB, 3.0-MB L3 cache, dual core, 35 W; not supported on computer models equipped with Windows 7 Starter 32-bit operating system)	653341-001
	Intel Core i3-2350M 2.30-GHz processor (1333-MHz FSB, 3.0-MB L3 cache, dual core, 35 W; not supported on computer models equipped with Windows 7 Starter 32-bit operating system)	653340-001
	Intel Core i3-2330M 2.20-GHz processor (1333-MHz FSB, 3.0-MB L3 cache, dual core, 35 W; not supported on computer models equipped with Windows 7 Starter 32-bit operating system)	653339-001
	Intel Core i3-380M 2.53-GHz processor (1066-MHz FSB, 3.0-MB L3 cache, dual core, 35 W; not supported on computer models equipped with Windows 7 Starter 32-bit operating system)	625823-001
	Intel Core i3-370M 2.40-GHz processor (1066-MHz FSB, 3.0-MB L3 cache, dual core, 35 W; not supported on computer models equipped with Windows 7 Starter 32-bit operating system)	613584-001
	Intel Pentium P6300 2.26-GHz processor (3.0-MB L3 cache, dual core, 35 W)	635500-001
	Intel Pentium P6200 2.13-GHz processor (3.0-MB L3 cache, dual core, 35 W)	625831-001
	Intel Pentium B970 2.30-GHz processor (2.0-MB L2 cache, dual core, TJ85, 35 W; not supported on computer models equipped with Windows 7 Starter 32-bit operating system)	676785-001
	Intel Pentium B960 2.20-GHz processor (2.0-MB L2 cache, dual core, TJ85, 35 W; not supported on computer models equipped with Windows 7 Starter 32-bit operating system)	664662-001
	Intel Pentium B950 2.10-GHz processor (2.0-MB L2 cache, dual core, TJ85, 35 W; not supported on computer models equipped with Windows 7 Starter 32-bit operating system)	653338-001
	Intel Pentium B940 2.00-GHz processor (2.0-MB L2 cache, dual core, 35 W; not supported on computer models equipped with Windows 7 Starter 32-bit operating system)	653337-001
	Intel Celeron B815 1.60-GHz processor (2.0-MB L3 cache, dual core, 35 W)	677153-001
	Intel Celeron B800 1.50-GHz processor (2.0-MB L3 cache, dual core, 35 W)	664661-001
	Intel Celeron B710 1.50-GHz processor (1.0-MB L3 cache, single core, 35 W)	664660-001
	Intel Celeron DC T3500 2.10-GHz processor (1.0-MB L2 cache, 800-MHz FSB)	625830-001
	Intel Celeron DC T3300 2.00-GHz processor (1.0-MB L2 cache, 800-MHz FSB)	592399-001
	Intel Celeron SC C925 2.30-GHz processor (1.0-MB L2 cache, 800-MHz FSB)	636636-001
	Intel Celeron SC C900 2.20-GHz processor (1.0-MB L2 cache, 800-MHz FSB)	534419-001
(14)	Fan/heat sink assembly (includes replacement thermal material):	
	For use only with computer models equipped with an AMD processor	647316-001
	For use only with computer models equipped with an Intel Core i5 or i3 processor and a graphics subsystem with discrete video memory	646182-001
	For use only with computer models equipped with an Intel Core i5 or i3 processor and a graphics subsystem with UMA video memory	646183-001
	For use only with computer models equipped with an Intel Pentium processor and a graphics subsystem with discrete video memory	646180-001

Item	Component	Spare part number
	For use only with computer models equipped with an Intel Pentium processor and a graphics subsystem with UMA video memory	646181-001
	For use only with computer models equipped with an Intel Celeron processor and a graphics subsystem with UMA video memory	646184-001
(15)	Base enclosure (includes battery release latch, heat sink, replacement thermal material, and 4 rubber feet)	646114-001
(16)	Battery:	
	6-cell, 55-Whr, 2.55-Ah Li-ion battery	593554-001
	6-cell, 47-Whr, 2.20-Ah Li-ion battery	593553-001
(17)	Optical drive (select models only; includes bezel and bracket):	
	DVD±RW and CD-RW Super Multi Double-Layer Combo Drive with LightScribe	646126-001
	DVD±RW and CD-RW Drive	659879-001
	DVD-ROM Drive	659638-001
	Optical drive slot space saver	659632-001
(18)	Hard drive (2.5-in, 7.0-mm, SATA; does not include hard drive connector cable, hard drive bracket, or screws):	
	640-GB, 5400-rpm	603785-001
	500-GB, 5400-rpm	634932-001
	320-GB, 5400-rpm	622643-001
	250-GB, 5400-rpm	622641-001
	Hard Drive Hardware Kit (not illustrated, includes hard drive bracket and screws)	646122-001
(19)	Memory modules (2, PC3, 10600, 1333-MHz):	
	4 GB	621569-001
	2 GB	621565-001
	1 GB	639738-001
(20)	WLAN module:	
	Atheros 9485GN 802.11b/g/n 1×1 WiFi and 3012 Bluetooth 4.0 Combo Adapter	655795-001
	Atheros AR9002WB-1NGB 802.11b/g/n 1×1 WiFi and Bluetooth 2.1+EDR Combo Adapter (BT3.0+HS ready)	593127-001
	Broadcom 4313GN 802.11b/g/n 1×1 WiFi and 20702 Bluetooth 4.0 Combo Adapter	657325-001
	Ralink 5390GN 802.11b/g/n 1×1 WiFi Adapter	630703-001
	Realtek 8188BC8 802.11a/b/g/n 2×2 WiFi and Bluetooth 3.0+HS Combo Adapter	602993-001
	Realtek 8188GN 802.11b/g/n 1×1 WiFi Adapter	640926-001

Cable Kit

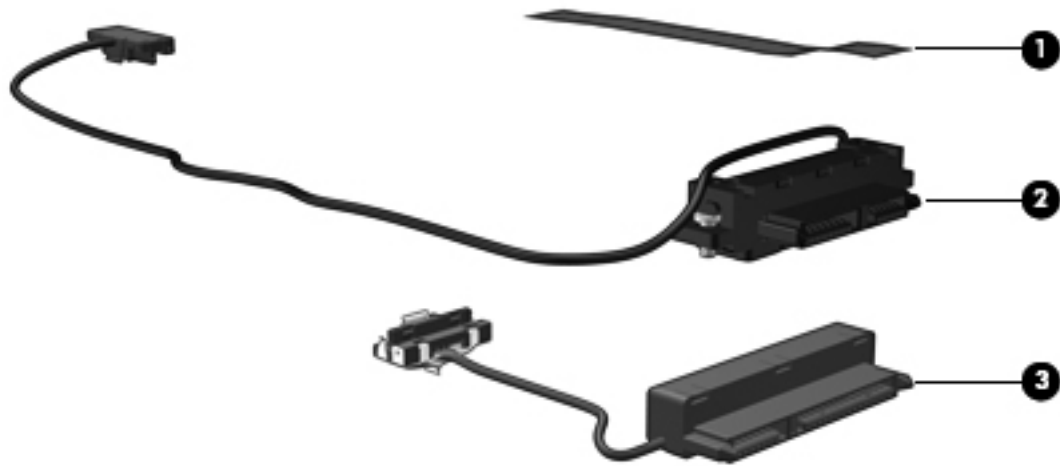

Item	Component	Spare part number
	Cable Kit, includes:	646119-001
(1)	TouchPad cable	
(2)	Optical drive connector cable	
(3)	Hard drive connector cable	

Display assembly subcomponents

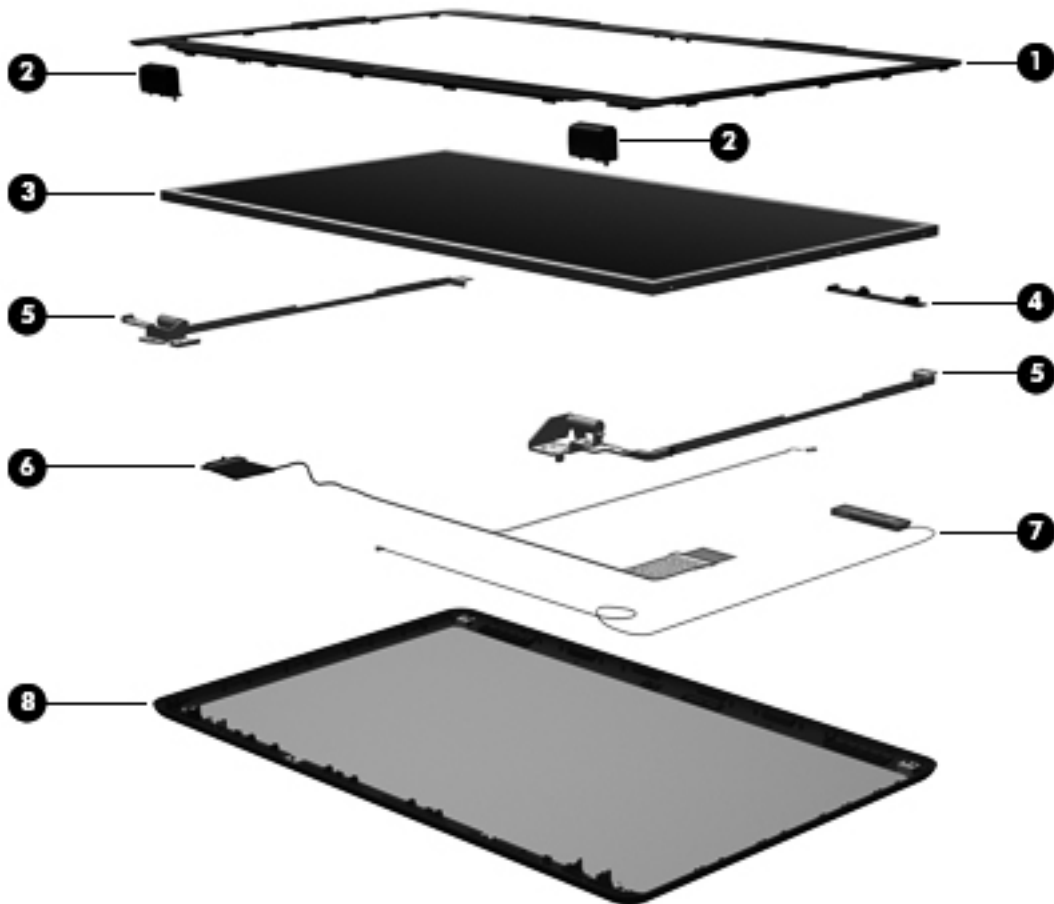

Item	Component	Spare part number
(1)	Display bezel:	
	For use with computer models equipped with a webcam and a microphone	646117-001
	For use with computer models equipped only with a microphone	646118-001
(2)	Display hinge covers (2)	646124-001
(3)	15.6-in, HD, LED, BrightView display panel	645096-001
(4)	Webcam/microphone module	646138-001
	Microphone module	645980-001
(5)	Display Hinge Kit (includes left and right display hinges and brackets)	646123-001
(6)	Display Cable Kit (includes display panel cable and webcam/microphone module cable)	646120-001
(7)	Antenna Kit (includes left and right wireless antenna cables and transceivers)	646111-001
(8)	Display enclosure	646113-001
	Display Screw Kit (not illustrated, includes Mylar screw covers and screws)	646134-001

Mass storage devices

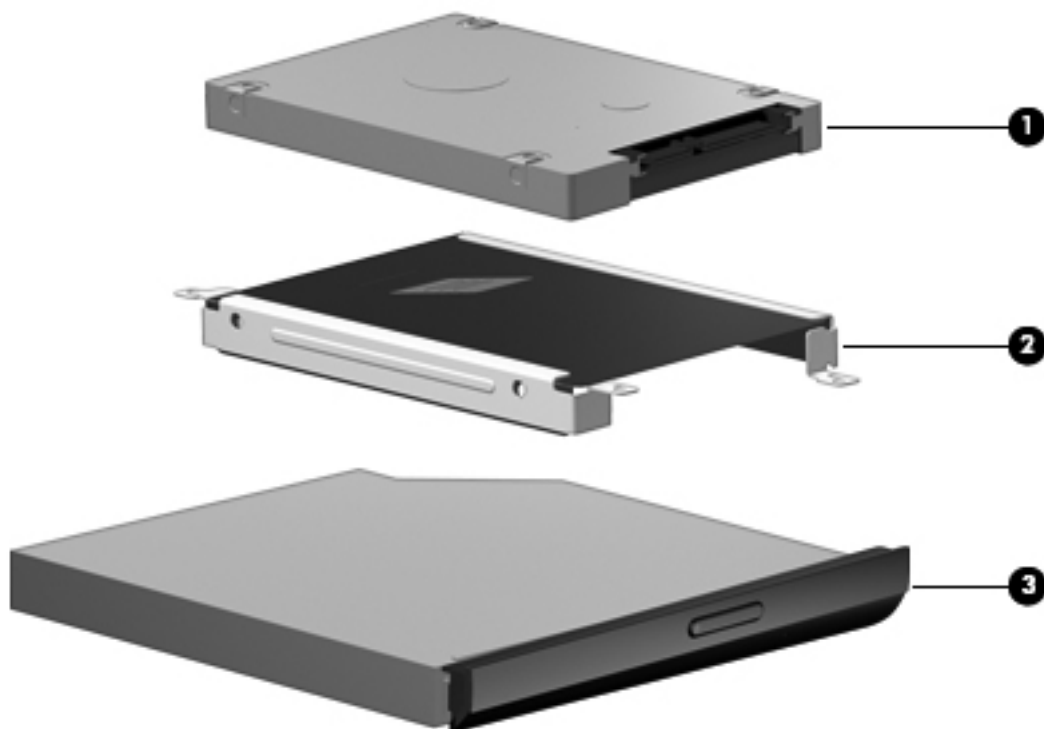

Item	Component	Spare part number
(1)	Hard drive (2.5-in, 7.0-mm, SATA; does not include hard drive connector cable, hard drive bracket, or screws):	
	640-GB, 5400-rpm	603785-001
	500-GB, 5400-rpm	634932-001
	320-GB, 5400-rpm	622643-001
	250-GB, 5400-rpm	622641-001
	Hard Drive Hardware Kit , includes:	646122-001
(2)	Hard drive bracket	
	Screws (not illustrated)	
(3)	Optical drive (includes bezel and bracket):	
	DVD±RW and CD-RW Super Multi Double-Layer Combo Drive with LightScribe (select models only)	646126-001
	DVD±RW and CD-RW Drive	659879-001
	DVD-ROM Drive	659638-001
	Optical drive slot space saver	659632-001

Miscellaneous parts

Component	Spare part number
HP Smart AC adapter:	
65-W RC V HP Smart AC adapter for use with all computer models	609939-001
For use only with computer models equipped with an Intel processor:	
90-W PFC RC V EM HP Smart AC adapter	609940-001
90-W PFC RC V HP Smart AC adapter	609947-001
65-W RC V EM HP Smart AC adapter	609948-001
Power cord (3-pin, black, 1.83-m):	
For use with all computer models:	
For use in Argentina	490371-D01
For use in Denmark	490371-081
For use in Europe	490371-021
For use in Italy	490371-061
For use in Israel	490371-BB1
For use in North America	490371-001
For use in South Africa	490371-AR1
For use in Switzerland	490371-111
For use in the United Kingdom and Singapore	490371-031
For use only with computer models equipped with an Intel processor:	
For use in Australia	490371-011
For use in India	490371-D61
For use in Italy	490371-061
For use in Japan	490371-291
For use in the People's Republic of China	490371-AA1
For use in South Korea	490371-AD1
Screw Kit	646133-001

Plastics Kit



Item	Component	Spare part number
	Plastics Kit , includes:	646131-001
(1)	Hard drive compartment cover (includes one captive screw, secured by a C-clip)	
(2)	Memory module/wireless module compartment cover (includes one captive screw, secured by a C-clip)	

Sequential part number listing

Spare part number	Description
490371-001	Power cord for use with all computer models in North America (3-pin, black, 1.83-m)
490371-011	Power cord for use only with computer models equipped with an Intel processor in Australia (3-pin, black, 1.83-m)
490371-021	Power cord for use with all computer models in Europe (3-pin, black, 1.83-m)
490371-031	Power cord for use with all computer models in the United Kingdom and Singapore (3-pin, black, 1.83-m)
490371-061	Power cord for use only with computer models equipped with an Intel processor in Italy (3-pin, black, 1.83-m)
490371-081	Power cord for use with all computer models in Denmark (3-pin, black, 1.83-m)
490371-111	Power cord for use with all computer models in Switzerland (3-pin, black, 1.83-m)
490371-291	Power cord for use only with computer models equipped with an Intel processor in Japan (3-pin, black, 1.83-m)
490371-AA1	Power cord for use only with computer models equipped with an Intel processor in the People's Republic of China (3-pin, black, 1.83-m)
490371-AD1	Power cord for use only with computer models equipped with an Intel processor in South Korea (3-pin, black, 1.83-m)
490371-AR1	Power cord for use with all computer models in South Africa (3-pin, black, 1.83-m)
490371-BB1	Power cord for use with all computer models in Israel (3-pin, black, 1.83-m)
490371-D01	Power cord for use with all computer models in Argentina (3-pin, black, 1.83-m)
490371-D61	Power cord for use only with computer models equipped with an Intel processor in India (3-pin, black, 1.83-m)
534419-001	Intel Celeron SC C900 2.20-GHz processor (1.0-MB L2 cache, 800-MHz FSB; includes replacement thermal material)
592399-001	Intel Celeron DC T3300 2.00-GHz processor (1.0-MB L2 cache, 800-MHz FSB; includes replacement thermal material)
593127-001	Atheros AR9002WB-1NGB 802.11b/g/n 1×1 WiFi and Bluetooth 2.1+EDR Combo Adapter (BT3.0+HS ready)
593553-001	6-cell, 47-Whr, 2.20-Ah Li-ion battery
593554-001	6-cell, 55-Whr, 2.55-Ah Li-ion battery
602993-001	Realtek 8188BC8 802.11a/b/g/n 2×2 WiFi and Bluetooth 3.0+HS Combo Adapter
603785-001	640-GB, 5400-rpm hard drive (2.5-in, 7.0-mm, SATA; does not include hard drive connector cable, hard drive bracket, or screws)
609939-001	65-W RC V HP Smart AC adapter for use will all computer models
609940-001	90-W PFC RC V EM HP Smart AC adapter for use only with computer models equipped with an Intel processor
609947-001	90-W PFC RC V HP Smart AC adapter for use only with computer models equipped with an Intel processor
609948-001	65-W RC V EM HP Smart AC adapter for use only with computer models equipped with an Intel processor

Spare part number	Description
613584-001	Intel Core i3-370M 2.40-GHz processor (1066-MHz FSB, 3.0-MB L3 cache, dual core, 35 W; includes replacement thermal material; not supported on computer models equipped with Windows 7 Starter 32-bit operating system)
621565-001	2-GB memory module (PC3, 10600, 1333-MHz)
621569-001	4-GB memory module (PC3, 10600, 1333-MHz)
622641-001	250-GB, 5400-rpm hard drive (2.5-in, 7.0-mm, SATA; does not include hard drive connector cable, hard drive bracket, or screws)
622643-001	320-GB, 5400-rpm hard drive (2.5-in, 7.0-mm, SATA; does not include hard drive connector cable, hard drive bracket, or screws)
625823-001	Intel Core i3-380M 2.53-GHz processor (1066-MHz FSB, 3.0-MB L3 cache, dual core, 35 W; includes replacement thermal material; not supported on computer models equipped with Windows 7 Starter 32-bit operating system)
625830-001	Intel Celeron DC T3500 2.10-GHz processor (1.0-MB L2 cache, 800-MHz FSB; includes replacement thermal material)
625831-001	Intel Pentium P6200 2.13-GHz processor (3.0-MB L3 cache, dual core, 35 W; includes replacement thermal material)
630703-001	Ralink 5390GN 802.11b/g/n 1×1 WiFi Adapter
634932-001	500-GB, 5400-rpm hard drive (2.5-in, 7.0-mm, SATA; does not include hard drive connector cable, hard drive bracket, or screws)
635500-001	Intel Pentium P6300 2.26-GHz processor (3.0-MB L3 cache, dual core, 35 W; includes replacement thermal material)
636636-001	Intel Celeron SC C925 2.30-GHz processor (1.0-MB L2 cache, 800-MHz FSB; includes replacement thermal material)
639738-001	1-GB memory module (PC3, 10600, 1333-MHz)
640926-001	Realtek 8188GN 802.11b/g/n 1×1 WiFi Adapter
645094-001	15.6-in, HD, LED, BrightView display assembly not equipped with a webcam (includes microphone and wireless antenna transceivers and cables)
645095-001	15.6-in, HD, LED, BrightView display assembly equipped with a webcam (includes microphone and wireless antenna transceivers and cables)
645096-001	15.6-in, HD, LED, BrightView display panel
645980-001	Microphone module
646111-001	Antenna Kit (includes left and right wireless antenna cables and transceivers)
646113-001	Display enclosure
646114-001	Base enclosure (includes battery release latch, heat sink, replacement thermal material, and 4 rubber feet)
646117-001	Display bezel for use with computer models equipped with a webcam and a microphone
646118-001	Display bezel for use with computer models equipped only with a microphone
646119-001	Cable Kit (includes TouchPad cable, optical drive connector cable, and hard drive connector cable)
	NOTE: See Cable Kit on page 22 for more Cable Kit spare part information.
646120-001	Display Cable Kit (includes display panel cable and webcam/microphone module cable)

Spare part number	Description
646121-001	Power connector cable
646122-001	Hard Drive Hardware Kit (includes hard drive bracket and screws)
646123-001	Display Hinge Kit (includes left and right display hinges and brackets)
646124-001	Display hinge covers
646125-001	Keyboard for use with all computer models in the United States (includes keyboard cable)
646125-031	Keyboard for use with all computer models in the United Kingdom and Singapore (includes keyboard cable)
646125-041	Keyboard for use with all computer models in Germany (includes keyboard cable)
646125-051	Keyboard for use with all computer models in France (includes keyboard cable)
646125-061	Keyboard for use with all computer models in Italy (includes keyboard cable)
646125-071	Keyboard for use with all computer models in Spain (includes keyboard cable)
646125-121	Keyboard for use with all computer models in Canada (includes keyboard cable)
646125-131	Keyboard for use with all computer models in Portugal (includes keyboard cable)
646125-141	Keyboard for use with all computer models in Turkey (includes keyboard cable)
646125-161	Keyboard for use with all computer models in Latin America (includes keyboard cable)
646125-171	Keyboard for use with all computer models in Saudi Arabia (includes keyboard cable)
646125-211	Keyboard for use with all computer models in Hungary (includes keyboard cable)
646125-221	Keyboard for use with all computer models in the Czech Republic (includes keyboard cable)
646125-251	Keyboard for use with all computer models in Russia (includes keyboard cable)
646125-261	Keyboard for use with all computer models in Bulgaria (includes keyboard cable)
646125-291	Keyboard for use only with computer models equipped with an Intel processor in Japan (includes keyboard cable)
646125-A41	Keyboard for use with all computer models in Belgium (includes keyboard cable)
646125-AB1	Keyboard for use only with computer models equipped with an Intel processor in Taiwan (includes keyboard cable)
646125-AD1	Keyboard for use only with computer models equipped with an Intel processor in South Korea (includes keyboard cable)
646125-B31	Keyboard for use with all computer models in the Netherlands (includes keyboard cable)
646125-BA1	Keyboard for use with all computer models in Slovenia (includes keyboard cable)
646125-BB1	Keyboard for use with all computer models in Israel (includes keyboard cable)
646125-BG1	Keyboard for use with all computer models in Switzerland (includes keyboard cable)
646125-D61	Keyboard for use only with computer models equipped with an Intel processor in India (includes keyboard cable)
646125-DH1	Keyboard for use with all computer models in Denmark, Finland, and Norway (includes keyboard cable)
646125-DJ1	Keyboard for use with all computer models in Greece (includes keyboard cable)

Spare part number	Description
646126-001	DVD±RW and CD-RW Super Multi Double-Layer Combo Drive with LightScribe (select models only)
646128-001	USB board (includes cable)
646129-001	Power button board (includes cable)
646130-001	TouchPad button board (includes bracket and cable)
646131-001	Plastics Kit (includes hard drive compartment cover and memory module/wireless module compartment cover)
	NOTE: See Plastics Kit on page 26 for more Plastics Kit spare part information.
646132-001	RTC battery (includes cable and double-sided tape)
646133-001	Screw Kit
646134-001	Display Screw Kit (includes Mylar screw covers and screws)
646135-001	Thermal Material Kit for use only with computer models equipped with an Intel processor (includes replacement thermal paste and pads)
646136-001	Top cover (includes TouchPad and TouchPad cable)
646138-001	Webcam/microphone module
646174-001	System board for use only with computer models equipped with an Intel Celeron processor (includes replacement thermal material)
646175-001	System board for use only with computer models equipped with an Intel Pentium processor and a graphics subsystem with UMA video memory (includes replacement thermal material)
646176-001	System board for use only with computer models equipped with an Intel Pentium processor and a graphics subsystem with discrete video memory (includes replacement thermal material)
646177-001	System board for use only with computer models equipped with an Intel Core i5 or i3 processor and a graphics subsystem with UMA video memory (includes replacement thermal material)
646179-001	System board for use only with computer models equipped with an Intel Core i5 or i3 processor and a graphics subsystem with discrete video memory (includes replacement thermal material)
646180-001	Fan/heat sink assembly for use only with computer models equipped with an Intel Pentium processor and a graphics subsystem with discrete video memory (includes replacement thermal material)
646181-001	Fan/heat sink assembly for use only with computer models equipped with an Intel Pentium processor and a graphics subsystem with UMA video memory (includes replacement thermal material)
646182-001	Fan/heat sink assembly for use only with computer models equipped with an Intel Core i5 or i3 processor and a graphics subsystem with discrete video memory (includes replacement thermal material)
646183-001	Fan/heat sink assembly for use only with computer models equipped with an Intel Core i5 or i3 processor and a graphics subsystem with UMA video memory (includes replacement thermal material)
646184-001	Fan/heat sink assembly for use only with computer models equipped with an Intel Celeron processor and a graphics subsystem with UMA video memory (includes replacement thermal material)
647315-001	Speaker Kit (includes left and right speakers and cable)
647316-001	Fan/heat sink assembly for use only with computer models equipped with an AMD processor (includes replacement thermal material)

Spare part number	Description
647320-001	System board for use only with computer models equipped with an AMD E350 1.60-GHz processor (dual core, 18 W) and a graphics subsystem with UMA video memory (includes replacement thermal material; for use only with computer models in the United States)
647322-001	System board for use only with computer models equipped with an AMD E240 1.50-GHz processor (dual core, 18 W) and a graphics subsystem with UMA video memory (for use only with computer models in the United States)
650277-001	Thermal Material Kit for use only with computer models equipped with an AMD processor (includes replacement thermal paste and pads)
653337-001	Intel Pentium B940 2.00-GHz processor (2.0-MB L2 cache, dual core, TJ85, 35 W; includes replacement thermal paste and pads; not supported on computer models equipped with Windows 7 Starter 32-bit operating system)
653338-001	Intel Pentium B950 2.10-GHz processor (2.0-MB L2 cache, dual core, TJ85, 35 W; includes replacement thermal paste and pads; not supported on computer models equipped with Windows 7 Starter 32-bit operating system)
653339-001	Intel Core i3-2330M 2.20-GHz processor (1333-MHz FSB, 3.0-MB L3 cache, dual core, 35 W; includes replacement thermal paste and pads; not supported on computer models equipped with Windows 7 Starter 32-bit operating system)
653340-001	Intel Core i3-2350M 2.30-GHz processor (1333-MHz FSB, 3.0-MB L3 cache, dual core, 35 W; includes replacement thermal paste and pads; not supported on computer models equipped with Windows 7 Starter 32-bit operating system)
653341-001	Intel Core i5-2430M 2.40-GHz processor (1333-MHz FSB, 3.0-MB L3 cache, dual core, 35 W; includes replacement thermal paste and pads; not supported on computer models equipped with Windows 7 Starter 32-bit operating system)
653985-001	System board for use only with computer models equipped with an AMD C50 1.00-GHz processor (1.0-MB L2 cache, dual core, 9 W) and a graphics subsystem with UMA video memory (includes replacement thermal paste and pads; for use only with computer models in the United States)
655795-001	Atheros 9485GN 802.11b/g/n 1×1 WiFi and 3012 Bluetooth 4.0 Combo Adapter
657323-001	System board for use only with computer models equipped with an AMD E450 1.65-GHz processor (dual core, 18 W) and a graphics subsystem with UMA video memory (includes replacement thermal paste and pads)
657324-001	System board for use only with computer models equipped with an AMD E300 1.60-GHz processor (dual core, 18 W) and a graphics subsystem with UMA video memory (includes replacement thermal paste and pads)
657325-001	Broadcom 4313GN 802.11b/g/n 1×1 WiFi and 20702 Bluetooth 4.0 Combo Adapter
659632-001	Optical drive slot space saver
659638-001	DVD-ROM Drive
659879-001	DVD±RW and CD-RW Drive
664660-001	Intel Celeron B710 1.50-GHz processor (1.0-MB L3 cache, single core, 35 W; includes replacement thermal paste and pads)
664661-001	Intel Celeron B800 1.50-GHz processor (2.0-MB L3 cache, dual core, 35 W; includes replacement thermal paste and pads)
664662-001	Intel Pentium B960 2.20-GHz processor (2.0-MB L2 cache, dual core, TJ85, 35 W; includes replacement thermal paste and pads; not supported on computer models equipped with Windows 7 Starter 32-bit operating system)

Spare part number	Description
676359-001	Intel Core i5-2450M 2.50-GHz processor (1333-MHz FSB, 3.0-MB L3 cache, dual core, 35 W; includes replacement thermal paste and pads; not supported on computer models equipped with Windows 7 Starter 32-bit operating system)
676785-001	Intel Pentium B970 2.30-GHz processor (2.0-MB L2 cache, dual core, TJ85, 35 W; includes replacement thermal paste and pads; not supported on computer models equipped with Windows 7 Starter 32-bit operating system)
677153-001	Intel Celeron B815 1.60-GHz processor (2.0-MB L3 cache, dual core, 35 W; includes replacement thermal paste and pads)

4 Removal and replacement procedures

Preliminary replacement requirements

Tools required

You will need the following tools to complete the removal and replacement procedures:

- Flat-bladed screwdriver
- Magnetic screwdriver
- Phillips P0 and P1 screwdrivers

Service considerations

The following sections include some of the considerations that you must keep in mind during disassembly and assembly procedures.

 **NOTE:** As you remove each subassembly from the computer, place the subassembly (and all accompanying screws) away from the work area to prevent damage.

Plastic parts

 **CAUTION:** Using excessive force during disassembly and reassembly can damage plastic parts. Use care when handling the plastic parts. Apply pressure only at the points designated in the maintenance instructions.

Cables and connectors

 **CAUTION:** When servicing the computer, be sure that cables are placed in their proper locations during the reassembly process. Improper cable placement can damage the computer.

Cables must be handled with extreme care to avoid damage. Apply only the tension required to unseat or seat the cables during removal and insertion. Handle cables by the connector whenever possible. In all cases, avoid bending, twisting, or tearing cables. Be sure that cables are routed in such a way that they cannot be caught or snagged by parts being removed or replaced. Handle flex cables with extreme care; these cables tear easily.

Drive handling

⚠ CAUTION: Drives are fragile components that must be handled with care. To prevent damage to the computer, damage to a drive, or loss of information, observe these precautions:

Before removing or inserting a hard drive, shut down the computer. If you are unsure whether the computer is off or in Hibernation, turn the computer on, and then shut it down through the operating system.

Before handling a drive, be sure that you are discharged of static electricity. While handling a drive, avoid touching the connector.

Before removing a diskette drive or optical drive, be sure that a diskette or disc is not in the drive and be sure that the optical drive tray is closed.

Handle drives on surfaces covered with at least one inch of shock-proof foam.

Avoid dropping drives from any height onto any surface.

After removing a hard drive, an optical drive, or a diskette drive, place it in a static-proof bag.

Avoid exposing an internal hard drive to products that have magnetic fields, such as monitors or speakers.

Avoid exposing a drive to temperature extremes or liquids.

If a drive must be mailed, place the drive in a bubble pack mailer or other suitable form of protective packaging and label the package "FRAGILE."

Grounding guidelines

Electrostatic discharge damage

Electronic components are sensitive to electrostatic discharge (ESD). Circuitry design and structure determine the degree of sensitivity. Networks built into many integrated circuits provide some protection, but in many cases, ESD contains enough power to alter device parameters or melt silicon junctions.

A discharge of static electricity from a finger or other conductor can destroy static-sensitive devices or microcircuitry. Even if the spark is neither felt nor heard, damage may have occurred.

An electronic device exposed to ESD may not be affected at all and can work perfectly throughout a normal cycle. Or the device may function normally for a while, then degrade in the internal layers, reducing its life expectancy.

⚠ CAUTION: To prevent damage to the computer when you are removing or installing internal components, observe these precautions:

Keep components in their electrostatic-safe containers until you are ready to install them.

Before touching an electronic component, discharge static electricity by using the guidelines described in this section.

Avoid touching pins, leads, and circuitry. Handle electronic components as little as possible.

If you remove a component, place it in an electrostatic-safe container.

The following table shows how humidity affects the electrostatic voltage levels generated by different activities.

 **CAUTION:** A product can be degraded by as little as 700 V.

Typical electrostatic voltage levels			
Event	Relative humidity		
	10%	40%	55%
Walking across carpet	35,000 V	15,000 V	7,500 V
Walking across vinyl floor	12,000 V	5,000 V	3,000 V
Motions of bench worker	6,000 V	800 V	400 V
Removing DIPS from plastic tube	2,000 V	700 V	400 V
Removing DIPS from vinyl tray	11,500 V	4,000 V	2,000 V
Removing DIPS from Styrofoam	14,500 V	5,000 V	3,500 V
Removing bubble pack from PCB	26,500 V	20,000 V	7,000 V
Packing PCBs in foam-lined box	21,000 V	11,000 V	5,000 V

Packaging and transporting guidelines

Follow these grounding guidelines when packaging and transporting equipment:

- To avoid hand contact, transport products in static-safe tubes, bags, or boxes.
- Protect ESD-sensitive parts and assemblies with conductive or approved containers or packaging.
- Keep ESD-sensitive parts in their containers until the parts arrive at static-free workstations.
- Place items on a grounded surface before removing items from their containers.
- Always be properly grounded when touching a component or assembly.
- Store reusable ESD-sensitive parts from assemblies in protective packaging or nonconductive foam.
- Use transporters and conveyors made of antistatic belts and roller bushings. Be sure that mechanized equipment used for moving materials is wired to ground and that proper materials are selected to avoid static charging. When grounding is not possible, use an ionizer to dissipate electric charges.

Workstation guidelines

Follow these grounding workstation guidelines:

- Cover the workstation with approved static-shielding material.
- Use a wrist strap connected to a properly grounded work surface and use properly grounded tools and equipment.
- Use conductive field service tools, such as cutters, screwdrivers, and vacuums.
- When fixtures must directly contact dissipative surfaces, use fixtures made only of static-safe materials.
- Keep the work area free of nonconductive materials, such as ordinary plastic assembly aids and Styrofoam.
- Handle ESD-sensitive components, parts, and assemblies by the case or PCM laminate. Handle these items only at static-free workstations.
- Avoid contact with pins, leads, or circuitry.
- Turn off power and input signals before inserting or removing connectors or test equipment.

Equipment guidelines

Grounding equipment must include either a wrist strap or a foot strap at a grounded workstation.

- When seated, wear a wrist strap connected to a grounded system. Wrist straps are flexible straps with a minimum of one megohm $\pm 10\%$ resistance in the ground cords. To provide proper ground, wear a strap snugly against the skin at all times. On grounded mats with banana-plug connectors, use alligator clips to connect a wrist strap.
- When standing, use foot straps and a grounded floor mat. Foot straps (heel, toe, or boot straps) can be used at standing workstations and are compatible with most types of shoes or boots. On conductive floors or dissipative floor mats, use foot straps on both feet with a minimum of one megohm resistance between the operator and ground. To be effective, the conductive must be worn in contact with the skin.

The following grounding equipment is recommended to prevent electrostatic damage:

- Antistatic tape
- Antistatic smocks, aprons, and sleeve protectors
- Conductive bins and other assembly or soldering aids
- Nonconductive foam
- Conductive tabletop workstations with ground cords of one megohm resistance
- Static-dissipative tables or floor mats with hard ties to the ground
- Field service kits
- Static awareness labels
- Material-handling packages
- Nonconductive plastic bags, tubes, or boxes
- Metal tote boxes
- Electrostatic voltage levels and protective materials

The following table lists the shielding protection provided by antistatic bags and floor mats.

Material	Use	Voltage protection level
Antistatic plastics	Bags	1,500 V
Carbon-loaded plastic	Floor mats	7,500 V
Metallized laminate	Floor mats	5,000 V

Component replacement procedures

This chapter provides removal and replacement procedures.

There are as many as 75 screws that must be removed, replaced, or loosened when servicing the computer. Make special note of each screw size and location during removal and replacement.

Service tag

When ordering parts or requesting information, provide the computer serial number and model number provided on the service tag.

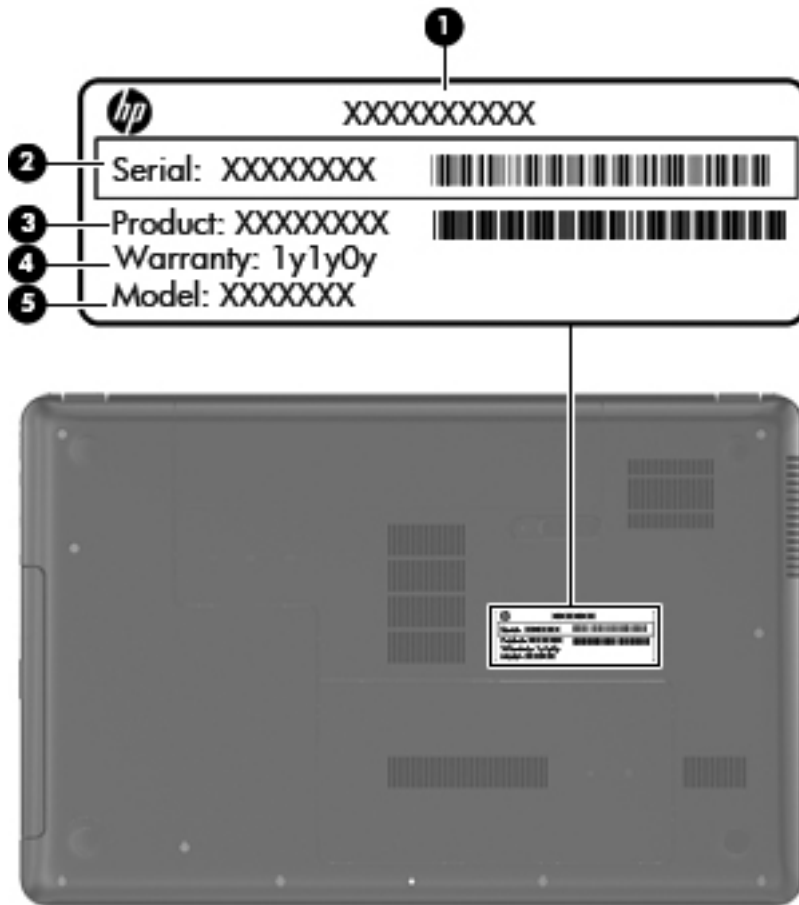

Item	Component	Description
(1)	Product name	This is the product name affixed to the front of the computer.
(2)	Serial number (s/n)	This is an alphanumeric identifier that is unique to each product.
(3)	Part number/Product number (p/n)	This number provides specific information about the product's hardware components. The part number helps a service technician determine what components and parts are needed.

Item	Component	Description
(4)	Warranty period	This number describes the duration of the warranty period for the computer.
(5)	Model description	This is the alphanumeric identifier used to locate documents, drivers, and support for the computer.

Computer feet

The computer feet are adhesive-backed rubber pads. There are 4 rubber feet that attach to the base enclosure in the locations illustrated below.

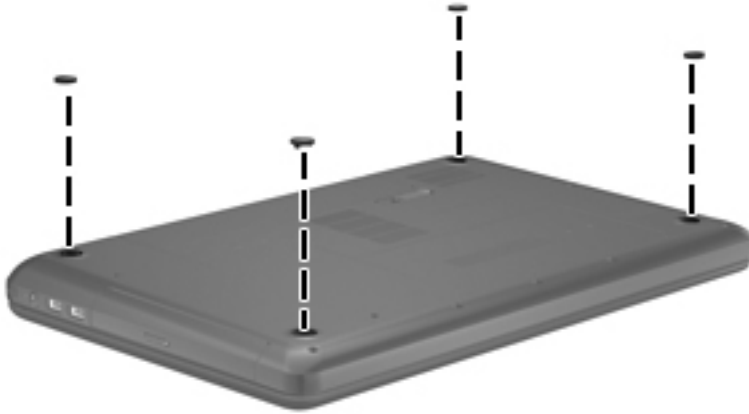

Battery

Description	Spare part number
6-cell, 55-Whr, 2.55-Ah Li-ion battery	593554-001
6-cell, 47-Whr, 2.20-Ah Li-ion battery	593553-001

Before disassembling the computer, follow these steps:

1. Shut down the computer. If you are unsure whether the computer is off or in Hibernation, turn the computer on, and then shut it down through the operating system.
2. Disconnect all external devices connected to the computer.
3. Disconnect the power from the computer by first unplugging the power cord from the AC outlet and then unplugging the AC adapter from the computer.

Remove the battery:

1. Slide the battery release latch **(1)** to release the battery.
2. Pivot the front edge of the battery **(2)** up and back.
3. Remove the battery **(3)** from the computer.



To insert the battery:

1. Align the tabs on the rear edge of the battery with the notches on the rear edge of the battery bay.
2. Pivot the front edge of the battery down into the battery bay until it is seated. (The battery release latch will automatically lock into place.)

Optical drive (select models only)



NOTE: The optical drive spare part kit includes a bezel and bracket.

Description	Spare part number
DVD±RW and CD-RW Super Multi Double-Layer Combo Drive with LightScribe	646126-001
DVD±RW and CD-RW Drive	659879-001
DVD-ROM Drive	659638-001
Optical drive slot space saver	659632-001

Before removing the optical drive, follow these steps:

1. Shut down the computer. If you are unsure whether the computer is off or in Hibernation, turn the computer on, and then shut it down through the operating system.
2. Disconnect all external devices connected to the computer.
3. Disconnect the power from the computer by first unplugging the power cord from the AC outlet and then unplugging the AC adapter from the computer.
4. Remove the battery (see [Battery on page 40](#)).

Remove the optical drive:

1. Loosen the captive screw (1) that secures the memory module/wireless module compartment cover to the computer.
2. Lift the rear edge of the memory module/wireless module compartment cover (2) up and forward until it rests at an angle.

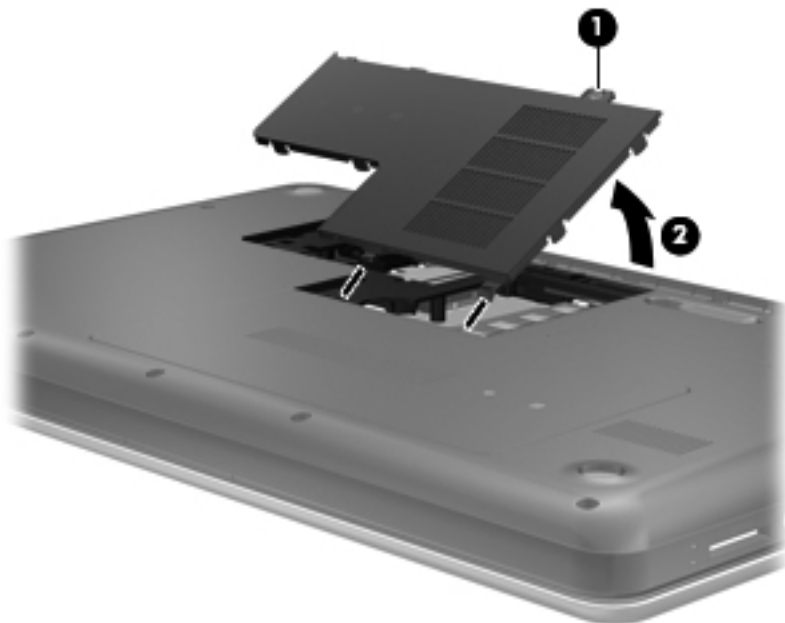

3. Remove the memory module/wireless module compartment cover. The memory module/wireless module compartment cover is available in the Plastics Kit, spare part number 646131-001.
4. Remove the Phillips PM2.5×6.0 screw (1) that secures the optical drive to the computer.
5. Insert an unbent paper clip or similar thin tool into the optical drive tab access (2) to release the optical drive tray from the optical drive.
6. Remove the optical drive (3) by sliding it out of the optical drive bay.

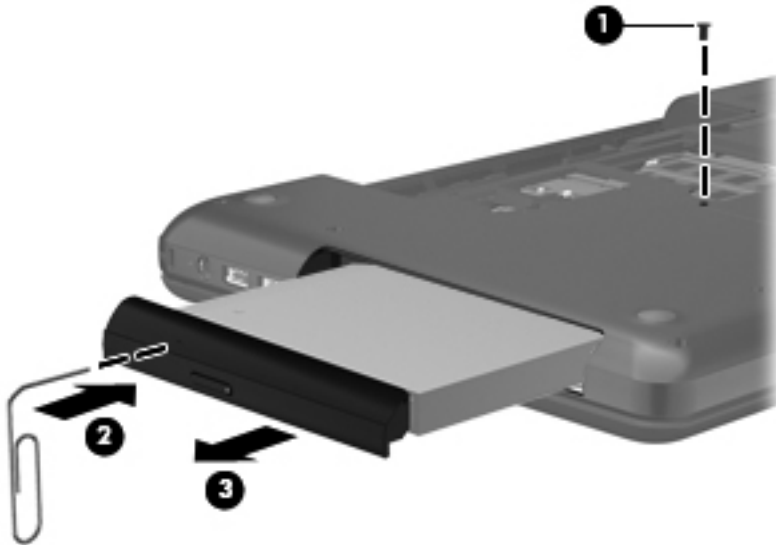

7. If it is necessary to replace the optical drive bracket, position the optical drive with the rear panel toward you.
8. Remove the two Phillips PM2.0×3.0 screws (1) that secure the bracket to the optical drive.
9. Remove the optical drive bracket (2).

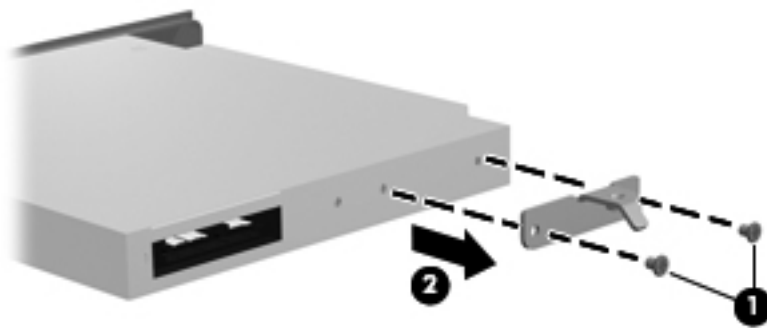

Reverse this procedure to reassemble and install the optical drive.

WLAN module

Description	Spare part number
Atheros 9485GN 802.11b/g/n 1×1 WiFi and 3012 Bluetooth 4.0 Combo Adapter	655795-001
Atheros AR9002WB-1NGB 802.11b/g/n 1×1 WiFi and Bluetooth 2.1+EDR Combo Adapter (BT3.0+HS ready)	593127-001
Broadcom 4313GN 802.11b/g/n 1×1 WiFi and 20702 Bluetooth 4.0 Combo Adapter	657325-001
Ralink 5390GN 802.11b/g/n 1×1 WiFi Adapter	630703-001
Realtek 8188BC8 802.11a/b/g/n 2×2 WiFi and Bluetooth 3.0+HS Combo Adapter	602993-001
Realtek 8188GN 802.11b/g/n 1×1 WiFi Adapter	640926-001

 **CAUTION:** To prevent an unresponsive system, replace the wireless module only with a wireless module authorized for use in the computer by the governmental agency that regulates wireless devices in your country or region. If you replace the module and then receive a warning message, remove the module to restore device functionality, and then contact technical support.

Before removing the WLAN module, follow these steps:

1. Shut down the computer. If you are unsure whether the computer is off or in Hibernation, turn the computer on, and then shut it down through the operating system.
2. Disconnect all external devices connected to the computer.
3. Disconnect the power from the computer by first unplugging the power cord from the AC outlet and then unplugging the AC adapter from the computer.
4. Remove the battery (see [Battery on page 40](#)).
5. Remove the memory module/wireless module compartment cover (see [Optical drive \(select models only\) on page 41](#)).

Remove the WLAN module:

1. Disconnect the WLAN antenna cables **(1)** from the terminals on the WLAN module.





NOTE: The #1 WLAN antenna cable is connected to the WLAN module #1 terminal. The #2 WLAN antenna cable is connected to the WLAN module #2 terminal.

2. Remove the Phillips PM2.0×3.0 screw **(2)** that secures the WLAN module to the system board. (The WLAN module tilts up.)

3. Remove the WLAN module by pulling the module away from the slot at an angle (3).

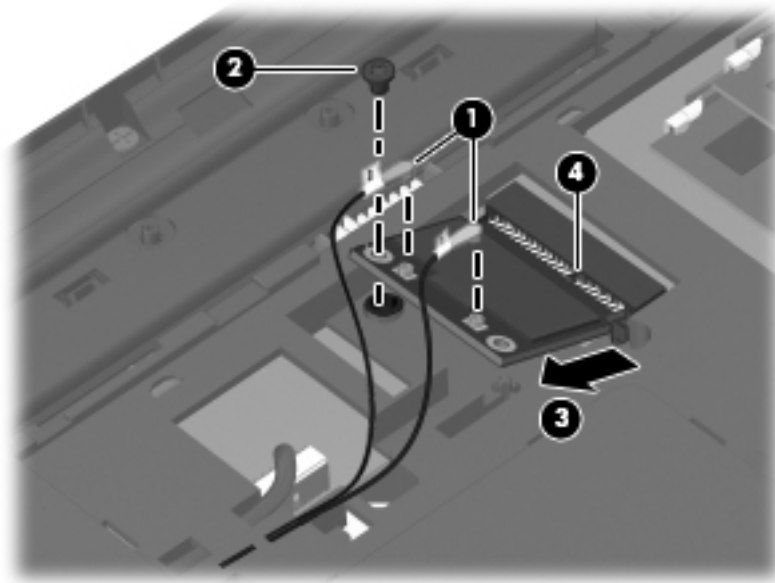
 **NOTE:** The WLAN module is designed with a notch (4) to prevent incorrect installation into the WLAN module socket.



 **NOTE:** If the WLAN antennas are not connected to the terminals on the WLAN module, the protective sleeves must be installed on the antenna connectors, as shown in the following illustration.

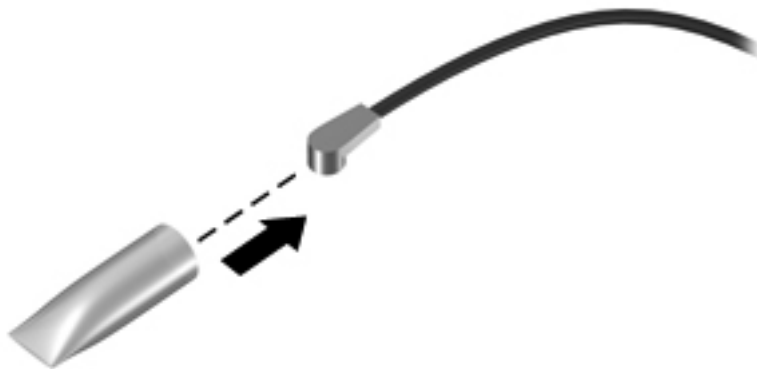

Reverse this procedure to install the WLAN module.

Memory module

Description	Spare part number
4-GB (PC3, 10600, 1333-MHz)	621569-001
2-GB (PC3, 10600, 1333-MHz)	621565-001
1-GB (PC3, 10600, 1333-MHz)	639738-001

Before removing a memory module, follow these steps:

1. Shut down the computer. If you are unsure whether the computer is off or in Hibernation, turn the computer on, and then shut it down through the operating system.
2. Disconnect all external devices connected to the computer.
3. Disconnect the power from the computer by first unplugging the power cord from the AC outlet and then unplugging the AC adapter from the computer.
4. Remove the battery (see [Battery on page 40](#)).
5. Remove the memory module/wireless module compartment cover (see [Optical drive \(select models only\) on page 41](#)).

Remove the memory module:

1. Spread the retaining tabs **(1)** on each side of the memory module slot to release the memory module. (The memory module tilts up.)
2. Remove the memory module **(2)** by pulling it away from the slot at an angle.

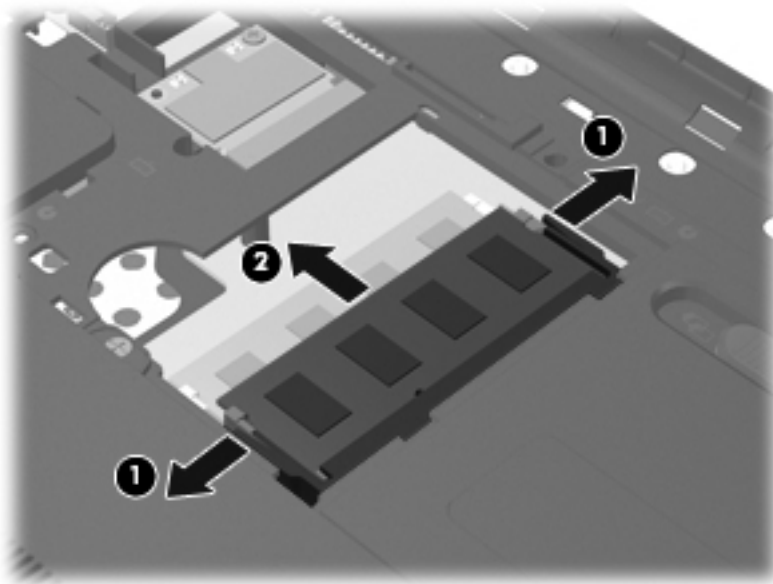

Reverse this procedure to install a memory module.

Hard drive



NOTE: The hard drive spare part kit does not include the hard drive connector cable, bracket, or screws. The hard drive connector cable is included in the Cable Kit, spare part number 646119-001. The hard drive bracket and screws are included in the Hard Drive Hardware Kit, spare part number 646122-001.

Description	Spare part number
640-GB, 5400-rpm	603785-001
500-GB, 5400-rpm	634932-001
320-GB, 5400-rpm	622643-001
250-GB, 5400-rpm	622641-001

Before removing the hard drive, follow these steps:

1. Shut down the computer. If you are unsure whether the computer is off or in Hibernation, turn the computer on, and then shut it down through the operating system.
2. Disconnect all external devices connected to the computer.
3. Disconnect the power from the computer by first unplugging the power cord from the AC outlet and then unplugging the AC adapter from the computer.
4. Remove the battery (see [Battery on page 40](#)).
5. Remove the memory module/wireless module compartment cover (see [Optical drive \(select models only\) on page 41](#)).

Remove the hard drive:

1. Loosen the captive screw **(1)** that secures the hard drive compartment cover to the computer.

2. Lift the rear edge of the hard drive compartment cover (2) up and forward until it rests at an angle.

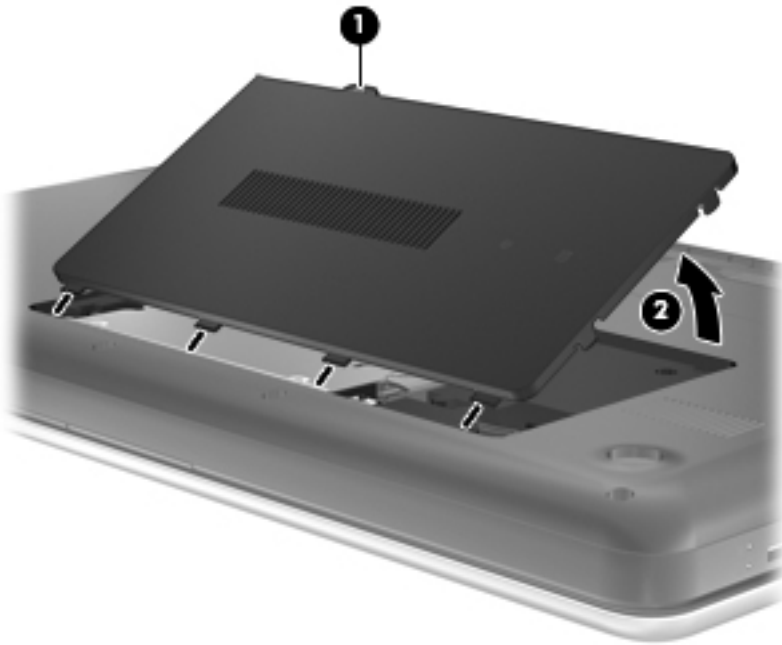

3. Remove the hard drive compartment cover. The hard drive compartment cover is available in the Plastics Kit, spare part number 646131-001.
4. Disconnect the hard drive connector cable (1) from the system board.
5. Release the hard drive connector cable from the clips (2) built into the base enclosure.
6. Remove the four Phillips PM 2.5x6.0 screws (3) that secure the hard drive to the computer.
7. Remove the hard drive (4).

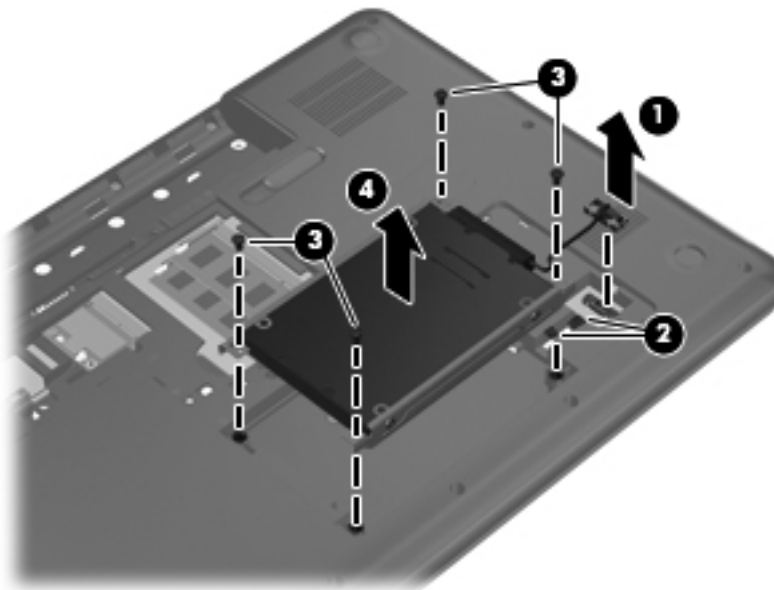

8. If it is necessary to replace the hard drive connector cable (1), the hard drive screws (2), or the hard drive bracket (3), remove and replace the components.

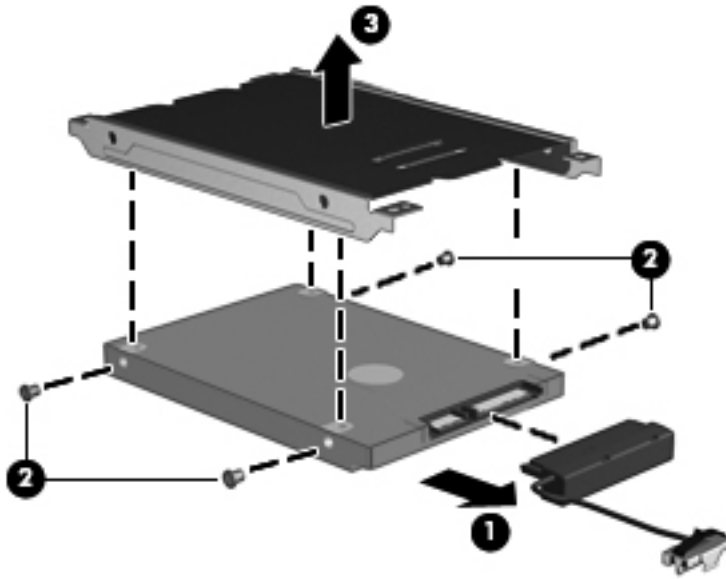

Reverse this procedure to reassemble and install the hard drive.

Keyboard



NOTE: The keyboard spare part kit includes a keyboard cable.

Description	Spare part number	Description	Spare part number
For use with all computer models:			
For use in Belgium	646125-A41	For use in Latin America	646125-161
For use in Bulgaria	646125-261	For use in the Netherlands	646125-B31
For use in Canada	646125-121	For use in Portugal	646125-131
For use in the Czech Republic	646125-221	For use in Russia	646125-251
For use in Denmark, Finland, and Norway	646125-DH1	For use in Saudi Arabia	646125-171
For use in France	646125-051	For use in Slovenia	646125-BA1
For use in Germany	646125-041	For use in Spain	646125-071
For use in Greece	646125-DJ1	For use in Switzerland	646125-BG1
For use in Hungary	646125-211	For use in Turkey	646125-141
For use in Israel	646125-BB1	For use in the United Kingdom	646125-031
For use in Italy	646125-061	For use in the United States	646125-001
For use only with computer models equipped with an Intel processor:			
For use in India	646125-D61	For use in South Korea	646125-AD1
For use in Japan	646125-291	For use in Taiwan	646125-AB1

Before removing the keyboard, follow these steps:

1. Shut down the computer. If you are unsure whether the computer is off or in Hibernation, turn the computer on, and then shut it down through the operating system.
2. Disconnect all external devices connected to the computer.
3. Disconnect the power from the computer by first unplugging the power cord from the AC outlet and then unplugging the AC adapter from the computer.
4. Remove the battery (see [Battery on page 40](#)).
5. Remove the memory module/wireless module compartment cover (see [Optical drive \(select models only\) on page 41](#)).
6. Remove the hard drive compartment cover (see [Hard drive on page 46](#)).

Remove the keyboard:

1. Remove the Phillips PM2.5×6.0 screw that secures the keyboard to the computer.

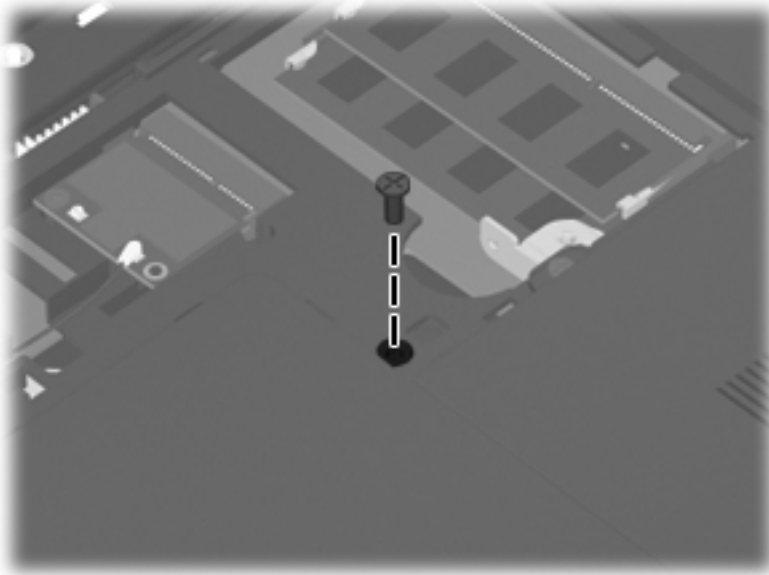

2. Rest and secure the computer on its left side.
3. Partially open the computer.
4. Insert a screw driver or similar thin tool into the keyboard release hole, and then press on the back of the keyboard until the keyboard disengages from the computer.

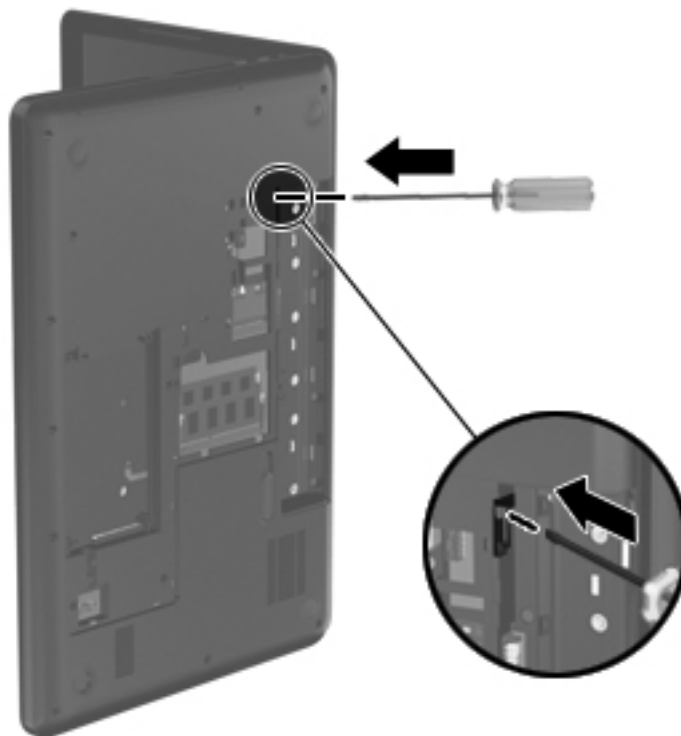

5. Turn the computer right-side up with the front toward you.

6. Lift the rear edge of the keyboard **(1)**, and then swing the keyboard up and forward **(2)** until it rests upside down on the palm rest.

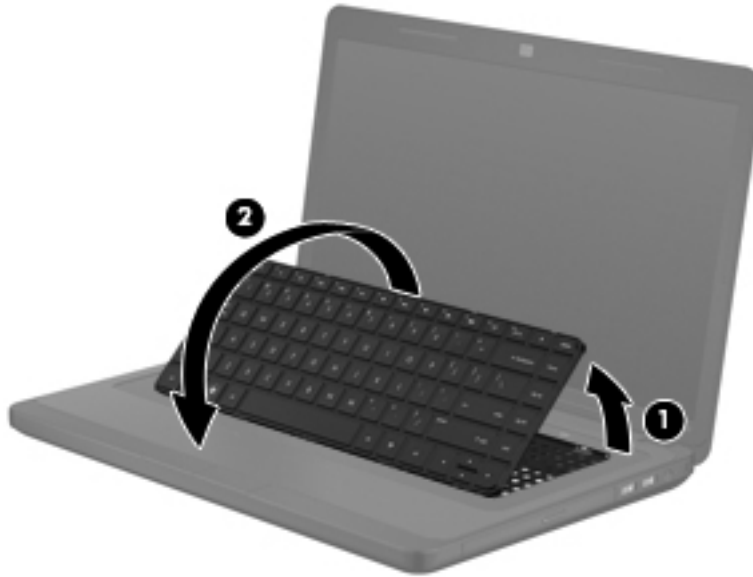

7. Release the zero insertion force (ZIF) connector **(1)** to which the keyboard cable is attached, and then disconnect the keyboard cable **(2)** from the system board.

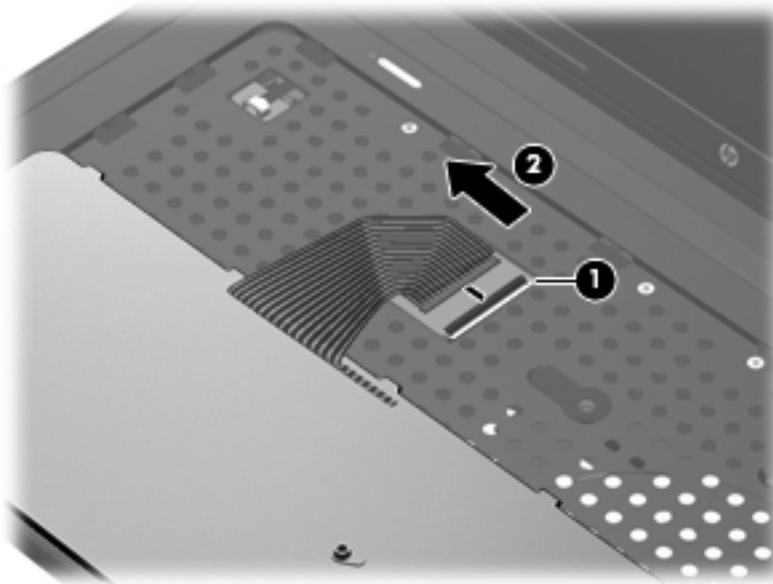

8. Remove the keyboard.

Reverse this procedure to install the keyboard.

Top cover

 **NOTE:** The top cover spare part kit includes the TouchPad and TouchPad cable.

Description	Spare part number
Top cover (includes TouchPad and TouchPad cable)	646136-001

Before removing the top cover, follow these steps:

1. Shut down the computer. If you are unsure whether the computer is off or in Hibernation, turn the computer on, and then shut it down through the operating system.
2. Disconnect all external devices connected to the computer.
3. Disconnect the power from the computer by first unplugging the power cord from the AC outlet and then unplugging the AC adapter from the computer.
4. Remove the battery (see [Battery on page 40](#)).
5. Remove the optical drive (see [Optical drive \(select models only\) on page 41](#)).
6. Remove the keyboard (see [Keyboard on page 49](#)).

When replacing the top cover, be sure that the following components are removed from the defective top cover and installed on the replacement top cover:

- Power button board and cable (see [Power button board on page 56](#))
- TouchPad button board and cable (see [TouchPad button board on page 57](#))

Remove the top cover:

1. Close the computer.
2. Turn the computer upside down, with the front toward you.
3. Remove the eight Phillips PM2.5×6.0 screws on the surface of the base enclosure that secure the top cover to the computer.

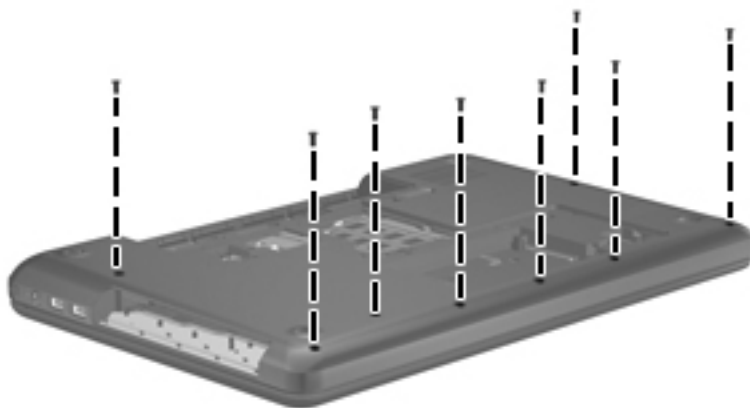

4. Remove the seven Phillips PM2.5×6.0 screws in the battery bay and the hard drive bay that secure the top cover to the computer.

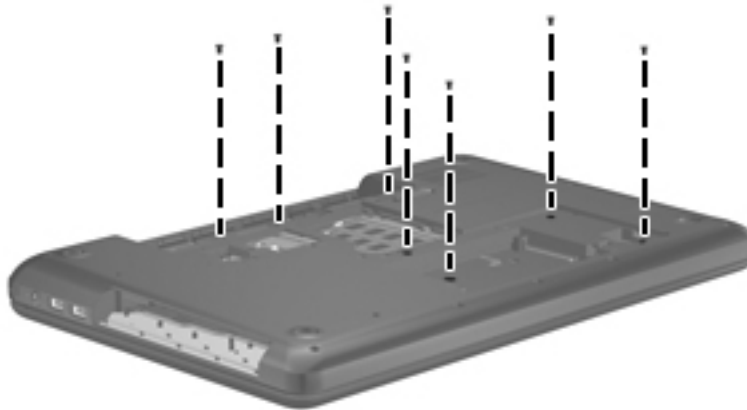

5. Remove the two Phillips PM2.5×9.0 screws (1) and the three Phillips PM2.0×3.0 screws (2) in the battery bay that secure the top cover to the computer.

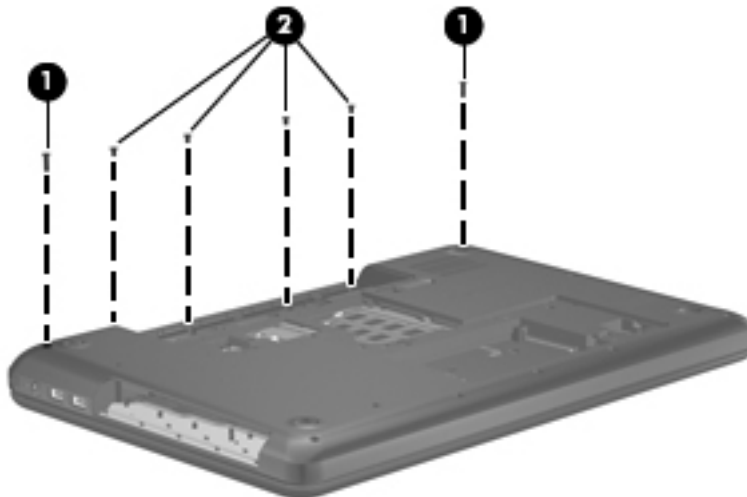

6. Turn the computer right-side up, with the front toward you.
7. Open the computer.
8. Release the ZIF connectors to which the following cables are attached, and then disconnect the cables from the system board:
 - Power button board cable (1) (included with the power button board spare part kit, spare part number 646129-001)
 - TouchPad button board cable (2) (included with the TouchPad button board spare part kit, spare part number 646130-001)
 - TouchPad cable (3) (included in the Cable Kit, spare part number 646119-001)

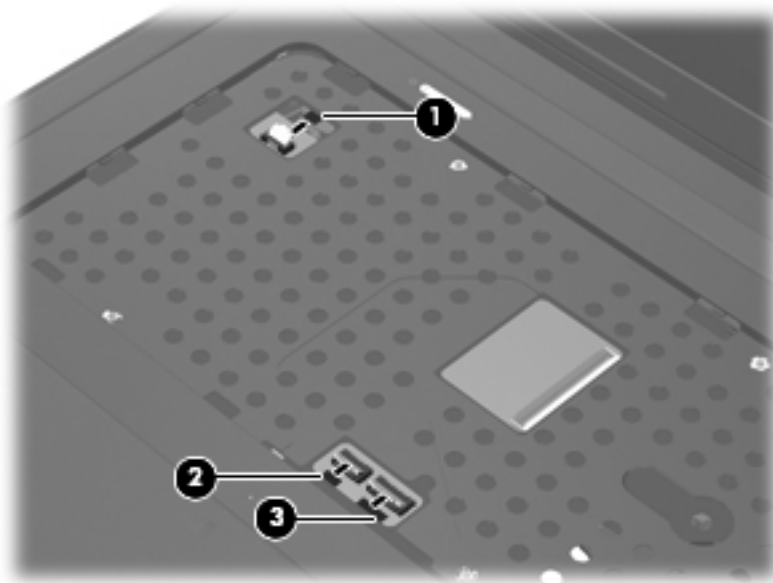

9. Remove the Phillips PM2.5×6.0 screw that secures the top cover to the computer.

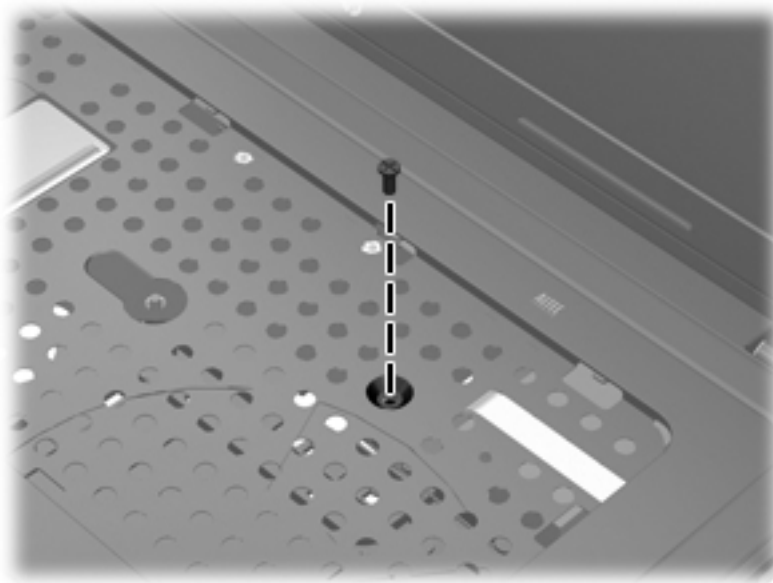

10. Lift the rear edge of the top cover (1) until the left and right sides disengage from the base enclosure.

11. Remove the top cover (2).

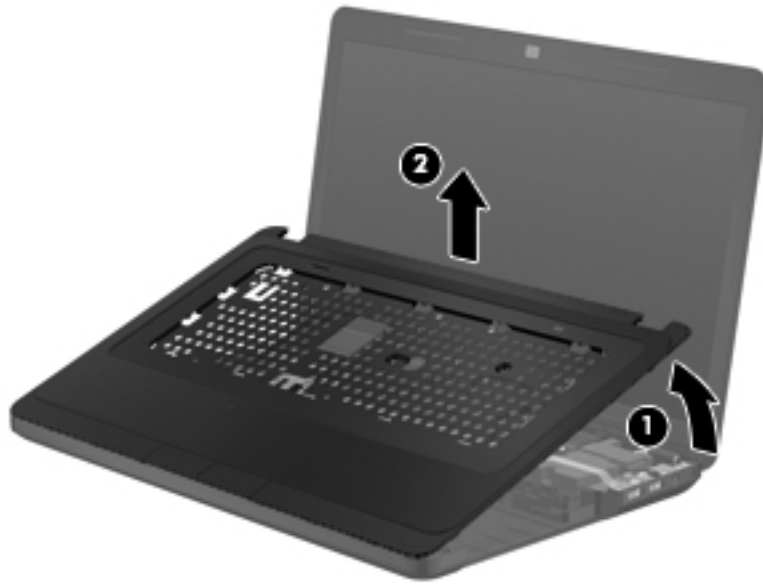

Reverse this procedure to install the top cover.

Power button board

Description	Spare part number
Power button board (includes cable)	646129-001

Before removing the power button board, follow these steps:

1. Shut down the computer. If you are unsure whether the computer is off or in Hibernation, turn the computer on, and then shut it down through the operating system.
2. Disconnect all external devices connected to the computer.
3. Disconnect the power from the computer by first unplugging the power cord from the AC outlet and then unplugging the AC adapter from the computer.
4. Remove the battery (see [Battery on page 40](#)), and then remove the following components:
 - Optical drive (see [Optical drive \(select models only\) on page 41](#))
 - Keyboard (see [Keyboard on page 49](#))
 - Top cover (see [Top cover on page 52](#))

Remove the power button board:

1. Turn the top cover upside down, with the top toward you.
2. Remove the two Phillips PM2.0×3.0 screws (1) that secure the power button board to the top cover.
3. Remove the power button board and cable (2).

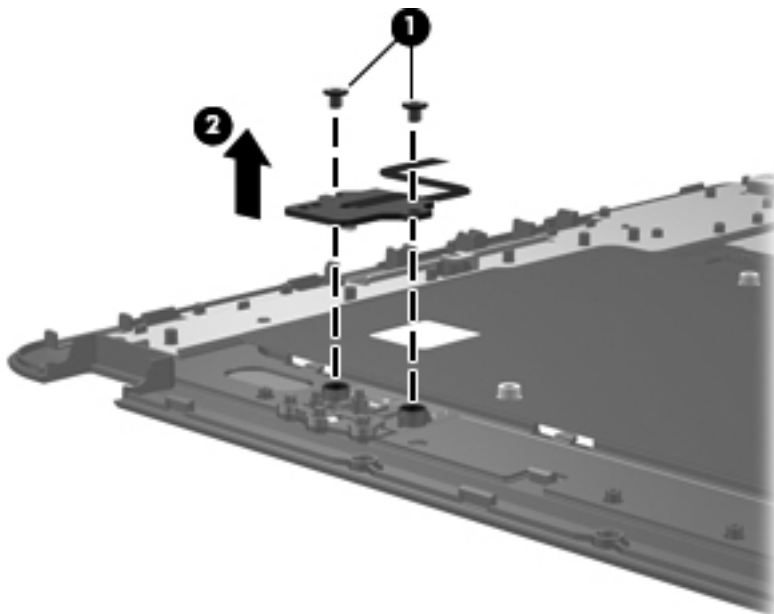

Reverse this procedure to install the power button board and cable.

TouchPad button board

Description	Spare part number
TouchPad button board (includes cable)	646130-001

Before removing the TouchPad button board, follow these steps:

1. Shut down the computer. If you are unsure whether the computer is off or in Hibernation, turn the computer on, and then shut it down through the operating system.
2. Disconnect all external devices connected to the computer.
3. Disconnect the power from the computer by first unplugging the power cord from the AC outlet and then unplugging the AC adapter from the computer.
4. Remove the battery (see [Battery on page 40](#)), and then remove the following components:
 - Optical drive (see [Optical drive \(select models only\) on page 41](#))
 - Keyboard (see [Keyboard on page 49](#))
 - Top cover (see [Top cover on page 52](#))

Remove the TouchPad button board and cable:

1. Turn the top cover upside down, with the top toward you.
2. Release the TouchPad board cable (1) and the TouchPad button board cable (2) from the top cover. (The TouchPad board cable and the TouchPad button board cable are attached to the top cover with double-sided tape.)
3. Remove the four Phillips PM2.0×4.0 screws (3) that secure the TouchPad button board to the top cover.
4. Remove the TouchPad button board (4) and cables from the top cover.

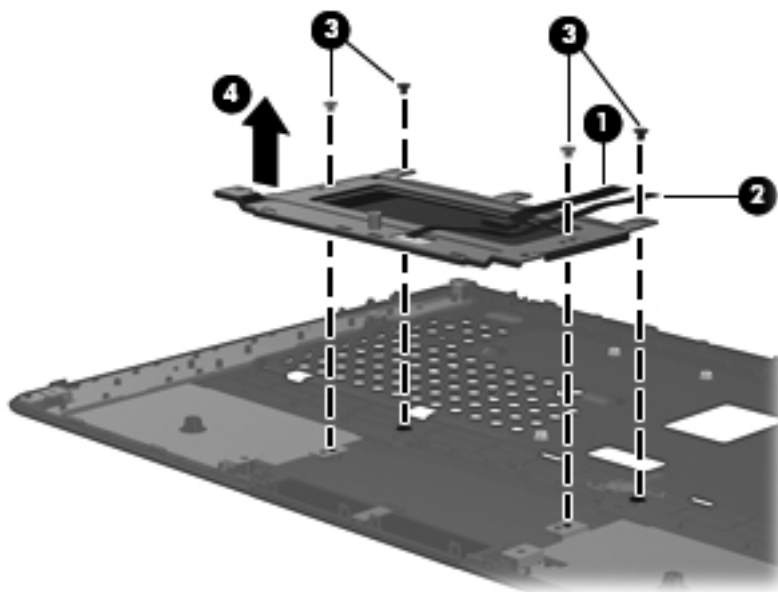

Reverse this procedure to install the TouchPad button board and cable.

USB board

Description	Spare part number
USB board (includes cable)	646128-001

Before removing the USB board, follow these steps:

1. Shut down the computer. If you are unsure whether the computer is off or in Hibernation, turn the computer on, and then shut it down through the operating system.
2. Disconnect all external devices connected to the computer.
3. Disconnect the power from the computer by first unplugging the power cord from the AC outlet and then unplugging the AC adapter from the computer.
4. Remove the battery (see [Battery on page 40](#)), and then remove the following components:
 - Optical drive (see [Optical drive \(select models only\) on page 41](#))
 - Keyboard (see [Keyboard on page 49](#))
 - Top cover (see [Top cover on page 52](#))

Remove the USB board:

1. Release the ZIF connector (1) to which the USB board cable is connected, and then disconnect the USB board cable (2) from the system board.
2. Remove the Phillips PM2.5×6.0 screw (2) that secures the USB board to the base enclosure.
3. Remove the USB board (3) and cable.

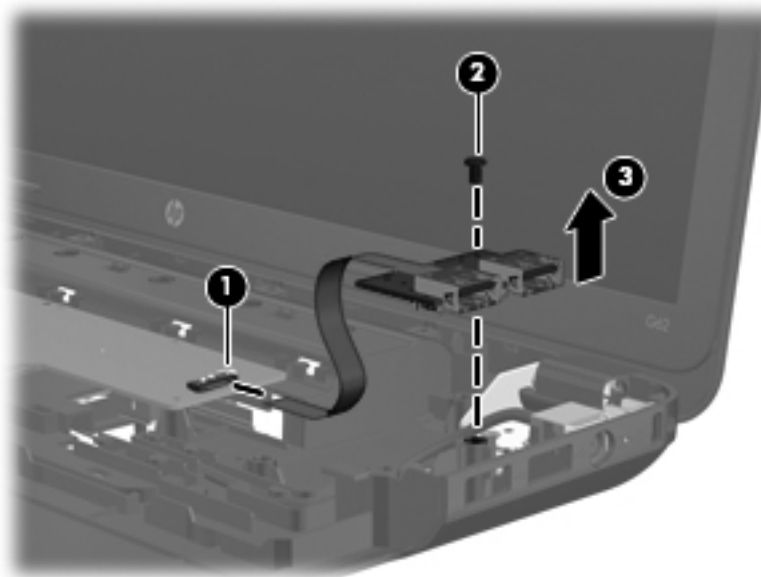

Reverse this procedure to install the USB board.

Power connector cable

Description	Spare part number
Power connector cable	641394-001

Before removing the power connector cable, follow these steps:

1. Shut down the computer. If you are unsure whether the computer is off or in Hibernation, turn the computer on, and then shut it down through the operating system.
2. Disconnect all external devices connected to the computer.
3. Disconnect the power from the computer by first unplugging the power cord from the AC outlet and then unplugging the AC adapter from the computer.
4. Remove the battery (see [Battery on page 40](#)), and then remove the following components:
 - Optical drive (see [Optical drive \(select models only\) on page 41](#))
 - Keyboard (see [Keyboard on page 49](#))
 - Top cover (see [Top cover on page 52](#))
 - USB board (see [USB board on page 59](#))

Remove the power connector cable:

1. Close the computer.
2. Turn the computer upside down, with the front toward you.
3. Disconnect the power connector cable **(1)** from the system board.
4. Release the power connector cable from the clips **(2)** built into the base enclosure.

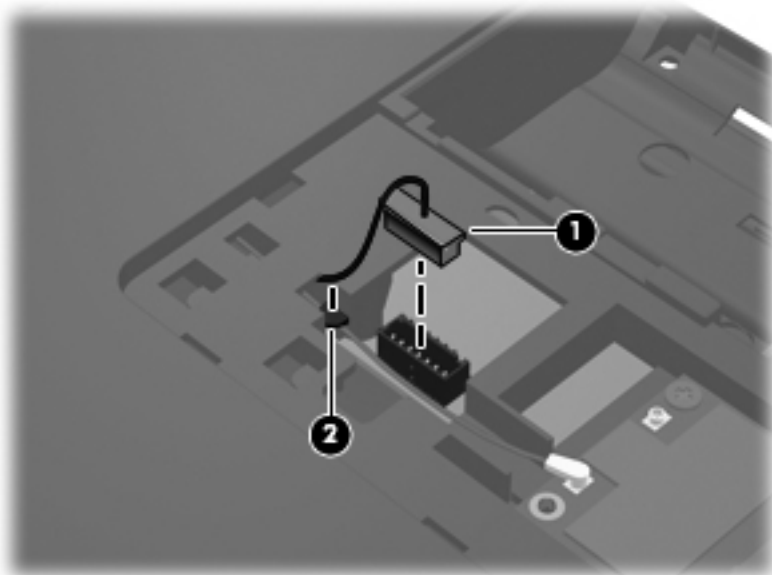

5. Turn the computer right-side up, with the front toward you.

6. Open the computer.
7. Remove the two Phillips PM2.5×6.0 screws (1) that secure the power connector and bracket to the computer.
8. Remove the power connector bracket (2).
9. Remove the power connector (3).

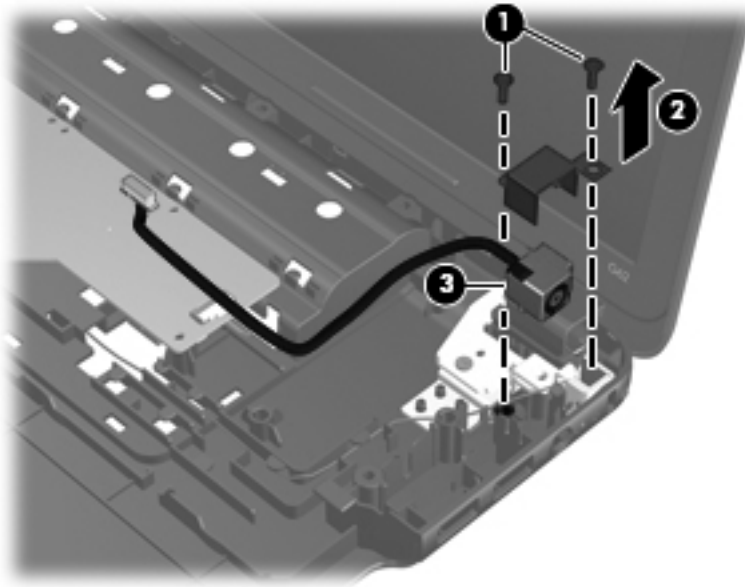

Reverse this procedure to install the power connector cable.

Speakers

Description	Spare part number
Speaker Kit (includes left and right speakers and cable)	647315-001

Before removing the speakers, follow these steps:

1. Shut down the computer. If you are unsure whether the computer is off or in Hibernation, turn the computer on, and then shut it down through the operating system.
2. Disconnect all external devices connected to the computer.
3. Disconnect the power from the computer by first unplugging the power cord from the AC outlet and then unplugging the AC adapter from the computer.
4. Remove the battery (see [Battery on page 40](#)), and then remove the following components:
 - Optical drive (see [Optical drive \(select models only\) on page 41](#))
 - Keyboard (see [Keyboard on page 49](#))
 - Top cover (see [Top cover on page 52](#))
 - USB board (see [USB board on page 59](#))

Remove the speakers:

1. Disconnect the speaker cable (1) from the system board.
2. Release the speaker cables (2) from the clips built into the base enclosure. Remove the Phillips PM2.5×9.0 screw (3) and the three Phillips PM2.5×6.0 screws (4) that secure the speakers to the computer. Remove the speakers (5).

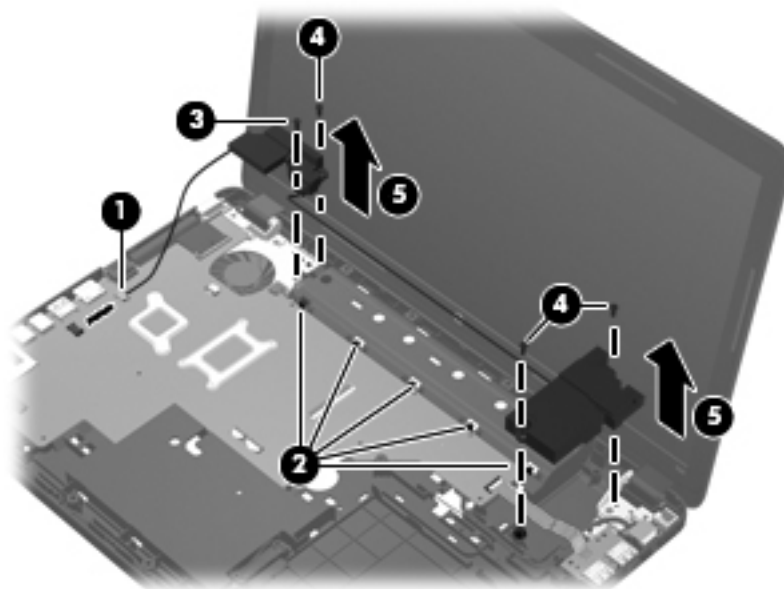

Reverse this procedure to install the speakers.

Optical drive connector cable

 **NOTE:** The optical drive connector cable is included in the Cable Kit, spare part number 646119-001.

Before removing the optical drive connector cable, follow these steps:

1. Shut down the computer. If you are unsure whether the computer is off or in Hibernation, turn the computer on, and then shut it down through the operating system.
2. Disconnect all external devices connected to the computer.
3. Disconnect the power from the computer by first unplugging the power cord from the AC outlet and then unplugging the AC adapter from the computer.
4. Remove the battery (see [Battery on page 40](#)), and then remove the following components:
 - Optical drive (see [Optical drive \(select models only\) on page 41](#))
 - Keyboard (see [Keyboard on page 49](#))
 - Top cover (see [Top cover on page 52](#))

Remove the optical drive connector cable:

1. Release the optical drive cable from the clips **(1)** built into the base enclosure.
2. Remove the two Phillips PM2.0×5.0 screws **(2)** that secure the optical drive connector to the base enclosure.
3. Remove the optical drive connector **(3)** from the base enclosure.

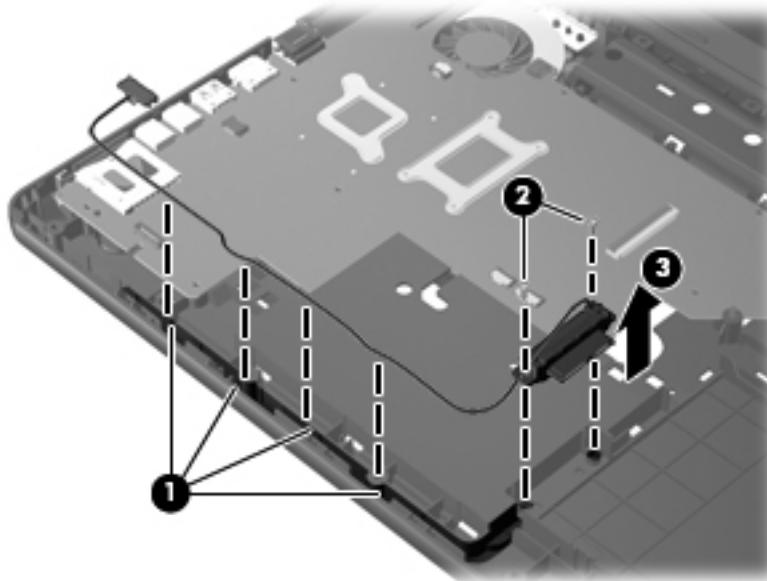

Reverse this procedure to install the optical drive connector cable.

Display assembly

Description	Spare part number
15.6-in, HD, LED, BrightView display assembly (includes microphone and wireless antenna transceivers and cables)	
Equipped with webcam	645095-001
Not equipped with webcam	645094-001

Before removing the display assembly, follow these steps:

1. Shut down the computer. If you are unsure whether the computer is off or in Hibernation, turn the computer on, and then shut it down through the operating system.
2. Disconnect all external devices connected to the computer.
3. Disconnect the power from the computer by first unplugging the power cord from the AC outlet and then unplugging the AC adapter from the computer.
4. Remove the battery (see [Battery on page 40](#)), and then remove the following components:
 - Optical drive (see [Optical drive \(select models only\) on page 41](#))
 - WLAN module (see [WLAN module on page 43](#))
 - Keyboard (see [Keyboard on page 49](#))
 - Top cover (see [Top cover on page 52](#))
 - USB board (see [USB board on page 59](#))
 - Power connector cable (see [Power connector cable on page 60](#))

Remove the display assembly:

1. Disconnect the display panel cable **(1)** from the system board.
2. Release the wireless antenna cables from the clips **(2)** built into the base enclosure.

 **CAUTION:** Support the display assembly when removing the following screws. Failure to support the display assembly can result in damage to the display assembly and other computer components.

3. Remove the four Phillips PM2.5×6.0 screws **(3)** that secure the display assembly to the computer.

4. Remove the display assembly (4).

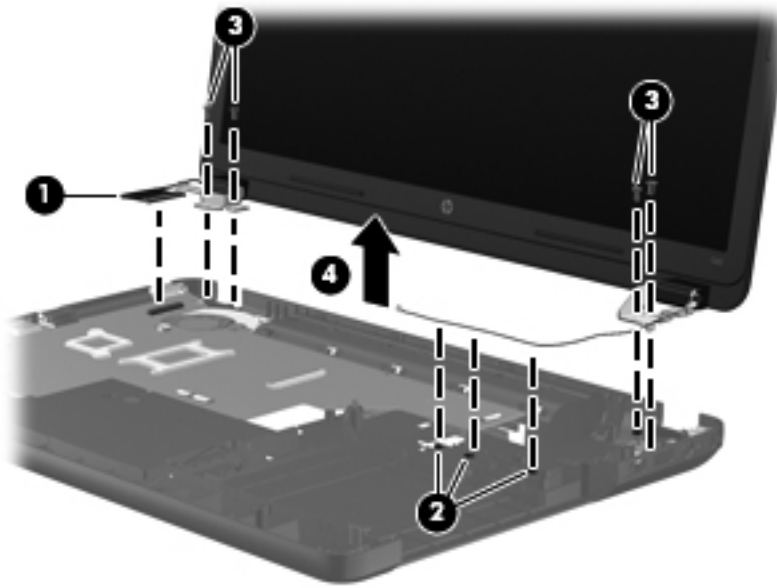

5. If it is necessary to replace the display bezel or any of the display assembly subcomponents:
- Remove the two Mylar screw covers (1) and the two Phillips PM2.5×4.0 screws (2) that secure the display bezel to the display assembly. The Mylar screw covers are available in the Display Screw Kit, spare part number 646134-001.

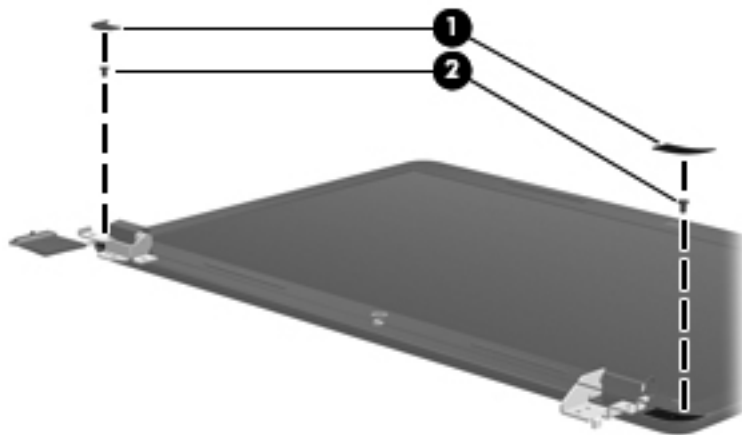

- Flex the inside edges of the top edge (1), the left and right sides (2), and the bottom edge (3) of the display bezel until the bezel disengages from the display enclosure.
- Remove the display bezel (4). The display bezel is available using the following spare part numbers:
 - 646117-001 — For use with computer models equipped with a webcam and a microphone
 - 646118-001 — For use with computer models equipped only with a microphone

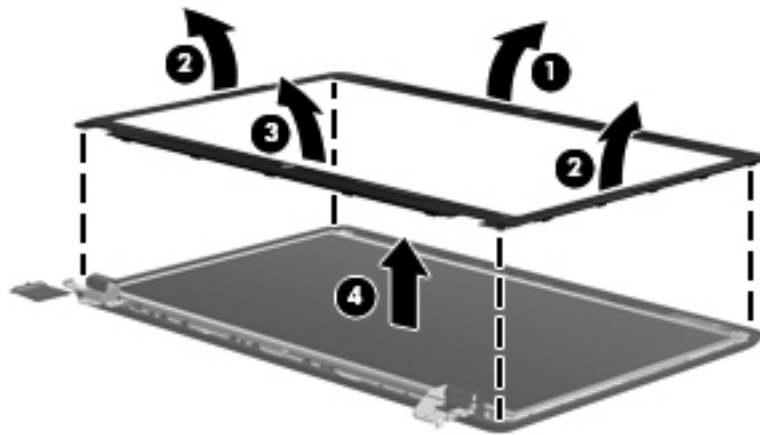

6. If it is necessary to replace the webcam/microphone module or microphone module:
 - a. Detach and release the module (1) as far as the module cable allows. (The module is attached to the display enclosure with double-sided tape.)
 - b. Disconnect the module cable (2) from the module.
 - c. Remove the webcam/microphone module (3) or microphone module. The webcam/microphone module is available using spare part number 646138-001. The microphone module is available using spare part number 645980-001.

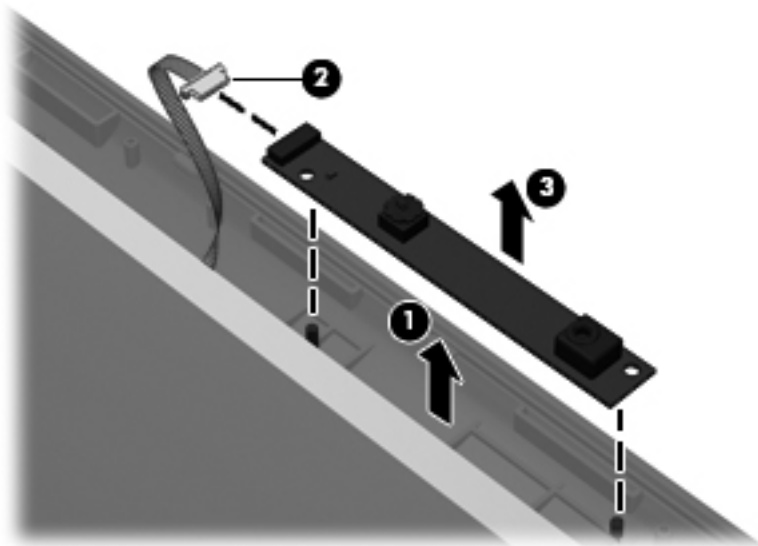

7. If it is necessary to replace the hinge covers:
 - a. Remove the two Phillips PM2.5x5.0 (1) screws that secure the hinge covers to the display enclosure.

- b. Remove the hinge covers (2). The hinge covers are available using spare part number 646124-001.

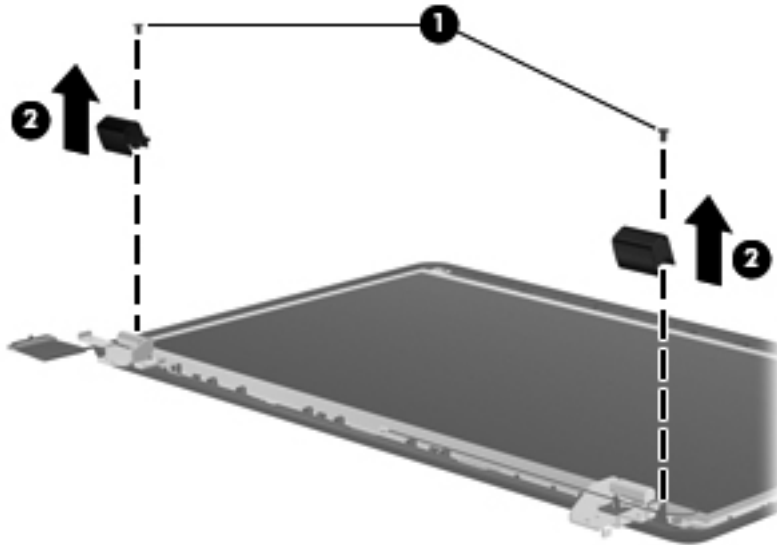

8. If it is necessary to replace the display panel:

- a. Remove the two Phillips PM2.5×4.0 screws (1) and four Phillips PM2.5×5.0 screws (2) that secure the display panel to the display enclosure.

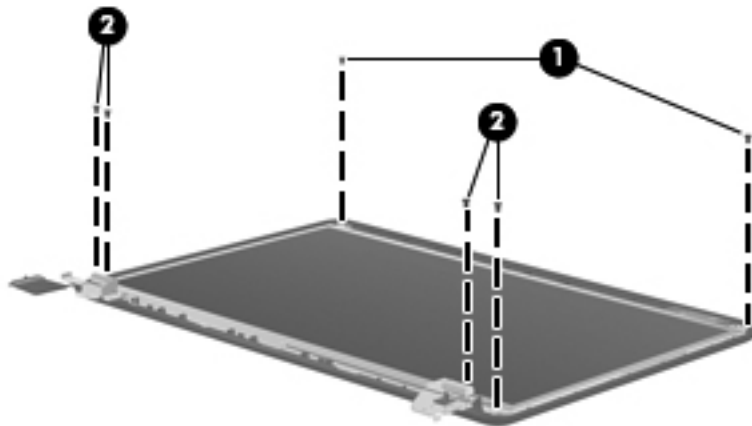

- b. Remove the display hinges (2). The display hinges include the display hinges and brackets and are available using spare part number 646123-001.

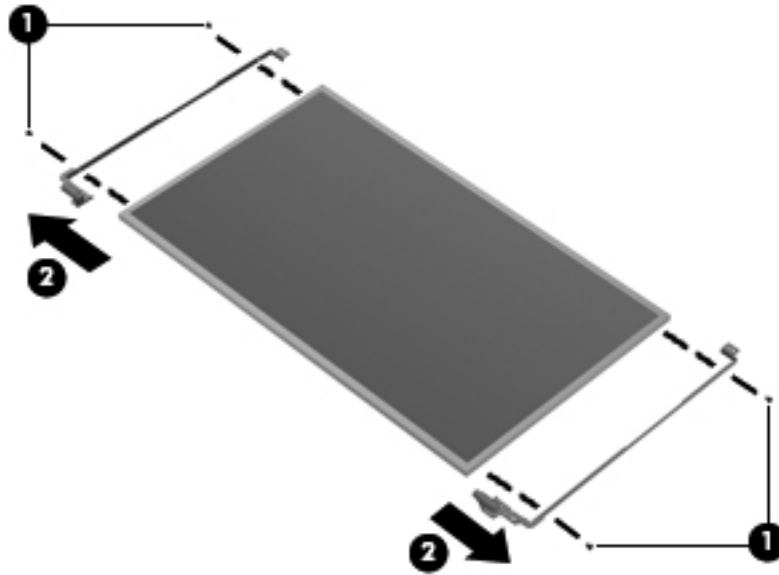

10. If it is necessary to replace the display panel cable:

- Release the tabs (1) built into the display enclosure shielding that secure the display panel cable to the display enclosure.
- Release the display panel cable from the clips (2) built into the display enclosure.
- Remove the display panel cable (3). The display panel cable includes the webcam/microphone module cable and is available in the Display Cable Kit, spare part number 646120-001.

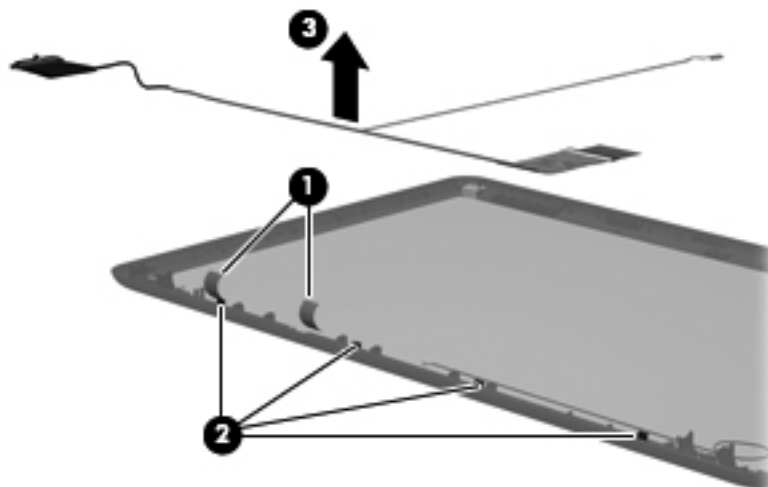

11. If it is necessary to replace the wireless antenna cable and transceiver:

- Release the wireless antenna transceiver (1) from the display enclosure. (The wireless antenna transceiver is attached to the display enclosure with double-sided tape.)
- Release the wireless antenna cable from the clips (2) built into the display enclosure.

- c. Remove the wireless antenna cable and transceiver (3). The wireless antenna cable and transceiver are available in the Antenna Kit, spare part number 646111-001.

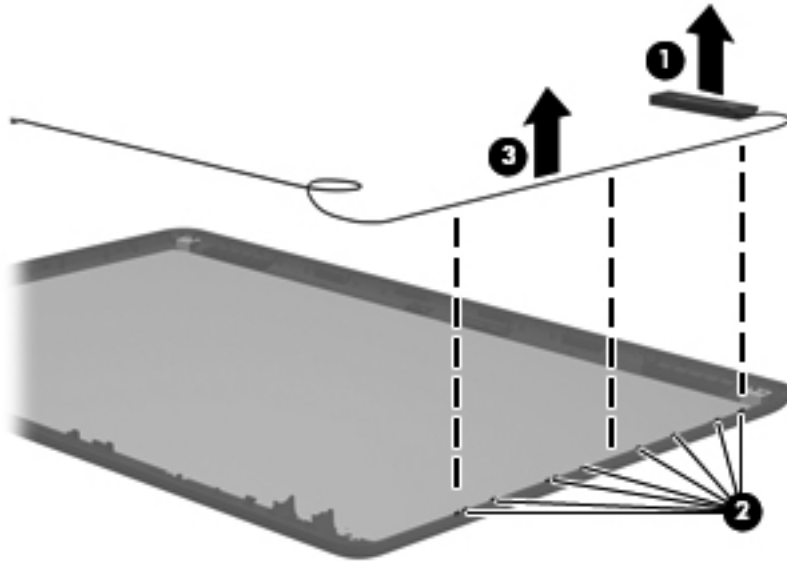

Reverse this procedure to reassemble and install the display assembly.

System board



NOTE: The system board spare part kit includes replacement thermal material. Replacement thermal material is also available in the Thermal Material Kit, spare part numbers 650277-001 (for use only with computer models equipped with an AMD processor) and 646135-001 (for use only with computer models equipped with an Intel processor).

Description	Spare part number
For use only with computer models equipped with an AMD E450 1.65-GHz processor (dual core, 18 W) and a graphics subsystem with UMA video memory	657323-001
For use only with computer models equipped with an AMD E350 1.60-GHz processor (dual core, 18 W) and a graphics subsystem with UMA video memory (for use only with computer models in the United States)	647320-001
For use only with computer models equipped with an AMD E300 1.30-GHz processor (dual core, 18 W) and a graphics subsystem with UMA video memory	657324-001
For use only with computer models equipped with an AMD E240 1.50-GHz processor (dual core, 18 W) and a graphics subsystem with UMA video memory (for use only with computer models in the United States)	647322-001
For use only with computer models equipped with an AMD C50 1.00-GHz processor (1.0-MB L2 cache, dual core, 9 W) and a graphics subsystem with UMA video memory (for use only with computer models in the United States)	653985-001
For use only with computer models equipped with an Intel Core i5 or i3 processor and a graphics subsystem with discrete video memory	646179-001
For use only with computer models equipped with an Intel Core i5 or i3 processor and a graphics subsystem with UMA video memory	646177-001
For use only with computer models equipped with an Intel Pentium processor and a graphics subsystem with discrete video memory	646176-001
For use only with computer models equipped with an Intel Pentium processor and a graphics subsystem with UMA video memory	646175-001
For use only with computer models equipped with an Intel Celeron processor	646174-001

Before removing the system board, follow these steps:

1. Shut down the computer. If you are unsure whether the computer is off or in Hibernation, turn the computer on, and then shut it down through the operating system.
2. Disconnect all external devices connected to the computer.
3. Disconnect the power from the computer by first unplugging the power cord from the AC outlet and then unplugging the AC adapter from the computer.
4. Remove the battery (see [Battery on page 40](#)).
5. Remove the optical drive (see [Optical drive \(select models only\) on page 41](#)).
6. Remove the WLAN module (see [WLAN module on page 43](#)).

7. Disconnect the hard drive connector cable from the system board (see [Hard drive on page 46](#)).
8. Remove the following components:
 - Keyboard (see [Keyboard on page 49](#))
 - Top cover (see [Top cover on page 52](#))
 - USB board (see [USB board on page 59](#))
 - Power connector cable (see [Power connector cable on page 60](#))
 - Display assembly (see [Display assembly on page 64](#))

When replacing the system board, be sure that the following components are removed from the defective system board and installed on the replacement system board:

- Memory module (see [Memory module on page 45](#))
- RTC battery (see [RTC battery on page 74](#))
- Fan and heat sink (see [Fan/heat sink assembly on page 76](#))
- Processor (see [Processor on page 82](#))

Remove the system board:

1. Disconnect the optical drive connector cable from the system board.

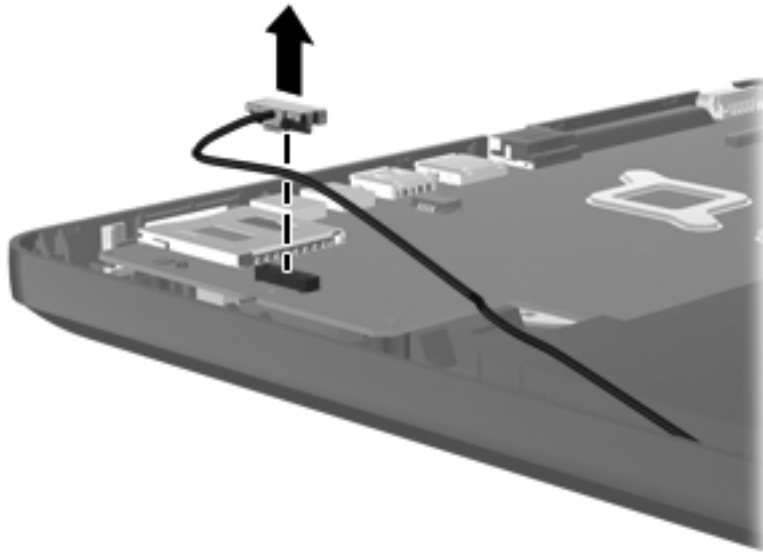

2. Remove the Phillips PM2.5×6.0 screw **(1)** that secures the system board to the base enclosure.
3. Lift the right side of the system board **(2)** until it rests at an angle.

4. Remove the system board (3) by sliding it up and to the right at an angle.

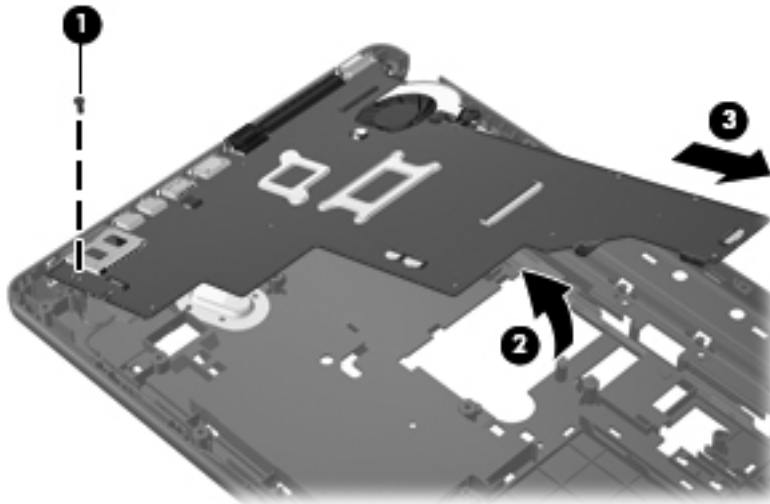

NOTE: A heat sink is attached to the base enclosure to service a component on the bottom of the system board. The thermal material must be thoroughly cleaned from the surfaces of the system board (1) and the heat sink (2) attached to the base enclosure each time the system board is removed. Replacement thermal material is included with all base enclosure and system board spare part kits.

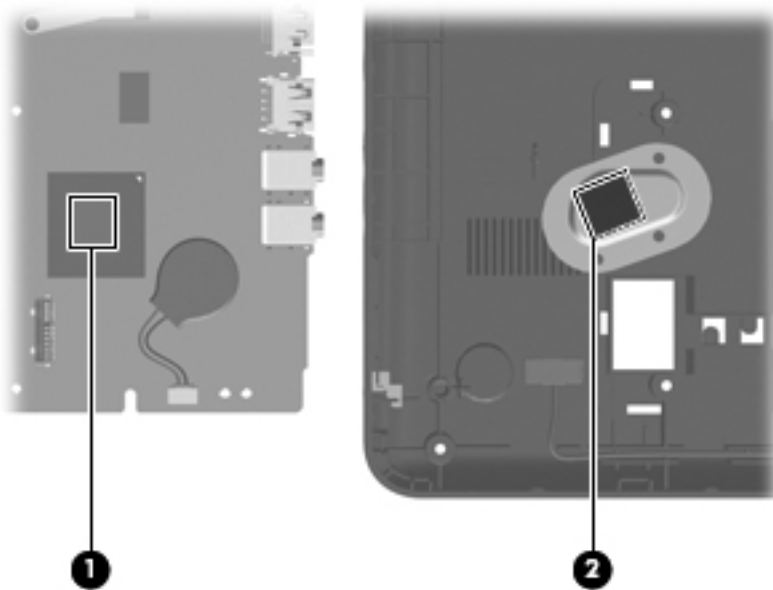

Reverse this procedure to install the system board.

RTC battery

Description	Spare part number
RTC battery (includes cable and double-sided tape)	646132-001

Before removing the RTC battery, follow these steps:

1. Shut down the computer. If you are unsure whether the computer is off or in Hibernation, turn the computer on, and then shut it down through the operating system.
2. Disconnect all external devices connected to the computer.
3. Disconnect the power from the computer by first unplugging the power cord from the AC outlet and then unplugging the AC adapter from the computer.
4. Remove the battery (see [Battery on page 40](#)), and then remove the following components:
 - Optical drive (see [Optical drive \(select models only\) on page 41](#))
 - WLAN module (see [WLAN module on page 43](#))
 - Keyboard (see [Keyboard on page 49](#))
 - Top cover (see [Top cover on page 52](#))
 - USB board (see [USB board on page 59](#))
 - Power connector cable (see [Power connector cable on page 60](#))
 - Display assembly (see [Display assembly on page 64](#))
 - System board (see [System board on page 71](#))

Remove the RTC battery:

1. Turn the system board upside down, with the front toward you.
2. Disconnect the RTC battery cable **(1)** from the system board.

3. Detach the RTC battery (2) from the system board. (The RTC battery is attached to the system board with double-sided tape.)

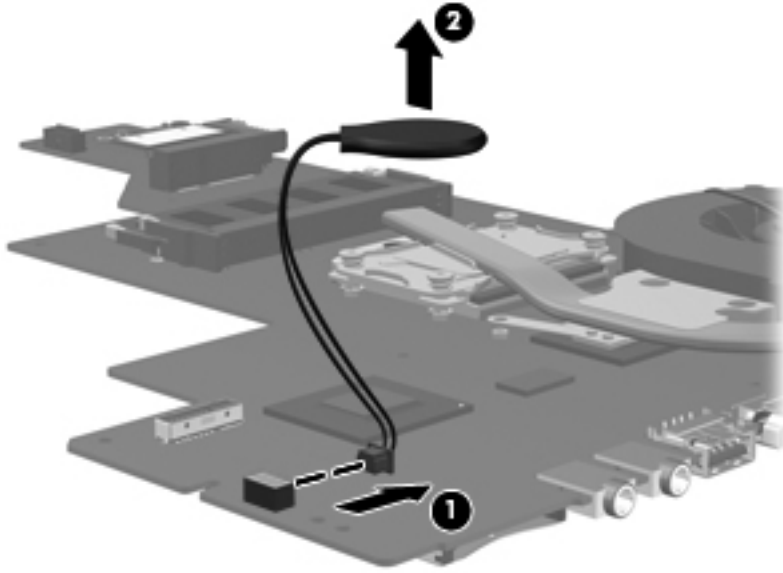

4. Remove the RTC battery.

Reverse this procedure to install the RTC battery.

Fan/heat sink assembly

 **NOTE:** The fan/heat sink assembly spare part kit includes replacement thermal material. Replacement thermal material is also available in the Thermal Material Kit, spare part numbers 650277-001 (for use only with computer models equipped with an AMD processor) and 646135-001 (for use only with computer models equipped with an Intel processor).

Description	Spare part number
For use only with computer models equipped with an AMD processor	647316-001
For use only with computer models equipped with an Intel Core i5 or i3 processor and a graphics subsystem with discrete video memory	646182-001
For use only with computer models equipped with an Intel Core i5 or i3 processor and a graphics subsystem with UMA video memory	646183-001
For use only with computer models equipped with an Intel Pentium processor and a graphics subsystem with discrete video memory	646180-001
For use only with computer models equipped with an Intel Pentium processor and a graphics subsystem with UMA video memory	646181-001
For use only with computer models equipped with an Intel Celeron processor and a graphics subsystem with UMA video memory	646184-001

 **NOTE:** To properly ventilate the computer, allow at least 7.6 cm (3 in) of clearance on the left side of the computer. The computer uses an electric fan for ventilation. The fan is controlled by a temperature sensor and is designed to turn on automatically when high temperature conditions exist. These conditions are affected by high external temperatures, system power consumption, power management/battery conservation configurations, battery fast charging, and software requirements. Exhaust air is displaced through the ventilation grill located on the left side of the computer.

Before removing the fan/heat sink assembly, follow these steps:

1. Shut down the computer. If you are unsure whether the computer is off or in Hibernation, turn the computer on, and then shut it down through the operating system.
2. Disconnect all external devices connected to the computer.
3. Disconnect the power from the computer by first unplugging the power cord from the AC outlet and then unplugging the AC adapter from the computer.
4. Remove the battery (see [Battery on page 40](#)), and then remove the following components:
 - Optical drive (see [Optical drive \(select models only\) on page 41](#))
 - WLAN module (see [WLAN module on page 43](#))
 - Keyboard (see [Keyboard on page 49](#))
 - Top cover (see [Top cover on page 52](#))
 - USB board (see [USB board on page 59](#))
 - Power connector cable (see [Power connector cable on page 60](#))
 - Display assembly (see [Display assembly on page 64](#))
 - System board (see [System board on page 71](#))

Remove the fan/heat sink assembly:

1. Disconnect the fan cable from the system board.

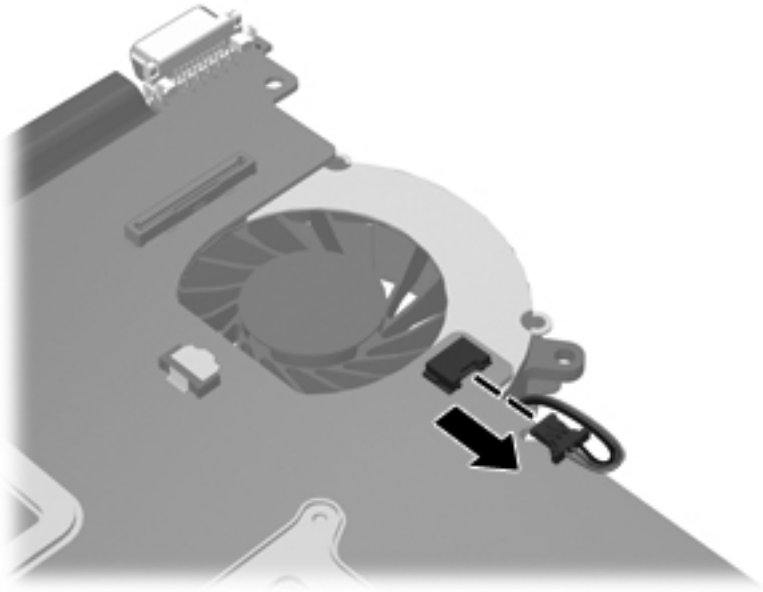

2. Turn the system board upside down, with the front toward you.
3. Loosen the captive screws **(1)** that secure the fan/heat sink assembly to the system board.

 **NOTE:** The number of screws used to secure the fan/heat sink assembly to the system board varies by computer model.

 **NOTE:** Due to the adhesive quality of the thermal material located between the heat sink and system board components, it may be necessary to move the heat sink from side to side to detach it.

4. Remove the fan and heat sink **(2)**.

 **NOTE:** The following illustration shows the fan/heat sink assembly removal process on a computer model equipped with an AMD processor.

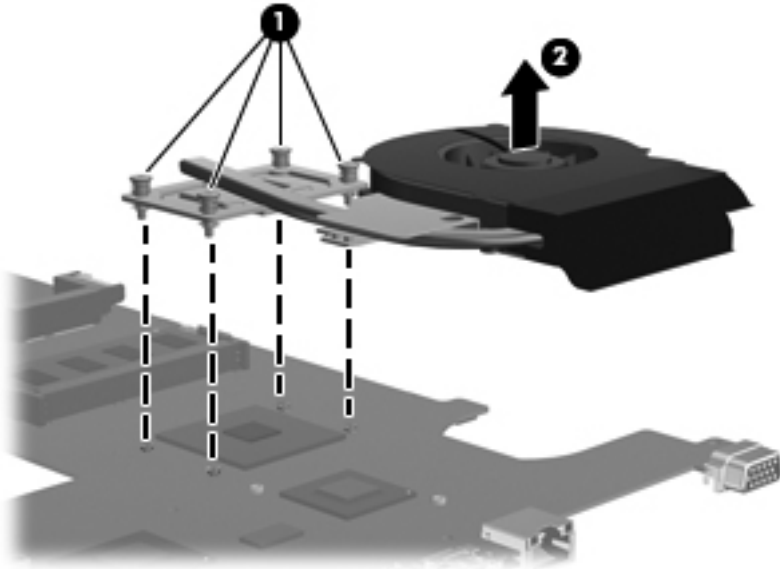

 **NOTE:** The following illustration shows the fan/heat sink assembly removal process on a computer model equipped with an Intel processor, the Intel HM65 or HM55 chipset, and a graphics subsystem with discrete memory.

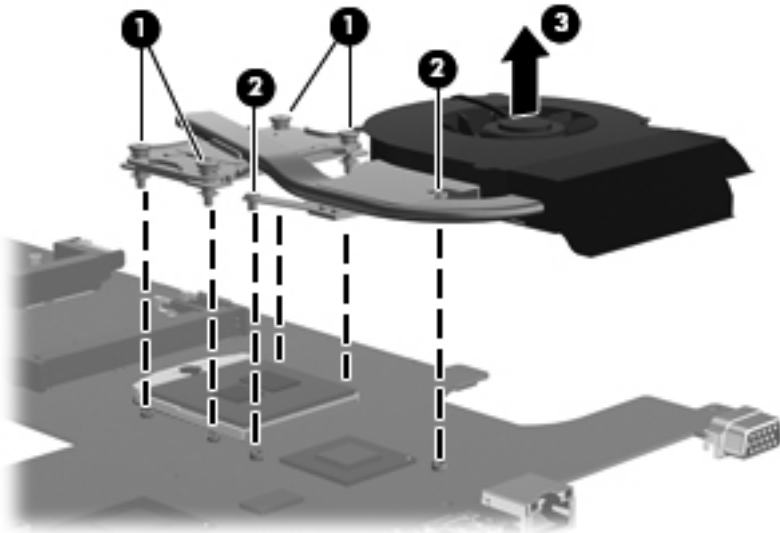

 **NOTE:** The following illustration shows the fan/heat sink assembly removal process on a computer model equipped with an Intel processor, the Intel HM65 or HM55 chipset, and a graphics subsystem with UMA memory.

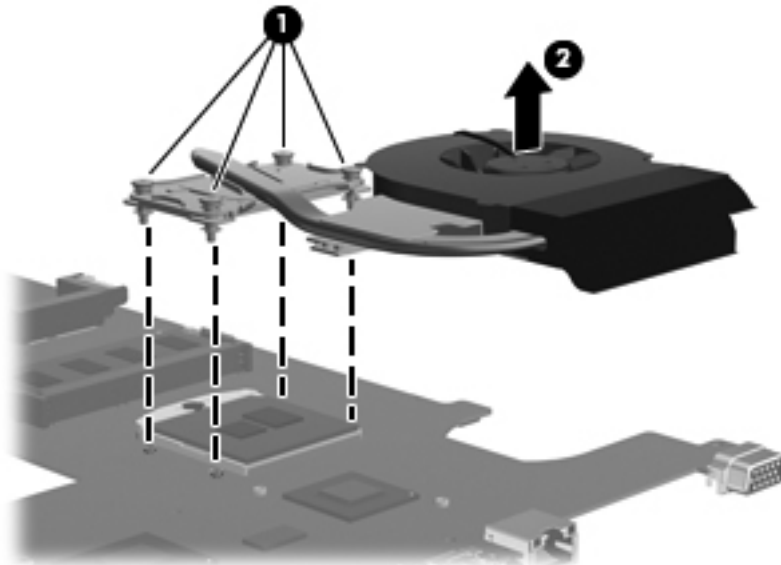

 **NOTE:** The following illustration shows the fan/heat sink assembly removal process on a computer model equipped with an Intel processor, the Intel HM45 chipset, and a graphics subsystem with UMA memory.

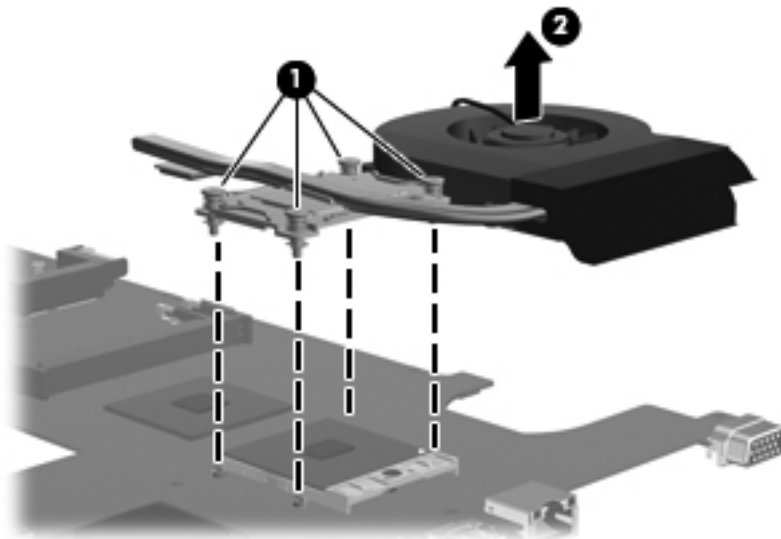

The thermal material must be thoroughly cleaned from the surfaces of the heat sink and the system board components each time the heat sink is removed. Replacement thermal material is included with the base enclosure, fan/heat sink assembly, processor, and system board spare part kits. Replacement thermal material is also available in the Thermal Material Kit, spare part numbers 650277-001 (for use only with computer models equipped with an AMD processor) and 646135-001 (for use only with computer models equipped with an Intel processor).

 **NOTE:** The following illustration shows the replacement thermal material locations on a computer model equipped with an AMD processor.

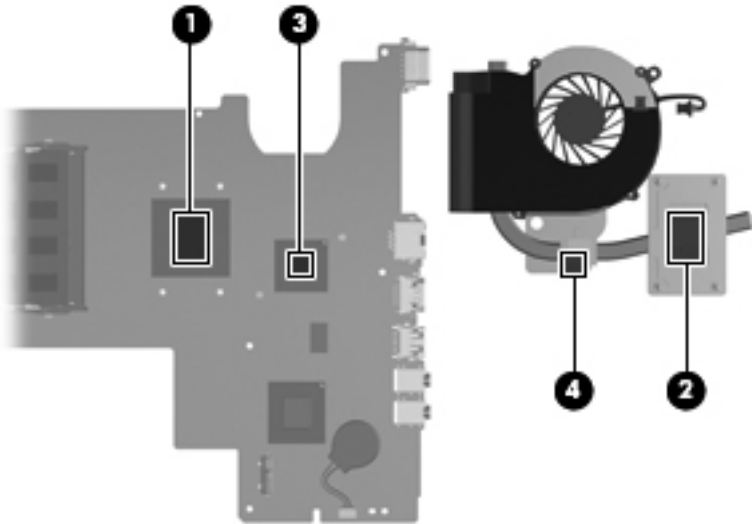

- Thermal paste is used on the processor (1) and the heat sink section (2) that services it
- A thermal pad is used on the Northbridge chip (3) and the heat sink section (4) that services it

 **NOTE:** The following illustration shows the replacement thermal material locations on a computer model equipped with an Intel Pentium processor and a graphics subsystem with discrete memory.

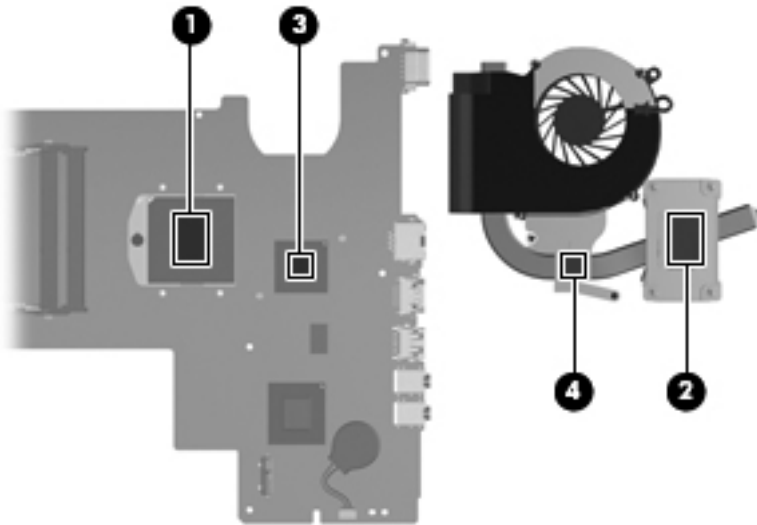

- Thermal paste is used on the processor (1) and the heat sink section (2) that services it
- A thermal pad is used on the graphics subsystem chip (3) and the heat sink section (4) that services it

 **NOTE:** The following illustration shows the replacement thermal material locations on a computer model equipped with an Intel Pentium processor and a graphics subsystem with UMA memory.

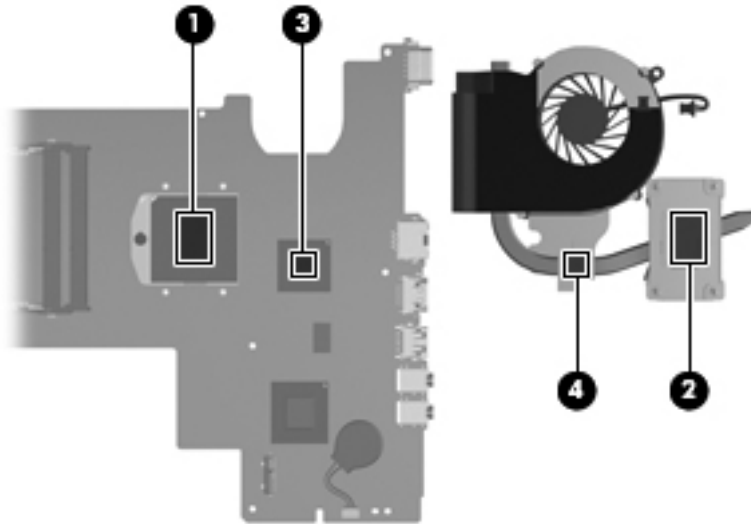

- Thermal paste is used on the processor (1) and the heat sink section (2) that services it
- A thermal pad is used on the Northbridge chip (3) and the heat sink section (4) that services it

 **NOTE:** The following illustration shows the replacement thermal material locations on a computer model equipped with an Intel Celeron processor.

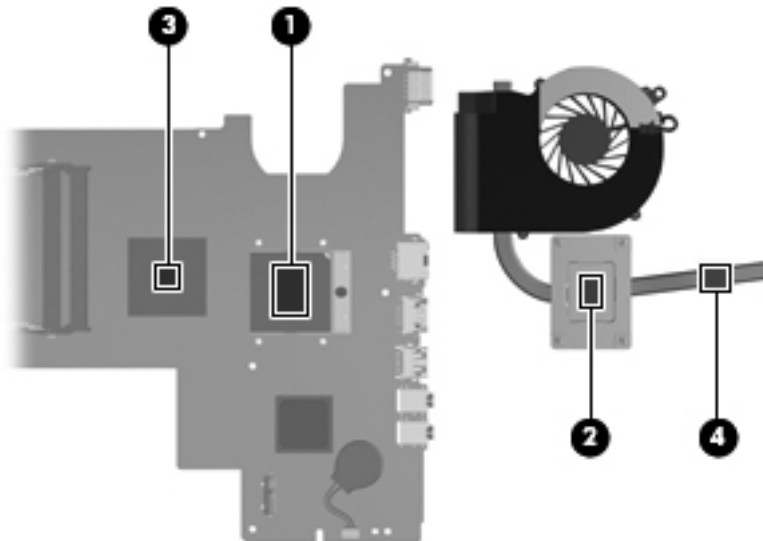

- Thermal paste is used on the processor (1) and the heat sink section (2) that services it
- A thermal pad is used on the Northbridge chip (3) and the heat sink section (4) that services it

Reverse this procedure to reassemble and install the fan/heat sink assembly.

Processor

 **NOTE:** This section applies only to computer models equipped with an Intel processor.

 **NOTE:** The processor spare part kit includes replacement thermal material. Replacement thermal material is also available in the Thermal Material Kit, spare part numbers 650277-001 (for use only with computer models equipped with an AMD processor) and 646135-001 (for use only with computer models equipped with an Intel processor).

Description	Spare part number
Intel Core i5-2450M 2.50-GHz processor (1333-MHz FSB, 3.0-MB L3 cache, dual core, 35 W; not supported on computer models equipped with Windows 7 Starter 32-bit operating system)	676359-001
Intel Core i5-2430M 2.40-GHz processor (1333-MHz FSB, 3.0-MB L3 cache, dual core, 35 W; not supported on computer models equipped with Windows 7 Starter 32-bit operating system)	653341-001
Intel Core i3-2350M 2.30-GHz processor (1333-MHz FSB, 3.0-MB L3 cache, dual core, 35 W; not supported on computer models equipped with Windows 7 Starter 32-bit operating system)	653340-001
Intel Core i3-2330M 2.20-GHz processor (1333-MHz FSB, 3.0-MB L3 cache, dual core, 35 W; not supported on computer models equipped with Windows 7 Starter 32-bit operating system)	653339-001
Intel Core i3-380M 2.53-GHz processor (1066-MHz FSB, 3.0-MB L3 cache, dual core, 35 W; not supported on computer models equipped with Windows 7 Starter 32-bit operating system)	625823-001
Intel Core i3-370M 2.40-GHz processor (1066-MHz FSB, 3.0-MB L3 cache, dual core, 35 W; not supported on computer models equipped with Windows 7 Starter 32-bit operating system)	613584-001
Intel Pentium P6300 2.26-GHz processor (3.0-MB L3 cache, dual core, 35 W)	635500-001
Intel Pentium P6200 2.13-GHz processor (3.0-MB L3 cache, dual core, 35 W)	625831-001
Intel Pentium B970 2.20-GHz processor (2.3-MB L2 cache, dual core, 35 W; not supported on computer models equipped with Windows 7 Starter 32-bit operating system)	676785-001
Intel Pentium B960 2.20-GHz processor (2.0-MB L2 cache, dual core, TJ85, 35 W; not supported on computer models equipped with Windows 7 Starter 32-bit operating system)	664662-001
Intel Pentium B950 2.10-GHz processor (2.0-MB L2 cache, dual core, TJ85, 35 W; not supported on computer models equipped with Windows 7 Starter 32-bit operating system)	653338-001
Intel Pentium B940 2.00-GHz processor (2.0-MB L2 cache, dual core, TJ85, 35 W; not supported on computer models equipped with Windows 7 Starter 32-bit operating system)	653337-001
Intel Celeron B815 1.60-GHz processor (2.0-MB L3 cache, dual core, 35 W)	677153-001
Intel Celeron B800 1.50-GHz processor (2.0-MB L3 cache, dual core, 35 W)	664661-001
Intel Celeron B710 1.50-GHz processor (1.0-MB L3 cache, single core, 35 W)	664660-001
Intel Celeron DC T3500 2.10-GHz processor (1.0-MB L2 cache, 800-MHz FSB)	625830-001
Intel Celeron DC T3300 2.00-GHz processor (1.0-MB L2 cache, 800-MHz FSB)	592399-001
Intel Celeron SC C925 2.30-GHz processor (1.0-MB L2 cache, 800-MHz FSB)	636636-001
Intel Celeron SC C900 2.20-GHz processor (1.0-MB L2 cache, 800-MHz FSB)	534419-001

Before removing the processor, follow these steps:

1. Shut down the computer. If you are unsure whether the computer is off or in Hibernation, turn the computer on, and then shut it down through the operating system.
2. Disconnect all external devices connected to the computer.
3. Disconnect the power from the computer by first unplugging the power cord from the AC outlet and then unplugging the AC adapter from the computer.
4. Remove the battery (see [Battery on page 40](#)), and then remove the following components:
 - Optical drive (see [Optical drive \(select models only\) on page 41](#))
 - Hard drive (see [Hard drive on page 46](#))
 - WLAN module (see [WLAN module on page 43](#))
 - Keyboard (see [Keyboard on page 49](#))
 - Top cover (see [Top cover on page 52](#))
 - System board (see [System board on page 71](#))
 - Fan and heat sink (see [Fan/heat sink assembly on page 76](#))

Remove the processor:

1. Use a flat-bladed screw driver to turn the processor locking screw one-half turn counterclockwise (1), until you hear a click.
2. Lift the processor (2) straight up, and then remove it.

 **NOTE:** The gold triangle (3) on the processor must be aligned with the triangle icon (4) embossed on the processor socket when you install the processor.

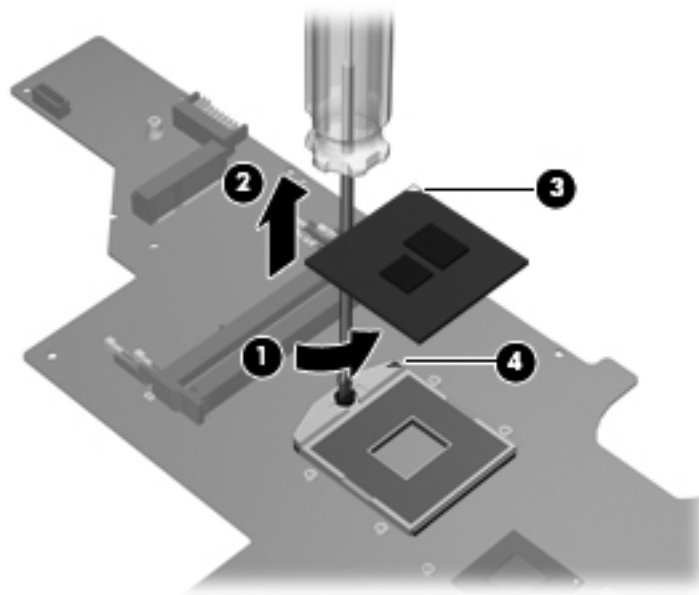

Reverse this procedure to install the processor.

5 Setup Utility (BIOS) and System Diagnostics

Using Setup Utility

Setup Utility, or Basic Input/Output System (BIOS), controls communication between all the input and output devices on the system (such as disk drives, display, keyboard, mouse, and printer). Setup Utility includes settings for the types of peripherals installed, the startup sequence of the computer, and the amount of system and extended memory.

 **NOTE:** Use extreme care when making changes in Setup Utility. Errors can prevent the computer from operating properly.

Starting Setup Utility

 **NOTE:** An external keyboard or mouse connected to a USB port can be used with Setup Utility only if USB legacy support is enabled.

To start Setup Utility, follow these steps:

1. Turn on or restart the computer, and then press **esc** while the “Press the ESC key for Startup Menu” message is displayed at the bottom of the screen.
2. Press **f10** to enter Setup Utility.

Changing the language of Setup Utility

1. Start Setup Utility.
2. Use the arrow keys to select **System Configuration > Language**, and then press **enter**.
3. Use the arrow keys to select a language, and then press **enter**.
4. When a confirmation prompt with your language selected is displayed, press **enter**.
5. To save your change and exit Setup Utility, use the arrow keys to select **Exit > Exit Saving Changes**, and then press **enter**.

Your change takes effect immediately.

Navigating and selecting in Setup Utility

To navigate and select in Setup Utility, follow these steps:

1. Turn on or restart the computer, and then press **esc** while the “Press the ESC key for Startup Menu” message is displayed at the bottom of the screen.
 - To select a menu or a menu item, use the tab key and the keyboard arrow keys and then press **enter**, or use a pointing device to click the item.
 - To scroll up and down, click the up arrow or the down arrow in the upper-right corner of the screen, or use the up arrow key or the down arrow key.
 - To close open dialog boxes and return to the main Setup Utility screen, press **esc**, and then follow the on-screen instructions.
2. Press **f10** to enter Setup Utility.

To exit Setup Utility menus, choose one of the following methods:

- To exit Setup Utility menus without saving your changes, press the **esc** key, and then follow the on-screen instructions.

– or –

Use the arrow keys to select **Exit > Exit Discarding Changes**, and then press **enter**.

- To save your changes and exit Setup Utility menus, press **f10**, and then follow the on-screen instructions.

– or –

Use the tab key and the arrow keys to select **Exit > Exit Saving Changes**, and then press **enter**.

Your changes go into effect when the computer restarts.

Displaying system information

1. Start Setup Utility.
2. Select the **Main** menu. System information such as the system time and date, and identification information about the computer is displayed.
3. To exit Setup Utility without changing any settings, use the arrow keys to select **Exit > Exit Discarding Changes**, and then press **enter**.

Restoring factory settings in Setup Utility

 **NOTE:** Restoring defaults will not change the hard drive mode.

To return all settings in Setup Utility to the values that were set at the factory, follow these steps:

1. Turn on or restart the computer, and then press **esc** while the “Press the ESC key for Startup Menu” message is displayed at the bottom of the screen.
2. Press **f10** to enter Setup Utility.
3. Use the arrow keys to select **Exit > Load Setup Defaults**.
4. Follow the on-screen instructions.
5. To save your changes and exit, press **f10**, and then follow the on-screen instructions.

– or –

Use the arrow keys to select **Exit > Exit Saving Changes**, and then press **enter**.

Your changes go into effect when the computer restarts.

 **NOTE:** Your password settings and security settings are not changed when you restore the factory settings.

Exiting Setup Utility

- To exit Setup Utility and save your changes from the current session:

If the Setup Utility menus are not visible, press **esc** to return to the menu display. Then use the arrow keys to select **Exit > Exit Saving Changes**, and then press **enter**.

- To exit Setup Utility without saving your changes from the current session:

If the Setup Utility menus are not visible, press **esc** to return to the menu display. Then use the arrow keys to select **Exit > Exit Discarding Changes**, and then press **enter**.

Updating the BIOS

Updated versions of the BIOS may be available on the HP Web site.

Most BIOS updates on the HP Web site are packaged in compressed files called *SoftPaqs*.

Some download packages contain a file named *Readme.txt*, which contains information regarding installing and troubleshooting the file.

Determining the BIOS version

To determine whether available BIOS updates contain later BIOS versions than those currently installed on the computer, you need to know the version of the system BIOS currently installed.

BIOS version information (also known as *ROM date* and *System BIOS*) can be displayed by pressing **fn+esc** (if you are already in Windows) or by using Setup Utility.

1. Start Setup Utility (BIOS).
2. Use the arrow keys to select **Main**.
3. To exit Setup Utility (BIOS) without saving your changes, use the tab key and the arrow keys to select **Exit > Exit Discarding Changes**, and then press **enter**.

Downloading a BIOS update

 **CAUTION:** To reduce the risk of damage to the computer or an unsuccessful installation, download and install a BIOS update only when the computer is connected to reliable external power using the AC adapter. Do not download or install a BIOS update while the computer is running on battery power, docked in an optional docking device, or connected to an optional power source. During the download and installation, follow these instructions:

Do not disconnect power from the computer by unplugging the power cord from the AC outlet.

Do not shut down the computer or initiate Sleep or Hibernation.

Do not insert, remove, connect, or disconnect any device, cable, or cord.

1. **Windows 7**—Select **Start > Help and Support > Maintain**.
Windows XP—Select **Start > Help and Support**, and then select the software and drivers update.
2. Follow the on-screen instructions to identify your computer and access the BIOS update you want to download.
3. At the download area, follow these steps:
 - a. Identify the BIOS update that is later than the BIOS version currently installed on your computer. Make a note of the date, name, or other identifier. You may need this information to locate the update later, after it has been downloaded to your hard drive.
 - b. Follow the on-screen instructions to download your selection to the hard drive. Make a note of the path to the location on your hard drive where the BIOS update is downloaded. You will need to access this path when you are ready to install the update.



NOTE: If you connect your computer to a network, consult the network administrator before installing any software updates, especially system BIOS updates.

BIOS installation procedures vary. Follow any instructions that are displayed on the screen after the download is complete. If no instructions are displayed, follow these steps:

1. **Windows 7**—Open Windows Explorer by selecting **Start > Computer**.
Windows XP—Open Windows Explorer by selecting **Start > My Computer**.
2. Double-click your hard drive designation. The hard drive designation is typically Local Disk (C:).

3. Using the hard drive path you recorded earlier, open the folder on your hard drive that contains the update.
4. Double-click the file that has an .exe extension (for example, *filename.exe*).
The BIOS installation begins.
5. Complete the installation by following the on-screen instructions.



NOTE: After a message on the screen reports a successful installation, you can delete the downloaded file from your hard drive.

Using System Diagnostics

System Diagnostics allows you to run diagnostic tests to determine if the computer hardware is functioning properly. The following diagnostic tests are available in System Diagnostics:

- **Start-up test**—This test analyzes the main computer components that are required to start the computer.
- **Run-in test**—This test repeats the start-up test and checks for intermittent problems that the start-up test does not detect.
- **Hard disk test**—This test analyzes the physical condition of the hard drive, and then checks all data in every sector of the hard drive. If the test detects a damaged sector, it attempts to move the data to a good sector.
- **Memory test**—This test analyzes the physical condition of the memory modules. If it reports an error, replace the memory modules immediately.
- **Battery test**—This test analyzes the condition of the battery. If the battery fails the test, contact HP support to report the issue and purchase a replacement battery.

You can also view system information and error logs in the System Diagnostics window.

To start System Diagnostics:

1. Turn on or restart the computer. While the “Press the ESC key for Startup Menu” message is displayed in the lower-left corner of the screen, press **esc**. When the Startup Menu is displayed, press **f2**.
2. Click the diagnostic test you want to run, and then follow the on-screen instructions.



NOTE: If you need to stop a diagnostics test while it is running, press **esc**.

6 Specifications

Computer specifications

	Metric	U.S.
Dimensions		
Depth	24.7 cm	9.7 in
Width	37.6 cm	14.8 in
Height (front to back)	3.1 to 3.6 cm	1.2 to 1.4 in
Weight		
	2.49 kg	5.49 lb
Input power		
Operating voltage	18.5 V dc @ 3.5 A - 65 W or 19.0 V dc @ 4.74 A - 90 W	
Operating current	3.5 A - 65 W or 4.74 A - 90 W	
Temperature		
Operating	5°C to 35°C	41°F to 95°F
Nonoperating	-20°C to 60°C	-4°F to 140°F
Relative humidity (noncondensing)		
Operating	10% to 90%	
Nonoperating	5% to 95%	
Maximum altitude (unpressurized)		
Operating	-15 m to 3,048 m	-50 ft to 10,000 ft
Nonoperating	-15 m to 12,192 m	-50 ft to 40,000 ft
NOTE: Applicable product safety standards specify thermal limits for plastic surfaces. The device operates well within this range of temperatures.		

15.6-inch display specifications

	Metric	U.S.
Dimensions		
Height	19.6 cm	7.72 in
Width	34.7 cm	13.66 in
Diagonal	39.8 cm	15.67 in
Number of colors	Up to 16.8 million	
Contrast ratio	200:1 (typical)	
Brightness	200 nits (typical)	
Pixel resolution		
Pitch	0.197 × 0.197 mm	
Format	1366 × 768	
Configuration	RGB vertical stripe	
Backlight	LED	
Character display	80 × 25	
Total power consumption	2.0 W	
Viewing angle	±65° horizontal, ±50° vertical (typical)	

Hard drive specifications

	500-GB*	320-GB*	250-GB*
Dimensions			
Height	9.5 mm	9.5 mm	7.0 mm
Length	100.4 mm	100.4 mm	100.4 mm
Width	69.9 mm	69.9 mm	69.9 mm
Weight	110 g	110 g	110 g
Interface type	SATA	SATA	SATA
Transfer rate			
Synchronous (maximum)	1.1 GB/sec	1.1 GB/sec	1.1 GB/sec
Security	ATA security	ATA security	ATA security
Seek times (typical read, including setting)			
Single track	1.5 ms	1.5 ms	1.5 ms
Average (read/write)	11/13 ms	11/13 ms	11/13 ms
Maximum	22 ms	22 ms	22 ms
Logical blocks	976,773,168	628,142,448	488,397,168
Disk rotational speed	5400 rpm	5400 rpm	5400 rpm
Operating temperature	0°C to 60°C (32°F to 140°F)		
*1 GB = 1 billion bytes when referring to hard drive storage capacity. Actual accessible capacity is less.			
NOTE: Certain restrictions and exclusions apply. Contact technical support for details.			

7 Backup and recovery

Your computer includes tools provided by the operating system and HP to help you safeguard your information and restore it if ever needed.

This chapter provides information on the following topics:

- Creating a set of recovery discs or a recovery flash drive (Recovery Manager software feature)
- Performing a system restore (from the partition, recovery discs, or a recovery flash drive)
- Backing up your information
- Recovering a program or driver

Restore

In the event of hard drive failure, to restore your system to its factory image you will need a set of recovery discs or a recovery flash drive that you can create using HP Recovery Manager. HP recommends that you use this software to create either a set of recovery discs or a recovery flash drive immediately after software setup.

If for some other reason you need to restore your system, this can be achieved using the HP Recovery partition (select models only), without the need for recovery discs or a recovery flash drive. To check for the presence of a recovery partition, click **Start**, right-click **Computer**, click **Manage**, and then click **Disk Management**. If the recovery partition is present, a Recovery drive is listed in the window.

 **CAUTION:** HP Recovery Manager (partition, or discs/flash drive) restores only software that was preinstalled at the factory. Software not provided with this computer must be reinstalled manually.

 **NOTE:** Recovery discs have been included if your computer does not have a recovery partition.

Creating restore media

HP recommends that you create either a set of recovery discs or a recovery flash drive to be sure that you can restore your computer to its original factory state if the hard drive fails, or if for any reason you cannot restore using the recovery partition tools. Create these discs or the flash drive after setting up the computer for the first time.

 **NOTE:** HP Recovery Manager allows the creation of only one set of recovery discs or one recovery flash drive. Handle these discs or flash drive carefully and keep them in a safe place.

 **NOTE:** If your computer does not include an integrated optical drive, you can use an optional external optical drive (purchased separately) to create recovery discs, or you can purchase recovery discs for your computer from the HP Web site. If you use an external optical drive, it must be connected directly to a USB port on the computer, not to a USB port on an external device, such as a USB hub.

Guidelines:

- Purchase high-quality DVD-R, DVD+R, DVD-R DL, or DVD+R DL discs.

 **NOTE:** Read-write discs, such as CD-RW, DVD±RW, and double-layer DVD±RW discs, are not compatible with the Recovery Manager software.

- The computer must be connected to AC power during this process.
- Only one set of recovery discs or one recovery flash drive can be created per computer.

 **NOTE:** If you are creating recovery discs, number each disc before inserting into the optical drive.

- If necessary, you can exit the program before you have finished creating the recovery discs or recovery flash drive. The next time you open Recovery Manager, you will be prompted to continue the backup creation process.

To create a set of recovery discs or a recovery flash drive:

1. Select **Start > All Programs > Recovery Manager > Recovery Media Creation**.
2. Follow the on-screen instructions.

Performing a system restore

Recovery Manager software allows you to repair or restore the computer to its original factory state. Recovery Manager works from recovery discs, a recovery flash drive, or from a dedicated recovery partition (select models only) on the hard drive.



NOTE: A system restore needs to be performed if the computer hard drive has failed or if all attempts to correct any functional computer issues fail. A system restore should be used as a final attempt to correct computer issues.

Note the following when performing a system restore:

- You can restore only the system that you have previously backed up. HP recommends that you use HP Recovery Manager to create either a set of recovery discs or a recovery flash drive as soon as you set up the computer.
- Windows has its own built-in repair features, such as System Restore. If you have not already tried these features, try them before using Recovery Manager.
- Recovery Manager restores only software that was preinstalled at the factory. Software not provided with this computer must be downloaded from the manufacturer's Web site or reinstalled from the disc provided by the manufacturer.

Restoring using the dedicated recovery partition (select models only)

When using the dedicated recovery partition, there is an option to back up pictures, music and other audio, videos and movies, recorded TV shows, documents, spreadsheets and presentations, e-mails, Internet favorites and settings during this process.

To restore the computer from the recovery partition, follow these steps:

1. Access Recovery Manager in either of the following ways:
 - Select **Start > All Programs > Recovery Manager > Recovery Manager**.
 - or –
 - Turn on or restart the computer, and then press **esc** while the “Press the ESC key for Startup Menu” message is displayed at the bottom of the screen. Then, press **f11** while the “F11 (System Recovery)” message is displayed on the screen.
2. Click **System Recovery** in the **Recovery Manager** window.
3. Follow the on-screen instructions.

Restoring using the restore media

1. If possible, back up all personal files.
2. Insert the first recovery disc into the optical drive on your computer or an optional external optical drive, and then restart the computer.

– or –

Insert the recovery flash drive into a USB port on your computer, and then restart the computer.



NOTE: If the computer does not automatically restart in the Recovery Manager, the computer boot order needs to be changed.

3. Press **f9** at system bootup.
4. Select the optical drive or the flash drive.
5. Follow the on-screen instructions.

Changing the computer boot order

To change the boot order for recovery discs:

1. Restart the computer.
2. Press **esc** while the computer is restarting, and then press **f9** for boot options.
3. Select **Internal CD/DVD ROM Drive** from the boot options window.

To change the boot order for recovery flash drive:

1. Insert the flash drive into a USB port.
2. Restart the computer.
3. Press **esc** while the computer is restarting, and then press **f9** for boot options.
4. Select the flash drive from the boot options window.

Backing up and recovering your information

It is very important to back up your files and keep any new software in a safe place. As you add new software and data files, continue to create backups on a regular basis.

How completely you are able to recover your system depends on how recent your backup is.



NOTE: A recovery from your most recent backup needs to be performed if the computer has a virus attack or if any major system components fail. In order to correct computer issues, a recovery should first be attempted before a system restore is attempted.

You can back up your information to an optional external hard drive, a network drive, or discs. Back up your system at the following times:

- At regularly scheduled times



TIP: Set reminders to back up your information periodically.

- Before the computer is repaired or restored
- Before you add or modify hardware or software

Guidelines:

- Create system restore points using the Windows System Restore feature, and periodically copy them to an optical disc or an external hard drive. For more information on using system restore points, refer to **Using Windows system restore points**.
- Store personal files in the Documents library and back up this folder periodically.
- Save customized settings in a window, toolbar, or menu bar by taking a screen shot of your settings. The screen shot can be a time-saver if you have to re-enter your preferences.

To create a screen shot:

1. Display the screen you want to save.
2. Copy the screen image:

To copy only the active window, press **alt+fn+prt sc**.

To copy the entire screen, press **fn+prt sc**.

3. Open a word-processing document, and then select **Edit > Paste**. The screen image is added to the document.
4. Save and print the document.

Using Windows Backup and Restore

Guidelines:

- Be sure that the computer is connected to AC power before you start the backup process.
- Allow enough time to complete the backup process. Depending on file sizes, it may take over an hour.

To create a backup:

1. Select **Start > Control Panel > System and Security > Backup and Restore**.
2. Follow the on-screen instructions to schedule and create a backup.



NOTE: Windows includes the User Account Control feature to improve the security of the computer. You may be prompted for your permission or password for tasks such as installing software, running utilities, or changing Windows settings. Refer to Help and Support for more information.

Using Windows system restore points

A system restore point allows you to save and name a snapshot of your hard drive at a specific point in time. You can then recover back to that point if you want to reverse subsequent changes.



NOTE: Recovering to an earlier restore point does not affect data files saved or e-mails created since the last restore point.

You also can create additional restore points to provide increased protection for your files and settings.

When to create restore points

- Before you add or modify software or hardware
- Periodically, whenever the computer is functioning optimally



NOTE: If you revert to a restore point and then change your mind, you can reverse the restoration.

Create a system restore point

1. Select **Start > Control Panel > System and Security > System**.
2. In the left pane, click **System Protection**.
3. Click the **System Protection** tab.
4. Follow the on-screen instructions.

Restore to a previous date and time

To revert to a restore point (created at a previous date and time), when the computer was functioning optimally, follow these steps:

1. Select **Start > Control Panel > System and Security > System**.
2. In the left pane, click **System Protection**.
3. Click the **System Protection** tab.
4. Click **System Restore**.
5. Follow the on-screen instructions.

8 Power cord set requirements

The wide-range input feature of the computer permits it to operate from any line voltage from 100 to 120 volts AC, or from 220 to 240 volts AC.

The 3-conductor power cord set included with the computer meets the requirements for use in the country or region where the equipment is purchased.

Power cord sets for use in other countries and regions must meet the requirements of the country or region where the computer is used.

Requirements for all countries

The following requirements are applicable to all countries and regions:

- The length of the power cord set must be at least **1.5 m** (5.0 ft) and no more than **2.0 m** (6.5 ft).
- All power cord sets must be approved by an acceptable accredited agency responsible for evaluation in the country or region where the power cord set will be used.
- The power cord sets must have a minimum current capacity of 10 amps and a nominal voltage rating of 125 or 250 V AC, as required by the power system of each country or region.
- The appliance coupler must meet the mechanical configuration of an EN 60 320/IEC 320 Standard Sheet C13 connector for mating with the appliance inlet on the back of the computer.

Requirements for specific countries and regions

Country/region	Accredited agency	Applicable note number
Australia	EANSW	1
Austria	OVE	1
Belgium	CEBC	1
Canada	CSA	2
Denmark	DEMKO	1
Finland	FIMKO	1
France	UTE	1
Germany	VDE	1
Italy	IMQ	1
Japan	METI	3
The Netherlands	KEMA	1
Norway	NEMKO	1
The People's Republic of China	COC	5
South Korea	EK	4
Sweden	SEMKO	1
Switzerland	SEV	1
Taiwan	BSMI	4
The United Kingdom	BSI	1
The United States	UL	2

1. The flexible cord must be Type HO5VV-F, 3-conductor, 1.0-mm² conductor size. Power cord set fittings (appliance coupler and wall plug) must bear the certification mark of the agency responsible for evaluation in the country or region where it will be used.
2. The flexible cord must be Type SPT-3 or equivalent, No. 18 AWG, 3-conductor. The wall plug must be a two-pole grounding type with a NEMA 5-15P (15 A, 125 V) or NEMA 6-15P (15 A, 250 V) configuration.
3. The appliance coupler, flexible cord, and wall plug must bear a "T" mark and registration number in accordance with the Japanese Dentori Law. The flexible cord must be Type VCT or VCTF, 3-conductor, 1.00-mm² conductor size. The wall plug must be a two-pole grounding type with a Japanese Industrial Standard C8303 (7 A, 125 V) configuration.
4. The flexible cord must be Type RVV, 3-conductor, 0.75-mm² conductor size. Power cord set fittings (appliance coupler and wall plug) must bear the certification mark of the agency responsible for evaluation in the country or region where it will be used.
5. The flexible cord must be Type VCTF, 3-conductor, 0.75-mm² conductor size. Power cord set fittings (appliance coupler and wall plug) must bear the certification mark of the agency responsible for evaluation in the country or region where it will be used.

9 Recycling

Battery

When a battery has reached the end of its useful life, do not dispose of the battery in general household waste. Follow the local laws and regulations in your area for computer battery disposal.

Display

⚠ WARNING! The backlight contains mercury. Caution must be exercised when removing and handling the backlight to avoid damaging this component and causing exposure to the mercury.

⚠ CAUTION: The procedures in this chapter can result in damage to display components. The only components intended for recycling purposes are the liquid crystal display (LCD) panel and the backlight. When you remove these components, handle them carefully.

📝 NOTE: Materials Disposal. This HP product contains mercury in the backlight in the display assembly that might require special handling at end-of-life. Disposal of mercury may be regulated because of environmental considerations. For disposal or recycling information, contact your local authorities, or see the Electronic Industries Alliance (EIA) Web site at <http://www.eiai.org>.

This section provides disassembly instructions for the display assembly. The display assembly must be disassembled to gain access to the backlight **(1)** and the liquid crystal display (LCD) panel **(2)**.



📝 NOTE: The procedures provided in this chapter are general disassembly instructions. Specific details, such as screw sizes, quantities, and locations, and component shapes and sizes, can vary from one computer model to another.

Perform the following steps:

1. Remove all screw covers (1) and screws (2) that secure the display bezel to the display assembly.

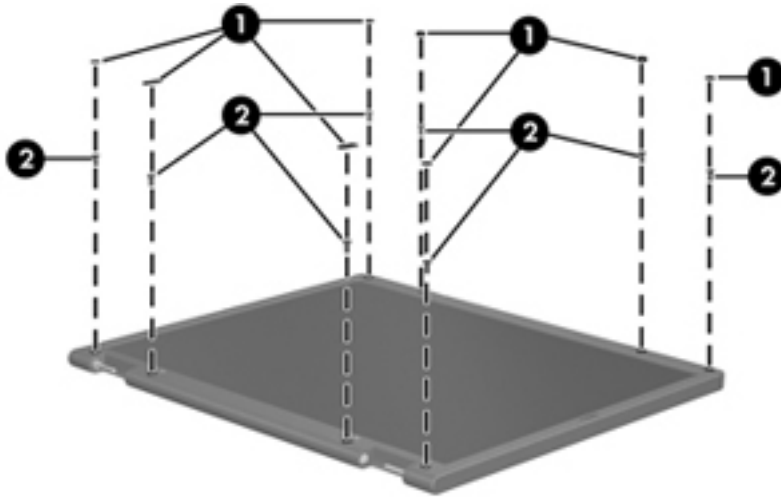

2. Lift up and out on the left and right inside edges (1) and the top and bottom inside edges (2) of the display bezel until the bezel disengages from the display assembly.
3. Remove the display bezel (3).

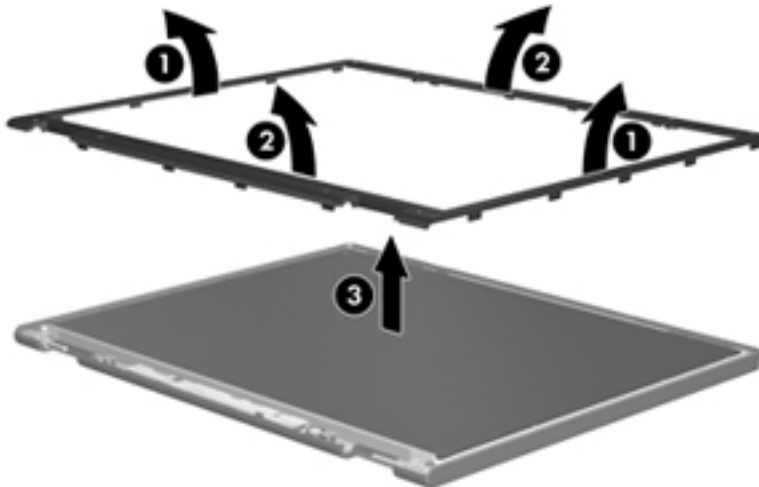

4. Disconnect all display panel cables (1) from the display inverter and remove the inverter (2).

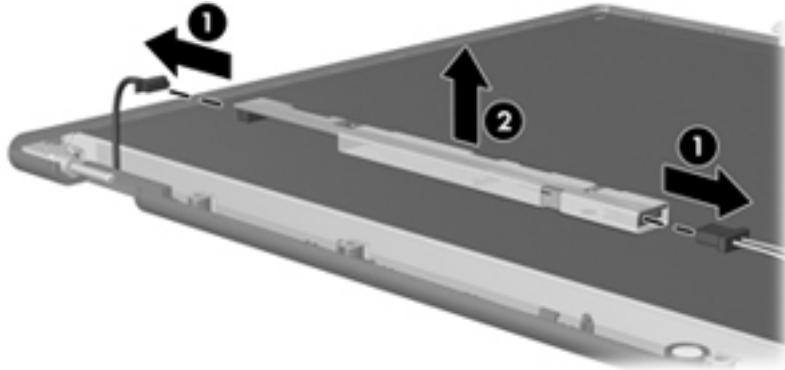

5. Remove all screws (1) that secure the display panel assembly to the display enclosure.
6. Remove the display panel assembly (2) from the display enclosure.

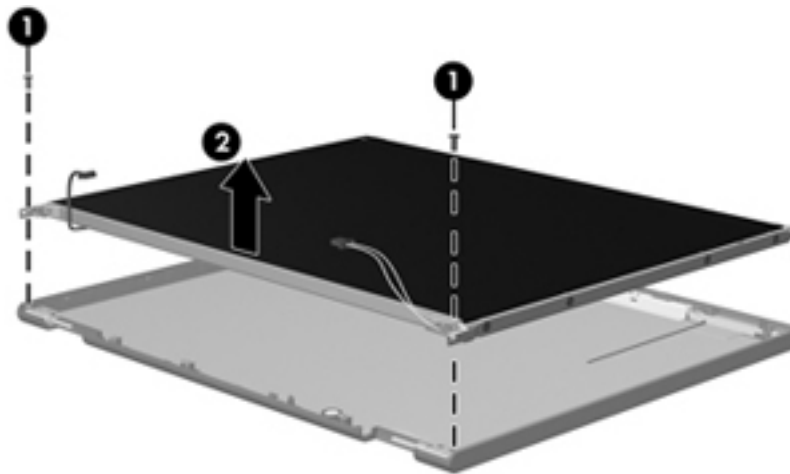

7. Turn the display panel assembly upside down.
8. Remove all screws that secure the display panel frame to the display panel.

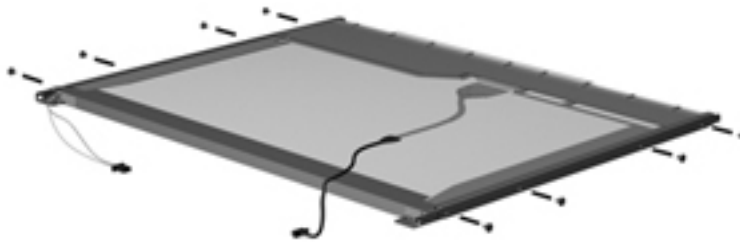

9. Use a sharp-edged tool to cut the tape (1) that secures the sides of the display panel to the display panel frame.

10. Remove the display panel frame (2) from the display panel.

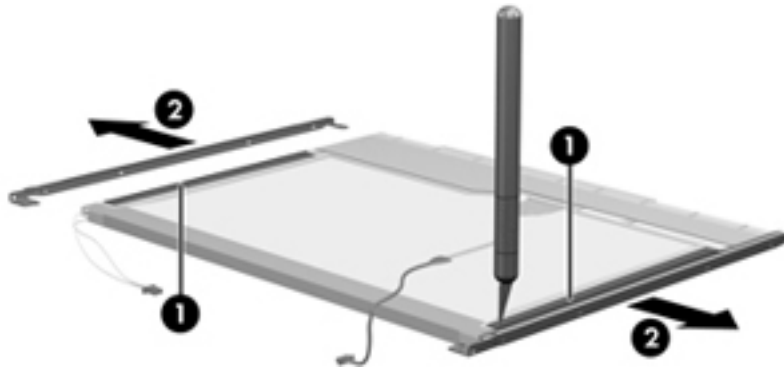

11. Remove the screws (1) that secure the backlight cover to the display panel.
12. Lift the top edge of the backlight cover (2) and swing it outward.

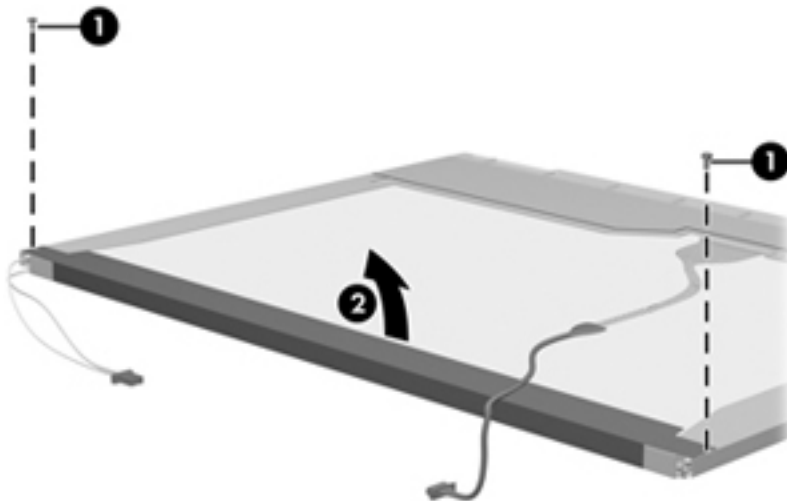

13. Remove the backlight cover.
14. Turn the display panel right-side up.

15. Remove the backlight cables (1) from the clip (2) in the display panel.

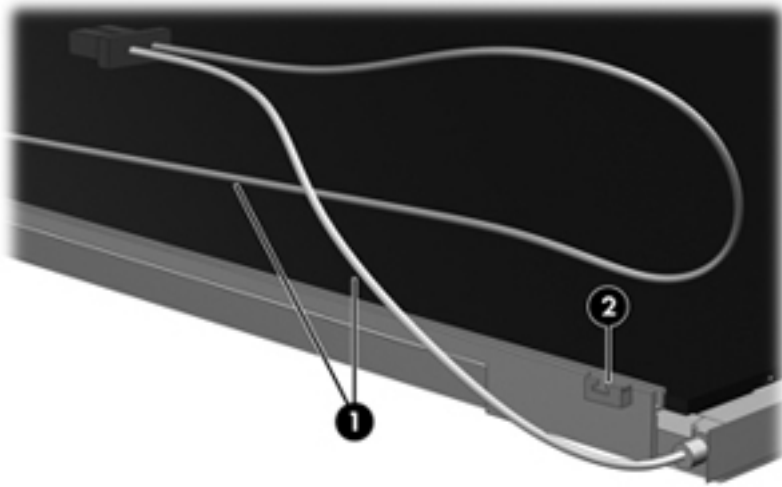

16. Turn the display panel upside down.
17. Remove the backlight frame from the display panel.

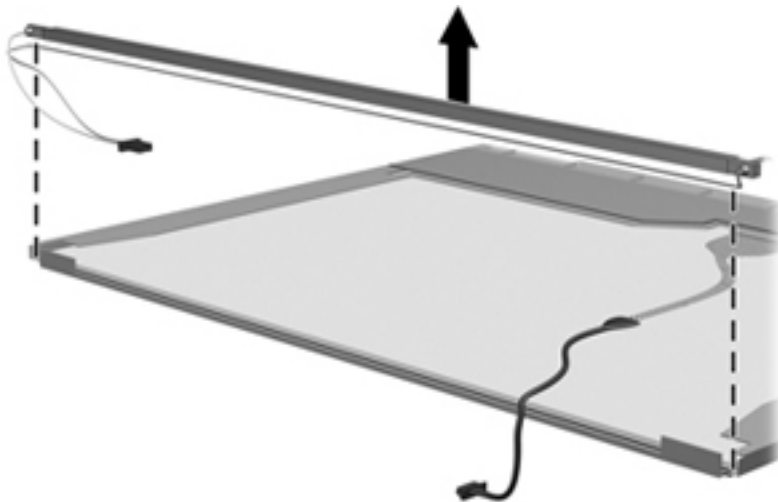

⚠ WARNING! The backlight contains mercury. Exercise caution when removing and handling the backlight to avoid damaging this component and causing exposure to the mercury.

18. Remove the backlight from the backlight frame.

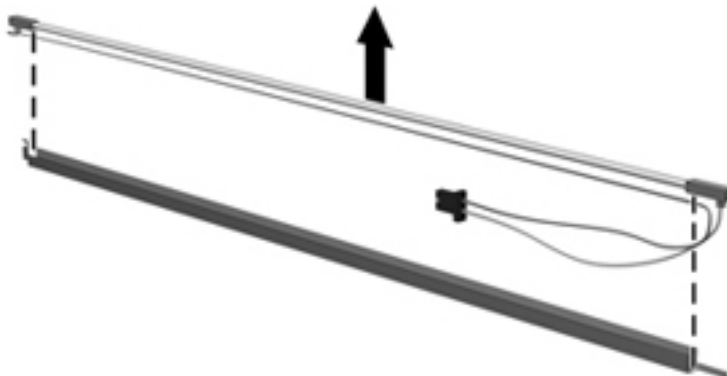

19. Disconnect the display cable (1) from the LCD panel.
20. Remove the screws (2) that secure the LCD panel to the display rear panel.
21. Release the LCD panel (3) from the display rear panel.
22. Release the tape (4) that secures the LCD panel to the display rear panel.

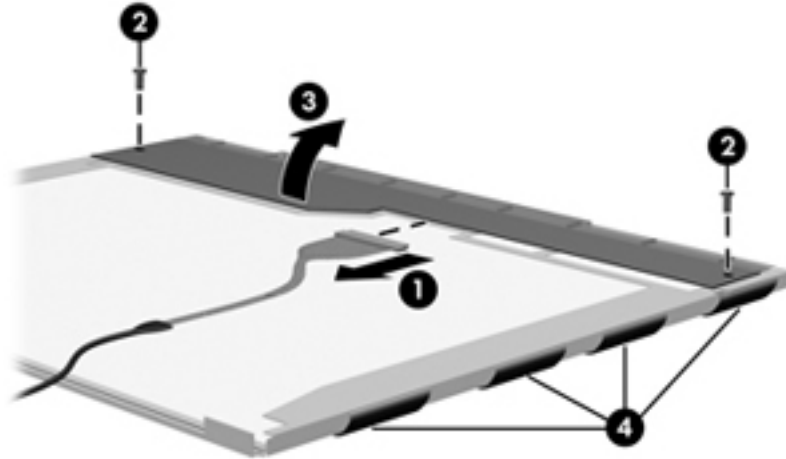

23. Remove the LCD panel.

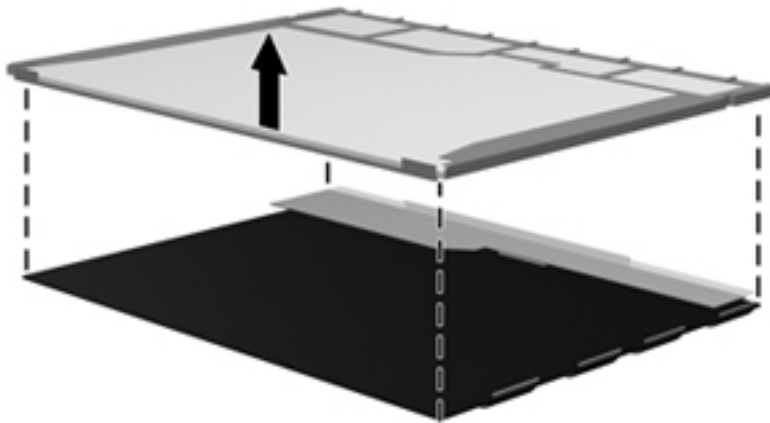

24. Recycle the LCD panel and backlight.

Index

A

AC adapter light 13
AC adapter, spare part numbers 25, 27
Action keys 9
antenna
 locations 7
 removal 69
 spare part number 23, 28, 70
Antenna Kit, spare part number 23, 28, 70
audio, product description 4
audio-in jack 12
audio-out jack 12

B

base enclosure, spare part number 21, 28
battery
 removal 40
 spare part numbers 21, 27, 40
battery bay 14
battery release latch 14
bottom components 14
button components 8
buttons
 power 8
 TouchPad 11
 TouchPad on/off 11

C

Cable Kit
 contents 22
 spare part number 18, 22, 28
cables, service considerations 33
caps lock light 10
chipset, product description 2
components
 bottom 14

 button 8
 display 7
 keys 9
 left-side 12
 lights 10
 right-side 13
 TouchPad 11
computer feet, locations 39
computer major components 17
computer part number 16, 38
computer specifications 89
connectors, service considerations 33

D

Digital Media Slot 12
display assembly
 removal 64
 spare part numbers 17, 28, 64
 subcomponents 23
display bezel
 removal 65
 spare part numbers 23, 28, 65
Display Cable Kit, spare part number 23, 28, 69
display components 7
display enclosure, spare part number 23, 28
Display Hinge Kit, spare part number 23, 29, 69
display panel
 product description 3
 removal 67
 spare part number 23, 28, 68
display panel cable
 removal 69
 spare part number 23, 28, 69
Display Screw Kit, spare part number 23, 30

display specifications 90
display switch 8
drive light 12
drives, preventing damage 34
DVD-ROM Drive
 removal 41
 spare part number 21, 24, 31, 41
DVD±RW and CD-RW Drive
 removal 41
 spare part number 21, 24, 31, 41
DVD±RW and CD-RW Super Multi Double-Layer Combo Drive
 removal 41
 spare part number 21, 24, 41
DVD±RW and CD-RW Super Multi Double-Layer Combo Drive with LightScribe
 precautions 34
 spare part number 30

E

electrostatic discharge 34
equipment guidelines 37
esc key 9
Ethernet, product description 4
external media cards, product description 5
external monitor port 12

F

fan/heat sink assembly
 removal 76
 spare part numbers 20, 30, 76
feet, locations 39
fn key 9

- G**
 - graphics, product description 2
 - grounding guidelines 34
 - guidelines
 - equipment 37
 - grounding 34
 - packaging 36
 - transporting 36
 - workstation 36
- H**
 - hard drive
 - precautions 34
 - product description 3
 - removal 46
 - spare part numbers 21, 24, 27, 28, 46
 - specifications 91
 - hard drive bay 14
 - hard drive bracket
 - illustrated 24
 - removal 48
 - hard drive compartment cover
 - illustrated 26
 - removal 46
 - hard drive connector cable
 - illustrated 22
 - removal 48
 - Hard Drive Hardware Kit, spare part number 21, 24, 29, 46
 - HDMI port 12
 - headphone jack 12
 - hinge
 - removal 68
 - spare part number 23, 29, 69
 - hinge cover
 - removal 66
 - spare part number 23, 29, 67
- J**
 - jacks
 - audio-in 12
 - audio-out 12
 - headphone 12
 - microphone 12
 - network 12
 - RJ-45 12
- K**
 - key components 9
- keyboard
 - product description 5
 - removal 49
 - spare part numbers 18, 29, 49
- keys
 - Action 9
 - esc 9
 - fn 9
 - Windows applications 9
 - Windows logo 9
- L**
 - left-side components 12
 - light components 10
 - lights
 - AC adapter 13
 - caps lock 10
 - drive 12
 - optical drive 13
 - power 10, 12
 - TouchPad 10, 11
 - webcam 7
 - wireless 10
- M**
 - mass storage device
 - precautions 34
 - removal 46
 - spare part numbers 24, 46
 - memory module
 - product description 3
 - removal 45
 - spare part numbers 21, 28, 45
 - memory module compartment 14
 - memory module/wireless module
 - compartment cover
 - illustrated 26
 - removal 41
 - microphone
 - location 7
 - product description 4
 - microphone jack 12
 - microphone module
 - removal 66
 - spare part number 23, 28, 66
 - model description 16, 39
 - model name 1
 - monitor port 12
- N**
 - network jack 12
- O**
 - operating system, product description 6
 - optical drive
 - location 13
 - precautions 34
 - product description 4
 - removal 41
 - spare part number 30
 - spare part numbers 21, 24, 31, 41
 - optical drive bracket, removal 42
 - optical drive connector cable
 - illustrated 22
 - removal 63
 - optical drive light 13
 - optical drive slot space saver
 - spare part number 31
 - optical drive slot space saver, spare part number 21, 24, 41
- P**
 - packaging guidelines 36
 - plastic parts, service considerations 33
 - Plastics Kit
 - contents 26
 - spare part number 19, 26, 30, 42, 47
 - pointing device, product description 5
 - ports
 - external monitor 12
 - HDMI 12
 - monitor port 12
 - product description 5
 - USB 12, 13
 - power button 8
 - power button board
 - removal 56
 - spare part number 18, 30, 56
 - power connector 13
 - power connector cable
 - removal 60
 - spare part number 19, 29
 - power cord
 - set requirements 99
 - spare part numbers 25, 27
 - power light 10, 12

- power requirements, product description 6
- processor
 - product description 1
 - removal 82
 - spare part numbers 19, 27, 28, 31, 32, 82
- product description
 - audio 4
 - chipset 2
 - display panel 3
 - Ethernet 4
 - external media cards 5
 - graphics 2
 - hard drives 3
 - keyboard 5
 - memory module 3
 - microphone 4
 - operating system 6
 - optical drive 4
 - pointing device 5
 - ports 5
 - power requirements 6
 - processors 1
 - product name 1
 - security 6
 - serviceability 6
 - video 4
 - wireless 4
- product name 1, 15, 38
- product number 16, 38

R

- removal/replacement
 - preliminaries 33
 - procedures 38
- right-side components 13
- RJ-45 jack 12
- RTC battery
 - removal 74
 - spare part number 19, 30, 74

S

- Screw Kit, spare part number 25, 30
- security cable slot 13
- security, product description 6
- serial number 15, 38
- service considerations
 - cables 33

- connectors 33
 - plastic parts 33
- service tag 15, 38
- serviceability, product description 6
- Setup Utility (BIOS) 84
- Speaker Kit, spare part number 19, 30, 62
- speakers
 - removal 62
 - spare part number 19, 30, 62
- specifications
 - computer 89
 - display 90
 - hard drive 91
- system board
 - removal 71
 - spare part numbers 19, 30, 31, 71
- System Diagnostics 84

T

- Thermal Material Kit, spare part numbers 19, 30, 31
- tools required 33
- top cover
 - removal 52
 - spare part number 18, 30, 52
- TouchPad button 11
- TouchPad button board
 - removal 57
 - spare part number 18, 30, 57
- TouchPad cable
 - disconnection 53
 - illustrated 22
- TouchPad components 11
- TouchPad light 10, 11
- TouchPad on/off button 11
- TouchPad zone 11
- transporting guidelines 36

U

- USB board
 - removal 59
 - spare part number 19, 30
- USB port 12, 13

V

- vents 12, 14
- video, product description 4

W

- warranty period 16, 39
- webcam 7
- webcam light 7
- webcam/microphone module
 - removal 66
 - spare part number 23, 30, 66
- Windows applications key 9
- Windows logo key 9
- wireless antenna
 - locations 7
 - removal 69
 - spare part number 23, 28, 70
- wireless light 10
- wireless, product description 4
- WLAN module
 - removal 43
 - spare part numbers 21, 27, 28, 31, 43
- workstation guidelines 36