

Basic Remote Control Function/基本的遙控器功能/基本的遙控器功能：

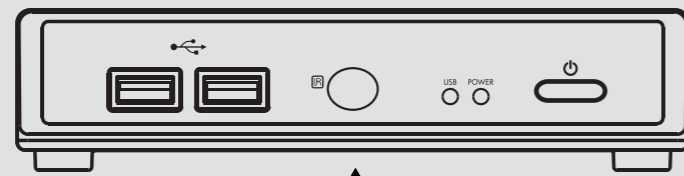

30°
6.0M

Remote Control Signal
遙控器訊號
遙控器讯号

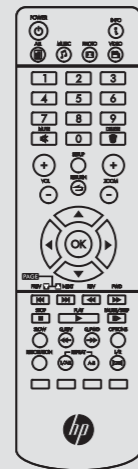

Power [On/Off]

(switch the mp200 HD Media Player on or off)
電源 [開/關]
(開啟或關閉 HP mp200 高畫質多媒體播放器電源)
电源 [开/关]
(开启或关闭 HP mp200 全高清媒体播放器电源)

PLAY/PAUSE
(starts/pauses playback)

播放/暫停
(開始/暫停播放)
播放/暫停
(开始/暂停播放)

STOP
(stop playback)

停止
(停止播放)
停止
(停止播放)

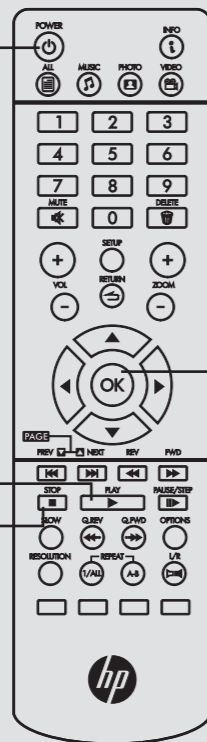

OK (starts/selects item)
確定 (執行所選取的项目)
确定 (执行所选取的项目)

* Please refer to the User Manual for more information on the remote control.

* 如需遙控器的相關詳細資訊，請參閱使用手冊。

* 如需遙控器的相關詳細信息，請參閱用戶手冊。



mp200 HD Media Player

Unleash Your Digital Life in Full HD 1080p

Quick Start Guide

What's inside the box...

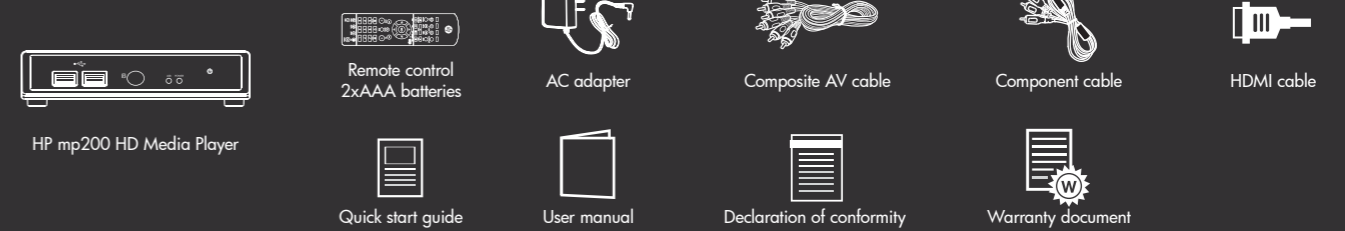

Connect: Select one of the connection options below

Option A:

HDMI (video resolutions up to 1080p)

Required: HDMI Cable (included)
* A single HDMI connection can deliver both audio and video signals to your TV.

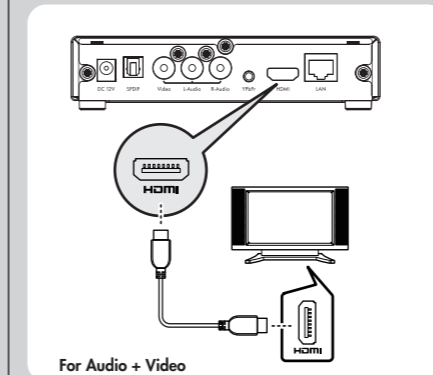

Option B:

Component (video resolutions up to 1080i)

Required: Component Video Cable (included) / Composite AV Cable (included)

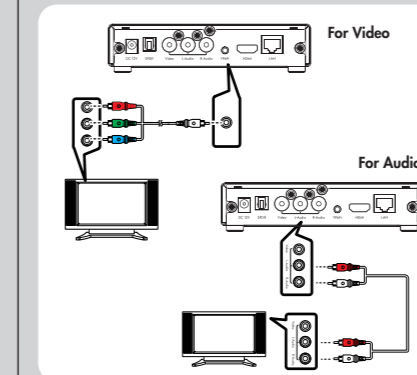

Option C:

Composite (video resolutions up to 480i)

Required: Composite A/V Cable (included)

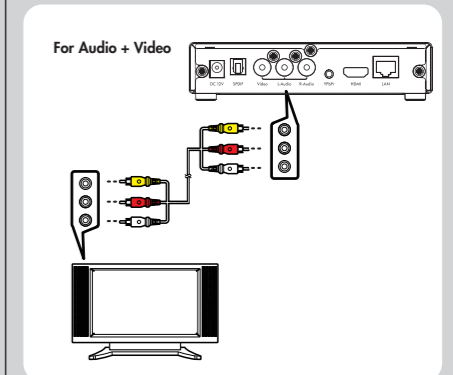

* Please refer to the User Manual for information on connecting an optical audio cable

USB Connection:

Required: USB Flash Drive / USB Hard Drive / USB DVDROM Drive

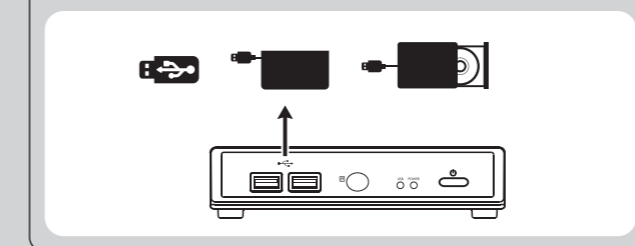

Network Connection:

Required: Ethernet Cable

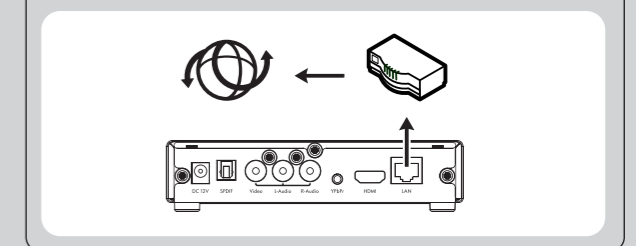

Setup

Step 1:

When the connection between your HP mp200 HD Media Player and TV is complete, connect the supplied power cord. The media player will automatically power on when it is plugged into the AC adapter.

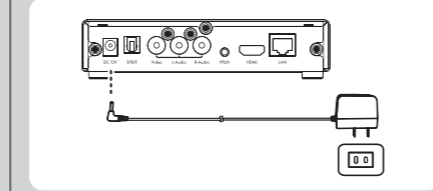

Step 2:

Turn on your TV and select the correct video source based on your earlier connection.

Connect

- Option A:** HDMI (video resolutions up to 1080p)
- Option B:** Component (video resolutions up to 1080i)
- Option C:** Composite (video resolutions up to 480i)

Step 3:

Enjoy your HD media player!

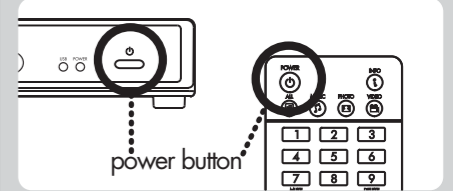

* Please insert the included batteries into the remote control before use.



惠普mp200 全高清媒体播放器

恣意享受Full HD 1080p 影音娱乐

快速使用指南

包装内容



连接：请选择下列其中一种连接选项

选项 A: HDMI (最高1080p的影像分辨率)

必备：HDMI线 (随附)
*单一HDMI线连接，可以同时传送音频与视频到电视。

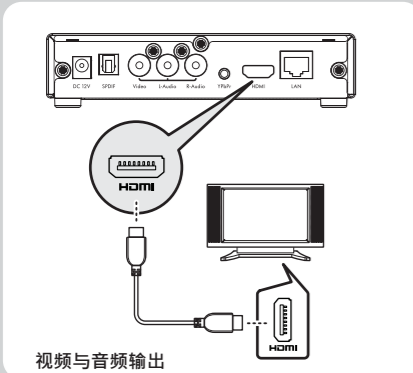

选项 B: 色差Component (最高1080i的影像分辨率)

必备：色差线 (随附) / AV线 (随附)

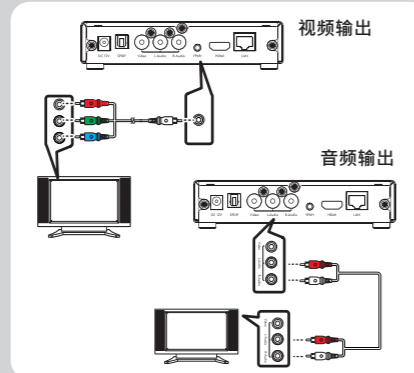

选项 C: 复合Composite (最高 480i 的影像分辨率)

必备：AV线 (随附)

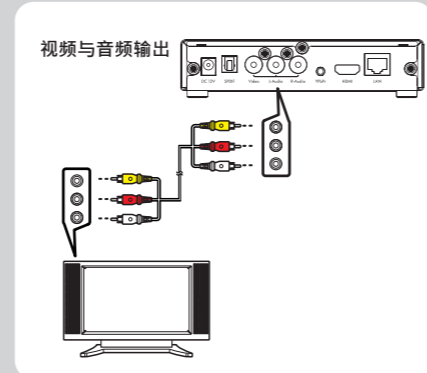

*若要连接光纤音频线，请参阅用户手册。

USB连接：

必备：U盘/USB硬盘/USB DVD光驱

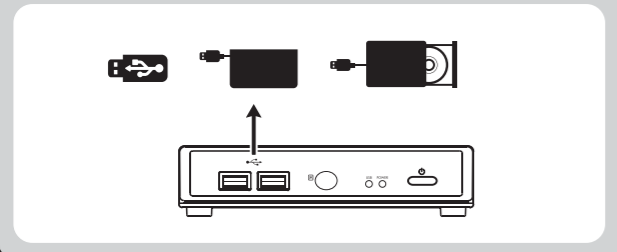

网络连接：

必备：以太网线

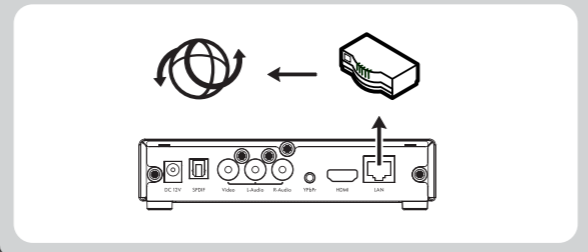

设置

步骤 1: 完成连接HP mp200全高清媒体播放器与电视后，请接上随附的电源线。请注意，当电源线插上插座时，播放器将自动开启。

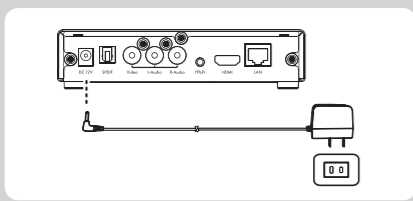

步骤 2: 打开电视，根据先前的连接，选择正确的视频来源。

连接

- 选项 A: HDMI (video resolutions up to 1080p)
- 选项 B: Component (video resolutions up to 1080i)
- 选项 C: Composite (video resolutions up to 480i)

步骤 3: 开始观赏！

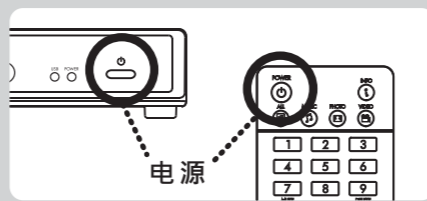

*使用前请将随附电池装入遥控器。



惠普mp200 高画质多媒体播放器

恣意享受Full HD 1080p 影音娱乐

快速使用指南

盒装内容



连接：请选择下列其中一种连接选项

选项 A: HDMI (最高1080p的影片解析度)

必备：HDMI线 (随附)
*单条HDMI线可同時傳送音訊與視訊號到電視。

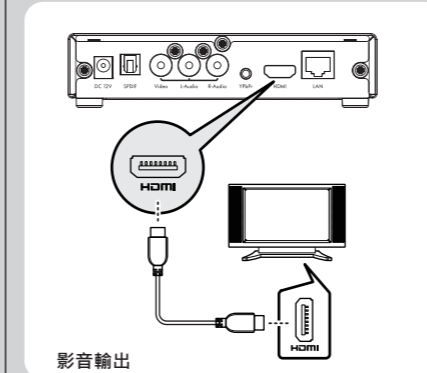

选项 B: 色差Component (最高1080i的影片解析度)

必备：色差端子线 (随附) / AV影音线 (随附)

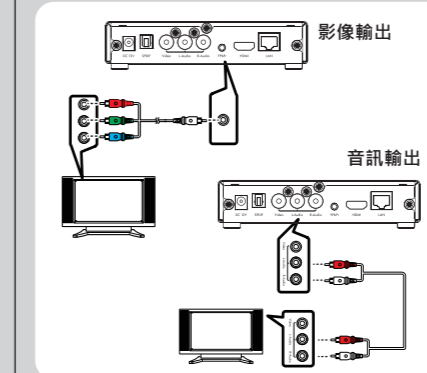

选项 C: 复合Composite (最高 480i 的影片解析度)

必备：AV影音线 (随附)

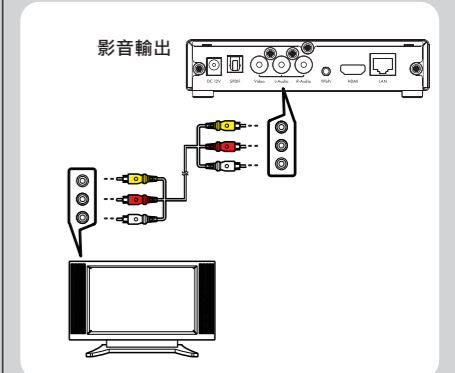

*若要连接光音讯线，请参阅使用手册。

USB连接：

必备：USB随身碟/USB随身硬碟/外接DVD光碟机

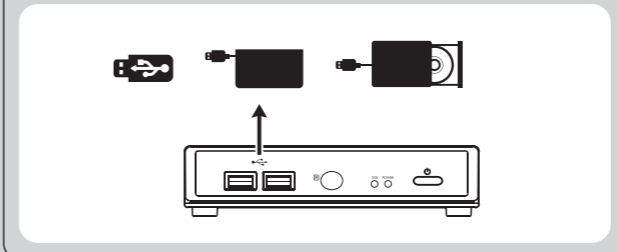

網路连接：

必备：以太网网路

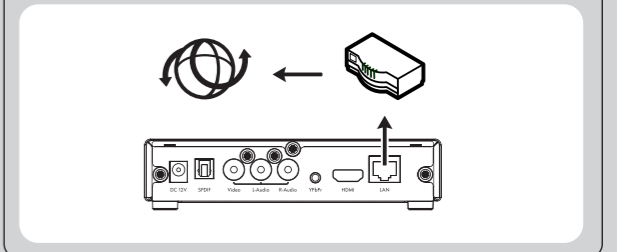

设定

步骤 1: 完成连接HP mp200高画质多媒体播放器与电视后，请接上随附的电源线。请注意，当电源线插上插座时，播放器将自动开启。

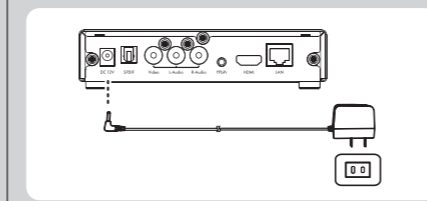

步骤 2: 打开电视，根据先前的连接，选择正确的视频来源。

连接

- 选项 A: HDMI (video resolutions up to 1080p)
- 选项 B: Component (video resolutions up to 1080i)
- 选项 C: Composite (video resolutions up to 480i)

步骤 3: 开始观赏！

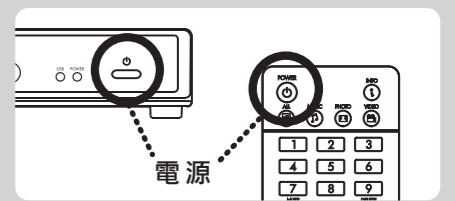

*使用前请将随附电池装入遥控器。