



# **HP EliteBook 2730p Notebook PC**

## Maintenance and Service Guide

Document Part Number: 483222-002

March 2012

This guide is a troubleshooting reference used for maintaining and servicing the computer. It provides comprehensive information on identifying computer features, components, and spare parts; troubleshooting computer problems; and performing computer disassembly procedures.



© Copyright 2008, 2012 Hewlett-Packard Development Company, L.P.

Microsoft, Windows, and Windows Vista are U.S. registered trademarks of Microsoft Corporation. SD Logo is a trademark of its proprietor. Bluetooth is a trademark owned by its proprietor and used by Hewlett-Packard Company under license. Intel and Core are trademarks or registered trademarks of Intel Corporation or its subsidiaries in the United States and other countries. Java is a U.S. trademark of Sun Microsystems, Inc.

The information contained herein is subject to change without notice. The only warranties for HP products and services are set forth in the express warranty statements accompanying such products and services. Nothing herein should be construed as constituting an additional warranty. HP shall not be liable for technical or editorial errors or omissions contained herein.

Second Edition: March 2012

First Edition: October 2008

Document Part Number: 483222-002

## Safety warning notice

---



**WARNING:** To reduce the possibility of heat-related injuries or of overheating the computer, do not place the computer directly on your lap or obstruct the computer air vents. Use the computer only on a hard, flat surface. Do not allow another hard surface, such as an adjoining optional printer, or a soft surface, such as pillows or rugs or clothing, to block airflow. Also, do not allow the AC adapter to contact the skin or a soft surface, such as pillows or rugs or clothing, during operation. The computer and the AC adapter comply with the user-accessible surface temperature limits defined by the International Standard for Safety of Information Technology Equipment (IEC 60950).

---

## 1 Product description

## 2 External component identification

|                                      |      |
|--------------------------------------|------|
| Top components . . . . .             | 2-1  |
| Wireless antenna locations . . . . . | 2-1  |
| Display components . . . . .         | 2-2  |
| Buttons and switches . . . . .       | 2-3  |
| Keys . . . . .                       | 2-4  |
| Lights . . . . .                     | 2-5  |
| Pointing devices . . . . .           | 2-6  |
| Front components . . . . .           | 2-7  |
| Right-side components . . . . .      | 2-8  |
| Left-side components . . . . .       | 2-9  |
| Rear components . . . . .            | 2-11 |
| Bottom components . . . . .          | 2-12 |

## 3 Illustrated parts catalog

|  |      |
|--|------|
| Serial number location . . . . .         | 3-1  |
| Computer major components . . . . .      | 3-2  |
| Cable Kit . . . . .                      | 3-7  |
| Mass storage devices . . . . .           | 3-8  |
| Plastics Kit . . . . .                   | 3-9  |
| Miscellaneous parts . . . . .            | 3-10 |
| Sequential part number listing . . . . . | 3-11 |

## 4 Removal and replacement procedures

|  |      |
|--|------|
| Preliminary replacement requirements . . . . . | 4-1  |
| Tools required . . . . .                       | 4-1  |
| Service considerations . . . . .               | 4-1  |
| Grounding guidelines . . . . .                 | 4-2  |
| Unknown user password . . . . .                | 4-5  |
| Component replacement procedures . . . . .     | 4-6  |
| Serial number location . . . . .               | 4-6  |
| Computer feet . . . . .                        | 4-7  |
| Battery . . . . .                              | 4-8  |
| SIM . . . . .                                  | 4-9  |
| Hard drive . . . . .                           | 4-10 |
| WLAN module . . . . .                          | 4-12 |
| WWAN module . . . . .                          | 4-15 |
| Memory module . . . . .                        | 4-16 |
| Keyboard . . . . .                             | 4-17 |
| Hinge cover . . . . .                          | 4-20 |

|  |      |
|--|------|
| Top cover . . . . .                                    | 4-21 |
| RTC battery . . . . .                                  | 4-23 |
| Audio connector board . . . . .                        | 4-24 |
| Bluetooth module . . . . .                             | 4-25 |
| Speaker . . . . .                                      | 4-26 |
| Display assembly . . . . .                             | 4-27 |
| System board . . . . .                                 | 4-30 |
| Fan/heat sink assembly . . . . .                       | 4-34 |
| Modem module . . . . .                                 | 4-36 |
| <br>   |      |
| <b>5 Computer Setup</b>                                |      |
| Starting Computer Setup . . . . .                      | 5-1  |
| Using Computer Setup . . . . .                         | 5-2  |
| Navigating and selecting in Computer Setup . . . . .   | 5-2  |
| Restoring factory settings in Computer Setup . . . . . | 5-3  |
| Computer Setup menus . . . . .                         | 5-3  |
| File menu . . . . .                                    | 5-3  |
| Security menu . . . . .                                | 5-4  |
| Diagnostics menu . . . . .                             | 5-5  |
| System Configuration menu . . . . .                    | 5-5  |
| <br>   |      |
| <b>6 Specifications</b>                                |      |
| Computer specifications . . . . .                      | 6-1  |
| 12.1-inch, WXGA display specifications . . . . .       | 6-2  |
| Hard drive specifications . . . . .                    | 6-2  |
| System DMA specifications . . . . .                    | 6-3  |
| System interrupt specifications . . . . .              | 6-3  |
| System I/O address specifications . . . . .            | 6-4  |
| System memory map specifications . . . . .             | 6-6  |
| <br>   |      |
| <b>7 Screw listing</b>                                 |      |
| Phillips PM2.0×5.0 captive screw . . . . .             | 7-1  |
| Phillips PM2.0×3.0 screw . . . . .                     | 7-2  |
| Phillips PM2.0×4.0 screw . . . . .                     | 7-3  |
| Torx T8M2.0×8.0 screw . . . . .                        | 7-4  |
| Torx T8M2.0×5.0 screw . . . . .                        | 7-5  |
| Phillips PM2.0×5.0 screw . . . . .                     | 7-6  |
| Phillips PM2.0×4.0 screw . . . . .                     | 7-8  |
| Torx T8M2.5×6.0 screw . . . . .                        | 7-9  |
| Phillips PM2.5×7.0 captive screw . . . . .             | 7-10 |
| <br>   |      |
| <b>8 Backup and recovery</b>                           |      |
| Backup and recovery in Windows Vista . . . . .         | 8-1  |
| Overview . . . . .                                     | 8-1  |
| Backing up your information . . . . .                  | 8-1  |
| Performing a recovery . . . . .                        | 8-2  |
| Backup and recovery in Windows XP . . . . .            | 8-5  |
| Overview . . . . .                                     | 8-5  |
| Backing up your information . . . . .                  | 8-5  |
| Performing a recovery . . . . .                        | 8-6  |

**9 Connector pin assignments**

1394 ..... 9-1  
 Audio-in (microphone)..... 9-2  
 Audio-out (headphone) ..... 9-2  
 External monitor..... 9-3  
 RJ-11 (modem)..... 9-4  
 RJ-45 (network)..... 9-5  
 Universal Serial Bus..... 9-6

**10 Power cord set requirements**

Requirements for all countries and regions ..... 10-1  
 Requirements for specific countries and regions ..... 10-2

**11 Recycling**

Battery ..... 11-1  
 Display ..... 11-1

**Index**





## Product description

| Category            | Description  |
|---------------------|--|
| <b>Product Name</b> | <b>HP EliteBook 2730p Notebook PC</b>  |
| <b>Processors</b>   | <p><b>Intel® Core™2 Duo ultra low-voltage, non-socketed processors:</b></p> <ul style="list-style-type: none"> <li>■ SL9600 2.13-GHz processor, 6-MB L2 cache, 1066-MHz front side bus (FSB)</li> <li>■ SL9400 1.86-GHz processor, 6-MB L2 cache, 1066-MHz FSB</li> <li>■ SL9300 1.60-GHz processor, 6-MB L2 cache, 1066-MHz FSB</li> <li>■ SU9400 1.40-GHz processor, 3-MB L2 cache, 800-MHz FSB</li> <li>■ SU9300 1.20-GHz processor, 3-MB L2 cache, 800-MHz FSB</li> </ul>  |
| <b>Chipset</b>      | <p>Northbridge: Cantiga GS<br/>         Southbridge: Intel ICH9M SFF enhanced</p>  |
| <b>Graphics</b>     | Intel Graphics Media Accelerator X4500 HD Unified Memory Architecture (UMA) graphics subsystem integrated with shared system memory (dynamically allocated) with up to 384 MB shared system memory   |
| <b>Panel</b>        | <p>Digitizer with pen support<br/>         Sparkle-free glass<br/>         Integrated keyboard light<br/>         2 wireless local area network (WLAN) antennae</p> <p>Supports the following display assemblies:</p> <ul style="list-style-type: none"> <li>■ 12.1-inch WXGA LED AntiGlare (1280 × 800) with webcam and outdoor light</li> <li>■ 12.1-inch WXGA LED AntiGlare (1280 × 800) with webcam</li> <li>■ 12.1-inch WXGA LED AntiGlare (1280 × 800) with outdoor light</li> <li>■ 12.1-inch WXGA LED AntiGlare (1280 × 800)</li> </ul>  |
| <b>Memory</b>       | <p>2 customer-accessible/upgradable memory module slots<br/>         Supports dual-channel memory<br/>         Supports PC2-6400, 800-MHz, DDR2 memory modules<br/>         Up to 8192-GB maximum memory supported</p> <p>Supports the following configurations:</p> <ul style="list-style-type: none"> <li>■ 8192-MB total system memory (4096 × 2, dual-channel)</li> <li>■ 6144-MB total system memory (4096 + 2048)</li> <li>■ 5120-MB total system memory (4096 + 1024)</li> <li>■ 4096-MB total system memory (2048 × 2, dual-channel)</li> <li>■ 3072-MB total system memory (2048 + 1024)</li> <li>■ 2048-MB total system memory (1024 × 2, dual-channel)</li> <li>■ 2048-MB total system memory (2048 × 1)</li> <li>■ 1024-MB total system memory (1024 × 1)</li> </ul> |

(Continued)

| Category                   | Description   |
|----------------------------|---|
| <b>Mass storage drives</b> | Supports 45.72-mm (1.80-inch) hard drives and 45.72-mm (1.80-inch) solid-state drives<br>Customer-accessible<br>Serial ATA<br>HP 3D DriveGuard  |
|                            | Supports the following drives: <ul style="list-style-type: none"> <li>■ 250-GB, 5400-rpm hard drive</li> <li>■ 160-GB, 5400-rpm hard drive</li> <li>■ 120-GB, 5400-rpm hard drive</li> <li>■ 80-GB, 5400-rpm hard drive</li> <li>■ 128-GB solid-state drive</li> <li>■ 80-GB solid-state drive</li> </ul> |
| <b>Optical drives</b>      | Supports external optical drive only through docking station  |
| <b>Diskette drive</b>      | Supports external USB diskette drive only<br>Supports boot from USB device  |
| <b>Microphone</b>          | Integrated dual array microphone  |
| <b>Audio</b>               | Analog Devices AD1984A high-definition audio<br>Single speaker  |
| <b>Webcam</b>              | Optional 2.1-megapixel webcam with business card reader support<br>Business card slot   |
| <b>Modem</b>               | 56K V.92 1.5-inch data/fax modem with digital line guard<br>Modem cable is included<br>Supports no-modem option   |
| <b>Ethernet</b>            | Intel 10/100/1000 network interface card (NIC)<br>NIC power-down technology<br>Ethernet cable included<br>S4/S5 wake on LAN   |
| <b>Wireless</b>            | <b>Integrated WLAN options by way of wireless module:</b><br>2 wireless antennae built into display assembly<br>Supports no-WLAN option   |
|                            | Supports the following WLAN formats: <ul style="list-style-type: none"> <li>■ Broadcom 802.11a/b/g/n</li> <li>■ Broadcom 802.11b/g</li> <li>■ 802.11a/b/g/n Intel with iAMT support</li> <li>■ 802.11a/b/g Intel with iAMT support</li> </ul>   |
|                            | <b>Integrated wireless wide area network (WWAN) options by way of wireless module:</b><br>HSPDA EV-DO WWAN module<br>2 WWAN antennae built into display assembly (worldwide 5-band)<br>Supports aftermarket WWAN option   |
|                            | <b>Subscriber identify module (SIM) user-accessible behind primary battery</b>  |
|                            | <b>Integrated personal area network (PAN) options by way of Bluetooth® module:</b><br>Support for no-WPAN option<br>Broadcom Bluetooth  |
| <b>External media card</b> | One ExpressCard slot, supporting optional ExpressCard/54 cards<br>SD Card Reader supporting MultiMediaCard (MMC) and Secure Digital (SD) Memory Cards   |

(Continued)

| Category                        | Description   |
|---------------------------------|---|
| <b>Docking</b>                  | <p>HP 2700 Ultra-Slim Expansion Base support</p> <p>Signals passed through docking connector:</p> <ul style="list-style-type: none"> <li>■ External monitor</li> <li>■ Headphone</li> <li>■ Microphone</li> <li>■ Optical drive support</li> <li>■ Power</li> <li>■ RJ-45</li> <li>■ USB 2.0</li> </ul>   |
| <b>Ports</b>                    | <p>1394a</p> <p>Audio-in (mono microphone)</p> <p>Audio-out (stereo headphone)</p> <p>Multi-pin AC power</p> <p>RJ-11 (modem)</p> <p>RJ-45 (Ethernet, includes link and activity lights)</p> <p>USB (2, one powered)</p> <p>VGA (Dsub 15-pin) supporting 1600 × 1200 external resolution at 75 GHz (hot plug/unplug with auto-detect)</p>   |
| <b>Keyboard/pointing device</b> | <p>Spill-resistant 27.1-mm (10.7-inch) keyboard</p> <p>Dual-point configuration (TouchPad with 2 TouchPad buttons and pointing stick with 2 pointing stick buttons)</p> <p>Durable key caps</p> <p>Taps enabled as default</p>  |
| <b>Power requirements</b>       | <p>65-W HP Smart AC adapter with localized cable plug support (3-wire plug with ground pin, supports 3-pin DC connector)</p> <p>6-cell, 2.25-Ah (44-Wh) Li-ion battery</p> <p>Supports HP2700 Ultra-Slim Battery (travel battery)</p>   |
| <b>Security</b>                 | <p>Supports security cable slot</p> <p>Optional integrated Active Smart card reader</p> <p>Integrated trusted platform module (TPM) 1.2 chip (soldered to system board)</p> <p>Integrated USB-based fingerprint reader</p>  |
| <b>Operating system</b>         | <p><b>Preinstalled without Microsoft® Office:</b></p> <p>Windows Vista® Business 32</p> <p>Windows Vista Business 32 with Windows® XPTablet image</p> <p>FreeDOS</p> <hr/> <p><b>Preinstalled with Microsoft Office:</b></p> <p>Windows Vista Business 32 with Microsoft Office 2007 Ready</p> <p>Windows Vista Business 32 with Windows XPTablet image and Microsoft Office 2007 Ready</p> <p>Windows Vista Ultimate 32 with Microsoft Office 2007 Ready</p> <p>Windows Vista Ultimate 32 with Windows XPTablet image and Microsoft Office 2007 Ready</p> <p>Windows Vista Business 32 with Microsoft Office 2007 Personal</p> <p>Windows Vista Business 32 with Windows XPTablet image and Microsoft Office 2007 Personal</p> <p>Windows Vista Business 32 with Microsoft Office 2007 Personal and PowerPoint</p> <p>Windows Vista Business 32 with Windows XPTablet image, Microsoft Office 2007 Personal, and PowerPoint</p> <p>Windows Vista Business 32 with Microsoft Office 2007 Pro</p> <p>Windows Vista Business 32 with Windows XPTablet image and Microsoft Office 2007 Pro</p> |

(Continued)

| <b>Category</b>         | <b>Description</b>  |
|-------------------------|---|
| <b>Operating system</b> | <b>Restore media:</b><br>Windows Vista Business 32<br>Windows Vista Business 64<br>Windows Vista Ultimate 32<br>Windows Vista DRDVD<br>Windows XPTablet<br>Windows XPTablet DRDVD<br>Microsoft Office Ready restore DVD                     |
|                         | <b>Certified:</b> Novell SuSE Linux   |
|                         | <b>Web support:</b><br>Windows Vista Enterprise 32<br>Windows Vista Enterprise 64   |
| <b>Serviceability</b>   | <b>End-user replaceable parts:</b> <ul style="list-style-type: none"><li>■ AC adapter</li><li>■ Battery (system)</li><li>■ Hard drive</li><li>■ Memory module</li><li>■ Optical drive</li><li>■ WLAN module</li><li>■ WWAN module</li></ul> |

---

## External component identification

### Top components

#### Wireless antenna locations



| Item | Component             | Description   |
|------|-----------------------|---|
| ❶    | WWAN antenna*         | Sends and receives wireless signals to communicate with wireless wide area networks (WWAN). |
| ❷    | WLAN antennae (2)*    | Send and receive wireless signals to communicate with wireless local area networks (WLAN).  |
| ❸    | External WWAN antenna | Sends and receives wireless signals to communicate with wireless wide area networks (WWAN). |

\*These antennae are not visible from the outside of the computer. For optimal transmission, keep the areas immediately around the antennae free from obstructions.

To see wireless regulatory notices, refer to the section of the *Regulatory, Safety and Environmental Notices* that applies to your country or region. These notices are located in Help and Support.

## Display components



| Item | Component                                  | Description  |
|------|--|--|
| ①    | Webcam light (select models only)          | On: The webcam is in use.  |
| ②    | Webcam (select models only)                | Records audio and video and captures still photographs.  |
| ③    | Keyboard light button                      | Opens and turns on the keyboard light.   |
| ④    | Keyboard light                             | Illuminates the keyboard in low-light conditions when the keyboard light button is pressed.                  |
| ⑤    | HP Fingerprint Sensor (fingerprint reader) | Allows a fingerprint logon to Windows instead of a password logon.   |
| ⑥    | Internal microphones (2)                   | Record sound and transmit sound for video conferencing and Voice Over IP (VoIP).                             |
| ⑦    | Ambient light sensor                       | Automatically adjusts the display brightness based on the lighting conditions in your environment.           |
| ⑧    | Convertible hinge                          | Swivels the display and converts the computer from traditional notebook mode into tablet mode or vice versa. |

## Buttons and switches



| Item | Component               | Description   |
|------|-------------------------|---|
| ❶    | Internal display switch | Turns off the display if the display is closed while the power is on.   |
| ❷    | Presentation button     | Starts the presentation feature.  |
| ❸    | Volume mute button      | Mutes and restores speaker sound.   |
| ❹    | Volume scroll zone      | Adjusts speaker volume: <ul style="list-style-type: none"> <li>■ To decrease volume, slide your finger across the volume scroll zone from right to left. You can also press and hold the left end of the volume scroll zone.</li> <li>■ To increase volume, slide your finger across the volume scroll zone from left to right. You can also press and hold the right end of the volume scroll zone.</li> </ul> |

## Keys

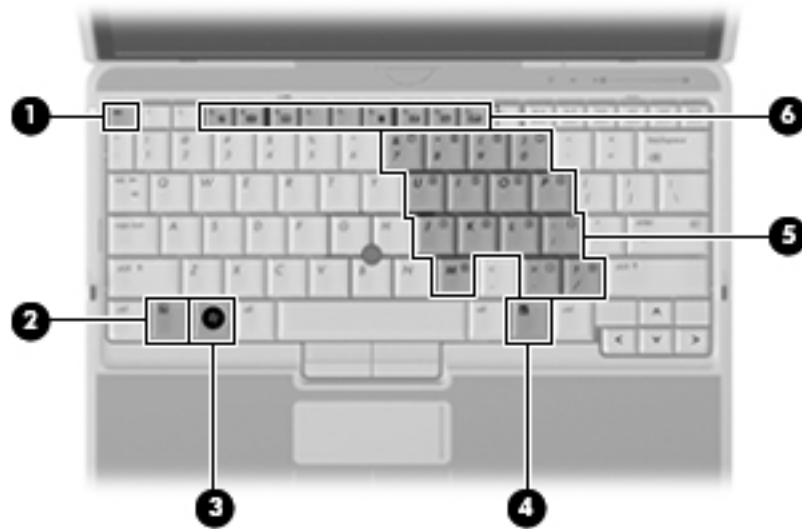

| Item | Component                    | Description  |
|------|------------------------------|--|
| ①    | esc key                      | Displays system information when pressed in combination with the <b>fn</b> key.                                  |
| ②    | fn key                       | Executes frequently used system functions when pressed in combination with a function key or the <b>esc</b> key. |
| ③    | Windows logo key             | Displays the Windows Start menu.   |
| ④    | Windows applications key     | Displays a shortcut menu for items beneath the pointer.  |
| ⑤    | Embedded numeric keypad keys | Can be used like the keys on an external numeric keypad.   |
| ⑥    | Function keys                | Execute frequently used system functions when pressed in combination with the <b>fn</b> key.                     |



## Lights



| Item | Component         | Description  |
|------|-------------------|--|
| ①    | Power light       | <ul style="list-style-type: none"> <li>■ On: The computer is on.</li> <li>■ Blinking: The computer is in the Sleep state (Windows Vista) or Standby (Windows XP).</li> <li>■ Off: The computer is off or in Hibernation.</li> </ul>  |
| ②    | Battery light     | <ul style="list-style-type: none"> <li>■ Amber: A battery is charging.</li> <li>■ Turquoise: A battery is close to full charge capacity.</li> <li>■ Blinking amber: A battery that is the only available power source has reached a low battery level. When the battery reaches a critical battery level, the battery light begins blinking rapidly.</li> <li>■ Off: If the computer is plugged into an external power source, the light turns off when all batteries in the computer are fully charged. If the computer is not plugged into an external power source, the light stays off until the battery reaches a low battery level.</li> </ul> |
| ③    | Drive light       | <ul style="list-style-type: none"> <li>■ Blinking turquoise: The hard drive is being accessed.</li> <li>■ Amber: HP 3D DriveGuard has temporarily parked the internal hard drive.</li> </ul>   |
| ④    | Caps lock light   | On: Caps lock is on.   |
| ⑤    | TouchPad light    | <ul style="list-style-type: none"> <li>■ Off: TouchPad is enabled.</li> <li>■ Amber: TouchPad is disabled.</li> </ul>  |
| ⑥    | Volume mute light | <ul style="list-style-type: none"> <li>■ Turquoise: Computer sound is on.</li> <li>■ Amber: Computer sound is off.</li> </ul>  |
| ⑦    | Volume down light | Blinking: The volume scroll zone is being used to decrease speaker volume.   |
| ⑧    | Volume up light   | Blinking: The volume scroll zone is being used to increase speaker volume.   |
| ⑨    | Num lock light    | On: Num lock is on or the embedded numeric keypad is enabled.  |

## Pointing devices



| Item | Component                    | Description   |
|------|------------------------------|---|
| 1    | TouchPad light               | <ul style="list-style-type: none"> <li>■ Off: TouchPad is enabled.</li> <li>■ Amber: TouchPad is disabled.</li> </ul> |
| 2    | TouchPad on/off control      | Enables/disables the TouchPad when pressed in combination with the <b>fn</b> key.                                     |
| 3    | Pointing stick*              | Moves the pointer and selects or activates items on the screen.   |
| 4    | <b>fn</b> key                | Enables/disables the TouchPad when pressed in combination with the <b>f5</b> key.                                     |
| 5    | Left pointing stick button*  | Functions like the left button on an external mouse.  |
| 6    | TouchPad*                    | Moves the pointer and selects or activates items on the screen.   |
| 7    | Left TouchPad button*        | Functions like the left button on an external mouse.  |
| 8    | Right TouchPad button*       | Functions like the right button on an external mouse.   |
| 9    | TouchPad scroll zone*        | Scrolls up or down.   |
| 10   | Right pointing stick button* | Functions like the right button on an external mouse.   |

\*This table describes factory settings. To view or change pointing device preferences, select **Start > Control Panel > Hardware and Sound > Mouse**.

## Front components

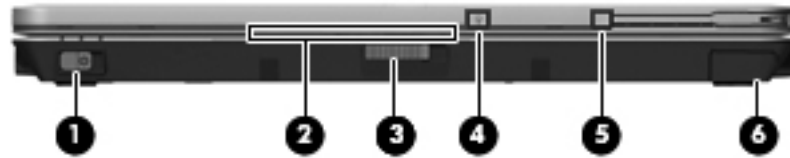

| Item | Component                    | Description  |
|------|------------------------------|--|
| ❶    | Power switch                 | <ul style="list-style-type: none"> <li>■ When the computer is off, slide the switch to the right to turn on the computer.</li> <li>■ When the computer is on, slide the switch to the right to shut down the computer.</li> <li>■ When the computer is in the Sleep state (Windows Vista) or Standby (Windows XP), slide the switch to the right briefly to exit the Sleep state or Standby.</li> <li>■ When the computer is in Hibernation, slide the switch to the right briefly to exit Hibernation.</li> </ul> <p>If the computer has stopped responding and Windows shutdown procedures are ineffective, slide the switch to the right and hold for at least 5 seconds to turn off the computer.</p> <p>To learn more about your power settings, select <b>Start &gt; Control Panel &gt; System and Maintenance &gt; Power Options</b>.</p> |
| ❷    | Business card slot           | Holds a business card in position so that the webcam can capture an image.   |
| ❸    | Display release latch        | Opens the computer.  |
| ❹    | Keyboard light button        | Opens and turns on the keyboard light.   |
| ❺    | External WWAN antenna button | Opens the external WWAN antenna.   |
| ❻    | Bluetooth compartment        | Contains an optional Bluetooth device.   |

## Right-side components

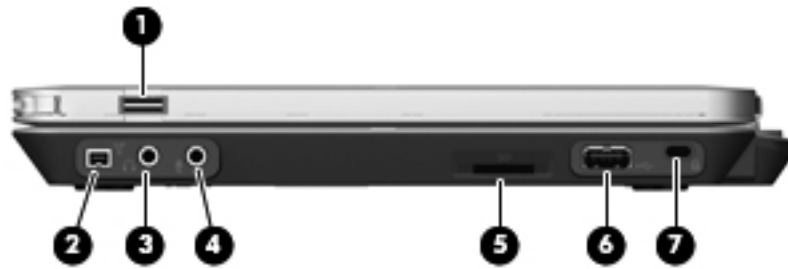



| Item | Component                                  | Description  |
|------|--|--|
| ❶    | HP Fingerprint Sensor (fingerprint reader) | Allows a fingerprint logon to Windows instead of a password logon.   |
| ❷    | 1394 port                                  | Connects an optional IEEE 1394 or 1394a device, such as a camcorder.   |
| ❸    | Audio-out (headphone) jack                 | Produces sound when connected to optional powered stereo speakers, headphones, ear buds, a headset, or television audio.   |
| ❹    | Audio-in (microphone) jack                 | Connects an optional computer headset microphone, stereo array microphone, or monaural microphone.   |
| ❺    | SD Card Reader                             | Supports the following optional digital card formats: <ul style="list-style-type: none"> <li>■ Secure Digital (SD) Memory Card</li> <li>■ MultiMediaCard (MMC)</li> </ul>  |
| ❻    | USB port                                   | Connects an optional USB device.   |
| ❼    | Security cable slot                        | Attaches an optional security cable to the computer. <p> The security cable is designed to act as a deterrent, but it may not prevent the computer from being mishandled or stolen.</p> |

## Left-side components



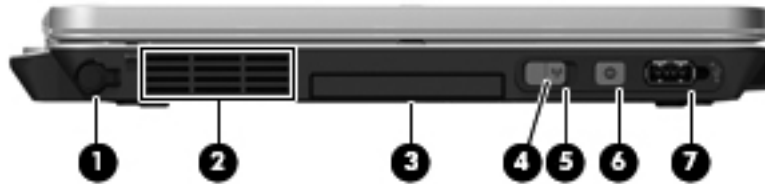

Refer to the illustration that most closely matches your computer.

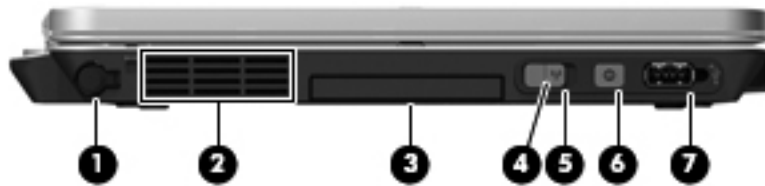

| Item | Component                             | Description   |
|------|---------------------------------------|---|
| 1    | Pen holder                            | Stores the pen.   |
| 2    | Vent                                  | Enables airflow to cool internal components.<br> The computer fan starts up automatically to cool internal components and prevent overheating. It is normal for the internal fan to cycle on and off during routine operation. |
| 3    | ExpressCard slot (select models only) | Supports optional ExpressCards.   |
| 4    | Wireless switch                       | Turns the wireless feature on or off, but does not create a wireless connection.<br> A wireless network must be set up in order to establish a wireless connection.  |
| 5    | Wireless light                        | <ul style="list-style-type: none"> <li>■ Blue: An integrated wireless device, such as a wireless local area network (WLAN) device, the HP Mobile Broadband Module, and/or a Bluetooth device, is on.</li> <li>■ Amber: All wireless devices are off.</li> </ul>   |
| 6    | Info button                           | Launches Info Center, which enables you to open various software solutions.   |
| 7    | Powered USB port                      | Provides power to a USB device, such as an optional external MultiBay, if used with a powered USB cable.  |



| Item | Component                              | Description   |
|------|--|---|
| ①    | Pen holder                             | Stores the pen.   |
| ②    | Vent                                   | Enables airflow to cool internal components.<br> The computer fan starts up automatically to cool internal components and prevent overheating. It is normal for the internal fan to cycle on and off during routine operation. |
| ③    | Smart card reader (select models only) | Supports optional smart cards and Java™ Cards.  |
| ④    | Wireless switch                        | Turns the wireless feature on or off, but does not create a wireless connection.<br> A wireless network must be set up in order to establish a wireless connection.  |
| ⑤    | Wireless light                         | <ul style="list-style-type: none"> <li>■ Blue: An integrated wireless device, such as a wireless local area network WLAN device, the HP Mobile Broadband Module, and/or a Bluetooth device, is on.</li> <li>■ Amber: All wireless devices are off.</li> </ul>   |
| ⑥    | Info button                            | Launches Info Center, which enables you to open various software solutions.   |
| ⑦    | Powered USB port                       | Provides power to a USB device, such as an optional external MultiBay, if used with a powered USB cable.  |

## Rear components



| Item | Component             | Description   |
|------|-----------------------|---|
| ①    | Jog dial              | In tablet mode, functions like the enter key and the up and down arrows on a standard keyboard. <ul style="list-style-type: none"> <li>■ Press inward to enter a command.</li> <li>■ Rotate up to scroll up.</li> <li>■ Rotate down to scroll down.</li> </ul>  |
| ②    | Esc button            | In tablet mode, allows you to exit or escape out of an application.   |
| ③    | Rotate button         | In tablet mode, switches the image between landscape and portrait orientation.  |
| ④    | Ctrl+alt+del button   | In tablet mode: <ul style="list-style-type: none"> <li>■ While Windows is running, press the button with the pen to enter the ctrl+alt+del command.*</li> <li>■ While the Computer Setup utility is running, press the button with the pen to enter the reset command. The computer resets and all unsaved information is lost. The reset function can be used to restore functionality when the system has become unresponsive.</li> </ul> |
| ⑤    | RJ-11 (modem) jack    | Connects a modem cable.   |
| ⑥    | RJ-45 (network) jack  | Connects a network cable.   |
| ⑦    | External monitor port | Connects an external VGA monitor or projector.  |
| ⑧    | Power connector       | Connects an AC adapter.   |

\*To protect your work and the system, the ctrl+alt+delete command cannot be entered using the **ctrl**, **alt**, and **del** keys on the on-screen keyboard.

## Bottom components

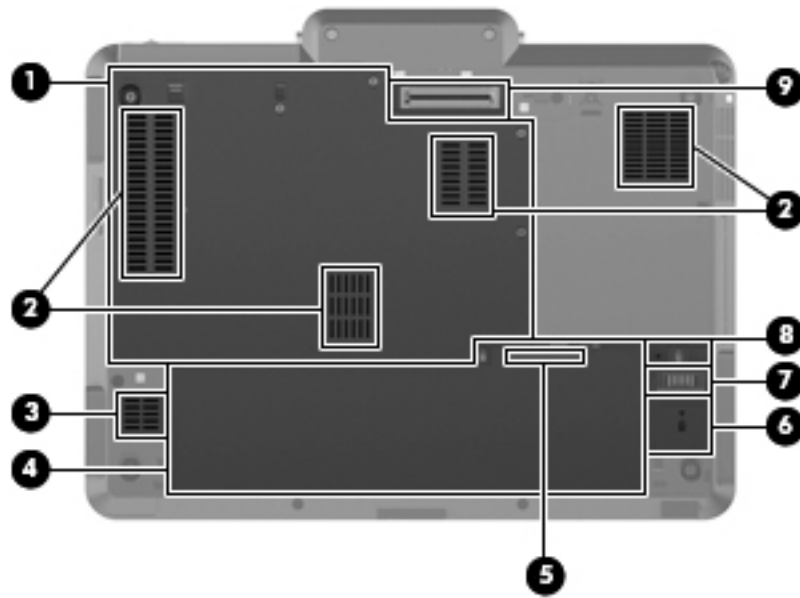

| Item | Component                        | Description  |
|------|----------------------------------|--|
| ❶    | Hard drive bay                   | Holds the hard drive, memory module slots, WLAN module (select models only), and WWAN module (select models only).   |
| ❷    | Vents (4)                        | Enable airflow to cool internal components.<br> The computer fan starts up automatically to cool internal components and prevent overheating. It is normal for the internal fan to cycle on and off during routine operation. |
| ❸    | Speaker                          | Produces sound.  |
| ❹    | Battery bay                      | Holds the battery and subscriber identity module (SIM).  |
| ❺    | Charge level indicator           | Displays the approximate remaining battery charge.   |
| ❻    | Accessory battery connector door | Slides open to expose the accessory battery connector.   |
| ❼    | Accessory battery connector      | Connects an optional accessory battery.  |
| ❽    | Battery release latch            | Releases the battery from the battery bay.   |
| ❾    | Docking connector                | Connects an optional docking device.   |



## Serial number location

The service tag, affixed to the bottom of the computer, provides information that may be needed when troubleshooting system problems. The service tag provides the following information:

- ❶ Product name: This is the product name affixed to the front of the computer.
- ❷ Serial number (s/n): This is an alphanumeric identifier that is unique to each product.
- ❸ Part number/Product number (p/n): This number provides specific information about the product's hardware components. The part number helps a service technician to determine what components and parts are needed.
- ❹ Model description: This is the number used to locate documents, drivers, and support for the computer.
- ❺ Warranty period: This number describes the duration of the warranty period for the computer.

When ordering parts or requesting information, provide the computer serial number and model description provided on the service tag.

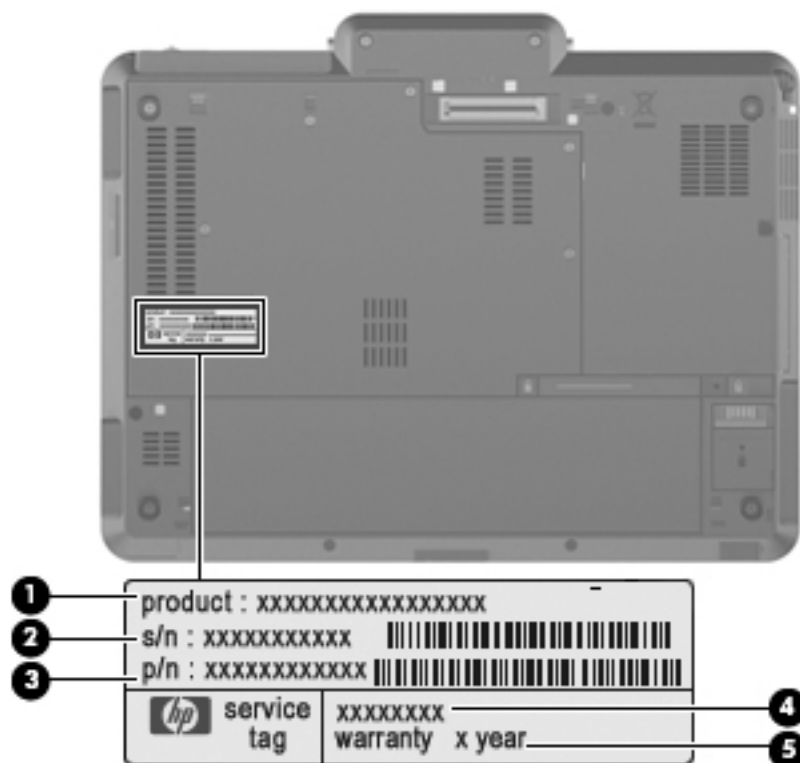

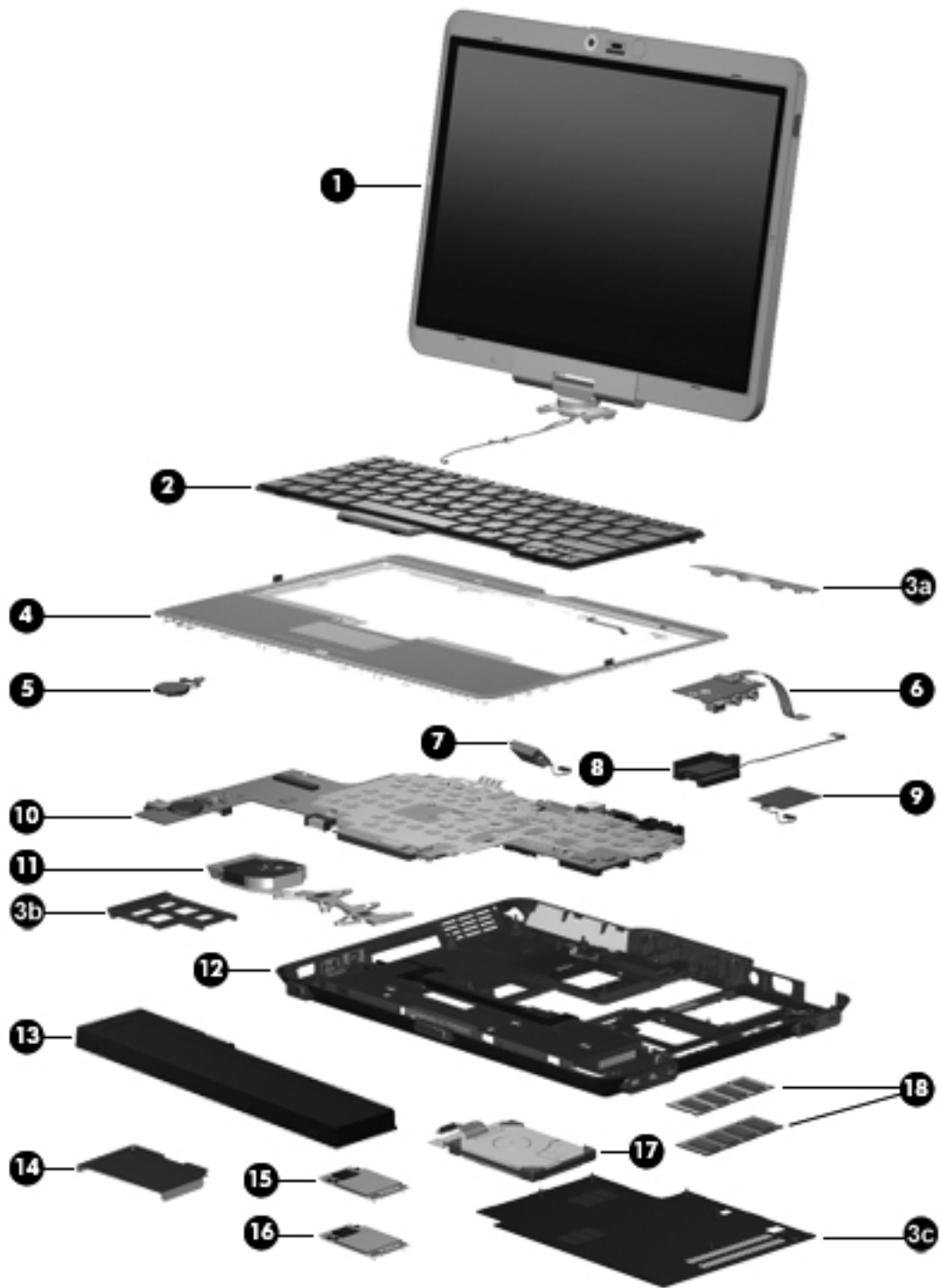

# Computer major components



| Item | Description   | Spare Part Number |
|------|---|-------------------|
| (1)  | <b>Display assembly</b> (includes ambient light sensor, fingerprint reader, logo, 2 microphones, nameplate, 2 WLAN antenna transceivers and cables, and 2 WWAN antenna transceivers and cables) |                   |
|      | 12.1-inch, WXGA LED display assembly with webcam and outdoor light  | 504172-001        |
|      | 12.1-inch, WXGA LED display assembly with webcam  | 504170-001        |
|      | 12.1-inch, WXGA LED display assembly with outdoor light   | 504171-001        |
|      | 12.1-inch, WXGA LED display assembly  | 504169-001        |
| (2)  | <b>Keyboard</b> (includes keyboard cable)   |                   |
|      | For use in Belgium  | 501493-A41        |
|      | For use in Brazil   | 501493-201        |
|      | For use the Czech Republic  | 501493-211        |
|      | For use in Denmark  | 501493-081        |
|      | For use in Finland and Sweden   | 501493-B71        |
|      | For use in France   | 501493-051        |
|      | For use in French Canada  | 501493-121        |
|      | For use in Germany  | 501493-041        |
|      | For use in Greece   | 501493-DJ1        |
|      | For use in Hungary  | 501493-221        |
|      | For use in Iceland  | 501493-DD1        |
|      | For use in Israel   | 501493-BB1        |
|      | For use in Italy  | 501493-061        |
|      | For use in Japan  | 501493-291        |
|      | For use in Latin America  | 501493-161        |
|      | For use in the Netherlands  | 501493-B31        |
|      | For use in Norway   | 501493-091        |
|      | For use in Portugal   | 501493-131        |
|      | For use in Russia   | 501493-251        |
|      | For use in Saudi Arabia   | 501493-171        |
|      | For use in Slovakia   | 501493-231        |
|      | For use in Slovenia   | 501493-BA1        |
|      | For use in South Korea  | 501493-AD1        |
|      | For use in Spain  | 501493-071        |
|      | For use in Switzerland  | 501493-BG1        |
|      | For use in Taiwan   | 501493-AB1        |
|      | For use in Thailand   | 501493-281        |
|      | For use in Turkey   | 501493-141        |
|      | For use in the United Kingdom   | 501493-031        |
|      | For use in the United States  | 501493-001        |

(Continued)

| Item | Description   | Spare Part Number        |
|------|---|--------------------------|
|      | <b>Plastics Kit</b> , includes:   | 501499-001               |
| (3a) | Hinge cover   |                          |
| (3b) | ExpressCard slot bezel  |                          |
| (3c) | Hard drive cover (includes 6 captive screws, secured by C-clips)  |                          |
|      |  See "Plastics Kit" on page 3-9 for more Plastics Kit spare part information.  |                          |
| (4)  | <b>Top cover</b> (includes LED board and cable and display alignment guides)  | 501502-001               |
| (5)  | <b>RTC battery</b> (includes double-sided tape)   | 482963-001               |
| (6)  | <b>Audio connector board</b> (includes cable)   | 507056-001               |
| (7)  | <b>Bluetooth module</b><br> The Bluetooth module spare part kit does not include a Bluetooth module cable. The Bluetooth module cable is included in the Cables Kit, spare part number 501500-001. | 483113-001               |
| (8)  | <b>Speaker</b>  | 507057-001               |
| (9)  | <b>Modem module</b> (includes module cable):<br>For use only in Australia and New Zealand<br>For use in all countries and regions except Australia and New Zealand  | 461750-011<br>461750-001 |
| (10) | <b>System board</b> (includes replacement thermal material)<br>For use in all countries and regions except for Russia and the People's Republic of China  |                          |
|      | ■ Equipped with Intel Core2 Duo SL9600 2.13-GHz processor, 1066-MHz FSB, and 6-MB L2 cache  | 530589-001               |
|      | ■ Equipped with Intel Core2 Duo SL9400 1.86-GHz processor, 1066-MHz FSB, and 6-MB L2 cache  | 501483-001               |
|      | ■ Equipped with Intel Core2 Duo SL9300 1.60-GHz processor, 1066-MHz FSB, and 6-MB L2 cache  | 501482-001               |
|      | ■ Equipped with Intel Core2 Duo SU9400 1.40-GHz processor, 800-MHz FSB, and 3-MB L2 cache   | 530590-001               |
|      | ■ Equipped with Intel Core2 Duo SU9300 1.20-GHz processor, 800-MHz FSB, and 3-MB L2 cache   | 501481-001               |
|      | For use in Russia and the People's Republic of China  |                          |
|      | ■ Equipped with Intel Core2 Duo SL9600 2.13-GHz processor, 1066-MHz FSB, and 6-MB L2 cache  | 598660-001               |
|      | ■ Equipped with Intel Core2 Duo SL9400 1.86-GHz processor, 1066-MHz FSB, and 6-MB L2 cache  | 510371-001               |
|      | ■ Equipped with Intel Core2 Duo SL9300 1.60-GHz processor, 1066-MHz FSB, and 6-MB L2 cache  | 510370-001               |
|      | ■ Equipped with Intel Core2 Duo SU9400 1.40-GHz processor, 800-MHz FSB, and 3-MB L2 cache   | 598661-001               |
|      | ■ Equipped with Intel Core2 Duo SU9300 1.20-GHz processor, 800-MHz FSB, and 3-MB L2 cache   | 510369-001               |
| (11) | <b>Fan/heat sink assembly</b> (includes replacement thermal material)   | 501495-001               |
| (12) | <b>Base enclosure</b> (includes display release latch and rubber feet)<br><b>Rubber Kit</b> (not illustrated; includes 4 rubber feet, 5 Mylar screw covers, and 2 display alignment guides)   | 501501-001<br>501496-001 |
| (13) | <b>6-cell, 4.4-Wh battery</b>   | 534060-291               |
| (14) | <b>Shield Kit</b> , includes system board shield (not illustrated) and wireless compartment shield  | 501503-001               |

(Continued)

| Item | Description   | Spare Part Number |
|------|---|-------------------|
| (15) | <b>WLAN module:</b>   |                   |
|      | Intel Wi-Fi Link 5100 802.11a/b/g WLAN module for use in all countries and regions  | 482957-001        |
|      | Intel Wi-Fi Link 5100 802.11a/b/g/n WLAN module for use in Russia, Ukraine, and Pakistan  | 506678-001        |
|      | Intel Wi-Fi Link 5100 802.11a/b/g/n WLAN module for use in all countries and regions  | 480985-001        |
|      | Broadcom 4322 802.11a/b/g/n WLAN module for use in Antigua and Barbuda, Barbados, Belize, Canada, the Cayman Islands, Guam, Puerto Rico, Trinidad and Tobago, the U.S. Virgin Islands, and the United States  | 487330-001        |
|      | Broadcom 4322 802.11a/b/g/n WLAN module for use in Afghanistan, Albania, Algeria, Andorra, Angola, Antigua and Barbuda, Argentina, Armenia, Aruba, Australia, Austria, Azerbaijan, the Bahamas, Bahrain, Bangladesh, Barbados, Belarus, Belgium, Belize, Benin, Bermuda, Bhutan, Bolivia, Bosnia and Herzegovina, Botswana, Brazil, the British Virgin Islands, Brunei, Bulgaria, Burkina Faso, Burundi, Cameroon, Cape Verde, the Central African Republic, Chad, Chile, the People's Republic of China, Colombia, Comoros, the Congo, Costa Rica, Croatia, Cyprus, the Czech Republic, Denmark, Djibouti, Dominica, the Dominican Republic, East Timor, Ecuador, Egypt, El Salvador, Equatorial Guinea, Eritrea, Estonia, Ethiopia, Fiji, Finland, France, French Guiana, Gabon, Gambia, Georgia, Germany, Ghana, Gibraltar, Greece, Grenada, Guadeloupe, Guatemala, Guinea, Guinea-Bissau, Guyana, Haiti, Honduras, Hong Kong, Hungary, Iceland, India, Ireland, Israel, Italy, the Ivory Coast, Jamaica, Jordan, Kazakhstan, Kenya, Kiribati, Kyrgyzstan, Laos, Latvia, Lebanon, Lesotho, Liberia, Liechtenstein, Lithuania, Luxembourg, Macedonia, Madagascar, Malawi, Malaysia, the Maldives, Mali, Malta, the Marshall Islands, Martinique, Mauritania, Mauritius, Mexico, Micronesia, Monaco, Mongolia, Montenegro, Morocco, Mozambique, Namibia, Nauru, Nepal, the Nether Antilles, the Netherlands, New Zealand, Nicaragua, Niger, Nigeria, Norway, Oman, Pakistan, Palau, Panama, Papua New Guinea, Paraguay, Peru, the Philippines, Poland, Portugal, the Republic of Moldova, Romania, Russia, Rwanda, Samoa, San Marino, Sao Tome and Principe, Saudi Arabia, Senegal, Serbia, the Seychelles, Sierra Leone, Singapore, Slovakia, Slovenia, the Solomon Islands, Somalia, South Africa, South Korea, Spain, Sri Lanka, St. Kitts and Nevis, St. Lucia, St. Vincent and the Grenadines, Suriname, Swaziland, Sweden, Switzerland, Taiwan, Tajikistan, Tanzania, Togo, Tonga, Trinidad and Tobago, Tunisia, Turkey, Turkmenistan, Tuvalu, Uganda, Ukraine, the United Arab Emirates, the United Kingdom, Uruguay, Uzbekistan, Vanuatu, Venezuela, Vietnam, Yemen, Zaire, Zambia, and Zimbabwe | 487330-002        |
|      | Broadcom BCM4312 802.11b/g WLAN module for use in Antigua and Barbuda, Barbados, Belize, Canada, the Cayman Islands, Guam, Puerto Rico, Trinidad and Tobago, the U.S. Virgin Islands, and the United States   | 459263-001        |

(Continued)

| Item        | Description  | Spare Part Number |
|-------------|--|-------------------|
|             | Broadcom BCM4312 802.11b/g WLAN module for use in Afghanistan, Albania, Algeria, Andorra, Angola, Antigua and Barbuda, Argentina, Armenia, Aruba, Australia, Austria, Azerbaijan, the Bahamas, Bahrain, Bangladesh, Barbados, Belarus, Belgium, Belize, Benin, Bermuda, Bhutan, Bolivia, Bosnia and Herzegovina, Botswana, Brazil, the British Virgin Islands, Brunei, Bulgaria, Burkina Faso, Burundi, Cameroon, Cape Verde, the Central African Republic, Chad, Chile, the People's Republic of China, Colombia, Comoros, the Congo, Costa Rica, Croatia, Cyprus, the Czech Republic, Denmark, Djibouti, Dominica, the Dominican Republic, East Timor, Ecuador, Egypt, El Salvador, Equatorial Guinea, Eritrea, Estonia, Ethiopia, Fiji, Finland, France, French Guiana, Gabon, Gambia, Georgia, Germany, Ghana, Gibraltar, Greece, Grenada, Guadeloupe, Guatemala, Guinea, Guinea-Bissau, Guyana, Haiti, Honduras, Hong Kong, Hungary, Iceland, India, Ireland, Israel, Italy, the Ivory Coast, Jamaica, Jordan, Kazakhstan, Kenya, Kiribati, Kyrgyzstan, Laos, Latvia, Lebanon, Lesotho, Liberia, Liechtenstein, Lithuania, Luxembourg, Macedonia, Madagascar, Malawi, Malaysia, the Maldives, Mali, Malta, the Marshall Islands, Martinique, Mauritania, Mauritius, Mexico, Micronesia, Monaco, Mongolia, Montenegro, Morocco, Mozambique, Namibia, Nauru, Nepal, the Nether Antilles, the Netherlands, New Zealand, Nicaragua, Niger, Nigeria, Norway, Oman, Pakistan, Palau, Panama, Papua New Guinea, Paraguay, Peru, the Philippines, Poland, Portugal, the Republic of Moldova, Romania, Russia, Rwanda, Samoa, San Marino, Sao Tome and Principe, Saudi Arabia, Senegal, Serbia, the Seychelles, Sierra Leone, Singapore, Slovakia, Slovenia, the Solomon Islands, Somalia, South Africa, South Korea, Spain, Sri Lanka, St. Kitts and Nevis, St. Lucia, St. Vincent and the Grenadines, Suriname, Swaziland, Sweden, Switzerland, Taiwan, Tajikistan, Tanzania, Togo, Tonga, Trinidad and Tobago, Tunisia, Turkey, Turkmenistan, Tuvalu, Uganda, Ukraine, the United Arab Emirates, the United Kingdom, Uruguay, Uzbekistan, Vanuatu, Venezuela, Vietnam, Yemen, Zaire, Zambia, and Zimbabwe | 459263-002        |
| <b>(16)</b> | <b>HSPDA EV-DO WWAN module</b>   | 483377-002        |
| <b>(17)</b> | <b>Hard drive</b> (includes bracket, isolator and connector cable)   |                   |
|             | 250-GB, 5400-rpm   | 577990-001        |
|             | 160-GB, 5400-rpm   | 509435-001        |
|             | 120-GB, 5400-rpm   | 501491-001        |
|             | 80-GB, 5400-rpm  | 501490-001        |
|             | <b>128-GB solid-state drive</b> (includes bracket, isolator and connector cable)   | 574995-001        |
|             | <b>80-GB solid-state drive</b> (includes bracket, isolator and connector cable)  | 501492-001        |
|             | <b>Hard drive connector cable</b> (not illustrated)  | 504519-001        |
| <b>(18)</b> | <b>Memory module</b> (PC2-6400, 800-MHz, DDR2)   |                   |
|             | 4096-MB  | 598855-001        |
|             | 2048-MB  | 598858-001        |
|             | 1024-MB  | 598861-001        |
|             | <b>Cable Kit</b> (not illustrated, includes audio connector board cable, see <a href="#">"Cable Kit" on page 3-7</a> for more Cable Kit information)   | 501500-001        |
|             | <b>Smart card reader</b> (not illustrated)   | 501497-001        |

## Cable Kit



| Item | Description                 | Spare part number |
|------|-----------------------------|-------------------|
|      | <b>Cable Kit:</b>           | 501500-001        |
| (1)  | Audio connector board cable |                   |
| (2)  | Bluetooth module cable      |                   |

## Mass storage devices

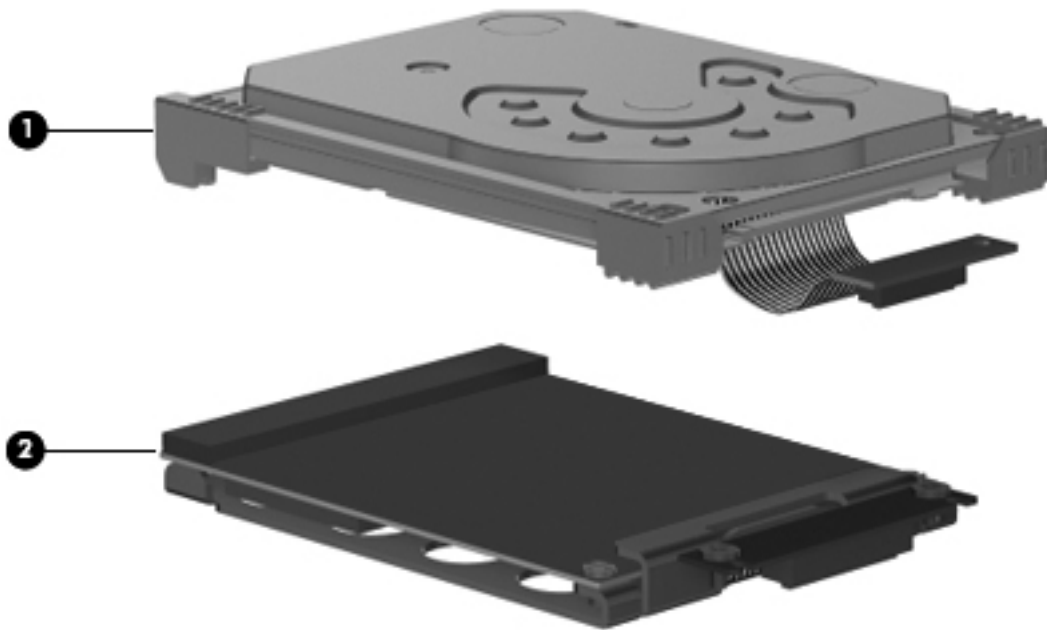

| Item | Description   | Spare part number |
|------|---|-------------------|
| (1)  | <b>Hard drive</b> (includes bracket, isolator and connector cable)        |                   |
|      | 250-GB, 5400-rpm  | 577990-001        |
|      | 160-GB, 5400-rpm  | 509435-001        |
|      | 120-GB, 5400-rpm  | 501491-001        |
|      | 80-GB, 5400-rpm   | 501490-001        |
| (2)  | <b>Solid-state drive</b> (includes bracket, isolator and connector cable) |                   |
|      | 128-GB  | 574995-001        |
|      | 80-GB   | 501492-001        |
|      | <b>Hard drive connector cable</b> (not illustrated)                       | 504519-001        |



## Plastics Kit

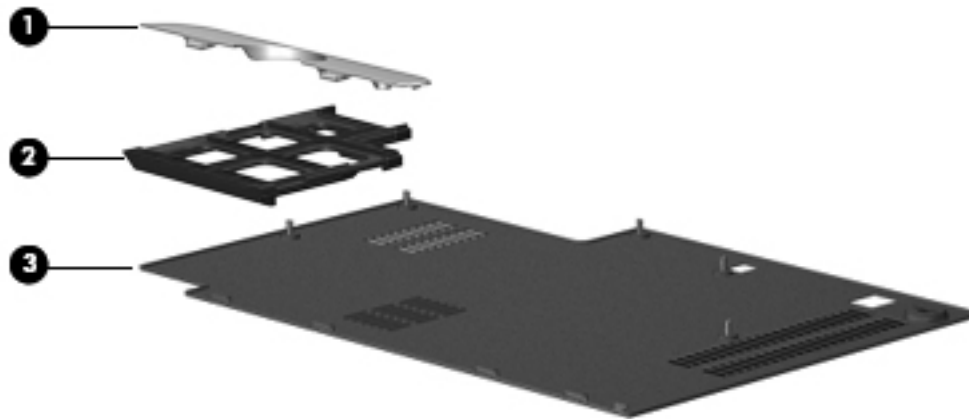

| Item | Description  | Spare part number |
|------|--|-------------------|
|      | <b>Plastics Kit:</b>   | 501499-001        |
| (1)  | Hinge cover  |                   |
| (2)  | ExpressCard slot bezel   |                   |
| (3)  | Hard drive cover (includes one captive screw, secured by a C-clip) |                   |

## Miscellaneous parts

| Description                                    | Spare part number |
|--|-------------------|
| <b>AC adapters</b>                             |                   |
| 65-W   | 463958-001        |
| 65-W for use in India                          | 577170-001        |
| 65-W (3-wire power cord)                       | 609939-001        |
| 65-W for use in India (3-wire power cord)      | 609948-001        |
| <b>Power cords:</b>                            |                   |
| For use in Argentina                           | 490371-D01        |
| For use in Australia                           | 490371-011        |
| For use in Brazil                              | 490371-201        |
| For use in the People's Republic of China      | 490371-AA1        |
| For use in Europe, the Middle East, and Africa | 490371-021        |
| For use in India                               | 490371-D61        |
| For use in Israel                              | 490371-BB1        |
| For use in Italy                               | 490371-061        |
| For use in Japan                               | 490371-291        |
| For use in North America                       | 490371-001        |
| For use in South Africa                        | 490371-AR1        |
| For use in South Korea                         | 490371-AD1        |
| For use in Switzerland                         | 490371-111        |
| For use in Taiwan                              | 490371-AB1        |
| For use in the United Kingdom                  | 490371-031        |
| <b>Screw Kit</b>                               | 501498-001        |
| ■ Phillips PM2.5×7.0 captive screw             |                   |
| ■ Phillips PM2.5×4.0 screw                     |                   |
| ■ Phillips PM2.0×5.0 captive screw             |                   |
| ■ Phillips PM2.0×5.0 screw                     |                   |
| ■ Phillips PM2.0×4.0 screw                     |                   |
| ■ Phillips PM2.0×3.0 screw                     |                   |
| ■ Torx T8M2.5×6.0 screw                        |                   |
| ■ Torx T8M2.0×8.0 screw                        |                   |
| ■ Torx T8M2.0×5.0 screw                        |                   |
| <b>Antenna, external</b>                       | 592489-001        |
| <b>Pointing stick rubber cap</b>               | 486565-001        |
| <b>HP Docking Station</b>                      | 455953-001        |
| <b>Pen with tether</b>                         | 501494-001        |

## Sequential part number listing

| Spare part number | Description  |
|-------------------|--|
| 455953-001        | HP Docking Station   |
| 459263-001        | Broadcom BCM4312 802.11b/g WLAN module for use in Antigua and Barbuda, Barbados, Belize, Canada, the Cayman Islands, Guam, Puerto Rico, Trinidad and Tobago, the U.S. Virgin Islands, and the United States  |
| 459263-002        | Broadcom BCM4312 802.11b/g WLAN module for use in Afghanistan, Albania, Algeria, Andorra, Angola, Antigua and Barbuda, Argentina, Armenia, Aruba, Australia, Austria, Azerbaijan, the Bahamas, Bahrain, Bangladesh, Barbados, Belarus, Belgium, Belize, Benin, Bermuda, Bhutan, Bolivia, Bosnia and Herzegovina, Botswana, Brazil, the British Virgin Islands, Brunei, Bulgaria, Burkina Faso, Burundi, Cameroon, Cape Verde, the Central African Republic, Chad, Chile, the People's Republic of China, Colombia, Comoros, the Congo, Costa Rica, Croatia, Cyprus, the Czech Republic, Denmark, Djibouti, Dominica, the Dominican Republic, East Timor, Ecuador, Egypt, El Salvador, Equatorial Guinea, Eritrea, Estonia, Ethiopia, Fiji, Finland, France, French Guiana, Gabon, Gambia, Georgia, Germany, Ghana, Gibraltar, Greece, Grenada, Guadeloupe, Guatemala, Guinea, Guinea-Bissau, Guyana, Haiti, Honduras, Hong Kong, Hungary, Iceland, India, Ireland, Israel, Italy, the Ivory Coast, Jamaica, Jordan, Kazakhstan, Kenya, Kiribati, Kyrgyzstan, Laos, Latvia, Lebanon, Lesotho, Liberia, Liechtenstein, Lithuania, Luxembourg, Macedonia, Madagascar, Malawi, Malaysia, the Maldives, Mali, Malta, the Marshall Islands, Martinique, Mauritania, Mauritius, Mexico, Micronesia, Monaco, Mongolia, Montenegro, Morocco, Mozambique, Namibia, Nauru, Nepal, the Nether Antilles, the Netherlands, New Zealand, Nicaragua, Niger, Nigeria, Norway, Oman, Pakistan, Palau, Panama, Papua New Guinea, Paraguay, Peru, the Philippines, Poland, Portugal, the Republic of Moldova, Romania, Russia, Rwanda, Samoa, San Marino, Sao Tome and Principe, Saudi Arabia, Senegal, Serbia, the Seychelles, Sierra Leone, Singapore, Slovakia, Slovenia, the Solomon Islands, Somalia, South Africa, South Korea, Spain, Sri Lanka, St. Kitts and Nevis, St. Lucia, St. Vincent and the Grenadines, Suriname, Swaziland, Sweden, Switzerland, Taiwan, Tajikistan, Tanzania, Togo, Tonga, Trinidad and Tobago, Tunisia, Turkey, Turkmenistan, Tuvalu, Uganda, Ukraine, the United Arab Emirates, the United Kingdom, Uruguay, Uzbekistan, Vanuatu, Venezuela, Vietnam, Yemen, Zaire, Zambia, and Zimbabwe |
| 461750-001        | Modem module for use in all countries and regions except Australia and New Zealand (includes module cable)   |
| 461750-011        | Modem module for use only in Australia and New Zealand (includes module cable)   |
| 463958-001        | 65-W AC adapter  |
| 480985-001        | Intel Wi-Fi Link 5100 802.11a/b/g/n WLAN module for use in all countries and regions   |
| 482957-001        | Intel Wi-Fi Link 5100 802.11a/b/g WLAN module for use in all countries and regions   |
| 482963-001        | RTC battery (includes double-sided tape)   |
| 483113-001        | Bluetooth module<br> The Bluetooth module spare part kit does not include a Bluetooth module cable. The Bluetooth module cable is included in the Cables Kit, spare part number 501500-001.   |
| 483377-002        | HSPDA EV-DO WWAN module  |
| 486565-001        | Pointing stick rubber cap  |
| 487330-001        | Broadcom 4322 802.11a/b/g/n WLAN module for use in Antigua and Barbuda, Barbados, Belize, Canada, the Cayman Islands, Guam, Puerto Rico, Trinidad and Tobago, the U.S. Virgin Islands, and the United States   |



(Continued)

| Spare part number | Description   |
|-------------------|---|
| 487330-002        | Broadcom 4322 802.11a/b/g/n WLAN module for use in Afghanistan, Albania, Algeria, Andorra, Angola, Antigua and Barbuda, Argentina, Armenia, Aruba, Australia, Austria, Azerbaijan, the Bahamas, Bahrain, Bangladesh, Barbados, Belarus, Belgium, Belize, Benin, Bermuda, Bhutan, Bolivia, Bosnia and Herzegovina, Botswana, Brazil, the British Virgin Islands, Brunei, Bulgaria, Burkina Faso, Burundi, Cameroon, Cape Verde, the Central African Republic, Chad, Chile, the People's Republic of China, Colombia, Comoros, the Congo, Costa Rica, Croatia, Cyprus, the Czech Republic, Denmark, Djibouti, Dominica, the Dominican Republic, East Timor, Ecuador, Egypt, El Salvador, Equatorial Guinea, Eritrea, Estonia, Ethiopia, Fiji, Finland, France, French Guiana, Gabon, Gambia, Georgia, Germany, Ghana, Gibraltar, Greece, Grenada, Guadeloupe, Guatemala, Guinea, Guinea-Bissau, Guyana, Haiti, Honduras, Hong Kong, Hungary, Iceland, India, Ireland, Israel, Italy, the Ivory Coast, Jamaica, Jordan, Kazakhstan, Kenya, Kiribati, Kyrgyzstan, Laos, Latvia, Lebanon, Lesotho, Liberia, Liechtenstein, Lithuania, Luxembourg, Macedonia, Madagascar, Malawi, Malaysia, the Maldives, Mali, Malta, the Marshall Islands, Martinique, Mauritania, Mauritius, Mexico, Micronesia, Monaco, Mongolia, Montenegro, Morocco, Mozambique, Namibia, Nauru, Nepal, the Nether Antilles, the Netherlands, New Zealand, Nicaragua, Niger, Nigeria, Norway, Oman, Pakistan, Palau, Panama, Papua New Guinea, Paraguay, Peru, the Philippines, Poland, Portugal, the Republic of Moldova, Romania, Russia, Rwanda, Samoa, San Marino, Sao Tome and Principe, Saudi Arabia, Senegal, Serbia, the Seychelles, Sierra Leone, Singapore, Slovakia, Slovenia, the Solomon Islands, Somalia, South Africa, South Korea, Spain, Sri Lanka, St. Kitts and Nevis, St. Lucia, St. Vincent and the Grenadines, Suriname, Swaziland, Sweden, Switzerland, Taiwan, Tajikistan, Tanzania, Togo, Tonga, Trinidad and Tobago, Tunisia, Turkey, Turkmenistan, Tuvalu, Uganda, Ukraine, the United Arab Emirates, the United Kingdom, Uruguay, Uzbekistan, Vanuatu, Venezuela, Vietnam, Yemen, Zaire, Zambia, and Zimbabwe |
| 490371-001        | Power cord for use in North America   |
| 490371-011        | Power cord for use in Australia   |
| 490371-021        | Power cord for use in Europe, the Middle East, and Africa   |
| 490371-031        | Power cord for use in the United Kingdom  |
| 490371-061        | Power cord for use in Italy   |
| 490371-011        | Power cord for use in Switzerland   |
| 490371-201        | Power cord for use in Brazil  |
| 490371-291        | Power cord for use in Japan   |
| 490371-AA1        | Power cord for use in the People's Republic of China  |
| 490371-AB1        | Power cord for use in Taiwan  |
| 490371-AD1        | Power cord for use in South Korea   |
| 490371-AR1        | Power cord for use in South Africa  |
| 490371-BB1        | Power cord for use in Israel  |
| 490371-D01        | Power cord for use in Argentina   |
| 490371-D61        | Power cord for use in India   |
| 501481-001        | System board equipped with Intel Core2 Duo SU9300 1.20-GHz processor, 800-MHz FSB, and 3-MB L2 cache (includes thermal replacement material) for use in all countries and regions except for Russia and the People's Republic of China  |
| 501482-001        | System board equipped with Intel Core2 Duo SL9300 1.60-GHz processor, 1066-MHz FSB, and 6-MB L2 cache (includes thermal replacement material) for use in all countries and regions except for Russia and the People's Republic of China   |
| 501483-001        | System board equipped with Intel Core2 Duo SL9400 1.86-GHz processor, 1066-MHz FSB, and 6-MB L2 cache (includes thermal replacement material) for use in all countries and regions except for Russia and the People's Republic of China   |
| 501490-001        | 80-GB, 5400-rpm, 1.8-inch hard drive (include bracket, isolator and connector cable)  |

(Continued)

| <b>Spare part number</b> | <b>Description</b>  |
|--------------------------|---|
| 501491-001               | 120-GB, 5400-rpm, 1.8-inch hard drive (include bracket, isolator and connector cable)     |
| 501492-001               | 1.8-inch, 80-GB solid-state drive (include bracket, isolator and connector cable)         |
| 501494-001               | Pen with tether   |
| 501497-001               | Smart card reader   |
| 501493-001               | Keyboard for use in the United States   |
| 501493-031               | Keyboard for use in the United Kingdom  |
| 501493-041               | Keyboard for use in Germany   |
| 501493-051               | Keyboard for use in France  |
| 501493-061               | Keyboard for use in Italy   |
| 501493-071               | Keyboard for use in Spain   |
| 501493-081               | Keyboard for use in Denmark   |
| 501493-091               | Keyboard for use in Norway  |
| 501493-121               | Keyboard for use in French Canada   |
| 501493-131               | Keyboard for use in Portugal  |
| 501493-141               | Keyboard for use in Turkey  |
| 501493-161               | Keyboard for use in Latin America   |
| 501493-171               | Keyboard for use in Saudi Arabia  |
| 501493-201               | Keyboard for use in Brazil  |
| 501493-211               | Keyboard for use in the Czech Republic  |
| 501493-221               | Keyboard for use in Hungary   |
| 501493-231               | Keyboard for use in Slovakia  |
| 501493-251               | Keyboard for use in Russia  |
| 501493-281               | Keyboard for use in Thailand  |
| 501493-291               | Keyboard for use in Japan   |
| 501493-A41               | Keyboard for use in Belgium   |
| 501493-AB1               | Keyboard for use in Taiwan  |
| 501493-AD1               | Keyboard for use in South Korea   |
| 501493-B31               | Keyboard for use in the Netherlands   |
| 501493-B71               | Keyboard for use in Finland and Sweden  |
| 501493-BB1               | Keyboard for use in Israel  |
| 501493-BG1               | Keyboard for use in Switzerland   |
| 501493-DD1               | Keyboard for use in Iceland   |
| 501493-DJ1               | Keyboard for use in Greece  |
| 501495-001               | Fan/heat sink assembly (includes replacement thermal material)                            |
| 501496-001               | Rubber Kit (includes 4 rubber feet, 5 Mylar screw covers, and 2 display alignment guides) |
| 501498-001               | Screw Kit   |

*(Continued)*

| Spare part number | Description  |
|-------------------|--|
| 501499-001        | Plastics Kit<br> See <a href="#">“Plastics Kit” on page 3-9</a> for more Plastics Kit spare part information.   |
| 501500-001        | Cable Kit<br> See <a href="#">“Cable Kit” on page 3-7</a> for more Cable Kit information.   |
| 501501-001        | Base enclosure (includes display release latch and rubber feet)  |
| 501502-001        | Top cover (includes LED board and cable and display alignment guides)  |
| 501503-001        | Shield Kit   |
| 504169-001        | 12.1-inch, WXGA LED display assembly (includes ambient light sensor, fingerprint reader, logo, 2 microphones, nameplate, 2 WLAN antenna transceivers and cables, and 2 WWAN antenna transceivers and cables)                               |
| 504170-001        | 12.1-inch, WXGA LED display assembly with webcam (includes ambient light sensor, fingerprint reader, logo, 2 microphones, nameplate, 2 WLAN antenna transceivers and cables, and 2 WWAN antenna transceivers and cables)                   |
| 504171-001        | 12.1-inch, WXGA LED display assembly with outdoor light (includes ambient light sensor, fingerprint reader, logo, 2 microphones, nameplate, 2 WLAN antenna transceivers and cables, and 2 WWAN antenna transceivers and cables)            |
| 504172-001        | 12.1-inch, WXGA LED display assembly with webcam and outdoor light (includes ambient light sensor, fingerprint reader, logo, 2 microphones, nameplate, 2 WLAN antenna transceivers and cables, and 2 WWAN antenna transceivers and cables) |
| 504519-001        | Hard drive connector cable   |
| 506678-001        | Intel Wi-Fi Link 5100 802.11a/b/g/n WLAN module for use in Russia, Ukraine, and Pakistan   |
| 507056-001        | Audio connector board (includes cable)   |
| 507057-001        | Speaker  |
| 509435-001        | 160-GB, 5400-rpm (include bracket, isolator and connector cable)   |
| 510369-001        | System board equipped with Intel Core2 Duo SU9300 1.20-GHz processor, 800-MHz FSB, and 3-MB L2 cache (includes thermal replacement material) for use in Russia and the People’s Republic of China  |
| 510370-001        | System board equipped with Intel Core2 Duo SL9300 1.60-GHz processor, 1066-MHz FSB, and 6-MB L2 cache (includes thermal replacement material) for use in Russia and the People’s Republic of China   |
| 510371-001        | System board equipped with Intel Core2 Duo SL9400 1.86-GHz processor, 1066-MHz FSB, and 6-MB L2 cache (includes thermal replacement material) for use in Russia and the People’s Republic of China   |
| 530589-001        | System board equipped with Intel Core2 Duo SL9600 2.13-GHz processor, 800-MHz FSB, and 3-MB L2 cache (includes thermal replacement material) for use in all countries and regions except for Russia and the People’s Republic of China     |
| 530590-001        | System board equipped with Intel Core2 Duo SU9400 1.40-GHz processor, 800-MHz FSB, and 3-MB L2 cache (includes thermal replacement material) for use in all countries and regions except for Russia and the People’s Republic of China     |
| 534060-291        | 6-cell, 4.4-Wh battery   |
| 574995-001        | 1.8-inch, 128-GB solid-state drive (include bracket, isolator and connector cable)   |
| 577170-001        | 65-W AC adapter for use in India   |
| 577990-001        | 250-GB, 5400-rpm (include bracket, isolator and connector cable)   |
| 592489-001        | Antenna, external  |

(Continued)

| <b>Spare part number</b> | <b>Description</b>  |
|--------------------------|---|
| 598660-001               | System board equipped with Intel Core2 Duo SL9600 2.13-GHz processor, 800-MHz FSB, and 3-MB L2 cache (includes thermal replacement material) for use in Russia and the People's Republic of China     |
| 598661-001               | System board equipped with Intel Core2 Duo SU9400 1.40-GHz processor, 800-MHz FSB, and 3-MB L2 cache (includes thermal replacement material) for use in for Russia and the People's Republic of China |
| 598855-001               | 4096-MB memory module (PC2-6400, 800-MHz, DDR2)   |
| 598858-001               | 2048-MB memory module (PC2-6400, 800-MHz, DDR2)   |
| 598861-001               | 1024-MB memory module (PC2-6400, 800-MHz, DDR2)   |
| 609939-001               | 65-W AC adapter (requires 3-wire power cord)  |
| 609948-001               | 65-W AC adapter for use in India (requires 3-wire power cord)   |





---

# Removal and replacement procedures

## Preliminary replacement requirements

### Tools required

You will need the following tools to complete the removal and replacement procedures:

- Flat-bladed screwdriver
- Magnetic screwdriver
- Phillips P0 and P1 screwdrivers
- Torx T8 screwdriver

### Service considerations

The following sections include some of the considerations that you must keep in mind during disassembly and assembly procedures.



---

As you remove each subassembly from the computer, place the subassembly (and all accompanying screws) away from the work area to prevent damage.

---

### Plastic parts



---

**CAUTION:** Using excessive force during disassembly and reassembly can damage plastic parts. Use care when handling the plastic parts. Apply pressure only at the points designated in the maintenance instructions.

---

### Cables and connectors



---

**CAUTION:** When servicing the computer, be sure that cables are placed in their proper locations during the reassembly process. Improper cable placement can damage the computer.

---

Cables must be handled with extreme care to avoid damage. Apply only the tension required to unseat or seat the cables during removal and insertion. Handle cables by the connector whenever possible. In all cases, avoid bending, twisting, or tearing cables. Be sure that cables are routed in such a way that they cannot be caught or snagged by parts being removed or replaced. Handle flex cables with extreme care; these cables tear easily.

## Drive handling



**CAUTION:** Drives are fragile components that must be handled with care. To prevent damage to the computer, damage to a drive, or loss of information, observe these precautions:

- Before removing or inserting a hard drive, shut down the computer. If you are unsure whether the computer is off or in Hibernation, turn the computer on, and then shut it down through the operating system.
  - Before handling a drive, be sure that you are discharged of static electricity. While handling a drive, avoid touching the connector.
  - Handle drives on surfaces covered with at least one inch of shock-proof foam.
  - Avoid dropping drives from any height onto any surface.
  - After removing a hard drive, an optical drive, or a diskette drive, place it in a static-proof bag.
  - Avoid exposing a hard drive to products that have magnetic fields, such as monitors or speakers.
  - Avoid exposing a drive to temperature extremes or liquids.
  - If a drive must be mailed, place the drive in a bubble pack mailer or other suitable form of protective packaging and label the package "FRAGILE."
- 

## Grounding guidelines

### Electrostatic discharge damage

Electronic components are sensitive to electrostatic discharge (ESD). Circuitry design and structure determine the degree of sensitivity. Networks built into many integrated circuits provide some protection, but in many cases, ESD contains enough power to alter device parameters or melt silicon junctions.

A discharge of static electricity from a finger or other conductor can destroy static-sensitive devices or microcircuitry. Even if the spark is neither felt nor heard, damage may have occurred.

An electronic device exposed to ESD may not be affected at all and may work perfectly throughout a normal cycle. Or the device may function normally for a while, and then degrade in the internal layers, reducing its life expectancy.



**CAUTION:** To prevent damage to the computer when you are removing or installing internal components, observe these precautions:

- Keep components in their electrostatic-safe containers until you are ready to install them.
  - Use nonmagnetic tools.
  - Before touching an electronic component, discharge static electricity by using the guidelines described in this section.
  - Avoid touching pins, leads, and circuitry. Handle electronic components as little as possible.
  - If you remove a component, place it in an electrostatic-safe container.
-

The following table shows how humidity affects the electrostatic voltage levels generated by different activities.



**CAUTION:** A product can be degraded by as little as 700 V.

| Typical electrostatic voltage levels |                   |          |         |
|--------------------------------------|-------------------|----------|---------|
| Event                                | Relative humidity |          |         |
|                                      | 10%               | 40%      | 55%     |
| Walking across carpet                | 35,000 V          | 15,000 V | 7,500 V |
| Walking across vinyl floor           | 12,000 V          | 5,000 V  | 3,000 V |
| Motions of bench worker              | 6,000 V           | 800 V    | 400 V   |
| Removing DIPS from plastic tube      | 2,000 V           | 700 V    | 400 V   |
| Removing DIPS from vinyl tray        | 11,500 V          | 4,000 V  | 2,000 V |
| Removing DIPS from Styrofoam         | 14,500 V          | 5,000 V  | 3,500 V |
| Removing bubble pack from PCB        | 26,500 V          | 20,000 V | 7,000 V |
| Packing PCBs in foam-lined box       | 21,000 V          | 11,000 V | 5,000 V |

## Packaging and transporting guidelines

Follow these grounding guidelines when packaging and transporting equipment:

- To avoid hand contact, transport products in static-safe tubes, bags, or boxes.
- Protect ESD-sensitive parts and assemblies with conductive or approved containers or packaging.
- Keep ESD-sensitive parts in their containers until the parts arrive at static-free workstations.
- Place items on a grounded surface before removing items from their containers.
- Always be properly grounded when touching a component or assembly.
- Store reusable ESD-sensitive parts from assemblies in protective packaging or nonconductive foam.
- Use transporters and conveyors made of antistatic belts and roller bushings. Be sure that mechanized equipment used for moving materials is wired to ground and that proper materials are selected to avoid static charging. When grounding is not possible, use an ionizer to dissipate electric charges.

## Workstation guidelines

Follow these grounding workstation guidelines:

- Cover the workstation with approved static-shielding material.
- Use a wrist strap connected to a properly grounded work surface and use properly grounded tools and equipment.
- Use conductive field service tools, such as cutters, screwdrivers, and vacuums.
- When fixtures must directly contact dissipative surfaces, use fixtures made only of static-safe materials.
- Keep the work area free of nonconductive materials, such as ordinary plastic assembly aids and Styrofoam.
- Handle ESD-sensitive components, parts, and assemblies by the case or PCM laminate. Handle these items only at static-free workstations.
- Avoid contact with pins, leads, or circuitry.
- Turn off power and input signals before inserting or removing connectors or test equipment.

## Equipment guidelines

Grounding equipment must include either a wrist strap or a foot strap at a grounded workstation.

- When seated, wear a wrist strap connected to a grounded system. Wrist straps are flexible straps with a minimum of one megohm  $\pm 10\%$  resistance in the ground cords. To provide proper ground, wear a strap snugly against the skin at all times. On grounded mats with banana-plug connectors, use alligator clips to connect a wrist strap.
- When standing, use foot straps and a grounded floor mat. Foot straps (heel, toe, or boot straps) can be used at standing workstations and are compatible with most types of shoes or boots. On conductive floors or dissipative floor mats, use foot straps on both feet with a minimum of one megohm resistance between the operator and ground. To be effective, the conductive strips must be worn in contact with the skin.

The following grounding equipment is recommended to prevent electrostatic damage:

- Antistatic tape
- Antistatic smocks, aprons, and sleeve protectors
- Conductive bins and other assembly or soldering aids
- Nonconductive foam
- Conductive tabletop workstations with ground cords of one megohm resistance
- Static-dissipative tables or floor mats with hard ties to the ground
- Field Service Kits

- Static awareness labels
- Material-handling packages
- Nonconductive plastic bags, tubes, or boxes
- Metal tote boxes
- Electrostatic voltage levels and protective materials

The following table lists the shielding protection provided by antistatic bags and floor mats.

| Material              | Use        | Voltage protection level |
|-----------------------|------------|--------------------------|
| Antistatic plastic    | Bags       | 1,500 V                  |
| Carbon-loaded plastic | Floor mats | 7,500 V                  |
| Metallized laminate   | Floor mats | 5,000 V                  |

## Unknown user password

If the computer you are servicing has an unknown user password, follow these steps to clear the password:



These steps also clear CMOS.

1. Shut down the computer. If you are unsure whether the computer is off or in Hibernation, turn the computer on, and then shut it down through the operating system.
2. Disconnect all external devices connected to the computer.
3. Disconnect the power from the computer by first unplugging the power cord from the AC outlet and then unplugging the AC adapter from the computer.
4. Remove the battery (see [“Battery” on page 4-8](#)).
5. Remove the real-time clock (RTC) battery (see [“RTC battery” on page 4-23](#)).
6. Wait approximately 5 minutes.
7. Replace the RTC battery and reassemble the computer.
8. Connect AC power to the computer. Do not reinsert any batteries at this time.
9. Turn on the computer.

All passwords and all CMOS settings have been cleared.

## Component replacement procedures

This chapter provides removal and replacement procedures.

There are as many as 49 screws, in 9 different sizes, that must be removed, replaced, or loosened when servicing the computer. Make special note of each screw size and location during removal and replacement.

### Serial number location

The service tag, affixed to the bottom of the computer, provides information that may be needed when troubleshooting system problems. The service tag provides the following information:

- ❶ Product name: This is the product name affixed to the front of the computer.
- ❷ Serial number (s/n): This is an alphanumeric identifier that is unique to each product.
- ❸ Part number/Product number (p/n): This number provides specific information about the product's hardware components. The part number helps a service technician to determine what components and parts are needed.
- ❹ Model description: This is the number used to locate documents, drivers, and support for the computer.
- ❺ Warranty period: This number describes the duration of the warranty period for the computer.

When ordering parts or requesting information, provide the computer serial number and model description provided on the service tag.

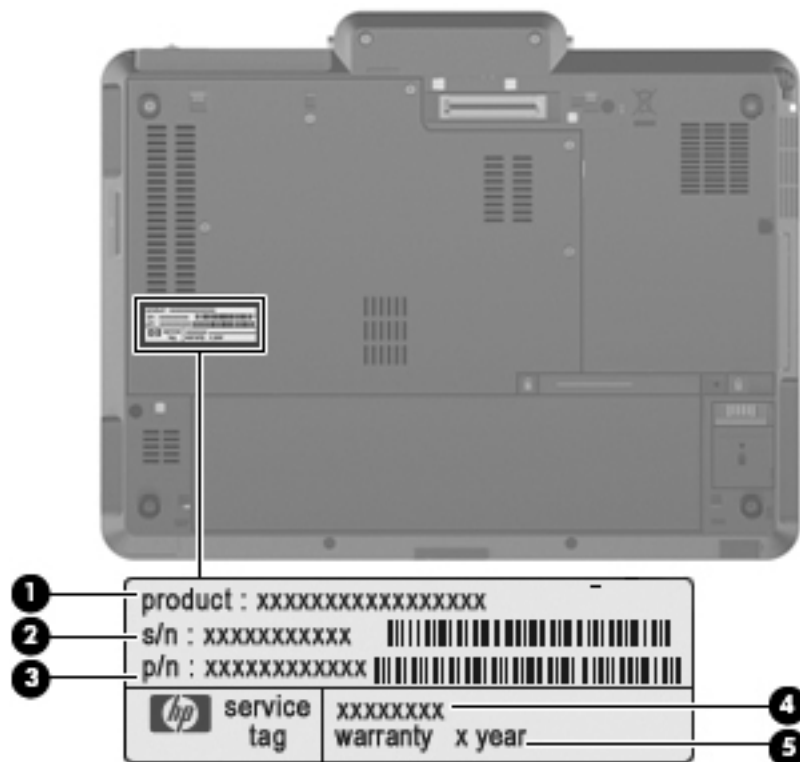

## Computer feet

The computer feet are adhesive-backed rubber pads. The feet are included in the Rubber Kit, spare part number 501496-001. There are four rubber feet that attach to the base enclosure in the locations illustrated below.

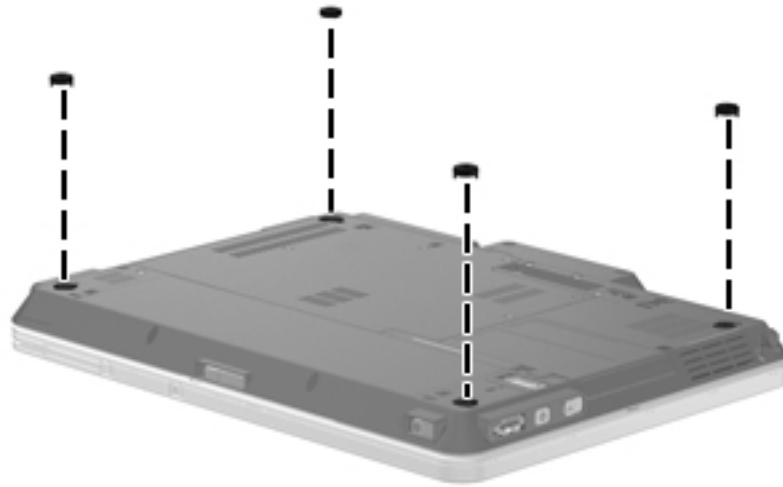

## Battery

| Description            | Spare part number |
|------------------------|-------------------|
| 6-cell, 4.4-Wh battery | 534060-291        |

Before disassembling the computer, follow these steps:

1. Shut down the computer. If you are unsure whether the computer is off or in Hibernation, turn the computer on, and then shut it down through the operating system.
2. Disconnect all external devices connected to the computer.
3. Disconnect the power from the computer by first unplugging the power cord from the AC outlet and then unplugging the AC adapter from the computer.

Remove the battery:

1. Turn the computer upside down on a flat surface, with the battery bay toward you.
2. Slide the battery release latch **1** to release the battery.
3. Pivot the rear edge of the battery **2** upward and remove it **3** from the computer.

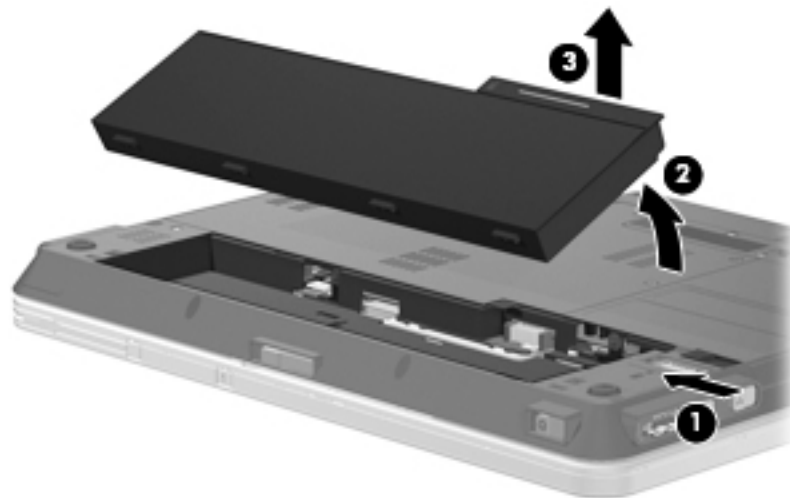

To insert the battery, insert the front edge of the battery into the battery bay and pivot the rear edge of the battery downward until it is seated. The battery release latch automatically locks the battery into place.



## SIM



This section applies only to computer models with WWAN capability.



If there is a SIM inserted in the SIM slot, it must be removed before disassembling the computer. Be sure that the SIM is reinserted in the SIM slot after reassembling the computer.

Before removing the SIM, follow these steps:

1. Shut down the computer. If you are unsure whether the computer is off or in Hibernation, turn the computer on, and then shut it down through the operating system.
2. Disconnect all external devices connected to the computer.
3. Disconnect the power from the computer by first unplugging the power cord from the AC outlet and then unplugging the AC adapter from the computer.
4. Remove the battery (see “[Battery](#)” on page 4-8).

Remove the SIM:

1. Press in on the SIM ❶. (The module is partially ejected from the SIM slot.)
2. Remove the SIM ❷ from the SIM slot.

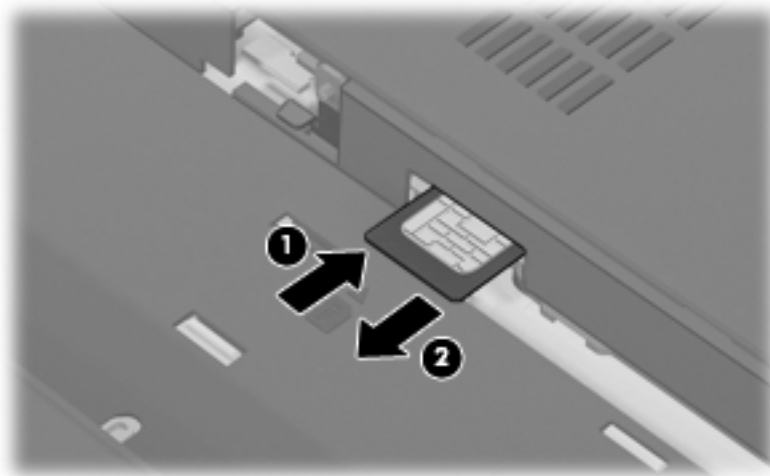

Reverse this procedure to install the SIM.

## Hard drive



The hard drive spare part kit includes a hard drive bracket, hard drive isolator, and hard drive connector cable.

| Description                           | Spare part number |
|---------------------------------------|-------------------|
| 250-GB, 5400-rpm, 1.8-inch hard drive | 577990-001        |
| 160-GB, 5400-rpm, 1.8-inch hard drive | 509435-001        |
| 120-GB, 5400-rpm, 1.8-inch hard drive | 501490-001        |
| 80-GB, 5400-rpm, 1.8-inch hard drive  | 501491-001        |
| 128-GB solid-state drive              | 574995-001        |
| 80-GB solid-state drive               | 501492-001        |
| Hard drive connector cable            | 504519-001        |

Before removing the hard drive, follow these steps:

1. Shut down the computer. If you are unsure whether the computer is off or in Hibernation, turn the computer on, and then shut it down through the operating system.
2. Disconnect all external devices connected to the computer.
3. Disconnect the power from the computer by first unplugging the power cord from the AC outlet and then unplugging the AC adapter from the computer.
4. Remove the battery (see “Battery” on page 4-8).
5. Remove the SIM (see “SIM” on page 4-9).

Remove the hard drive:

1. Loosen the six Phillips PM2.0x5.0 captive screws ❶ that secure the hard drive cover to the computer.
2. Lift the rear edge of the hard drive cover ❷ until it rests at an angle, and then remove the hard drive cover. The hard drive cover is included in the Plastics Kit, spare part number 501499-001.

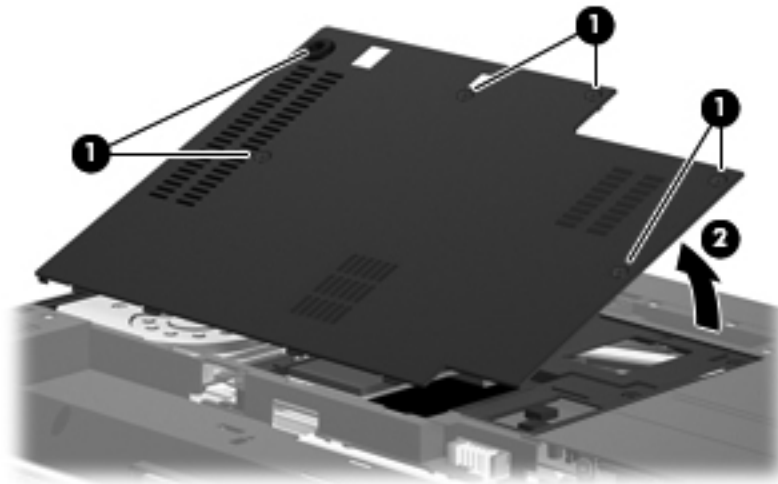

3. Remove the two Phillips PM2.0×3.0 screws ❶ that secure the hard drive bracket to the computer.
4. Remove the hard drive bracket ❷.

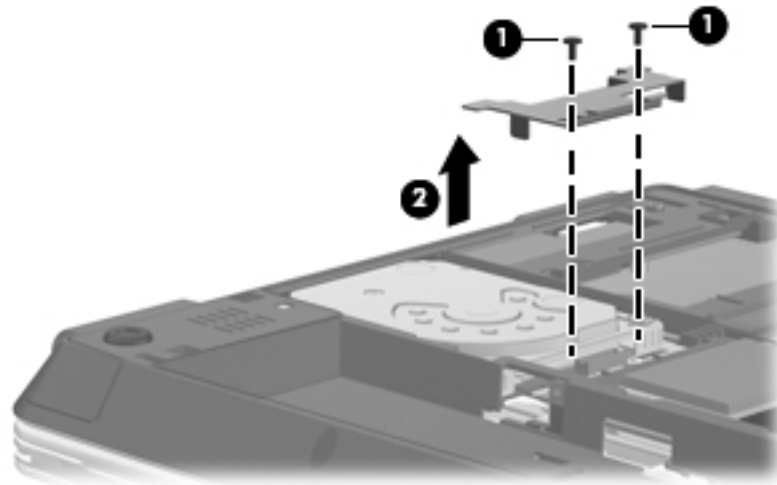

5. Disconnect the hard drive connector cable ❶ from the system board.
6. Release the hard drive ❷ by sliding it to the right, and then lifting the rear edge ❸ until the hard drive rests at an angle.
7. Lift the hard drive ❹ straight up to remove it from the hard drive compartment.

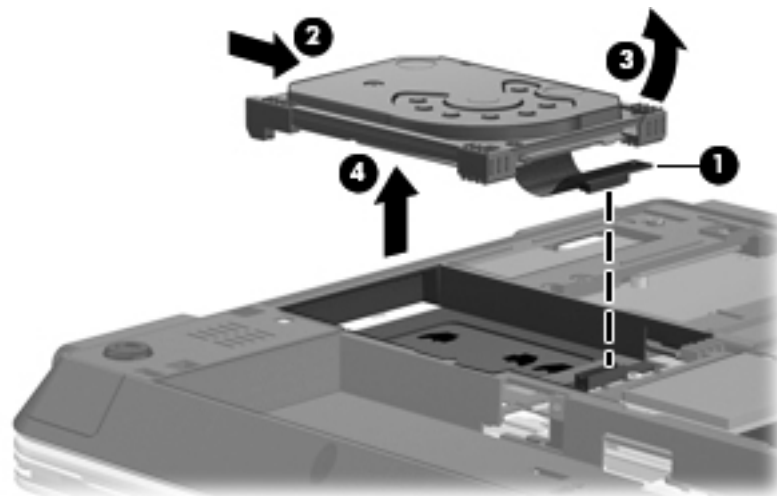

Reverse this procedure to reassemble and install the hard drive.

## WLAN module



**CAUTION:** The WLAN module and the WWAN module are not interchangeable.

| Description   | Spare part number |
|---|-------------------|
| Intel Wi-Fi Link 5100 802.11a/b/g WLAN module for use in all countries and regions  | 482957-001        |
| Intel Wi-Fi Link 5100 802.11a/b/g/n WLAN module for use in all countries and regions  | 480985-001        |
| Intel Wi-Fi Link 5100 802.11a/b/g/n WLAN module for use in Russia, Ukraine, and Pakistan  | 506678-001        |
| Broadcom 4322 802.11a/b/g/n WLAN module for use in Antigua and Barbuda, Barbados, Belize, Canada, the Cayman Islands, Guam, Puerto Rico, Trinidad and Tobago, the U.S. Virgin Islands, and the United States  | 487330-001        |
| Broadcom 4322 802.11a/b/g/n WLAN module for use in Afghanistan, Albania, Algeria, Andorra, Angola, Antigua and Barbuda, Argentina, Armenia, Aruba, Australia, Austria, Azerbaijan, the Bahamas, Bahrain, Bangladesh, Barbados, Belarus, Belgium, Belize, Benin, Bermuda, Bhutan, Bolivia, Bosnia and Herzegovina, Botswana, Brazil, the British Virgin Islands, Brunei, Bulgaria, Burkina Faso, Burundi, Cameroon, Cape Verde, the Central African Republic, Chad, Chile, the People's Republic of China, Colombia, Comoros, the Congo, Costa Rica, Croatia, Cyprus, the Czech Republic, Denmark, Djibouti, Dominica, the Dominican Republic, East Timor, Ecuador, Egypt, El Salvador, Equatorial Guinea, Eritrea, Estonia, Ethiopia, Fiji, Finland, France, French Guiana, Gabon, Gambia, Georgia, Germany, Ghana, Gibraltar, Greece, Grenada, Guadeloupe, Guatemala, Guinea, Guinea-Bissau, Guyana, Haiti, Honduras, Hong Kong, Hungary, Iceland, India, Ireland, Israel, Italy, the Ivory Coast, Jamaica, Jordan, Kazakhstan, Kenya, Kiribati, Kyrgyzstan, Laos, Latvia, Lebanon, Lesotho, Liberia, Liechtenstein, Lithuania, Luxembourg, Macedonia, Madagascar, Malawi, Malaysia, the Maldives, Mali, Malta, the Marshall Islands, Martinique, Mauritania, Mauritius, Mexico, Micronesia, Monaco, Mongolia, Montenegro, Morocco, Mozambique, Namibia, Nauru, Nepal, the Nether Antilles, the Netherlands, New Zealand, Nicaragua, Niger, Nigeria, Norway, Oman, Pakistan, Palau, Panama, Papua New Guinea, Paraguay, Peru, the Philippines, Poland, Portugal, the Republic of Moldova, Romania, Russia, Rwanda, Samoa, San Marino, Sao Tome and Principe, Saudi Arabia, Senegal, Serbia, the Seychelles, Sierra Leone, Singapore, Slovakia, Slovenia, the Solomon Islands, Somalia, South Africa, South Korea, Spain, Sri Lanka, St. Kitts and Nevis, St. Lucia, St. Vincent and the Grenadines, Suriname, Swaziland, Sweden, Switzerland, Taiwan, Tajikistan, Tanzania, Togo, Tonga, Trinidad and Tobago, Tunisia, Turkey, Turkmenistan, Tuvalu, Uganda, Ukraine, the United Arab Emirates, the United Kingdom, Uruguay, Uzbekistan, Vanuatu, Venezuela, Vietnam, Yemen, Zaire, Zambia, and Zimbabwe | 487330-002        |
| Broadcom BCM4312 802.11b/g WLAN module for use in Antigua and Barbuda, Barbados, Belize, Canada, the Cayman Islands, Guam, Puerto Rico, Trinidad and Tobago, the U.S. Virgin Islands, and the United States   | 459263-001        |

(Continued)

| Description  | Spare part number |
|--|-------------------|
| Broadcom BCM4312 802.11b/g WLAN module for use in Afghanistan, Albania, Algeria, Andorra, Angola, Antigua and Barbuda, Argentina, Armenia, Aruba, Australia, Austria, Azerbaijan, the Bahamas, Bahrain, Bangladesh, Barbados, Belarus, Belgium, Belize, Benin, Bermuda, Bhutan, Bolivia, Bosnia and Herzegovina, Botswana, Brazil, the British Virgin Islands, Brunei, Bulgaria, Burkina Faso, Burundi, Cameroon, Cape Verde, the Central African Republic, Chad, Chile, the People's Republic of China, Colombia, Comoros, the Congo, Costa Rica, Croatia, Cyprus, the Czech Republic, Denmark, Djibouti, Dominica, the Dominican Republic, East Timor, Ecuador, Egypt, El Salvador, Equatorial Guinea, Eritrea, Estonia, Ethiopia, Fiji, Finland, France, French Guiana, Gabon, Gambia, Georgia, Germany, Ghana, Gibraltar, Greece, Grenada, Guadeloupe, Guatemala, Guinea, Guinea-Bissau, Guyana, Haiti, Honduras, Hong Kong, Hungary, Iceland, India, Ireland, Israel, Italy, the Ivory Coast, Jamaica, Jordan, Kazakhstan, Kenya, Kiribati, Kyrgyzstan, Laos, Latvia, Lebanon, Lesotho, Liberia, Liechtenstein, Lithuania, Luxembourg, Macedonia, Madagascar, Malawi, Malaysia, the Maldives, Mali, Malta, the Marshall Islands, Martinique, Mauritania, Mauritius, Mexico, Micronesia, Monaco, Mongolia, Montenegro, Morocco, Mozambique, Namibia, Nauru, Nepal, the Nether Antilles, the Netherlands, New Zealand, Nicaragua, Niger, Nigeria, Norway, Oman, Pakistan, Palau, Panama, Papua New Guinea, Paraguay, Peru, the Philippines, Poland, Portugal, the Republic of Moldova, Romania, Russia, Rwanda, Samoa, San Marino, Sao Tome and Principe, Saudi Arabia, Senegal, Serbia, the Seychelles, Sierra Leone, Singapore, Slovakia, Slovenia, the Solomon Islands, Somalia, South Africa, South Korea, Spain, Sri Lanka, St. Kitts and Nevis, St. Lucia, St. Vincent and the Grenadines, Suriname, Swaziland, Sweden, Switzerland, Taiwan, Tajikistan, Tanzania, Togo, Tonga, Trinidad and Tobago, Tunisia, Turkey, Turkmenistan, Tuvalu, Uganda, Ukraine, the United Arab Emirates, the United Kingdom, Uruguay, Uzbekistan, Vanuatu, Venezuela, Vietnam, Yemen, Zaire, Zambia, and Zimbabwe | 459263-002        |

Before removing the WLAN module, follow these steps:

1. Shut down the computer. If you are unsure whether the computer is off or in Hibernation, turn the computer on, and then shut it down through the operating system.
2. Disconnect all external devices connected to the computer.
3. Disconnect the power from the computer by first unplugging the power cord from the AC outlet and then unplugging the AC adapter from the computer.
4. Remove the battery (see [“Battery” on page 4-8](#)).
5. Remove the SIM (see [“SIM” on page 4-9](#)).
6. Remove the hard drive cover (see [“Hard drive” on page 4-10](#)).

Remove the WLAN module:

1. Disconnect the WLAN antenna cables ❶ from the terminals on the WLAN module.

✎ The black WLAN antenna cable is connected to the WLAN module “Main” terminal. The white WLAN antenna cable is connected to the WLAN module “Aux” terminal.

2. Remove the two Phillips PM2.5×4.0 screws ❷ that secure the WLAN module to the computer. (The edge of the module opposite the slot rises away from the computer.)

3. Remove the WLAN module ❸ by pulling the module away from the slot at an angle.

✎ WLAN modules are designed with a notch ❹ to prevent incorrect insertion into the WLAN module slot.

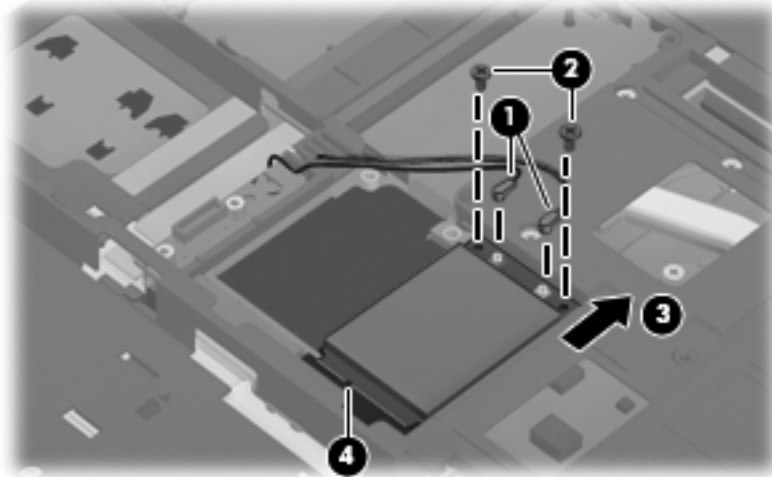

Reverse this procedure to install the WLAN module.

## WWAN module



**CAUTION:** The WLAN module and the WWAN module are not interchangeable.

| Description             | Spare part number |
|-------------------------|-------------------|
| HSPDA EV-DO WWAN module | 483377-002        |

Before removing the WWAN module, follow these steps:

1. Shut down the computer. If you are unsure whether the computer is off or in Hibernation, turn the computer on, and then shut it down through the operating system.
2. Disconnect all external devices connected to the computer.
3. Disconnect the power from the computer by first unplugging the power cord from the AC outlet and then unplugging the AC adapter from the computer.
4. Remove the battery (see “Battery” on page 4-8).
5. Remove the SIM (see “SIM” on page 4-9).
6. Remove the hard drive cover (see “Hard drive” on page 4-10).

Remove the WWAN module:

1. Disconnect the WWAN antenna cables ❶ from the terminals on the WWAN module.

 The red WWAN antenna cable is connected to the WWAN module “Main” terminal. The blue WWAN antenna cable is connected to the WWAN module “Aux” terminal.

2. Remove the two Phillips PM2.5×4.0 screws ❷ that secure the WWAN module to the computer. (The edge of the module opposite the slot rises away from the computer.)
3. Remove the WWAN module ❸ by pulling the module away from the slot at an angle.

 WWAN modules are designed with a notch ❹ to prevent incorrect insertion into the WWAN module slot.

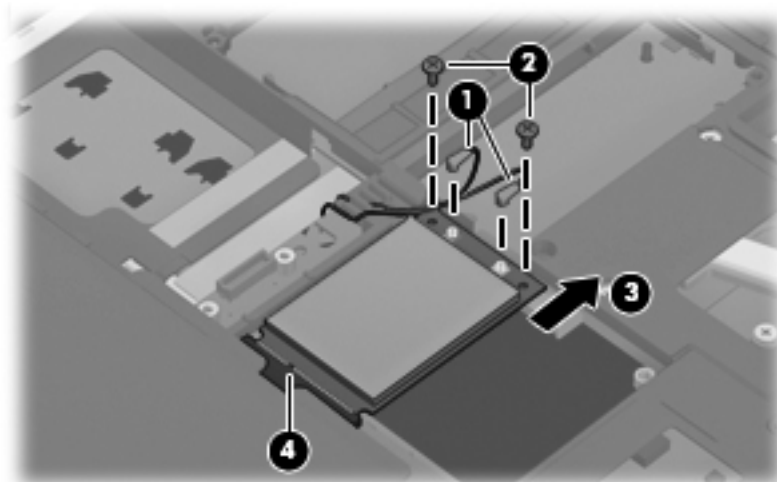

Reverse this procedure to install the WWAN module.

## Memory module

| Description                       | Spare part number |
|-----------------------------------|-------------------|
| 4096-MB (PC2-6400, 800-MHz, DDR2) | 598855-001        |
| 2048-MB (PC2-6400, 800-MHz, DDR2) | 598858-001        |
| 1024-MB (PC2-6400, 800-MHz, DDR2) | 598861-001        |

Before removing the memory module, follow these steps:

1. Shut down the computer. If you are unsure whether the computer is off or in Hibernation, turn the computer on, and then shut it down through the operating system.
2. Disconnect all external devices connected to the computer.
3. Disconnect the power from the computer by first unplugging the power cord from the AC outlet and then unplugging the AC adapter from the computer.
4. Remove the battery (see “[Battery](#)” on page 4-8).
5. Remove the SIM (see “[SIM](#)” on page 4-9).
6. Remove the hard drive cover (see “[Hard drive](#)” on page 4-10).

Remove the memory module:



The top memory module slot is for extension memory and the bottom slot is for primary memory.

1. Spread the retaining tabs **1** on each side of the memory module to release the memory module. (The edge of the module opposite the slot rises away from the computer.)
2. Remove the memory module **2** by pulling the module away from the slot at an angle.

 Memory modules are designed with a notch **3** to prevent incorrect insertion into the memory module slots.

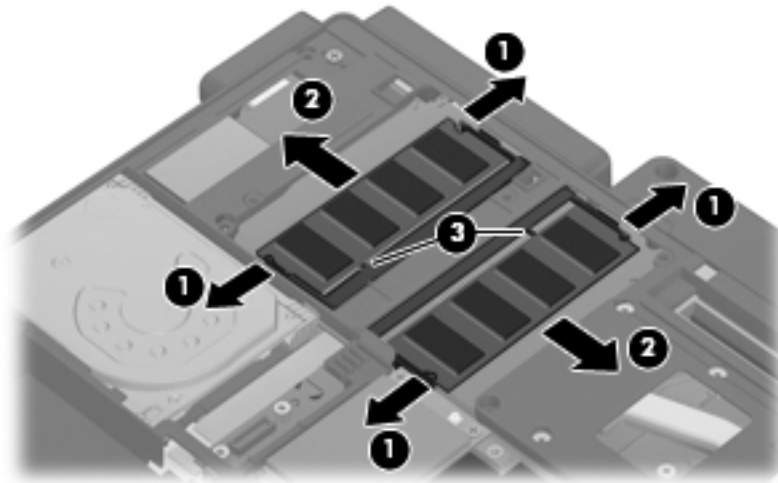

Reverse this procedure to install a memory module.



## Keyboard

| <b>Description</b>            | <b>Spare part number</b> |
|-------------------------------|--------------------------|
| For use in Belgium            | 501493-A41               |
| For use in Brazil             | 501493-201               |
| For use the Czech Republic    | 501493-211               |
| For use in Denmark            | 501493-081               |
| For use in Finland and Sweden | 501493-B71               |
| For use in France             | 501493-051               |
| For use in French Canada      | 501493-121               |
| For use in Germany            | 501493-041               |
| For use in Greece             | 501493-DJ1               |
| For use in Hungary            | 501493-221               |
| For use in Iceland            | 501493-DD1               |
| For use in Israel             | 501493-BB1               |
| For use in Italy              | 501493-061               |
| For use in Japan              | 501493-291               |
| For use in Latin America      | 501493-161               |
| For use in the Netherlands    | 501493-B31               |
| For use in Norway             | 501493-091               |
| For use in Portugal           | 501493-131               |
| For use in Russia             | 501493-251               |
| For use in Saudi Arabia       | 501493-171               |
| For use in Slovakia           | 501493-231               |
| For use in South Korea        | 501493-AD1               |
| For use in Spain              | 501493-071               |
| For use in Switzerland        | 501493-BG1               |
| For use in Taiwan             | 501493-AB1               |
| For use in Thailand           | 501493-281               |

Before removing the keyboard, follow these steps:

1. Shut down the computer. If you are unsure whether the computer is off or in Hibernation, turn the computer on, and then shut it down through the operating system.
2. Disconnect all external devices connected to the computer.
3. Disconnect the power from the computer by first unplugging the power cord from the AC outlet and then unplugging the AC adapter from the computer.
4. Remove the battery (see “[Battery](#)” on page 4-8).
5. Remove the SIM (see “[SIM](#)” on page 4-9).
6. Remove the hard drive cover (see “[Hard drive](#)” on page 4-10).

Remove the keyboard:

1. Remove the following:
  - ❶ Two Mylar screw covers. The screw covers detailed in this section are available in the Rubber Kit, spare part number RUB-001.
  - ❷ Six Torx T8M2.0×8.0 screws.

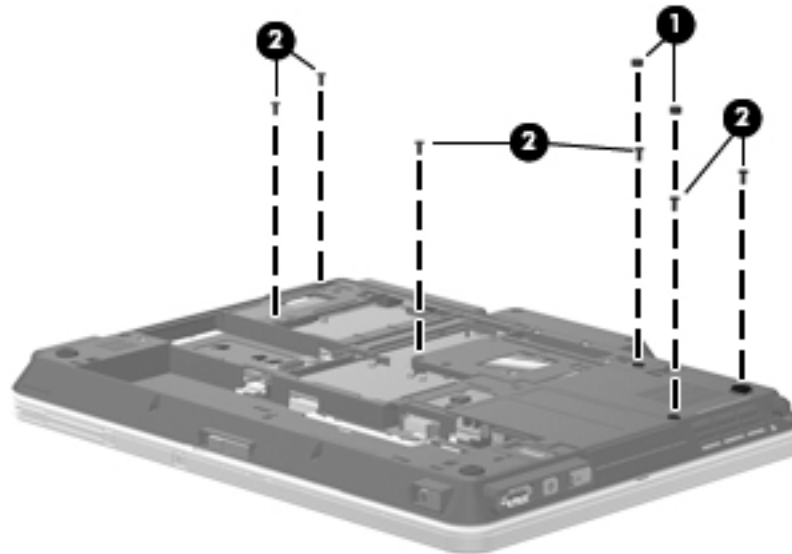

2. Turn the computer display-side up, with the front toward you.
3. Open the computer as far as possible.
4. Lift the rear edge of the keyboard ❶ and slide it ❷ back until the pointing stick cable is accessible.
5. Release the zero insertion force (ZIF) connector ❸ to which the pointing stick cable is attached, and disconnect the pointing stick cable ❹ from the system board.

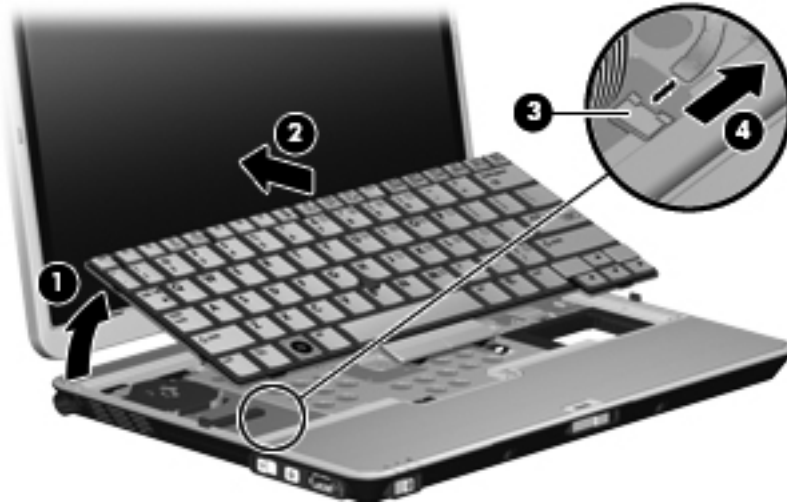

6. Swing the top edge of the keyboard ❶ up and forward until it rests upside down on the palm rest.
7. Release the ZIF connector ❷ to which the keyboard cable is attached, and disconnect the keyboard cable ❸ from the system board.



8. Remove the keyboard.
- Reverse this procedure to install the keyboard.

## Hinge cover



The hinge cover is included in the Plastics Kit, spare part number 501499-001.

Before removing the hinge cover, follow these steps:

1. Shut down the computer. If you are unsure whether the computer is off or in Hibernation, turn the computer on, and then shut it down through the operating system.
2. Disconnect all external devices connected to the computer.
3. Disconnect the power from the computer by first unplugging the power cord from the AC outlet and then unplugging the AC adapter from the computer.
4. Remove the battery (see “[Battery](#)” on page 4-8).
5. Remove the following components:
  - a. SIM (see “[SIM](#)” on page 4-9)
  - b. Hard drive cover (see “[Hard drive](#)” on page 4-10)
  - c. Keyboard (see “[Keyboard](#)” on page 4-17)

Remove the hinge cover:

1. Turn the computer upside down, with the rear panel toward you.
2. Remove the two Torx T8M2.0x5.0 screws that secure the hinge cover to the computer.

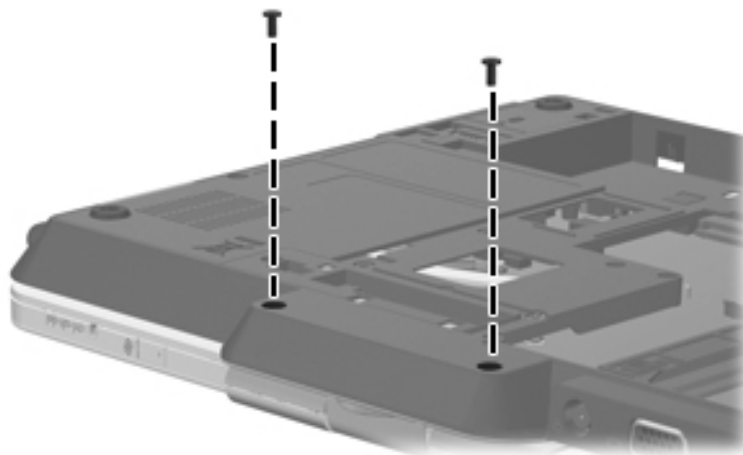

3. Turn the computer right-side up, with the rear panel toward you.
4. Raise the display to an upright position.
5. Remove the hinge cover by pulling it away from the computer.

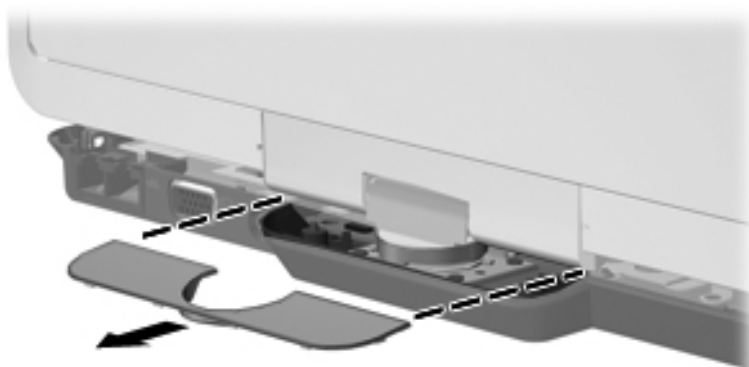

Reverse this procedure to install the hinge cover.

## Top cover

| Description   | Spare part number |
|---|-------------------|
| Top cover (includes LED board and cable and display alignment guides) | 501502-001        |

Before removing the top cover, follow these steps:

1. Shut down the computer. If you are unsure whether the computer is off or in Hibernation, turn the computer on, and then shut it down through the operating system.
2. Disconnect all external devices connected to the computer.
3. Disconnect the power from the computer by first unplugging the power cord from the AC outlet and then unplugging the AC adapter from the computer.
4. Remove the battery (see [“Battery” on page 4-8](#)).
5. Remove the following components:
  - a. SIM (see [“SIM” on page 4-9](#))
  - b. Hard drive cover (see [“Hard drive” on page 4-10](#))
  - c. Keyboard (see [“Keyboard” on page 4-17](#))
  - d. Hinge cover (see [“Hinge cover” on page 4-20](#))

Remove the top cover:

1. Turn the computer upside down, with the front toward you.
2. Remove the following:
  - ❶ One small Mylar screw cover. All Mylar screw covers detailed in this section are included in the Rubber Kit, spare part number RUB-001.
  - ❷ Three Torx T8M2.0×8.0 screws.
  - ❸ Two large Mylar screw covers. The screw covers detailed in this section are included in the Rubber Kit, spare part number RUB-001.
  - ❹ Two Torx T8M2.0×4.0 screws.

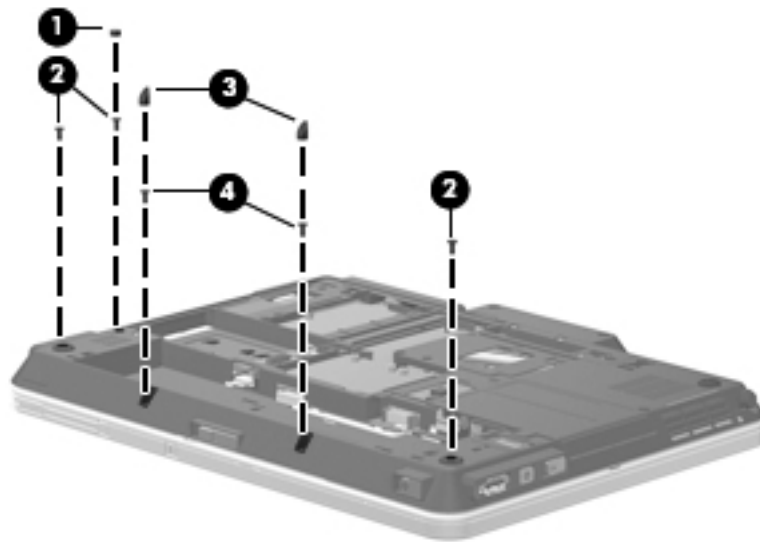

3. Turn the computer right-side up, with the front toward you.
4. Open the computer as far as possible.
5. Release the ZIF connector ❶ to which the TouchPad board cable is connected and disconnect the TouchPad board cable from the system board.
6. Release the ZIF connector ❷ to which the LED board cable is connected and disconnect the LED board cable from the system board.
7. Remove the two Phillips PM2.0×5.0 screws ❸ that secure the top cover to the computer.

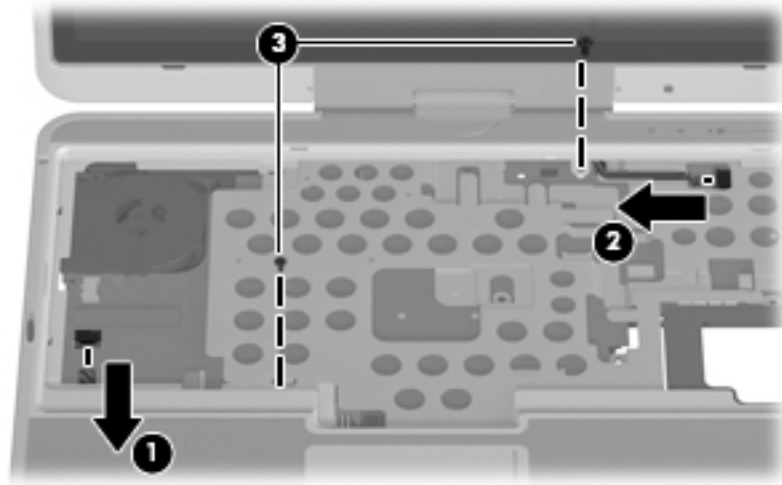

8. Lift the front edge of the top cover ❶ until it rests at an angle.
9. Remove the top cover by pulling it away from the computer ❷ at an angle.

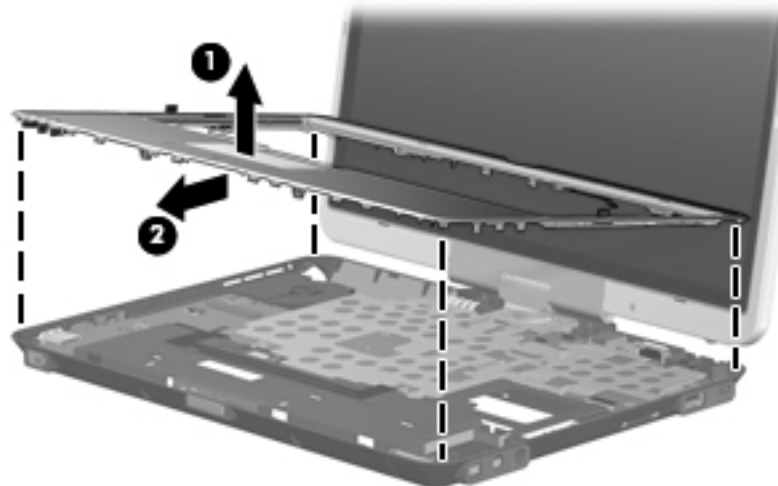

Reverse this procedure to install the top cover.

## RTC battery



Removing the RTC battery and leaving it uninstalled for 5 or more minutes causes all passwords and CMOS settings to be cleared.

| Description                              | Spare part number |
|--|-------------------|
| RTC battery (includes double-sided tape) | 482963-001        |

Before removing the RTC battery, follow these steps:

1. Shut down the computer. If you are unsure whether the computer is off or in Hibernation, turn the computer on, and then shut it down through the operating system.
2. Disconnect all external devices connected to the computer.
3. Disconnect the power from the computer by first unplugging the power cord from the AC outlet and then unplugging the AC adapter from the computer.
4. Remove the battery (see “[Battery](#)” on page 4-8).
5. Remove the following components:
  - a. SIM (see “[SIM](#)” on page 4-9)
  - b. Hard drive cover (see “[Hard drive](#)” on page 4-10)
  - c. Keyboard (see “[Keyboard](#)” on page 4-17)
  - d. Hinge cover (see “[Hinge cover](#)” on page 4-20)
  - e. Top cover (see “[Top cover](#)” on page 4-21)

Remove the RTC battery:

1. Disconnect the RTC battery cable ❶ from the system board.
2. Remove the RTC battery ❷. The RTC battery is attached to the system board using two-sided tape.

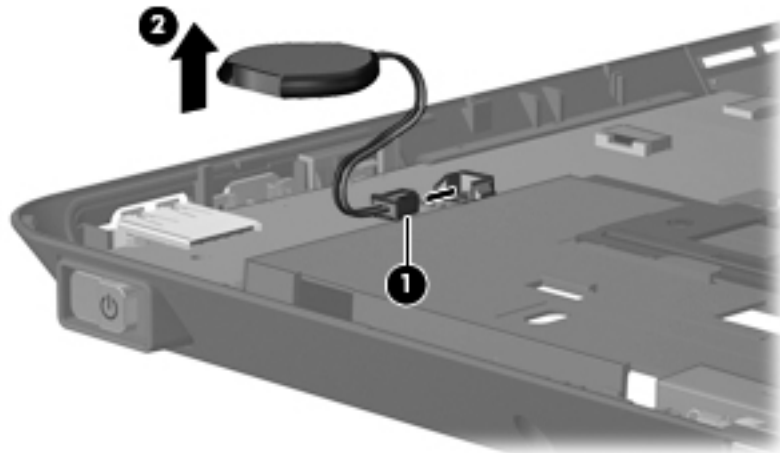

Reverse this procedure to install the RTC battery.

## Audio connector board

| Description                            | Spare part number |
|--|-------------------|
| Audio connector board (includes cable) | 507056-001        |

Before removing the audio connector board, follow these steps:

1. Shut down the computer. If you are unsure whether the computer is off or in Hibernation, turn the computer on, and then shut it down through the operating system.
2. Disconnect all external devices connected to the computer.
3. Disconnect the power from the computer by first unplugging the power cord from the AC outlet and then unplugging the AC adapter from the computer.
4. Remove the battery (see [“Battery” on page 4-8](#)).
5. Remove the following components:
  - a. SIM (see [“SIM” on page 4-9](#))
  - b. Hard drive cover (see [“Hard drive” on page 4-10](#))
  - c. Keyboard (see [“Keyboard” on page 4-17](#))
  - d. Hinge cover (see [“Hinge cover” on page 4-20](#))
  - e. Top cover (see [“Top cover” on page 4-21](#))

Remove the audio connector board and cable:

1. Release the ZIF connector **1** to which the audio connector board cable is connected, and disconnect the audio connector board cable **2** from the system board. The audio connector board cable is included with the audio connector board and is also available in the Cables Kit, spare part number MCK-001.
2. Remove the Phillips PM2.0×5.0 screw **3** that secures the audio connector board to the base enclosure.
3. Remove the audio connector board and cable **4**.

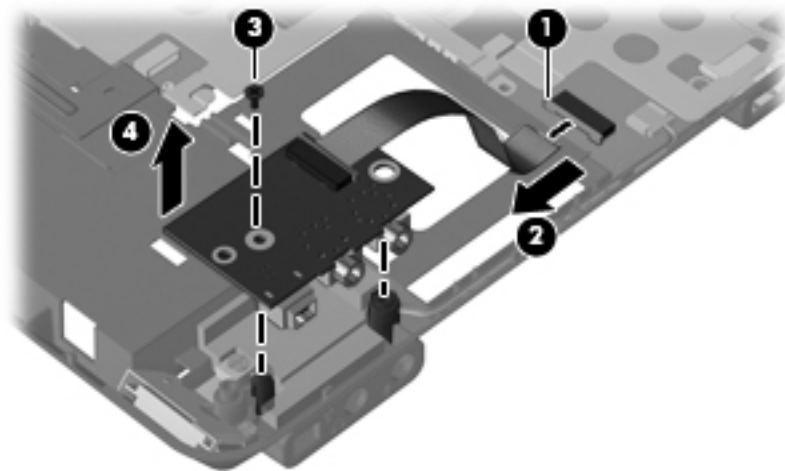

Reverse this procedure to install the audio connector board.



## Bluetooth module

| Description  | Spare part number |
|--|-------------------|
| Bluetooth module   | 483113-001        |
|  The Bluetooth module spare part kit does not include a Bluetooth module cable. The Bluetooth module cable is included in the Cables Kit, spare part number 501500-001. |                   |

Before removing the Bluetooth module, follow these steps:

1. Shut down the computer. If you are unsure whether the computer is off or in Hibernation, turn the computer on, and then shut it down through the operating system.
2. Disconnect all external devices connected to the computer.
3. Disconnect the power from the computer by first unplugging the power cord from the AC outlet and then unplugging the AC adapter from the computer.
4. Remove the battery (see [“Battery” on page 4-8](#)).
5. Remove the following components:
  - a. SIM (see [“SIM” on page 4-9](#))
  - b. Hard drive cover (see [“Hard drive” on page 4-10](#))
  - c. Keyboard (see [“Keyboard” on page 4-17](#))
  - d. Hinge cover (see [“Hinge cover” on page 4-20](#))
  - e. Top cover (see [“Top cover” on page 4-21](#))
  - f. Audio connector board (see [“Audio connector board” on page 4-24](#))

Remove the Bluetooth module:

1. Disconnect the Bluetooth module cable ❶ from the system board.
2. Remove the Bluetooth module cable from the clips ❷ built into the base enclosure.
3. Remove the Phillips PM2.0×4.0 screw ❸ that secures the Bluetooth module and bracket to the system board.
4. Remove the module ❹ and bracket from the base enclosure.

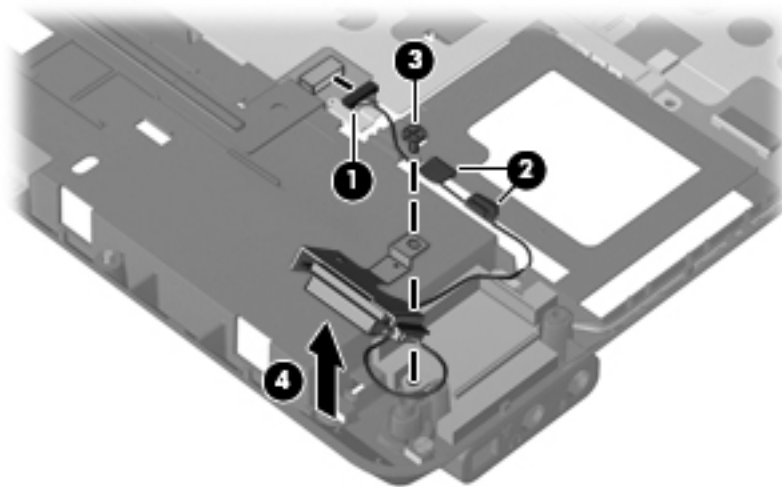

Reverse this procedure to install the Bluetooth module.

## Speaker

| Description | Spare part number |
|-------------|-------------------|
| Speaker     | 507057-001        |

Before removing the speaker, follow these steps:

1. Shut down the computer. If you are unsure whether the computer is off or in Hibernation, turn the computer on, and then shut it down through the operating system.
2. Disconnect all external devices connected to the computer.
3. Disconnect the power from the computer by first unplugging the power cord from the AC outlet and then unplugging the AC adapter from the computer.
4. Remove the battery (see [“Battery” on page 4-8](#)).
5. Remove the following components:
  - a. SIM (see [“SIM” on page 4-9](#))
  - b. Hard drive cover (see [“Hard drive” on page 4-10](#))
  - c. Keyboard (see [“Keyboard” on page 4-17](#))
  - d. Hinge cover (see [“Hinge cover” on page 4-20](#))
  - e. Top cover (see [“Top cover” on page 4-21](#))
  - f. Audio connector board (see [“Audio connector board” on page 4-24](#))
  - g. Bluetooth module (see [“Bluetooth module” on page 4-25](#))

Remove the speaker:

1. Disconnect the speaker cable ❶ from the system board.
2. Remove the speaker cable from the clips ❷ built into the base enclosure.
3. Remove the Phillips PM2.0×5.0 screw ❸ that attaches the speaker to the base enclosure.
4. Remove the speaker ❹ from the base enclosure.

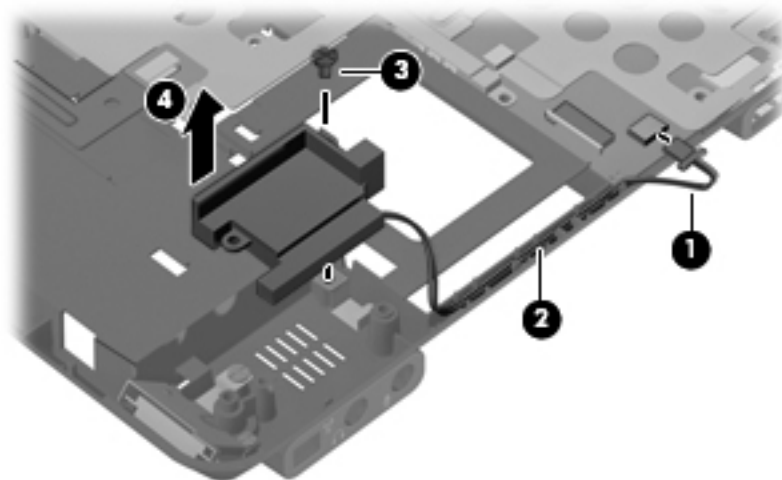

Reverse this procedure to install the speaker.

## Display assembly



The display assembly spare part kit includes an ambient light sensor, fingerprint reader, logo, 2 microphones, nameplate, 2 WLAN antenna transceivers and cables, and 2 WWAN antenna transceivers and cables.

| Description  | Spare part number |
|--|-------------------|
| 12.1-inch, WXGA LED display assembly with webcam and outdoor light | 504172-001        |
| 12.1-inch, WXGA LED display assembly with webcam                   | 504170-001        |
| 12.1-inch, WXGA LED display assembly with outdoor light            | 504171-001        |
| 12.1-inch, WXGA LED display assembly                               | 504169-001        |

Before removing the display assembly, follow these steps:

1. Shut down the computer. If you are unsure whether the computer is off or in Hibernation, turn the computer on, and then shut it down through the operating system.
2. Disconnect all external devices connected to the computer.
3. Disconnect the power from the computer by first unplugging the power cord from the AC outlet and then unplugging the AC adapter from the computer.
4. Remove the battery (see [“Battery” on page 4-8](#)).
5. Remove the following components:
  - a. SIM (see [“SIM” on page 4-9](#))
  - b. Hard drive cover (see [“Hard drive” on page 4-10](#))
  - c. Keyboard (see [“Keyboard” on page 4-17](#))
  - d. Hinge cover (see [“Hinge cover” on page 4-20](#))
  - e. Top cover (see [“Top cover” on page 4-21](#))

Remove the display assembly:

1. Open the computer as far as possible.
2. Disconnect the following cables from the system board and remove the cables from the clips built into the system board shielding:
  - ❶ Fingerprint reader board cable
  - ❷ Webcam cable
  - ❸ Microphone cable
3. Remove the wireless antenna cables ❹ from the opening in the system board and the clips built into the system board shielding.

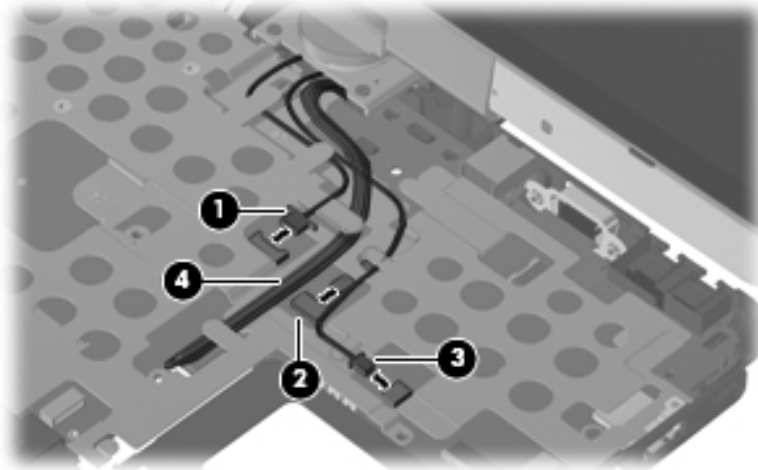

4. Remove the two Phillips PM2.0×4.0 screws ❶ that secure the display panel cable to the system board.
5. Disconnect the display panel cable ❷ from the system board.
6. Remove the Phillips PM2.0×4.0 screw ❸ that secures the display converter cable to the system board.
7. Disconnect the display converter cable ❹ from the system board.

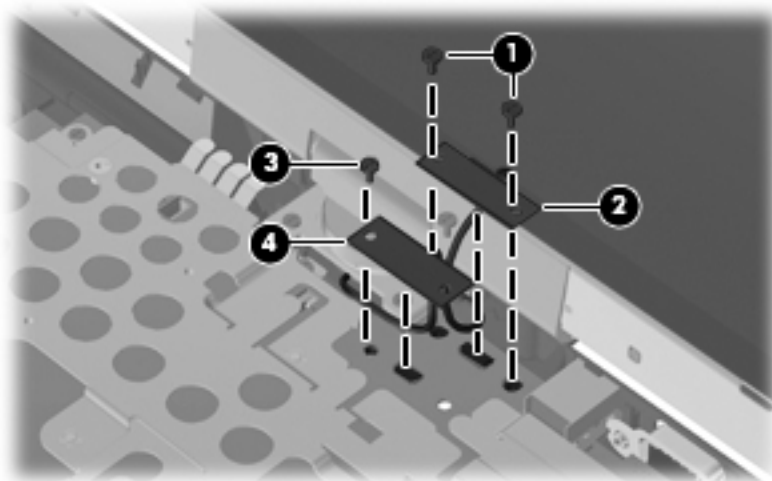

**CAUTION:** The display assembly will be unsupported when the following screws are removed. To prevent damage to the display assembly, support it before removing the screws.

8. Remove the four Phillips PM2.5×6.0 screws ❶ that secure the display assembly to the computer. Be sure to hold the display before removing the last screw to prevent damage to the display.
9. Lift the display assembly ❷ straight up and remove it.

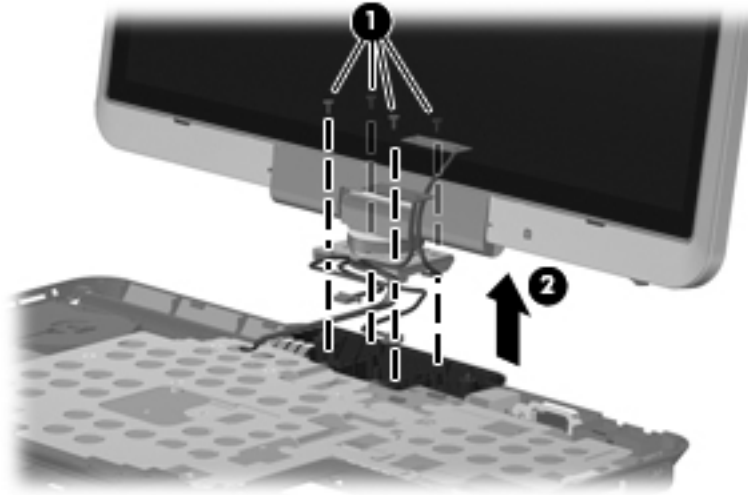

Reverse this procedure to install the display assembly.

## System board



The system board spare part kit includes replacement thermal material.

| Description  | Spare part number |
|--|-------------------|
| For use in all countries and regions except for Russia and the People's Republic of China  |                   |
| ■ Equipped with Intel Core2 Duo SL9600 2.13-GHz processor, 1066-MHz FSB, and 6-MB L2 cache | 530589-001        |
| ■ Equipped with Intel Core2 Duo SL9400 1.86-GHz processor, 1066-MHz FSB, and 6-MB L2 cache | 501483-001        |
| ■ Equipped with Intel Core2 Duo SL9300 1.60-GHz processor, 1066-MHz FSB, and 6-MB L2 cache | 501482-001        |
| ■ Equipped with Intel Core2 Duo SU9400 1.40-GHz processor, 800-MHz FSB, and 3-MB L2 cache  | 530590-001        |
| ■ Equipped with Intel Core2 Duo SU9300 1.20-GHz processor, 800-MHz FSB, and 3-MB L2 cache  | 501481-001        |
| For use in Russia and the People's Republic of China                                       |                   |
| ■ Equipped with Intel Core2 Duo SL9600 2.13-GHz processor, 1066-MHz FSB, and 6-MB L2 cache | 598660-001        |
| ■ Equipped with Intel Core2 Duo SL9400 1.86-GHz processor, 1066-MHz FSB, and 6-MB L2 cache | 510371-001        |
| ■ Equipped with Intel Core2 Duo SL9300 1.60-GHz processor, 1066-MHz FSB, and 6-MB L2 cache | 510370-001        |
| ■ Equipped with Intel Core2 Duo SU9400 1.40-GHz processor, 800-MHz FSB, and 3-MB L2 cache  | 598661-001        |
| ■ Equipped with Intel Core2 Duo SU9300 1.20-GHz processor, 800-MHz FSB, and 3-MB L2 cache  | 510369-001        |

Before removing the system board, follow these steps:

1. Shut down the computer. If you are unsure whether the computer is off or in Hibernation, turn the computer on, and then shut it down through the operating system.
2. Disconnect all external devices connected to the computer.
3. Disconnect the power from the computer by first unplugging the power cord from the AC outlet and then unplugging the AC adapter from the computer.
4. Remove the battery (see [“Battery” on page 4-8](#)).
5. Remove the following components:
  - a. SIM (see [“SIM” on page 4-9](#))
  - b. Hard drive cover (see [“Hard drive” on page 4-10](#))
  - c. Keyboard (see [“Keyboard” on page 4-17](#))
  - d. Hinge cover (see [“Hinge cover” on page 4-20](#))
  - e. Top cover (see [“Top cover” on page 4-21](#))
  - f. Display assembly (see [“Display assembly” on page 4-27](#))

When replacing the system board, be sure that the following components are removed from the defective system board and installed on the replacement system board:

- SIM (see [“SIM” on page 4-9](#))
- WLAN module (see [“WLAN module” on page 4-12](#))
- WWAN module (see [“WWAN module” on page 4-15](#))
- Memory modules (see [“Memory module” on page 4-16](#))
- RTC battery (see [“RTC battery” on page 4-23](#))
- Fan/heat sink assembly (see [“Fan/heat sink assembly” on page 4-34](#))
- Modem module (see [“Modem module” on page 4-36](#))

Remove the system board:

1. Turn the computer upside down, with the front toward you.
2. Remove the wireless module compartment shield from the base enclosure. The wireless module compartment shield is included in the Shield Kit, spare part number 501503-001.

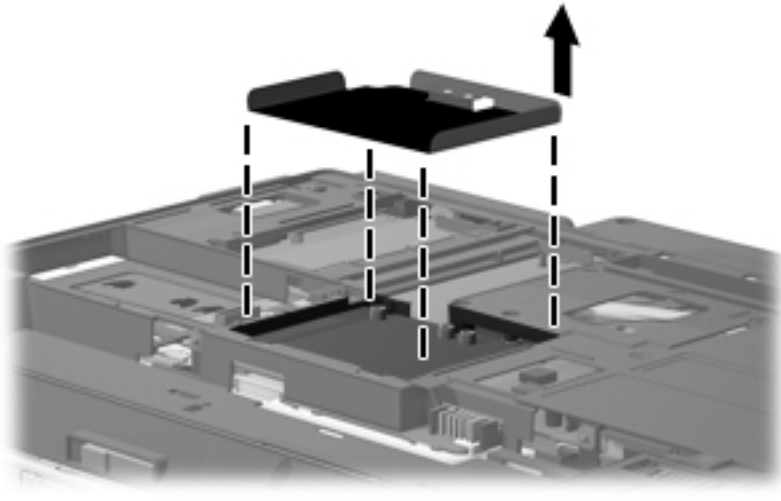

3. Turn the computer right-side up, with the front toward you.
4. Press the ExpressCard slot bezel ❶ to release it from the ExpressCard slot. (The ExpressCard slot bezel is partially ejected from the ExpressCard slot.)
5. Remove the ExpressCard slot bezel ❷. The ExpressCard slot bezel is included in the Plastics Kit, spare part number 501499-001.

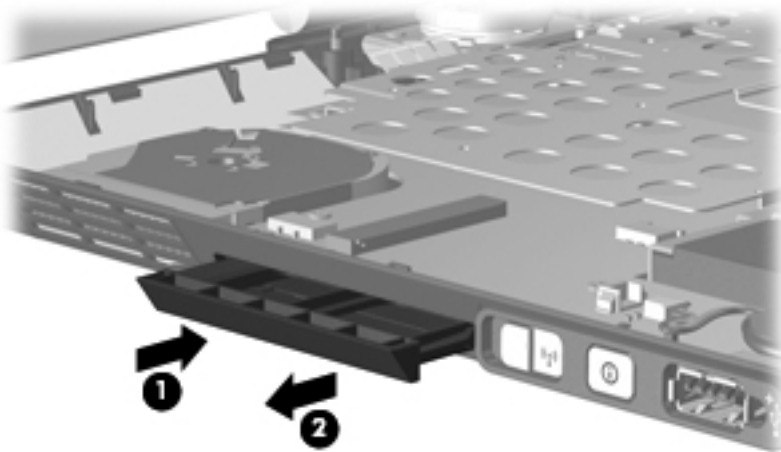

6. Position the computer with the front toward you.
7. Remove the system board shield. The system board shield is included in the Shield Kit, spare part number 501503-001.

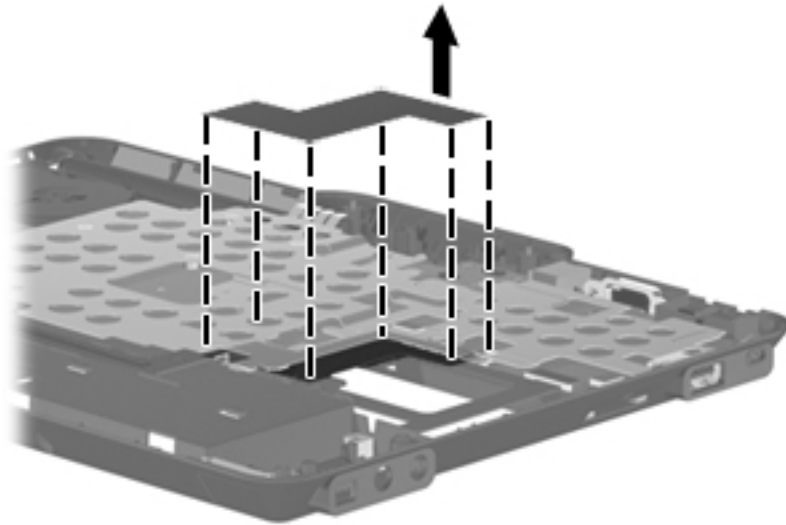

8. Remove the four Phillips PM2.0x5.0 screws that secure the system board to the base enclosure.

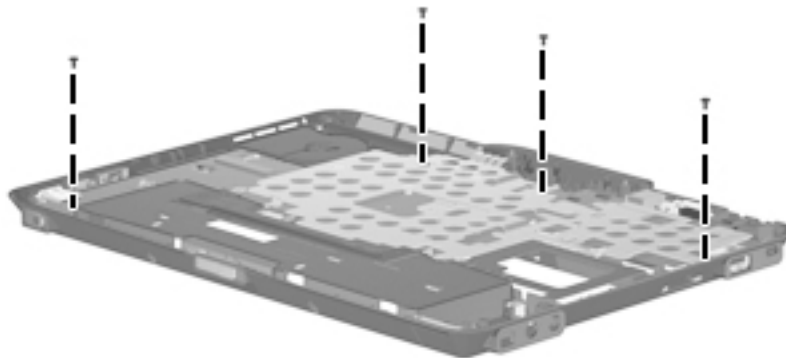



9. Position the computer with the rear panel toward you.
10. Use the battery connector ❶ to lift the front edge of the system board ❷ until it rests at an angle.
11. Remove the system board by sliding it away from the base enclosure ❸ at an angle.

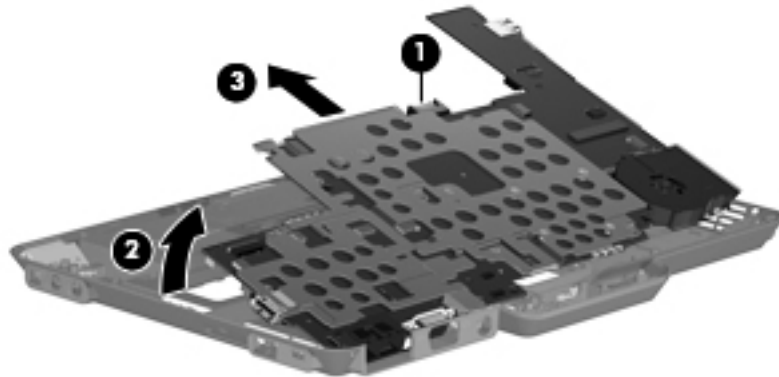

Reverse this procedure to install the system board.

## Fan/heat sink assembly

| Description  | Spare part number |
|--|-------------------|
| Fan/heat sink assembly (includes replacement thermal material) | 501495-001        |

Before removing the fan/heat sink assembly, follow these steps:

1. Shut down the computer. If you are unsure whether the computer is off or in Hibernation, turn the computer on, and then shut it down through the operating system.
2. Disconnect all external devices connected to the computer.
3. Disconnect the power from the computer by first unplugging the power cord from the AC outlet and then unplugging the AC adapter from the computer.
4. Remove the battery (see [“Battery” on page 4-8](#)).
5. Remove the following components:
  - a. SIM (see [“SIM” on page 4-9](#))
  - b. Hard drive cover (see [“Hard drive” on page 4-10](#))
  - c. Keyboard (see [“Keyboard” on page 4-17](#))
  - d. Hinge cover (see [“Hinge cover” on page 4-20](#))
  - e. Top cover (see [“Top cover” on page 4-21](#))
  - f. Display assembly (see [“Display assembly” on page 4-27](#))
  - g. System board (see [“System board” on page 4-30](#))

Remove the fan/heat sink assembly:

1. Disconnect the fan cable from the system board.

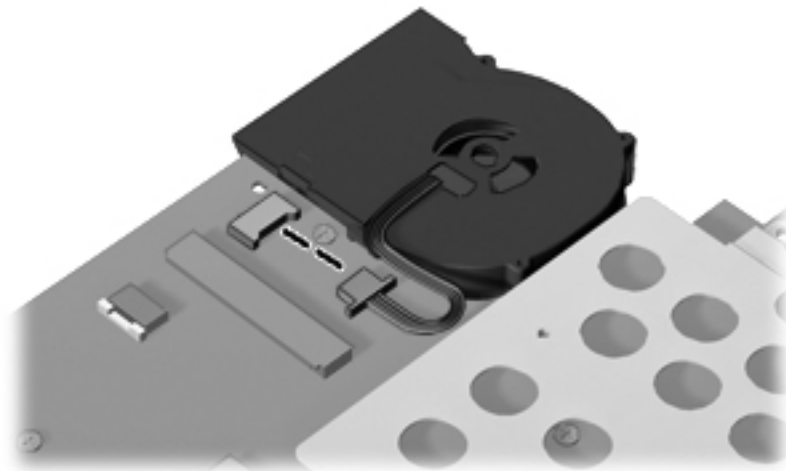

2. Turn the system board upside down with the front toward you.
3. Loosen the six Phillips PM2.5×7.0 captive screws ❶ that secure the fan/heat sink assembly to the base enclosure in the 1, 2, 3, 4, 5, 6 sequence stamped into the fan/heat sink assembly.
4. Remove the fan/heat sink assembly ❷.

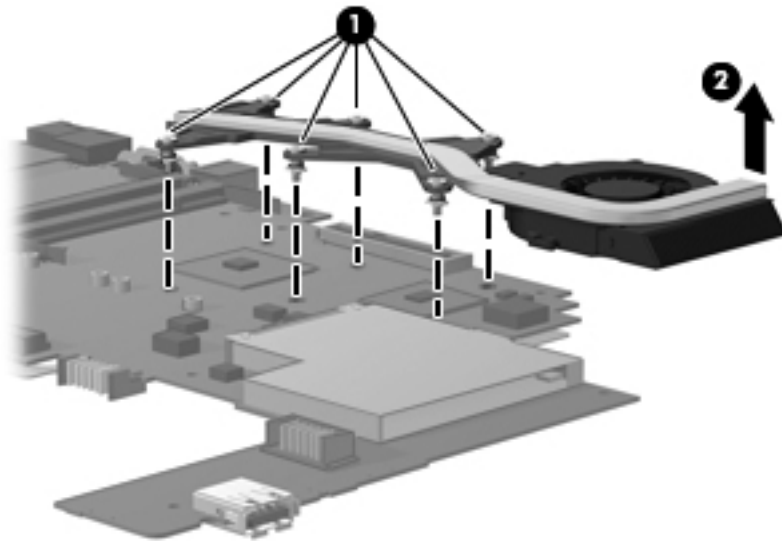

 Due to the adhesive quality of the thermal material located between the processor heat sink and system board components, it may be necessary to move the processor heat sink from side to side to detach it.

 The thermal material must be thoroughly cleaned from the surfaces of the heat sink ❶, ❷, and ❸, the processor ❹, the graphics system component ❺, and the system board component ❻ each time the heat sink is removed. Replacement thermal material is included with all system board and fan/heat sink assembly spare part kits.

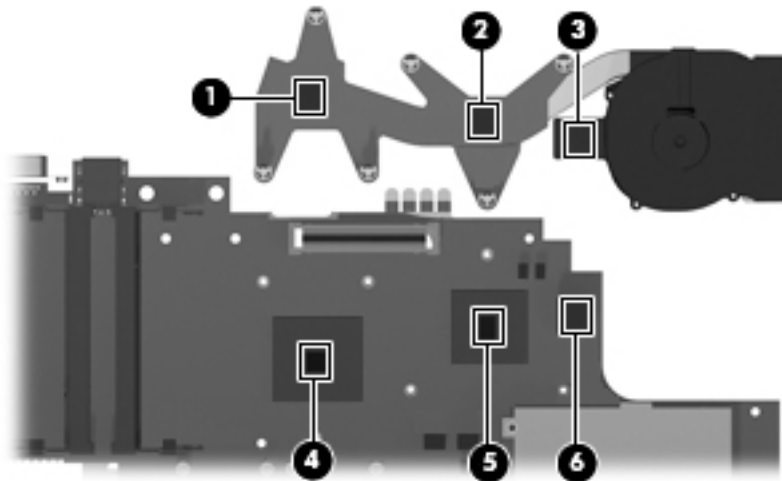

Reverse this procedure to install the fan/heat sink assembly.

 To properly ventilate the computer, allow at least a 7.6-cm (3-inch) clearance on the left side of the computer. The computer uses an electric fan for ventilation. The fan is controlled by a temperature sensor and is designed to turn on automatically when high temperature conditions exist. These conditions are affected by high external temperatures, system power consumption, power management/battery conservation configurations, battery fast charging, and software requirements. Exhaust air is displaced through the ventilation grill located on the left side of the computer.

## Modem module



The modem module spare part kit includes a modem module cable.

| Description   | Spare part number |
|---|-------------------|
| For use only in Australia and New Zealand                             | 461750-011        |
| For use in all countries and regions except Australia and New Zealand | 461750-001        |

Before removing the modem module, follow these steps:

1. Shut down the computer. If you are unsure whether the computer is off or in Hibernation, turn the computer on, and then shut it down through the operating system.
2. Disconnect all external devices connected to the computer.
3. Disconnect the power from the computer by first unplugging the power cord from the AC outlet and then unplugging the AC adapter from the computer.
4. Remove the battery (see [“Battery” on page 4-8](#)).
5. Remove the following components:
  - a. SIM (see [“SIM” on page 4-9](#))
  - b. Hard drive cover (see [“Hard drive” on page 4-10](#))
  - c. Keyboard (see [“Keyboard” on page 4-17](#))
  - d. Hinge cover (see [“Hinge cover” on page 4-20](#))
  - e. Top cover (see [“Top cover” on page 4-21](#))
  - f. Display assembly (see [“Display assembly” on page 4-27](#))
  - g. System board (see [“System board” on page 4-30](#))

Remove the modem module:

1. Turn the system board upside down, with the RJ-11 and RJ-45 jacks toward you.
2. Remove the two Phillips PM2.5×4.0 screws **1** that secure the modem module to the system board.
3. Lift the modem module **2** straight up to disconnect it from the system board.
4. Disconnect the modem module cable **3** from the modem module.

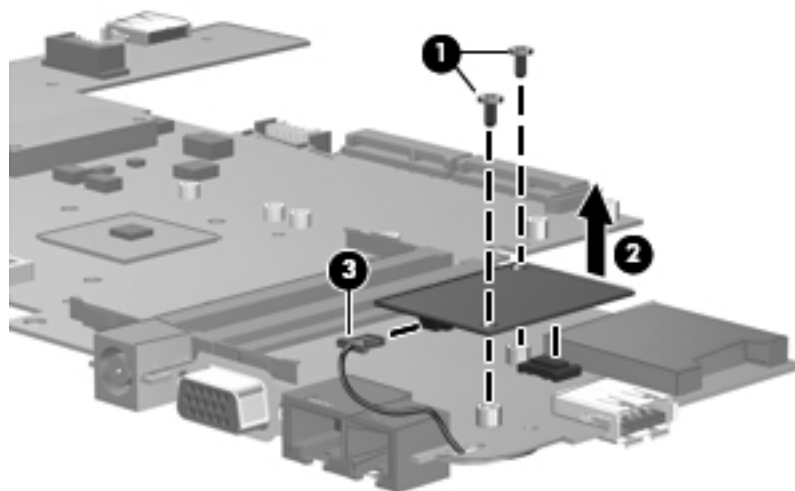

5. Remove the modem module.

Reverse this procedure to install the modem module.

---

## Computer Setup

### Starting Computer Setup

Computer Setup is a preinstalled, ROM-based utility that can be used even when the operating system is not working or will not load.



---

Some of the Computer Setup menu items listed in this guide may not be supported by your computer.

---



---

An external keyboard or mouse connected to a USB port can be used with Computer Setup only if USB legacy support is enabled.

---

To start Computer Setup, follow these steps:

1. Turn on or restart the computer, and then press **esc** while the “Press the ESC key for Startup Menu” message is displayed at the bottom of the screen.
2. Press **f10** to enter BIOS Setup.

# Using Computer Setup

## Navigating and selecting in Computer Setup

The information and settings in Computer Setup are accessed from the File, Security, Diagnostics, and System Configuration menus.

To navigate and select in Computer Setup, follow these steps:

1. Turn on or restart the computer, and then press **esc** while the “Press the ESC key for Startup Menu” message is displayed at the bottom of the screen.
  - ❑ To select a menu or a menu item, use the keyboard arrow keys and then press **enter**, or use a pointing device to click the item.
  - ❑ To scroll up and down, click the up arrow or the down arrow in the upper-right corner of the screen.
  - ❑ To close open dialog boxes and return to the main Computer Setup screen, press **esc**, and then follow the on-screen instructions.

 You can use either a pointing device (TouchPad, pointing stick, or USB mouse) or the keyboard to navigate and make selections in Computer Setup.

2. Press **f10** to enter BIOS Setup.
3. Select the File, Security, Diagnostics, or System Configuration menu.

To exit Computer Setup menus, choose one of the following methods:

- To exit Computer Setup menus without saving your changes, click the Exit icon in the lower-left corner of the screen, and then follow the on-screen instructions.
  - or –
- Use the arrow keys to select **File > Ignore changes and exit**, and then press **enter**.
  - or –
- To save your changes and exit Computer Setup menus, click the Save icon in the lower-left corner of the screen, and then follow the on-screen instructions.
  - or –
- Use the arrow keys to select **File > Save changes and exit**, and then press **enter**.

Your changes go into effect when the computer restarts.

## Restoring factory settings in Computer Setup



Restoring defaults will not change the hard drive mode.

To return all settings in Computer Setup to the values that were set at the factory, follow these steps:

1. Turn on or restart the computer, and then press **esc** while the “Press the ESC key for Startup Menu” message is displayed at the bottom of the screen.
2. Press **f10** to enter BIOS Setup.
3. Use a pointing device or the arrow keys to select **File > Restore defaults**.
4. Follow the on-screen instructions.
5. To save your changes and exit, click the Save icon in the lower-left corner of the screen, and then follow the on-screen instructions.

– or –

Use the arrow keys to select **File > Save changes and exit**, and then press **enter**.

Your changes go into effect when the computer restarts.



Your password settings and security settings are not changed when you restore the factory settings.

## Computer Setup menus

The menu tables in this section provide an overview of Computer Setup options.



Some of the Computer Setup menu items listed in this chapter may not be supported by your computer.



### File menu

| Select                   | To do this   |
|--------------------------|--|
| System Information       | <ul style="list-style-type: none"> <li>■ View identification information for the computer and the batteries in the system.</li> <li>■ View specification information for the processor, cache and memory size, system ROM, video revision, and keyboard controller version.</li> </ul> |
| Set System Date and Time | Set or change the date and time on the computer.   |
| Restore defaults         | Replace the configuration settings in Computer Setup with the original factory settings. (Hard drive mode, password settings, and security settings are not changed when you restore the factory settings.)  |
| Ignore changes and exit  | Cancel any changes entered during the current session. Then exit and restart the computer.   |
| Save changes and exit    | Save any changes entered during the current session. Then exit and restart the computer. Your changes go into effect when the computer restarts.   |

## Security menu



Some of the menu items listed in this section may not be supported by your computer.

| Select   | To do this   |
|--|--|
| User Management (requires an administrator password)       | <ul style="list-style-type: none"> <li>■ Create a new BIOS user account.</li> <li>■ View a list of ProtectTools users.</li> </ul>  |
| Password Policy (requires an administrator password)       | Revise password policy criteria.   |
| Allow HP SpareKey Enrollment                               | Enable/disable permission to enroll or reset HP SpareKey.  |
| HP SpareKey Enrollment                                     | Enroll or reset HP SpareKey, which is a set of security questions and answers used if you forget your password.  |
| HP SpareKey  | Enable/disable HP SpareKey (enabled by default).   |
| Fingerprint Reset on Reboot (If Present)                   | Enable/disable the fingerprint reader (select models only; disabled by default).   |
| Change Password  | Enter, change, or delete a BIOS administrator password.  |
| DriveLock Passwords  | <ul style="list-style-type: none"> <li>■ Enable/disable DriveLock on any computer hard drive (enabled by default).</li> <li>■ Change a DriveLock user password or master password.</li> </ul> <p> DriveLock settings are accessible only when you enter Computer Setup by turning on (not restarting) the computer.</p>   |
| Automatic DriveLock  | Enable/disable Automatic DriveLock support.  |
| TPM Embedded Security (requires an administrator password) | <ul style="list-style-type: none"> <li>■ Change TPM (Trusted Platform Module) Embedded Security device state at restart. The following options are available: <ul style="list-style-type: none"> <li><input type="checkbox"/> Do Nothing (enabled by default)</li> <li><input type="checkbox"/> Available and Disabled</li> <li><input type="checkbox"/> Available and Enabled</li> <li><input type="checkbox"/> Factory Defaults</li> </ul> </li> <li>■ Reset Authentication Credential.</li> <li>■ Enable/disable support for the following: <ul style="list-style-type: none"> <li><input type="checkbox"/> Power-on authentication support (enabled by default)</li> <li><input type="checkbox"/> Operating system TPM management (enabled by default)</li> <li><input type="checkbox"/> Reset of TPM from operating system (disabled by default)</li> </ul> </li> </ul> |
| Disk Sanitizer   | <p>Run Disk Sanitizer to destroy all existing data on the primary hard drive or the drive in the upgrade bay.</p> <p> If you run Disk Sanitizer, the data on the selected drive is destroyed permanently.</p>   |
| System IDs   | Enter a user-defined computer asset tracking number and ownership tag.   |
| Setup BIOS Administrator Password                          | Set up a BIOS administrator password.  |
| Always Prompt for HP SpareKey Enrollment                   | Enable/disable a prompt for HP SpareKey enrollment.  |



## Diagnostics menu

| Select                  | To do this   |
|-------------------------|--|
| System Diagnostics menu | <ul style="list-style-type: none"> <li>■ F1 System Information—Displays the following information:               <ul style="list-style-type: none"> <li><input type="checkbox"/> Identification information for the computer and the batteries in the system.</li> <li><input type="checkbox"/> Specification information for the processor, cache and memory size, system ROM, video revision, and keyboard controller version.</li> </ul> </li> <li>■ F2 Start-up Test—Verifies the system components needed for starting the computer.</li> <li>■ F3 Run-In Test—Runs a comprehensive check on system memory.</li> <li>■ F4 Hard Disk Test—Runs a comprehensive self-test on any hard drive in the system.</li> </ul> |

## System Configuration menu



Some of the listed System Configuration options may not be supported by your computer.

| Select       | To do this   |
|--------------|--|
| Language     | Change the Computer Setup language.  |
| Boot Options | <ul style="list-style-type: none"> <li>■ Set a Startup Menu delay (in seconds).</li> <li>■ Enable/disable Custom Logo (disabled by default).</li> <li>■ Enable/disable Display Diagnostic URL (enabled by default).</li> <li>■ Enable/disable CD-ROM boot (enabled by default).</li> <li>■ Enable/disable SD Card boot (enabled by default).</li> <li>■ Enable/disable floppy boot (enabled by default).</li> <li>■ Enable/disable PXE Internal NIC boot (enabled by default).</li> <li>■ Set the Express Boot Popup delay in seconds.</li> <li>■ Set the boot order.</li> </ul> |



*(Continued)*

| Select                  | To do this  |
|-------------------------|---|
| Device Configurations   | <ul style="list-style-type: none"> <li>■ Enable/disable USB legacy support (enabled by default). When enabled, USB legacy support allows the following:               <ul style="list-style-type: none"> <li><input type="checkbox"/> Use of a USB keyboard in Computer Setup even when a Windows® operating system is not running.</li> <li><input type="checkbox"/> Startup from bootable USB devices, including a hard drive, diskette drive, or optical drive connected by a USB port to the computer.</li> </ul> </li> <li>■ Select a parallel port mode: ECP (Enhanced Capabilities Port), standard, bidirectional, or EPP (Enhanced Parallel Port).</li> <li>■ Enable/disable fan always on while connected to an AC outlet (enabled by default).</li> <li>■ Enable/disable LAN Power Save (select models only). When enabled, saves power by turning off the LAN when not in use (enabled by default).</li> <li>■ Enable/disable Data Execution Prevention. When enabled, the processor can disable some virus code execution, which helps to improve computer security.</li> <li>■ SATA (Serial Advanced Technology Attachment) device mode. The following options are available:               <ul style="list-style-type: none"> <li><input type="checkbox"/> AHCI (Advanced Host Controller Interface)</li> <li><input type="checkbox"/> IDE (Integrated Drive Electronics)</li> <li><input type="checkbox"/> RAID (select models only)</li> </ul> </li> <li> Availability of the options above varies by computer model.</li> <li>■ Enable/disable secondary battery fast charge (enabled by default).</li> <li>■ Enable/disable HP QuickLook 2 (enabled by default).</li> <li>■ Enable/disable Virtualization Technology (select models only; disabled by default).</li> <li>■ Enable/disable TXT (Intel® Trusted Execution Technology) (select models only; disabled by default).</li> <li>■ Enable/disable Dual Core CPU (select models only; enabled by default).</li> <li>■ Enable/Disable Unified Extensible Firmware Interface (UEFI) mode (disabled by default).</li> </ul> |
| Built-In Device Options | <ul style="list-style-type: none"> <li>■ Enable/disable the wireless switch (enabled by default).</li> <li>■ Enable/disable embedded WWAN device radio (select models only; enabled by default).</li> <li>■ Enable/disable embedded Bluetooth device radio (enabled by default).</li> <li>■ Enable/disable the Network Interface Controller (LAN) (enabled by default).</li> <li>■ Set the wake on LAN state. Options include the following:               <ul style="list-style-type: none"> <li><input type="checkbox"/> Disabled</li> <li><input type="checkbox"/> Boot to Network (set by default)</li> <li><input type="checkbox"/> Follow Boot Order</li> </ul> </li> <li>■ Enable/disable the fingerprint device (enabled by default).</li> <li>■ Enable/disable a modem device (enabled by default).</li> <li>■ Enable/disable the embedded WLAN device (enabled by default).</li> <li>■ Enable/disable LAN/WLAN switching (disabled by default).</li> <li>■ Enable the ambient light sensor (enabled by default).</li> <li>■ Enable/disable the Notebook Multibay device (enabled by default).</li> <li>■ Enable/disable the integrated camera (select models only; enabled by default).</li> </ul>  |

(Continued)

| Select                  | To do this  |
|-------------------------|---|
| Device Configurations   | <ul style="list-style-type: none"> <li>■ Enable/disable USB legacy support (enabled by default). When enabled, USB legacy support allows the following: <ul style="list-style-type: none"> <li><input type="checkbox"/> Use of a USB keyboard in Computer Setup even when a Windows® operating system is not running.</li> <li><input type="checkbox"/> Startup from bootable USB devices, including a hard drive, diskette drive, or optical drive connected by a USB port to the computer.</li> </ul> </li> <li>■ Select a parallel port mode: ECP (Enhanced Capabilities Port), standard, bidirectional, or EPP (Enhanced Parallel Port).</li> <li>■ Enable/disable fan always on while connected to an AC outlet (enabled by default).</li> <li>■ Enable/disable LAN Power Save (select models only). When enabled, saves power by turning off the LAN when not in use (enabled by default).</li> <li>■ Enable/disable Data Execution Prevention. When enabled, the processor can disable some virus code execution, which helps to improve computer security.</li> <li>■ SATA (Serial Advanced Technology Attachment) device mode. The following options are available: <ul style="list-style-type: none"> <li><input type="checkbox"/> AHCI (Advanced Host Controller Interface)</li> <li><input type="checkbox"/> IDE (Integrated Drive Electronics)</li> <li><input type="checkbox"/> RAID (select models only)</li> </ul> </li> <li> Availability of the options above varies by computer model.</li> <li>■ Enable/disable secondary battery fast charge (enabled by default).</li> <li>■ Enable/disable HP QuickLook 2 (enabled by default).</li> <li>■ Enable/disable Virtualization Technology (select models only; disabled by default).</li> <li>■ Enable/disable TXT (Intel® Trusted Execution Technology) (select models only; disabled by default).</li> <li>■ Enable/disable Dual Core CPU (select models only; enabled by default).</li> <li>■ Enable/Disable Unified Extensible Firmware Interface (UEFI) mode (disabled by default).</li> </ul> |
| Built-In Device Options | <ul style="list-style-type: none"> <li>■ Enable/disable the wireless switch (enabled by default).</li> <li>■ Enable/disable embedded WWAN device radio (select models only; enabled by default).</li> <li>■ Enable/disable embedded Bluetooth device radio (enabled by default).</li> <li>■ Enable/disable the Network Interface Controller (LAN) (enabled by default).</li> <li>■ Set the wake on LAN state. Options include the following: <ul style="list-style-type: none"> <li><input type="checkbox"/> Disabled</li> <li><input type="checkbox"/> Boot to Network (set by default)</li> <li><input type="checkbox"/> Follow Boot Order</li> </ul> </li> <li>■ Enable/disable the fingerprint device (enabled by default).</li> <li>■ Enable/disable a modem device (enabled by default).</li> <li>■ Enable/disable the embedded WLAN device (enabled by default).</li> <li>■ Enable/disable LAN/WLAN switching (disabled by default).</li> <li>■ Enable the ambient light sensor (enabled by default).</li> <li>■ Enable/disable the Notebook Multibay device (enabled by default).</li> <li>■ Enable/disable the integrated camera (select models only; enabled by default).</li> </ul>  |

(Continued)

| Select                                    | To do this  |
|---|---|
| Port Options (all are enabled by default) | <p> All port options are enabled by default.</p> <ul style="list-style-type: none"> <li>■ Enable/disable the Smart Card slot.</li> <li>■ Enable/disable the ExpressCard slot.</li> <li>■ Enable/disable the serial port.</li> <li>■ Enable/disable the parallel port.</li> <li>■ Enable/disable the flash media reader.</li> <li>■ Enable/disable the USB port.</li> </ul> <p> Disabling the USB port also disables MultiBay devices and ExpressCard devices on the advanced port replicator.</p> <ul style="list-style-type: none"> <li>■ Enable/disable the 1394 port.</li> </ul> |
| AMT Options (all are disabled by default) | <p> All AMT options are disabled by default.</p> <ul style="list-style-type: none"> <li>■ Enable/disable Firmware Verbosity.</li> <li>■ Enable/disable AMT Setup Prompt (CTRL-P).</li> <li>■ Enable/disable USB Key Provisioning Support.</li> <li>■ Enable/disable Unconfigure AMT on Next Boot.</li> <li>■ Enable/disable Terminal Emulation Mode.</li> <li>■ Enable/disable Firmware Progress Event Support.</li> <li>■ Enable/disable Include TYPE-131 in SMBIOS.</li> </ul>   |
| Set Security Level                        | Change, view, or hide security levels for all BIOS menu items.  |
| Restore Security Defaults                 | Restore the default security settings.  |

# Specifications

## Computer specifications

|   | Metric   | U.S.                |
|---|--|---------------------|
| <b>Dimensions</b>   |  |                     |
| Length  | 21.2 cm  | 8.35 in             |
| Width   | 29.0 cm  | 11.42 in            |
| Height  | 2.8 cm   | 1.10 in             |
| <b>Weight</b>   |  |                     |
|   | 1.70 kg  | 3.74 lb             |
| <b>Input power</b>  |  |                     |
| Operating voltage   | 19.0 V dc @ 4.74 A - 65 W  |                     |
| Operating current   | 4.74 A   |                     |
| <b>Temperature</b>  |  |                     |
| Operating (not writing to optical disc)   | 0°C to 35°C  | 32°F to 95°F        |
| Operating (writing to optical disc)   | 5°C to 35°C  | 41°F to 95°F        |
| Nonoperating  | -20°C to 60°C  | -4°F to 140°F       |
| <b>Relative humidity</b>  |  |                     |
| Operating   | 10% to 90%   |                     |
| Nonoperating  | 5% to 95%  |                     |
| <b>Maximum altitude (unpressurized)</b>   |  |                     |
| Operating   | -15 m to 3,048 m   | -50 ft to 10,000 ft |
| Nonoperating  | -15 m to 12,192 m  | -50 ft to 40,000 ft |
| <b>Shock</b>  |  |                     |
| Operating   | 125 g, 2 ms, half-sine   |                     |
| Nonoperating  | 200 g, 2 ms, half-sine   |                     |
| <b>Random vibration</b>   |  |                     |
| Operating   | 0.75 g zero-to-peak, 10 Hz to 500 Hz, 0.25 oct/min sweep rate  |                     |
| Nonoperating  | 1.50 g zero-to-peak, 10 Hz to 500 Hz, 0.5 oct/min sweep rate   |                     |
|  | Applicable product safety standards specify thermal limits for plastic surfaces. The computer operates well within this range of temperatures. |                     |

## 12.1-inch, WXGA display specifications

|                                | Metric  | U.S.    |
|--------------------------------|---|---------|
| <b>Dimensions</b>              |   |         |
| Height                         | 16.9 cm   | 6.7 in  |
| Width                          | 26.2 cm   | 10.3 in |
| Diagonal                       | 30.8 cm   | 12.1 in |
| <b>Number of colors</b>        | Up to 16.8 million                              |         |
| <b>Contrast ratio</b>          | 250:1 (typical)                                 |         |
| <b>Brightness</b>              | 180 nits (typical)                              |         |
| <b>Pixel resolution</b>        |   |         |
| Pitch                          | 0.279 × 0.279 mm                                |         |
| Format                         | 1280 × 800                                      |         |
| Configuration                  | RGB vertical stripe                             |         |
| <b>Backlight</b>               | Edge lit  |         |
| <b>Character display</b>       | 80 × 25   |         |
| <b>Total power consumption</b> | 4.0 W   |         |
| <b>Viewing angle</b>           | +/-40° horizontal, +120/-40° vertical (typical) |         |

## Hard drive specifications

|   | 250-GB*                     | 160-GB*      | 120-GB*      | 80-GB*       |
|---|-----------------------------|--------------|--------------|--------------|
| <b>Dimensions</b>                                   |                             |              |              |              |
| Height  | 8.0 mm                      | 8.0 mm       | 8.0 mm       | 8.0 mm       |
| Width   | 45.7 mm                     | 45.7 mm      | 45.7 mm      | 45.7 mm      |
| Weight  | 101 g                       | 101 g        | 101 g        | 101 g        |
| <b>Interface type</b>                               | SATA                        | SATA         | SATA         | SATA         |
| <b>Transfer rate</b>                                | 100 MB/sec                  | 100 MB/sec   | 100 MB/sec   | 100 MB/sec   |
| <b>Security</b>                                     | ATA security                | ATA security | ATA security | ATA security |
| <b>Seek times</b> (typical read, including setting) |                             |              |              |              |
| Single track  | 1.5 ms                      | 1.5 ms       | 3 ms         | 3 ms         |
| Average   | 12 ms                       | 12 ms        | 13 ms        | 13 ms        |
| Maximum   | 21 ms                       | 21 ms        | 24 ms        | 24 ms        |
| <b>Logical blocks</b>                               | 488,397,168                 | 312,581,808  | 234,456,960  | 156,304,640  |
| <b>Disc rotational speed</b>                        | 5400 rpm                    | 5400 rpm     | 5400 rpm     | 5400 rpm     |
| <b>Operating temperature</b>                        | 5°C to 55°C (41°F to 131°F) |              |              |              |

\*1 GB = 1 billion bytes when referring to hard drive storage capacity. Actual accessible capacity is less. Actual drive specifications may differ slightly.



Certain restrictions and exclusions apply. Contact technical support for details.

## System DMA specifications

| Hardware | DMA System function             |
|----------|---------------------------------|
| DMA0     | Not applicable                  |
| DMA1*    | Not applicable                  |
| DMA2*    | Not applicable                  |
| DMA3     | Not applicable                  |
| DMA4     | Direct memory access controller |
| DMA5*    | Not applicable                  |
| DMA6     | Not assigned                    |
| DMA7     | Not assigned                    |

\*PC Card controller can use DMA 1, 2, or 5.

## System interrupt specifications

| Hardware IRQ | System function  |
|--------------|--|
| IRQ0         | System timer   |
| IRQ1         | Standard 101-/102-Key or Microsoft® Natural Keyboard   |
| IRQ8         | System CMOS/real-time clock  |
| IRQ12        | Synaptics PS/2 TouchPad  |
| IRQ13        | Numeric data processor   |
| IRQ16        | Intel® ICH9 Family USB universal Host Controller 2937<br>Mobile Intel 4 Series Express Chipset Family  |
| IRQ17        | High Definition Audio Controller<br>Intel® ICH9 Family USB universal Host Controller 2938<br>Marvel Yukon 88E8072 PCIE-Gigabit Ethernet Controller |
| IRQ18        | Intel® ICH9 Family USB universal Host Controller 2939<br>Intel® ICH9 Family USB universal Host Controller 2936                                     |
| IRQ19        | Intel® ICH9 Family USB2 Enhanced Controller 293C   |
| IRQ20        | Intel® ICH9 Family USB2 Enhanced Controller 293A<br>Intel® ICH9 Family USB universal Host Controller 2934  |
| IRQ21        | Intel® ICH9M-E/M SATA AHCI Controller  |
| IRQ22        | Intel® ICH9 Family USB universal Host Controller 2935  |

\*Default configuration; audio possible configurations are IRQ5, IRQ7, IRQ9, IRQ10, or none.

 PC Cards may assert IRQ3, IRQ4, IRQ5, IRQ7, IRQ9, IRQ10, IRQ11, or IRQ15. Either the infrared or the serial port may assert IRQ3 or IRQ4.

 For operating systems after Windows 2000, APIC (Advanced programming interrupt controller) is used.

## System I/O address specifications

| I/O address (hex) | System function (shipping configuration)             |
|-------------------|--|
| 000 - 01F         | DMA controller                                       |
| 020 - 021         | Program interrupt controller                         |
| 024 - 025         | Program interrupt Controller                         |
| 028 - 029         | Program interrupt Controller                         |
| 02C - 03D         | Program interrupt Controller                         |
| 02E - 02F         | Motherboard Resource                                 |
| 030 - 031         | Program interrupt Controller                         |
| 034 - 035         | Program interrupt Controller                         |
| 038 - 039         | Program interrupt Controller                         |
| 03C- 03D          | Program interrupt Controller                         |
| 040 - 043         | System Timer   |
| 04E-04F           | Motherboard Resource                                 |
| 050-053           | System Timer   |
| 060               | Standard 101-/102-Key or Microsoft. Natural Keyboard |
| 061               | Motherboard Resource                                 |
| 062               | Microsoft ACPI-Compliant Embedded Controller         |
| 063               | Motherboard Resource                                 |
| 064               | Standard 101-/102-Key or Microsoft. Natural Keyboard |
| 065               | Motherboard resources                                |
| 066               | Microsoft ACPI-Compliant Embedded Controller         |
| 067               | Motherboard resources                                |
| 070               | Motherboard resources                                |
| 070-077           | System CMOS/real time clock                          |
| 080               | Motherboard resources                                |
| 081-091           | Direct memory access controller                      |
| 092               | Motherboard resources                                |
| 093-09F           | Direct memory access controller                      |
| 0A0-0A1           | Program interrupt Controller                         |
| 0A4-0A5           | Program interrupt Controller                         |
| 0A8-0A9           | Program interrupt Controller                         |
| 0AC-0AD           | Program interrupt Controller                         |
| 0B0-0B1           | Program interrupt Controller                         |
| 0B2-0B3           | Motherboard resources                                |
| 0B4- 0B5          | Program interrupt Controller                         |
| 0B8-0B9           | Program interrupt Controller                         |
| 0BC- 0BD          | Program interrupt Controller                         |

(Continued)



| <b>I/O address (hex)</b> | <b>System function (shipping configuration)</b>         |
|--------------------------|---|
| 0C0-0DF                  | Direct memory access controller                         |
| 0F0-0F0                  | Numeric data processor                                  |
| 0200-027F                | Motherboard resource                                    |
| 3B0-3BB                  | Mobile Intel 4 series Express Chipset Family            |
| 3C0-3DF                  | Mobile Intel 4 series Express Chipset Family            |
| 400-47F                  | Motherboard resource                                    |
| 4D0-4D1                  | Programmable interrupt controller                       |
| 500-57F                  | Motherboard resources                                   |
| 1000-1003                | Motherboard resources                                   |
| 1010-101F                | Motherboard resources                                   |
| 2000-20FF                | Marvell Yukon 88E8072 PCI-E Gigabit Ethernet Controller |
| 2000-2FFF                | ICH9 Family PCI Express Root Port6-294A                 |
| 3000-4FFF                | ICH9 Family PCI Express Root Port5-2948                 |
| 5000-6FFF                | ICH9 Family PCI Express Root Port3-2944                 |
| 7000-701F                | ICH9M-E/M SATA AHCI Controller                          |
| 7020-703F                | ICH9 Family USB universal Host Controller-2936          |
| 7040-705F                | ICH9 Family USB universal Host Controller-2935          |
| 7060-707F                | ICH9 Family USB universal Host Controller-2934          |
| 7080-709F                | ICH9 Family USB universal Host Controller-2939          |
| 70A0-70BF                | ICH9 Family USB universal Host Controller-2938          |
| 70C0-70DF                | ICH9 Family USB universal Host Controller-2937          |
| 70E0-70E7                | ICH9M-E/M SATA AHCI Controller                          |
| 70E8-70EF                | ICH9M-E/M SATA AHCI Controller                          |
| 70F0-70F7                | Mobile Intel 4 series Express Chipset Family            |
| 70F8-70FB                | ICH9M-E/M SATA AHCI Controller                          |
| 70FC-70FF                | ICH9M-E/M SATA AHCI Controller                          |
| EF80-EF9F                | Motherboard resources                                   |
| FE00-FE0F                | Motherboard resources                                   |
| FE80-EF8F                | Motherboard resources                                   |
| FFFF                     | Motherboard resources                                   |

## System memory map specifications

| Size   | Memory address         | System function                             |
|--------|------------------------|---|
| 640 KB | 00000000-0009FFFF      | Base memory                                 |
| 128 KB | 000A0000-000BFFFF      | Video memory                                |
| 64 KB  | 000C0000-000CFFFF      | Video BIOS                                  |
| 64 KB  | 000E8000-000FFFFF      | System BIOS                                 |
|        | 00100000- XFFFFFFF     | Extended memory (based on memory installed) |
|        | (X+1)0000000-FEDFFFFFF | PCI bus                                     |
|        | FED00000-FED003FF      | High precision event timer                  |
|        | FEE01000-FFFFFFF       | PCI bus                                     |

## Screw listing

This section provides specification and reference information for the screws used in the computer. Some screws listed in this section are available in the Screw Kit, spare part number 501498-001.

### Phillips PM2.0×5.0 captive screw

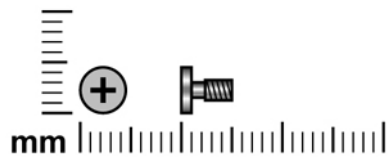

| Color | Quantity | Length | Thread | Head diameter |
|-------|----------|--------|--------|---------------|
| Black | 6        | 5.0 mm | 2.0 mm | 5.0 mm        |

**Where used:** 6 captive screws that secure the hard drive cover to the computer (screws are secured by C clips)

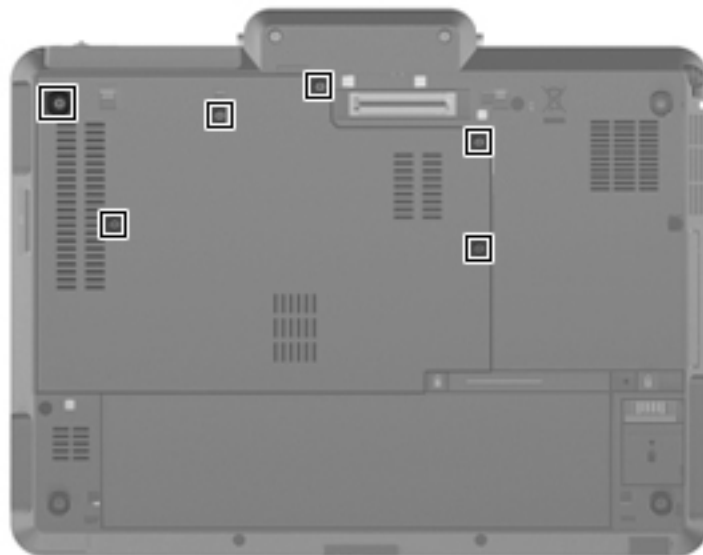

## Phillips PM2.0×3.0 screw

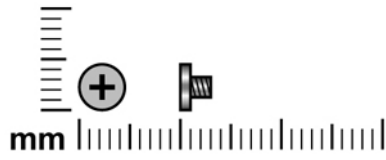

| Color  | Quantity | Length | Thread | Head diameter |
|--------|----------|--------|--------|---------------|
| Silver | 2        | 3.0 mm | 2.0 mm | 5.0 mm        |

**Where used:** 2 screws that secure the hard drive bracket to the system board

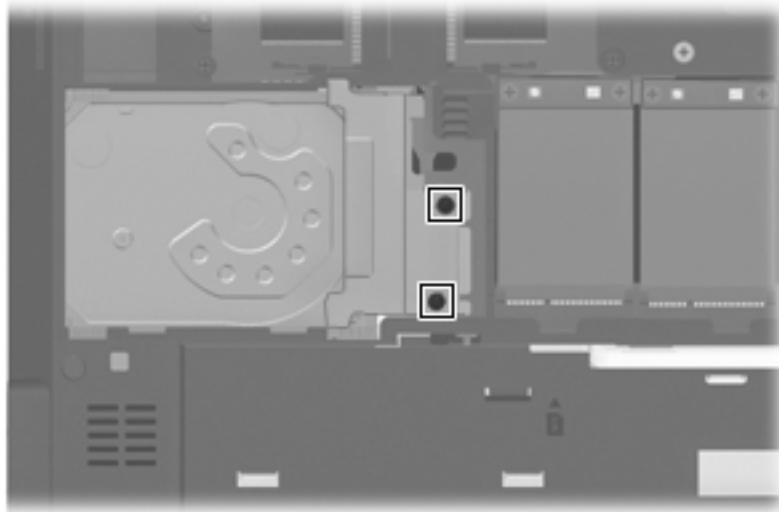

## Phillips PM2.0×4.0 screw

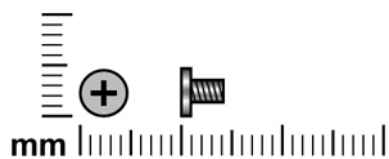

| Color | Quantity | Length | Thread | Head diameter |
|-------|----------|--------|--------|---------------|
| Black | 6        | 4.0 mm | 2.0 mm | 5.0 mm        |

### Where used:

- ❶ Two screws that secure the WLAN module to the system board
- ❷ Two screws that secure the WWAN module to the system board

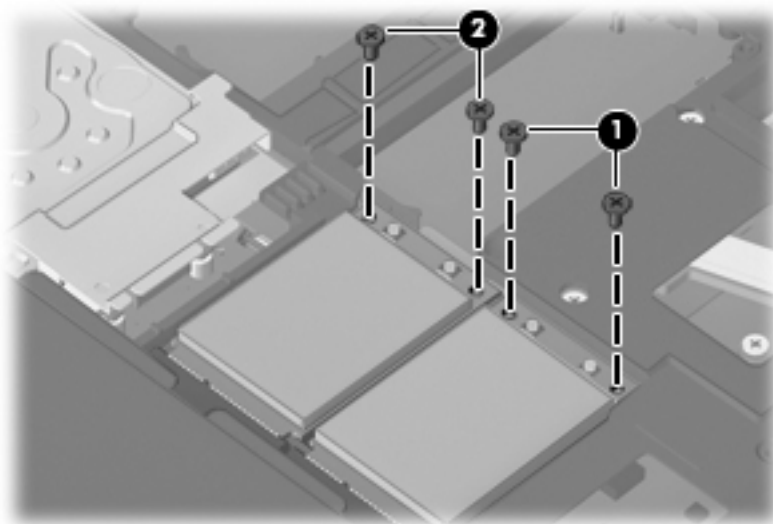

**Where used:** 2 screws that secure the modem module to the system board

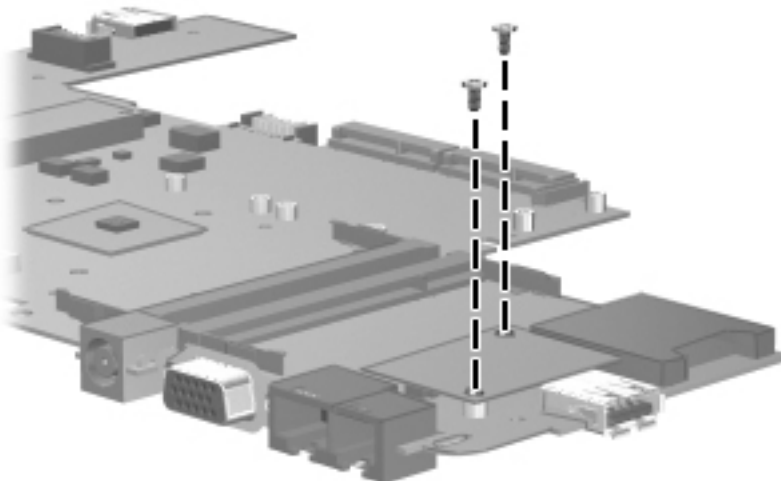

## Torx T8M2.0×8.0 screw

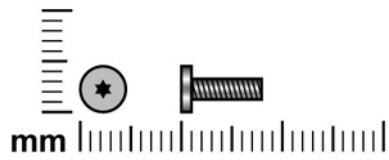

| Color | Quantity | Length | Thread | Head diameter |
|-------|----------|--------|--------|---------------|
| Black | 9        | 8.0 mm | 2.0 mm | 4.5 mm        |

**Where used:** 6 screws that secure the keyboard to the computer

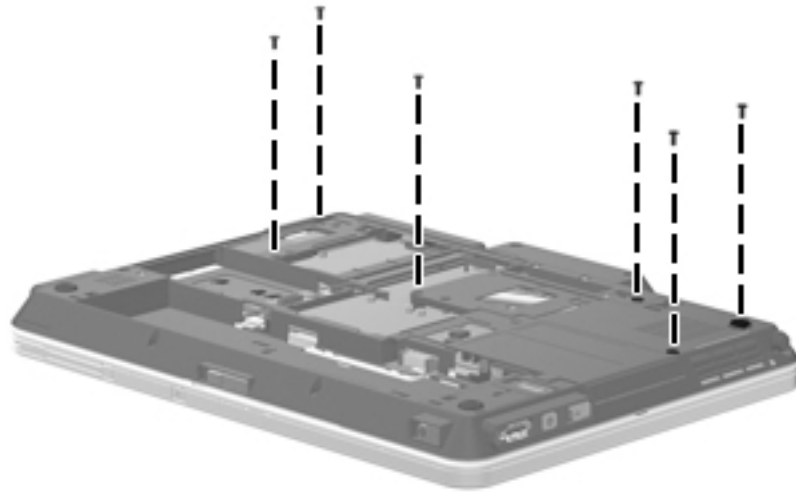

**Where used:** 3 screws that secure the top cover to the base enclosure

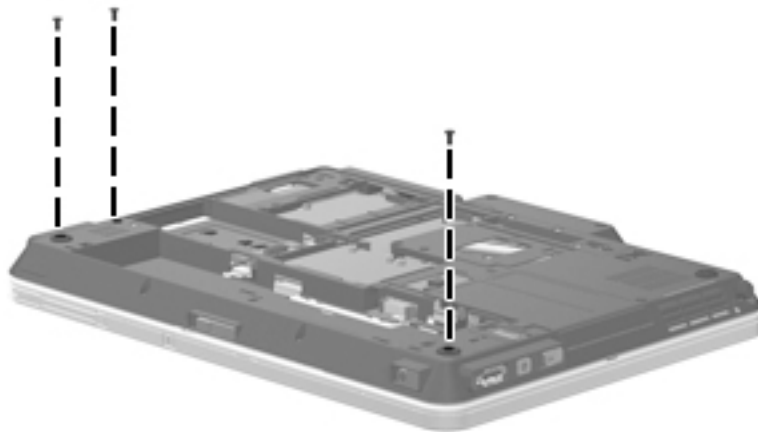

## Torx T8M2.0×5.0 screw

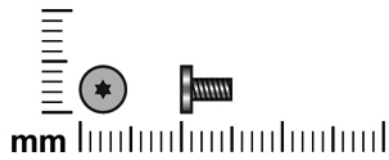

| Color | Quantity | Length | Thread | Head diameter |
|-------|----------|--------|--------|---------------|
| Black | 4        | 5.0 mm | 2.0 mm | 4.5 mm        |

**Where used:** 2 screws that secure the hinge cover to the computer

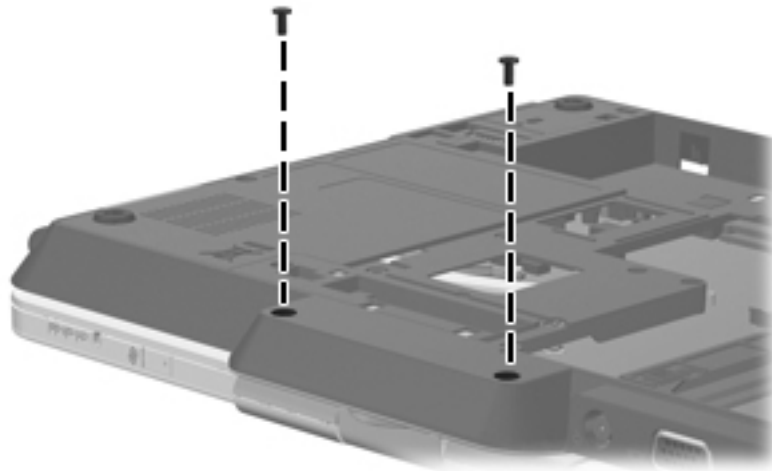

**Where used:** 2 screws that secure the top cover to the base enclosure

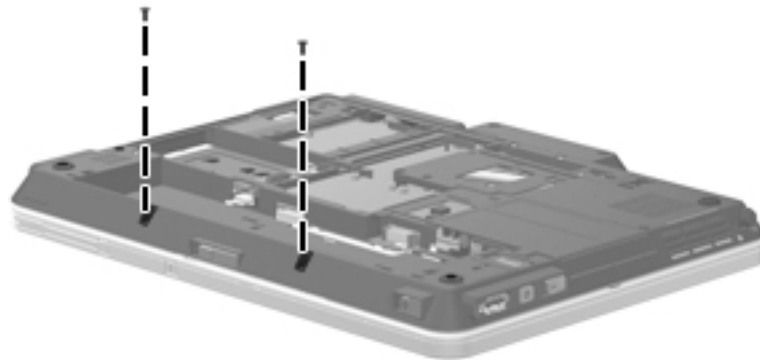

## Phillips PM2.0×5.0 screw

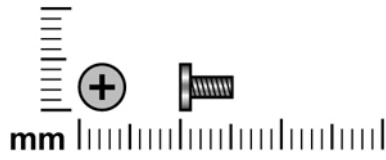

| Color | Quantity | Length | Thread | Head diameter |
|-------|----------|--------|--------|---------------|
| Black | 8        | 5.0 mm | 2.0 mm | 5.0 mm        |

**Where used:** 2 screws that secure the top cover to the base enclosure

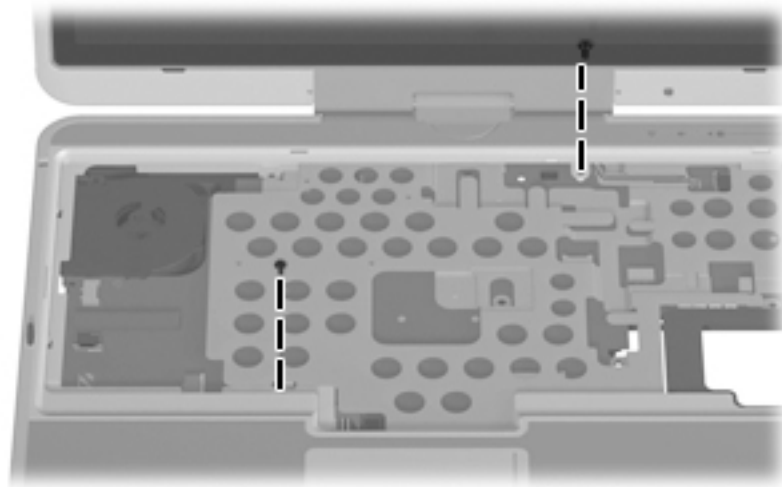

**Where used:** One screw that secures the audio connector board to the base enclosure

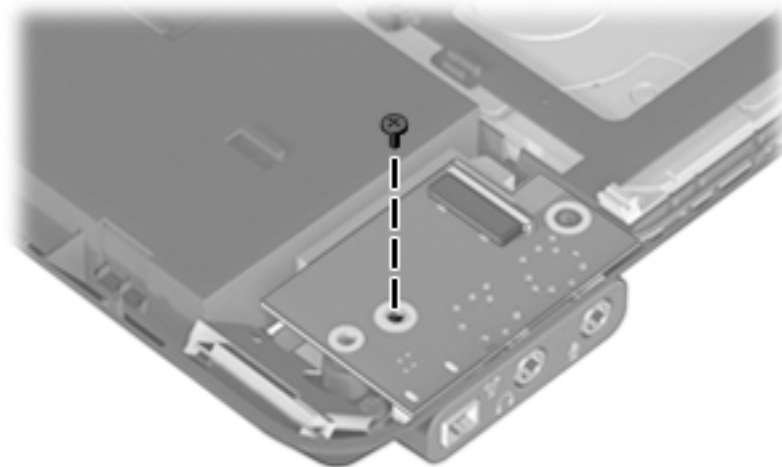



**Where used:** One screw that secures the speaker to the base enclosure

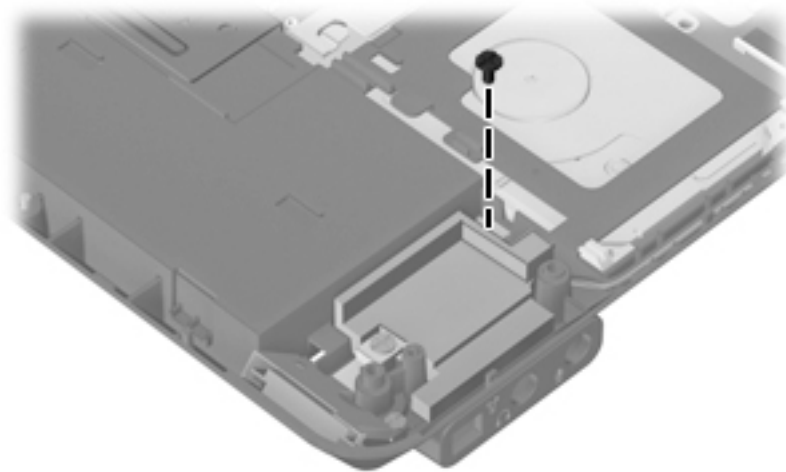

**Where used:** 4 screws that secure the system board to the base enclosure

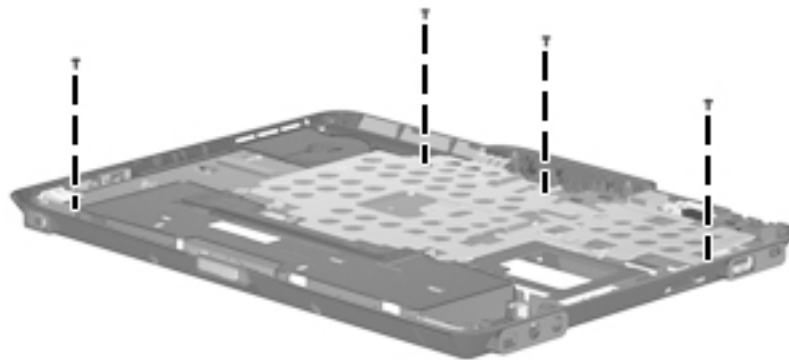

## Phillips PM2.0×4.0 screw

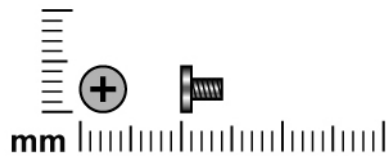

| Color | Quantity | Length | Thread | Head diameter |
|-------|----------|--------|--------|---------------|
| Black | 4        | 4.0 mm | 2.0 mm | 4.0 mm        |

**Where used:** One screw that secures the Bluetooth module to the base enclosure

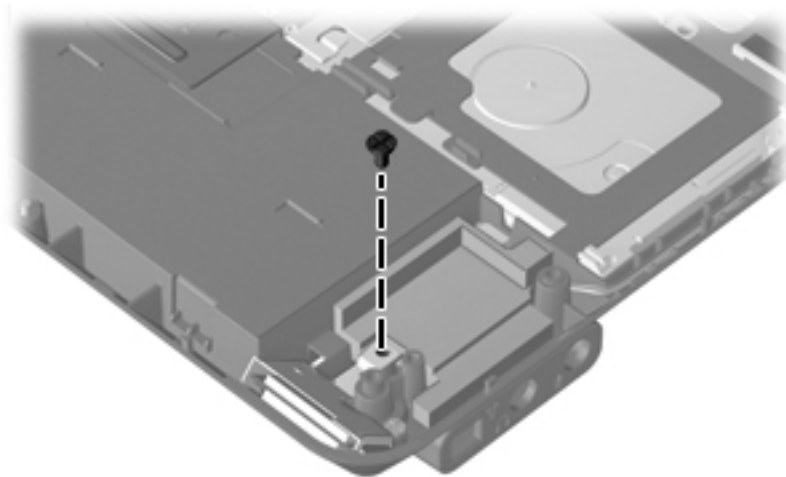

**Where used:**

- ❶ One screw that secures the display converter cable to the system board
- ❷ Two screws that secure the display panel cable to the system board

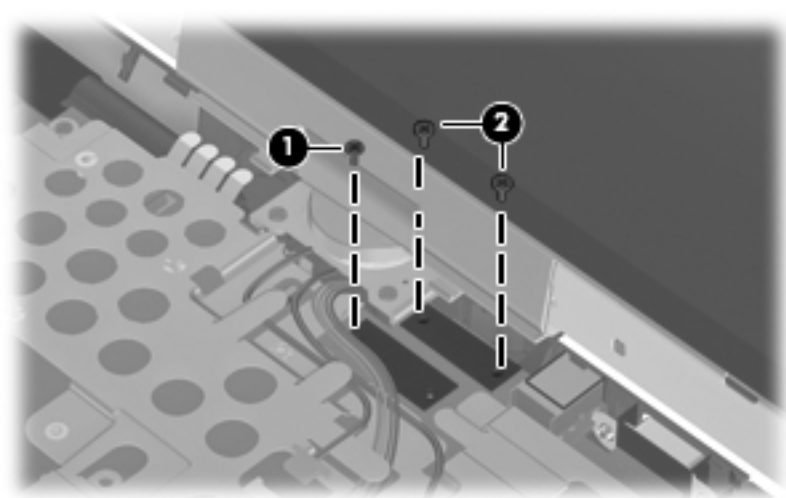

## Torx T8M2.5×6.0 screw

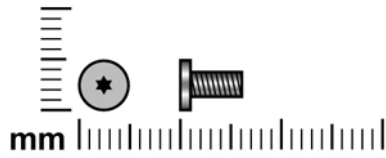

| Color | Quantity | Length | Thread | Head diameter |
|-------|----------|--------|--------|---------------|
| Black | 4        | 6.0 mm | 2.5 mm | 5.0 mm        |

**Where used:** 4 screws that secure the display assembly to the computer

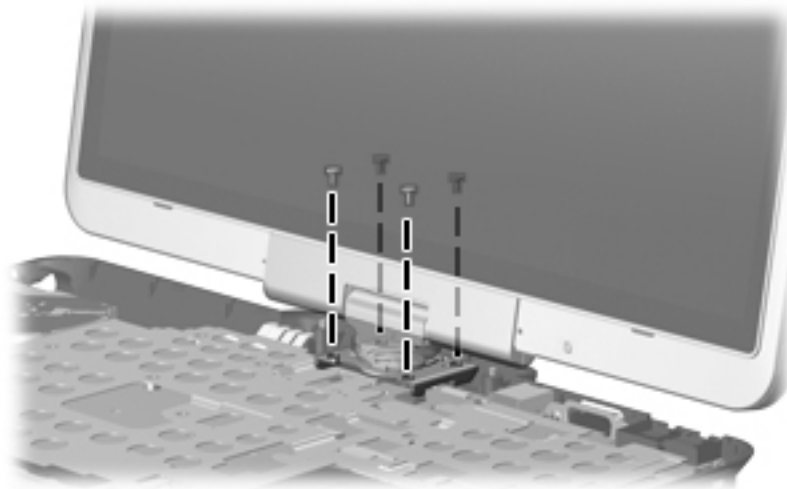

## Phillips PM2.5×7.0 captive screw

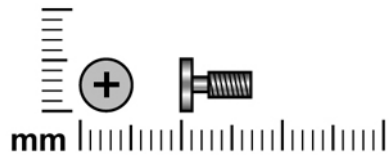

| Color  | Quantity | Length | Thread | Head diameter |
|--------|----------|--------|--------|---------------|
| Silver | 6        | 7.0 mm | 2.5 mm | 5.0 mm        |

**Where used:** 6 captive screws that secure the fan/heat sink assembly to the system board (screws are secured by C clips)

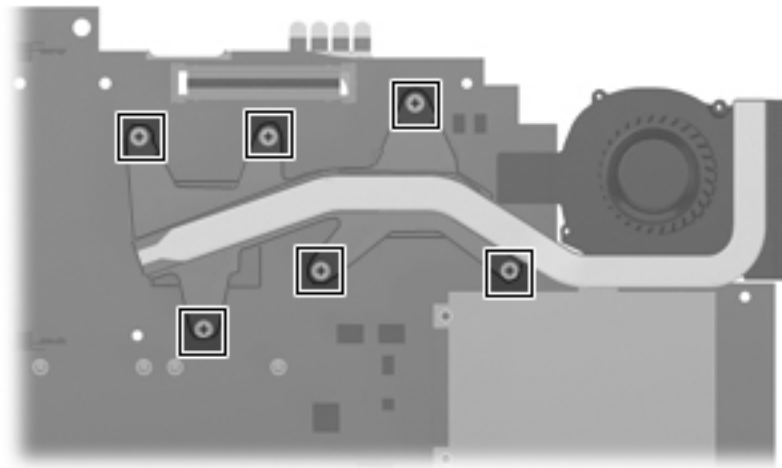

---

# Backup and recovery

## Backup and recovery in Windows Vista

### Overview

To protect your information, use the Backup and Restore Center to back up individual files and folders, back up your entire hard drive (select models only), or create system restore points. In case of system failure, you can use the backup files to restore the contents of your computer.

The Backup and Restore Center provides the following options:

- Backing up individual files and folders
- Backing up the entire hard drive (select models only)
- Scheduling automatic backups (select models only)
- Creating system restore points
- Recovering individual files
- Restoring the computer to a previous state
- Recovering information using recovery tools



For detailed instructions, perform a search for these topics in Help and Support.

---



In case of system instability, HP recommends that you print the recovery procedures and save them for later use.

---

### Backing up your information

Recovery after a system failure is as complete as your most current backup. You should create your initial backup immediately after software setup. As you add new software and data files, you should continue to back up your system on a regular basis to maintain a reasonably current backup.

You can back up your information to an optional external hard drive, a network drive, or discs.

Note the following when backing up:

- Store personal files in the Documents folder, and back it up regularly.
- Back up templates that are stored in their associated programs.
- Save customized settings that appear in a window, toolbar, or menu bar by taking a screen shot of your settings. The screen shot can be a time-saver if you have to reset your preferences.

To create a screen shot:

1. Display the screen you want to save.
2. Copy the screen image:

To copy only the active window, press **alt+fn+prt sc**.

To copy the entire screen, press **fn+prt sc**.

3. Open a word-processing document, and then select **Edit > Paste**.

The screen image is added to the document.

4. Save the document.

- When backing up to discs, use any of the following types of discs (purchased separately): CD-R, CD-RW, DVD+R, DVD+R DL, DVD-R, DVD-R DL, or DVD RW. The discs you use will depend on the type of optical drive installed in your computer.

 DVDs and DVDs with double-layer (DL) support store more information than CDs, so using them for backup reduces the number of recovery discs required.

- When backing up to discs, number each disc before inserting it into the optical drive of the computer.

To create a backup using Backup and Restore Center, follow these steps:

---

 Be sure that the computer is connected to AC power before you start the backup process.

---

 The backup process may take over an hour, depending on file size and the speed of the computer.

---

1. Select **Start > All Programs > Maintenance > Backup and Restore Center**.
2. Follow the on-screen instructions to back up your entire computer (select models only) or your files.

 Windows includes the User Account Control feature to improve the security of your computer. You may be prompted for your permission or password for tasks such as installing software, running utilities, or changing Windows settings. Refer to Help and Support for more information.

## Performing a recovery

In case of system failure or instability, the computer provides the following tools to recover your files:

- Windows recovery tools: You can use the Backup and Restore Center to recover information you have previously backed up. You can also use Windows Startup Repair to fix problems that might prevent Windows from starting correctly.

- f11 recovery tools: You can use the f11 recovery tools to recover your original hard drive image. The image includes the Windows operating system and software programs installed at the factory.

 If you are unable to boot (start up) your computer, you must purchase a Windows Vista operating system DVD to reboot the computer and repair the operating system. For additional information, refer to the Using a Windows Vista operating system DVD (purchased separately) section in this guide.

## Using the Windows recovery tools

To recover information you previously backed up, follow these steps:

1. Click **Start > All Programs > Maintenance > Backup and Restore Center**.
2. Follow the on-screen instructions to recover your entire computer (select models only) or your files.

 Windows includes the User Account Control feature to improve the security of your computer. You may be prompted for your permission or password for tasks such as installing software, running utilities, or changing Windows settings. Refer to Help and Support for more information.

To recover your information using Startup Repair, follow these steps:

---

 **CAUTION:** Using Startup Repair completely erases hard drive contents and reformats the hard drive. All files you have created and any software installed on the computer are permanently removed. When reformatting is complete, the recovery process restores the operating system, as well as the drivers, software, and utilities from the backup used for recovery.

---

1. If possible, back up all personal files.
2. If possible, check for the presence of the Windows partition and the HP Recovery partition. To find the partitions, select **Start > Computer**.

 If the Windows partition and the HP Recovery partition have been deleted, you must recover your operating system and programs using the Windows Vista operating system DVD and the Driver Recovery disc (both purchased separately). For additional information, refer to the Using a Windows Vista operating system DVD (purchased separately) section in this guide.

3. Restart the computer, and then press **f8** before the Windows operating system loads.
4. Select **Repair your computer**.
5. Follow the on-screen instructions.

 For additional information on recovering information using the Windows tools, perform a search for these topics in Help and Support.

## Using f11

---

 **CAUTION:** Using **f11** completely erases hard drive contents and reformats the hard drive. All files you have created and any software installed on the computer are permanently removed. The **f11** recovery tool reinstalls the operating system and HP programs and drivers that were installed at the factory. Software not installed at the factory must be reinstalled.

---

To recover the original hard drive image using **f11**, follow these steps:

1. If possible, back up all personal files.
2. If possible, check for the presence of the HP Recovery partition. To find the partition, select **Start > Computer**.

 If the HP Recovery partition has been deleted, you must recover your operating system and programs using the Windows Vista operating system DVD and the Driver Recovery disc (both purchased separately). For additional information, refer to the “Using a Windows Vista operating system DVD (purchased separately)” section in this guide.

3. Turn on or restart the computer, and then press **esc** while the “Press the ESC key for Startup Menu” message is displayed at the bottom of the screen.
4. Press **f11** while the “Press <F11> for recovery” message is displayed on the screen.
5. Follow the on-screen instructions.

## Using a Windows Vista operating system DVD (purchased separately)

If you are unable to boot (start up) your computer, you must purchase a Windows Vista operating system DVD to reboot the computer and repair the operating system. Make sure that your most recent backup (stored on discs or on an external drive) is easily accessible. To order a Windows Vista operating system DVD, go to <http://www.hp.com/support>, select your country or region, and follow the on-screen instructions. You can also order the DVD by calling technical support. For contact information, refer to the Worldwide Telephone Numbers booklet included with the computer.



**CAUTION:** Using a Windows Vista operating system DVD completely erases hard drive contents and reformats the hard drive. All files you have created and any software installed on the computer are permanently removed. When reformatting is complete, the recovery process helps you restore the operating system, as well as drivers, software, and utilities.

---

To initiate recovery using a Windows Vista operating system DVD, follow these steps:

---



This process takes several minutes.

---

1. If possible, back up all personal files.
2. Restart the computer, and then insert the Windows Vista operating system DVD into the optical drive before the Windows operating system loads.
3. When prompted, press any keyboard key.
4. Follow the on-screen instructions.
5. Click **Next**.
6. Select **Repair your computer**.
7. Follow the on-screen instructions.



# Backup and recovery in Windows XP

## Overview

To protect your information, use the Windows Backup utility (select models only) to back up files and folders or create recovery points. In case of system failure, you can use the backup files to restore your computer.

Windows provides the following options:

- Backing up individual files and folders
- Backing up all files and folders
- Scheduling automatic backups
- Creating recovery points
- Recovering information



---

For detailed instructions, perform a search for these topics in Help and Support.

---



---

In case of system instability, HP recommends that you print the recovery procedures and save them for later use.

---

## Backing up your information

Recovery after a system failure is as complete as your most current backup. You should create your initial backup immediately after software setup. As you add new software and data files, you should continue to back up your system on a regular basis to maintain a reasonably current backup.

You can back up individual files or folders to an optional external hard drive or to a network drive.

Note the following when backing up:

- Store personal files in the My Documents folder, and back it up periodically.
- Back up templates stored in their associated programs.
- Save customized settings that appear in a window, toolbar, or menu bar by taking a screen shot of your settings. The screen shot can be a time saver if you have to reset your preferences.

To copy the screen and paste it into a word-processing document:

- a. Display the screen you want to save.
- b. Copy the screen image:
  - To copy only the active window, press **alt+fn+prt sc**.
  - To copy the entire screen, press **fn+prt sc**.
- c. Open a word-processing document, click **Edit > Paste**.
  - The screen image is added to the document.
- d. Save the document.

To create a backup using the Windows Backup utility (select models only), follow these steps:



---

Be sure that the computer is connected to AC power before you start the backup process.

---



---

The backup process may take over an hour, depending on file size and the speed of the computer.

---

1. Click **Start > All Programs > Accessories > System Tools > Backup**.
2. Follow the on-screen instructions.

## Performing a recovery

In case of system failure or instability, the computer provides the following tools to recover your files:

- Windows recovery tools (select models only): You can use the Windows Backup utility to recover information you have previously backed up.
- Operating System and Driver Recovery discs (included with your computer): You can use the discs to recover your operating system and programs installed at the factory.

## Recovering your information

To recover information you previously backed up, follow these steps:

1. If possible, back up all personal files.
2. Click **Start > All Programs > Accessories > System Tools > Backup**.  
The Backup or Restore Wizard opens.
3. Click **Restore files and settings**, and then click **Next**.
4. Follow the on-screen instructions.



---

For additional information on initiating a recovery in Windows, perform a search for this topic in Help and Support.

---

## Recovering the operating system and programs



**CAUTION:** The recovery process reformats and completely erases the hard drive. All files you have created and any software installed on the computer are permanently removed. The recovery process reinstalls the original operating system, software, and drivers. Software, drivers, and updates not installed by HP must be manually reinstalled.

---

To recover your operating system and programs, follow these steps:

1. If possible, back up all personal files.
2. Insert the Operating System disc into the optical drive.
3. Shut down the computer.
4. Turn on the computer.
5. Follow the on-screen instructions to install the operating system.
6. After the operating system is installed, remove the Operating System disc and insert the Driver Recovery disc.
7. Follow the on-screen instructions to install the drivers and programs.

---

## Connector pin assignments

1394

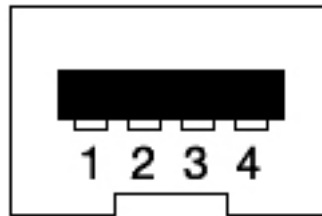

| Pin | Signal |
|-----|--------|
| 1   | TPB-   |
| 2   | TPB+   |
| 2   | TPA-   |
| 4   | TPA+   |

## Audio-in (microphone)

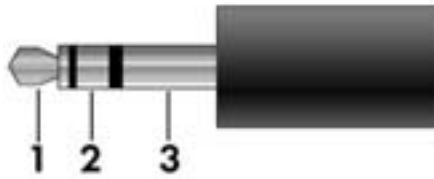

| Pin | Signal          |
|-----|-----------------|
| 1   | Audio signal in |
| 2   | Audio signal in |
| 3   | Ground          |

## Audio-out (headphone)

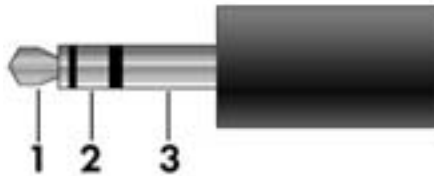

| Pin | Signal                   |
|-----|--------------------------|
| 1   | Audio out, left channel  |
| 2   | Audio out, right channel |
| 3   | Ground                   |

## External monitor

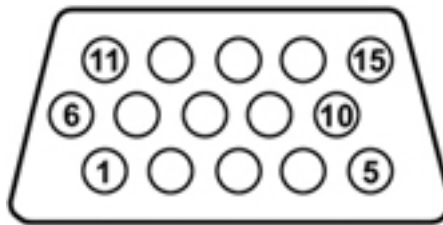

| Pin | Signal          |
|-----|-----------------|
| 1   | Red analog      |
| 2   | Green analog    |
| 3   | Blue analog     |
| 4   | Not connected   |
| 5   | Ground          |
| 6   | Ground analog   |
| 7   | Ground analog   |
| 8   | Ground analog   |
| 9   | +5 VDC          |
| 10  | Ground          |
| 11  | Monitor detect  |
| 12  | DDC 2B data     |
| 13  | Horizontal sync |
| 14  | Vertical sync   |
| 15  | DDC 2B clock    |

## RJ-11 (modem)

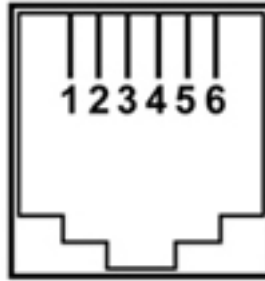

| Pin | Signal |
|-----|--------|
| 1   | Unused |
| 2   | Tip    |
| 3   | Ring   |
| 4   | Unused |
| 5   | Unused |
| 6   | Unused |

## RJ-45 (network)

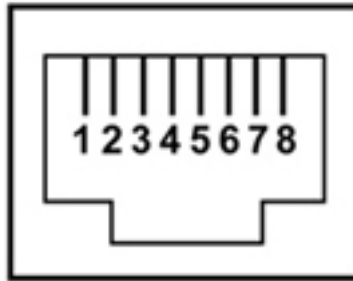

| Pin | Signal     |
|-----|------------|
| 1   | Transmit + |
| 2   | Transmit - |
| 3   | Receive +  |
| 4   | Unused     |
| 5   | Unused     |
| 6   | Receive -  |
| 7   | Unused     |
| 8   | Unused     |

## Universal Serial Bus

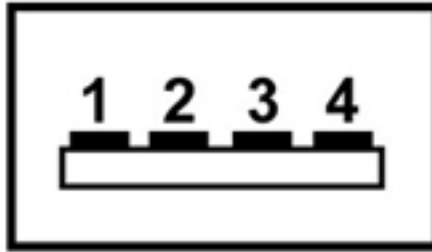

| Pin | Signal |
|-----|--------|
| 1   | +5 VDC |
| 2   | Data   |
| 3   | Data + |
| 4   | Ground |



---

## Power cord set requirements

The wide range input feature of the computer permits it to operate from any line voltage from 100 to 120 volts AC or from 220 to 240 volts AC.

The 3-conductor power cord set included with the computer meets the requirements for use in the country or region where the equipment is purchased.

Power cord sets for use in other countries and regions must meet the requirements of the country or region where the computer is used.

### Requirements for all countries and regions

The requirements listed below are applicable to all countries and regions:

- The length of the power cord set must be at least 1.5 m (5.0 ft) and no more than 2.0 m (6.5 ft).
- All power cord sets must be approved by an acceptable accredited agency responsible for evaluation in the country or region where the power cord set will be used.
- The power cord sets must have a minimum current capacity of 10 amps and a nominal voltage rating of 125 or 250 V AC, as required by the power system of each country or region.
- The appliance coupler must meet the mechanical configuration of an EN 60 320/IEC 320 Standard Sheet C13 connector for mating with the appliance inlet on the back of the computer.

## Requirements for specific countries and regions

| Country/region                 | Accredited agency | Applicable note number |
|--------------------------------|-------------------|------------------------|
| Australia                      | EANSW             | 1                      |
| Austria                        | OVE               | 1                      |
| Belgium                        | CEBC              | 1                      |
| Canada                         | CSA               | 2                      |
| Denmark                        | DEMKO             | 1                      |
| Finland                        | FIMKO             | 1                      |
| France                         | UTE               | 1                      |
| Germany                        | VDE               | 1                      |
| Italy                          | IMQ               | 1                      |
| Japan                          | METI              | 3                      |
| The Netherlands                | KEMA              | 1                      |
| Norway                         | NEMKO             | 1                      |
| The People's Republic of China | CCC               | 5                      |
| South Korea                    | EK                | 4                      |
| Sweden                         | SEMKO             | 1                      |
| Switzerland                    | SEV               | 1                      |
| Taiwan                         | BSMI              | 4                      |
| The United Kingdom             | BSI               | 1                      |
| The United States              | UL                | 2                      |

1. The flexible cord must be Type HO5VV-F, 3-conductor, 1.0-mm<sup>2</sup> conductor size. Power cord set fittings (appliance coupler and wall plug) must bear the certification mark of the agency responsible for evaluation in the country or region where it will be used.
2. The flexible cord must be Type SPT-3 or equivalent, No. 18 AWG, 3-conductor. The wall plug must be a two-pole grounding type with a NEMA 5-15P (15 A, 125 V) or NEMA 6-15P (15 A, 250 V) configuration.
3. The appliance coupler, flexible cord, and wall plug must bear a "T" mark and registration number in accordance with the Japanese Dentori Law. The flexible cord must be Type VCT or VCTF, 3-conductor, 1.00-mm<sup>2</sup> conductor size. The wall plug must be a two-pole grounding type with a Japanese Industrial Standard C8303 (7 A, 125 V) configuration.
4. The flexible cord must be Type RVV, 3-conductor, 0.75-mm<sup>2</sup> conductor size. Power cord set fittings (appliance coupler and wall plug) must bear the certification mark of the agency responsible for evaluation in the country or region where it will be used.
5. The flexible cord must be Type VCTF, 3-conductor, 0.75-mm<sup>2</sup> conductor size. Power cord set fittings (appliance coupler and wall plug) must bear the certification mark of the agency responsible for evaluation in the country or region where it will be used.

## Battery

When a battery has reached the end of its useful life, do not dispose of the battery in general household waste. Follow the local laws and regulations in your area for computer battery disposal.

## Display

 **WARNING:** The backlight contains mercury. Caution must be exercised when removing and handling the backlight to avoid damaging this component and causing exposure to the mercury.

 **CAUTION:** The procedures in this chapter can result in damage to display components. The only components intended for recycling purposes are the liquid crystal display (LCD) panel and the backlight. When you remove these components, handle them carefully.

 **Materials Disposal.** This HP product contains mercury in the backlight in the display assembly that might require special handling at end-of-life. Disposal of mercury may be regulated because of environmental considerations. For disposal or recycling information, contact your local authorities, or see the Electronic Industries Alliance (EIA) Web site at <http://www.eiae.org>.

This section provides disassembly instructions for the display assembly. The display assembly must be disassembled to gain access to the backlight ❶ and the liquid crystal display (LCD) panel ❷.



 The procedures provided in this appendix are general disassembly instructions. Specific details, such as screw sizes, quantities, and locations, and component shapes and sizes, can vary from one computer model to another.

Perform the following steps to disassemble the display assembly:

1. Remove all screw covers ❶ and screws ❷ that secure the display bezel to the display assembly.

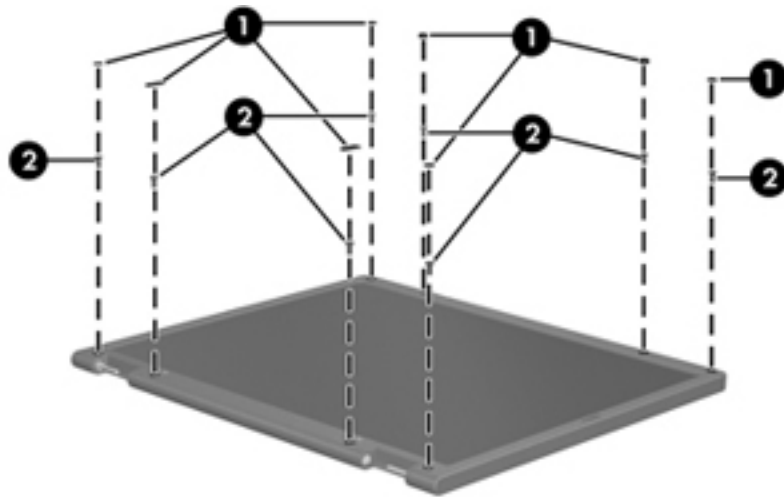

2. Lift up and out on the left and right inside edges ❶ and the top and bottom inside edges ❷ of the display bezel until the bezel disengages from the display assembly.
3. Remove the display bezel ❸.

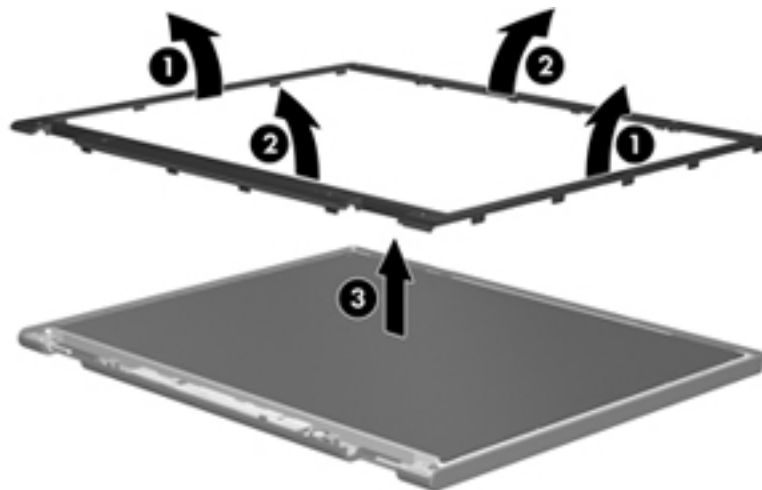

4. Disconnect all display panel cables ❶ from the display inverter and remove the inverter ❷.

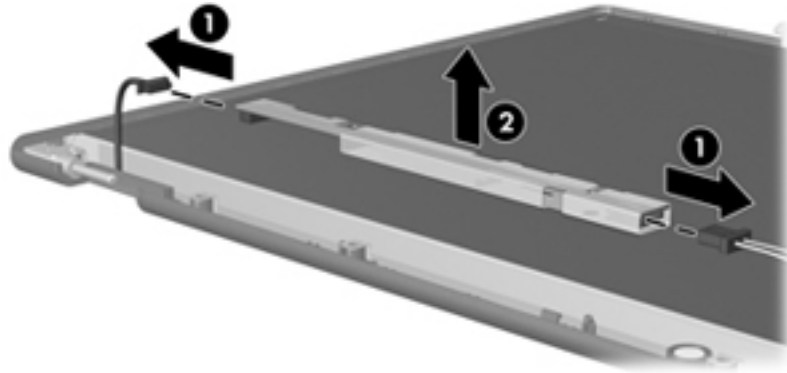

5. Remove all screws ❶ that secure the display panel assembly to the display enclosure.

6. Remove the display panel assembly ❷ from the display enclosure.

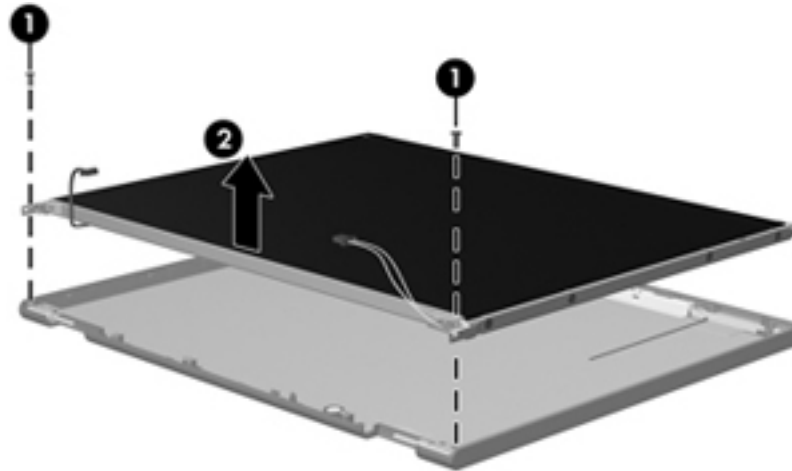

7. Turn the display panel assembly upside down.

8. Remove all screws that secure the display panel frame to the display panel.

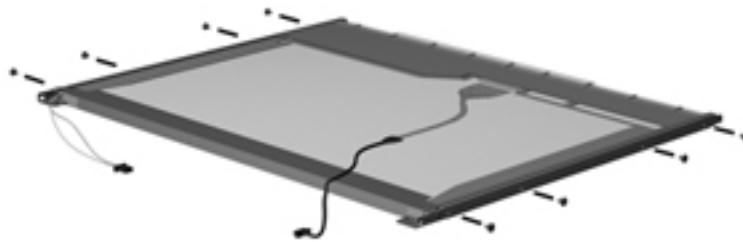

9. Use a sharp-edged tool to cut the tape ❶ that secures the sides of the display panel to the display panel frame.
10. Remove the display panel frame ❷ from the display panel.

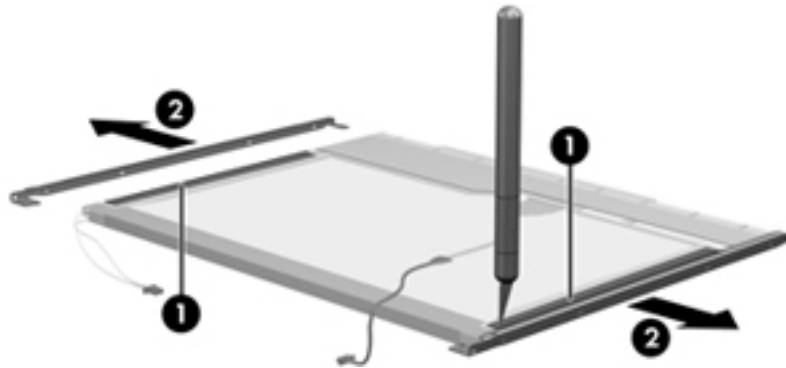

11. Remove the screws ❶ that secure the backlight cover to the display panel.
12. Lift the top edge of the backlight cover ❷ and swing it outward.

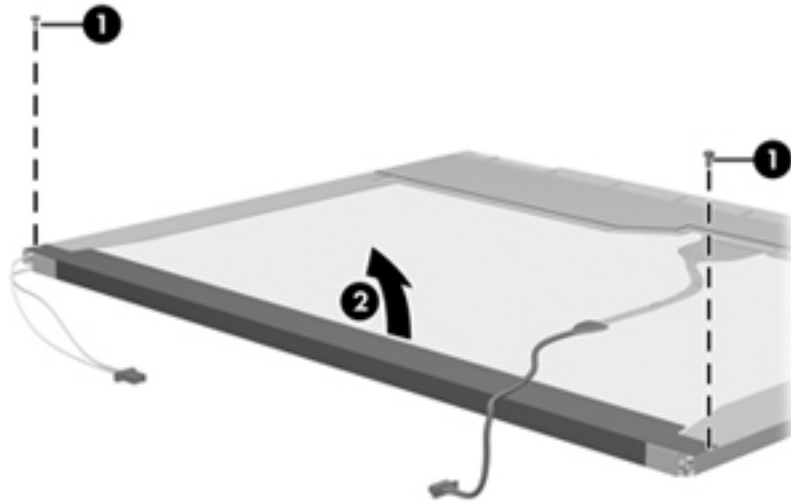

13. Remove the backlight cover.
14. Turn the display panel right-side up.
15. Remove the backlight cables ❶ from the clip ❷ in the display panel.

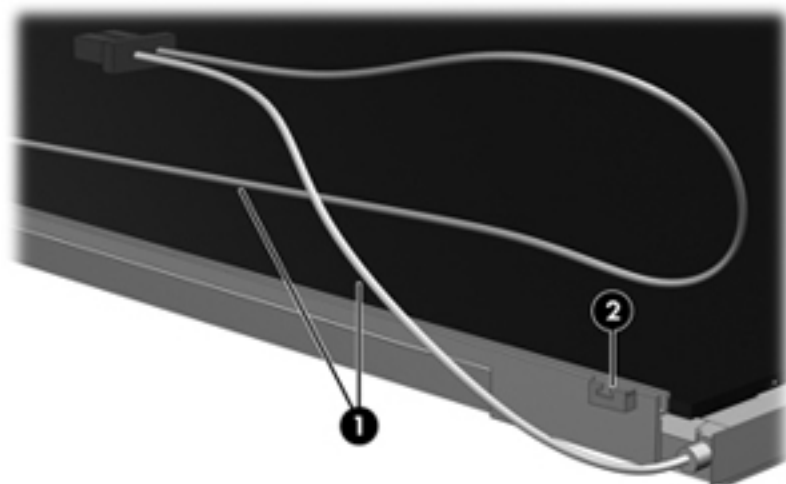

16. Turn the display panel upside down.
17. Remove the backlight frame from the display panel.

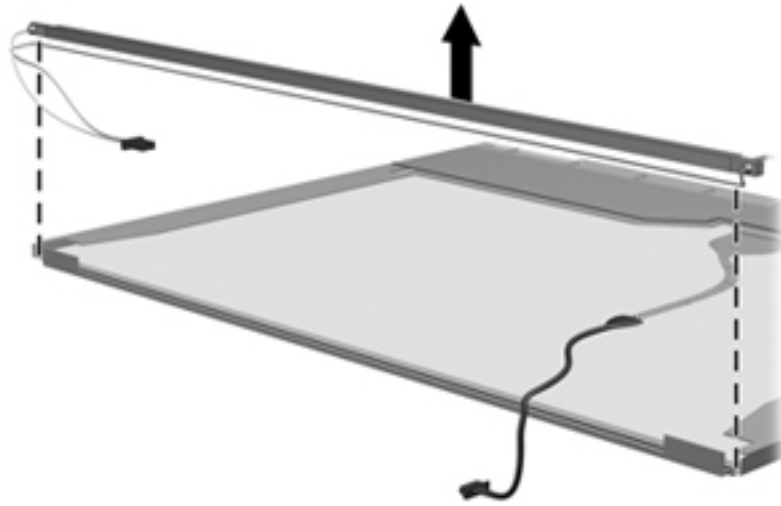

**WARNING:** The backlight contains mercury. Exercise caution when removing and handling the backlight to avoid damaging this component and causing exposure to the mercury.

18. Remove the backlight from the backlight frame.

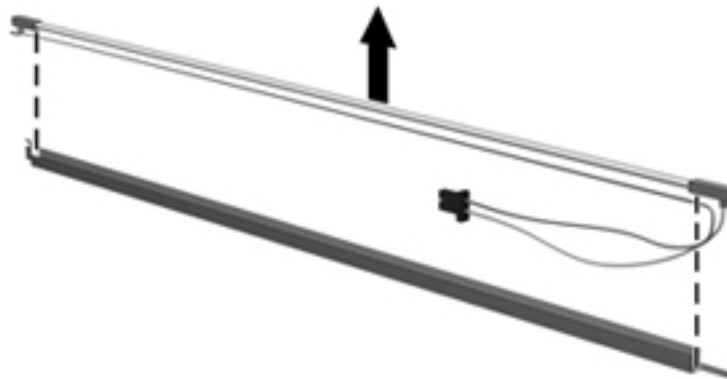

19. Disconnect the display cable ❶ from the LCD panel.
20. Remove the screws ❷ that secure the LCD panel to the display rear panel.
21. Release the LCD panel ❸ from the display rear panel.
22. Release the tape ❹ that secures the LCD panel to the display rear panel.

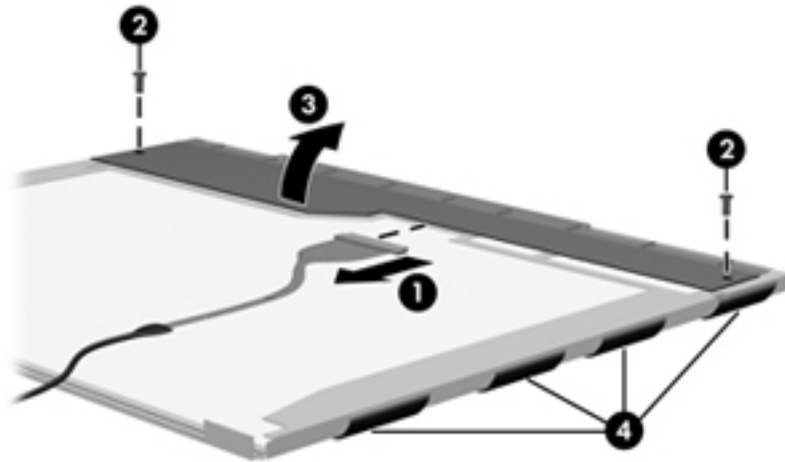

23. Remove the LCD panel.

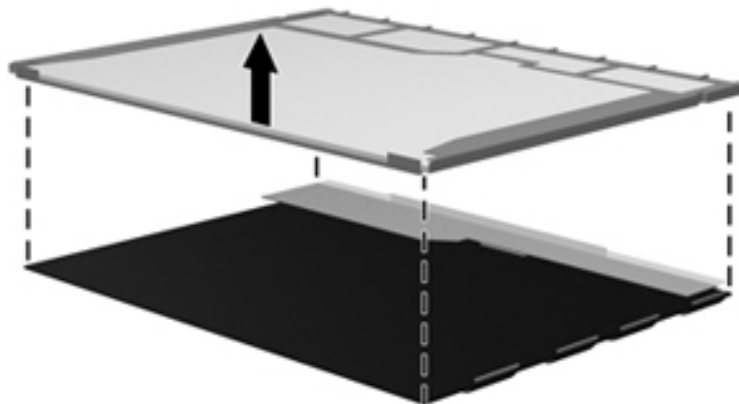

24. Recycle the LCD panel and backlight.



## 1394 port

- connector pinout 9-1
- enabling/disabling 5-8
- location 2-8

## A

AC adapter, spare part number 3-10, 3-11, 3-14, 3-15

accessory battery connector 2-12

accessory battery connector door 2-12

allow HP SpareKey enrollment 5-4

ambient light sensor

- enabling/disabling 5-6, 5-7

- location 2-2

AMT Options 5-8

AMT Setup Prompt 5-8

antenna

- spare part number 3-10, 3-14

antenna components 2-1

audio connector board

- removal 4-24

- spare part number 3-4, 3-14, 4-24

audio connector board cable, illustrated 3-7

audio-in jack

- connector pinout 9-2

- location 2-8

audio-out jack

- connector pinout 9-2

- location 2-8

automatic DriveLock 5-4

## B

backing up files and folders 8-1, 8-5

backing up your information 8-1

backup and recovery, overview 8-1

base enclosure, spare part number 3-4, 3-14

battery

- removal 4-8

- spare part number 3-4, 3-14, 4-8

battery bay 2-12

battery light 2-5

battery release latch 2-12

Bluetooth compartment 2-7

Bluetooth module

- enabling/disabling 5-6, 5-7

- removal 4-25

- spare part number 3-4, 3-11, 4-25

boot options 5-5

bottom components 2-12

business card slot 2-7

button components 2-3

buttons

- ctrl+alt+del 2-11

- Esc 2-11

- external WWAN antenna 2-7

- info 2-9, 2-10

- keyboard light 2-2, 2-7

- pointing stick 2-6

- presentation 2-3

- rotate 2-11

- TouchPad 2-6

- volume mute 2-3

## C

Cable Kit

- contents 3-7

- spare part number 3-6, 3-7, 3-14

cables, service considerations 4-1

caps lock light 2-5

charge level indicator 2-12

CMOS clearing 4-5

component replacement procedures 4-6

components

- antenna 2-1

- bottom 2-12

- buttons 2-3

- display 2-2

- front 2-7

- keys 2-4

- left-side 2-9, 2-10

- lights 2-5

- pointing devices 2-6

- rear 2-11

- right-side 2-8

- switches 2-3

- top 2-1

- wireless antenna 2-1

computer feet

- locations 4-7

- spare part number 3-4, 3-13

computer major components, illustrated 3-2

- computer model description 3-1, 4-6
- computer part number 3-1, 4-6
- computer product name 3-1, 4-6
- computer serial number 3-1, 4-6
- Computer Setup
  - boot options 5-5
  - built-in device options 5-6, 5-7
  - device configuration 5-6, 5-7
  - diagnostics menu 5-5
  - file menu 5-3
  - language 5-5
  - menu 5-3
  - navigating 5-2
  - overview 5-1
  - port options 5-8
  - restore security defaults 5-8
  - restoring factory settings 5-3
  - Security menu 5-4
  - selecting 5-2
  - set security level 5-8
  - starting 5-1
  - system configuration menu 5-5
  - using 5-2
- computer warranty period 3-1, 4-6
- connector pinout
  - 1394 port 9-1
  - audio-in jack 9-2
  - audio-out jack 9-2
  - external monitor port 9-3
  - headphone jack 9-2
  - microphone jack 9-2
  - modem jack 9-4
  - monitor port 9-3
  - network jack 9-5
  - RJ-11 jack 9-4
  - RJ-45 jack 9-5
  - USB port 9-6
- connectors, service considerations 4-1
- convertible hinge 2-2
- ctrl+alt+del button 2-11
- D**
- diagnostics menu 5-5
- discs
  - Driver Recovery 8-6
  - Operating System 8-6
- disk sanitizer 5-4
- display assembly
  - removal 4-27
  - spare part numbers 3-3, 3-14, 4-27
- display components
  - illustrated 2-2
  - recycling 11-1
- display inverter, removal 11-3
- display release latch 2-7
- display switch 2-3
- docking connector 2-12
- drive light 2-5
- DriveLock passwords 5-4
- Driver Recovery disc 8-6
- E**
- electrostatic discharge 4-2
- equipment guidelines 4-4
- Esc button 2-11
- esc** key 2-4
- ExpressCard slot
  - enabling/disabling 5-8
  - location 2-9
- ExpressCard slot bezel
  - illustrated 3-9
  - removal 4-31
- external monitor port
  - connector pinout 9-3
  - location 2-11
- external WWAN antenna button 2-7
- F**
- F1 System Information 5-5
- F2 Start-up Test 5-5
- F3 Run-In Test 5-5
- F4 Hard Disk Test 5-5
- fan/heat sink assembly
  - removal 4-34
  - spare part number 3-4, 3-13, 4-34
- feet
  - locations 4-7
  - spare part number 3-4, 3-13
- file menu 5-3
- files and folders
  - backing up 8-1, 8-5
  - recovering 8-1
- fingerprint reader
  - enabling/disabling 5-6, 5-7
  - location 2-2, 2-8
- fingerprint reset on reboot 5-4
- Firmware Progress Event Support 5-8
- Firmware Verbosity 5-8
- flash media reader, enabling/disabling 5-8
- fn** key 2-4, 2-6
- front components 2-7
- function keys 2-4
- G**
- grounding guidelines 4-2
- guidelines
  - equipment 4-4

- grounding 4–2
  - packaging 4–3
  - transporting 4–3
  - workstation 4–4
- H**
- hard drive
    - illustrated 3–8
    - precautions 4–2
    - removal 4–10
    - spare part numbers 3–6, 3–8, 3–12, 3–13, 3–14, 4–10
  - hard drive bay 2–12
  - hard drive bracket, removal 4–11
  - hard drive connector cable
    - disconnection 4–11
    - spare part number 3–6, 3–8, 3–14, 4–10
  - hard drive cover
    - illustrated 3–9
    - removal 4–10
  - headphone jack
    - connector pinout 9–2
    - location 2–8
  - hinge cover
    - illustrated 3–9
    - removal 4–20
  - HP Docking Station
    - spare part number 3–10, 3–11
  - HP Fingerprint Sensor 2–2, 2–8
  - HP SpareKey 5–4
  - HP SpareKey enrollment 5–4
- I**
- illustrated parts catalog 3–1
  - Include TYPE-131 in SMBIOS 5–8
  - info button 2–9, 2–10
- J**
- jacks
    - audio-in 2–8
    - audio-out 2–8
    - headphone 2–8
    - microphone 2–8
    - modem 2–11
    - network 2–11
    - RJ-11 2–11
    - RJ-45 2–11
  - jog dial 2–11
- K**
- key components 2–4
  - keyboard
    - removal 4–17
    - spare part numbers 3–3, 3–13, 4–17
  - keyboard light 2–2
  - keyboard light button 2–2, 2–7
  - keys
    - esc 2–4
    - fn 2–4, 2–6
    - function 2–4
    - numeric keypad 2–4
    - Windows applications 2–4
    - Windows logo 2–4
- L**
- left-side components 2–9, 2–10
  - light components 2–5
  - lights
    - battery 2–5
    - caps lock 2–5
    - drive 2–5
    - keyboard 2–2
    - num lock 2–5
    - power 2–5
    - TouchPad 2–5, 2–6
    - volume down 2–5
    - volume mute 2–5
    - volume up 2–5
    - webcam 2–2
    - wireless 2–9, 2–10
- M**
- memory module
    - removal 4–16
    - spare part numbers 3–6, 3–15, 4–16
  - microphone jack
    - connector pinout 9–2
    - location 2–8
  - microphones 2–2
  - miscellaneous parts, spare part numbers 3–10
  - modem jack
    - connector pinout 9–4
    - location 2–11
  - modem module
    - enabling/disabling 5–6, 5–7
    - removal 4–36
    - spare part numbers 3–4, 3–11, 4–36
  - monitor port
    - connector pinout 9–3
    - location 2–11
- N**
- network jack
    - connector pinout 9–5
    - location 2–11
  - NIC, enabling/disabling 5–6, 5–7
  - num lock light 2–5
  - numeric keypad keys 2–4

**O**

Operating System disc 8–6

**P**

packaging guidelines 4–3  
 parallel port, enabling/disabling 5–8  
 password clearing 4–5  
 password policy 5–4  
 password, changing 5–4  
 pen  
   spare part number 3–10, 3–13  
 pen holder 2–9, 2–10  
 plastic parts, service considerations 4–1  
 Plastics Kit  
   contents 3–9  
   spare part number 3–4, 3–9, 3–14  
 pointing device components 2–6  
 pointing stick 2–6  
 pointing stick button 2–6  
 pointing stick cap  
   spare part number 3–10, 3–11  
 ports  
   1394 2–8  
   external monitor 2–11  
   monitor 2–11  
   USB 2–8, 2–9, 2–10  
 power connector 2–11  
 power cord  
   set requirements 10–1  
   spare part numbers 3–10, 3–12  
 power light 2–5  
 power switch 2–7  
 presentation button 2–3

**R**

rear components 2–11  
 recovering information 8–5  
 recovery tools 8–3  
 recovery, performing 8–2  
 recycling  
   battery 11–1  
   display components 11–1  
 right-side components 2–8  
 RJ-11 jack  
   connector pinout 9–4  
   location 2–11  
 RJ-45 jack  
   connector pinout 9–5  
   location 2–11  
 rotate button 2–11  
 RTC battery  
   removal 4–23  
   spare part number 3–4, 3–11, 4–23

Rubber Kit, spare part number 3–4, 3–13

**S**

Screw Kit  
   contents 3–10  
   spare part number 3–10, 3–13  
 screw listing 7–1  
 SD Card Reader 2–8  
 security cable slot 2–8  
 security level, setting 5–8  
 security menu 5–4  
 serial number 3–1, 4–6  
 serial port, enabling/disabling 5–8  
 service considerations  
   cables 4–1  
   connectors 4–1  
   overview 4–1  
   plastic parts 4–1  
 setup BIOS administrator password 5–4  
 Shield Kit, spare part number 3–4, 3–14  
 Smart card reader 2–10  
 smart card reader  
   spare part number 3–6, 3–13  
 Smart Card slot, enabling/disabling 5–8  
 solid-state drive  
   illustrated 3–8  
   precautions 4–2  
   removal 4–10  
   spare part number 3–6, 3–8, 3–13, 3–14, 4–10  
 speaker  
   location 2–12  
   removal 4–26  
   spare part number 3–4, 3–14, 4–26  
 switch components 2–3  
 system board  
   spare part numbers 3–4, 3–12, 3–14, 3–15  
 system configuration menu 5–5  
 system diagnostics menu 5–5  
 system IDs 5–4  
 system Information 5–3

**T**

Terminal Emulation Mode 5–8  
 tools required 4–1  
 top components 2–1  
 top cover  
   removal 4–21  
   spare part number 3–4, 3–14, 4–21  
 TouchPad 2–6  
 TouchPad button 2–6  
 TouchPad light 2–5, 2–6  
 TouchPad on/off control 2–6  
 TouchPad scroll zone 2–6

TPM embedded security 5-4  
transporting guidelines 4-3

## U

Unconfigure AMT on Next Boot 5-8  
Universal Serial Bus (USB) port  
    connector pinout 9-6  
    enabling/disabling 5-8  
    location 2-8, 2-9, 2-10  
unknown password 4-5  
USB Key Provisioning Support 5-8  
user management 5-4

## V

vent 2-9, 2-10, 2-12  
volume down light 2-5  
volume mute button 2-3  
volume mute light 2-5  
volume scroll zone 2-3  
volume up light 2-5

## W

webcam  
    enabling/disabling 5-6, 5-7  
    location 2-2  
webcam light 2-2  
Windows applications key 2-4  
Windows Backup utility 8-6  
Windows logo key 2-4  
Windows recovery 8-6  
wireless antenna components 2-1  
wireless light 2-9, 2-10  
wireless switch  
    enabling/disabling 5-6, 5-7  
    location 2-9, 2-10  
WLAN antenna 2-1  
WLAN module  
    enabling/disabling 5-6, 5-7  
    removal 4-12  
    spare part numbers 3-5, 3-6, 3-11, 3-12, 3-14,  
    4-12, 4-13  
workstation guidelines 4-4  
WWAN antenna 2-1  
WWAN module  
    enabling/disabling 5-6, 5-7  
    removal 4-15  
    spare part number 3-6, 3-11, 4-15

