



Hardware Reference Guide

HP t510 Thin Client

© Copyright 2012 Hewlett-Packard Development Company, L.P. The information contained herein is subject to change without notice.

Microsoft and Windows are trademarks of Microsoft Corporation in the U.S. and other countries.

The only warranties for HP products and services are set forth in the express warranty statements accompanying such products and services. Nothing herein should be construed as constituting an additional warranty. HP shall not be liable for technical or editorial errors or omissions contained herein.

This document contains proprietary information that is protected by copyright. No part of this document may be photocopied, reproduced, or translated to another language without the prior written consent of Hewlett-Packard Company.

First Edition (March 2012)

Document Part Number: 683995-001

About This Book

 **WARNING!** Text set off in this manner indicates that failure to follow directions could result in bodily harm or loss of life.

 **CAUTION:** Text set off in this manner indicates that failure to follow directions could result in damage to equipment or loss of information.

 **NOTE:** Text set off in this manner provides important supplemental information.

Table of contents

1 Product Features	1
Standard Features	1
Front Panel Components	1
Top Components	2
Rear Panel Components	3
Installing the Antenna (Wireless Models)	4
Installing the Rubber Feet	4
Installing the Stand	5
Removing the Stand	6
Using the Power Cord Retention Slot	6
Using the Keyboard	7
Windows Logo Key	8
Additional Function Keys	8
Special Mouse Functions	8
Serial Number Location	9
2 Hardware Changes	10
General Hardware Installation Sequence	10
Removing and Replacing the Secure USB Compartment Cover	11
Removing the Secure USB Compartment Cover	11
Replacing the Secure USB Compartment Cover	12
Removing and Replacing the Side Access Panel and Metal Side Cover	12
Removing the Side Access Panel and Metal Side Cover	12
Replacing the Metal Side Cover and Side Access Panel	14
Installing Thin Client Options	15
Installing the USB Device	15
Removing and Replacing the Battery	16
Installing a Secondary Flash Memory Module	18
External Drives	19
Appendix A Specifications	20
Appendix B Security Provisions	22
Securing the Thin Client	22

Appendix C Mounting the Thin Client	23
HP Quick Release	23
Supported Mounting Options	25
Non-supported Mounting Option	27
Appendix D Thin Client Operation	28
Routine Thin Client Care	28
Supported Orientations	29
Non-supported Orientation	30
Appendix E Electrostatic Discharge	31
Preventing Electrostatic Damage	31
Grounding Methods	31
Appendix F Shipping Information	32
Shipping Preparation	32
Important Service Repair Information	32
Index	33

1 Product Features

Standard Features

Thank you for purchasing an HP thin client. We hope you have years of use from our thin clients. Our goal is to provide you with award-winning clients that are easy to deploy and manage with the power and reliability you expect.

The next sections describe the features of the thin client. For a complete list of the hardware and software installed on a specific model, visit <http://www.hp.com> and search for your specific thin client model.

The following features are common to all HP thin clients:

- no hard drives or diskette drives
- 5 minutes or less hardware setup time
- central deployment and management using HP Management Solutions

Various options are available for your thin client. For more information about available options, visit the HP Web site at <http://www.hp.com> and search for your specific thin client model.

 **NOTE:** Your computer model may look different than the model in the following illustrations.

Front Panel Components

For more information, <http://www.hp.com> and search for your specific thin client model to find the model-specific QuickSpecs.

Figure 1-1 Front panel components

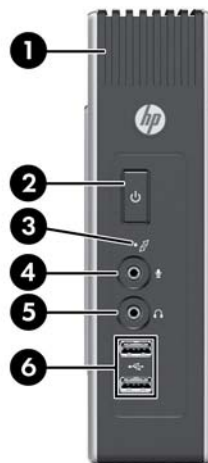

(1) Secure USB compartment

(4) Line-in (microphone) connector

(2)	Power button	(5)	Line-out (headphone) audio connector
(3)	Flash drive activity LED	(6)	Universal serial bus (USB) connectors (2)

Top Components

For more information, <http://www.hp.com> and search for your specific thin client model to find the model-specific QuickSpecs.

The secure USB compartment allows you to use two USB devices in a secured location.

Figure 1-2 Top components, external view

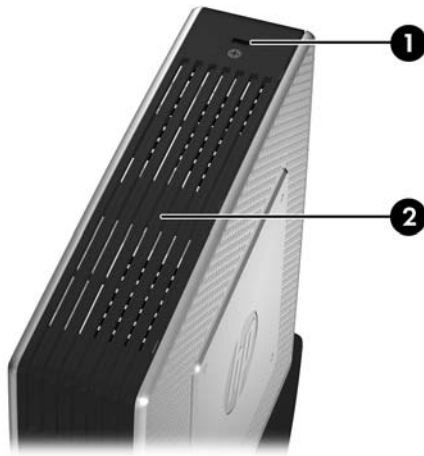

(1)	Cable lock slot
(2)	Secure USB compartment

Figure 1-3 Top components, internal view

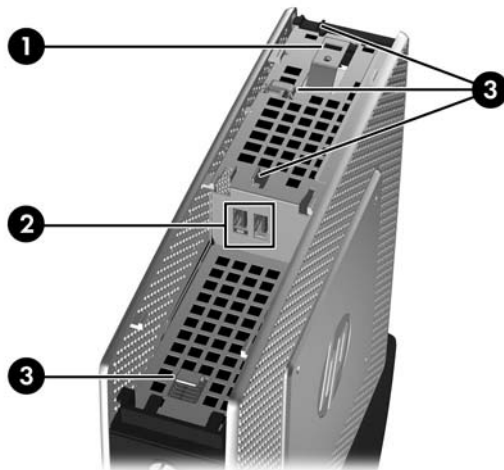

(1)	Cable lock slot
-----	-----------------

(2)	Secure USB compartment ports (2)
(3)	USB cable management features

Rear Panel Components

For more information, <http://www.hp.com> and search for your specific thin client model to find the model-specific QuickSpecs.

Figure 1-4 Rear panel components

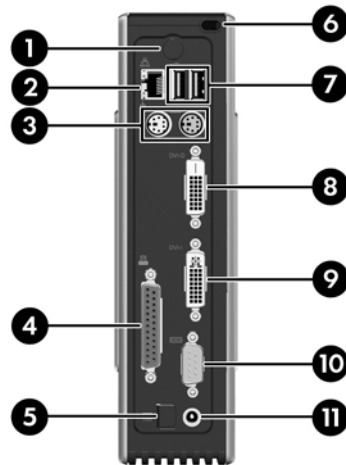

(1)	Wireless antenna*	(7)	Universal serial bus (USB) connectors (2)
(2)	Ethernet RJ-45 connector	(8)	DVI-D connector
(3)	PS/2 connectors (2)	(9)	DVI-I connector
(4)	Parallel connector	(10)	Serial connector
(5)	Power cord retention slot	(11)	Power connector
(6)	Secure USB compartment cable routing slot		

*Available on some models. Refer to the model-specific QuickSpecs at www.hp.com for details.

The wireless antenna allows you to send and receive wireless signals to communicate with wireless local area networks (WLAN).

Installing the Antenna (Wireless Models)

- ▲ Screw the antenna in place on the rear of the thin client.

Figure 1-5 Installing the antenna



CAUTION: To prevent damage to the antenna mounting, do not overtighten the antenna.

Installing the Rubber Feet

You may want to use your thin client in a horizontal orientation. You can install self-adhesive rubber feet at the corners of the left side of the unit. The rubber feet help keep the unit safely in place.

CAUTION: If you use the thin client in a horizontal orientation without the rubber feet, it may slide and result in equipment damage.

To install the rubber feet:

1. Remove the feet from their backing.

2. Align the feet with their holes and press them in securely.

Figure 1-6 Installing the rubber feet

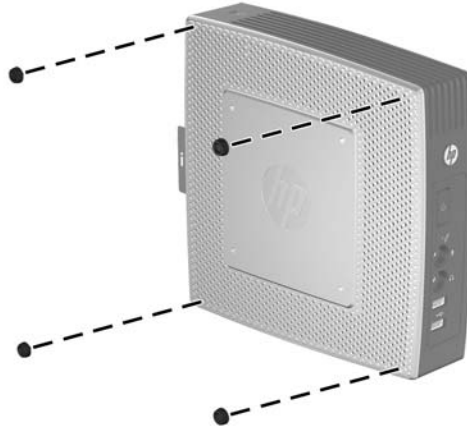

Installing the Stand

If you want to use the thin client in a vertical orientation, you will need to install the stand for stability.

To install the stand:

1. Turn unit upside down.
2. Position the stand with the wide part toward the front of the unit. Align the tabs on the stand with the slots on the bottom of the unit.
3. Insert the tabs into the slots (1) and slide the stand toward the front of the unit until it locks into place (2).

Figure 1-7 Installing the stand

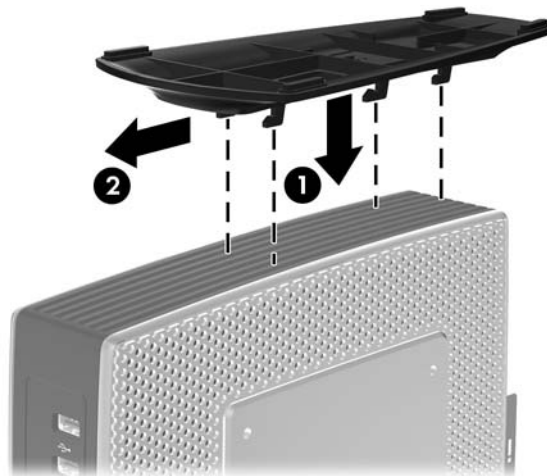

Removing the Stand

To remove the stand:

1. Turn unit upside down.
2. Press down on the tab (1), and then slide the stand toward the rear of the unit and pull it up to remove it from the unit (2).

Figure 1-8 Removing the stand

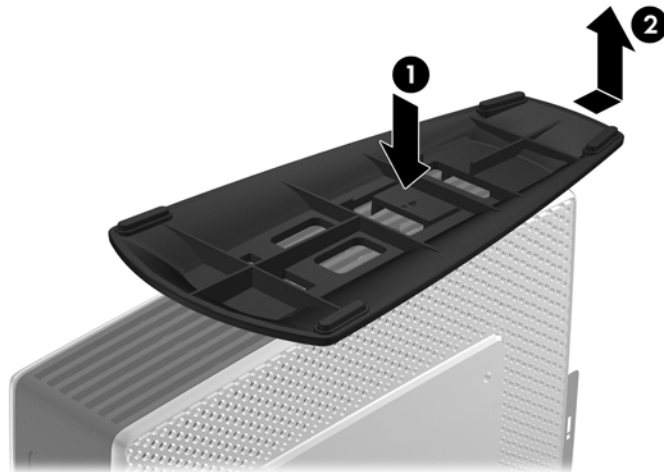

Using the Power Cord Retention Slot

To prevent accidental disconnection, press a loop of the power cord into the power cord retention slot.

Figure 1-9 Power cord retention slot

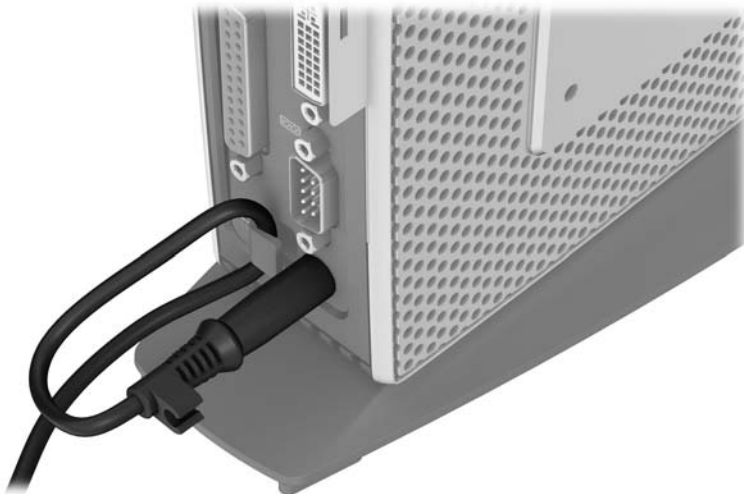

Using the Keyboard

Figure 1-10 Keyboard features

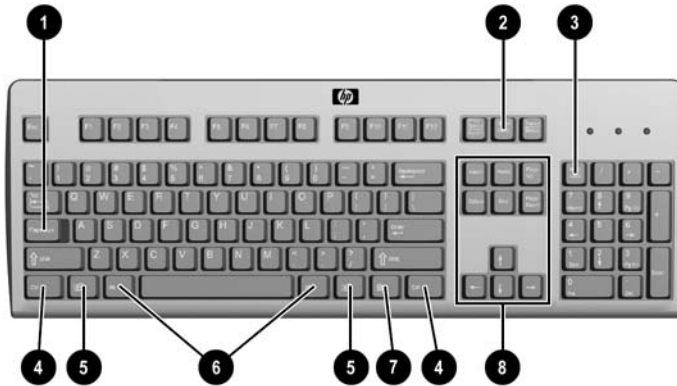

(1)	Caps Lock key	Activates/deactivates the Caps Lock feature.
(2)	Scroll Lock key	Activates/deactivates the Scroll Lock feature.
(3)	Num Lock key	Activates/deactivates the Num Lock feature.
(4)	Ctrl key	Use in combination with another key; its function depends on the application software you are using.
(5)	Windows Logo Key ¹²	Opens the Start menu in Microsoft® Windows®. Use in combination with other keys to perform other functions. For more information, see Windows Logo Key on page 8 .
(6)	Alt key	Use in combination with another key; its function depends on the application software you are using.
(7)	Application key ¹	Similar to the right mouse button, opens pop-up menus in a Microsoft Office application. May perform other functions in other software applications.
(8)	Editing keys	Includes the following: Insert , Home , Page Up , Delete , End , and Page Down . Hold Ctrl and Alt while pressing Delete to restart the thin client.

¹Available in select geographic regions.

²For local sessions, applies only to thin clients running Windows Embedded Standard. For full-screen remote Windows sessions, applies to all thin clients.

Windows Logo Key

Use the Windows Logo Key in combination with other keys to perform certain functions available in Windows operating systems.

Windows Logo Key + Tab	Switch between open items.
Windows Logo Key + e	Open My Computer.
Windows Logo Key + f	Search for a file or folder.
Windows Logo Key + Ctrl + f	Search for computers.
Windows Logo Key + m	Minimize all windows.
Windows Logo Key + Shift + m	Undo minimize all.
Windows Logo Key + Break	Display the System Properties dialog box.
Windows Logo Key + r	Open the Run dialog box.

Additional Function Keys

The following key combinations also work on all thin clients regardless of operating system:

Alt + Esc	Cycles through minimized applications.
Alt + Tab	Cycles through open applications.
Alt + Shift + Tab	Switches to the previous session.

Special Mouse Functions

Most software applications support the use of a mouse. The functions assigned to each mouse button depend on the software applications you are using.

Serial Number Location

Every thin client includes a unique serial number located as shown in the following illustration. Have this number available when contacting HP customer service for assistance.

Figure 1-11 Serial number location





2 Hardware Changes

General Hardware Installation Sequence

To ensure the proper installation thin client hardware components:

1. Back up any data, if necessary.
2. If the thin client is powered on:
 - a. Turn off the computer properly through the operating system, then turn off any external devices.
 - b. Disconnect the power cord from the power outlet and disconnect any external devices.
 - c. Disconnect any external devices or cables, such as an antenna or cable lock.

 **WARNING!** To reduce the risk of personal injury from electrical shock and/or hot surfaces, be sure to disconnect the power cord from the wall outlet and allow the internal system components to cool before touching.

 **WARNING!** To reduce the risk of electrical shock, fire, or damage to the equipment, do not plug telecommunications or telephone connectors into the network interface controller (NIC) receptacles.

 **CAUTION:** Static electricity can damage the electronic components of the thin client or optional equipment. Before beginning these procedures, ensure that you are discharged of static electricity by briefly touching a grounded metal object. See [Electrostatic Discharge on page 31](#) for more information.

-
3. Remove the secure USB compartment cover. See [Removing and Replacing the Secure USB Compartment Cover on page 11](#) for more information.
 4. Remove the stand, if it is installed. See [Removing the Stand on page 6](#) for more information.
 5. Remove the side access panel and metal side cover. See [Removing and Replacing the Side Access Panel and Metal Side Cover on page 12](#) for more information.
 6. Remove any hardware that you will replace.
 7. Install or replace equipment. For removal and replacement procedures, see the following sections:
 - [Installing the USB Device on page 15](#)
 - [Removing and Replacing the Battery on page 16](#)
 - [Installing a Secondary Flash Memory Module on page 18](#)

 **NOTE:** Option kits include more detailed installation instructions.

-
8. Replace the side access panel and metal side cover. See [Removing and Replacing the Side Access Panel and Metal Side Cover on page 12](#).

9. Replace the secure USB compartment cover. See [Removing and Replacing the Secure USB Compartment Cover on page 11](#).
10. Reconnect any external devices and power cords.
11. Turn on the monitor, the thin client, and any devices you want to test.
12. Load any necessary drivers.



NOTE: You can download select hardware drivers from HP. Go to <http://www.hp.com> and search for your specific thin client model.

13. Reconfigure the thin client, if necessary.

Removing and Replacing the Secure USB Compartment Cover

The secure USB compartment allows you to install two USB devices in a secure location inside the thin client. The cable management feature allows you to install a USB mouse and a USB keyboard in this compartment. See [Installing the USB Device on page 15](#) for more information. Along with providing a hidden location, the secure USB compartment can be locked by the optional security cable lock.



CAUTION: The ambient temperature inside of the secure USB compartment can reach up to 55° C (131° F) in worst case conditions. Make sure the specifications for any device you install in the compartment indicate the device can tolerate a 55° C (131° F) ambient environment.



NOTE: In addition to following these instructions, follow the detailed instructions that accompany the accessory you are installing.

Before beginning the installation process, review [General Hardware Installation Sequence on page 10](#) for procedures you should follow before and after installing or replacing hardware.

Removing the Secure USB Compartment Cover

Use the following procedure to remove the secure USB compartment cover.



WARNING! Before removing the secure USB compartment cover, ensure that the thin client is turned off and the power cord is disconnected from the electrical outlet.

To remove the secure USB compartment cover:

1. Toward the rear of the thin client's compartment cover, remove the screw that secures the compartment cover to the unit (1).

2. Push the compartment cover about .6 cm (1/4 inch) toward the front of the unit (2) and lift it off the unit (3).

Figure 2-1 Removing the secure USB compartment cover

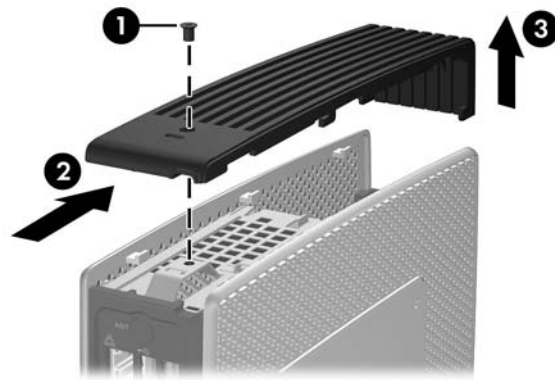

Replacing the Secure USB Compartment Cover

To replace the secure compartment cover:

1. Place the cover on top of the unit so it is offset about 0.6 cm (1/4 inch) toward the front of the unit, allowing the tabs on the cover to align with the slots on the chassis (1).
2. Slide the cover toward the back of the unit until the cover is flush with the chassis (2).
3. Replace the screw (3).

Figure 2-2 Replacing the secure compartment cover

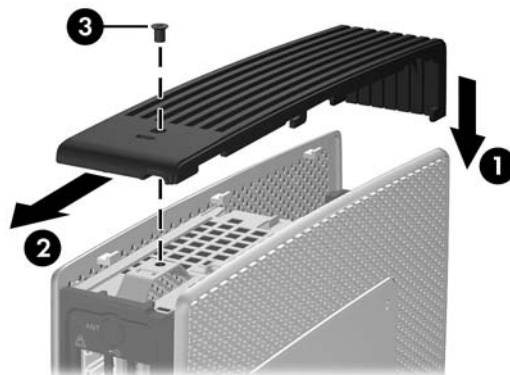

Removing and Replacing the Side Access Panel and Metal Side Cover

Removing the Side Access Panel and Metal Side Cover

WARNING! Before removing the side access panel, ensure that the thin client is turned off and the power cord is disconnected from the electrical outlet.

To remove the access panel:

1. Remove the secure compartment cover (1). For more information, see [Removing the Secure USB Compartment Cover on page 11](#).
2. Remove the stand, if it is installed. See [Removing the Stand on page 6](#) for more information.
3. Lay the unit flat on a stable surface with the right side up and the left side down.
4. Slide the access panel about 3 mm (1/8 inch) toward the top of the unit (2), and then lift the access panel up and off the unit (3).

Figure 2-3 Removing the side access panel

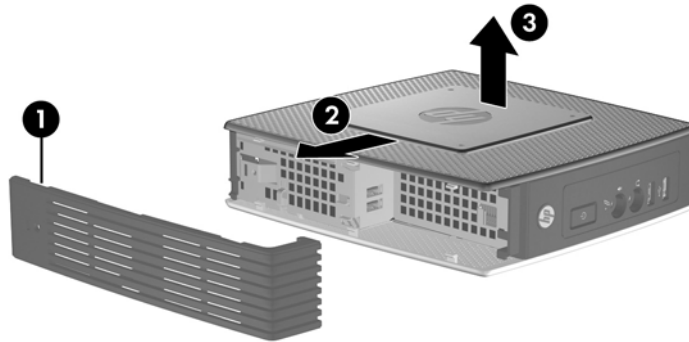

To remove the metal side cover:

 **NOTE:** You must remove the metal side cover to access internal components such as the battery or the memory.

1. Remove the four screws that secure the metal side cover to the chassis (1).
2. Lift the metal side cover, rear side first, off the unit (2).

Figure 2-4 Removing the metal side cover

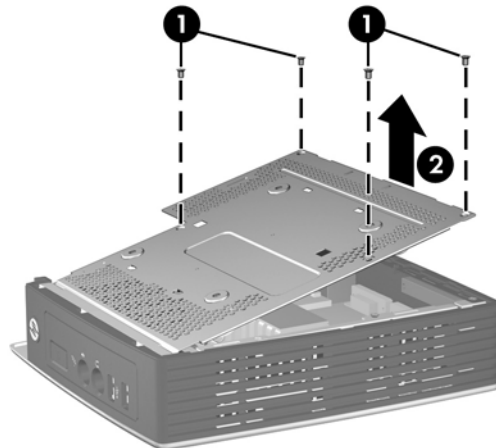

Replacing the Metal Side Cover and Side Access Panel

To replace the metal side cover:

1. Slip the front edge of the metal side cover under the lip on the chassis, lower the front edge, and then press the metal side cover down into place (1).
2. Insert and tighten the four screws (2).

Figure 2-5 Replacing the metal side cover

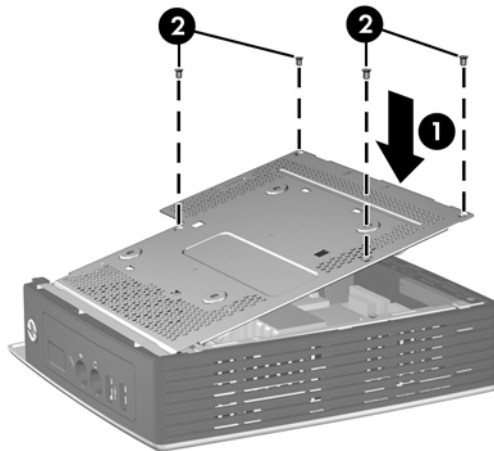

To replace the access panel:

1. Align the tabs on the access panel with the slots in the chassis and place the access panel on the side of the unit, offset about 3 mm (1/8 inch) toward the top of the unit (1).
2. Slide the access panel toward the bottom of the unit until it is flush with the bottom of the chassis (2).

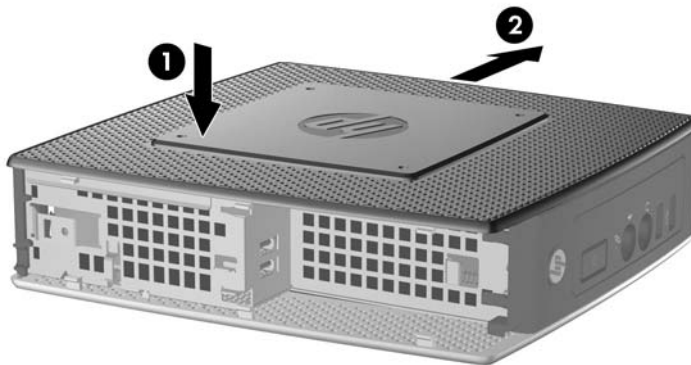

3. Replace the secure compartment cover. For more information, see [Replacing the Secure USB Compartment Cover on page 12](#).

Installing Thin Client Options

Various options can be installed on the thin client:

- [Installing the USB Device on page 15](#)
- [Removing and Replacing the Battery on page 16](#)
- [Installing a Secondary Flash Memory Module on page 18](#)
- [External Drives on page 19](#)

Installing the USB Device

Before beginning the replacement process, review [General Hardware Installation Sequence on page 10](#) for procedures you should follow before and after installing or replacing hardware.

- ▲ Insert the USB device into the USB port in the secure USB compartment. See the following illustration for the location of the ports in the secure USB compartment.

Figure 2-6 USB ports in the secure USB compartment

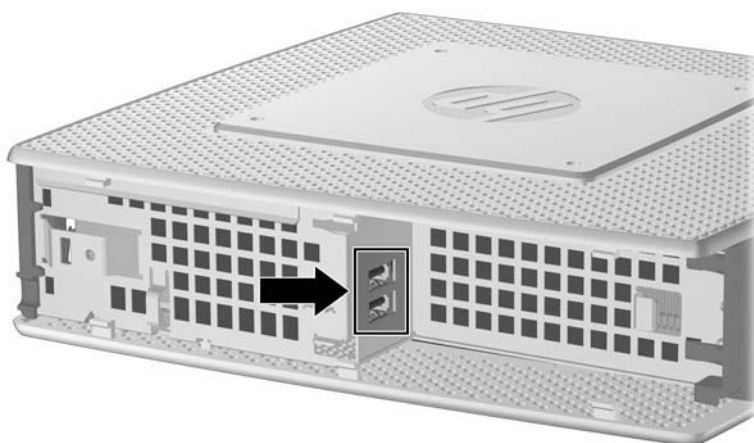

If you install a USB mouse and a USB keyboard in the secure USB compartment, route the cables around and through the clips, then out the secure cable routing slot, as shown in the following illustration.

Figure 2-7 Using the secure cable routing slot

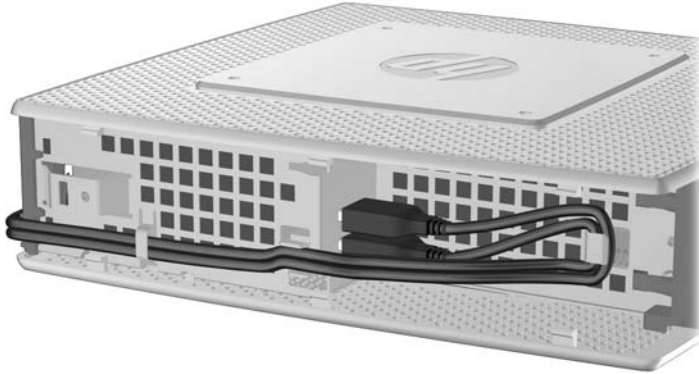

Removing and Replacing the Battery

Before beginning the replacement process, review [General Hardware Installation Sequence on page 10](#) for procedures you should follow before and after installing or replacing hardware.

⚠ WARNING! Before removing the side access panel, ensure that the thin client is turned off and the power cord is disconnected from the electrical outlet.

To remove and replace the battery:

1. Locate the battery on the system board.

2. To release the battery from its holder, gently push the metal guard that extends above one edge of the battery very slightly toward the rear of the unit (1), then lift the battery out (2).

 **NOTE:** Be careful not to bend the metal guard.

Figure 2-8 Removing and replacing the internal battery



3. To insert the new battery, align the replacement battery with the positive side toward the rear of the unit. Slide one edge of the battery into the slot and push down until the guard snaps over the edge of the battery.

HP encourages customers to recycle used electronic hardware, HP original print cartridges, and rechargeable batteries. For more information about recycling programs, go to <http://www.hp.com> and search for “recycle”.

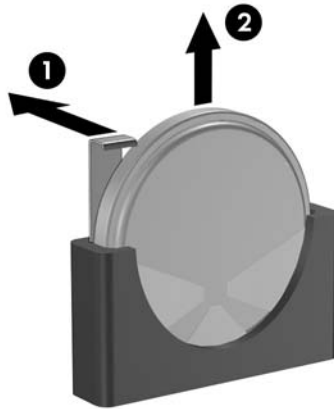

Batteries, battery packs, and accumulators should not be disposed of together with the general household waste. In order to forward them to recycling or proper disposal, please use the public collection system or return them to HP, an authorized HP partner, or their agents.



廢電池請回收

The Taiwan EPA requires dry battery manufacturing or importing firms, in accordance with Article 15 or the Waste Disposal Act, to indicate the recovery marks on the batteries used in sales, giveaways, or promotions. Contact a qualified Taiwanese recycler for proper battery disposal.

Installing a Secondary Flash Memory Module

Before beginning the installation process, review [General Hardware Installation Sequence on page 10](#) for procedures you should follow before and after installing or replacing hardware.

- ⚠ **WARNING!** You must remove the right side panel to access the system board. Before removing the side access panel, ensure that the thin client is turned off and the power cord is disconnected from the electrical outlet.
- ⚠ **CAUTION:** Static electricity can damage the electronic components of the computer or optional cards. Before beginning these procedures, ensure that you are discharged of static electricity by briefly touching a grounded metal object. When handling a memory module, be careful not to touch any of the contacts. Doing so may damage the module.

To install the secondary flash memory module:

1. Locate the secondary flash memory module socket on the system board.

Figure 2-9 Installing the Secondary Flash Memory Module

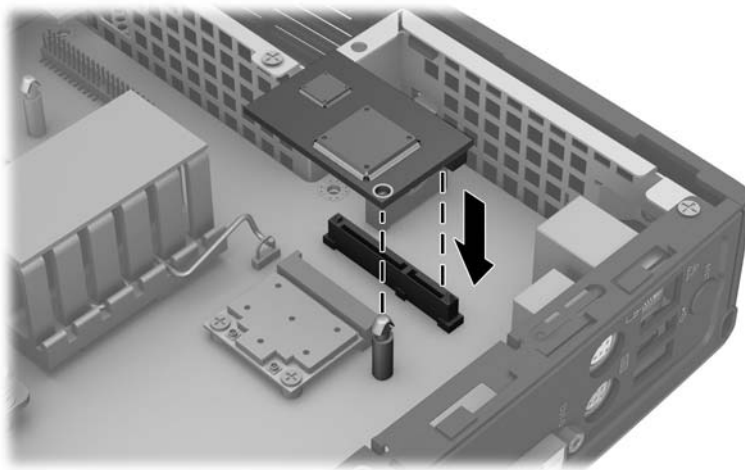

2. Insert the flash memory module into the socket on the system board.

📝 **NOTE:** A flash memory module can be installed in only one way. Line up the hole in the flash memory module with the retention post on the system board.

3. Press the module connectors firmly into the flash memory module socket, making sure that the retention post on the system board comes up through the hole in the module.

External Drives

Various external USB drives are available as options for these thin clients. For more information about these drives, visit <http://www.hp.com> and search for your specific thin client model, or refer to the instructions that accompany the option.

For more information about available options, visit the HP Web site <http://www.hp.com> and search for your specific thin client model.

A Specifications

Table A-1 HP t510 Thin Client

Dimensions		
Width	58.42 mm	2.30 in.
Height (without stand)	209.55 mm	8.25 in
Height (with stand)	219.70 mm	8.65 in
Depth	215.90 mm	8.50 in.
Approximate Weight		
	1.36 kg	3.00 lb
Temperature Range (fanless design)*		
Operating**	10° to 40° C	50° to 104° F
(max. rate of change is 10° C per hour or 18° F per hour)		
Nonoperating	-30° to 60° C	-22° to 140° F
(max. rate of change is 20° C per hour or 36° F per hour)		
*Specifications are at sea level with altitude derating of 1° C/300m (1.8° F/1000ft) to a maximum of 3Km (10,000ft), with no direct, sustained sunlight. Upper limit may be limited by the type and number of options installed.		** The operating temperature range when the thin client is attached to a flat panel using the HP Quick Release is 50° to 95° F (10° to 35° C).
Relative Humidity (non-condensing)		
Operating	10–90%	10–90%
(max. wet bulb temperature is 28° C or 84.2° F)		
Nonoperating	5–95%	5–95%
(max. wet bulb temperature is 38.7° C or 101.6° F)		
Maximum Altitude (unpressurized)		
Operating	3048 m	10,000 ft
(max. allowed rate of change is 457m per minute or 1500 ft per minute)		
Nonoperating	9144 m	30,000 ft
(max. allowed rate of change is 457m per minute or 1500 ft per minute)		
Power Supply		
Operating Voltage Range	100–240 VAC	100–240 VAC
Rated Line Frequency	50–60 Hz	50–60 Hz
Power Output (maximum)		
	65 W	65 W

Table A-1 HP t510 Thin Client (continued)

Rated Output Current (maximum)	3.42 A	3.42 A
Output Voltage	+19 V DC	+19 V DC

B Security Provisions

Securing the Thin Client

These thin clients are designed to accept a security cable lock. This cable lock prevents unauthorized removal of the thin client, as well as locking the secure compartment. To order this option, visit the HP Web site at <http://www.hp.com> and search for your specific thin client model.

1. Locate the cable lock slot on the back panel.
2. Insert the cable lock into the slot, and then use the key to lock it.

Figure B-1 Securing the thin client

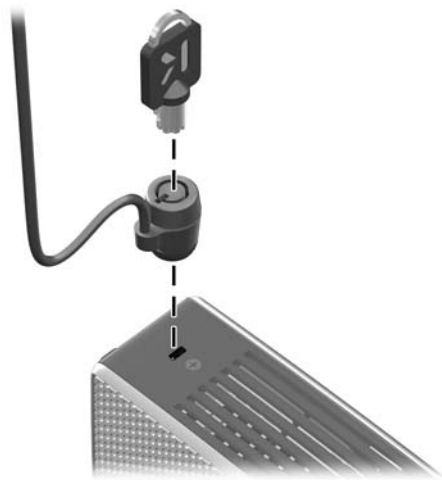

You may also secure your USB mouse and keyboard or other USB devices by installing them in the secure USB compartment. See [Installing the USB Device on page 15](#)

C Mounting the Thin Client

HP Quick Release

This thin client incorporates four mounting points on each side of the unit. These mounting points follow the VESA (Video Electronics Standards Association) standard, which provides industry-standard mounting interfaces for Flat Displays (FDs), such as flat panel monitors, flat displays, and flat TVs. The HP Quick Release connects to the VESA-standard mounting points, allowing you to mount the thin client in a variety of orientations.

 **NOTE:** When mounting to a thin client, use the 15 mm screws supplied with the HP Quick Release.

Figure C-1 HP Quick Release



To use the HP Quick Release:

1. Using four 15 mm screws included in the mounting device kit, attach one side of the HP Quick Release to the thin client as shown in the following illustration.

Figure C-2 Connecting the HP Quick Release to the thin client

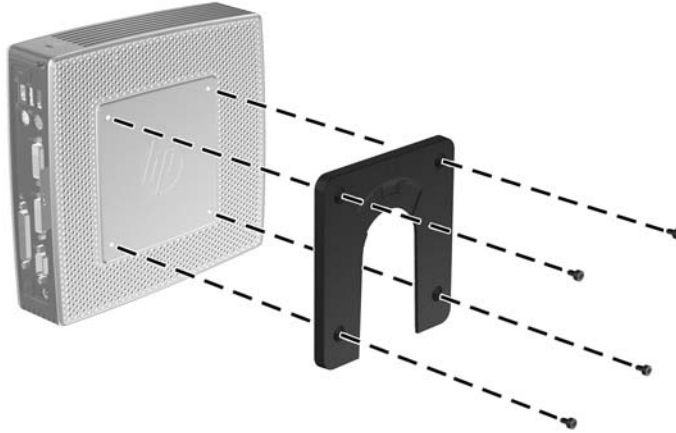

2. Using four screws included in the mounting device kit, attach the other side of the HP Quick Release to the device to which you will mount the thin client. Make sure the release lever points upward.

Figure C-3 Connecting the HP Quick Release to another device

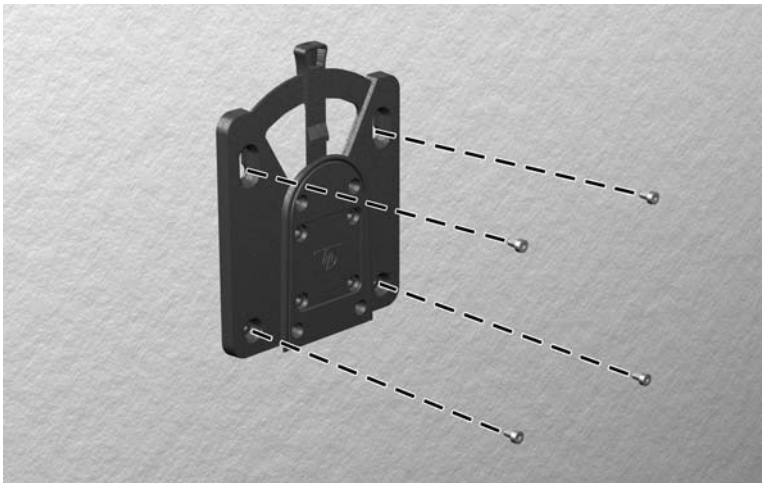

3. Slide the side of the mounting device attached to the thin client (1) over the other side of the mounting device (2) on the device on which you want to mount the thin client. An audible 'click' indicates a secure connection.

Figure C-4 Connecting the thin client

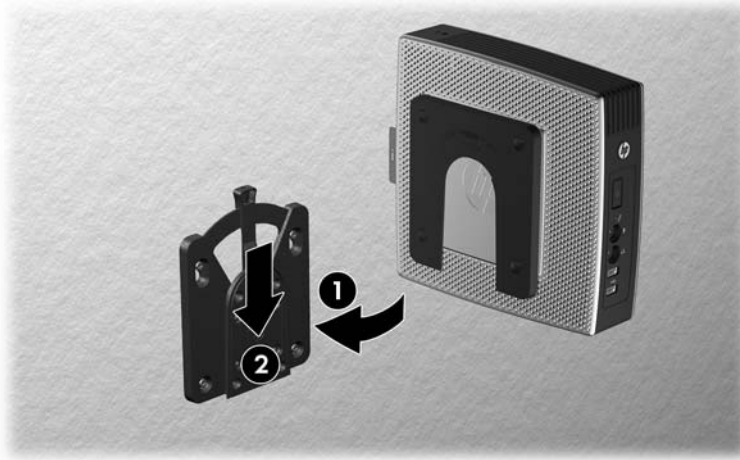

 **NOTE:** When attached, the HP Quick Release automatically locks in position. You only need to slide the lever to one side to remove the thin client.

 **CAUTION:** To ensure proper function of the HP Quick Release and a secure connection of all components, make sure both the release lever on one side of the mounting device and the rounded opening on the other side face upward.

Supported Mounting Options

The following illustrations demonstrate some of the supported and not supported mounting options for the mounting bracket.

Figure C-5 Thin client mounted with flat panel on wall



Figure C-6 Thin client mounted on back of monitor stand



Figure C-7 Thin client mounted on wall



Figure C-8 Thin client mounted under desk



Non-supported Mounting Option

CAUTION: Mounting a thin client in a non-supported manner could result in failure of the HP Quick Release and damage to the thin client and/or other equipment.

Do not mount the thin client on a flat panel monitor stand, between the panel and the stand.

Figure C-9 Unsupported mounting position—thin client between stand and monitor



D Thin Client Operation

Routine Thin Client Care

Use the following information to properly care for your thin client:

- Never operate the thin client with the outside panel removed.
- Keep the thin client away from excessive moisture, direct sunlight, and extreme heat and cold. For information about the recommended temperature and humidity ranges for the thin client, see [Specifications on page 20](#).
- Keep liquids away from the thin client and keyboard.
- Turn off the thin client and wipe the exterior with a soft, damp cloth as needed. Using cleaning products may discolor or damage the finish.

Supported Orientations

HP supports the following orientations for the thin client.

⚠ CAUTION: You must adhere to HP-supported orientations to ensure your thin clients function properly.

Figure D-1 Vertical orientation using the supplied stand



Figure D-2 Horizontal orientation on rubber feet



Figure D-3 Under monitor stand with at least one inch clearance



Non-supported Orientation

HP does not support the following orientation for the thin client.

CAUTION: Non-supported placement of thin clients could result in operation failure and/or damage to the devices.

CAUTION: Thin clients require proper ventilation to maintain operating temperature. Do not block the vents.

Do not put thin clients in drawers or other sealed enclosures. Do not place a monitor or other object on top of the thin client. Thin clients require proper ventilation to maintain operating temperatures.

Figure D-4 Do not put thin clients in drawers or other sealed enclosures



Figure D-5 Do not place a monitor on the thin client



E Electrostatic Discharge

A discharge of static electricity from a finger or other conductor may damage system boards or other static-sensitive devices. This type of damage may reduce the life expectancy of the device.

Preventing Electrostatic Damage

To prevent electrostatic damage, observe the following precautions:

- Avoid hand contact by transporting and storing products in static-safe containers.
- Keep electrostatic-sensitive parts in their containers until they arrive at static-free workstations.
- Place parts on a grounded surface before removing them from their containers.
- Avoid touching pins, leads, or circuitry.
- Always be properly grounded when touching a static-sensitive component or assembly.

Grounding Methods

There are several methods for grounding. Use one or more of the following methods when handling or installing electrostatic-sensitive parts:

- Use a wrist strap connected by a ground cord to a grounded Thin Client chassis. Wrist straps are flexible straps of 1 megohm +/- 10 percent resistance in the ground cords. To provide proper grounding, wear the strap snug against the skin.
- Use heelstraps, toestraps, or bootstraps at standing workstations. Wear the straps on both feet when standing on conductive floors or dissipating floor mats.
- Use conductive field service tools.
- Use a portable field service kit with a folding static-dissipating work mat.

If you do not have any of the suggested equipment for proper grounding, contact an HP authorized dealer, reseller, or service provider.

 **NOTE:** For more information about static electricity, contact an HP authorized dealer, reseller, or service provider.

F Shipping Information

Shipping Preparation

Follow these suggestions when preparing to ship the thin client:

1. Turn off the thin client and external devices.
2. Disconnect the power cord from the electrical outlet, then from the thin client.
3. Disconnect the system components and external devices from their power sources, then from the thin client.
4. Pack the system components and external devices in their original packing boxes or similar packaging with sufficient packing material to protect them.



NOTE: For environmental nonoperating ranges, see [Specifications on page 20](#)

Important Service Repair Information

In all cases, remove and safeguard all external options before returning the thin client to HP for repair or exchange.

In countries that support customer mail-in repair by returning the same unit to the customer, HP makes every effort to return the repaired unit with the same internal memory and flash modules that were sent.

In countries that do not support customer mail-in repair by returning the same unit to the customer, all internal options should be removed and safeguarded in addition to the external options. The thin client should be restored to the **original configuration** before returning it to HP for repair.

Index

A

- access panel
 - removing 12
 - replacing 14
- altitude specifications 20
- antenna
 - installing 4

B

- battery, replacing 16

C

- cable lock slot location 2
- cable lock, installing 22
- cable routing slot 3
- cautions
 - ambient temperature 11
 - antenna mounting 4
 - HP Quick Release 25
 - mounting thin client 27
 - static electricity 10
 - thin client orientation 29, 30
 - ventilation 30
- components
 - front panel 1
 - keyboard 7
 - mouse 8
 - rear panel 3
 - top 2

D

- dimensions 20
- diskette drive 19
- download hardware drivers 11
- DVI connector locations 3

E

- electrostatic discharge 31
- Ethernet connector location 3

F

- feet, installing 4
- Flash activity LED location 1
- flash memory module, installing 18

- front panel components 1
- function keys 8

G

- grounding methods 31

H

- hard drive 19
- hardware drivers 11
- hardware specifications 20
- hardware, upgrades 10
- headphone connector location 1
- horizontal orientation 4, 29
- HP Quick Release 23
- humidity specifications 20

I

- installation sequence 10
- installing
 - antenna 4
 - cable lock 22
 - external drives 19
 - flash memory module 18
 - hardware 10
 - HP Quick Release 23
 - MultiBay diskette drive 19
 - rubber feet 4
 - SATA flash memory module 18
 - stand 5
 - thin client onto HP Quick Release 23
 - USB devices 1, 11, 15

K

- keyboard
 - function keys 8
 - layout 7
 - Windows logo key 8

L

- line-out audio location 3
- lock, cable, slot location 2

M

- memory module, installing 18
- metal side cover
 - removing 12
 - replacing 14
- microphone connector location 1
- mounting options
 - on back of monitor stand 25
 - on wall 25
 - under desk 25
 - with flat panel on wall 25
- mounting thin client 23
- mouse functions 8

N

- non-supported orientations
 - in a drawer 30
 - under a monitor 30

O

- options 1, 22
 - installing 10
 - supported 10
 - USB device 15
- orientation
 - horizontal 4
 - vertical 5

P

- parallel connector 3
- power button location 1
- power connector location 3
- power cord retention slot 6
- power LED location 1
- power output specifications 20
- power supply specifications 20
- preventing electrostatic damage 31
- PS/2 connectors location 3

Q

- Quick Release 23

R

- rated output current 21

- rear panel components 3
- recycling 17
- relative humidity specifications 20
- removing
 - battery 16
 - metal side cover 12
 - secure USB compartment cover 11
 - side access panel 12
 - stand 6
- replacing
 - battery 16
 - metal side cover 14
 - secure USB compartment cover 12
 - side access panel 14
- retention slot, power cord 6
- RJ-45 connector location 3
- routine care 28
- rubber feet, installing 4

S

- SATA flash memory module, installing 18
- secure cable routing slot 3
- secure USB compartment 22
 - location 1, 2
 - ports 2
 - removing cover 11
 - replacing cover 12
- security 22
 - cable routing slot 15
 - USB devices 15
- serial connector location 3
- serial number location 9
- service repair 32
- shipping preparation 32
- shutting down 10
- side access panel
 - removing 12
 - replacing 14
- side cover
 - removing 12
 - replacing 14
- specifications
 - altitude 20
 - dimensions 20
 - hardware 20
 - humidity 20
 - power output 20

- power supply 20
 - rated output current 21
 - relative humidity 20
 - temperature 20
- thin client 20
- weight 20
- stand
 - installing 5
 - removing 6
- supported mounting options 25
- supported orientations 29
 - horizontal 29
 - under monitor stand 29
 - vertical 29

T

- temperature specifications 20
- top components 2

U

- unsupported mounting option 27
- USB compartment
 - security 22
- USB devices, installing 1, 11, 15
- USB drive options 19
- USB ports
 - location 1, 3
 - secure 2

V

- vertical orientation 5, 29
- VGA connector location 3

W

- warnings
 - electric shock 10, 11, 12, 16, 18
 - fire 10
- Web sites
 - HP 1
 - options 1
- weight 20
- Windows Logo Key 7
- Windows logo key 8
- wireless antenna
 - installing 4