LSI SAS RAID Host Bus Adapter installation

Introduction

This document describes how to install an LSI 9212–4i Serial Attached SCSI (SAS) Redundant Array of Independent Disks (RAID) Host Bus Adapter (HBA) in HP Z series Workstations. Procedures are included for drives mounted in internal hard drive bays and external drive bays.

Kit contents

- LSI SAS 9212–4i RAID HBA (RAID controller card)
- SAS driver CD
- 4x SATA cable extender (for HP Z620 Workstation only)
- Hard drive activity LED cable
- Warranty information
- Installation instructions (this document)

Before you begin



To view *QuickSpecs* and determine the compatibility of this product with your HP workstation, see <http://www.hp.com/go/productbulletin>.





405023-007

© 2012 Hewlett-Packard Development Company, L.P. Printed in the USA

Warnings and cautions



 **WARNING!**  Any surface or area of the equipment marked with this symbol indicates the presence of a hot surface or hot component. If this surface is contacted, the potential for injury exists. To reduce the risk of injury from a hot component, enable the surface to cool before touching.

 **WARNING!**  Any surface or area of the equipment marked with this symbol indicates the presence of an electrical shock hazard. To reduce the risk of injury from electrical shock, do not open any enclosed area marked with this symbol.

 **WARNING!** To reduce the risk of electric shock or damage to your equipment:

- Do not disable the power cord grounding plug. The grounding plug is an important safety feature.
- Plug the power cord in a grounded (earthed) outlet that is easily accessible at all times.
- Disconnect power from the equipment by unplugging the power cord from the electrical outlet.

 **WARNING!** To reduce the risk of serious injury, read the *Safety & Comfort Guide*. It describes proper computer setup, posture, health, and work habits for computer users, and provides important electrical and mechanical safety information. This guide is located at <http://www.hp.com/ergo> and on the documentation CD (if one is included with the product).

 **WARNING!** If a product is shipped in packaging marked with this symbol, , the product must always be lifted by two persons to avoid personal injury due to product weight.

 **CAUTION:** Static electricity can damage the electronic components of the computer. Before beginning these procedures, be sure you discharge static electricity by briefly touching a grounded metal object.

 **CAUTION:** To prevent damage to the computer, observe the following Electrostatic Discharge (ESD) precautions while performing the system parts removal and replacement procedures:

- Work on a static-free mat.
- Wear a static strap to ensure that any accumulated electrostatic charge is discharged from your body to the ground.
- Create a common ground for the equipment you are working on by connecting the static-free mat, static strap, and peripheral units to that piece of equipment.

 **NOTE:** HP accessories are for use in HP computer products. They have been extensively tested for reliability and are manufactured to high quality standards.

Step 1—Preparing for component installation

 **NOTE:** Computer models vary. All illustrations are examples only.

Download and install updates

1. Check for available system BIOS updates specified for your HP computer model and operating system at <http://www.hp.com/support>.
2. Install the system BIOS updates, if available.

Accessing the internal components of the computer

1. If you need help preparing the computer for this installation, refer to the
 - Removal and replacement procedures in the Maintenance and Service Guide for your computer at <http://www.hp.com/support/computer-manuals>, or
 - Removal and Replacement videos for your computer at <http://www.hp.com/go/sml>.
2. Power down the computer, and then disconnect the power cord.
3. Power down all external devices, and then disconnect them from the computer.
4. Remove the side access panel.

Step 2—Installing the RAID controller card

1. If present, remove the card support to enable access to the expansion slots and system board connectors.
2. Select an unused PCI Express (PCIe) x4, x8, or x16 expansion slot on the system board. The 9212-4i RAID controller card must be installed in a higher performance slot.

 **NOTE:** To identify an available PCIe expansion slot, see the service label on the side access panel.

3. Install the RAID controller card into the selected slot on the system board. Verify that the keyed components of the card align with the slot.

Figure 1 Placing the RAID controller card in the expansion slot

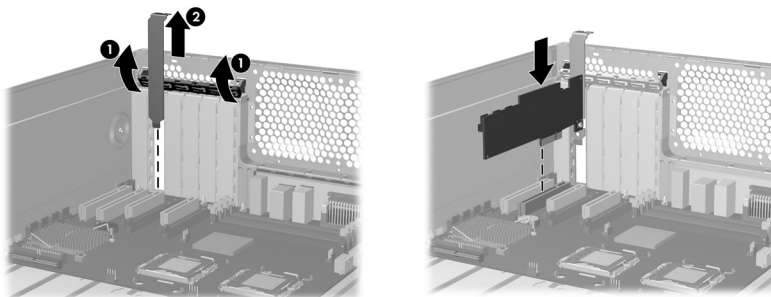

Step 3—Configuring the cabling

The RAID controller card may be used to control hard drives located in the internal and external drive bays.

The data cable connections for RAID controller cards differ between workstation models. To determine the correct connection for your hard drives, identify the applicable HP workstation model and the location of the hard drive being connected in the following table. To connect existing hard drives, disconnect the existing data cables from the system board and choose the correct connection type.

The hard drive LED cable connection is similar for most HP workstation models.

Table 1 Data cable configuration guide

HP workstation model	Location of hard drive	Connection type	Description
HP Z400 and Z420 Workstations	<ul style="list-style-type: none"> Internal hard drive bay External drive bay 	Connecting standard data cables on page 7	Use the data cable provided with the hard drive to connect the hard drive to the RAID controller card. For SAS drives, refer to specific instructions on data cabling and adapter types in Connecting standard data cables on page 7 .
HP Z600 and Z620* Workstations	<ul style="list-style-type: none"> Internal hard drive bay 	Connecting pre-installed data cables on page 5	The pre-installed data cables from the internal hard drives are disconnected from the system board and connected to the appropriate port connectors on the RAID controller card in Connecting pre-installed data cables on page 5 .
HP Z600 and Z620* Workstations	<ul style="list-style-type: none"> External drive bay 	Connecting standard data cables on page 7	Use the data cable provided with the hard drive to connect the hard drive to the RAID controller card. For SAS drives, refer to specific instructions on data cabling and adapter types in Connecting standard data cables on page 7 .
IMPORTANT: * The HP Z620 Workstation requires use of the provided 4x SATA cable to extend the data cable length. Attach the 4x SATA cable extender to the RAID controller card, then connect the internal hard drive bay data cables or the external drive bay cable to the appropriate port on the other end of the 4x SATA cable.			

Connecting pre-installed data cables

HP Z600 and HP Z620 Workstations have internal hard drive bay data cables pre-installed on the system board. For workstations with this cabling configuration, use the following procedure to connect internal hard drives to the RAID controller card.

1. Locate and disconnect the hard drive cables from the system board.

Figure 2 Reconnecting the data cables to the RAID controller card (1 of 2)

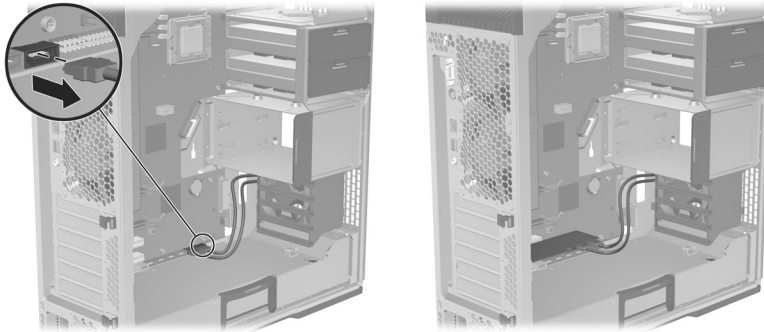
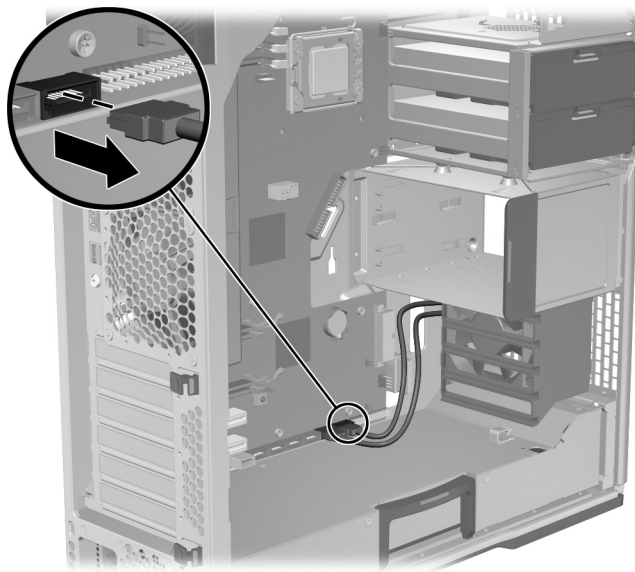
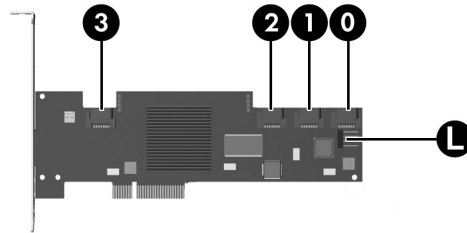

Figure 2 Reconnecting the data cables to the RAID controller card (2 of 2)



2. Connect the data cables to the corresponding ports on the RAID controller card, as shown in [Figure 3 SAS/SATA data ports and hard drive LED connector on page 6](#). For the HP Z620 Workstation, refer to Table 1* instructions on the required use of the 4x SATA cable extender to lengthen the data cabling.

Figure 3 SAS/SATA data ports and hard drive LED connector



3. Continue with [Connecting the hard drive LED activity indicator on page 9](#).

Figure 4 RAID controller card and 4x SATA cable extender

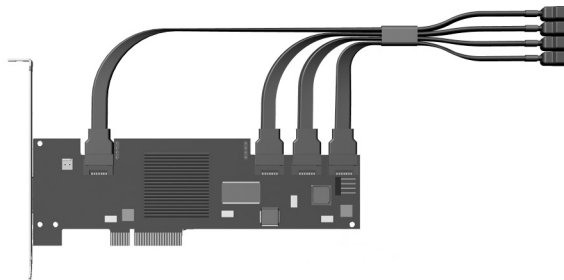

Connecting standard data cables

External hard drives installed in HP Z400 and HP Z420 Workstations do not have cabling preinstalled on the system board. To connect the RAID controller card cabling for these configurations:

1. If connecting a SAS hard drive, ensure that there is a SAS-to-SATA adapter or SAS-to-SATA cable (included with the HP workstation SAS hard drive kit) attached to the data connector on the SAS hard drive. [Figure 5 Attaching the SAS-to-SATA adapter or SAS-to-SATA cable on page 7](#) shows examples of adapter types A and B.

Figure 5 Attaching the SAS-to-SATA adapter or SAS-to-SATA cable

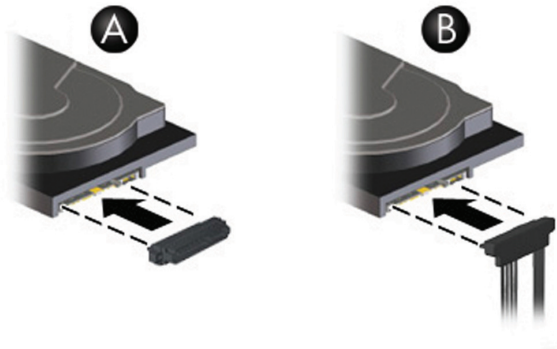

2. For adapter types A and B, select the required data cable for the workstation from those shipped with the hard drive.

Table 2 SAS-to-SATA adapter and data cable options

Adapter type	Workstation	Hard drive bay use	Cabling with adapter installed
A	HP Z400 HP Z420 HP Z600 HP Z620* HP Z800 HP Z820	External drive bays	Use straight connector to straight connector data cable. Plug the end of the data cable into port 0 of the RAID controller card; and plug in opposite end of the data cable into the adapter.
B	HP Z400 HP Z420	Internal hard drive bays	Plug in portion (2) of the SAS-to-SATA cable into the hard drive; plug in portion (1) of the SAS-to-SATA cable into port 0 on the RAID controller card; plug in portion (3) of the SAS-to-SATA cable into SATA power source from the power supply, as shown in Figure 6 Attaching the data cable on page 8 .

IMPORTANT: * For the HP Z620 Workstation: refer to [Table 1 Data cable configuration guide on page 4](#) instructions on the required use of the 4x SATA cable to extend the data cabling length.

Figure 6 Attaching the data cable

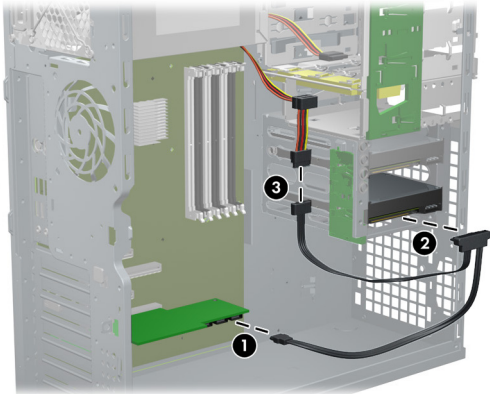

- 3.** Attach any subsequent hard drives to ports 1 through 3 on the RAID controller card as shown in [Figure 3 SAS/SATA data ports and hard drive LED connector on page 6](#).
- 4.** Continue with [Connecting the hard drive LED activity indicator on page 9](#).

Connecting the hard drive LED activity indicator

This section applies to all HP workstations previously listed.

Attach one end of the hard drive LED cable to the RAID controller card LED port (L) as shown in [Figure 7 RAID controller card with hard drive LED connector on page 9](#). The LSI SAS 9212-4i hard drive LED cable is a 4-to-2 pin connector style. The RAID controller card connection is illustrated in [Figure 7 RAID controller card with hard drive LED connector on page 9](#).

Figure 7 RAID controller card with hard drive LED connector

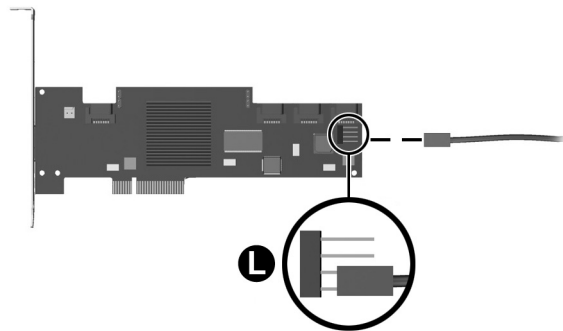

Attach the other end of the hard drive-LED cable to the hard drive LED activity connector on the system board, as shown in [Figure 8 Attaching the hard drive LED cable on page 9](#). (An HP Z600 series Workstation system board is shown for reference in [Figure 8 Attaching the hard drive LED cable on page 9](#).)

 **NOTE:** To locate the hard drive LED activity connector on the system board, see the service label inside the workstation side access panel. Use the hard drive LED cable appropriate for the workstation.

Figure 8 Attaching the hard drive LED cable



Step 4—Reassembling the workstation

1. Reinstall the card support, if applicable.
2. Reinstall the side access panel.
3. Reconnect power to the workstation and all external devices.
4. Restore power to the workstation and all external devices.

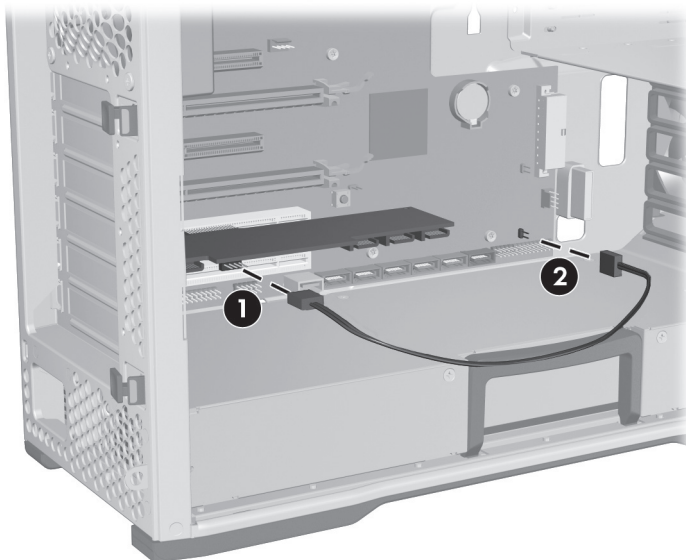
Step 5—Loading and setting up driver software

For instructions on loading and setting up the drivers for use with your workstation, see the manufacturer's documentation shipped with the RAID controller card.

At the time of component installation, look for device firmware and driver updates, designated for your workstation model and operating system. Obtain updates from <http://www.hp.com/go/workstationsupport>.

Step 6—Configuring RAID devices

For detailed instruction on configuring RAID devices, see the service guide for your HP workstation model at http://www.hp.com/support/workstation_manuals.

Additional information is available at http://www.hp.com/support/RAID_FAQs.

Japanese 日本語

This document is available in Japanese. See http://www.hp.com/support/workstation_manuals, then select your workstation product and select **Japanese** from the drop down **Manual Language** menu.

このドキュメントは日本語版が用意されています。http://www.hp.com/support/workstation_manuals にアクセスし、ご使用のワークステーション製品を選択し、**Manual Language** ドロップダウンメニューから **Japanese** を選択してください。