



HP Photosmart 5520 series

Contents

1	HP Photosmart 5520 series Help	3
2	Get to know the HP Photosmart	
	Printer parts	5
	Control panel features	6
	Status lights and buttons	6
3	How do I?	9
4	Print	
	Print photos from a memory card	11
	Print Quick Forms	12
	Wireless Direct print	12
	Select print media	12
	Load media	12
	Recommended papers for photo printing	15
	Recommended papers for printing and copying	16
	Tips for print success	16
5	Use Web Services	
	Print from anywhere	19
	Use HP Print Apps	20
	Use the HP ePrintCenter website	20
	Tips for using Web Services	20
6	Copy and scan	
	Copy text or mixed documents	21
	Scan to a computer or memory card	23
	Tips for copy and scan success	24
7	Work with cartridges	
	Check the estimated ink levels	25
	Clean printhead automatically	25
	Clean ink smear	25
	Replace the cartridges	26
	Align printer	27
	Order ink supplies	28
	Cartridge warranty information	28
	Tips for working with cartridges	29
8	Connectivity	
	Add the HP Photosmart to a network	31
	Connect wirelessly to the printer without a router	32
	Change from a USB connection to a wireless network	33
	Connect a new printer	34
	Change network settings	34
	Tips for setting up and using a networked printer	34
	Advanced printer management tools (for networked printers)	35
9	Solve a problem	
	Get more help	37
	Register your printer	37
	Clear paper jam	37
	Solve print problem	40
	Solve copy and scan problem	40
	Solve networking problem	40

HP support by phone.....	41
10 Technical information	
Notice.....	47
Cartridge chip information.....	47
Specifications.....	48
Environmental product stewardship program.....	49
Regulatory notices.....	54
Regulatory wireless statements.....	57
Index.....	59

1 HP Photosmart 5520 series Help

For information about HP Photosmart 5520 series, see:

- [Get to know the HP Photosmart on page 5](#)
- [How do I? on page 9](#)
- [Print on page 11](#)
- [Use Web Services on page 19](#)
- [Copy and scan on page 21](#)
- [Work with cartridges on page 25](#)
- [Connectivity on page 31](#)
- [Technical information on page 47](#)
- [Solve a problem on page 37](#)

2 Get to know the HP Photosmart

- [Printer parts](#)
- [Control panel features](#)
- [Status lights and buttons](#)

Printer parts

- Front and top views of HP Photosmart 5520 series

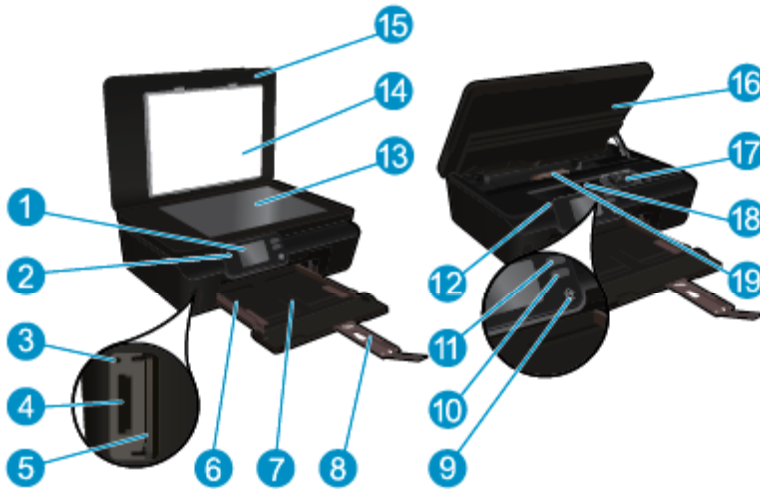

1	Color graphics display (also referred to as the display)
2	Control panel
3	Memory card light
4	Memory card slot
5	Memory card door
6	Paper-width guide
7	Paper tray
8	Paper tray extender (also referred to as the tray extender)
9	On button
10	ePrint status light and button
11	Wireless status light and button
12	Model number location
13	Glass
14	Lid-backing
15	Lid
16	Cartridge access door
17	Printhead assembly
18	Cartridge access area
19	Paper path cover

- Rear view of HP Photosmart 5520 series



20	Rear USB port
21	Power connection. Use only the power cord supplied by HP.

Control panel features

Touch the directional buttons to navigate between two Home screens.

Control panel features

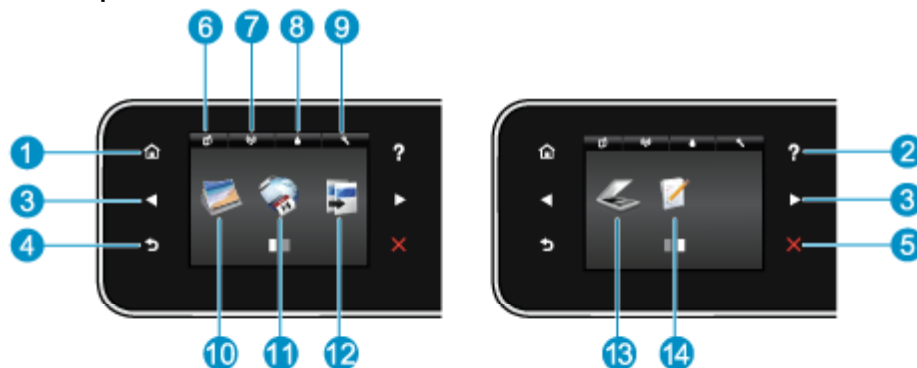

1	Home: Returns to the Home screen, the screen that is displayed when you first turn on the printer.
2	Help: On the Home screen, shows all Help topics. On another screen, shows information or animation on the display to assist in the current operation.
3	Directional buttons: Allow you to navigate through two home screens, photos, print previews, apps, and horizontal menu options.
4	Back: Returns to the previous screen.
5	Cancel: Stops the current operation.
6	ePrint icon: Opens the Web Services Summary menu, where you can check ePrint status details, change ePrint settings, or print an Info page.
7	Wireless icon: Opens the Wireless Summary menu, where you can check wireless status and change wireless settings. You can also print a wireless test report, helping diagnose network connection issues.
8	Ink icon: Shows estimated ink levels by cartridge. Displays a warning symbol if the ink level is less than the minimum expected ink level.
9	Settings icon: Opens the Settings menu where you can change preferences and use tools to perform maintenance functions.
10	Photo: Opens the Photo Menu where you can view and print photos, or reprint a printed photo.
11	Apps: Provides a quick and easy way to access and print information from the web, such as coupons, coloring pages, puzzles, and more.
12	Copy: Opens the Copy menu where you can select a copy type or change the copy settings.
13	Scan: Opens the Scan menu where you can select a destination for your scan.
14	Quick Forms: Using HP Quick Forms, you can print calendars, check lists, games, notebook paper, graph paper, and music paper.

Status lights and buttons

- Wireless status light and button

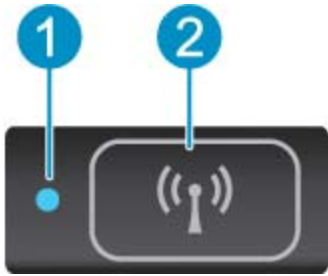

1	Wireless status light	<ul style="list-style-type: none"> • Solid blue light indicates that wireless connection has been established and you can print. • Slow blinking light indicates that wireless is on, but the printer is not connected to a network. Make sure your printer is within the range of wireless signal. • Fast blinking light indicates wireless error. Refer to the message on the printer display.
2	Wireless button	Press the button to display wireless status, IP address, network name, hardware address (MAC), and Wireless Direct status.

- **ePrint button**



Press the button to display the printer's email address, ePrint status, and ePrint feature.

3 How do I?

This section contains links to commonly performed tasks, such as managing apps, scanning, and making copies.

- [Load media on page 12](#)
- [Wireless Direct print on page 12](#)
- [Replace the cartridges on page 26](#)
- [Use HP Print Apps on page 20](#)
- [How to get started with HP ePrint on page 19](#)
- [Print Quick Forms on page 12](#)
- [Clear paper jam on page 37](#)
- [Copy text or mixed documents on page 21](#)
- [Scan to a computer or memory card on page 23](#)
- [Solve a problem on page 37](#)

4 Print



Print photos from a memory card on page 11



Print Quick Forms on page 12



Wireless Direct print on page 12

Related topics

- [Load media on page 12](#)
[Tips for print success on page 16](#)

Print photos from a memory card

To print photos from a memory card

1. Load photo paper into the paper tray.
2. Make sure the paper tray extender is open.
3. Insert a memory card into the memory card slot.

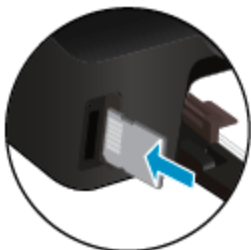

4. From the Home screen, touch **Photo** to display the **Photo** menu.
5. On the **Photo** menu, touch **View & Print** to display photos.
6. Touch a photo that you want to print.
7. Touch the up or down arrow to specify the number of photos to print.
8. Touch **Edit** to select options to edit the selected photos. You can rotate, crop a photo, or turn **Photo Fix** on and off.
9. Touch **Done** and preview the selected photo. If you wish to adjust layout, paper type, red eye removal, or date stamp, touch **Settings**, and then touch your selection. You can also save any new settings as defaults.
10. Touch **Print** to begin printing.

Related topics

- [Load media on page 12](#)
[Tips for print success on page 16](#)

Print Quick Forms

Use HP Quick Forms to print fun and useful pages. You can print calendars, check lists, games, notebook paper, graph paper, and music paper

To print Quick Forms

1. On the Home screen from your printer display, touch the right directional button, and then touch **Quick Forms**.
2. Touch **Quick Forms**. If you cannot find it, touch the right directional button to scroll through all the apps.
3. Select one of the HP Quick Form options: **Calendar**, **Check List**, **Games**, **Notebook Paper**, **Graph Paper**, and **Music Paper**.
4. Touch one of the subcategories from your selection. Use the right directional button to scroll through the subcategories.
5. Touch the left or right arrow button to specify the number of copies you want to print, and then touch **Done**.

Wireless Direct print

With Wireless Direct, you can print directly to the printer wirelessly, without a wireless router, from your Wi-Fi enabled computer or mobile device.

To print with Wireless Direct

1. Make sure Wireless Direct is enabled on the printer. Learn how to enable Wireless Direct, see [Connect wirelessly to the printer without a router on page 32](#) for more information.
2. From your wireless computer or mobile device, turn on the Wi-Fi radio, search for and connect to the Wireless Direct name (for example: HP-print-xx-Photosmart-5520).
3. Print a photo or a document as you normally do from your computer or mobile device.

 **NOTE:** If you want to print from a mobile device, you need to have a print application on your mobile device.

Select print media

The printer is designed to work well with most types of office media. Use HP media for optimum print quality. Visit the HP website at www.hp.com for more information about HP media.

HP recommends plain papers with the ColorLok logo for printing and copying of everyday documents. All papers with the ColorLok logo are independently tested to meet high standards of reliability and print quality, and produce documents with crisp, vivid color, bolder blacks and dry faster than ordinary plain papers. Look for papers with the ColorLok logo in a variety of weights and sizes from major paper manufacturers.

To purchase HP papers, go to [Shop for Products and Services](#) and select ink, toner and paper.

Load media

- ▲ Do one of the following:

Load small-size paper

- a. Pull out the paper tray, slide the paper-width guides outward, and then remove any previously loaded media.





b. Load paper.

- Insert a stack of photo paper into the paper tray with short edge forward and print side down.

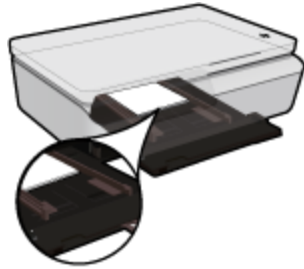

- Slide photo paper forward until it stops.



 **NOTE:** If the photo paper you are using has perforated tabs, load photo paper so that tabs are closest to you.

- Slide paper-width guides inward until they touch the paper.



- Push back in the paper tray, and then open the paper tray extender.

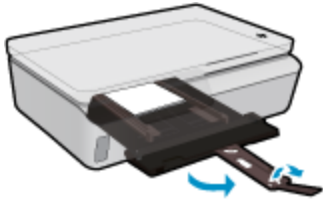

Load full-size paper

- a. Pull out the paper tray, slide the paper-width guides outward, and then remove any previously loaded media.



- b. Load paper.

- Insert a stack of paper into paper tray with short edge forward and print side down.



- Slide paper forward until it stops.
- Slide paper-width guides inward until they stop at the edges of paper.



- Push back in the paper tray, and then open the paper tray extender.

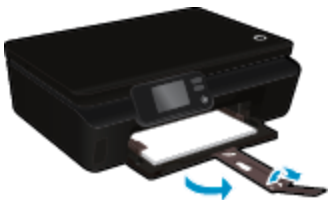

Load envelopes

- a. Pull out the paper tray, slide the paper-width guides outward, and then remove any previously loaded media.

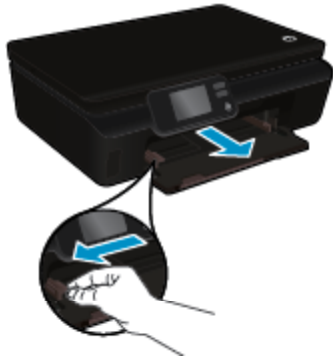

- b. Load envelopes

- Insert one or more envelopes in center of the input tray. The side to be printed on should face down. The flap should be on the left side and facing up.



- Slide stack of envelopes down until it stops.
- Slide paper-width guide to the right against stack of envelopes until it stops.
- Push back in the paper tray, and then open the paper tray extender.

Recommended papers for photo printing

If you want the best print quality, HP recommends using HP papers that are specifically designed for the type of project you are printing. Depending on your country/region, some of these papers might not be available.

Paper	Description
HP Premium Plus Photo Paper	HP's best photo paper is heavyweight for producing professional-quality photos. Features an instant-dry finish for easy handling without smudging. It resists water, smears, fingerprints, and humidity. It is available in several sizes, including A4, 8.5 x 11 inch, 10 x 15 cm (4 x 6 inch), 13 x 18 cm (5 x 7 inch) and two finishes – high gloss or soft gloss (satin matte). It is acid-free for longer lasting documents.
HP Advanced Photo Paper	This thick photo paper features an instant-dry finish for easy handling without smudging. It resists water, smears, fingerprints, and humidity. Your prints have a look and feel comparable to a store processed photo. It is available in several sizes, including A4, 8.5 x 11 inch, 10 x 15 cm (4 x 6 inch), 13 x 18 cm (5 x 7 inch) and two finishes – glossy or soft gloss (satin matte). It is acid-free for longer lasting documents.
HP Everyday Photo Paper	Print colorful, everyday snapshots at a low cost, using paper designed for casual photo printing. This affordable, photo paper dries quickly for easy handling. Get sharp, crisp images when you use this paper with any inkjet printer. Available in glossy finish in 8.5 x 11

Paper	Description
	inch, A4, 4 x 6 inch and 10 x 15 cm. It is acid-free for longer lasting documents.
HP Photo Value Packs	HP Photo Value Packs conveniently package Original HP ink cartridges and HP Advanced Photo Paper to save you time, and take the guesswork out of printing affordable Lab-quality photos with your HP printer. Original HP inks and HP Advanced Photo Paper have been designed to work together so your photos are long lasting and vivid, print after print. Great for printing out an entire vacation's worth of photos or multiple prints to share.

Recommended papers for printing and copying

Depending on your country/region, some of these papers might not be available.

Paper	Description
HP Brochure Paper and HP Professional Paper 180gsm	These papers are glossy-coated or matte-coated on both sides for two-sided use. They are the best choice for producing professional-quality marketing materials, such as brochures and mailers, as well as business graphics for report covers and calendars.
HP Premium Presentation 120gsm Paper and HP Professional Paper 120gsm	These papers are heavy two-sided matte papers perfect for presentation, proposals, reports and newsletters. They are a professional weight for an impressive look and feel.
HP Bright White Inkjet Paper	HP Bright White Inkjet Paper delivers high-contrast colors and sharp text. It is opaque enough for two-sided color usage with no showthrough, which makes it ideal for newsletters, reports, and flyers. It features ColorLok Technology for less smearing, bolder blacks, and vivid colors.
HP Printing Paper	HP Printing Paper is a high-quality multifunction paper. It produces documents that look and feel more substantial than documents printed on standard multipurpose or copy paper. It features ColorLok Technology for less smearing, bolder blacks and vivid colors.
HP Office Paper	HP Office Paper is a high-quality multifunction paper. It is suitable for copies, drafts, memos and other everyday documents. It features ColorLok Technology for less smearing, bolder blacks and vivid colors.
HP Office Recycled Paper	HP Office Recycled Paper is a high-quality multifunction paper made with 30% recycled fiber. It features ColorLok Technology for less smearing, bolder blacks and vivid colors.
HP Iron-On Transfers	HP Iron-on Transfers (for color fabrics or for light or white fabrics) are the ideal solution for creating custom T-shirts from your digital photos.

Tips for print success

Use the following tips to print successfully.

Tips for printing from a computer

For more information on printing documents, photos, or envelopes from a computer, use the following links to operating-system specific instructions.

- Learn how to print documents from your computer. [Click here to go online for more information.](#)
- Learn how to print photos saved on your computer. Learn how to enable maximum dpi resolution. [Click here to go online for more information.](#)
- Learn how to print envelopes from your computer. [Click here to go online for more information.](#)

Tips for ink and paper

- Use genuine HP cartridges. Genuine HP cartridges are designed for and tested with HP printers to help you produce great results, time after time.
- Make sure the cartridges have sufficient ink. To view the estimated ink levels, touch the **Ink** icon from the Home screen.
- If you want to print a black and white document using black ink only, do one of the following according to your operating system.
 - **On Windows:** Open your printer software, click **Set Preferences**. On the **Paper/Quality** tab, click **Advanced**. Select **Black Ink Only** from the **Print in Grayscale** drop-down list under **Printer Features**.
 - **On Mac:** From the Print dialog box, choose the **Paper Type/Quality** pane, click **Color Options**, and then choose **Grayscale** from the Color pop-up menu.
If the Print dialog does not show printer options, click the blue disclosure triangle next to the printer name (Mac OS X v10.5 and v10.6) or **Show Details** (Mac OS X v10.7). Use the pop-up menu toward the bottom of the dialog to choose the **Paper Type/Quality** pane.
- To learn more tips about working with cartridges, see [Tips for working with cartridges on page 29](#) for more information.
- Load a stack of paper, not just one page. Use clean and flat paper of the same size. Make sure only one type of paper is loaded at a time.
- Adjust the paper-width guides in the paper tray to fit snugly against all paper. Make sure the paper-width guides do not bend the paper in the paper tray.
- Set the print quality and paper size settings according to the type and size of paper loaded in the paper tray.
- To clear paper jam, see [Clear paper jam on page 37](#) for more information.

5 Use Web Services



Print from anywhere on page 19



Use HP Print Apps on page 20

Related topics

- Load media on page 12
- Tips for using Web Services on page 20

Print from anywhere

HP ePrint is a free service from HP that allows you to print to your HP ePrint-enabled printer anywhere you can send an email. Just send your documents and photos to the email address assigned to your printer when you enable Web Services. No additional drivers or software are needed.

- Your printer needs to have a wireless network connection to the Internet. You won't be able to use HP ePrint via a USB connection to a computer.
- Attachments might print differently from the way they appear in the software program that created them, depending on the original fonts and layout options used.
- Free product updates are provided with HP ePrint. Some updates might be required to enable certain functionality.

Related topics

- Your printer is protected on page 19
- How to get started with HP ePrint on page 19
- Use the HP ePrintCenter website on page 20

Your printer is protected

To help prevent unauthorized email, HP assigns a random email address to your printer and never publicizes this address. HP ePrint also provides industry-standard spam filtering and transforms email and attachments to a print-only format to reduce the threat of virus or other harmful content. However, the HP ePrint service does not filter emails based on content, so it cannot prevent objectionable or copyrighted material from being printed.

Go to the HP ePrintCenter website for more information and specific terms and conditions: www.hp.com/go/ePrintCenter.

How to get started with HP ePrint

To use HP ePrint, connect your printer to an active wireless network with Internet access, set up an account on HP ePrintCenter, and add your printer to the account.

To get started with HP ePrint

1. Enable Web services.
 - a. Touch the **ePrint** button on the control panel.
 - b. Accept the terms of use, and then follow the onscreen instructions to enable Web Services. The HP ePrint information sheet prints, containing a printer code.

- c. Go to www.hp.com/go/ePrintCenter, click the **Sign In** button, and then click the **Sign Up** link at the top of the window that appears.
 - d. When prompted, enter the printer code to add your printer.
2. Touch **ePrint** on the control panel. From the **Web Services Summary** screen, get your printer's email address.
3. Compose and send email to your printer's email address from your computer or mobile device, anywhere and anytime. Both the email message and recognized attachments will print.

Use HP Print Apps

Print pages from the web, without using a computer, by setting up **Apps**, a free service from HP. You can print coloring pages, calendars, puzzles, recipes, maps, and more, depending on the apps available in your country/region.

Touch the **Get More** icon on the **Apps** screen to connect to the Internet and add more apps. You need to have Web Services enabled in order to use apps.

Go to the HP ePrintCenter website for more information and specific terms and conditions: www.hp.com/go/ePrintCenter.

Use the HP ePrintCenter website

Use HP's free HP ePrintCenter website to set up increased security for HP ePrint, and specify the email addresses that are allowed to send email to your printer. You can also get product updates, more apps, and other free services.

Go to the HP ePrintCenter website for more information and specific terms and conditions: www.hp.com/go/ePrintCenter.

Tips for using Web Services

Use the following tips to print apps and use HP ePrint.

Tips for printing apps and using HP ePrint

- Learn how to share your photos online and order prints. [Click here to go online for more information.](#)
- Learn about apps for printing recipes, coupons, and other content from the web, simply and easily. [Click here to go online for more information.](#)
- Learn how to print from anywhere by sending an email and attachments to your printer. [Click here to go online for more information.](#)
- If you have enabled **Auto Power-Off**, you should disable **Auto Power-Off** to use ePrint. See [Auto Power-Off on page 53](#) for more information.

6 Copy and scan

- [Copy text or mixed documents](#)
- [Scan to a computer or memory card](#)
- [Tips for copy and scan success](#)

Copy text or mixed documents

- ▲ Do one of the following:

Make a 1-sided copy

- a. Load paper.
 - Load full-size paper in the paper tray.



- Make sure the paper tray is pushed back in and the paper tray extender is open.
- b. Load original.
 - Lift the lid on the product.



 **TIP:** To make copies of thick originals, such as books, you can remove the lid.

- Load the original print side down on the right front corner of the glass.



- Close the lid.
- c. Specify number of copies and settings.
 - From the Home screen, touch **Copy**. Touch arrow buttons to change the number of copies.
 - If the **2-Sided** option is selected, touch it to clear the selection.
 - Touch **Settings** to specify paper size, paper type, quality, or other settings.
- d. Start copy.
 - Touch **Black** or **Color**.

Make a 2-sided copy

- a. Load paper.
 - Load full-size paper in the paper tray.



- Make sure the paper tray is pushed back in and the paper tray extender is open.
- b. Load original.
 - Lift the lid on the product.



 **TIP:** To make copies of thick originals, such as books, you can remove the lid.

- Load the original print side down on the right front corner of the glass.



- Close the lid.

- c. Select **Copy**.
 - From the Home screen, touch **Copy**. Touch arrow buttons to change the number of copies.
 - If the **2-Sided** option is not selected, touch to select the option.
 - Touch **Settings** to specify paper size, paper type, quality, or other settings.
- d. Start copy.
 - Touch **Black** or **Color**.

Related topics

- [Tips for copy and scan success on page 24](#)

Scan to a computer or memory card

You can scan to a computer either from the printer display or from the printer software on your computer. Scanning from the printer display is quick. Scanning from the software gives you more options.

Before you can scan to a computer from the printer display, make sure the printer is connected to your computer either on a wireless network or through a USB cable.

To scan to a computer or memory card from the printer display

1. Load the original.
 - a. Lift the lid on the product.



- b. Load the original print side down on the right front corner of the glass.



- c. Close the lid.
2. To scan to a memory card, insert a memory card in the memory card slot.
If you want to scan to a computer, make sure the printer is connected to your computer on a wireless network or through a USB cable.
3. Start scan.
 - a. From the Home screen, touch the right directional button, and then touch **Scan**.
 - b. Select the destination by touching either **Computer** or **Memory Card**.
Touch **Touch here to preview** to preview the scan.
Touch **Settings** to select a scan type or change resolution.
 - c. Touch **Scan**.

Related topics

- [Tips for copy and scan success on page 24](#)

Tips for copy and scan success

Use the following tips to copy and scan successfully:

- Learn how to scan to email from the printer display. [Click here to go online for more information.](#)
- Keep the glass and the back of the lid clean. The scanner interprets anything it detects on the glass as part of the image.
- Load your original, print side down, on the right front corner of the glass.
- To copy or scan a book or other thick originals, remove the lid.
- To make a large copy of a small original, scan the original into the computer, resize the image in the scanning software, and then print a copy of the enlarged image.
- If you want to adjust scan size, output type, scan resolution, or file type, and so on, start scan from the printer software.
- To avoid incorrect or missing scanned text, make sure the brightness is set appropriately in the software.

7 Work with cartridges

- [Check the estimated ink levels](#)
- [Clean printhead automatically](#)
- [Clean ink smear](#)
- [Replace the cartridges](#)
- [Align printer](#)
- [Order ink supplies](#)
- [Cartridge warranty information](#)
- [Tips for working with cartridges](#)

Check the estimated ink levels

From the Home screen, touch the **Ink** icon to display the estimated ink levels.

 **NOTE: 1** If you have installed a refilled or remanufactured cartridge, or a cartridge that has been used in another printer, the ink level indicator might be inaccurate or unavailable.

NOTE: 2 Ink level warnings and indicators provide estimates for planning purposes only. When you receive a low-ink warning message, consider having a replacement cartridge available to avoid possible printing delays. You do not have to replace the cartridges until the print quality is unacceptable.

NOTE: 3 Ink from the cartridges is used in the printing process in a number of different ways, including in the initialization process, which prepares the product and cartridges for printing, and in printhead servicing, which keeps print nozzles clear and ink flowing smoothly. In addition, some residual ink is left in the cartridge after it is used. For more information, see www.hp.com/go/inkusage.

Related topics

- [Order ink supplies on page 28](#)
[Tips for working with cartridges on page 29](#)

Clean printhead automatically

If print quality is unacceptable, and the problem is not low ink levels or non-HP ink, try cleaning the printhead from the printer display. Full-size paper needs to be loaded and an information page will print.

To clean printhead from the printer display

1. From the Home screen, touch the **Settings** icon, and then touch **Tools**.
2. On the **Tools** menu, touch the down arrow to scroll through the options, and then touch **Clean Printhead**.

Related topics

- [Order ink supplies on page 28](#)
[Tips for working with cartridges on page 29](#)

Clean ink smear

If printouts show smears of ink, try cleaning ink smear from the printer display. This process takes several minutes to complete. Full-size plain paper needs to be loaded and will be moved back and forth during the cleaning. Mechanical noises are normal at this time.

To clean ink smear from the printer display

1. From the Home screen, touch the **Settings** icon, and then touch **Tools**.
2. On the **Tools** menu, touch the down arrow to scroll through the options, and then touch **Clean Ink Smear**.

Related topics

- Order ink supplies on page 28
- Tips for working with cartridges on page 29

Replace the cartridges

To replace the cartridges

1. Check that power is on.
2. Remove cartridge.
 - a. Open the cartridge access door.



Wait for the print carriage to move to the ink label part of the product.

- b. Press the tab on the cartridge, then remove it from the slot.

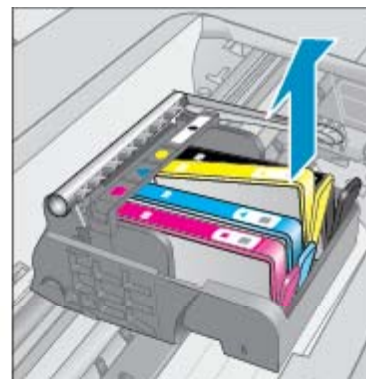
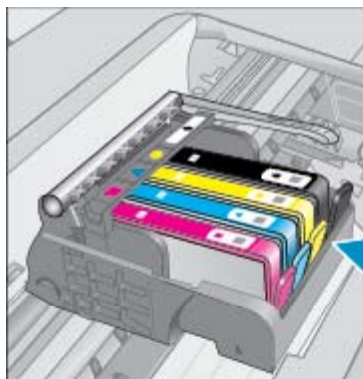

3. Insert new cartridge.
 - a. Remove the cartridge from the packaging.

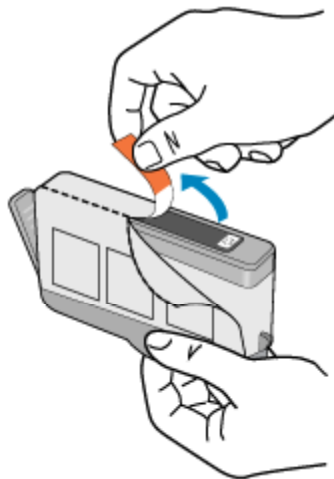

- b. Twist the orange cap to snap it off. A forceful twist may be required to remove the cap.

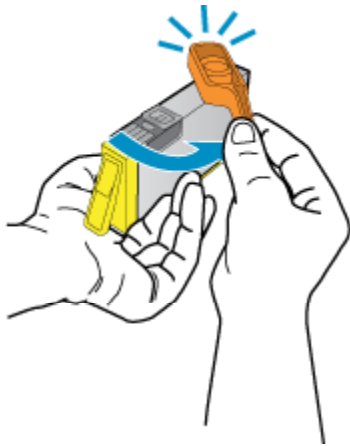

- c. Match color icons, then slide the cartridge into the slot until it clicks into the place.

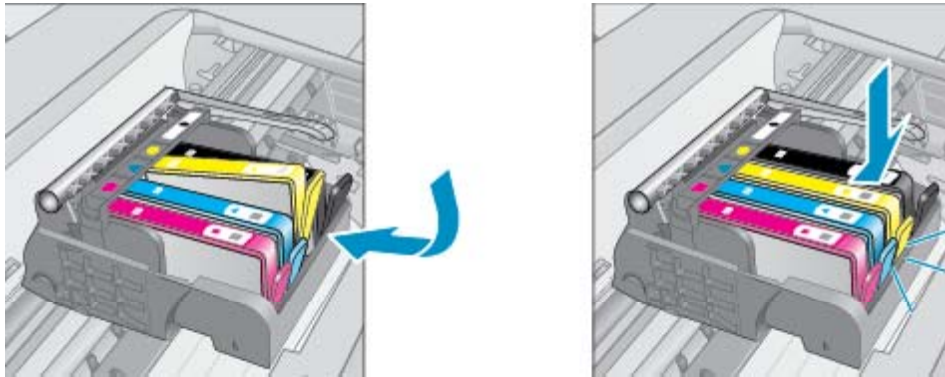

- d. Close the cartridge access door.



Related topics

- [Order ink supplies on page 28](#)
- [Tips for working with cartridges on page 29](#)

Align printer

After you insert new cartridges, align the printer for best print quality. You can align printer either from the printer display or from the printer software.

To align printer from the printer display

1. From the Home screen, touch the **Settings** icon, and then touch **Tools**.
2. On the **Tools** menu, touch the down arrow to scroll through the options, and then touch **Align Printer**.
3. Follow the instruction on the screen.

To align printer from the printer software

- ▲ Do one of the following according to the operating system you are using.

On Windows:

- a. From the **Start** menu on your computer, click **All Programs**, click **HP**.
- b. Click the **HP Photosmart 5520 series** folder, click **HP Photosmart 5520 series**.
- c. Under **Print**, double-click **Maintain Your Printer**.
- d. Under the **Device Services** tab, double-click **Align Printheads**.

On Mac:

- ▲ Open **HP Utility**, click **Align**, and then click **Align** again.

Related topics

- [Order ink supplies on page 28](#)
- [Tips for working with cartridges on page 29](#)

Order ink supplies

To find the correct model number for replacement cartridges, open the printer cartridge access door and check the label.



Cartridge information and links to online shopping also appear on ink alert messages. In addition, you can find cartridge information and order online by visiting www.hp.com/buy/supplies.

 **NOTE:** Ordering cartridges online is not supported in all countries/regions. If it is not supported in your country/region, contact a local HP reseller for information about purchasing cartridges.

Cartridge warranty information

The HP cartridge warranty is applicable when the product is used in its designated HP printing device. This warranty does not cover HP ink products that have been refilled, remanufactured, refurbished, misused, or tampered with.

During the warranty period the product is covered as long as the HP ink is not depleted and the end of warranty date has not been reached. The end of warranty date, in YYYY/MM format, may be found on the product as indicated:

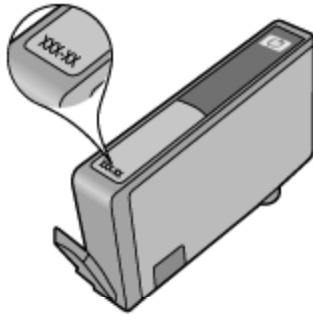

For a copy of the HP Limited Warranty Statement for the printer, see the printed documentation that came with the product.

Tips for working with cartridges

Use the following tips to work with cartridges:

- Don't open or uncap cartridges until you are ready to install them. Leaving caps on the cartridges reduces ink evaporation.
- Insert the cartridges into the correct slots. Match the color and icon of each cartridge to the color and icon for each slot. Make sure all cartridges snap down into place.
- After you insert new cartridges, align the printer for best print quality. See [Align printer on page 27](#) for more information.
- Make sure the printhead is clean. See [Clean printhead automatically on page 25](#) for more information.
- When you receive a low ink alert message, consider getting replacement cartridges. This avoids possible printing delays. You do not need to replace the cartridges until print quality becomes unacceptable. See [Replace the cartridges on page 26](#) for more information.
- If you receive a carriage stalled error, try clearing carriage jam. See [Clear carriage jam on page 39](#) for more information.

8 Connectivity

- [Add the HP Photosmart to a network](#)
- [Connect wirelessly to the printer without a router](#)
- [Change from a USB connection to a wireless network](#)
- [Connect a new printer](#)
- [Change network settings](#)
- [Tips for setting up and using a networked printer](#)
- [Advanced printer management tools \(for networked printers\)](#)

Add the HP Photosmart to a network

- [WiFi Protected Setup \(WPS\) on page 31](#)
- [Wireless with a router \(infrastructure network\) on page 32](#)

WiFi Protected Setup (WPS)

To connect the HP Photosmart to a wireless network using WiFi Protected Setup (WPS), you will need the following:

- A wireless 802.11b/g/n network that includes a WPS-enabled wireless router or access point.

 **NOTE:** 802.11n will only support 2.4Ghz.

- A desktop computer or laptop with either wireless networking support, or a network interface card (NIC). The computer must be connected to the wireless network that you intend to install the HP Photosmart on.

To connect the HP Photosmart using WiFi Protected Setup (WPS)

- ▲ Do one of the following:

Use Push Button Configuration (PBC) method

- Select setup method. Make sure your WPS-enabled wireless router supports PBC method.
 - From the Home screen, touch the **Wireless** icon, and then touch **Settings**.
 - Touch the down arrow to scroll through the options. Touch **WiFi Protected Setup**.
 - Touch **Push Button Setup**.
- Set up wireless connection.
 - Turn on wireless radio if it is off.
 - Touch **Start**.
 - Press and hold the button on WPS-enabled router or other networking device for three seconds to activate WPS.



 **NOTE:** The product begins a timer for approximately two minutes in which the corresponding button on the networking device needs to be pressed.

- Touch **OK**.
- c. Install software.

Use PIN method

- a. Select setup method. Make sure your WPS-enabled wireless router supports PIN method.
 - From the Home screen, touch the **Wireless** icon, and then touch **Settings**.
 - Touch the down arrow to scroll through the options. Touch **WiFi Protected Setup**.
 - Touch **PIN Setup**.
- b. Set up wireless connection.
 - Touch **Start**.
 - Turn on wireless radio if it is off.

 **NOTE:** The product begins a timer for approximately five minutes in which the PIN needs to be entered on the networking device.

- Touch **OK**.
- c. Install software.

Related topics

- [Tips for setting up and using a networked printer on page 34](#)

Wireless with a router (infrastructure network)

To connect the HP Photosmart to an integrated wireless WLAN 802.11 network, you will need the following:

- A wireless 802.11b/g/n network that includes a wireless router or access point.

 **NOTE:** 802.11n will only support 2.4Ghz.

- A desktop computer or laptop with either wireless networking support, or a network interface card (NIC). The computer must be connected to the wireless network that you intend to install the HP Photosmart on.
- Broadband Internet access (recommended) such as cable or DSL.
If you connect the HP Photosmart on a wireless network that has Internet access, HP recommends that you use a wireless router (access point or base station) that uses Dynamic Host Configuration Protocol (DHCP).
- Network name (SSID).
- WEP key or WPA Passphrase (if needed).

To connect the product with the Wireless Setup Wizard

1. Write down your network name (SSID) and WEP key or WPA passphrase.
2. Start Wireless Setup Wizard.
 - a. From the Home screen, touch the **Wireless** icon, and then touch **Settings**.
 - b. Touch **Wireless Setup Wizard**.
3. Connect to wireless network.
 - ▲ Select your network from the list of detected networks.
4. Follow prompts.
5. Install software.

Related topics

- [Tips for setting up and using a networked printer on page 34](#)

Connect wirelessly to the printer without a router

Wireless Direct allows your Wi-Fi devices (for example: computers or smartphones) to connect to your printer directly through Wi-Fi, using the process you currently use to connect your Wi-Fi device to new wireless networks and hotspots. You can print directly to the printer wirelessly with the Wireless Direct connection.

To connect wirelessly to the printer without a router

1. Turn on Wireless Direct from the control panel:
 - a. From the Home screen, touch the **Wireless** icon.
 - b. If Wireless Direct displays Off, touch **Settings**.
 - c. Touch **Wireless Direct**, touch **On (No Security)** or **On (With Security)**.

 **NOTE:** If you turn on security, only users with the password will be able to print wirelessly to the printer. If you turn off security, anyone with a Wi-Fi device within Wi-Fi range of the printer will be able to connect to the printer.

2. Locate the Wireless Direct name and password if you have Wireless Direct security on:
 - a. From the Home screen, touch the **Wireless** icon, touch **Settings**, and then touch **Wireless Direct**.
 - b. Touch **Display Name** to display the Wireless Direct name.
 - c. Touch **Display Password** to display the Wireless Direct password.
3. From your wireless computer or mobile device, turn on the Wi-Fi radio, search for and connect to the Wireless Direct name (for example: HP-print-xx-Photosmart-5520).
If you have Wireless Direct security on, enter the Wireless Direct password when prompted.

 **NOTE: 1** You cannot access the Internet through the Wireless Direct connection.

NOTE: 2 The Wireless Direct connection is available even if the printer is also connected to a wireless home network.

NOTE: 3 All functionality that is available on your wireless home network, such as printing, scanning, printer maintenance, etc., is also available when a computer, with the printer software installed, is connected to the printer with Wireless Direct. Some functionality may not be supported if the printer has a simultaneous wireless connection to your home network and Wireless Direct.

Change from a USB connection to a wireless network

If you first setup your printer and installed the software with a USB cable, directly connecting the printer to your computer, you can easily change to a wireless network connection. You will need a wireless 802.11b/g/n network that includes a wireless router or access point.

 **NOTE:** 802.11n will only support 2.4Ghz.

To change from a USB connection to a wireless network

- ▲ Do one of the following according to your operating system.

On Windows:

- a. From the **Start** menu on your computer, click **All Programs**, and then click **HP**.
- b. Click **HP Photosmart 5520 series**, click **Printer Setup & Software**, and then click **Convert a USB connected printer to wireless**.
- c. Follow the instructions on the screen.

On Mac:

- a. From the Home screen, touch the **Wireless** icon, and then touch **Settings**.
- b. Follow the instructions on the screen to connect the printer.
- c. Use **HP Setup Assistant** in Applications/Hewlett-Packard/Device Utilities to change the software connection to this printer to wireless.

Connect a new printer

To connect a new printer from the printer software

If you haven't finished connecting the printer to your computer, you need to connect it from the printer software. If you want to connect another new printer of the same model to your computer, you don't need to install the printer software once again.

- ▲ Do one of the following according to your operating system.

On Windows:

- a. From the **Start** menu on your computer, click **All Programs**, and then click **HP**.
- b. Click **HP Photosmart 5520 series**, click **Printer Setup & Software**, and then click **Connect a new printer**.
- c. Follow the instructions on the screen.

On Mac:

- a. From the Home screen, touch the **Wireless** icon, and then touch **Settings**.
- b. Follow the instructions on the screen to connect the printer.
- c. Use **HP Setup Assistant** in Applications/Hewlett-Packard/Device Utilities to change the software connection to this printer to wireless.

Change network settings

If you want to change the wireless settings that you previously configured to a network, you need to run the Wireless Setup Wizard from the printer display.

To run Wireless Setup Wizard to change network settings

1. From the Home screen, touch the **Wireless** icon, and then touch **Settings**.
2. Touch **Wireless Setup Wizard**.
3. Follow the instructions on the screen to change the network settings.

Tips for setting up and using a networked printer

Use the following tips to set up and use a networked printer:

- When setting up the wireless networked printer, make sure your wireless router is powered on. The printer searches for wireless routers, then lists the detected network names on the display.
- To verify the wireless connection, touch the **Wireless** button on the control panel. If it shows **Wireless Off**, touch **Turn On**.
- If your computer is connected to a Virtual Private Network (VPN), you need to disconnect from the VPN before you can access any other device on your network, including the printer.
- Learn more about configuring your network and the printer for wireless printing. [Click here to go online for more information.](#)
- Learn how to find your network security settings. [Click here to go online for more information.](#)
- Learn about the Network Diagnostic Utility (Windows only) and other troubleshooting tips. [Click here to go online for more information.](#)
- Learn how to change from a USB to wireless connection. [Click here to go online for more information.](#)
- Learn how to work with your firewall and anti-virus programs during printer setup. [Click here to go online for more information.](#)

Advanced printer management tools (for networked printers)

When the printer is connected to a network, you can use the embedded Web server to view status information, change settings, and manage the printer from your computer.

 **NOTE:** To view or change some settings, you might need a password.

You can open and use the embedded Web server without being connected to the Internet. However, some features are not available.

-
- [Open the embedded Web server](#)
 - [About cookies](#)

Open the embedded Web server

 **NOTE:** The printer must be on a network and must have an IP address. The IP address for the printer can be found by touching the **Wireless** button on the control panel or by printing a network configuration page.

In a supported Web browser on your computer, type the IP address or hostname that has been assigned to the printer.

For example, if the IP address is 192.168.0.12, type the following address into a Web browser such as Internet Explorer: `http://192.168.0.12`.

About cookies

The embedded Web server (EWS) places very small text files (cookies) on your hard drive when you are browsing. These files let the EWS recognize your computer the next time you visit. For example, if you have configured the EWS language, a cookie helps remember which language you have selected so that the next time you access the EWS, the pages are displayed in that language. Though some cookies are cleared at the end of each session (such as the cookie that stores the selected language), others (such as the cookie that stores customer-specific preferences) are stored on the computer until you clear them manually.

You can configure your browser to accept all cookies, or you can configure it to alert you every time a cookie is offered, which allows you to decide which cookies to accept or refuse. You can also use your browser to remove unwanted cookies.

 **NOTE:** Depending on your printer, if you disable cookies, you also disable one or more of the following features:

-
- Starting where you left the application (especially useful when using setup wizards).
 - Remembering the EWS browser language setting.
 - Personalizing the EWS Home page.

For information about how to change your privacy and cookie settings and how to view or delete cookies, see the documentation available with your Web browser.

9 Solve a problem

- [Get more help](#)
- [Register your printer](#)
- [Clear paper jam](#)
- [Solve print problem](#)
- [Solve copy and scan problem](#)
- [Solve networking problem](#)
- [HP support by phone](#)

Get more help

You can find more information and help about your HP Photosmart by entering a keyword in the **Search** field in the top left of the help viewer. Titles of related topics -- for both local and online topics -- will be listed.



[Click here to go online for more information.](#)

Register your printer

By taking just a few minutes to register your printer, you can enjoy quicker service, more efficient support, and product support alerts. If you did not register your printer while installing the software, you can register now at <http://www.register.hp.com>.

Clear paper jam

Clear a paper jam from the paper tray.

To clear a paper jam from the paper tray

1. Open the cartridge access door.



2. Open the paper path cover.



3. Remove the jammed paper from the rear roller.



4. Close the paper path cover.



5. Close the cartridge access door.



6. Try printing again.
Clear a paper jam from the duplexer.

To clear a paper jam from the duplexer

1. Open the cartridge access door.



2. Open the paper path cover.



3. Press on the hole of the duplexer path cover to lift it up. Remove the jammed paper.



4. Close the paper path cover.



5. Close the cartridge access door.



6. Try printing again.

If the above solutions do not resolve the problem, [click here for more online troubleshooting](#).

Clear carriage jam

Remove any objects, such as paper, that are blocking the print carriage.

 **NOTE:** Do not use any tools or other devices to remove jammed paper. Always use caution when removing jammed paper from inside the printer.

To get help from the print display, touch **Help** from the Home screen. Touch the directional button to navigate through help topics, touch **Troubleshoot and Support**, and then touch **Clear Carriage Jam**.



[Click here to go online for more information.](#)

Solve print problem

Make sure that the printer is turned on and that there is paper in the paper tray. If you are still unable to print, HP provides a Print Diagnostic Utility (Windows only) that can help solve many common “Unable to Print” issues. From the **Start** menu on your computer, click **All Programs**, and then click **HP**. Under **HP Photosmart 5520 series**, click **HP Photosmart 5520 series**, click the **Help** button, and then double-click **HP Print Diagnostic Utility**.



[Click here to go online for more information.](#)

If print quality is not acceptable, try the following to improve print quality:

- Use the printer status and print quality reports to diagnose printer and print quality issues. From the Home screen, touch the **Settings** icon, and then touch **Tools**. Touch **Printer Status Report** or **Print Quality Report**. [Click here to go online for more information](#)
- If printouts show misaligned colors or lines, try aligning the printer. See [Align printer on page 27](#) for more information.
- If there are ink smears on the printouts, try clearing the ink smears. See [Clean ink smear on page 25](#) for more information.

Solve copy and scan problem

HP provides a Scan Diagnostic Utility (Windows only) that can help solve many common “Unable to scan” issues. From the **Start** menu on your computer, click **All Programs**, and then click **HP**. Under **HP Photosmart 5520 series**, click **HP Photosmart 5520 series**, click the **Help** button, and then double-click **HP Scan Diagnostic Utility**.

Learn more about how to solve scan issues. [Click here to go online for more information.](#)

Learn how to solve copy issues. [Click here to go online for more information.](#)

Solve networking problem

Check the network configuration or print the wireless test report to assist in diagnosing network connection issues.

To check network configuration or print wireless test report

1. From the Home screen, touch the **Wireless** icon, and then touch **Settings**.
2. Touch the down arrow to scroll through options. Touch **Display Network Configuration** or **Print Wireless Test Report**.

Click the links below to find more online information to solve networking issues.

- Learn more about wireless printing. [Click here to go online for more information.](#)
- Learn how to find your network security settings. [Click here to go online for more information.](#)
- Learn about the Network Diagnostic Utility (Windows only) and other troubleshooting tips. [Click here to go online for more information.](#)
- Learn how to work with your firewall and anti-virus programs during printer setup. [Click here to go online for more information.](#)

HP support by phone

Phone support options and availability vary by product, country/region, and language.

This section contains the following topics:

- [Phone support period](#)
- [Placing a call](#)
- [After the phone support period](#)

Phone support period

One year of phone support is available in North America, Asia Pacific, and Latin America (including Mexico). To determine the duration of phone support in Europe, the Middle East, and Africa, go to www.hp.com/support. Standard phone company charges apply.

Placing a call

Call HP support while you are in front of the computer and the product. Be prepared to provide the following information:

- Product name (HP Photosmart 5520 series)
- Serial number (located on the back or bottom of the product)
- Messages that appear when the situation occurs
- Answers to these questions:
 - Has this situation happened before?
 - Can you re-create it?
 - Did you add any new hardware or software to your computer at about the time that this situation began?
 - Did anything else occur prior to this situation (such as a thunderstorm, product was moved, etc.)?

For the list of support phone numbers, visit www.hp.com/support.

After the phone support period

After the phone support period, help is available from HP at an additional cost. Help may also be available at the HP online support Web site: www.hp.com/support. Contact your HP dealer or call the support phone number for your country/region to learn more about support options.

Additional warranty options

Extended service plans are available for the HP Photosmart at additional costs. Go to www.hp.com/support, select your country/region and language, then explore the services and warranty area for information about the extended service plans.

Cartridge supply upgrade

If the supply upgrade is not successful, try getting your printer to recognize the supply upgrade cartridge.

To get the printer to recognize the supply upgrade cartridge:

1. Remove the supply upgrade cartridge.
2. Insert the original cartridge in the carriage.
3. Close the cartridge access door, then wait until the carriage stops moving.
4. Remove the original cartridge, then replace with the supply upgrade cartridge.
5. Close the cartridge access door, then wait until the carriage stops moving.

If you still receive a supply upgrade problem error message, contact HP support for help.



[Click here to go online for more information.](#)

Prepare printer

If you are not satisfied with the print quality, try cleaning the cartridges from the control panel. See [Clean printhead automatically on page 25](#) for more information.

To maintain the cartridges, use the printer's Auto Power-Off feature to manage the printer's power use. See [Auto Power-Off on page 53](#) for more information.

Check cartridge access door

The cartridge access door should be closed for printing.



[Click here to go online for more information.](#)

Printhead failure

The printhead in this product has failed. Contact HP support for help.



[Click here to go online for more information.](#)

Printer failure

If you have already turned the printer off and then on, and this does not solve your problem, contact HP support for help.



[Click here to go online for more information.](#)

Ink cartridge problem

To solve ink cartridge problem

1. Try removing and reinserting the cartridges. Make sure the cartridges are in the correct slots.
2. If reinserting the cartridges does not work, try cleaning cartridge contacts.

To clean cartridge contacts

⚠ CAUTION: The cleaning procedure should take only a few minutes. Make sure that the ink cartridges are reinstalled in the product as soon as possible. It is not recommended to leave the ink cartridges outside of the product longer than 30 minutes. This could result in damage to both the printhead and the ink cartridges.

- a. Check that power is on.
- b. Open the cartridge access door.



Wait for the print carriage to move to the ink label part of the product.

- c. Press tab on the cartridge indicated in the error message, then remove it from slot.

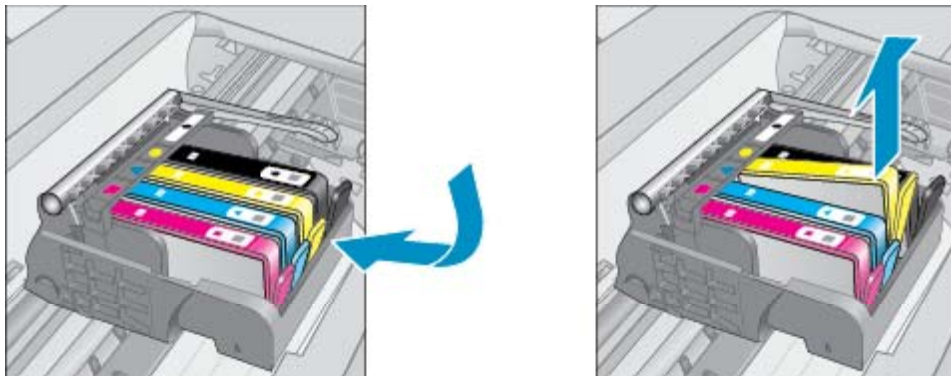

- d. Hold the ink cartridge by its sides with the bottom pointing up and locate the electrical contacts on the ink cartridge.

The electrical contacts are four small rectangles of copper or gold-colored metal on the bottom of the ink cartridge.

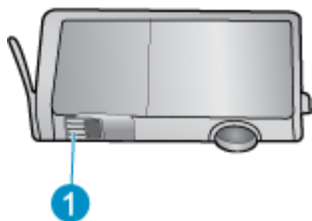

1 Electrical contacts

- e. Wipe only the contacts with a damp lint-free cloth.

⚠ CAUTION: Be careful to touch only the contacts, and do not smear any of the ink or other debris elsewhere on the cartridge.

- f. On the inside of the product, locate the contacts in the printhead. The contacts look like a set of four copper or gold-colored pins positioned to meet the contacts on the ink cartridge.

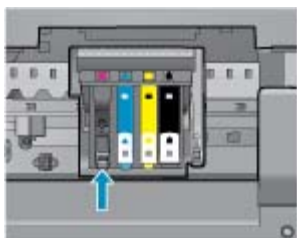

- g. Use a dry swab or lint-free cloth to wipe the contacts.
 h. Reinstall the ink cartridge.
 i. Close the access door, and check if the error message has gone away.
 j. If you still receive the error message, turn the product off, and then on again.
3. If your problem is still not resolved, try replacing cartridges. See [Replace the cartridges on page 26](#) for more information.



[Click here to go online for more information.](#)

SETUP cartridges

When you first set up the printer, you must install the cartridges that shipped in the box with the printer. These cartridges are labeled SETUP, and they calibrate your printer before the first print job. Failure to install the SETUP cartridges during the initial product setup causes an error.

If you installed a set of regular cartridges, remove them and install the SETUP cartridges to complete printer setup. After printer setup is complete, the printer can use regular cartridges.

⚠ WARNING! Don't open or uncap cartridges until you are ready to install them. Leaving caps on the cartridges reduces ink evaporation. You can use the orange caps from the SETUP cartridges if necessary.



If you still receive the error message, contact HP support for help.



[Click here to go online for more information.](#)

Older generation cartridges

You will need to use a newer version of this cartridge. In most cases you can identify a newer version of the cartridge by looking at the exterior of the cartridge package and finding the Warranty Ends date.



If it says 'v1' several spaces to the right of the date, then the cartridge is the updated newer version. If it is an older generation cartridge, contact HP support for help or replacement.



[Click here to go online for more information.](#)

10 Technical information

The technical specifications and international regulatory information for the HP Photosmart are provided in this section.

For additional specifications, see the printed documentation that came with the HP Photosmart.

This section contains the following topics:

- [Notice](#)
- [Cartridge chip information](#)
- [Specifications](#)
- [Environmental product stewardship program](#)
- [Regulatory notices](#)
- [Regulatory wireless statements](#)

Notice

Hewlett-Packard Company notices

The information contained in this document is subject to change without notice.

All rights reserved. Reproduction, adaptation, or translation of this material is prohibited without prior written permission of Hewlett-Packard, except as allowed under copyright laws. The only warranties for HP products and services are set forth in the express warranty statements accompanying such products and services. Nothing herein should be construed as constituting an additional warranty. HP shall not be liable for technical or editorial errors or omissions contained herein.

© 2011 Hewlett-Packard Development Company, L.P.

Microsoft, Windows, Windows XP, and Windows Vista are U.S. registered trademarks of Microsoft Corporation.

Windows 7 is either a registered trademark or trademark of Microsoft Corporation in the United States and/or other countries.

Intel and Pentium are trademarks or registered trademarks of Intel Corporation or its subsidiaries in the United States and other countries.

Adobe® is a trademark of Adobe Systems Incorporated.

Cartridge chip information

The HP cartridges used with this product contain a memory chip that assists in the operation of the product. In addition, this memory chip collects a limited set of information about the usage of the product, which might include the following: the date when the cartridge was first installed, the date when the cartridge was last used, the number of pages printed using the cartridge, the page coverage, the printing modes used, any printing errors that might have occurred, and the product model. This information helps HP design future products to meet our customers printing needs.

The data collected from the cartridge memory chip does not contain information that can be used to identify a customer or user of the cartridge or their product.

HP collects a sampling of the memory chips from cartridges returned to HP's free return and recycling program (HP Planet Partners: www.hp.com/hpinfo/globalcitizenship/environment/recycle/). The memory chips from this sampling are read and studied in order to improve future HP products. HP partners who assist in recycling this cartridge might have access to this data, as well.

Any third party possessing the cartridge might have access to the anonymous information on the memory chip. If you prefer to not allow access to this information, you can render the chip inoperable. However, after you render the memory chip inoperable, the cartridge cannot be used in an HP product.

If you are concerned about providing this anonymous information, you can make this information inaccessible by turning off the memory chip's ability to collect the product's usage information.

To disable the usage information function

1. From the Home screen, touch the **Settings** icon.



2. Touch **Preferences**.
3. Use the down arrow button to scroll through the options. Touch **Cartridge Chip Info**, and then touch **Off**.

NOTE: 1 To re-enable the usage information function, restore the factory defaults.

NOTE: 2 You can continue to use the cartridge in the HP product if you turn off the memory chip's ability to collect the product's usage information.

Specifications

Technical specifications for the HP Photosmart are provided in this section. For more product specifications, see the Product Data Sheet at www.hp.com/support.

System requirements

Software and system requirements are located in the Readme file.

For information about future operating system releases and support, visit the HP online support Web site at www.hp.com/support.

Environmental specifications

- Recommended operating temperature range: 15°C to 32°C (59°F to 90°F)
- Allowable operating temperature range: 5°C to 40°C (41°F to 104°F)
- Humidity: 20% to 80% RH non-condensing (recommended); 25°C maximum dewpoint
- Non-operating (Storage) temperature range: -40°C to 60°C (-40°F to 140°F)
- In the presence of high electromagnetic fields, it is possible the output from the HP Photosmart may be slightly distorted.
- HP recommends using a USB cable less than or equal to 3 m (10 feet) in length to minimize injected noise due to potential high electromagnetic fields.

Print specifications

- Print speeds vary according to the complexity of the document.
- Method: drop-on-demand thermal inkjet
- Language: PCL3 GUI

Scan specifications

- Optical Resolution: up to 1200 dpi
- Hardware Resolution: up to 1200 x 2400 dpi
- Enhanced Resolution: up to 2400 x 2400 dpi
- Bitdepth: 24-bit color, 8-bit grayscale (256 levels of gray)
- Maximum scan size from glass: 21.6 x 29.7 cm (8.5 x 11.7 inches)
- Supported File Types: BMP, JPEG, PNG, TIFF, PDF
- Twain Version: 1.9

Copy specifications

- Digital image processing
- Maximum number of copies varies by model.
- Copy speeds vary according to the complexity of the document and model.

Cartridge yield

Visit www.hp.com/go/learnaboutsupplies for more information on estimated cartridge yields.

Print resolution

Print resolution (continued)

Print resolution

Draft mode	<ul style="list-style-type: none"> Color Input/Black Render: 300x300dpi Output (Black/Color): Automatic
Normal mode	<ul style="list-style-type: none"> Color Input/Black Render: 600x600dpi Output (Black/Color): Automatic
Plain-Best mode	<ul style="list-style-type: none"> Color Input/Black Render: 600x600dpi Output (Black/Color): Automatic
Photo-Best mode	<ul style="list-style-type: none"> Color Input/Black Render: 600x600dpi Output (Black/Color): Automatic
Max DPI mode	<ul style="list-style-type: none"> Color Input/Black Render: 1200x1200dpi Output: Automatic (Black), 4800x1200 optimized dpi (Color)

Environmental product stewardship program

Hewlett-Packard is committed to providing quality products in an environmentally sound manner. Design for recycling has been incorporated into this product. The number of materials has been kept to a minimum while ensuring proper functionality and reliability. Dissimilar materials have been designed to separate easily. Fasteners and other connections are easy to locate, access, and remove using common tools. High priority parts are designed for efficient disassembly and repair.

For more information, visit HP's Commitment to the Environment website at:

www.hp.com/hpinfo/globalcitizenship/environment/index.html.

This section contains the following topics:

- [Eco-Tips](#)
- [Paper use](#)
- [Plastics](#)
- [Material safety data sheets](#)
- [Recycling program](#)
- [HP inkjet supplies recycling program](#)
- [Power consumption](#)
- [Disposal of waste equipment by users in private households in the European Union](#)
- [Chemical Substances](#)
- [Toxic and hazardous substance table \(China\)](#)
- [Restriction of hazardous substance \(Ukraine\)](#)
- [Battery disposal in the Netherlands](#)
- [Battery disposal in Taiwan](#)
- [California Perchlorate Material Notice](#)
- [EU battery directive](#)
- [Auto Power-Off](#)
- [Sleep mode](#)

Eco-Tips

HP is committed to helping customers reduce their environmental footprint. HP has provided the Eco-Tips below to help you focus on ways to assess and reduce the impact of your printing choices. In addition to specific features in this product, please visit the HP Eco Solutions website for more information on HP's environmental initiatives.

www.hp.com/hpinfo/globalcitizenship/environment/

Paper use

This product is suited for the use of recycled paper according to DIN 19309 and EN 12281:2002.

Plastics

Plastic parts over 25 grams are marked according to international standards that enhance the ability to identify plastics for recycling purposes at the end of product life.

Material safety data sheets

Material safety data sheets (MSDS) can be obtained from the HP Web site at:

www.hp.com/go/msds

Recycling program

HP offers an increasing number of product return and recycling programs in many countries/regions, and partners with some of the largest electronic recycling centers throughout the world. HP conserves resources by reselling some of its most popular products. For more information regarding recycling of HP products, please visit:

www.hp.com/hpinfo/globalcitizenship/environment/recycle/

HP inkjet supplies recycling program

HP is committed to protecting the environment. The HP Inkjet Supplies Recycling Program is available in many countries/regions, and lets you recycle used print cartridges and ink cartridges free of charge. For more information, go to the following Web site:

www.hp.com/hpinfo/globalcitizenship/environment/recycle/

Power consumption

Hewlett-Packard printing and imaging equipment marked with the ENERGY STAR® logo is qualified to the U.S. Environmental Protection Agency's ENERGY STAR specifications for imaging equipment. The following mark will appear on ENERGY STAR qualified imaging products:



Additional ENERGY STAR qualified imaging product model information is listed at: www.hp.com/go/energystar

Disposal of waste equipment by users in private households in the European Union



English	<p>Disposal of Waste Equipment by Users in Private Households in the European Union This symbol on the product or on its packaging indicates that this product must not be disposed of with your other household waste. Instead, it is your responsibility to dispose of your waste equipment by handing it over to a designated collection point for the recycling of waste electrical and electronic equipment. The separate collection and recycling of your waste equipment at the time of disposal will help to conserve natural resources and ensure that it is recycled in a manner that protects human health and the environment. For more information about where you can drop off your waste equipment for recycling, please contact your local city office, your household waste disposal service or the shop where you purchased the product.</p>
French	<p>Évacuation des équipements usagés par les utilisateurs dans les foyers privés au sein de l'Union européenne La présence de ce symbole sur le produit ou sur son emballage indique que vous ne pouvez pas vous débarrasser de ce produit de la même façon que vos déchets courants. Au contraire, vous êtes responsable de l'évacuation de vos équipements usagés et, à cet effet, vous êtes tenu de les remettre à un point de collecte agréé pour le recyclage des équipements électriques et électroniques usagés. Le tri, l'évacuation et le recyclage séparés de vos équipements usagés permettront de préserver les ressources naturelles et de s'assurer que ces équipements sont recyclés dans le respect de la santé humaine et de l'environnement. Pour plus d'informations sur les lieux de collecte des équipements usagés, veuillez contacter votre mairie, votre service de traitement des déchets ménagers ou le magasin où vous avez acheté le produit.</p>
German	<p>Entsorgung von Elektrogeräten durch Benutzer in privaten Haushalten in der EU Dieses Symbol auf dem Produkt oder dessen Verpackung gibt an, dass das Produkt nicht zusammen mit dem Restmüll entsorgt werden darf. Es obliegt daher Ihrer Verantwortung, das Gerät an einer entsprechenden Stelle für die Entsorgung oder Wiederverwertung von Elektrogeräten aller Art abzugeben (z.B. ein Wertstoffhof). Die separate Sammlung und das Recyceln Ihrer alten Elektrogeräte zum Zeitpunkt Ihrer Entsorgung trägt zum Schutz der Umwelt bei und gewährleistet, dass sie auf eine Art und Weise recycelt werden, die keine Gefährdung für die Gesundheit des Menschen und der Umwelt darstellt. Weitere Informationen darüber, wo Sie alte Elektrogeräte zum Recyceln abgeben können, erhalten Sie bei den örtlichen Behörden, Wertstoffhöfen oder dort, wo Sie das Gerät erworben haben.</p>
Italian	<p>Smaltimento di apparecchiature da rottamare da parte di privati nell'Unione Europea Questo simbolo che appare sul prodotto o sulla confezione indica che il prodotto non deve essere smaltito assieme agli altri rifiuti domestici. Gli utenti devono provvedere allo smaltimento delle apparecchiature da rottamare portandole al luogo di raccolta indicato per il riciclaggio delle apparecchiature elettriche ed elettroniche. La raccolta e il riciclaggio separati delle apparecchiature da rottamare in fase di smaltimento favoriscono la conservazione delle risorse naturali e garantiscono che tali apparecchiature vengano rottamate nel rispetto dell'ambiente e della tutela della salute. Per ulteriori informazioni sui punti di raccolta delle apparecchiature da rottamare, contattare il proprio comune di residenza, un servizio di smaltimento dei rifiuti locale o il negozio presso il quale è stato acquistato il prodotto.</p>
Spanish	<p>Eliminación de residuos de aparatos eléctricos y electrónicos por parte de usuarios domésticos en la Unión Europea Este símbolo en el producto o en el embalaje indica que no se puede deschar el producto junto con los residuos domésticos. Por el contrario, si debe eliminar este tipo de residuo, es responsabilidad del usuario entregarlo en un punto de recogida designado de reciclado de aparatos electrónicos y eléctricos. El reciclaje y la recogida por separado de estos residuos en el momento de la eliminación ayudará a preservar recursos naturales y a garantizar que el reciclaje proteja la salud y el medio ambiente. Si desea información adicional sobre los lugares donde puede dejar estos residuos para su reciclado, póngase en contacto con las autoridades locales de su ciudad, con el servicio de gestión de residuos domésticos o con la tienda donde adquirió el producto.</p>
Czech	<p>Likvidace vysloužilého zařízení uživateli v domácnosti v zemích EU Tato značka na produktu nebo na jeho obalu označuje, že tento produkt nesmí být likvidován prostým vyhozením do běžného domovního odpadu. Odpovídáte za to, že vysloužilé zařízení bude předáno k likvidaci do stanovených sběrných míst určených k recyklaci vysloužilých elektrických a elektronických zařízení. Likvidace vysloužilého zařízení samostatným sběrem a recyklací napomáhá zachování přírodních zdrojů a zajišťuje, že recyklace proběhne způsobem chránícím lidské zdraví a životní prostředí. Další informace o tom, kam můžete vysloužilé zařízení předat k recyklaci, můžete získat od úřadů místní samosprávy, od společnosti provádějící svoz a likvidaci domovního odpadu nebo v obchodě, kde jste produkt zakoupili.</p>
Danish	<p>Bortskaffelse af affaldsudstyr for brugere i private husholdninger i EU Dette symbol på produktet eller på dets emballage indikerer, at produktet ikke må bortskaffes sammen med andet husholdningsaffald. I stedet er det dit ansvar at bortskaffe affaldsudstyr ved at aflevere det på dertil beregnede indsamlingssteder med henblik på genbrug af elektrisk og elektronisk affaldsudstyr. Den separate indsamling og genbrug af dit affaldsudstyr på tidspunktet for bortskaffelse er med til at bevare naturlige ressourcer og sikre, at genbrug finder sted på en måde, der beskytter menneskets helbred samt miljøet. Hvis du vil vide mere om, hvor du kan aflevere dit affaldsudstyr til genbrug, kan du kontakte kommunen, det lokale renovationsvesen eller den forening, hvor du købte produktet.</p>
Netherlands	<p>Afvoer van afgedankte apparatuur door gebruikers in particuliere huishoudens in de Europese Unie Dit symbool op het product of de verpakking geeft aan dat dit product niet mag worden afgevoerd met het huishoudelijk afval. Het is uw verantwoordelijkheid uw afgedankte apparatuur af te leveren op een aangewezen inzamelingspunt voor de verwerking van afgedankte elektrische en elektronische apparatuur. De gescheiden inzameling en verwerking van uw afgedankte apparatuur draagt bij tot het sparen van natuurlijke bronnen en tot het hergebruik van materiaal op een wijze die de volksgezondheid en het milieu beschermt. Voor meer informatie over waar u uw afgedankte apparatuur kunt inleveren voor recycling kunt u contact opnemen met het gemeentehuis in uw woonplaats, de reinigingsdienst of de winkel waar u het product hebt aangeschaft.</p>
Norwegian	<p>Ernæringsmidleres kasuttsett körvaldatavate seadmte käitlemine Euroopa Liidus Kui tootel või toote pakendil on see sümbol, ei tohi seda toodet viata olmejäätmete hulka. Teie kohus on viia tarbetuks muutunud seade selleks ettenähtud elektri- ja elektroonikaseadmte utiliseerimiskohale. Utiliseerivate seadmte eraldi kogumise ja käitlemine aitab säilita loodusvarasid ning tagada, et käitlemine toimub inimeste tervisele ja keskkonnale ohutult. Lisateavete selle kohta, kuhu saate utiliseeritava seadmte käitlemiseks viia, saate küsida kohalikut omavalitsust, olmejäätmete utiliseerimispunkti või kauplust, kust te seadme ostsite.</p>
Estonian	<p>Hävitettävien laitteiden käsittely kotitalouksissa Euroopan unionin alueella Tämä tuotteen tai sen pakkausosassa oleva merkintä osoittaa, että tuotetta ei saa hävittää talousjätteen mukana. Käyttäjän velvollisuus on huolehtia siitä, että hävitettävä laite toimitetaan sähkö- ja elektroniikkalaitteiden keräyspisteeseen. Hävitettävien laitteiden erillinen keräys ja käsittely säästää luonnonvaroja. Näin toimimalla varmistetaan myös, että käsittely tapahtuu tavalla, joka suojaa ihmisten terveyttä ja ympäristöä. Saat tarvittaessa lisätietoja jätteen keräilypaikoista paikallisista viranomaisilta, jätehuoltajalta tai tuotteen jälleenympäristä.</p>
Swedish	<p>Απορριψη χρηστων συσκευων στην Ευρωπαϊκη Ένωση Το παρον σύμβολο στον εξοπλισμο ή τη συσκευασία του υποδεικνύει ότι το προϊόν αυτό δεν πρέπει να πεταχτεί μαζί με άλλα οικιακά απορρίμματα. Αντίθετα, ευθύνη σας είναι να απορρίψετε τις χρηστές συσκευές σε μια καθορισμένη μονάδα συλλογής απορριμμάτων για την ανακύκλωση χρηστων ηλεκτρικών και ηλεκτρονικών εξοπλισμών. Η χωριστή συλλογή και ανακύκλωση των χρηστων συσκευων θα συμβάλει στη διατήρηση των φυσικών πόρων και στη διασφάλιση ότι θα ανακυκλωθούν με τέτοιο τρόπο, ώστε να προστατεύεται η υγεία των ανθρώπων και το περιβάλλον. Για περισσότερες πληροφορίες σχετικά με το πού μπορείτε να απορρίψετε τις χρηστές συσκευές για ανακύκλωση, επικοινωνήστε με τις κατά τόπους αρμόδιες αρχές ή με το κοινοτικό από το οποίο αγοράσατε το προϊόν.</p>
Latvian	<p>A hulladékanyagok kezelése a magánháztartásokban az Európai Unióban Ez a szimbólum, amely a termék vagy annak csomagolásán van feltüntetve, azt jelzi, hogy a termék nem kezelhető együtt az egyéb háztartási hulladékkal. Az Ön feladata, hogy a készült hulladékanyagait eljuttassa olyan kijelölt gyűjtőhelyre, amely az elektromos hulladékanyagok és elektronikus berendezések újrahasznosítását foglalkozik. A hulladékanyagok elkülönített gyűjtése és újrahasznosítása hozzájárul a természeti erőforrások megőrzéséhez, egyúttal az is biztosítja, hogy a hulladék újrahasznosítása az egészségre és a környezetre nem ártalmas módon történjen. Ha tájékoztatást szeretne kapni azokról a helyekről, ahol leadhatja újrahasznosításra a hulladékanyagokat, forduljon a helyi önkormányzathoz, a háztartási hulladék begyűjtésével foglalkozó vállalatához vagy a termék forgalmazójához.</p>
Lithuanian	<p>Lietauto atbriviolanas no nederigām ierīcēm Eiropas Savienības privātajās mājāsniecībās Šis simbols uz ierīces vai tās iepakojuma norāda, ka šo ierīci nedrīkst izmest kopā ar pārējiem mājāsniecības atkritumiem. Jūs esat atbildīgs par atbriviolanos no nederīgās ierīces, to nododot norādītajā savākšanas vietā, lai tā tiktu veikta nederīgu elektriskā un elektroniskā aprīkojuma atbriviolana. Speciāla nederīgās ierīces savākšana un atbriviolana palīdz taupīt dabas resursus un nodrošina tīdu atbriviolanu pārstrādi, kas sagūā cilvēku veselību un apkārtējā vidi. Lai iegūtu paprdu informāciju par to, kur atbriviolāt pārstrādi vai nogādāt nederīgu ierīci, lūdz, sazinieties ar vietējo pašvaldību, mājāsniecības atkritumu savākšanas dienestu vai veikalu, kust iegādājāties šo ierīci.</p>
Latvian	<p>Europos Sąjungos vartotojų ir privačių namų ūkių atliekamasis įrangos išmetimas Šis simbolis ant produkto arba jo pakuotės nurodo, kad produktas negali būti išmestas kartu su kitomis namų ūkiu atliekomis. Jūs privalote išmesti savo atliekamą įrangą atitinkamą į ją atliekamą elektronikos ir elektrinės įrangos perdirbimo punktus. Jei atliekamą įrangą bus atskirai surenkama ir perdirbama, bus išsaugomi natūralūs išteklių ir atliekama, kad įrangą yra perdirbta žmogaus sveikatai ir gamtą tausojančiu būdu. Dėl informacijos apie tai, kur galite išmesti atliekamą perdirbti skirtą įrangą kreipkitės į atliekamą vietos tarnybą, namų ūkiu atliekų išvežimo tarnybą arba į parduotuvę, kurioje pirkote produktą.</p>
Polish	<p>Utilização do utilizado separado para utilização de resíduos domésticos em Unia Europeia Este símbolo em o produto ou na embalagem indica que o produto não pode ser descartado com o lixo doméstico. No entanto, é sua responsabilidade levar os equipamentos a serem descartados a um ponto de coleta designado para a reciclagem de equipamentos eletro-eletrônicos. A coleta separada e a reciclagem dos equipamentos no momento do descarte ajudam na conservação dos recursos naturais e garantem que os equipamentos serão reciclados de forma a proteger a saúde das pessoas e o meio ambiente. Para obter mais informações sobre onde descartar equipamentos para reciclagem, entre em contato com o escritório local de sua cidade, o serviço de limpeza pública de seu bairro ou a loja em que adquiriu o produto.</p>
Portuguese	<p>Postup používateľov v krajínach Európskej únie pri vyhazovaní zariadenia v domácom používaní do odpadu Tento symbol na produkte alebo na jeho obale znamená, že nesmie byť vyhodený s inými komunálnymi odpadmi. Na miesto toho máte povinnos odovzdať toto zariadenie na zbernóm mieste, kde sa zabezpečuje recyklácia elektrických a elektronických zariadení. Separovaný zber a recyklácia zariadenia určeného na odpad pomôže chráni prírodné zdroje a zabezpečí taký spôsob recyklácie, ktorý bude chráni ľudské zdravie a životné prostredie. Ďalšie informácie o separovanom zbere a recyklácii získate na miestnom obecnom úrade, vo firme zabezpečujúcej zber vášho komunálneho odpadu alebo v predajni, kde ste produkt kúpili.</p>
Slovak	<p>Ramjanje z odpadno opremo v gospodinjstvih znotaj Evropske unije Ta znak na izdelku ali embalaži izdelka pomeni, da izdelka ne smete odlagati skupaj z drugimi gospodinjstvenimi odpadki. Odpadno opremo ste dolžni oddati na določenem zbirnem mestu za recikliranje odpadne električne in elektronske opreme. Z ločenim zbiranjem in recikliranjem odpadne opreme bo odlaganje opreme boste pomagali ohraniti naravne vire in zagotovili, da bo odpadna oprema reciklirana tako, da se varuje zdravje ljudi in okolje. Več informacij o mestih, kjer lahko oddate odpadno opremo za recikliranje, lahko dobite na občini, v komunalnem podjetju ali trgovini, kjer ste izdelek kupili.</p>
Slovenian	<p>Kassering av förbrukningsmaterial, för hem- och privatvårdare i EU Produkter eller produktförpackningar med den här symbolen får inte kasseras med vanligt hushållsaffall. I stället har du ansvar för att produkten lämnas till en behörig återvinningstation för hantering av el- och elektronikkprodukter. Genom att lämna kasserade produkter till återvinning hjälper du till att bevara våra gemensamma naturresurser. Dessutom skyddas både människor och miljön när produkter återvinns på rätt sätt. Kommunala myndigheter, sophanteringsföretag eller butiken där varan köptes kan ge mer information om var du lämnar kasserade produkter för återvinning.</p>
Croatian	<p>Postup používateľov v krajínach Európskej únie pri vyhazovaní zariadenia v domácom používaní do odpadu Tento symbol na produkte alebo na jeho obale znamená, že nesmie byť vyhodený s inými komunálnymi odpadmi. Na miesto toho máte povinnos odovzdať toto zariadenie na zbernóm mieste, kde sa zabezpečuje recyklácia elektrických a elektronických zariadení. Separovaný zber a recyklácia zariadenia určeného na odpad pomôže chráni prírodné zdroje a zabezpečí taký spôsob recyklácie, ktorý bude chráni ľudské zdravie a životné prostredie. Ďalšie informácie o separovanom zbere a recyklácii získate na miestnom obecnom úrade, vo firme zabezpečujúcej zber vášho komunálneho odpadu alebo v predajni, kde ste produkt kúpili.</p>

Chemical Substances

HP is committed to providing our customers with information about the chemical substances in our products as needed to comply with legal requirements such as REACH (*Regulation EC No 1907/2006 of the European Parliament and the Council*). A chemical information report for this product can be found at: www.hp.com/go/reach.

Toxic and hazardous substance table (China)

有毒有害物质表						
根据中国《电子信息产品污染控制管理办法》						
零件描述	有毒有害物质和元素					
	铅	汞	镉	六价铬	多溴联苯	多溴联苯醚
外壳和托盘*	0	0	0	0	0	0
电线*	0	0	0	0	0	0
印刷电路板*	X	0	0	0	0	0
打印系统*	X	0	0	0	0	0
显示器*	X	0	0	0	0	0
喷墨打印机墨盒*	0	0	0	0	0	0
驱动光盘*	X	0	0	0	0	0
扫描仪*	X	X	0	0	0	0
网络配件*	X	0	0	0	0	0
电池板*	X	0	0	0	0	0
自动双面打印系统*	0	0	0	0	0	0
外部电源*	X	0	0	0	0	0

0: 指此部件的所有均一材质中包含的这种有毒有害物质, 含量低于SJ/T11363-2006 的限制
 X: 指此部件使用的均一材质中至少有一种包含的这种有毒有害物质, 含量高于SJ/T11363-2006 的限制
 注: 环保使用期限的参考标识取决于产品正常工作的温度和湿度等条件
 *以上只适用于使用这些部件的产品

Restriction of hazardous substance (Ukraine)

Технічний регламент щодо обмеження використання небезпечних речовин (Україна)

Обладнання відповідає вимогам Технічного регламенту щодо обмеження використання деяких небезпечних речовин в електричному та електронному обладнанні, затвердженого постановою Кабінету Міністрів України від 3 грудня 2008 № 1057

Battery disposal in the Netherlands



Dit HP Product bevat een lithium-manganese-dioxide batterij. Deze bevindt zich op de hoofdprintplaat. Wanneer deze batterij leeg is, moet deze volgens de geldende regels worden afgevoerd.

Battery disposal in Taiwan



廢電池請回收

Please recycle waste batteries.

California Perchlorate Material Notice

California Perchlorate Material Notice

Perchlorate material - special handling may apply. See: <http://www.dtsc.ca.gov/hazardouswaste/perchlorate/>

This product's real-time clock battery or coin cell battery may contain perchlorate and may require special handling when recycled or disposed of in California.

EU battery directive



English	<p>European Union Battery Directive This product contains a battery that is used to maintain data integrity of real time clock or product settings and is designed to last the life of the product. Any attempt to service or replace this battery should be performed by a qualified service technician.</p>
French	<p>Directive sur les batteries de l'Union Européenne Ce produit contient une batterie qui permet de maintenir l'intégrité des données pour les paramètres du produit ou l'horloge en temps réel et qui a été conçue pour durer aussi longtemps que le produit. Toute tentative de réparation ou de remplacement de cette batterie doit être effectuée par un technicien qualifié.</p>
German	<p>Batterie-Richtlinie der Europäischen Union Dieses Produkt enthält eine Batterie, die dazu dient, die Datenintegrität der Echtzeituhr sowie der Produkteinstellungen zu erhalten, und die für die Lebensdauer des Produkts ausreicht. Im Bedarfsfall sollte das Instandhalten bzw. Austauschen der Batterie von einem qualifizierten Servicetechniker durchgeführt werden.</p>
Italian	<p>Direttiva dell'Unione Europea relativa alla raccolta, al trattamento e allo smaltimento di batterie e accumulatori Questo prodotto contiene una batteria utilizzata per preservare l'integrità dei dati dell'orologio in tempo reale o delle impostazioni del prodotto e la sua durata si intende pari a quella del prodotto. Eventuali interventi di riparazione o sostituzione della batteria devono essere eseguiti da un tecnico dell'assistenza qualificato.</p>
Spanish	<p>Directiva sobre baterías de la Unión Europea Este producto contiene una batería que se utiliza para conservar la integridad de los datos del reloj de tiempo real o la configuración del producto y está diseñada para durar toda la vida útil del producto. El mantenimiento o la sustitución de dicha batería deberá realizarla un técnico de mantenimiento cualificado.</p>
Czech	<p>Směrnice Evropské unie pro nakládání s bateriemi Tento výrobek obsahuje baterii, která slouží k uchování správných dat hodin reálného času nebo nastavení výrobku. Baterie je navržena tak, aby vydržela celou životnost výrobku. Jakýkoliv pokus o opravu nebo výměnu baterie by měl provést kvalifikovaný servisní technik.</p>
Dutch	<p>EU's batteriedirectiv Produktet indeholder et batteri, som bruges til at vedligeholde dataintegriteten for realtidur eller produktindstillinger og er beregnet til at holde i hele produktets levetid. Service på batteriet eller udskiftning bør foretages af en uddannet servicetekniker.</p>
Netherlands	<p>Richtlijn batterijen voor de Europese Unie Dit product bevat een batterij die wordt gebruikt voor een juiste tijdsaanwijzing van de klok en het behoud van de productinstellingen. Bovendien is deze ontworpen om gedurende de levensduur van het product mee te gaan. Het onderhoud of de vervanging van deze batterij moet door een gekwalificeerde onderhoudstechnicus worden uitgevoerd.</p>
Eesti	<p>Euroopa Liidu aku direktiiv Toode sisaldab akut, mida kasutatakse reaaja kella andmeühitsuse või toote sätete säilitamiseks. Aku on valmistatud kestma terve toote kasutusaja. Akut tohib hooldada või vahetada ainult kvalifitseeritud hooldustehnik.</p>
Finnish	<p>Euroopan unionin paristodirektiivi Tämä laite sisältää pariston, jota käytetään reaaliaikaisen kellon tietojen ja laitteen asetusten säilyttämiseen. Pariston on suunniteltu kestäväin laitteen koko käyttöajan ajan. Pariston mahdollinen korjaus tai vaihto on jätettävä päteväin huoltohenkilön tehtäväksi.</p>
Slovene	<p>Οδηγία της Ευρωπαϊκής Ένωσης για τις ηλεκτρικές στήλες Αυτό το προϊόν περιλαμβάνει μια μπαταρία, η οποία χρησιμοποιείται για τη διατήρηση της ακριβείας των δεδομένων ρολογιού πραγματικού χρόνου ή των ρυθμίσεων προϊόντος και έχει σχεδιαστεί έτσι ώστε να διαρκέσει όσο και το προϊόν. Τυχόν απόπειρες επιδιόρθωσης ή αντικατάστασης αυτής της μπαταρίας θα πρέπει να πραγματοποιούνται από κατάλληλα εκπαιδευμένο τεχνικό.</p>
Magyar	<p>Az Európai unió telepek és akkumulátorok direktívája A termék tartalmaz egy elemet, melynek feladata az, hogy biztosítsa a valós idejű óra vagy a termék beállításainak adatintegritását. Az elem úgy van tervezve, hogy végig kitartson a termék használatá során. Az elem bármilyen javítását vagy cseréjét csak képzett szakember végezheti el.</p>
Lithuanian	<p>Europos Sąveien baterijų direktyva Produktam ir baterija, ko izmanto realią laiką pulkstei vai produkta iestatījumu datu integritātes saglabāšanai, un tā ir paredzēta visam produkta dzīves ciklam. Jebkura apkope vai baterijas nomainīšana ir jāveic atbilstoši kvalificētam darbiniekam.</p>
Latvian	<p>Europos Sąjungos baterijų ir akumuliatorių direktyva Šiame gaminyje yra baterija, kuri naudojama, kad būtų galima prižiūrėti realaus laiko laikrodžio veikimą arba gaminio nuostatą; ji skirta veikti visą gaminio eksploatavimo laiką. Bet kokius šios baterijos aptarnavimo arba keitimo darbus turi atlikti kvalifikuotas aptarnavimo technikas.</p>
Polish	<p>Dyrektywa Unii Europejskiej w sprawie baterii i akumulatorów Produkt zawiera baterię wykorzystywaną do zachowania integralności danych zegara czasu rzeczywistego lub ustawień produktu, która podtrzymuje działanie produktu. Przegląd lub wymiana baterii powinny być wykonywane wyłącznie przez uprawnionego technika serwisu.</p>
Portuguese	<p>Directiva sobre baterias da União Europeia Este produto contém uma bateria que é usada para manter a integridade dos dados do relógio em tempo real ou das configurações do produto e é projetada para ter a mesma duração que este. Qualquer tentativa de consertar ou substituir essa bateria deve ser realizada por um técnico qualificado.</p>
Slovak	<p>Smernica Európskej únie pre zaobchádzanie s batériami Tento výrobok obsahuje batériu, ktorá slúži na uchovanie správnych údajov hodín reálneho času alebo nastavení výrobku. Batéria je skonštruovaná tak, aby vydržala celú životnosť výrobku. Akýkoľvek pokus o opravu alebo výmenu batérie by mal vykonať kvalifikovaný servisný technik.</p>
Slovenian	<p>Directiva Evropske unije o baterijah in akumulatorjih V tem izdelku je baterija, ki zagotavlja natančnost podatkov ure v realnem času ali nastavitev izdelka v celotni življenjski dobi izdelka. Kakršno koli popravilo ali zamenjava te baterije lahko izvede le pooblaščen tehnik.</p>
Swedish	<p>EU:s batteridirektiv Produkten innehåller ett batteri som används för att upprätthålla data i realtidsklockan och produktinställningarna. Batteriet ska räkna produktens hela livslängd. Endast kvalificerade servicetekniker får utföra service på batteriet och byta ut det.</p>
Bulgarian	<p>Директива за батерии на Европейския съюз Този продукт съдържа батерия, която се използва за поддържане на целостта на данните на часовника в реално време или настройките за продукта, създадена на издръжливост през целия живот на продукта. Сервизът или замяната на батерията трябва да се извършва от квалифициран техник.</p>
Romanian	<p>Directiva Uniunii Europene referitoare la baterii Acest produs conține o baterie care este utilizată pentru a menține integritatea datelor ceasului de timp real sau setărilor produsului și care este proiectată să funcționeze pe întreaga durată de viață a produsului. Orice lucrare de service sau de înlocuire a acestei baterii trebuie efectuată de un tehnician de service calificat.</p>

Auto Power-Off

Auto Power-Off is automatically enabled by default when you turn on the printer. When Auto Power-Off is enabled, the printer will automatically turn off after two hours of inactivity to help reduce energy use. Auto Power-Off is automatically disabled when the printer establishes a wireless or Ethernet (if supported) network connection. You can change the Auto Power-Off setting from the control panel. Once you change the setting, the printer will maintain the setting that you choose. **Auto Power-Off turns the printer off completely, so you must use the power button to turn the printer back on.**

To enable or disable Auto Power-Off

1. From the Home screen, touch the **Settings** icon.



2. Touch **Preferences**.
3. Touch the down arrow button to scroll through the options, and then touch **Auto-Off**.
4. Touch **Enabled** or **Disabled**.

 **TIP:** If you are printing through a wireless or Ethernet connection over a network, Auto Power-Off should be disabled to ensure that print jobs do not get lost. Even when Auto Power-Off is disabled, the printer enters a Sleep mode after five minutes of inactivity to help reduce energy use.

Sleep mode

- Power usage is reduced while in the Sleep mode.
- After initial setup of printer, the printer will enter the Sleep mode after five minutes of inactivity.
- The time to the Sleep mode can be changed from the control panel.

To set the Sleep mode time

1. From the Home screen, touch the **Settings** icon.



2. Touch **Preferences**.
3. Touch the down arrow to scroll through the options, and then touch **Sleep Mode**.
4. Touch **After 5 minutes** or **After 10 minutes**, or **After 15 minutes**.

Regulatory notices

The HP Photosmart meets product requirements from regulatory agencies in your country/region.

This section contains the following topics:

- [Regulatory model identification number](#)
- [FCC statement](#)
- [VCCI \(Class B\) compliance statement for users in Japan](#)
- [Notice to users in Japan about the power cord](#)
- [Notice to users in Korea](#)
- [Notice to users in Germany](#)
- [Noise emission statement for Germany](#)
- [European Union Regulatory Notice](#)

Regulatory model identification number

For regulatory identification purposes, your product is assigned a Regulatory Model Number. The Regulatory Model Number for your product is SNPRH-1103. This regulatory number should not be confused with the marketing name (**HP Photosmart 5520 e-All-in-One Printer**, etc.) or product numbers (CX042A, etc.).

FCC statement

FCC statement

The United States Federal Communications Commission (in 47 CFR 15.105) has specified that the following notice be brought to the attention of users of this product.

This equipment has been tested and found to comply with the limits for a Class B digital device, pursuant to Part 15 of the FCC Rules. These limits are designed to provide reasonable protection against harmful interference in a residential installation. This equipment generates, uses and can radiate radio frequency energy and, if not installed and used in accordance with the instructions, may cause harmful interference to radio communications. However, there is no guarantee that interference will not occur in a particular installation. If this equipment does cause harmful interference to radio or television reception, which can be determined by turning the equipment off and on, the user is encouraged to try to correct the interference by one or more of the following measures:

- Reorient the receiving antenna.
- Increase the separation between the equipment and the receiver.
- Connect the equipment into an outlet on a circuit different from that to which the receiver is connected.
- Consult the dealer or an experienced radio/TV technician for help.

For further information, contact:

Manager of Corporate Product Regulations
 Hewlett-Packard Company
 3000 Hanover Street
 Palo Alto, Ca 94304
 (650) 857-1501

Modifications (part 15.21)

The FCC requires the user to be notified that any changes or modifications made to this device that are not expressly approved by HP may void the user's authority to operate the equipment.

This device complies with Part 15 of the FCC Rules. Operation is subject to the following two conditions: (1) this device may not cause harmful interference, and (2) this device must accept any interference received, including interference that may cause undesired operation.

VCCI (Class B) compliance statement for users in Japan

この装置は、クラスB情報技術装置です。この装置は、家庭環境で使用することを目的としていますが、この装置がラジオやテレビジョン受信機に近接して使用されると、受信障害を引き起こすことがあります。取扱説明書に従って正しい取り扱いをして下さい。

VCCI-B

Notice to users in Japan about the power cord

製品には、同梱された電源コードをお使い下さい。
 同梱された電源コードは、他の製品では使用出来ません。

Notice to users in Korea

B 급 기기
 (가정용 방송통신기기)

이 기기는 가정용(B급)으로 전자파적합등록을 한 기기로서 주로 가정에서 사용하는 것을 목적으로 하며, 모든 지역에서 사용할 수 있습니다.

Notice to users in Germany

GS-Erklärung (Deutschland)

Das Gerät ist nicht für die Benutzung im unmittelbaren Gesichtsfeld am Bildschirmarbeitsplatz vorgesehen. Um störende Reflexionen am Bildschirmarbeitsplatz zu vermeiden, darf dieses Produkt nicht im unmittelbaren Gesichtsfeld platziert werden.

Noise emission statement for Germany

Geräuschemission

LpA < 70 dB am Arbeitsplatz im Normalbetrieb nach DIN 45635 T. 19

European Union Regulatory Notice

Products bearing the CE marking comply with the following EU Directives:

- Low Voltage Directive 2006/95/EC
- EMC Directive 2004/108/EC
- Ecodesign Directive 2009/125/EC, where applicable



CE compliance of this product is valid only if powered with the correct CE-marked AC adapter provided by HP.

If this product has telecommunications functionality, it also complies with the essential requirements of the following EU Directive:

- R&TTE Directive 1999/5/EC

Compliance with these directives implies conformity to applicable harmonized European standards (European Norms) that are listed in the EU Declaration of Conformity issued by HP for this product or product family and available (in English only) either within the product documentation or at the following web site: www.hp.com/go/certificates (type the product number in the search field).

The compliance is indicated by one of the following conformity markings placed on the product:

	<p>For non-telecommunications products and for EU harmonized telecommunications products, such as Bluetooth® within power class below 10mW.</p>
	<p>For EU non-harmonized telecommunications products (If applicable, a 4-digit notified body number is inserted between CE and !).</p>

Please refer to the regulatory label provided on the product.

The telecommunications functionality of this product may be used in the following EU and EFTA countries: Austria, Belgium, Bulgaria, Cyprus, Czech Republic, Denmark, Estonia, Finland, France, Germany, Greece,

Hungary, Iceland, Ireland, Italy, Latvia, Liechtenstein, Lithuania, Luxembourg, Malta, Netherlands, Norway, Poland, Portugal, Romania, Slovak Republic, Slovenia, Spain, Sweden, Switzerland, and United Kingdom.

The telephone connector (not available for all products) is intended for connection to analogue telephone networks.

Products with wireless LAN devices

- Some countries may have specific obligations or special requirements about the operation of Wireless LAN networks such as indoor use only or restrictions of the channels available. Please make sure that the country settings of the wireless network are correct.

France

- For 2.4-GHz Wireless LAN operation of this product, certain restrictions apply: This product may be used indoors for the entire 2400-MHz to 2483.5-MHz frequency band (channels 1 to 13). For outdoor use, only the 2400-MHz to 2454-MHz frequency band (channels 1 to 7) may be used. For the latest requirements, see www.arcep.fr.

The point of contact for regulatory matters is:

Hewlett-Packard GmbH, Dept./MS: HQ-TRE, Herrenberger Strasse 140, 71034 Boeblingen, GERMANY

Regulatory wireless statements

This section contains the following regulatory information pertaining to wireless products:

- [Exposure to radio frequency radiation](#)
- [Notice to users in Brazil](#)
- [Notice to users in Canada](#)
- [Notice to users in Taiwan](#)

Exposure to radio frequency radiation

Exposure to radio frequency radiation



Caution The radiated output power of this device is far below the FCC radio frequency exposure limits. Nevertheless, the device shall be used in such a manner that the potential for human contact during normal operation is minimized. This product and any attached external antenna, if supported, shall be placed in such a manner to minimize the potential for human contact during normal operation. In order to avoid the possibility of exceeding the FCC radio frequency exposure limits, human proximity to the antenna shall not be less than 20 cm (8 inches) during normal operation.

Notice to users in Brazil

Aviso aos usuários no Brasil

Este equipamento opera em caráter secundário, isto é, não tem direito à proteção contra interferência prejudicial, mesmo de estações do mesmo tipo, e não pode causar interferência a sistemas operando em caráter primário. (Res.ANATEL 282/2001).

Notice to users in Canada

Notice to users in Canada/Note à l'attention des utilisateurs canadiens

For Indoor Use. This digital apparatus does not exceed the Class B limits for radio noise emissions from the digital apparatus set out in the Radio Interference Regulations of the Canadian Department of Communications. The internal wireless radio complies with RSS 210 and RSS GEN of Industry Canada.

Under Industry Canada regulations, this radio transmitter may only operate using an antenna of a type and maximum (or lesser) gain approved for the transmitter by Industry Canada. To reduce potential radio interference to other users, the antenna type and its gain should be so chosen that the equivalent isotropically radiated power (e.i.r.p.) is not more than that necessary for successful communication.

This device complies with Industry Canada licence-exempt RSS standard(s). Operation is subject to the following two conditions: (1) this device may not cause interference, and (2) this device must accept any interference, including interference that may cause undesired operation of the device.

Utiliser à l'intérieur. Le présent appareil numérique n'émet pas de bruit radioélectrique dépassant les limites applicables aux appareils numériques de la classe B prescrites dans le Règlement sur le brouillage radioélectrique édicté par le ministère des Communications du Canada. Le composant RF interne est conforme à la norme RSS-210 and RSS GEN d'Industrie Canada.

Conformément au Règlement d'Industrie Canada, cet émetteur radioélectrique ne peut fonctionner qu'avec une antenne d'un type et d'un gain maximum (ou moindre) approuvé par Industrie Canada. Afin de réduire le brouillage radioélectrique potentiel pour d'autres utilisateurs, le type d'antenne et son gain doivent être choisis de manière à ce que la puissance isotrope rayonnée équivalente (p.i.r.e.) ne dépasse pas celle nécessaire à une communication réussie.

Cet appareil est conforme aux normes RSS exemptes de licence d'Industrie Canada. Son fonctionnement dépend des deux conditions suivantes : (1) cet appareil ne doit pas provoquer d'interférences nuisibles et (2) doit accepter toutes interférences reçues, y compris des interférences pouvant provoquer un fonctionnement non souhaité de l'appareil.

Notice to users in Taiwan

低功率電波輻射性電機管理辦法

第十二條

經型式認證合格之低功率射頻電機，非經許可，公司、商號或使用者均不得擅自變更頻率、加大功率或變更設計之特性及功能。

第十四條

低功率射頻電機之使用不得影響飛航安全及干擾合法通信；經發現有干擾現象時，應立即停用，並改善至無干擾時方得繼續使用。

前項合法通信，指依電信法規定作業之無線電通信。低功率射頻電機須忍受合法通信或工業、科學及醫藥用電波輻射性電機設備之干擾。

Index

A

after the support period 41

B

buttons, control panel 6

C

control panel

buttons 6

features 6

copy

specifications 48

customer support

warranty 41

E

environment

Environmental product stewardship
program 49

environmental specifications 48

I

interface card 31, 32

N

network

interface card 31, 32

P

phone support 41

phone support period

period for support 41

print

specifications 48

R

recycle

ink cartridges 50

regulatory notices

regulatory model identification

number 54

wireless statements 57

S

scan

scan specifications 48

system requirements 48

T

technical information

copy specifications 48

environmental specifications 48

print specifications 48

scan specifications 48

system requirements 48

W

warranty 41

