



English

IMPORTANT: Follow these part replacement instructions:

- 1 Match the part you received to the illustration on the next page.
- 2 Go to the page number indicated (→ #) for that part.
- 3 Complete only the part replacement steps in that section.

Bahasa Indonesia

PENTING: Ikuti petunjuk penggantian berikut ini:

- 1 Samakan komponen yang Anda terima dengan gambar di halaman berikutnya.
- 2 Buka halaman yang ditunjukkan (→ #) untuk komponen tersebut.
- 3 Lakukan langkah-langkah penggantian yang tertera pada bagian tersebut.
- 4 Obavite samo korake izmjene dijela iz tog odlomka.

한국어

중요: 다음 부품 교체 지침을 따르십시오.

- 1 다음 페이지의 그림과 같은지 수령한 부품을 확인합니다.
- 2 해당 부품에 표시된 페이지 번호(→ #)로 이동합니다.
- 3 해당 부분의 부품 교체 절차만 완료합니다.

简体中文

重要提示: 请遵循以下部件更换指示:

- 1 确定您收到的部件与下一页中的图示相符。
- 2 转到指定页码 (→ #) 以参考该部件的说明。
- 3 完成该部分所述的部件更换步骤即可。

繁體中文

重要: 請遵照下列零件更換指示:

- 1 確定您收到的零件與下一頁中的圖示相符。
- 2 翻到指定頁碼 (→ #) 以參考該零件說明。
- 3 完成該節中的零件更換步驟即可。

日本語

重要:
部品を交換する場合は以下の指示に従ってください。

- 1 交換する部品を次のページの図と照らし合わせます。
- 2 その部品のページ (→ #) を開きます。
- 3 該当する部品交換手順のみを行います。

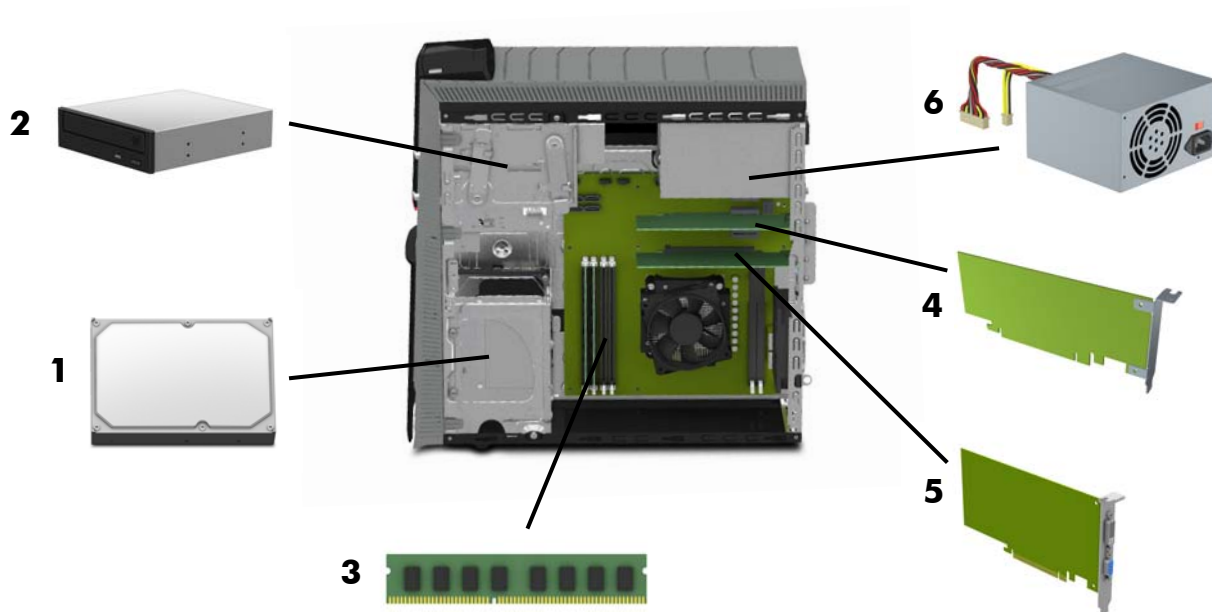

1 Hard Drive → **5**
 Drive hard disk
 하드 드라이브
 硬盘
 硬碟
 ハードドライブ

2 CD/DVD Drive → **11**
 Drive CD/DVD
 CD/DVD 드라이브
 CD/DVD 光驱
 CD/DVD 光碟機
 CD/DVD 드라이브

3 Memory Modules → **15**
 Modul memori
 메모리 모듈
 内存条
 記憶體模組
 メモリモジュール

4 Add-in Card → **19**
 Kartu Tambahan
 확장 카드
 扩充卡
 擴充卡
 追加カード

5 Graphics Card → **24**
 Kartu Grafis
 그래픽 카드
 图形卡
 顯示卡
 グラフィックスカード

6 Power Supply → **29**
 Catu Daya
 전원 공급장치
 电源
 電源供應器
 電源

English

WARNING:

- Keep your hands away from the moving fan.
- Keep fingers and tools clear of the fan when power is applied.
- Never open the cover with the power cord attached or power applied. You may damage your computer or be injured from the spinning fan blades.
- Avoid touching sharp edges inside the computer.
- If you disconnect the power connector for the liquid cooling system, ensure that it is reconnected prior to connecting power and turning on the computer. Failure to do so may result in damage to the cooling system and to the computer.

CAUTION: This product contains components that are easily damaged by electrostatic discharge (ESD). To reduce the chance of ESD damage, work over a non-carpeted floor, use a static dissipative work surface (like a conductive foam pad), and wear an ESD wrist strap that is connected to a grounded surface, like the metal frame of the computer.

IMPORTANT: A hard disk drive is extremely sensitive to shock and impact. Do not bang or drop it. Do not touch the circuit board. Static electricity can damage the drive.

The memory performance may vary due to different system configurations.

NOTE: Computer features may vary by model.

Bahasa Indonesia

PERINGATAN:

- Jauhkan tangan dari kipas yang sedang berputar.
- Jauhkan jari dan perkakas dari kipas ketika kipas terhubung ke listrik.
- Jangan pernah buka penutup kabel daya yang terpasang atau tersambung ke listrik. Komputer dapat rusak atau Anda terluka akibat putaran kipas.
- Jangan sentuh bagian yang berujung tajam di dalam komputer.
- Jika konektor daya dicabut dari sistem pendingin cair, pastikan konektor disambungkan kembali sebelum menyambungkan daya dan menyalakan komputer. Jika Anda tidak melakukannya maka dapat berakibat kerusakan pada sistem pendingin dan komputer.

AWAS: Produk ini mengandung komponen yang mudah rusak oleh medan elektrostatis (ESD). Untuk mengurangi kerusakan akibat ESD, kerjakan di lantai tanpa karpet, gunakan tempat kerja dengan permukaan yang menyerap medan listrik statis (seperti alas dengan bantalan busa konduktif), serta kenakan gelang tangan anti-statis ESD yang tersambung ke ground, seperti rangka komputer dari logam.

PENTING: Hard disk sangat sensitif terhadap guncangan dan benturan. Jangan lempar atau jatuhkan hard disk. Jangan sentuh bidang sirkuit. Listrik statis dapat merusak drive.

Kinerja memori dapat bervariasi tergantung konfigurasi sistem.

CATATAN: Fitur komputer dapat bervariasi tergantung model.

한국어



경고:

- 작동 중인 팬에 손을 대지 마십시오.
- 전원이 켜진 팬 주변에는 손가락이나 도구를 두지 마십시오.
- 전원 코드가 연결되어 있거나 전원이 켜져 있을 경우에는 절대로 덮개를 열지 마십시오. 회전 중인 팬 날개로 인해 컴퓨터가 손상되거나 사용자가 다칠 위험이 있습니다.
- 컴퓨터 내부의 날카로운 모서리를 만지지 마십시오.
- 액체 냉각 시스템의 전원 커넥터를 연결 해제한 경우 이를 먼저 연결한 후 전원을 연결하고 컴퓨터를 켜야 합니다. 이렇게 하지 않으면 냉각 시스템과 컴퓨터가 손상될 수 있습니다.



주의: 이 제품에는 정전기 방전(ESD)에 의해 쉽게 손상되는 구성 요소가 있습니다. ESD 손상의 가능성을 줄이려면, 카펫이 깔리지 않은 바닥에서 정전기가 분산되는 작업 표면(예: 전도성 스트로폼 패드)을 사용하고 컴퓨터의 금속 프레임과 같이 접지된 표면에 연결된 ESD 손목 보호대를 착용하고 작업합니다.

중요: 하드 디스크 드라이브는 충격에 매우 민감합니다. 부딪치거나 떨어뜨리지 마십시오. 회로 기판을 만지지 마십시오. 정전기는 드라이브를 손상시킬 수 있습니다.

메모리 성능은 시스템 구성에 따라 다를 수 있습니다.

참고: 컴퓨터 기능은 모델마다 다를 수 있습니다.

简体中文



警告：

- 请勿将手靠近正在旋转的风扇。
- 电脑接通电源时，请勿让手指或工具靠近风扇。
- 当电脑连接着电源线或接通电源时，请勿打开机箱盖。否则，正在旋转的风扇叶片可能会损坏电脑或使您受伤。
- 请勿碰触电脑内部的锋利边缘。
- 如果断开液体制冷系统的电源接头，请确保在连接电源并打开电脑前重新连接。否则，可能导致制冷系统和电脑损坏。



注意事项：本产品包含容易被静电放电 (Electrostatic Discharge, ESD) 所损坏的组件。为了降低发生 ESD 损坏的可能性，请在没有铺设地毯的地面进行操作，使用可耗散静电的工作台面（例如导电的泡棉垫），并佩戴与接地表面（例如电脑的金属外壳）相连的 ESD 腕带。

重要提示：硬盘驱动器很容易因震荡和碰撞而损坏。请勿摔掷或敲击驱动器。请勿触碰电路板。静电会损坏驱动器。

内存性能会因系配置不同而有所差异。

注：电脑的功能因型号而异。

繁體中文



警告：

- 雙手請勿靠近風扇。
- 供電時，請勿將手指與工具靠近風扇。
- 請勿在連接電源線或供電時開啟外蓋。旋轉的風扇葉片可能會損壞電腦或使您受傷。
- 請避免碰觸電腦內部銳利的邊緣。
- 如果您切斷水冷式散熱系統的電源，請確保在連接電源和開機前重新接上電源接頭。若沒有這樣做的話，可能會造成散熱系統和電腦損壞。



警告事項：本產品包含易於被靜電放電 (Electrostatic Discharge, ESD) 損毀的組件。若要減少靜電放電的損害，請在未鋪設地毯的地板上工作，使用防靜電的工作表面（例如導電泡棉墊），並戴上連接到地面（例如電腦金屬框）的靜電放電腕帶。

重要：硬碟對於震動和碰撞非常敏感。請勿摔落或碰撞光碟機。請勿碰觸電路板。靜電會損壞磁碟機。

記憶體效能會因不同系統設定而有所差異。

注意事項：電腦功能依型號而異。

日本語



警告：

- ファンに手を触れないでください。
- 電源が入っているときは、指や工具をファンに近づけないでください。
- 電源コードがコンセントに差し込まれているときや、電源が入っているときは、絶対にカバーを開かないでください。コンピューターを破損したり、回転しているファンで指に怪我をしたりするおそれがあります。
- コンピューター内部の尖った部分に触れないでください。
- 水冷システムの電源コネクタを取り外した場合は、コンピューターを外部電源に接続して電源を入れる前に、必ず接続しなおしてください。接続しなおせずにコンピューターの電源を入れると、冷却システムおよびコンピューター本体が損傷する可能性があります。



注意：お使いの製品には静電気で損傷しやすい部品が含まれています。静電気による損傷を防ぐには、絨毯の敷かれていない床に、静電気を消散させる作業台(伝導性のフォームパッドなど)を置いて作業します。さらに、コンピューターの金属製フレームなどの、接地された面に つなげた静電気防止用ストラップを装着します。

重要：ハードディスクは非常に衝撃に弱いいため、叩いたり落としたりしないでください。また、回路基盤に触れないでください。静電気によりドライブが損傷するおそれがあります。

メモリのパフォーマンスは、システム構成の違いによって異なる場合があります。

注：コンピューターの機能はモデルにより異なる場合があります。

Hard Drive

Drive hard disk

하드 드라이브
硬盘
硬碟
ハードドライブ

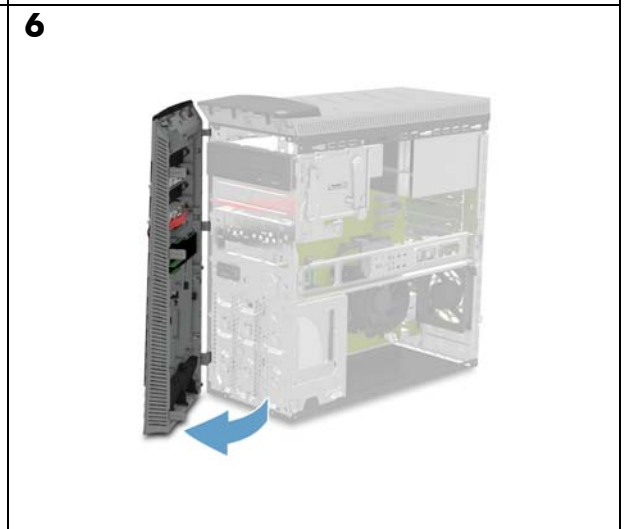
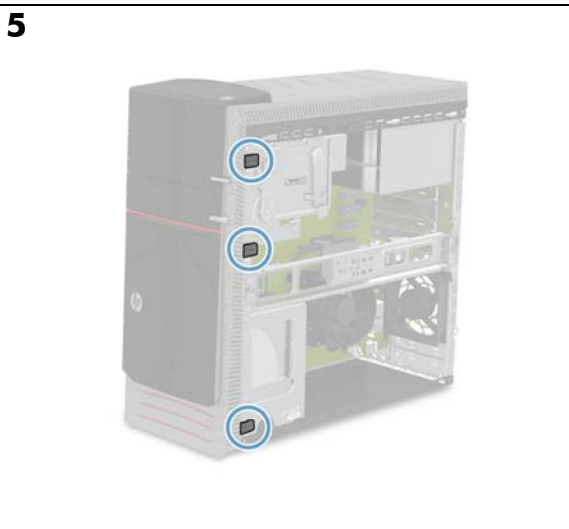
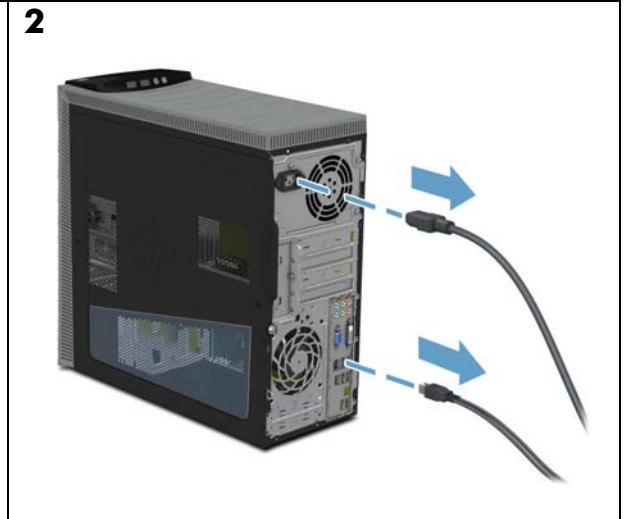
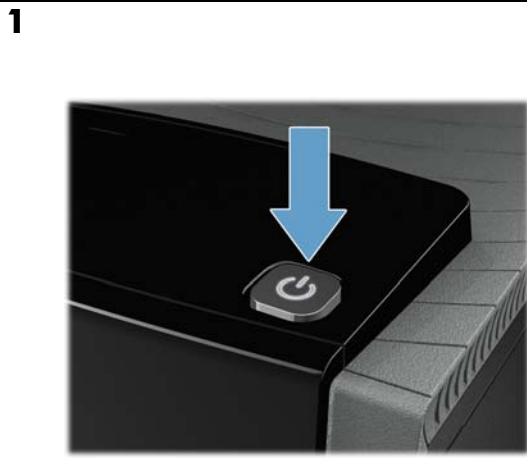

Hard Drive

Drive hard disk

하드 드라이브
硬盘
硬碟
ハードドライブ

7



8



9

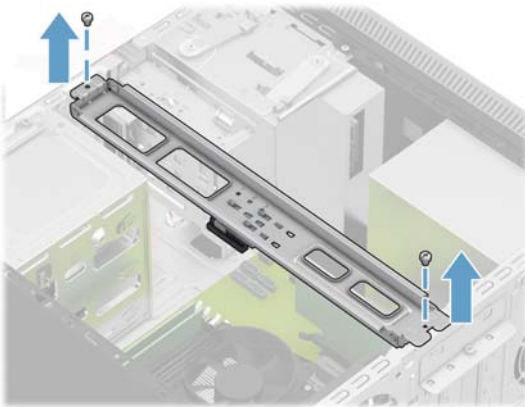

10

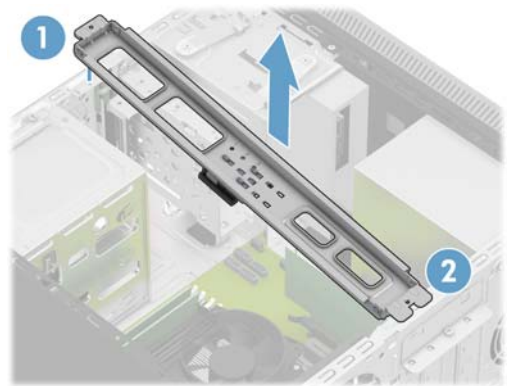

11



12

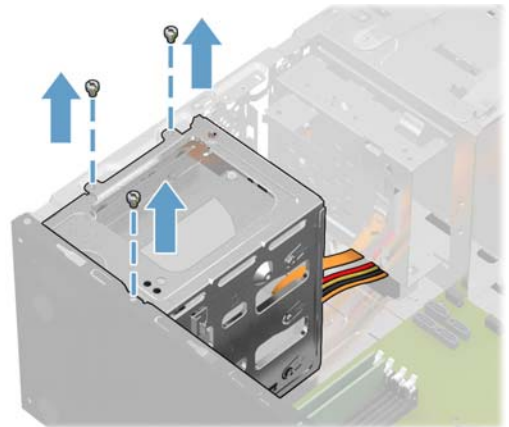

Hard Drive

Drive hard disk

하드 드라이브
硬盘
硬碟
ハードドライブ

13

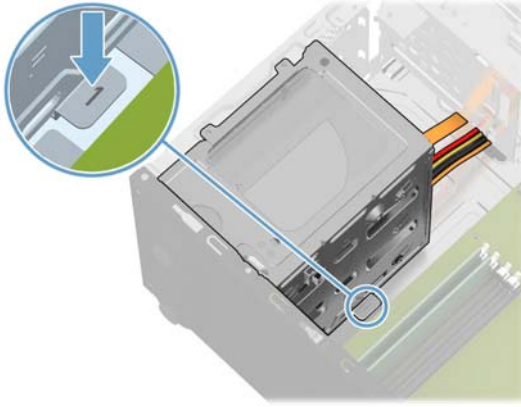

14

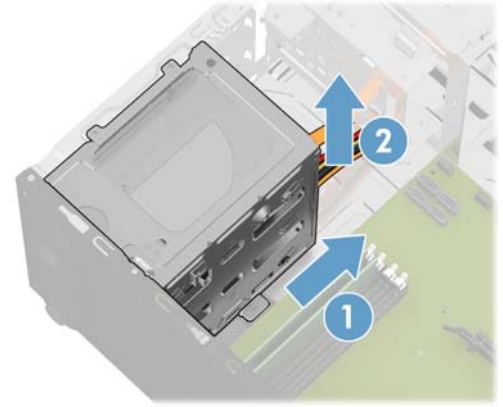

15

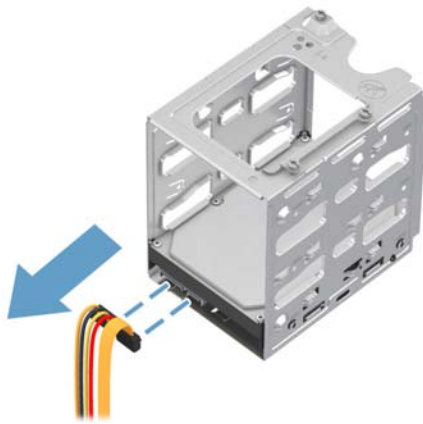

16

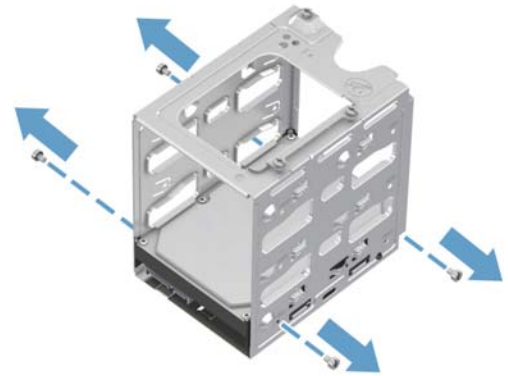

17

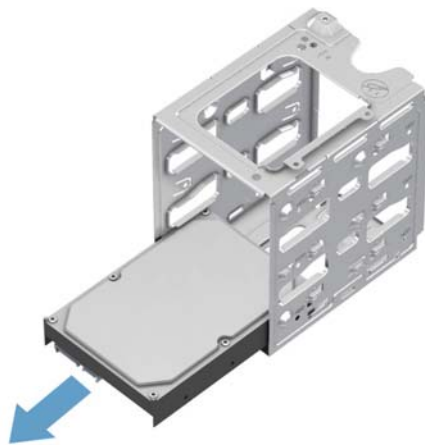

18

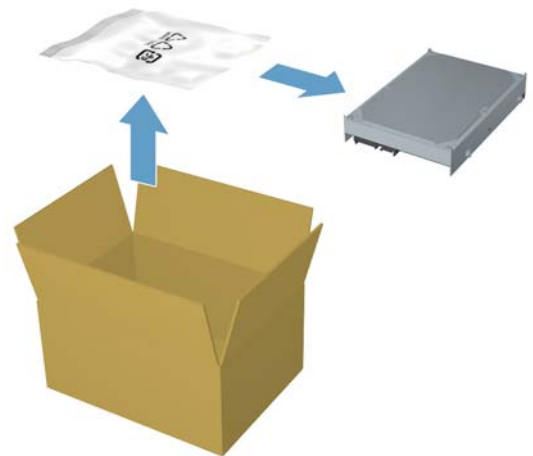

Hard Drive

Drive hard disk

하드 드라이브
硬盘
硬碟
ハードドライブ

19

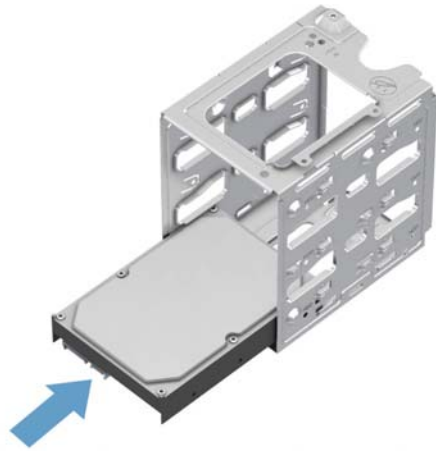

20

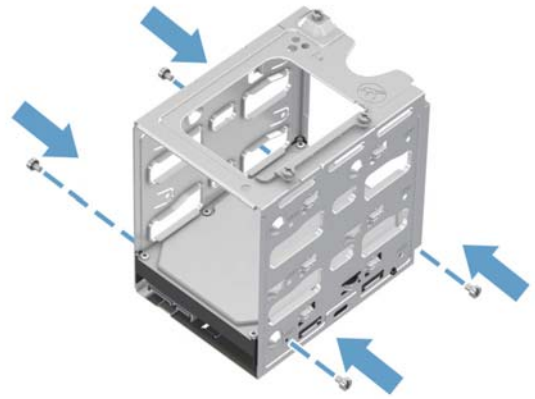

21

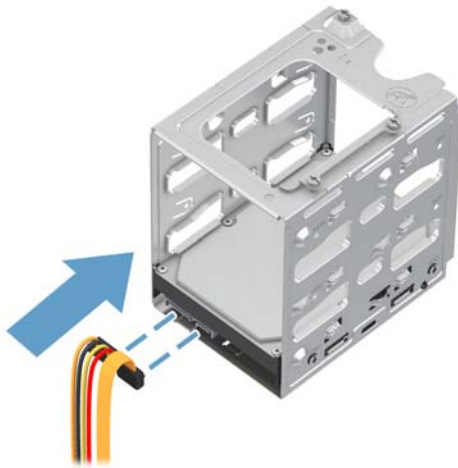

22

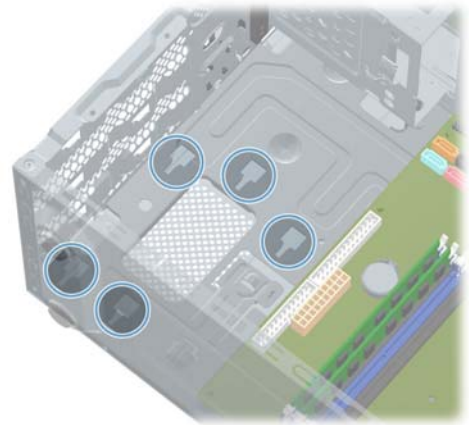

23

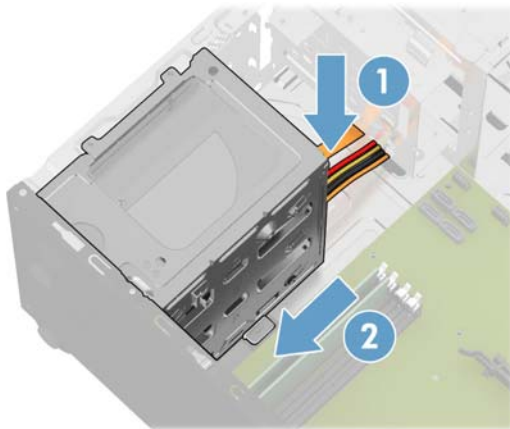

24

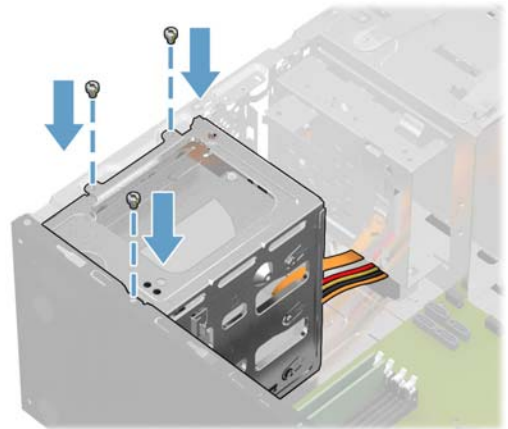

Hard Drive

Drive hard disk

하드 드라이브
硬盘
硬碟
ハードドライブ

25

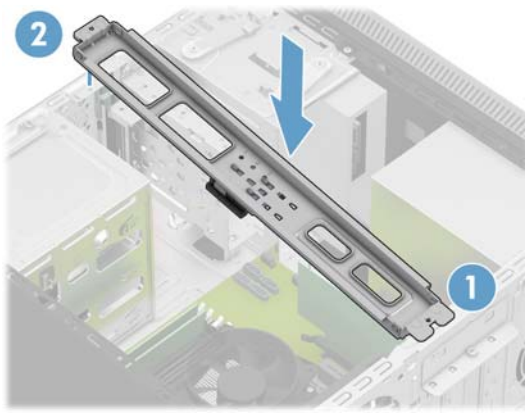

26

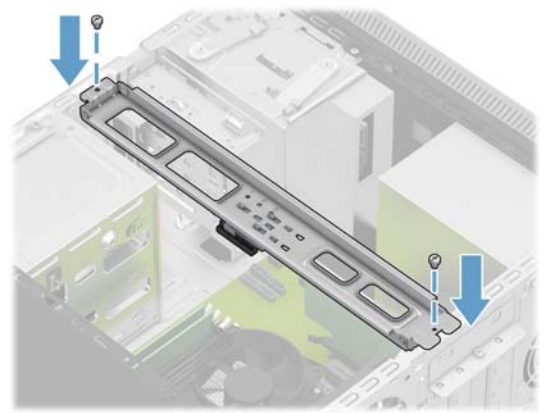

27

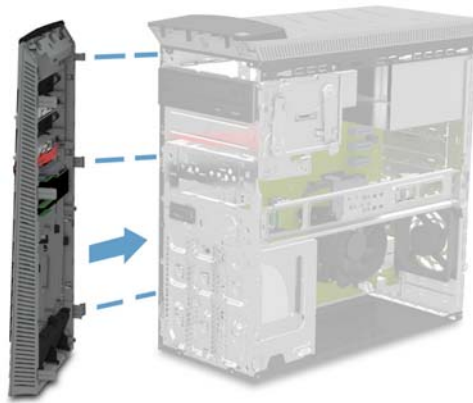

28



29

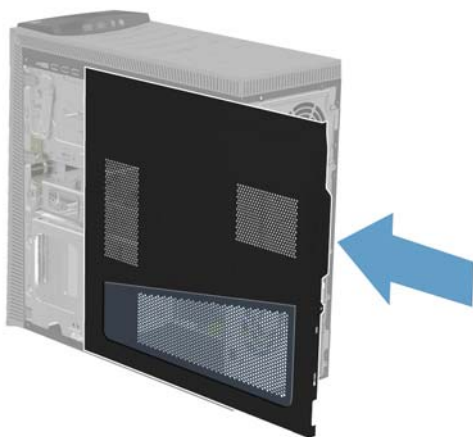

30

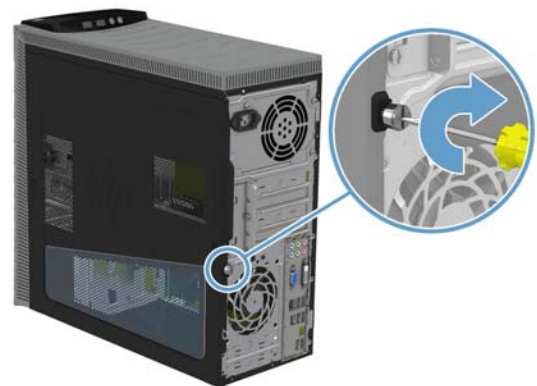

Hard Drive

Drive hard disk

하드 드라이브
硬盘
硬碟
ハードドライブ

31

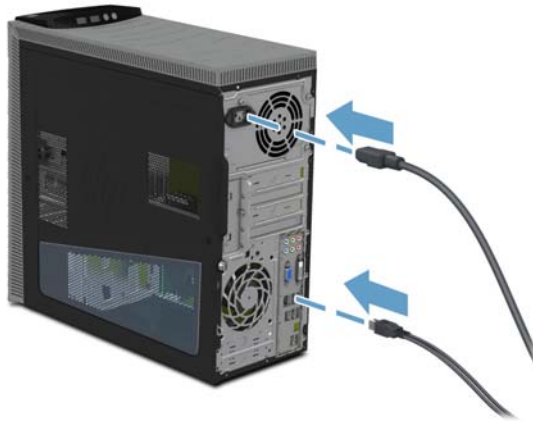

32



CD/DVD Drive

Drive CD/DVD

CD/DVD 드라이브
CD/DVD 光驱
CD/DVD 光碟機
CD/DVD 드라이브

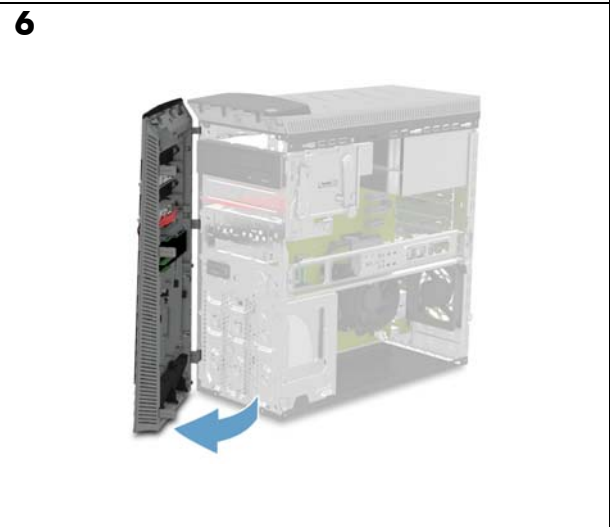
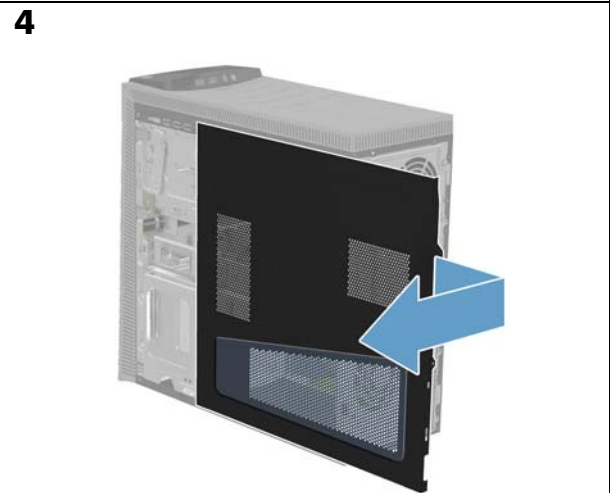
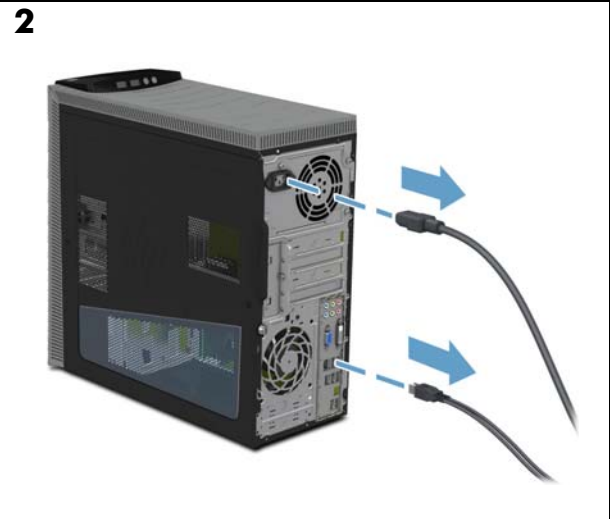
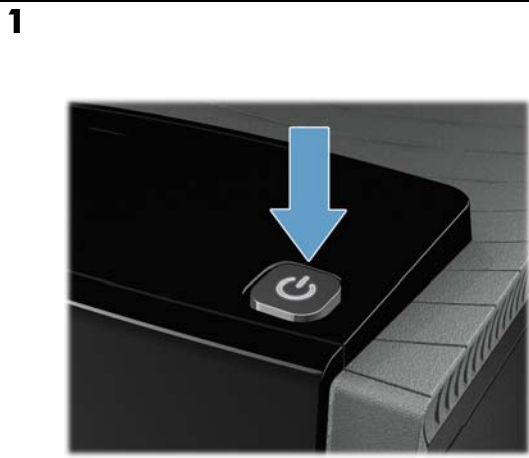

CD/DVD Drive

**Drive
CD/DVD**

CD/DVD 드라이브
CD/DVD 光驱
CD/DVD 光碟機
CD/DVD 드라이브

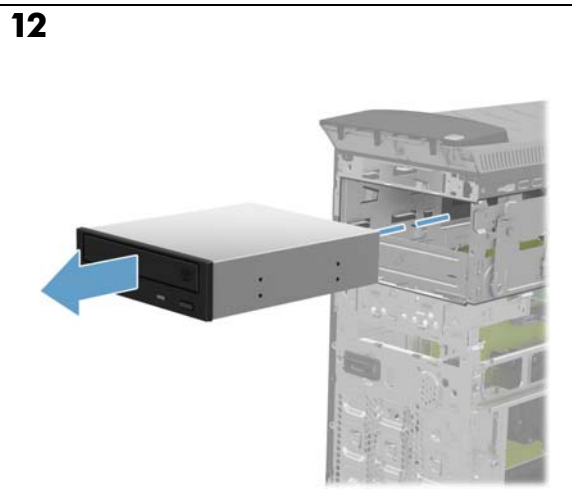
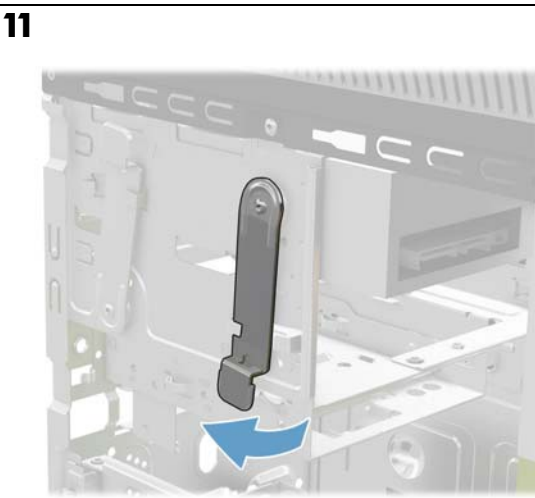
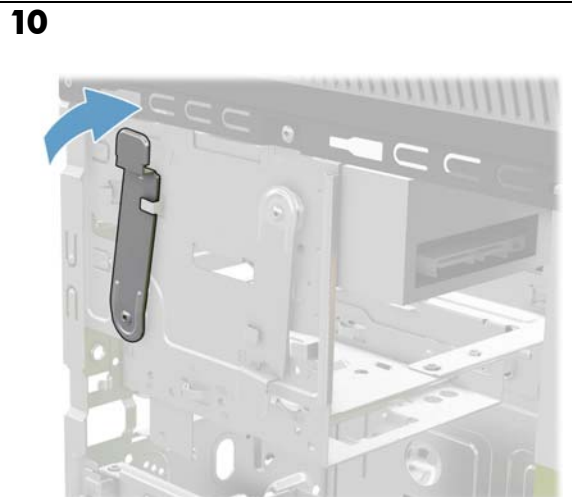
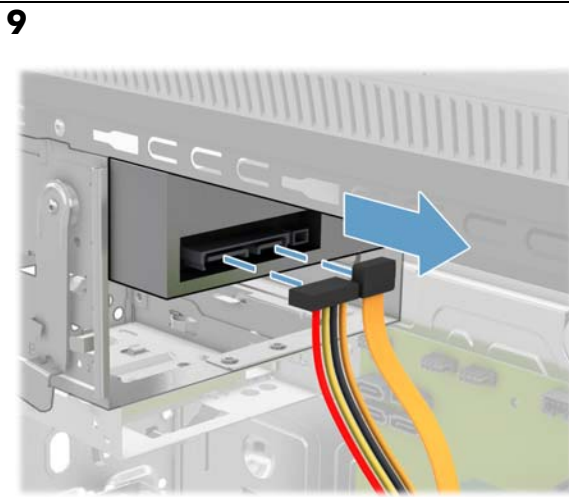
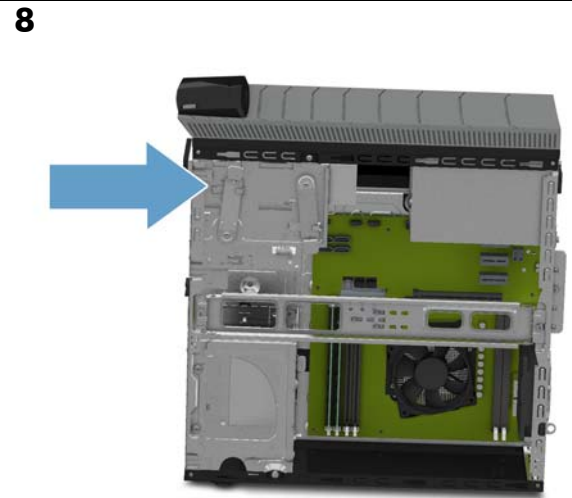

CD/DVD Drive

Drive CD/DVD

CD/DVD 드라이브
CD/DVD 光驱
CD/DVD 光碟機
CD/DVD ドライブ

13

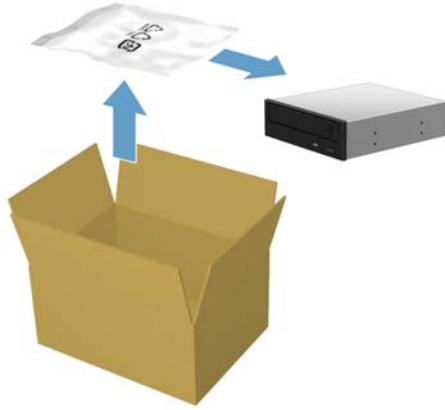

14

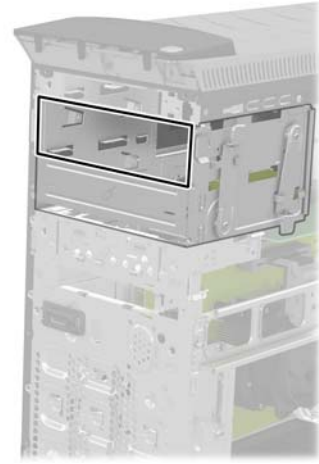

15

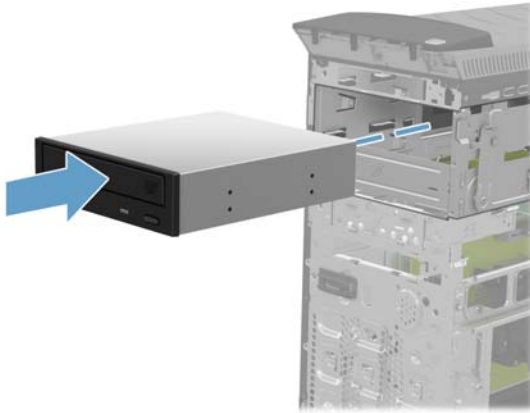

16

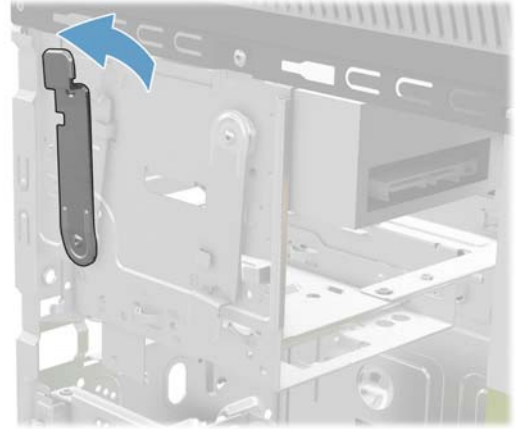

17

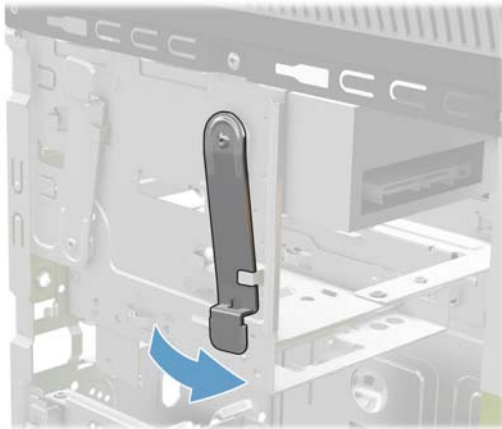

18

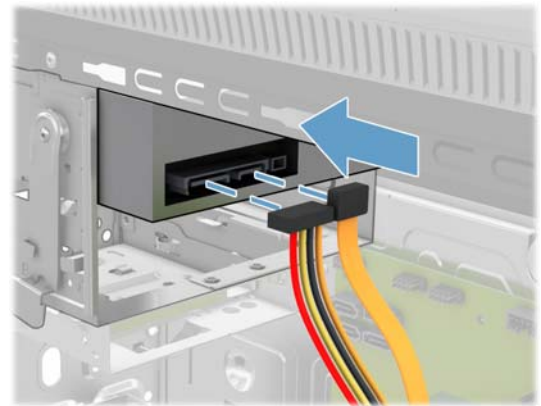

CD/DVD Drive

Drive CD/DVD

CD/DVD 드라이브
CD/DVD 光驱
CD/DVD 光碟機
CD/DVD 드라이브

19

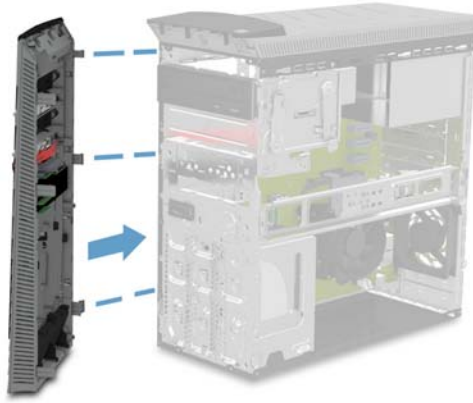

20



21

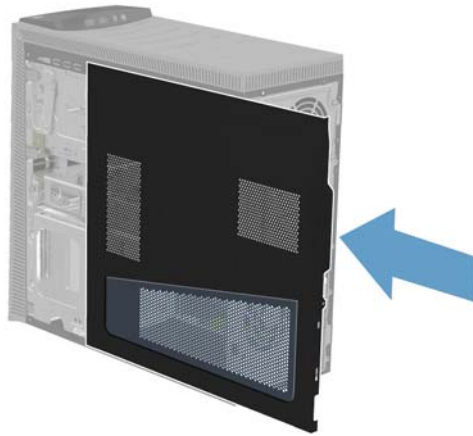

22

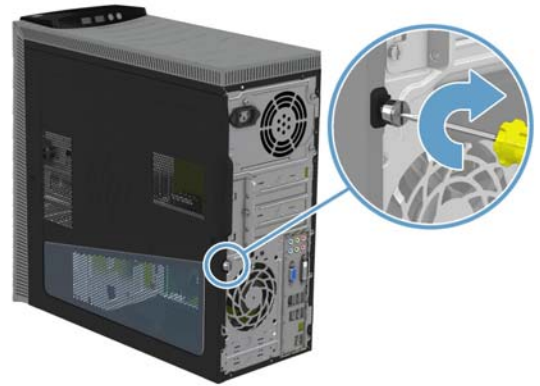

23

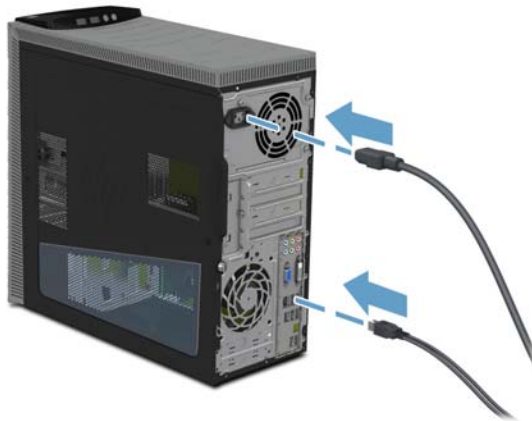

24



Memory Modules

Modul memori

메모리 모듈
内存条
記憶體模組
メモリモジュール

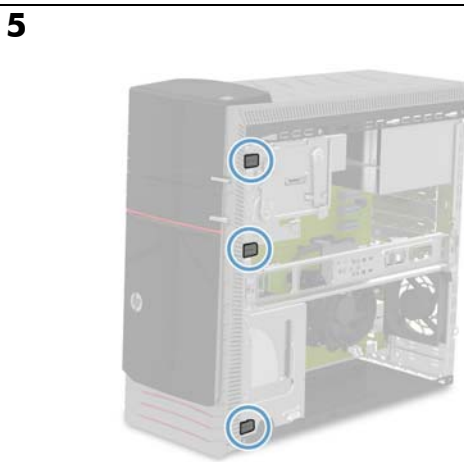
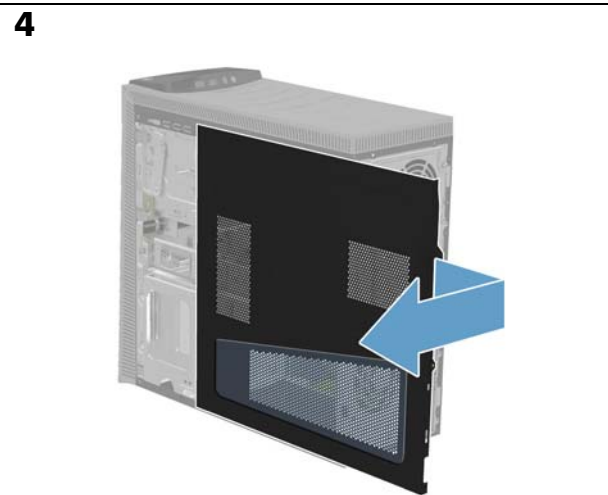
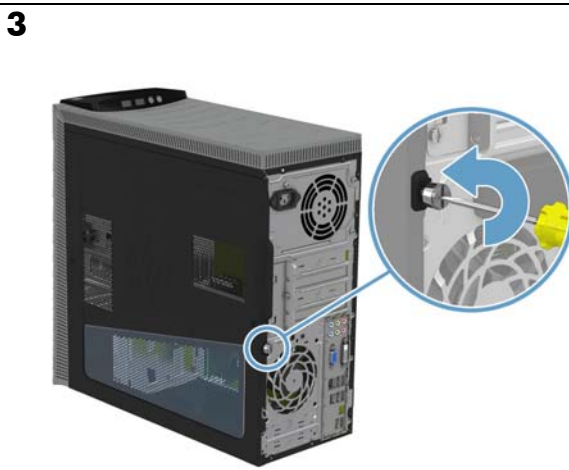
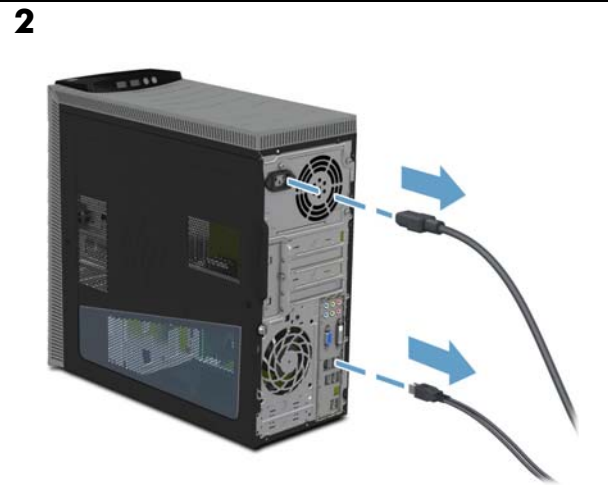
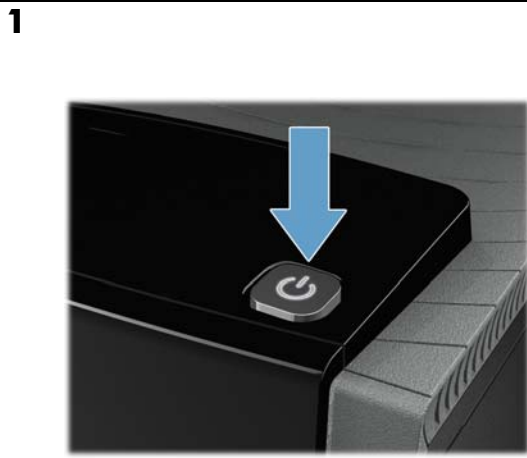

Memory Modules

Modul memori

메모리 모듈
内存条
記憶體模組
メモリモジュール

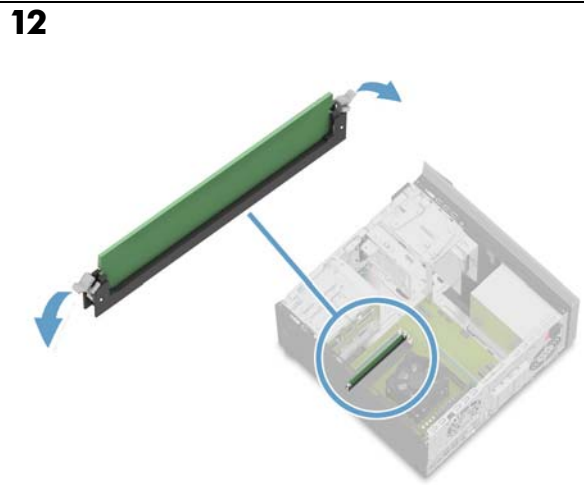
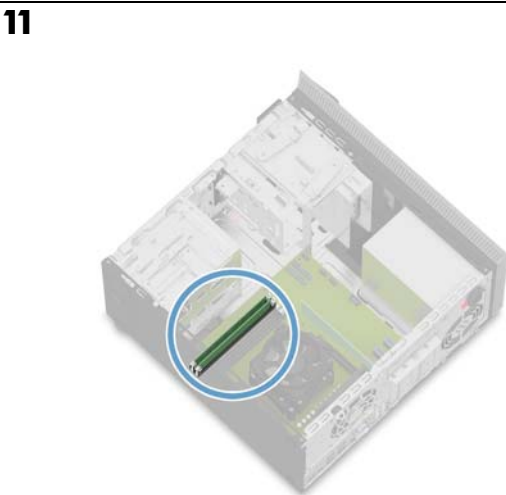
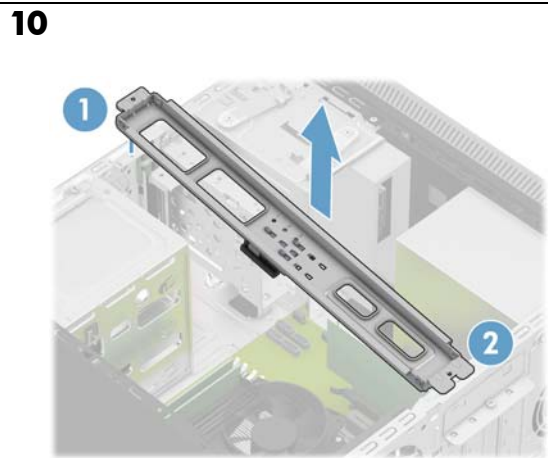
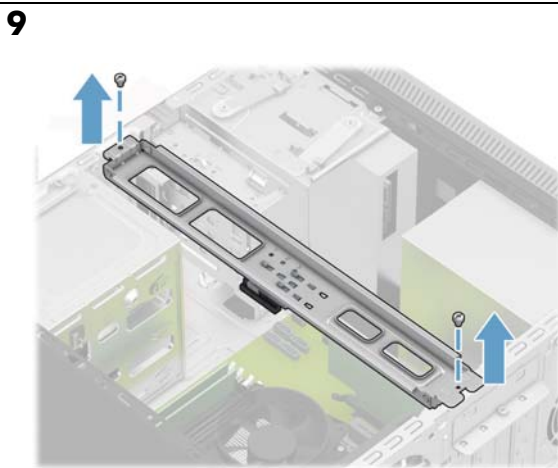
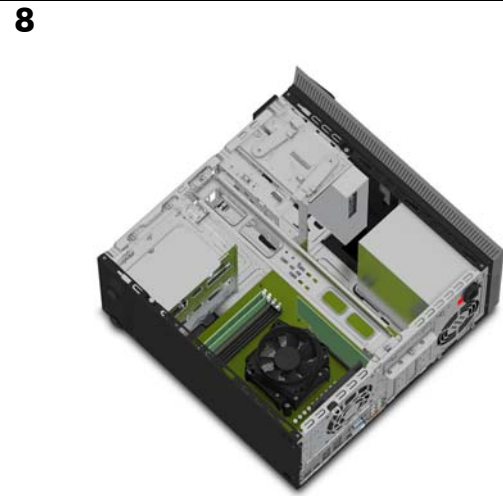

Memory Modules

Modul memori

메모리 모듈
内存条
記憶體模組
メモリモジュール

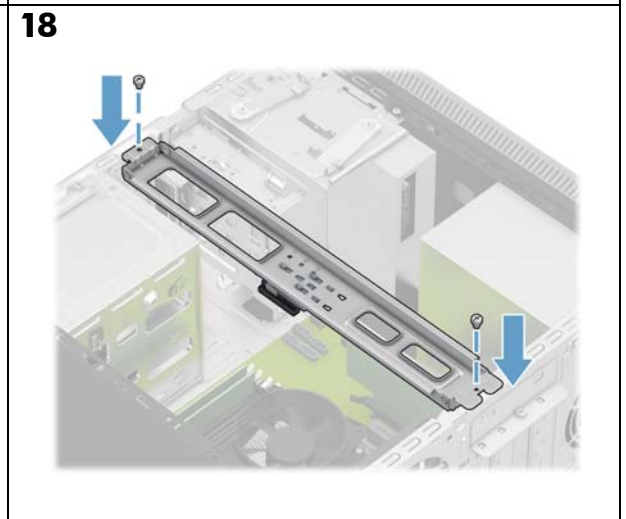
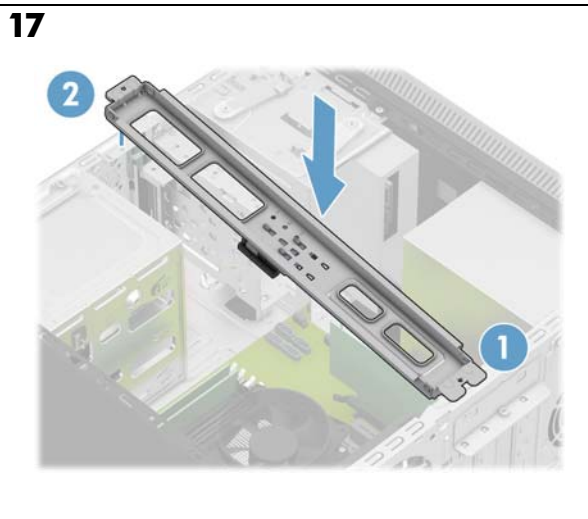
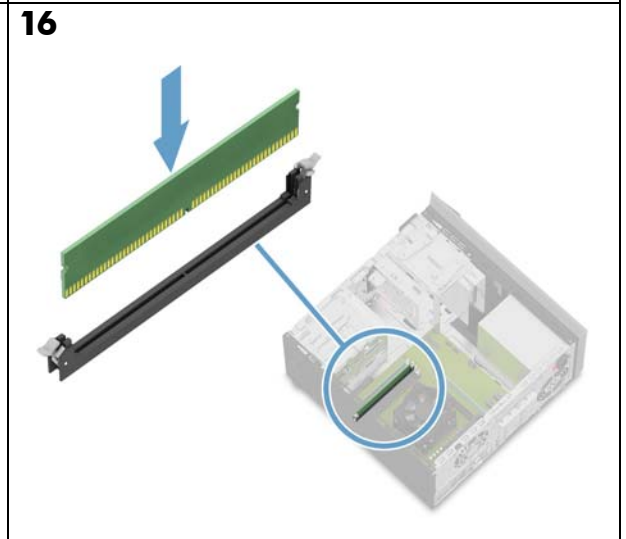
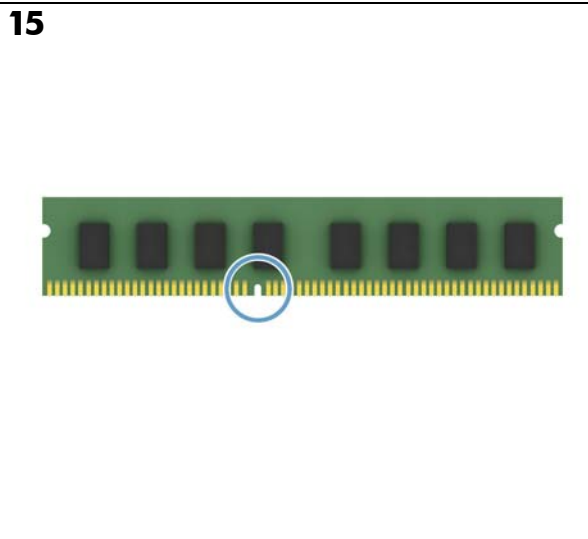
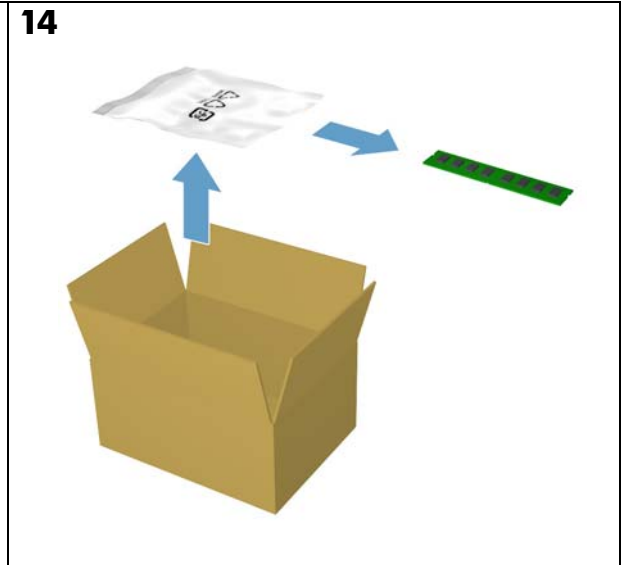
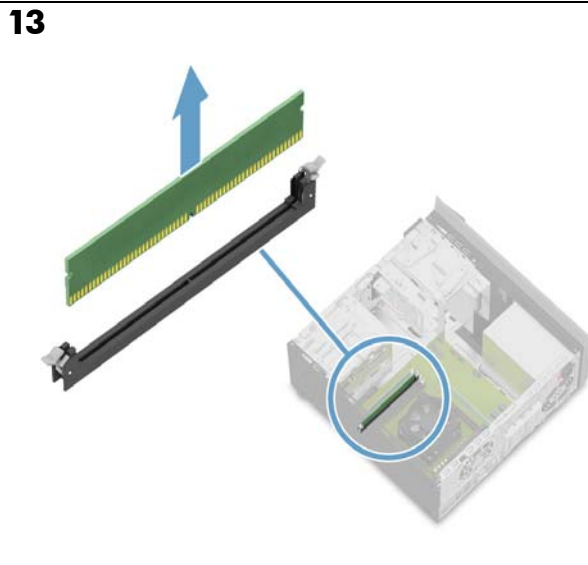

Memory Modules

Modul memori

메모리 모듈
内存条
記憶體模組
メモリモジュール

19

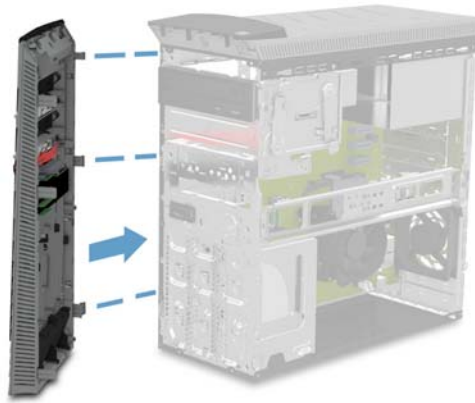

20



21

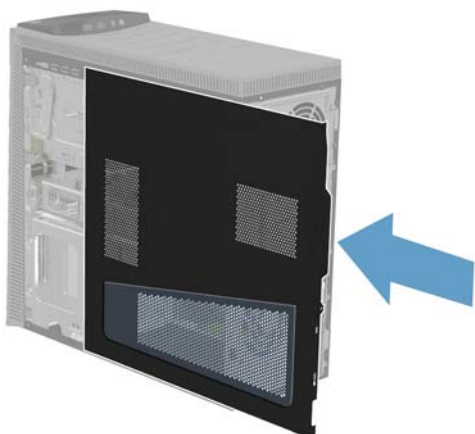

22

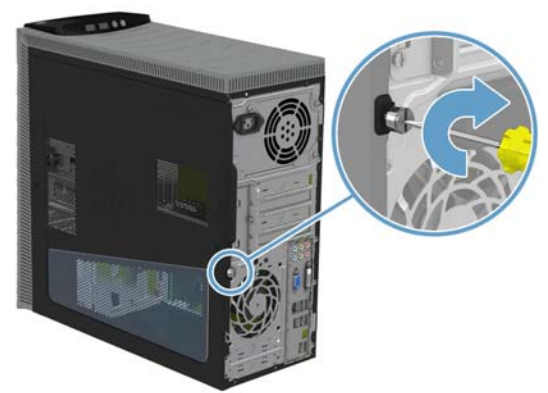

23

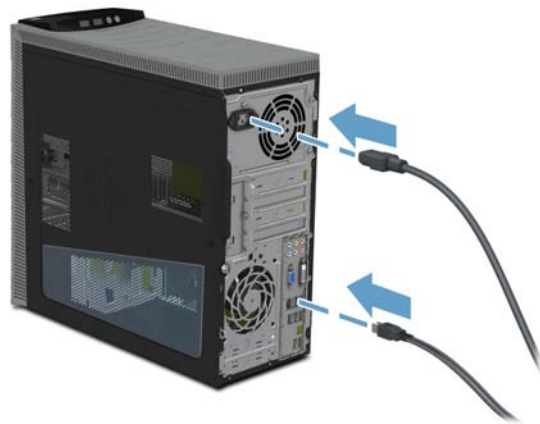

24



Add-in Card

Kartu Tambahan

확장 카드

扩充卡

擴充卡

追加カード

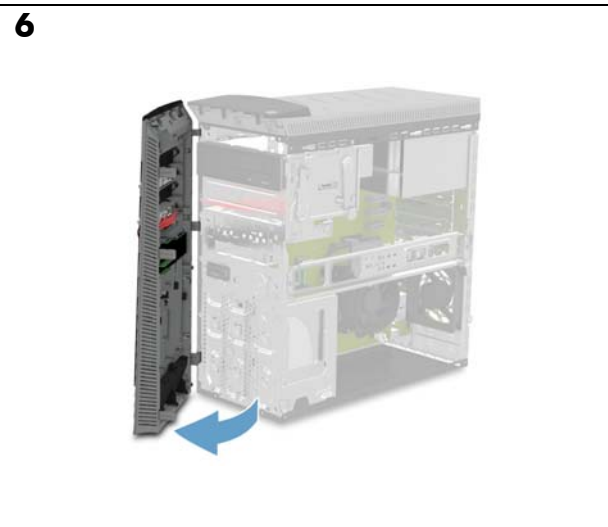
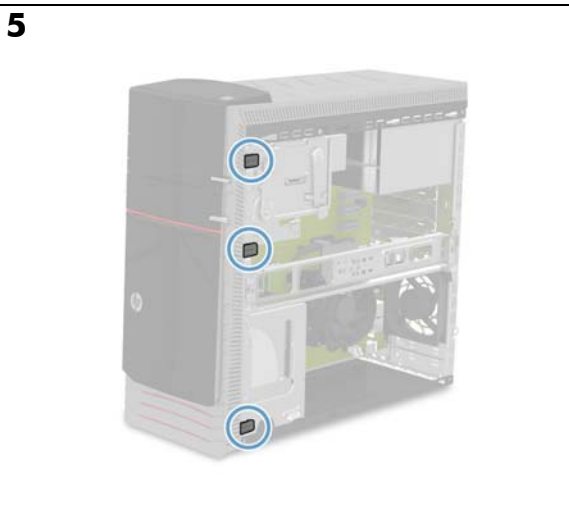
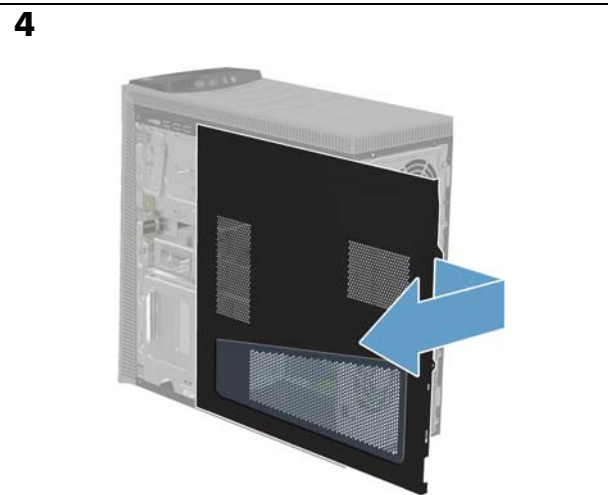
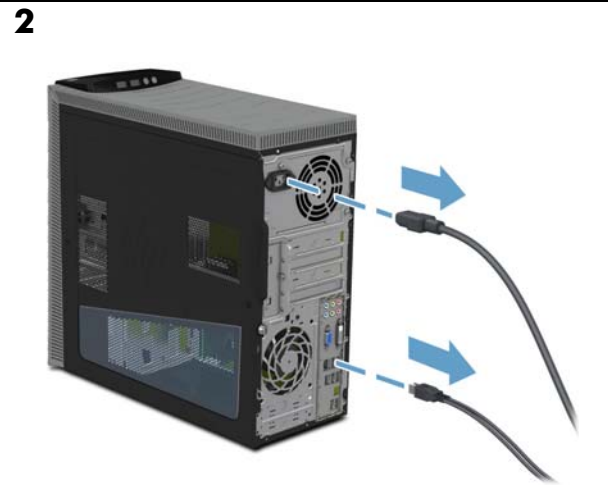
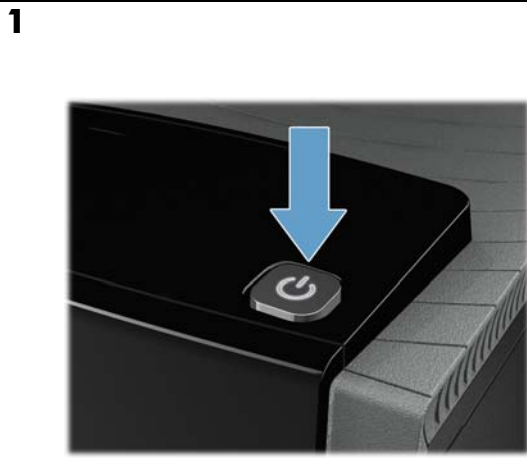

Add-in Card

Kartu Tambahan

확장 카드

扩充卡

擴充卡

追加カード

7



8



9

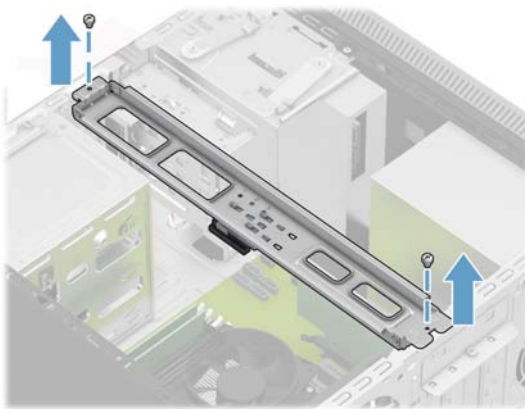

10

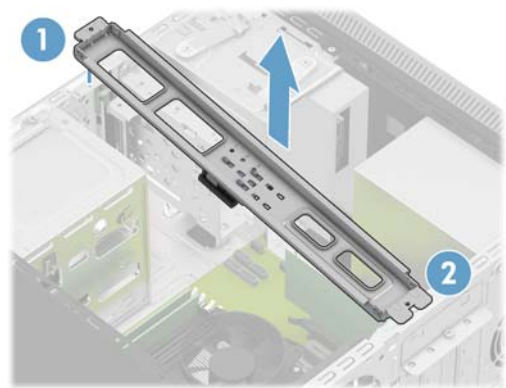

11

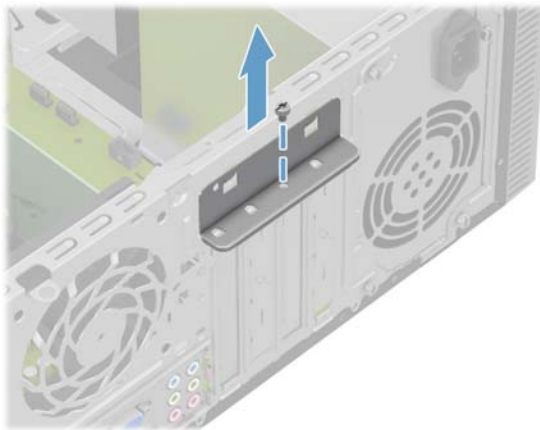

12

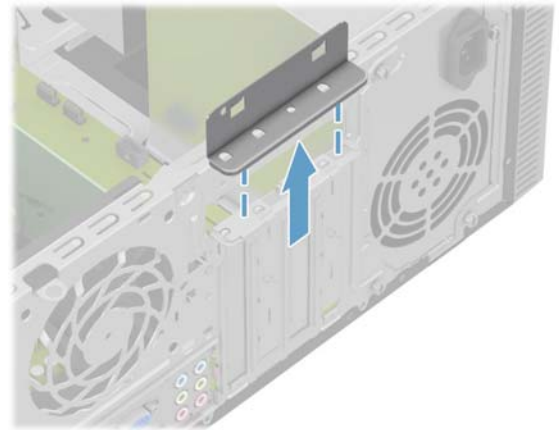

Add-in Card

Kartu Tambahan

확장 카드

扩充卡

擴充卡

追加カード

13

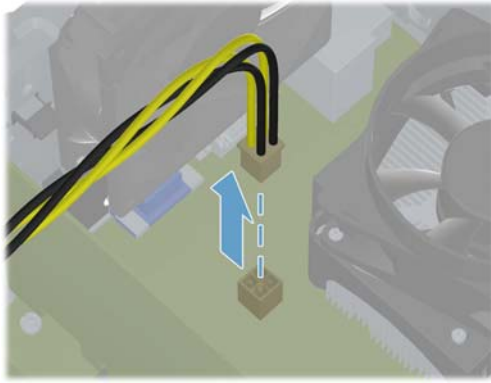

14

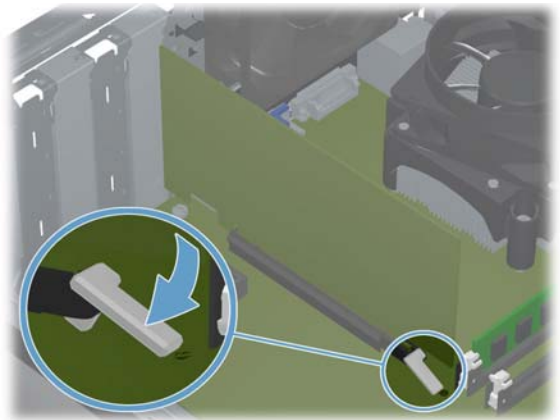

15

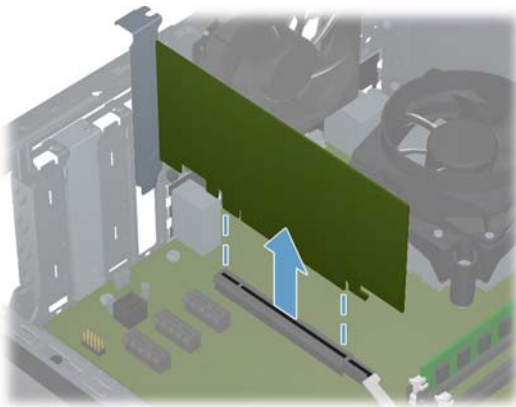

16

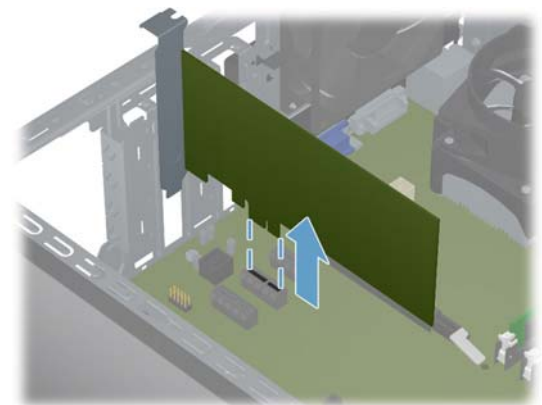

17

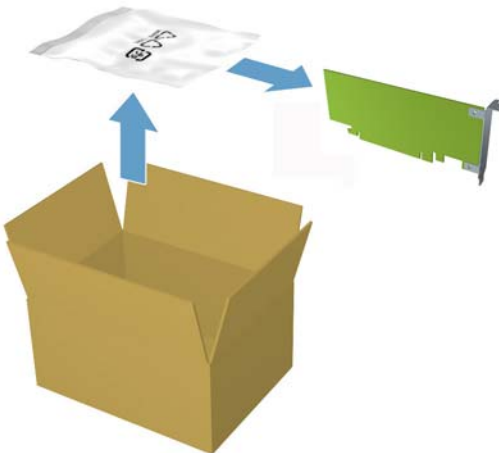

18

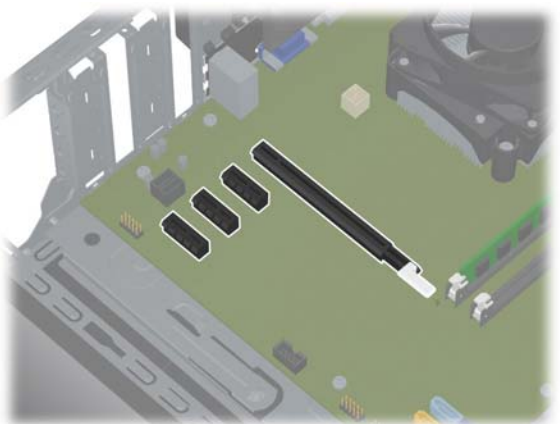

Add-in Card

Kartu Tambahan

확장 카드

扩充卡

擴充卡

追加カード

19

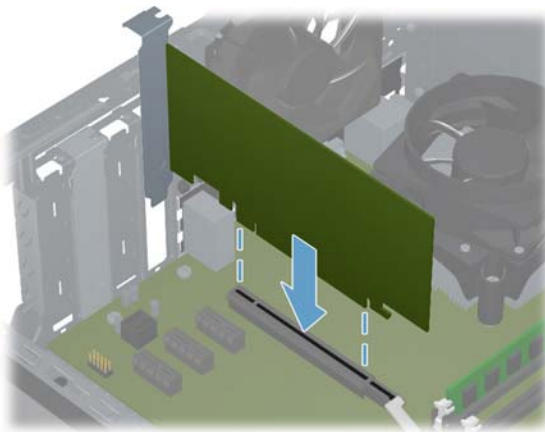

20

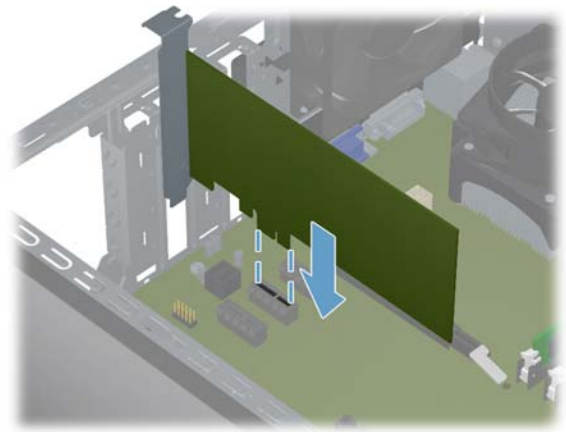

21

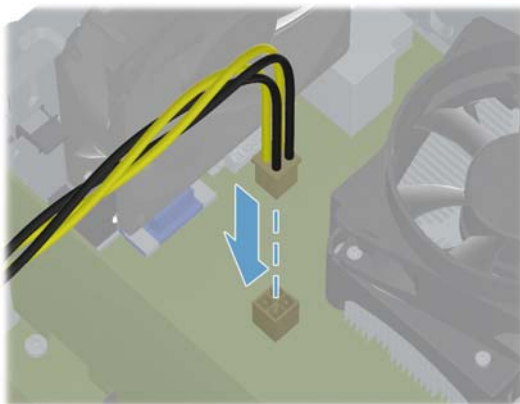

22

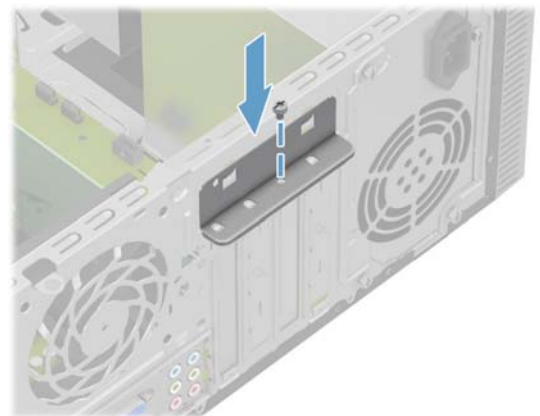

23

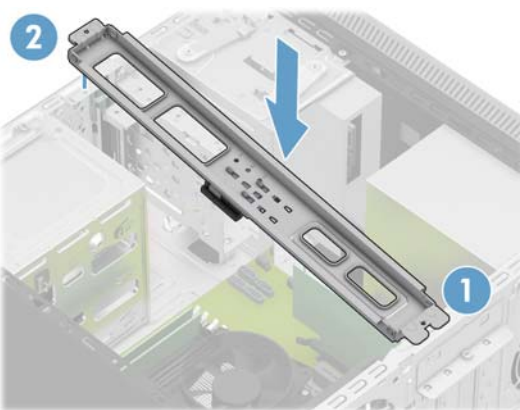

24

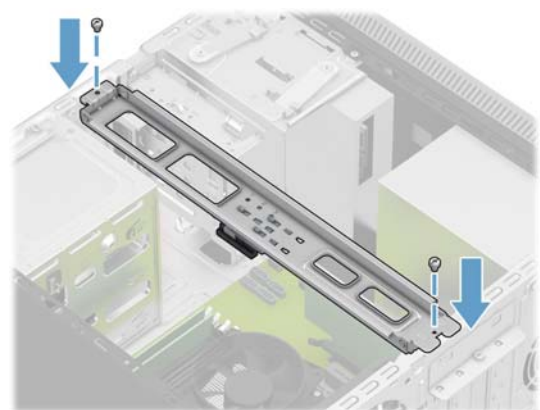

Add-in Card

Kartu Tambahan

확장 카드

扩充卡

擴充卡

追加カード

25

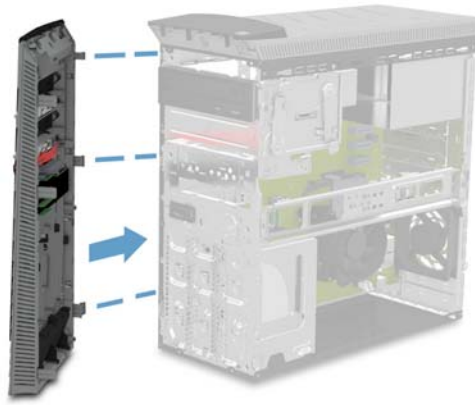

26



27

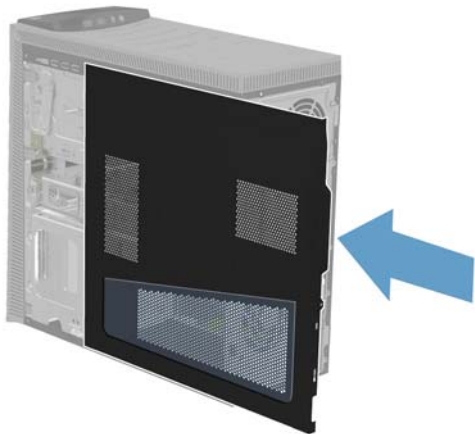

28



29

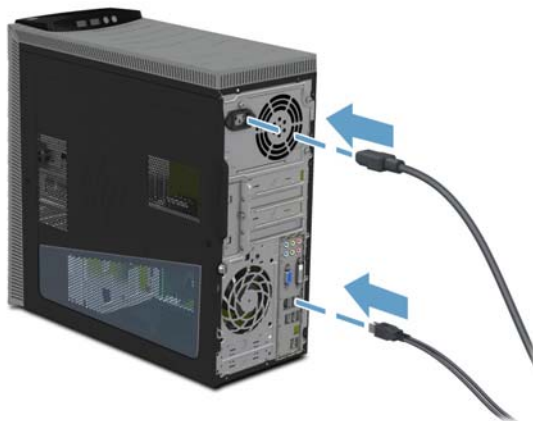

30



**Graphics
Card**

Kartu Grafis

그래픽 카드

图形卡

顯示卡

グラフィックスカード

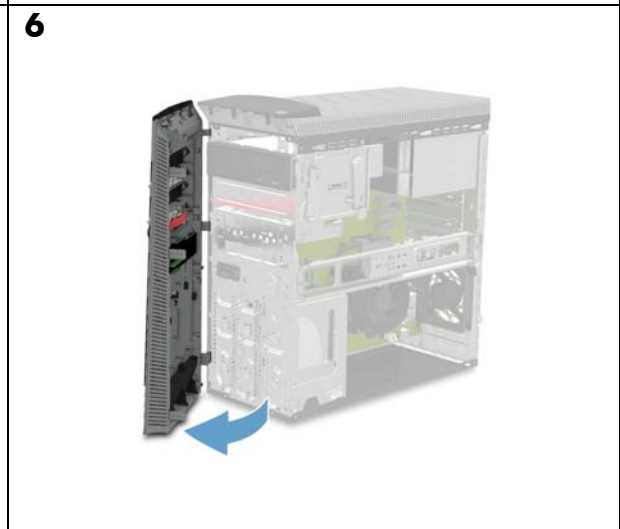
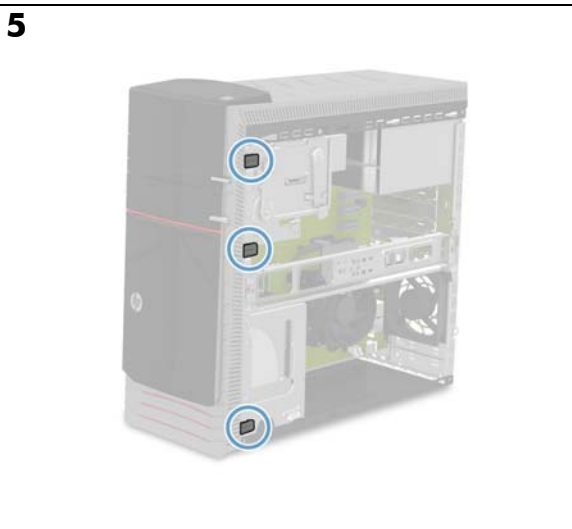
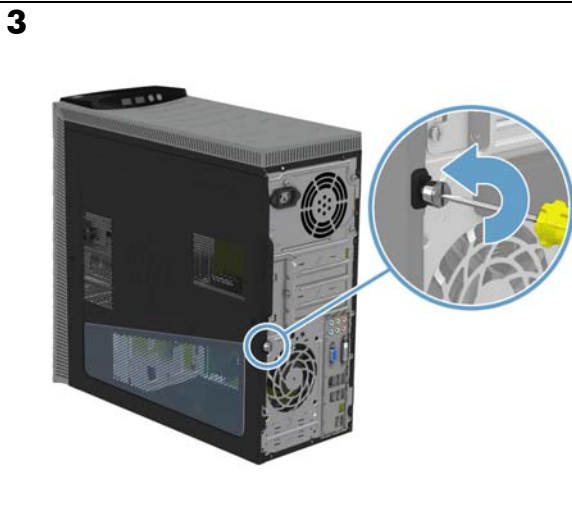
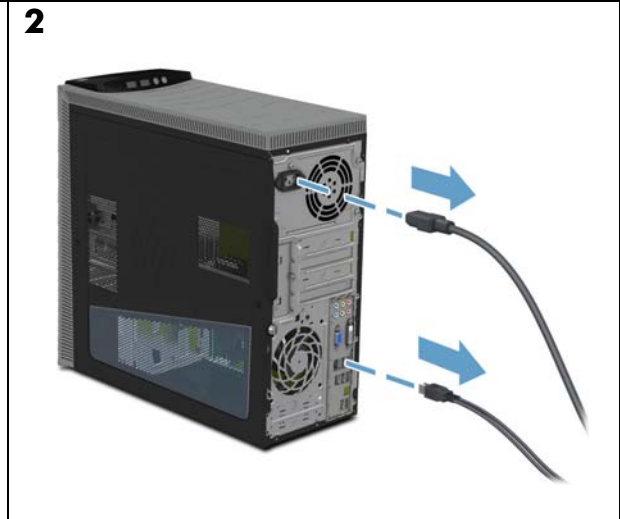
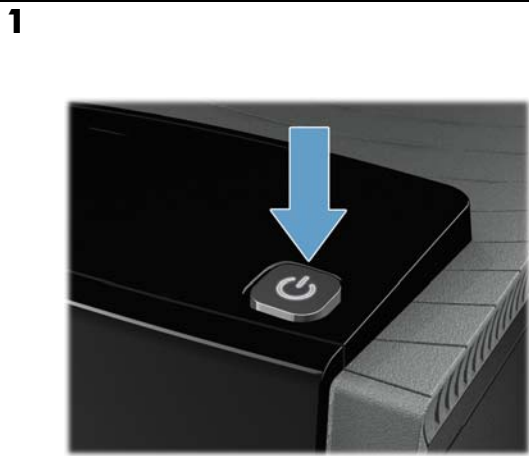

Graphics Card

Kartu Grafis

그래픽 카드

图形卡

顯示卡

グラフィックスカード

7



8



9

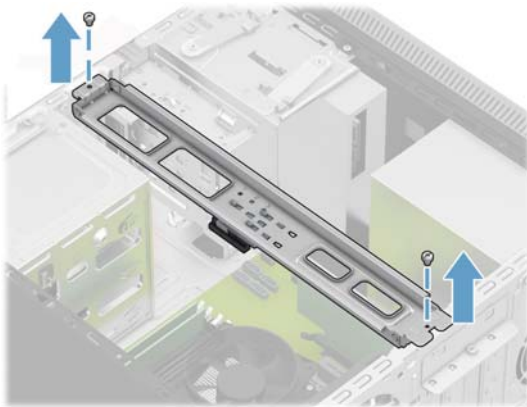

10

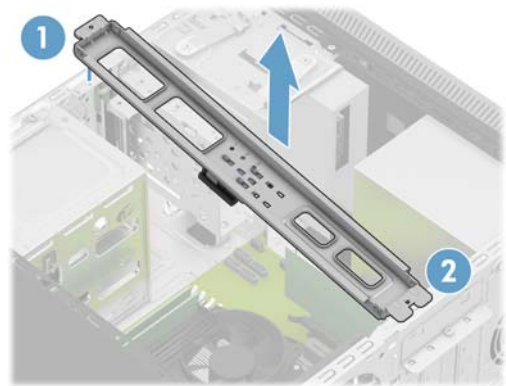

11

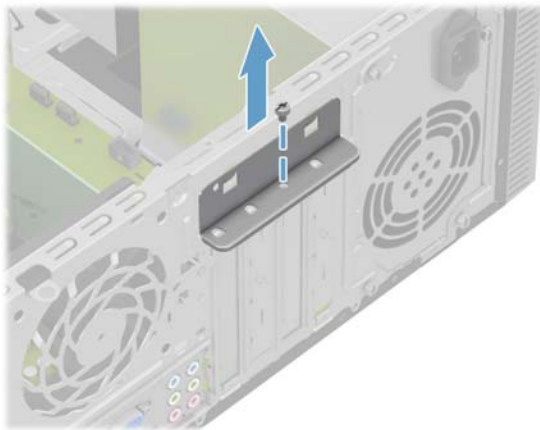

12

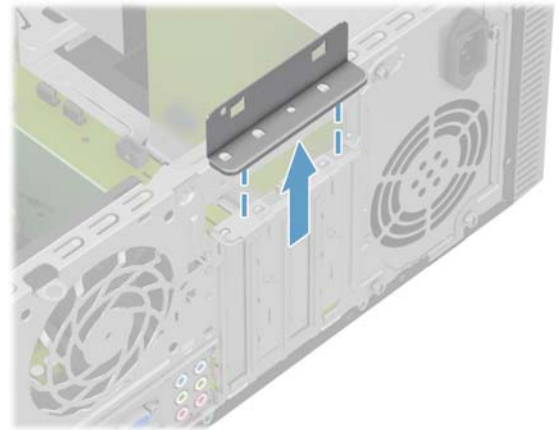

**Graphics
Card**

Kartu Grafis

그래픽 카드

图形卡

顯示卡

グラフィックスカード

13

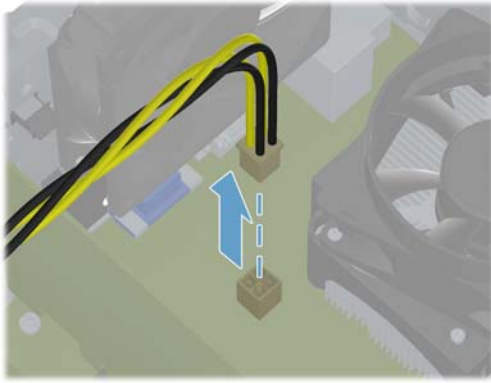

14

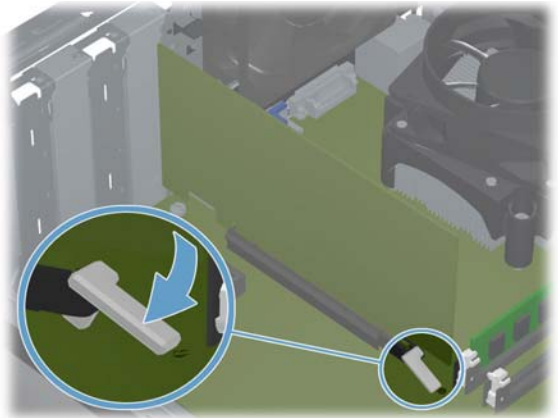

15

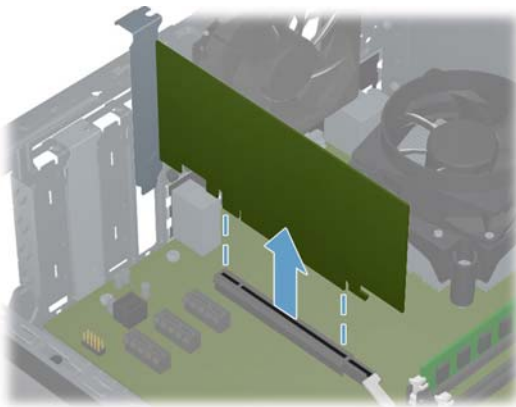

16

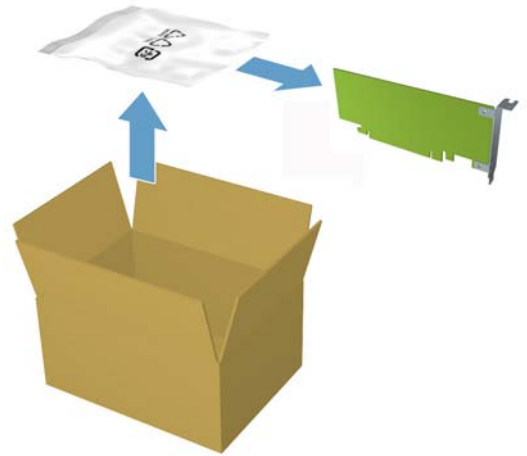

17

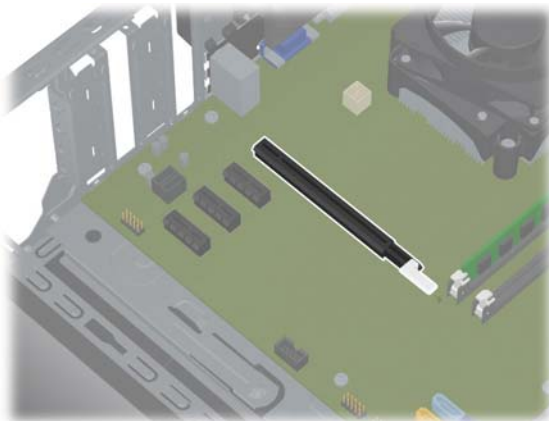

18

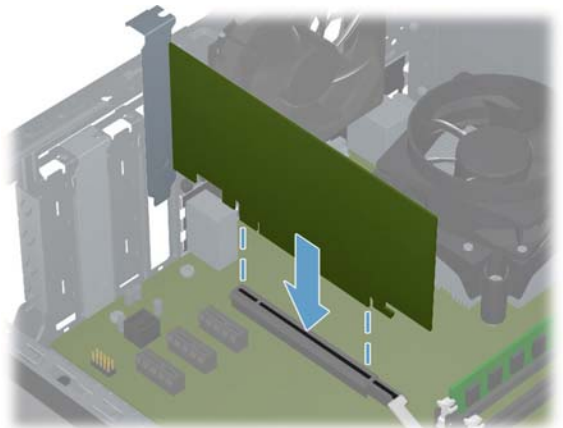

**Graphics
Card**

Kartu Grafis

그래픽 카드

图形卡

顯示卡

グラフィックスカード

19

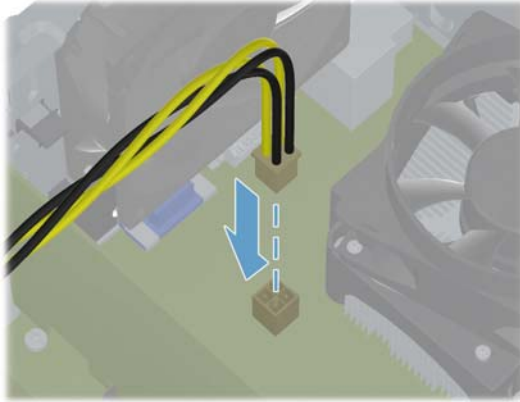

20

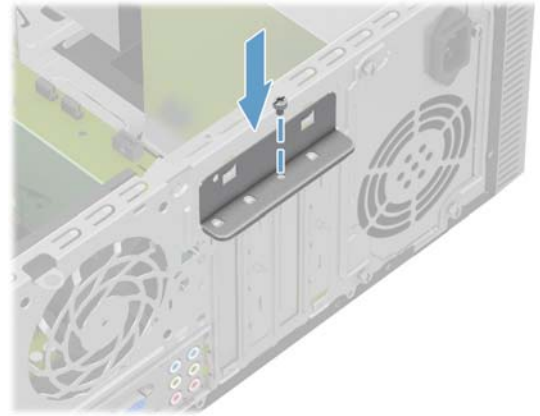

21

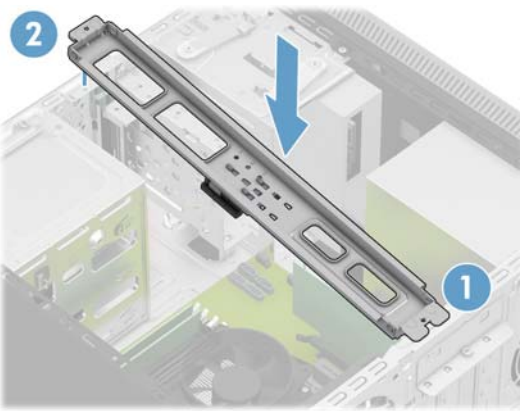

22

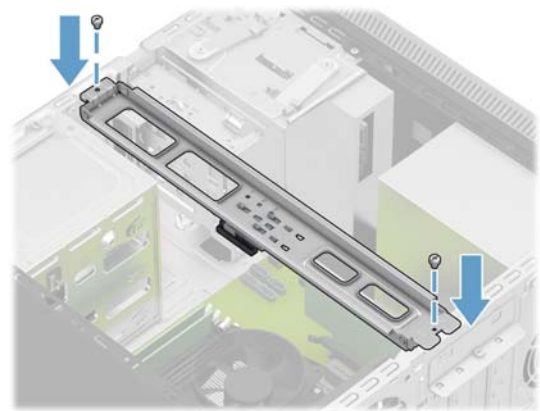

23

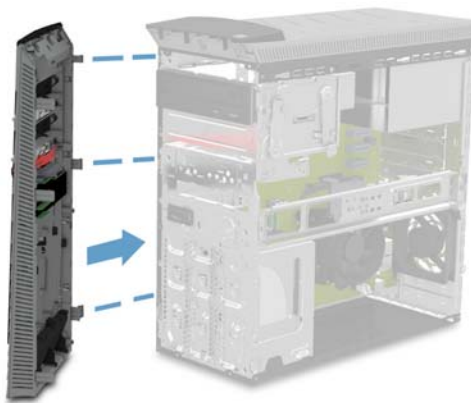

24



**Graphics
Card**

Kartu Grafis

그래픽 카드

图形卡

顯示卡

グラフィックスカード

25

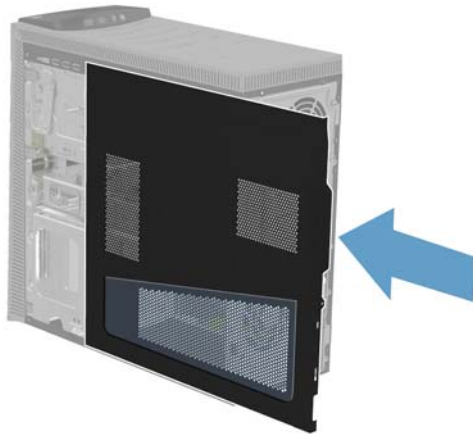

26

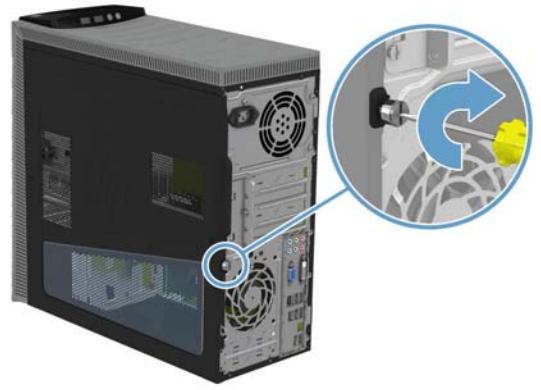

27

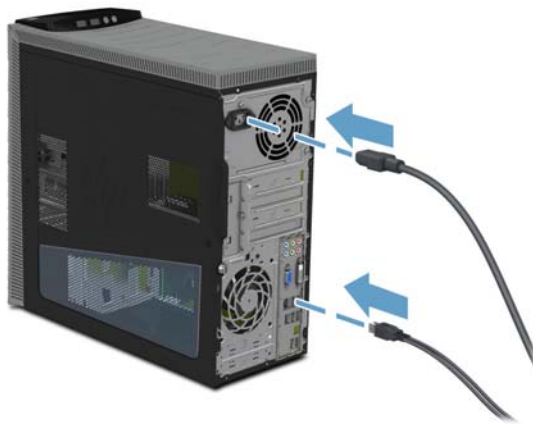

28



Power Supply

Catu Daya

전원 공급장치
电源
電源供應器
電源

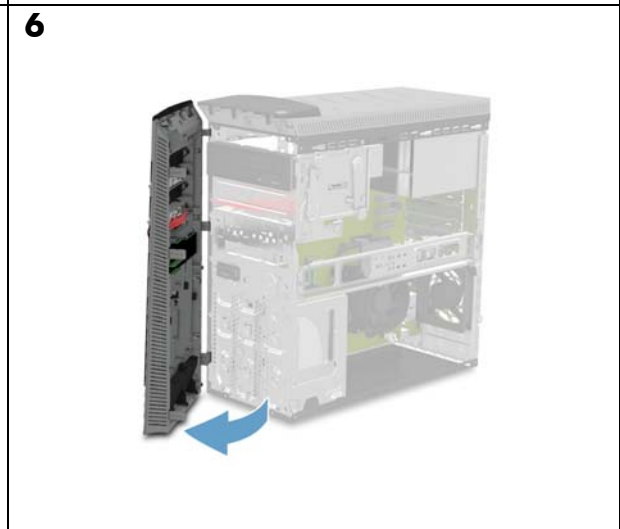
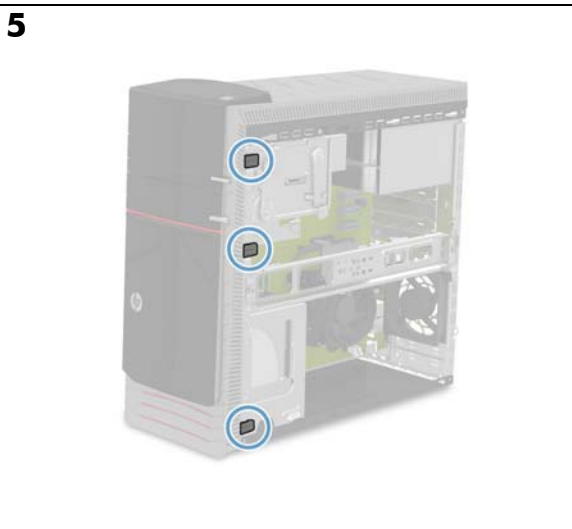
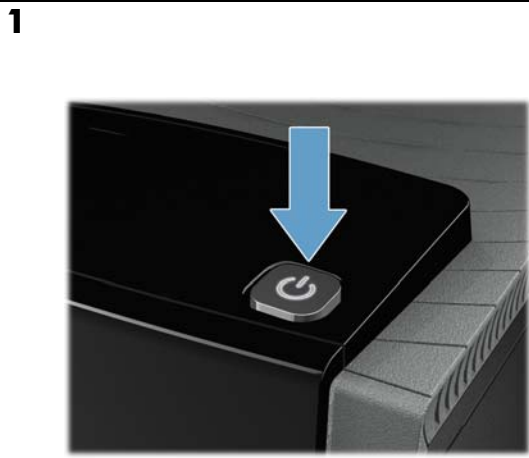

Power Supply

Catu Daya

전원 공급장치
电源
電源供應器
電源

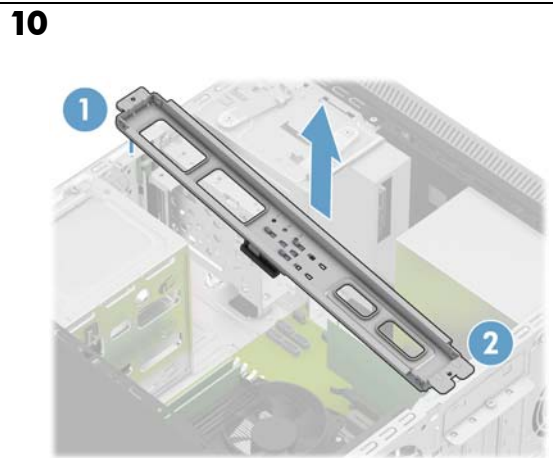
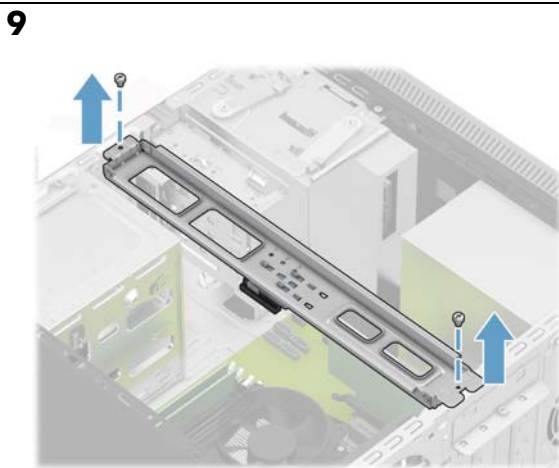
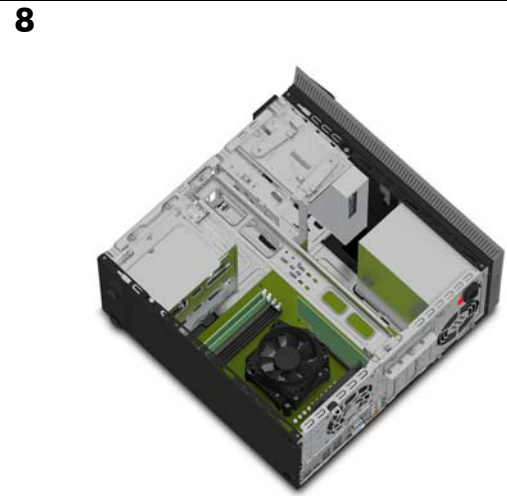

Power Supply

Catu Daya

전원 공급장치
电源
電源供應器
電源

11

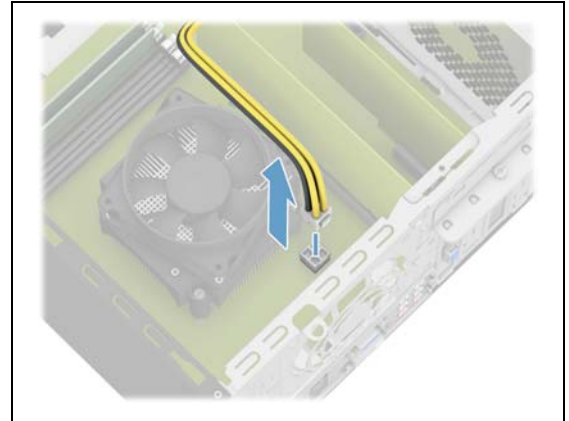
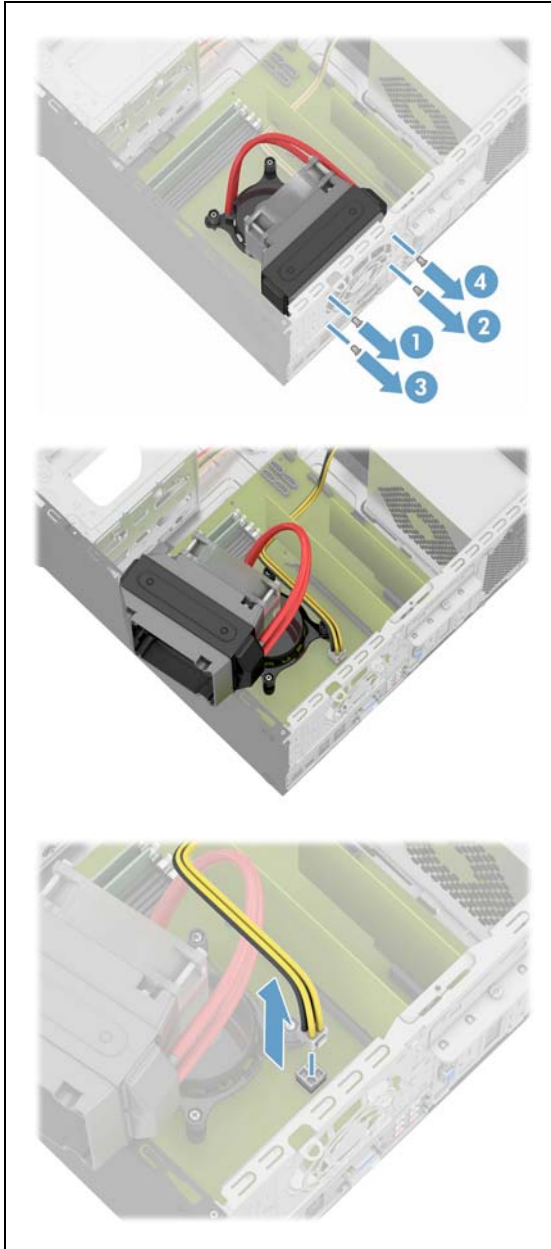
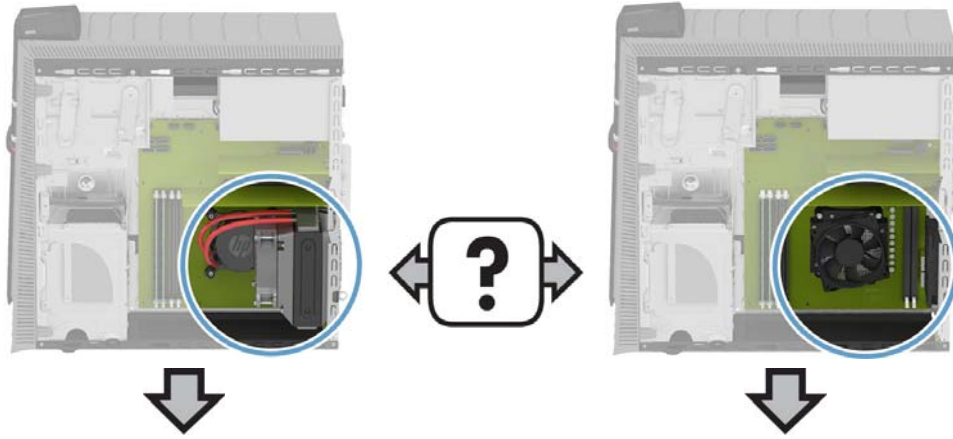

Power Supply

Catu Daya

전원 공급장치
电源
電源供應器
電源

12

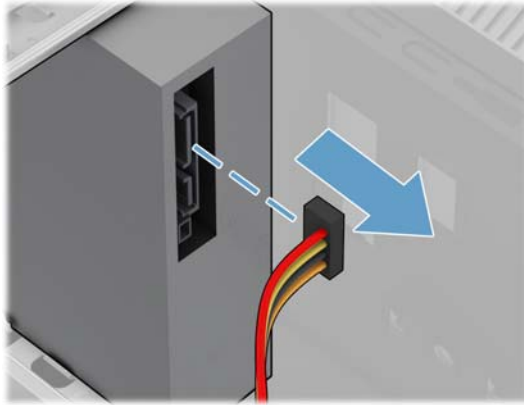

13

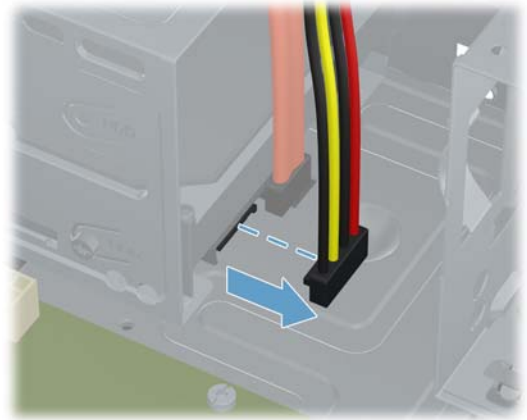

14

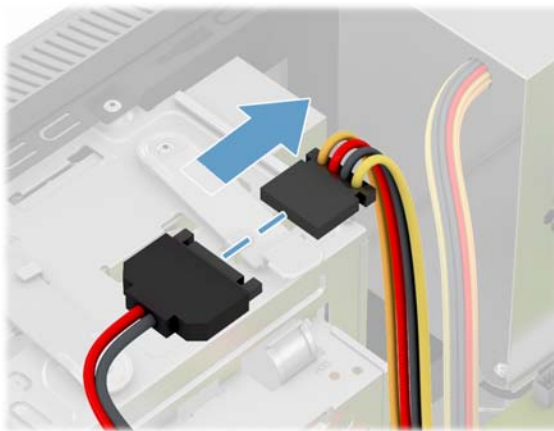

15

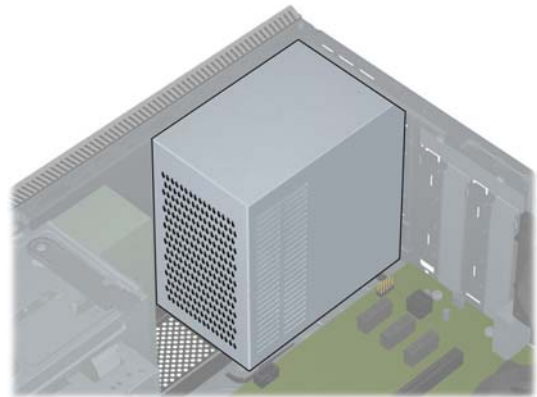

16

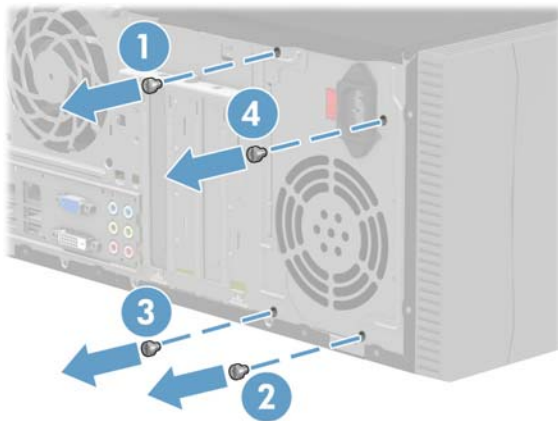

17

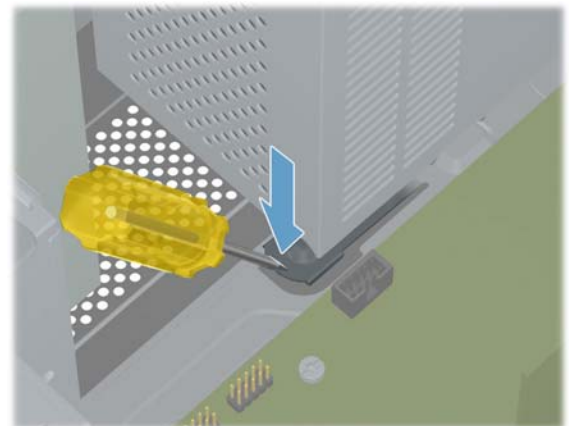

Power Supply

Catu Daya

전원 공급장치
电源
電源供應器
電源

18

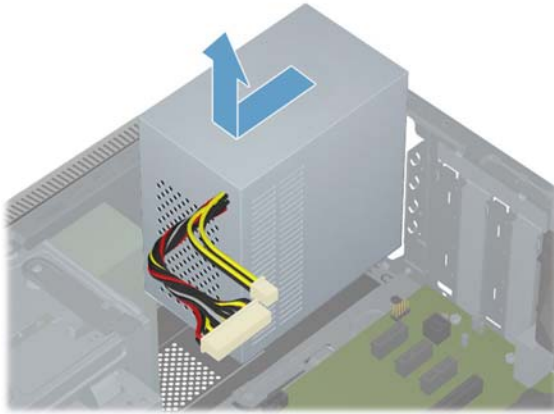

19

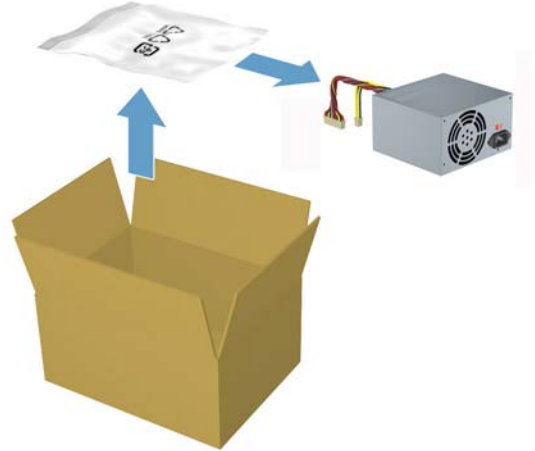

20

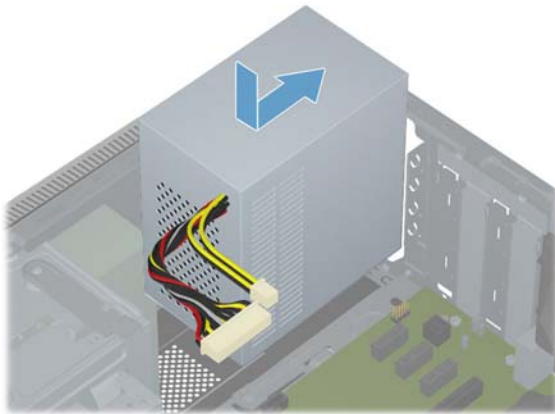

21

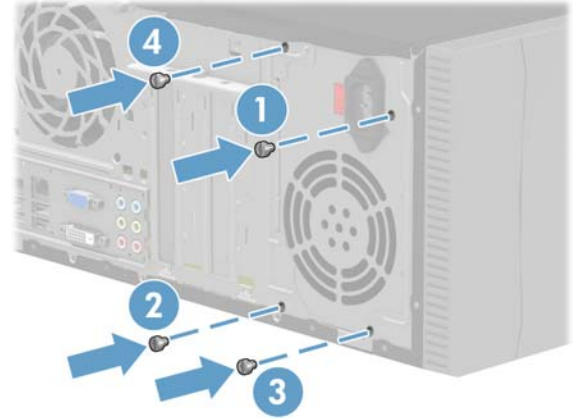

22

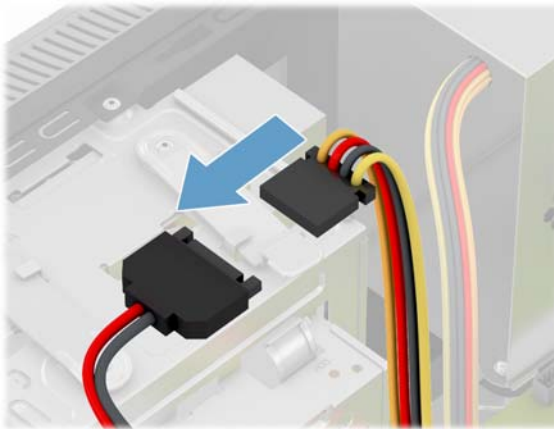

23

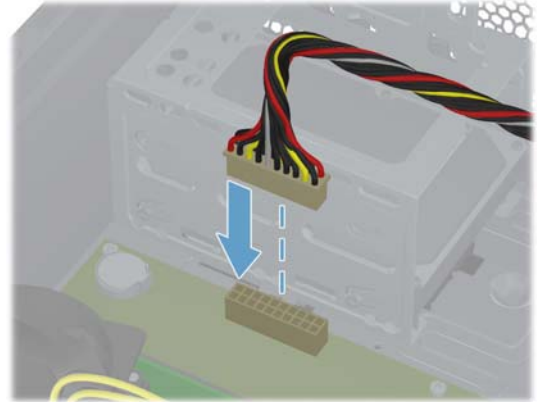

Power Supply

Catu Daya

전원 공급장치
电源
電源供應器
電源

24

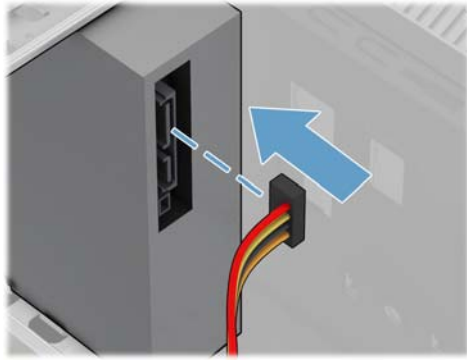

25

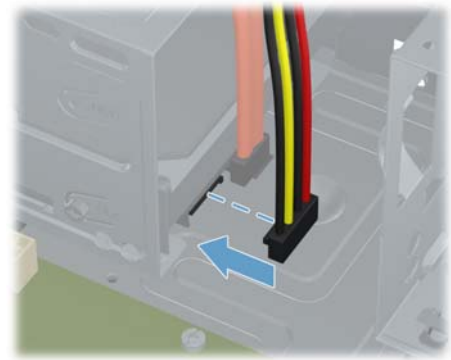

26

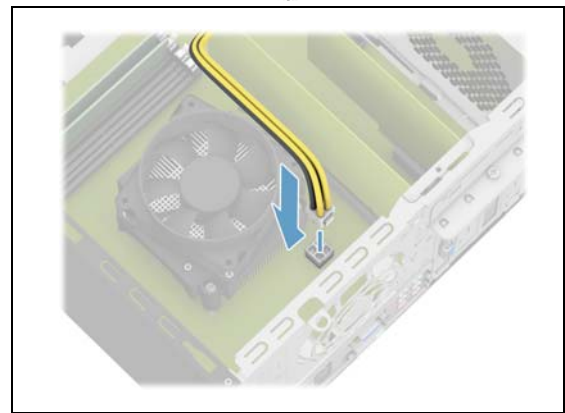
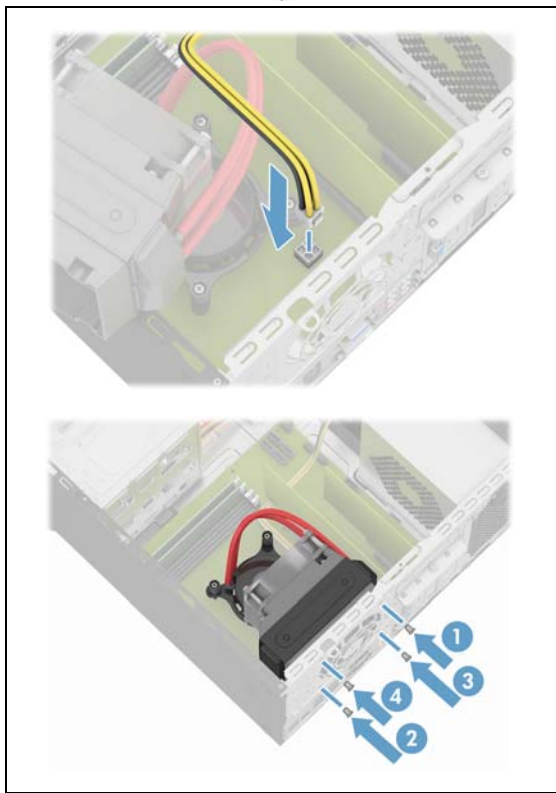
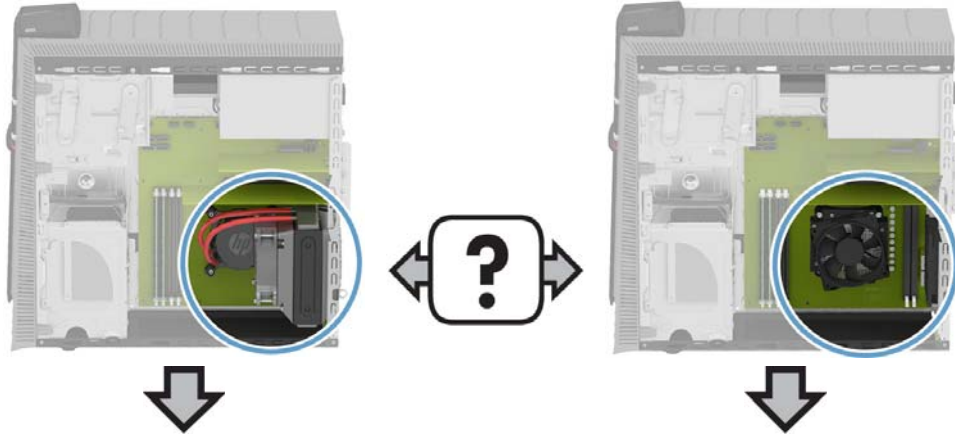

Power Supply

Catu Daya

전원 공급장치
电源
電源供應器
電源

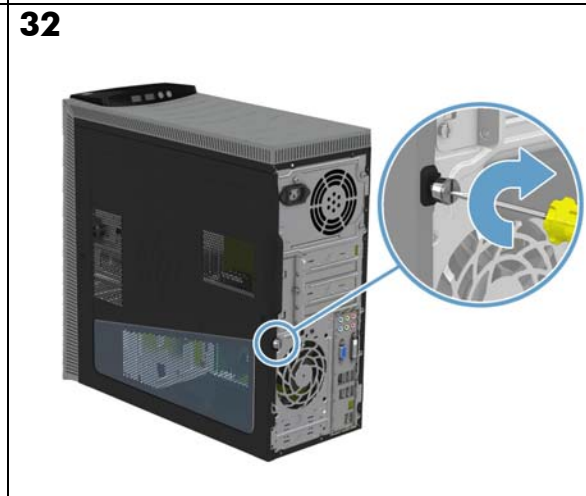
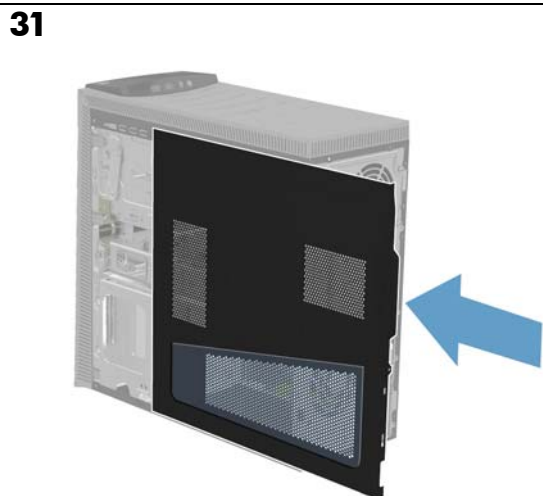
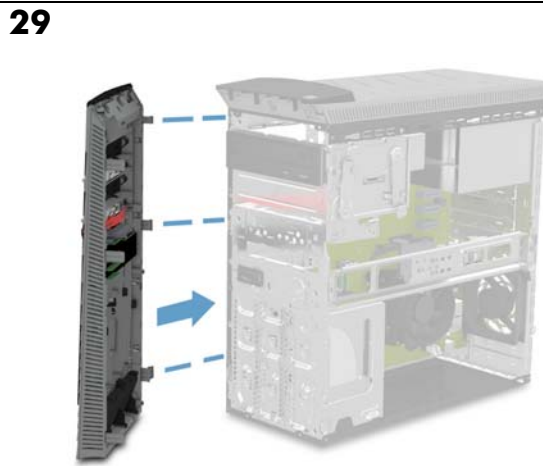
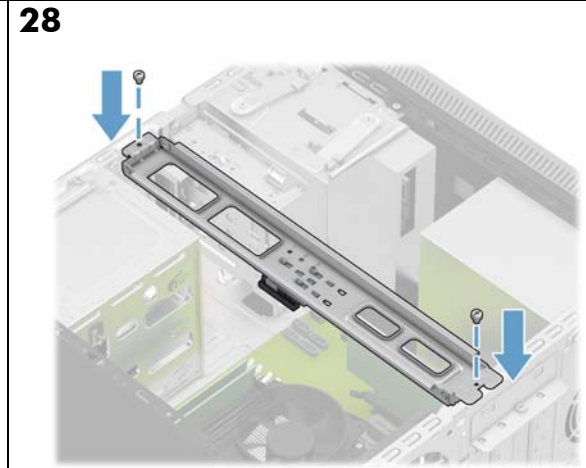
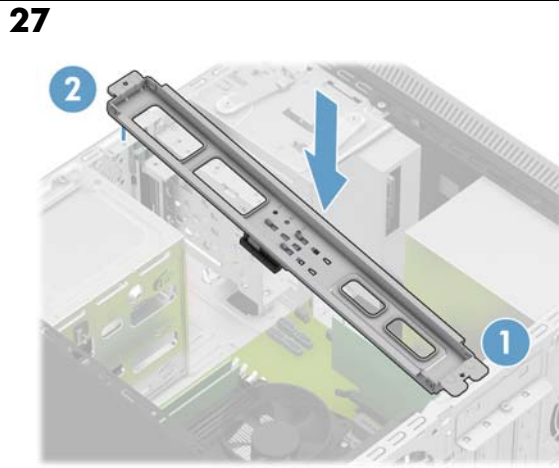

**Power
Supply**

Catu Daya

전원 공급장치
电源
電源供應器
電源

33

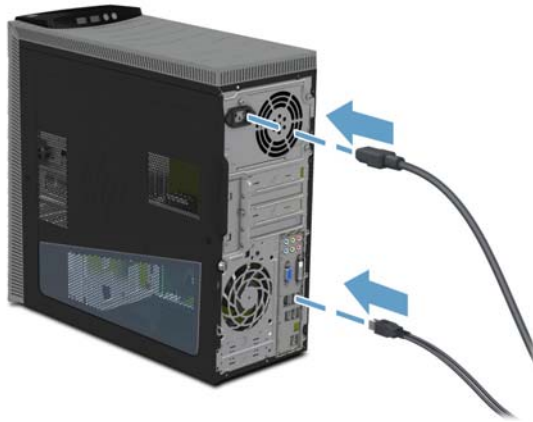

34

