



# HP 10s Scientific Calculator User's Guide

Part Number: F2214-90001

First Edition: 01/2007



## Notice

REGISTER YOUR PRODUCT AT: [www.register.hp.com](http://www.register.hp.com)

THIS MANUAL AND ANY EXAMPLES CONTAINED HEREIN ARE PROVIDED "AS IS" AND ARE SUBJECT TO CHANGE WITHOUT NOTICE. HEWLETT-PACKARD COMPANY MAKES NO WARRANTY OF ANY KIND WITH REGARD TO THIS MANUAL, INCLUDING, BUT NOT LIMITED TO, THE IMPLIED WARRANTIES OF MERCHANTABILITY, NON-INFRINGEMENT AND FITNESS FOR A PARTICULAR PURPOSE. HEWLETT-PACKARD CO. SHALL NOT BE LIABLE FOR ANY ERRORS OR FOR INCIDENTAL OR CONSEQUENTIAL DAMAGES IN CONNECTION WITH THE FURNISHING, PERFORMANCE, OR USE OF THIS MANUAL OR THE EXAMPLES CONTAINED HEREIN.

© Copyright 2005, 2007 Hewlett-Packard Development Company, L.P.

Reproduction, adaptation, or translation of this manual is prohibited without prior written permission of Hewlett-Packard Company, except as allowed under copyright laws.

Hewlett-Packard Company  
16399 West Bernardo Drive  
MS 8-600  
San Diego, CA 92127-1899  
USA

# Contents

Notice .....	1
Using the Protective Case.....	4
Safety Precautions .....	4
Other Precautions.....	5
Two-Line Display.....	7
Preparing to Use the Calculator.....	7
Modes.....	7
Input Limit .....	8
Error Correction when Entering .....	9
Recalling a Previous Calculation .....	9
Error Indicator .....	10
Multi-statement.....	10
Exponent Display Format.....	10
Decimal Point and Separator.....	11
Initializing the Calculator .....	11
Basic Calculations .....	11
Arithmetic Operations .....	11
Calculation with Fractions.....	12
Calculation with fractions.....	12
Converting between decimal and fractional display .....	13
Converting between Mixed and Improper Fractions.....	13
Calculating Percentages.....	14
About Calculating Percentages .....	14
Calculations Involving Degrees, Minutes and Seconds .....	15
FIX,SCI,RND .....	15
Calculations Involving the Memory .....	17
Ans Memory.....	17
Continuous Calculation.....	17

Variable M.....	18
Variables.....	18
<b>Scientific Functions.....</b>	<b>19</b>
Trigonometric and Inverse Trigonometric Functions.....	19
Hyperbolic and Inverse Hyperbolic Functions.....	20
Common Logarithms, Natural Logarithms and Antilogarithms .....	20
Square Root, Cube Root, Root, Square, Cube, Reciprocal, Factorial, Random Number, Circumference Ratio( $\pi$ ), Permutation and Combination .....	20
Converting Angular Measurements .....	21
Coordinate Systems ( Pol ( $x, y$ ), Rec ( $r, \theta$ )) ....	22
Expressing Numbers in Engineering Format.....	22
<b>Statistics .....</b>	<b>23</b>
Standard Deviation–SD.....	23
Regression–REG.....	25
Linear Regression.....	27
Logarithmic, Exponential, Mathematical Power and Inverse Regression.....	28
Quadratic Regression .....	28
<b>Technical Data.....</b>	<b>29</b>
Troubleshooting .....	29
Error Messages.....	30
Input Range .....	31
Sequence of Operations .....	33
Stack.....	34
Automatic Power-Saver .....	35
<b>Specifications.....</b>	<b>35</b>
<b>Regulatory Information.....</b>	<b>37</b>
<b>Customer Support .....</b>	<b>40</b>

## Using the protective case

Please do not slide the protective case over the LCD.

1. Before use, slide the calculator out of the protective case as shown below.
2. After use, slide the protective case onto the calculator, as shown below.

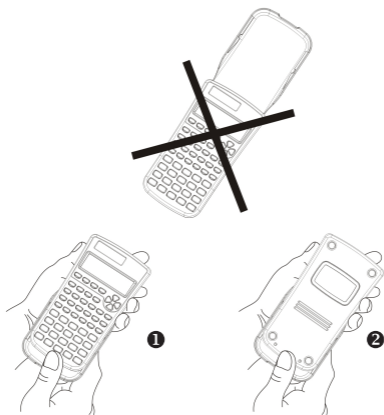

## Safety Precautions

Before using this calculator, please read the following safety precautions carefully. Keep this manual handy so that you can refer to it when needed.

## Notice



This symbol indicates that there is a risk of injury or damage if the specified safety precautions are ignored.

## Battery

- Keep battery out of the reach of children. If a battery is swallowed, seek urgent medical advice.
- Do not charge, attempt to disassemble, short circuit, or apply heat to the battery.
- When installing a new battery, orient it such that the positive sign is facing upwards.
- Use only the battery specified in this manual.

## Disposing of the calculator

- Do not dispose of this calculator in an incinerator. It might explode and cause injury or fire.
- The representations of the display and the keys in this manual are for explanatory purposes only and may not exactly match what you see on the calculator.

## Other Precautions

- Before using this calculator for the first time, press the **ON** key.
- The battery may lose some charge between the time the calculator leaves the factory and the time when it is purchased. Thus the original battery may not last as long as a new battery.

- When battery power is very low, the calculator's memory may become corrupt or be lost completely. To avoid loss of important information, keep a copy of it elsewhere.
- Avoid storing or using the calculator under extreme temperature conditions.

Low temperature will slow the calculator's response time, cause the display to appear incomplete, and shorten the life of the battery. In addition, the calculator should not be directly exposed to the sun or placed near a heater. High temperature may cause the casing to fade, distort the casing, or damage the internal circuitry.

- Avoid storing or using the calculator in damp conditions or when there is high humidity or excessive dust. Doing so will damage the internal circuitry.
- Do not drop the calculator or allow it to be subjected to extreme force.
- Do not twist, bend or otherwise distort the calculator.
- Note: Carrying the calculator in a pocket could cause it to twist or bend.
- Do not use a pen or other pointed object to press the calculator's keys.
- Use a soft dry cloth to clean the calculator. Opening the case of calculator voids the warranty.

If the calculator is very dirty, a neutral household cleanser diluted in water can be used to clean it. Dip a cloth in the solution and wring it out before applying it to the calculator. Do not use benzine, a diluting agent or any other volatile solvent to clean the calculator. Doing so may damage the casing and the keys.

## Two-Line Display

The calculator shows both the expression being calculated and the result of the calculation. These appear in a two-line display.







- The expression being calculated is shown on the upper line.
- The result is shown on the lower line.

If the result has more than three digits, a separator appears before each group of three digits.

## Preparing to Use the Calculator

### ■ Modes

Choose the appropriate mode before performing a calculation.

Type of Calculation	Operation	Calculation mode
Basic Calculation	 	COMP
Standard Deviation	 	SD
Calculation using Regression	 	REG

- Press the  key to display each settings screen in turn. Each settings screen is described later in this guide.
- Throughout this guide, the mode setting required for each type of calculation is given when the calculation is explained.



## Notes

- To return the calculator to its default settings, as indicated below press **SHIFT** **CLR** **2** (Mode) **=** in that order. The default settings are:

Calculation mode : COMP

Angle unit: Deg

Exponent display format: Norm 1

Fraction display:  $ab/c$

Decimal point character: Dot

- The mode indicator appears in the upper part of the display.
- Before calculating, check the current mode setting (COMP, REG or SD) and the angle unit (Deg, Rad or Grad).

### ■ Input Limit

- The memory of the calculator can accommodate 79 steps in any one calculation. When you press a number key or an arithmetic operator key (**+**, **-**, **×**, **÷**), it occupies one step. Pressing **SHIFT** or **ALPHA** does not occupy a step. So pressing **SHIFT** **↵**, for example, takes up only one step.
- When you input the 73<sup>rd</sup> step of any calculation, the cursor changes from " \_ " to " ■ " to alert you to the fact that the capacity of the memory is almost used up. If what you want to input contains more than 79 steps, separate the calculation into two or more smaller calculations and then combine them as you go.
- Press **Ans** to recall the previous result, which can then be used in the next calculation. Please see the section on *Key Memory* for more information about the **Ans** key.



## ■ Error Correction when Entering

- Press **◀** or **▶** to move the cursor to the position needed.
- Press **DEL** to delete the digit or function at the position of the cursor.
- Press the **SHIFT INS** keys to activate the insertion cursor **[ ]**. Whatever you insert now will appear at the cursor's current position.
- Press the **SHIFT INS** key to return the cursor to its normal functioning.

## ■ Recalling a Previous Calculation

- Each calculation and its result is kept in memory. Press **▲** to recall the previous calculation and its results. Press the **▲** key again to recall the next previous calculation, and so on.
- When a previous calculation is recalled, you can activate editing mode by pressing **◀** or **▶**.
- After any calculation, the calculation can be edited by pressing **◀** or **▶** immediately.
- Pressing **AC** does not clear the calculation memory. Therefore, when you press **AC** again, the previous calculations are still available.
- The capacity of the calculation memory to store expressions and calculation results is 128 bytes.
- The calculation memory is cleared if the:
  - **ON** key is pressed
  - **SHIFT CLR 2** (or **3**) **≡** are pressed (which initializes the calculator)
  - calculation mode is changed
  - power supply is turned off

## ■ Error Indicator

- If an error occurs, press  or . The calculation reappears and the cursor is located where the error is.

## ■ Multi-statement



A multi-statement is an expression consisting of two or more smaller expressions. The expressions are separated by a colon (:)

## ■ Exponent Display Format

The calculator can display up to 10 digits. Values needing more than 10 digits will automatically be displayed in exponent notation. Two exponent formats are available.

- To change the display format, press  repeatedly until the appropriate settings screen appears.

Fix	Sci	Norm
1	2	3

- For an exponent setting, press . In the settings screen that appears, press  to choose Norm 1 or  to choose Norm 2.

### ● Norm 1

Exponent notation is applied automatically to any number whose absolute value is greater than or equal to  $10^{10}$  or less than  $10^{-2}$ .

### ● Norm 2

Exponent notation is applied automatically to any number whose absolute value is greater than or equal to  $10^{10}$  or less than  $10^{-9}$ .

- In this manual, results are expressed in Norm 1 format.

## ■ Decimal Point and Separator

The display setting (Disp) screen is used to specify the required decimal mark and the character to use before groups of three digits.

- To change these settings, press **MODE** repeatedly until the settings screen appears.



- Press **1** **▶** to display the settings screen.
- Press the number key ( **1** or **2** ) corresponding to the setting you want:
  - 1** (Dot) : Decimal point and comma separator
  - 2** (Comma) : Decimal comma and point separator

## ■ Initializing the Calculator

- To initialize the calculator (which clears the memory and all variables, and resets all modes to their default settings) press: **SHIFT** **CLR** **3** (ALL) **=**

## Basic Calculations

### ■ Arithmetic Operations

To perform a basic calculation, select COMP mode by pressing **MODE** .

COMP.....**MODE** **1**

- When raising negative values to powers, make sure that the negative sign is inside the parentheses around the value. Please see the section on *Sequence of Operations* (page 33) for more information.

- A negative exponent does not need to be in parentheses.

$$\sin 4.56 \times 10^{-8} \rightarrow \boxed{\sin} \ 4.56 \ \boxed{\text{EXP}} \ \boxed{(-)} \ 8$$

- Example 1:  $3 \times (4 \times 10^{-7}) = 1.2 \times 10^{-6}$

$$3 \ \boxed{\times} \ 4 \ \boxed{\text{EXP}} \ \boxed{(-)} \ 7 \ \boxed{=}$$

- Example 2:  $2 \times (3+4) = 14$

$$2 \ \boxed{\times} \ \boxed{(} \ 3 \ \boxed{+} \ 4 \ \boxed{)} \ \boxed{=}$$

- You can omit the  $\boxed{)}$  at the end of an expression if the next key you press is  $\boxed{=}$ .

## ■ Calculation with fractions

- A value is automatically displayed in decimal format if the total number of digits of the fraction (integer + numerator + denominator + semicolon) is greater than 10.

- Example 1:  $\frac{1}{3} + \frac{2}{5} = \frac{11}{15}$

$$1 \ \boxed{\text{ab/c}} \ 3 \ \boxed{+} \ 2 \ \boxed{\text{ab/c}} \ 5 \ \boxed{=} \ \boxed{11 \ \text{┘} \ 15.}$$

- Example 2:  $3\frac{1}{2} + 2\frac{3}{4} = 6\frac{1}{4}$

$$3 \ \boxed{\text{ab/c}} \ 1 \ \boxed{\text{ab/c}} \ 2 \ \boxed{+} \\ 2 \ \boxed{\text{ab/c}} \ 3 \ \boxed{\text{ab/c}} \ 4 \ \boxed{=} \ \boxed{6 \ \text{┘} \ 1 \ \text{┘} \ 4.}$$

- Example 3:  $\frac{6}{9} = \frac{2}{3}$

$$6 \ \boxed{\text{ab/c}} \ 9 \ \boxed{=}$$

- Example 4:  $\frac{1}{4} + 1.8 = 2.05$

$$1 \ \boxed{\text{ab/c}} \ 4 \ \boxed{+} \ 1.8 \ \boxed{=}$$

- A calculation involving a fraction and a decimal generally yields a decimal result.

- **Converting between decimal and fractional display**

- Example 1:  $3.25 = 3\frac{1}{4}$     3.25 **=**

(Decimal  $\longleftrightarrow$  Fraction)    **ab/c**

**SHIFT** **d/c**

- Example 2:  $\frac{1}{5} \longleftrightarrow 0.2$

(Fraction  $\longleftrightarrow$  Decimal)    1 **ab/c** 5 **=**

**ab/c**

**ab/c**

- **Converting between Mixed and Improper Fractions**

- Example :  $2\frac{3}{4} \longleftrightarrow \frac{11}{4}$

2 **ab/c** 3 **ab/c** 4 **=**

**SHIFT** **d/c**

**SHIFT** **d/c**

- To change the fraction display format, press **MODE** repeatedly until the following screen appears.

Disp  
1

- Press **[1]** to display the settings screen.
- Press the number key ( **[1]** or **[2]** ) corresponding to the setting required:

**[1]** ( a**b/c** ) : Mixed fraction

**[2]** ( d/c ) : Improper fraction

- If you choose the d/c display format and enter a mixed fraction, an error will occur.

## ■ Calculating percentages

### ● About Calculating Percentages

- Example 1: Calculate 15% of 1000 ? (150)  
1000 **[x]** 15 **[SHIFT]** **[%]**
- Example 2: What percentage of 440 is 330 ? (75%)  
330 **[÷]** 440 **[SHIFT]** **[%]**
- Example 3: 1000 plus 15% ? (1150)  
1000 **[x]** 15 **[SHIFT]** **[%]** **[+]**
- Example 4: 1000 minus 15% ? (850)  
1000 **[x]** 15 **[SHIFT]** **[%]** **[-]**
- Example 5: If the original weight of a sample is 400g and a further 100g is added to it, what is the new weight as a percentage of the old weight ? (125%)  
100 **[+]** 400 **[SHIFT]** **[%]**
- Example 6: If the temperature increases from 60°C to 66°C, what is the percentage increase? What is it when the temperature increases to 69°C?  
(10% , 15%)  
66 **[-]** 60 **[SHIFT]** **[%]**  
**[▶]** **[▶]** 9 **[=]**

## ■ Calculations Involving Degrees, Minutes and Seconds

- You can convert between sexagesimal and decimal numbers.
- Example 1: Convert the decimal number 1.234 to its sexagesimal equivalent and then back to a decimal number again.

1.234 [=]

- Example 2: Calculate  $12^{\circ} 34' 56'' \times 7.89$

12  34  56   7.89 [=]

## ■ FIX, SCI, RND

- To change the display format settings, press  repeatedly until the screen below appears.

Fix	Sci	Norm
1	2	3

- Press the number key (, , or ) corresponding to the setting you want to change.

(Fix) : To set the number of decimal places

(Sci) : To set the number of significant digits

(Norm): To set the display format to normal

- Example 1:  $100 \div 3 \times 15$

100  3  15 [=]

(Now specify that you want numbers displayed with 3 decimal places.)

.....  (Fix)



(Note that only the display precision gets fixed to 3 digits. The calculations are still performed with the complete number.)

$$100 \div 3 = 33.333$$

$$\times 15 = 500.000$$

(Note that you can also force the calculator to round a number to the number of decimal places you have specified.)

$$100 \div 3 = 33.333$$

(Internally Rounded)  $\text{SHIFT}$   $\text{Rnd}$   $33.333$

$$\times 15 = 499.995$$

- Press  $\text{MODE}$  .....  $3$  (Norm)  $1$  to cancel the settings.

- Example 2:  $2 \div 3$

Display the result with two significant digits (Sci 2)

$\text{MODE}$  .....  $2$  (Sci)  $2$

$$2 \div 3 = 6.7 \times 10^{-01} \text{ SCI}$$

You can also display result in 10 significant digits (Sci 10) using (Sci)  $0$

- Press  $\text{MODE}$  .....  $3$  (Norm)  $1$  to cancel settings.

## Calculations Involving the Memory

To perform a calculation involving the memory, press **MODE** to enter COMP mode.

COMP.....**MODE** **1**

### ■ Ans Memory

- The Ans memory is updated with each new calculation when you press **=**.
- It is also updated when you press **SHIFT** **%**, **M+**, **SHIFT** **M-** or **SHIFT** **STO** after a letter (A to F, or M, X, or Y).
- Pressing **Ans** recalls the contents of the Ans memory.
- The Ans memory can only store one value at a time.
- The Ans memory is not updated if an error occurs when you use any of the above mentioned keys for a calculation.

### ■ Continuous Calculation

- The result currently displayed can be used as the first value in the next calculation. Simply press an operator key. Ans appears on the screen, indicating that the last answer obtained is to be used in the calculation.
- The previous result can also be used by the following functions: ( $x^2$ ,  $x^3$ ,  $x^{-1}$ ,  $x!$ , **DRG**▶),  $+$ ,  $-$ ,  $^{\wedge}$  ( $x^y$ ),  $\sqrt[x]{\quad}$ ,  $\times$ ,  $\div$ ,  $nPr$  or  $nCr$ .

## ■ Variable M

- You can use the variable M to compute accumulated totals which can be put into the variable M directly, or they can also be added to or subtracted from the number stored in variable M.
- To clear all the numerical values in the separate variable M, press  $\boxed{0}$   $\boxed{\text{SHIFT}}$   $\boxed{\text{STO}}$   $\boxed{\text{M}}$  (M+)

$12 + 3 = 15$	$12 \boxed{+} 3 \boxed{\text{SHIFT}} \boxed{\text{STO}} \boxed{\text{M}}$ (M+)
$45 - 6 = 39$	$45 \boxed{-} 6 \boxed{\text{M}+}$
$- 38 \times 2 = 76$	$38 \boxed{\times} 2 \boxed{\text{SHIFT}} \boxed{\text{M}-}$
<hr/>	
(Total) $-22$	$\boxed{\text{RCL}} \boxed{\text{M}}$ (M+)

## ■ Variables

- There are 9 variables: A to F, M, X and Y. These are used for storing data, constants, calculation results and other numerical values.
- To clear a single variable, store zero into it. For example,  $\boxed{0}$   $\boxed{\text{SHIFT}}$   $\boxed{\text{STO}}$   $\boxed{\text{A}}$   
This clears variable A.
- To clear the values of all variables, press  $\boxed{\text{SHIFT}}$   $\boxed{\text{CLR}}$   
 $\boxed{1}$  (Mcl)  $\boxed{=}$
- Example:

$$\underline{1234} \div 20 = 61.7$$

$$\underline{1234} \div 25 = 49.36$$

$$1234 \boxed{\text{SHIFT}} \boxed{\text{STO}} \boxed{\text{A}} \boxed{\div} 20 \boxed{=}$$
$$\boxed{\text{ALPHA}} \boxed{\text{A}} \boxed{\div} 25 \boxed{=}$$

## Scientific Functions

To perform a scientific function calculation, press **MODE** to enter COMP mode.

COMP.....**MODE** **1**

- Some scientific calculations may take longer than other types of calculations.
- You can start the next calculation after the calculation result displays on the screen .
- $\pi = 3.14159265359$

### ■ Trigonometric and Inverse Trigonometric Functions

- To change the current angle units (degrees, radians or grads), press **MODE** repeatedly until the following screen appears.

Deg	Rad	Gra
1	2	3

- Now press the number key ( **1** , **2** or **3** ) corresponding to the angle unit you want to use.  
(Note that  $90^\circ = \frac{\pi}{2}$  radians = 100 grads )

- Example 1:  $\sin 12^\circ 34' 56'' = 0.217840422$

**MODE** ..... **1** (Deg)      **sin** 12 **°** 34 **'** 56 **''** **=**

- Example 2:  $\cos\left(\frac{\pi}{3}\text{ rad}\right) = 0.5$

**MODE** ..... **2** (Rad)      **cos** ( **SHIFT** **π** **÷** 3 ) **=**

- Example 3:  $\cos^{-1} \frac{\sqrt{2}}{2} = 0.25\pi \text{ (rad)} (= \frac{\pi}{4} \text{ (rad)})$

**MODE** ..... **2** (Rad)  
**SHIFT** **cos<sup>-1</sup>** ( **√** 2 **÷** 2 ) **=** **Ans** **÷** **SHIFT** **π** **=**

- Example 4:  $\tan^{-1} 0.789 = 38.27343992$

**MODE** ..... **1** (Deg)      **SHIFT** **tan<sup>-1</sup>** 0.789 **=**

## ■ Hyperbolic and Inverse Hyperbolic Functions

- Example 1:  $\sinh 4.5 = 45.00301115$

**hyp** **sin** 4.5 **=**

- Example 2:  $\cosh^{-1} 60 = 4.787422291$

**hyp** **SHIFT** **cos<sup>-1</sup>** 60 **=**

## ■ Common Logarithms, Natural Logarithms and Antilogarithms

- Example 1:  $\log 1.2 = 0.079181246$

**log** 1.2 **=**

- Example 2:  $\ln 90 (= \log_e 90) = 4.49980967$

**ln** 90 **=**

$$\ln e = 1$$

**ln** **ALPHA** **e** **=**

- Example 3:  $e^{10} = 22026.46579$

**SHIFT** **e<sup>x</sup>** 10 **=**

- Example 4:  $10^{2.5} = 316.227766$

**SHIFT** **10<sup>x</sup>** 2.5 **=**

- Example 5:  $2^{-5} = 0.03125$

2 **y<sup>x</sup>** **(-)** 5 **=**

- Example 6:  $(-2)^6 = 64$

**(** **(-)** 2 **)** **y<sup>x</sup>** 6 **=**

- Note that the negative value in the previous example had to be placed in parentheses. Please see the *Sequence of Operations* section for details.

## ■ Square Root, Cube Root, Root, Square, Cube, Reciprocal, Factorial, Random Number, Circumference Ratio ( $\pi$ ), Permutation and Combination

- Example 1:  $\sqrt{2} + \sqrt{3} \times \sqrt{4} = 4.878315178$

**√** 2 **+** **√** 3 **×** **√** 4 **=**

- Example 2:  $\sqrt[3]{4} + \sqrt[3]{-5} = -0.122574894$

**SHIFT** **∛** 4 **+** **SHIFT** **∛** **(-)** 5 **=**

- Example 3:  $\sqrt[4]{123} (=123^{\frac{1}{4}}) = 3.330245713$   
 $4$  **SHIFT**  **$\frac{1}{x}$**   $123$  **=**

- Example 4:  $123+45^2=2148$       $123$  **+**  $45$  **x2** **=**

- Example 5:  $54^3=157464$       $54$  **x3** **=**

- Example 6:  $\frac{1}{\frac{1}{2} - \frac{1}{3}} = 6$   
 $($   $2$  **x<sup>-1</sup>** **-**  $3$  **x<sup>-1</sup>**  $)$  **x<sup>-1</sup>** **=**

- Example 7:  $6!=720$       $6$  **SHIFT**  **$x!$**  **=**

- Example 8: Generate a random number between  $0.000$  and  $0.999$   
**SHIFT** **Ran#** **=**

(The value shown above is just an example. A different random number is likely to be produced each time)

- Example 9:  $2\pi = 6.283185307$       $2$  **SHIFT**  **$\pi$**  **=**

- Example 10: How many different 5-digit numbers can be produced with the digits 1 to 6 if no digit can be repeated (12345 allowed, 11234 not allowed)? (720)  
 $6$  **SHIFT** **nPr**  $5$  **=**

- Example 11: How many different groups of three people can be organized with 10 people? (120)  
 $10$  **nCr**  $3$  **=**

## ■ Converting Angular Measurements

- Press the **SHIFT** **DRG** keys to display the following screen.

D	R	G
1	2	3

- Press **1**, **2** or **3** to change the displayed value to the corresponding angle unit.

- Example: Change 2 . 34 radians to degrees.

$$\text{MODE} \dots\dots \text{1 (Deg)}$$

$$2.34 \text{ SHIFT DRG} \text{ 2 (R) = } \begin{array}{|l|} \hline 2.34r \\ \hline 134.0721241 \\ \hline \end{array}$$

## ■ Coordinate Systems ( Pol ( $x, y$ ), Rec ( $r, \theta$ ))

- The result will be stored in variables E and F automatically.

- Example 1: Express the point defined by the polar coordinates (  $r = 4, \theta = 30^\circ$  ) in rectangular coordinates (  $x, y$  ). ( Deg )

$$x = 3.464101615 \quad \text{SHIFT Rec} \text{ 4 } \text{ , } \text{ 30 } \text{ ) } \text{ =}$$

$$y = 2 \quad \text{RCL } \text{ F}$$

- Press **RCL E** to display the value of  $x$  or press **RCL F** to display the value of  $y$ .

- Example 2: Express the point defined by the rectangular coordinates (  $2, \sqrt{5}$  ) in polar coordinates (  $r, \theta$  ). ( Rad )

$$r = 3 \quad \text{Pol} \text{ 2 } \text{ , } \sqrt{\text{ 5 }} \text{ ) } \text{ =}$$

$$\theta = 0.84106867 \quad \text{RCL } \text{ F}$$

- Press **RCL E** to display the value of  $r$  or press **RCL F** to display the value of  $\theta$ .

## ■ Expressing Numbers in Engineering Format

- Example 1: Change 54321 meters to kilometers

$$\text{----> } 54.321 \times 10^3 \quad 54321 \text{ = } \text{ENG}$$

(km)

- Example 2: Change 0.01234 grams to milligrams

$$\text{----> } 12.34 \times 10^{-3} \quad 0.01234 \text{ = } \text{ENG}$$

(mg)

# Statistics

## ■ Standard Deviation-SD

Press **MODE** to select SD mode for statistical calculations with standard deviations.

SD ..... **MODE** **2**

- In SD and REG modes, the **M+** key acts as the **DT** key.
- Press the **SHIFT CLR 1** (Scl) **=** keys to erase the statistics memory before you enter data.
- Press the following key to input data.  
<  $x$  data > **DT**
- Input data to calculate  $n, \Sigma x, \Sigma x^2, \bar{x}, x^{\sigma n}, x^{\sigma n-1}$ .

To display this result	Press these keys
$\Sigma x^2$	<b>SHIFT S-SUM 1</b>
$\Sigma x$	<b>SHIFT S-SUM 2</b>
$n$	<b>SHIFT S-SUM 3</b>
$\bar{x}$	<b>SHIFT S-VAR 1</b>
$x^{\sigma n}$	<b>SHIFT S-VAR 2</b>
$x^{\sigma n-1}$	<b>SHIFT S-VAR 3</b>

- Example: Calculate  $x^{\sigma n-1}, x^{\sigma n}, \bar{x}, n, \Sigma x, \Sigma x^2$  given the following data:

15, 14, 11, 15, 13, 13, 14, 12

In SD mode :

**SHIFT CLR 1** (Scl) **=** (Stat clear)

15 **DT** n= SD 1.

Each time you press **DT**, the data you have just entered is stored. The  $n=$  value shown on the screen indicates the number of data pairs you have entered.

14 **DT** 11 **DT** 15 **DT**  
13 **DT** **DT** 14 **DT** 12 **DT**

Standard deviation of the sample  
( $x^{\sigma n-1}$ ) = 1.407885953

**SHIFT S-VAR 3 =**



Standard deviation of the population

$$(x \sigma n) = 1.316956719$$

SHIFT S-VAR 2 =

Mean ( $\bar{x}$ ) = 13.375

SHIFT S-VAR 1 =

Number of data points ( $n$ ) = 8

SHIFT S-SUM 3 =

Sum of the data values ( $\sum x$ ) = 107

SHIFT S-SUM 2 =

Sum of the squares of the data values

$$(\sum x^2) = 1445$$

SHIFT S-SUM 1 =

## Data Entry Hints

- Press **DT** **DT** to enter the same data twice.
- Press **SHIFT** **;** to repeat the same data item several times. For example, press 100 **SHIFT** **;** 15 **DT** to enter the data value 100 15 times.
- You can perform these operations in any sequence, not necessarily in the same order as in the example above.
- Press **▲** or **▼** to scroll through the entered data.
- Edit the data displayed as desired. The new data replace the old data after inputting new data and pressing the key **=**. Therefore, if you want to perform some other operations (calculation, display calculation result and so on), you must first press the key **AC** to exit from the data displaying screen.
- To change a data value, scroll to it, enter the new value and press **=**. (However, you must press **DT** if you want to add the value as a new data item.)
- To delete a data value displayed by pressing **▲** and **▼**, press **SHIFT** **⌫**.
- The values are stored in the memory. If "Data Full" appears on the screen, there is no more memory available to store new data. In this case, press **=** to display the following menu:

Edit OFF	ESC
1	2

Press **[2]** to quit the data input operation without storing the entered data values. Alternatively, press **[1]** to clear the values but remain in data input mode.

- Press **[SHIFT] [CLR]** to cancel data input.
- In SD or REG mode, you cannot display or edit data items once you change to another mode or choose a different regression type (Lin, Log, Exp, Pwr, Inv, Quad).

## ■ Regression-REG

Calculations involving regression require REG mode. Press **[MODE]** key to select REG mode.

REG..... **[MODE] [3]**

- In SD mode and REG mode, the **[M+]** key acts as the **[DT]** key.
- When you select REG mode, the following screen appears.

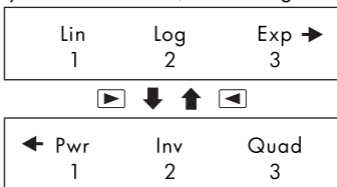

- Press the number key (**[1]**, **[2]** or **[3]**) corresponding to the regression type you want to use.
  - [1]** (Lin) : Linear regression
  - [2]** (Log) : Logarithmic regression
  - [3]** (Exp) : Exponential regression
  - ▶ [1]** (Pwr) : Mathematical power regression
  - ▶ [2]** (Inv) : Inverse regression
  - ▶ [3]** (Quad) : Quadratic regression
- Before entering data, press the **[SHIFT] [CLR] [1] (Scl) [=]** keys to clear the statistics memory.
- Press the following key to input data.  
<x data> **[.]** <y data> **[DT]**
- The regression calculation result is determined by the data input. The result can be displayed using the following syntax and keys.

To display the result	Press these keys
$\Sigma x^2$	SHIFT S-SUM 1
$\Sigma x$	SHIFT S-SUM 2
$n$	SHIFT S-SUM 3
$\Sigma y^2$	SHIFT S-SUM ► 1
$\Sigma y$	SHIFT S-SUM ► 2
$\Sigma xy$	SHIFT S-SUM ► 3
$\bar{x}$	SHIFT S-VAR 1
$x\sigma n$	SHIFT S-VAR 2
$x\sigma n-1$	SHIFT S-VAR 3
$\bar{y}$	SHIFT S-VAR ► 1
$y\sigma n$	SHIFT S-VAR ► 2
$y\sigma n-1$	SHIFT S-VAR ► 3
Regression coefficient A	SHIFT S-VAR ► ► 1
Regression coefficient B	SHIFT S-VAR ► ► 2
With non quadratic regression types:	
Regression coefficient $r$	SHIFT S-VAR ► ► 3
$\hat{x}$	SHIFT S-VAR ► ► ► 1
$\hat{y}$	SHIFT S-VAR ► ► ► 2

- To display quadratic regression calculation results , use the following syntax and keys.

To display the result	Press these keys
$\Sigma x^3$	SHIFT S-SUM ► ► 1
$\Sigma x^2y$	SHIFT S-SUM ► ► 2
$\Sigma x^4$	SHIFT S-SUM ► ► 3
Regression coefficient C	SHIFT S-VAR ► ► 3
$\hat{x}1$	SHIFT S-VAR ► ► ► 1
$\hat{x}2$	SHIFT S-VAR ► ► ► 2
$\hat{y}$	SHIFT S-VAR ► ► ► 3

- The statistics values calculated can be stored in variables and used in expressions.

## ● Linear Regression

- The formula for linear regression is  $y=A+Bx$
- Example: The relationship between atmospheric pressure and air temperature is given in the following table:

Air Temperature	Atmospheric Pressure
10°C	1003 hPa
15°C	1005 hPa
20°C	1010 hPa
25°C	1011 hPa
30°C	1014 hPa

The following explains how to calculate the coefficients of the regression formula and how the formula can then be used to determine air temperature at a particular pressure (1000hPa) and the air pressure at a particular temperature (-5°C). In the process, we also determine the coefficient of determination ( $r^2$ ) and the sample covariance

In regression (REG) mode:

(mode 3) **1** (Lin)

**SHIFT CLR 1** (Scl) **=** (Stat clear)

10 **▸** 1003 **DT**

$$\left( \frac{\sum xy - n \cdot \bar{x} \cdot \bar{y}}{n-1} \right)$$

**n=** REG 1.

Each time you press **DT**, the data you have just entered is stored. The  $n =$  value shown on the screen indicates the number of data pairs you have entered.

15 **▸** 1005 **DT**

20 **▸** 1010 **DT** 25 **▸** 1011 **DT**

30 **▸** 1014 **DT**

Regression coefficient A=997.4

**SHIFT S-VAR** **▶▶** **1** **=**

Regression coefficient B=0.56

**SHIFT S-VAR** **▶▶** **2** **=**

Regression coefficient

$r=0.982607368$

**SHIFT S-VAR** **▶▶** **3** **=**

The atmospheric pressure when the air temperature is -5°C =994.6

**( (-) 5 )** **SHIFT S-VAR** **▶▶▶** **2** **=**

The air temperature when atmospheric pressure is 1000 hPa =4.642857143

1000 **SHIFT S-VAR** **▶▶▶** **1** **=**

Coefficient of determination

=0.965517241

**SHIFT S-VAR** **▶▶** **3** **x<sup>2</sup>** **=**

Sample covariance=35

**(** **SHIFT S-SUM** **▶** **3** **-**

**SHIFT S-SUM** **3** **x** **SHIFT S-VAR** **1** **x**

**SHIFT S-VAR** **▶** **1** **)** **÷**

**(** **SHIFT S-SUM** **3** **-** **1** **)** **=**

- **Logarithmic, Exponential, Mathematical Power and Inverse Regression**

- Use these regression types in the same way that you use linear regression (see above).

- The corresponding regression formulas are:

Logarithmic regression	$y=A+B \cdot \ln x$
Exponential regression	$y=A \cdot e^{B \cdot x}$ ( $\ln y=\ln A+B x$ )
Mathematical Power Regression	$y=A \cdot x^B$ ( $\ln y=\ln A+B \ln x$ )
Inverse regression	$y=A+B \cdot \frac{1}{x}$

- **Quadratic Regression**

- The regression formula for quadratic regression is  $y=A+Bx+Cx^2$

- Example: In this example, we perform quadratic regression on the given data to determine the regression formula and then use the formula to calculate  $\hat{y}$  (the estimated value of  $y$ ) when  $x_i = 16$  and the  $\hat{x}$  value (the estimated value of  $x$ ) when  $y_i = 20$ .

$x_i$	$y_i$
29	1.6
50	23.5
74	38.0
103	46.4
118	48.0

In regression (REG) mode:

**▶** **3** (Quad)

**SHIFT CLR 1** (Scl) **=** (Stat clear)

29 **▸** 1.6 **DT** 50 **▸** 23.5 **DT**  
 74 **▸** 38.0 **DT** 103 **▸** 46.4 **DT**  
 118 **▸** 48.0 **DT**

Regression coefficient

$A = -35.59856934$

**SHIFT S-VAR ▶ ▶ 1 =**

Regression coefficient

$B = 1.495939414$

**SHIFT S-VAR ▶ ▶ 2 =**

Regression coefficient

$C = -6.71629667 \times 10^{-3}$

**SHIFT S-VAR ▶ ▶ 3 =**

Estimated value of  $\hat{y} = -13.38291067$  when  $x_i = 16$

16 **SHIFT S-VAR ▶ ▶ ▶ 3 =**

Estimated value of  $\hat{x}_1 = 47.14556728$  when  $y_i = 20$

20 **SHIFT S-VAR ▶ ▶ ▶ 1 =**

Estimated value of  $\hat{x}_2 = 175.5872105$  when  $y_i = 20$   
20 **SHIFT** **S-VAR** **▶** **▶** **▶** **2** **=**

## Data Entry Hints

- Press **DT** **DT** to enter the same data twice.
- Press **SHIFT** **;** to enter the same data several times. For example, pressing 30 **,** 40 **SHIFT** **;** 5 **DT** enters the data pair {30, 40} 5 times.
- The same data entry hints noted for Standard Deviation mode (see earlier) also apply in Regression mode.
- When carrying out statistical calculations, do not store any data in variables A to F, X or Y. These variables are used as temporary memory during calculations and thus their contents could get overwritten during a calculation.
- Variables A to F, X and Y are cleared when you select REG mode and choose a regression type (Lin, Log, Exp, Pwr, Inv, Quad). They are also cleared if you switch to another regression type.

## Technical Data

### ■ Troubleshooting.....

If the result of a calculation is not what you expected, or if an error occurs please carry out the following steps.

1. Press the **SHIFT** **CLR** **2** (Mode) **=** keys in that order to reset all modes and settings.
2. Check that the formula or expression you entered is correct.
3. Select the correct mode and try the calculation again.

If the problem persists, press **ON**. The calculator will perform a self-check and, if an abnormality is found, clear all stored data. For this reason, you should always have a copy of all important information kept separate from the calculator.

## ■ Error Messages

If an error message occurs, the calculator stops running immediately. Press **AC** to clear the error message, or press **◀** or **▶** to redisplay the calculation so that you can correct it.

### **Math ERROR**

---

- Causes**
- The result exceeds the calculator's computational range.
  - You tried to enter a value that exceeds the calculator's input range.
  - The operation requested is not mathematically valid (for example, dividing by 0).
- Correction**
- Check that the input value is within the allowable input range. If you are using memory variables, check that the stored values will not cause the calculator to exceed its computational range.

### **Stack ERROR**

---

- Causes**
- The capacity of the number stack or operator stack has been exceeded. The number stack can have 10 levels while the operator stack can have 24.
- Correction**
- Simplify the calculation.
  - Break up the calculation into two or more parts.

### **Syntax ERROR**

---

- Causes**
- The number entered or operator selected was not expected or was not in the correct form.
- Correction**
- Press **◀** or **▶** to redisplay the calculation. The cursor will be at the place where the error occurred. Correct the problem and then proceed.

### **Arg ERROR**

---

- Causes**
- The parameter you entered was not expected or was not in the correct form.
- Correction**
- Press **◀** or **▶** to redisplay the calculation. The cursor will be at the place where the error occurred. Correct the problem and then proceed.

## ■ Input Range

Functions	Input Range	
$\sin x$	DEG	$0 \leq  x  \leq 4.4999999999 \times 10^{10}$
	RAD	$0 \leq  x  \leq 785398163.3$
	GRA	$0 \leq  x  \leq 4.9999999999 \times 10^{10}$
$\cos x$	DEG	$0 \leq  x  \leq 4.5000000008 \times 10^{10}$
	RAD	$0 \leq  x  \leq 785398164.9$
	GRA	$0 \leq  x  \leq 4.9999999999 \times 10^{10}$
$\tan x$	DEG	Same as $\sin x$ , except when $ x  = (2n-1) \times 90$
	GRA	Same as $\sin x$ , except when $ x  = (2n-1) \times \frac{\pi}{2}$
	RAD	Same as $\sin x$ , except when $ x  = (2n-1) \times 100$
$\sin^{-1} x$	$0 \leq  x  \leq 1$	
$\cos^{-1} x$		
$\tan^{-1} x$	$0 \leq  x  \leq 9.9999999999 \times 10^{99}$	
$\sinh x$	$0 \leq  x  \leq 230.2585092$	
$\cosh x$		
$\sinh^{-1} x$	$0 \leq  x  \leq 4.9999999999 \times 10^{99}$	
$\cosh^{-1} x$	$1 \leq x \leq 4.9999999999 \times 10^{99}$	
$\tanh x$	$0 \leq  x  \leq 9.9999999999 \times 10^{99}$	
$\tanh^{-1} x$	$0 \leq  x  \leq 9.9999999999 \times 10^{-1}$	
$\log x / \ln x$	$0 < x \leq 9.9999999999 \times 10^{99}$	
$10^x$	$-9.9999999999 \times 10^{99} \leq x \leq 99.9999999999$	
$e^x$	$-9.9999999999 \times 10^{99} \leq x \leq 230.2585092$	
$\sqrt{x}$	$0 \leq x < 1 \times 10^{100}$	
$x^2$	$ x  < 1 \times 10^{50}$	



$1/x$	$ x  < 1 \times 10^{100}; x \neq 0$
$\sqrt[3]{x}$	$ x  < 1 \times 10^{100}$
$x!$	$0 \leq x \leq 69$ ( $x$ is an integer)
$nPr$	$0 \leq n < 1 \times 10^{10}, 0 \leq r \leq n$ ( $n, r$ are integers) $1 \leq \{ n! / (n-r)! \} < 1 \times 10^{100}$
$nCr$	$0 \leq n < 1 \times 10^{10}, 0 \leq r \leq n$ ( $n, r$ are integers) $1 \leq [ n! / \{ r!(n-r)! \} ] < 1 \times 10^{100}$
$\text{Pol}(x, y)$	$ x ,  y  \leq 9.999999999 \times 10^{49}$ $(x^2 + y^2) \leq 9.999999999 \times 10^{99}$
$\text{Rec}(r, \theta)$	$0 \leq r \leq 9.999999999 \times 10^{99}$ $\theta$ : Same as for $\sin x$
”””	$ a , b, c < 1 \times 10^{100} \quad 0 \leq b, c$
←””	$ x  < 1 \times 10^{100}$ Decimal ↔ Sexagesimal Conversions $0^\circ \ 0^\circ \ 0^\circ \leq  x  \leq 999999^\circ \ 59^\circ$
$\wedge(x^y)$	$x > 0: -1 \times 10^{100} < y \log x < 100$ $x = 0: y > 0$ $x < 0: y = n, \frac{1}{2n+1}$ ( $n$ is an integer) However: $-1 \times 10^{100} < y \log  x  < 100$
$\sqrt[x]{y}$	$y > 0: x \neq 0$ $-1 \times 10^{100} < 1/x \log y < 100$ $y = 0: x > 0$ $y < 0: x = 2n+1, \frac{1}{n}$ ( $n \neq 0, n$ is an integer) However: $-1 \times 10^{100} < 1/x \log  y  < 100$
$a \ b/c$	The total number of integer, numerator, and denominator digits must be 10 or less (including division marks)
SD (REG)	$ x  < 1 \times 10^{50} \quad x^{\sigma n}, y^{\sigma n}, \bar{x}, \bar{y}: n \neq 0$ $ y  < 1 \times 10^{50} \quad x^{\sigma n-1}, y^{\sigma n-1}, A, B, r: n \neq 0, 1$ $ n  < 1 \times 10^{100}$

- \* Each operation is accurate to  $\pm 1$  in the 10th digit. However, calculations involving multiple operations will cause the error to accumulate. This is also observed with internal calculations involving multiple operations such as  $^{\wedge}(x^y)$ ,  $\sqrt[x]{y}$ ,  $x!$ ,  $\sqrt[3]{\phantom{x}}$ ,  $nPr$ ,  $nCr$  and the like.

Note that the error may be greater near an inflection point of a function.

## ■ Sequence of Operations

Calculations are carried out in the following order:

- ① Coordinate transformations:  $\text{Pol}(x, y)$ ,  $\text{Rec}(r, \theta)$
- ② A-type functions:  
These are functions where a value must be entered before you press a function key.  
 $x^3$ ,  $x^2$ ,  $x^{-1}$ ,  $x!$ ,  $\pi$ ,  $\hat{x}$ ,  $\hat{x}1$ ,  $\hat{x}2$ ,  $\hat{y}$   
Converting angular values (DRG▶)
- ③ Mathematical power and root:  $^{\wedge}(x^y)$ ,  $\sqrt[x]{\phantom{x}}$
- ④  $a/b/c$
- ⑤  $\ln \pi$ ,  $e$  (base of natural logarithm), implied multiplication involving a memory or variable name:  $2\pi$ ,  $3e$ ,  $5A$ ,  $\pi A$  etc.
- ⑥ B-type functions  
These are functions where a function key must be pressed before a value is entered.  
 $\sqrt{\phantom{x}}$ ,  $\sqrt[3]{\phantom{x}}$ ,  $\log$ ,  $\ln$ ,  $e^x$ ,  $10^x$ ,  $\sin$ ,  $\cos$ ,  $\tan$ ,  $\sin^{-1}$ ,  $\cos^{-1}$ ,  $\tan^{-1}$ ,  $\sinh$ ,  $\cosh$ ,  $\tanh$ ,  $\sinh^{-1}$ ,  $\cosh^{-1}$ ,  $\tanh^{-1}$ ,  $(-)$
- ⑦ Implied multiplication preceding a B-type function:  
 $2\sqrt{3}$ ,  $A\log 2$  etc.
- ⑧ Permutations and combinations:  $nPr$ ,  $nCr$

⑨  $\times, \div$

⑩  $+, -$

- In an expression where two components have the same priority, the calculation is performed from right to left.

$$e^x \ln \sqrt{120} \rightarrow e^x (\ln (\sqrt{120}))$$

- Other calculations will be carried out from left to right.
- Calculations in parentheses are performed first.
- If the calculation includes a parameter with a negative number, the negative number should be in parentheses. Since a minus sign ( $-$ ) is considered a B-type function, care is needed when negative numbers are included in A-type functions, mathematical powers or root operations.

Example:  $(-3)^4 = 81$   
 $-3^4 = -81$

## ■ Stack

This "stack" is an area of memory used to temporarily save values (the number stack) and the order of operations (the operator stack) during the calculation. The number stack has a maximum capacity of 10 while the operator stack has a maximum capacity of 24. If a calculation exceeds the stack capacity, a Stack ERROR will occur.

- Example:

$$2 \times ( ( 3 + 4 \times ( 5 + 6 ) \div 7 ) \div 8 ) + 9 =$$

① ② ③ ④ ⑤

① ② ③ ④ ⑤ ⑥ ⑦

①	2
②	3
③	4
④	5
⑤	6
⋮	

①	×
②	(
③	(
④	+
⑤	×
⑥	(
⑦	+
⋮	

- The calculation will be carried out in the order described in Sequence of Operations. During the course of a calculation, the number and order stacks are cleared.

## ■ Automatic Power-Saver

If you have not used the calculator for 5 minutes, it will automatically turn off. Press **ON** to turn it on again.

## Specifications

### Power:

- Solar Cell: Built into the front of the calculator
- Button Cell: One (1) Alkaline button battery (LR44)

**Battery Life:** Standby (ON but no calculation) about 3 years; OFF about 5 years.

**Dimensions:** 152 x 81 x 13 mm (unit)  
153.96 X 80.72 X 16.4 mm (with protective case)

**Weight:** 93g (unit)  
120g (with protective case)

**Operating Temperature:** 0°C ~ 40°C

## Disposal of Waste Equipment by Users in Private Households in the European Union



This symbol on the product or packaging indicates that this product must not be disposed of with your other household waste. Instead, it is your responsibility to dispose of the product by handing it over to a designated collection point for the recycling of waste electrical and electronic equipment. The separate collection and recycling of your waste equipment at the time of disposal will help to

conserve natural resources and ensure that it is recycled in a manner that protects human health and the environment. For more information about where you can drop off your waste equipment for recycling, please contact your local city office, your household waste disposal service or the shop where you purchased the product.

## **Regulatory Notices**

### **Federal Communications Commission Notice**

This equipment has been tested and found to comply with the limits for a Class B digital device, pursuant to Part 15 of the FCC Rules. These limits are designed to provide reasonable protection against harmful interference in a residential installation. This equipment generates, uses, and can radiate radio frequency energy and, if not installed and used in accordance with the instructions, may cause harmful interference to radio communications. However, there is no guarantee that interference will not occur in a particular installation. If this equipment does cause harmful interference to radio or television reception, which can be determined by turning the equipment off and on, the user is encouraged to try to correct the interference by one or more of the following measures:

- Reorient or relocate the receiving antenna.
- Increase the separation between the equipment and the receiver.
- Consult the dealer or an experienced radio or television technician for help.

### **Modifications**

The FCC requires the user to be notified that any changes or modifications made to this device that are not expressly approved by Hewlett-Packard Company may void the user's authority to operate the equipment.

### **Declaration of Conformity for Products Marked with FCC Logo, United States Only**

This device complies with Part 15 of the FCC Rules.

Operation is subject to the following 2 conditions:

1. This device may not cause harmful interference.
2. This device must accept any interference received, including interference that may cause undesired operation.

If you have any questions about the product that are not related to this declaration, write to  
Hewlett-Packard Company  
P. O. Box 692000, Mail Stop 530113  
Houston, TX 77269-2000

For questions regarding this FCC declaration, write to  
Hewlett-Packard Company  
P. O. Box 692000, Mail Stop 510101  
Houston, TX 77269-2000  
or call HP at 281-514-3333

To identify your product, refer to the part, series, or model number located on the product.

### **Canadian Notice**

This Class B digital apparatus meets all requirements of the Canadian Interference-Causing Equipment Regulations.

### **Avis Canadien**

Cet appareil numérique de la classe B respecte toutes les exigences du Règlement sur le matériel brouilleur du Canada.

### **European Union Regulatory Notice**

This product complies with the following EU Directives:

Low Voltage Directive 2006/95/EC

EMC Directive 2004/108/EC

Compliance with these directives implies conformity to applicable harmonized European standards (European Norms) which are listed on the EU Declaration of Conformity issued by Hewlett-Packard for this product or product family. This compliance is indicated by the following conformity marking placed on the product:



Hewlett-Packard GmbH, HQ-TRE, Herrenberger Strasse  
140, 71034 Boeblingen, Germany

## JAPANESE NOTICE

この装置は、情報処理装置等電波障害自主規制協議会（VCCI）の基準に基づくクラスB情報技術装置です。この装置は、家庭環境で使用することを目的としていますが、この装置がラジオやテレビジョン受信機に近接して使用されると、受信障害を引き起こすことがあります。

取扱説明書に従って正しい取り扱いをして下さい。

## Warranty Statement

HP 10s scientific calculator; Warranty period: 12 months

1. HP warrants to you, the end-user customer, that HP hardware, accessories and supplies will be free from defects in materials and workmanship after the date of purchase, for the period specified above.

2. If HP receives notice of such defects during the warranty period, HP will, at its option, either repair or replace products which prove to be defective. Replacement products may be either new or like-new.

For complete warranty information by country please go to <http://www.hp.com/calculators>.

**FOR CONSUMER TRANSACTIONS IN AUSTRALIA AND NEW ZEALAND: THE WARRANTY TERMS CONTAINED IN THIS STATEMENT, EXCEPT TO THE EXTENT LAWFULLY PERMITTED, DO NOT EXCLUDE, RESTRICT OR MODIFY AND ARE IN ADDITION TO THE MANDATORY STATUTORY RIGHTS APPLICABLE TO THE SALE OF THIS PRODUCT TO YOU.**



# Customer Support

<b>Asia Pacific</b>	<b>Country :</b>	<b>Telephone numbers</b>
	Australia	1300-551-664 or 03-9841-5211
	China	010-68002397
	Hong Kong	2805-2563
	Indonesia	+65 6100 6682
	Japan	+852 2805-2563
	Malaysia	+65 6100 6682
	New Zealand	09-574-2700
	Philippines	+65 6100 6682
	Singapore	6100 6682
	South Korea	2-561-2700
	Taiwan	+852 2805-2563
	Thailand	+65 6100 6682
	Vietnam	+65 6100 6682

<b>Europe</b>	<b>Country :</b>	<b>Telephone numbers</b>
	Austria	01 360 277 1203
	Belgium	02 620 00 85 or 02 620 00 86
	Czech Republic	296 335 612
	Denmark	82 33 28 44
	Finland	09 8171 0281
	France	01 4993 9006
	Germany	069 9530 7103
	Greece	210 969 6421
	Netherlands	020 654 5301
	Ireland	01 605 0356
	Italy	02 754 19 782
	Luxembourg	2730 2146
	Norway	23500027
	Portugal	021 318 0093
	Russia	495 228 3050

<b>Country :</b>	<b>Telephone numbers</b>
South Africa	0800980410
Spain	913753382
Sweden	08 5199 2065
Switzerland	022 827 8780 (French) 01 439 5358 (German) 022 567 5308 (Italian)
United Kingdom	0207 458 0161

### **L.America**

<b>Country :</b>	<b>Telephone numbers</b>
Anguila	1-800-711-2884
Antigua	1-800-711-2884
Argentina	0-800- 555-5000
Aruba	800-8000 or 800-711-2884
Bahamas	1-800-711-2884
Barbados	1-800-711-2884
Bermuda	1-800-711-2884
Bolivia	800-100-193
Brazil	0-800-709-7751
British Virgin Islands	1-800-711-2884
Cayman Island	1-800-711-2884
Curacao	001-800-872-2881 or 800-711-2884
Chile	800-360-999
Colombia	01-8000-51-4746-8368 (01-8000-51- HP INVENT)
Costa Rica	0-800-011-0524
Dominica	1-800-711-2884
Dominican Republic	1-800-711-2884
Ecuador	1-999-119 or 800-711-2884 (Andinatel) 1-800-225-528 or 800-711-2884 (Pacifitel)
El Salvador	800-6160
French Antilles	0-800-990-011 or 800-711-2884

<b>Country :</b>	<b>Telephone numbers</b>
French Guiana	0-800-990-011 or 800-711-2884
Grenada	1-800-711-2884
Guadelupe	0-800-990-011 or 800-711-2884
Guatemala	1-800-999-5105
Guyana	159-800-711-2884
Haiti	183-800-711-2884
Honduras	800-0-123 or 800-711-2884
Jamaica	1-800-711-2884
Martinica	0-800-990-011 or 877-219-8671
Mexico	01-800-474-68368 (800 HP INVENT)
Montserrat	1-800-711-2884
Netherland Antilles	001-800-872-2881 or 800-711-2884
Nicaragua	1-800-0164 or 800-711-2884
Panama	001-800-711-2884
Paraguay	(009) 800-541-0006
Peru	0-800-10111
Puerto Rico	1-877 232 0589
St. Lucia	1-800-478-4602
St Vincent	01-800-711-2884
St. Kitts & Nevis	1-800-711-2884
St. Marteen	1-800-711-2884
Suriname	156-800-711-2884
Trinidad & Tobago	1-800-711-2884
Turks & Caicos	01-800-711-2884
US Virgin Islands	1-800-711-2884
Uruguay	0004-054-177
Venezuela	0-800-474-68368 (0-800 HP INVENT)

**N.America**

<b>Country :</b>	<b>Telephone numbers</b>
Canada	800-HP-INVENT
USA	(905) 206-4663 or 800-HP INVENT