



# HP EliteBook 2170p Notebook PC

Maintenance and Service Guide

© Copyright 2012 Hewlett-Packard  
Development Company, L.P.

Bluetooth is a trademark owned by its proprietor and used by Hewlett-Packard Company under license. Intel and Core are trademarks or registered trademarks of Intel Corporation in the United States and other countries. Microsoft and Windows are U.S. registered trademarks of Microsoft Corporation. SD Logo is a trademark of its proprietor.

The information contained herein is subject to change without notice. The only warranties for HP products and services are set forth in the express warranty statements accompanying such products and services. Nothing herein should be construed as constituting an additional warranty. HP shall not be liable for technical or editorial errors or omissions contained herein.

Second Edition: October 2012

First Edition: June 2012

Document Part Number: 677134-002

## Safety warning notice

---

**⚠ WARNING!** To reduce the possibility of heat-related injuries or of overheating the device, do not place the device directly on your lap or obstruct the device air vents. Use the device only on a hard, flat surface. Do not allow another hard surface, such as an adjoining optional printer, or a soft surface, such as pillows or rugs or clothing, to block airflow. Also, do not allow the AC adapter to contact the skin or a soft surface, such as pillows or rugs or clothing, during operation. The device and the AC adapter comply with the user-accessible surface temperature limits defined by the International Standard for Safety of Information Technology Equipment (IEC 60950).

---



---

# Table of contents

<b>1 Product description .....</b>	<b>1</b>
<b>2 External component identification .....</b>	<b>9</b>
Display .....	9
Buttons and fingerprint reader (select models only) .....	10
Keys .....	11
Lights .....	12
TouchPad .....	13
Front .....	14
Left side .....	15
Right side .....	16
Bottom .....	18
<b>3 Illustrated parts catalog .....</b>	<b>20</b>
Service tag .....	21
Computer major components .....	22
Display assembly subcomponents .....	31
Cable Kit .....	33
Mass storage devices .....	34
Miscellaneous parts .....	35
Sequential part number listing .....	36
<b>4 Removal and replacement procedures .....</b>	<b>49</b>
Preliminary replacement requirements .....	49
Tools required .....	49
Service considerations .....	49
Plastic parts .....	49
Cables and connectors .....	49
Drive handling .....	50
Grounding guidelines .....	50
Electrostatic discharge damage .....	50

Packaging and transporting guidelines .....	52
Component replacement procedures .....	54
Service tag .....	54
Computer feet .....	55
Battery .....	56
SIM .....	57
Service cover .....	58
Hard drive .....	59
Fingerprint reader board .....	61
WLAN module .....	62
WWAN module .....	64
Memory module .....	66
Fan .....	68
Keyboard .....	69
Base enclosure .....	76
Audio board .....	80
Speakers .....	81
Power switch board .....	83
Media Card reader assembly .....	84
RTC battery .....	86
System board .....	88
Heat sink .....	91
Smart Card reader assembly .....	93
Top cover .....	94
Display assembly subcomponents .....	97

## **5 Computer Setup (BIOS) and Advanced System Diagnostics ..... 105**

Windows 8 .....	105
Using Computer Setup .....	105
Starting Computer Setup .....	105
Navigating and selecting in Computer Setup .....	106
Restoring factory settings in Computer Setup .....	107
Updating the BIOS .....	107
Determining the BIOS version .....	107
Downloading a BIOS update .....	108
Using Advanced System Diagnostics .....	109
Windows 7 .....	110
Starting Computer Setup .....	110
Using Computer Setup .....	110
Navigating and selecting in Computer Setup .....	110
Restoring factory settings in Computer Setup .....	111

Updating the BIOS .....	112
Determining the BIOS version .....	112
Downloading a BIOS update .....	112
Using Advanced System Diagnostics .....	113
SuSE Linux (SLED) .....	114
Starting Computer Setup .....	114
Using Computer Setup .....	114
Navigating and selecting in Computer Setup .....	114
Restoring factory settings in Computer Setup .....	115
Updating the BIOS .....	115
Determining the BIOS version .....	116
Downloading a BIOS update .....	116
Using Advanced System Diagnostics .....	117
<b>6 Specifications .....</b>	<b>118</b>
Computer specifications .....	118
11.6-inch SGA display specifications .....	119
Hard drive specifications .....	120
<b>7 Backup and recovery .....</b>	<b>121</b>
Windows 8 .....	121
Backing up your information .....	121
Performing a system recovery .....	122
Using the Windows recovery tools .....	122
Using f11 recovery tools .....	123
Using Windows 8 operating system media (purchased separately) .....	124
Using Windows Refresh for quick and easy recovery .....	124
Remove everything and reinstall Windows .....	125
Using HP Software Setup .....	126
Windows 7 .....	126
Creating recovery media with HP Recovery Disc Creator .....	127
Creating recovery media .....	127
Backing up your information .....	127
Performing a system recovery .....	128
Using the Windows recovery tools .....	128
Using f11 recovery tools .....	129
Using a Windows 7 operating system DVD (purchased separately) .....	130
SuSE Linux (SLED) .....	131
Creating backups .....	131
Backing up your information .....	131
Performing a system recovery .....	132

USB Recovery option (select models only) .....	133
Remove everything and reinstall SLED .....	134
<b>8 Power cord set requirements .....</b>	<b>135</b>
Requirements for all countries .....	135
Requirements for specific countries and regions .....	136
<b>9 Recycling .....</b>	<b>137</b>
<b>Index .....</b>	<b>138</b>



---

# 1 Product description

---

Category	Description
<b>Product Name</b>	HP EliteBook 2170p Notebook PC
<b>Processors</b>	<ul style="list-style-type: none"><li>• Intel® Quad Core® i7-3687U 2.10-GHz processor (SC turbo up to 3.30-GHz, 4.0-MB L3 cache, 17 W)</li><li>• Intel Dual Core i7-3667U 1.80-GHz processor (SC turbo up to 2.90-GHz; 4.0-MB L3 cache, 17 W)</li><li>• Intel Dual Core i5-3437U 1.90-GHz processor (SC turbo up to 2.90-GHz, 3.0-MB L3 cache, 17 W)</li><li>• Intel Dual Core i5-3427U 1.70-GHz processor (SC turbo up to 2.70-GHz; 3.0-MB L3 cache, 17 W)</li><li>• Intel Dual Core i5-3317U 1.70-GHz processor (SC turbo up to 2.60-GHz; 3.0-MB L3 cache, 17 W)</li><li>• Intel Dual Core i3-3217U 1.80-GHz processor (3.0-MB L3 cache, 17 W)</li></ul>
<b>Chipset</b>	Mobile Intel QM77 chipset
<b>Graphics</b>	Intel HD Graphics 4000 integrated universal memory architecture (UMA) graphics
<b>Panel</b>	<p>11.6-in light-emitting diode (LED), high-definition (HD), AntiGlare (AG), SVA (1368×768) display with and without webcam and microphone</p> <p>All display assemblies include two wireless local area network (WLAN) antenna cables and two wireless wide area network (WWAN) antenna cables</p> <p>Supports low voltage differential signalling (LVDS)</p> <p>Supports optional privacy filter</p>

---

<b>Category</b>	<b>Description</b>
<b>Memory</b>	<p>Two customer-accessible/upgradable memory module slots</p> <p>DDR3-12800 (1600-MHz) dual channel support</p> <p>Supports 16384-MB of system RAM in the following configurations:</p> <ul style="list-style-type: none"> <li>• 16384-MB (8192-MB×2, dual channel)</li> <li>• 12288-MB (8192-MB×1+4096-MB×1, dual channel)</li> <li>• 8192-MB (8192-MB×1 or 4096×2, dual channel)</li> <li>• 4096-MB (4096-MB×1 or 2048-MB×2, dual channel)</li> <li>• 2048-MB (2048×1)</li> </ul>
<b>Hard drive</b>	<p>Supports 6.35-cm (2.5-in) hard drives in 9.5-mm (.37-in) and 7.0-mm (.28-in) thicknesses (all hard drives use the same bracket)</p> <p>Customer-accessible</p> <p>Serial ATA</p> <p>Supports the following hard drives:</p> <ul style="list-style-type: none"> <li>• 750-GB, 7200-rpm, 9.5-mm</li> <li>• 500-GB, 7200-rpm, 7.0-mm self-encrypting drive (SED)</li> <li>• 500-GB, 7200-rpm, 7.0-mm</li> <li>• 320-GB, 7200-rpm, 7.0-mm</li> </ul>
<b>Solid-state drive</b>	<p>Solid-state drive (SSD) mounts in the same bracket as the hard drive</p> <p>Customer-accessible</p> <p>Serial ATA type II and III</p> <p>Supports the following SSDs:</p> <ul style="list-style-type: none"> <li>• 256-GB SED III</li> <li>• 240-GB III</li> <li>• 180-GB III</li> <li>• 160-GB II</li> <li>• 128-GB III</li> </ul>
<b>Audio and video</b>	<p>Two stereo speakers</p> <p>HD audio with SRS Premium Sound PRO</p> <p>Integrated 720p HD webcam (supports no camera option)</p> <p>Integrated dual-array microphone on computer models equipped with a webcam</p> <p>Integrated mono microphone on computer models not equipped with a webcam</p>

<b>Category</b>	<b>Description</b>
<b>Ethernet</b>	<p>Intel 82579LM 10/100/1000 Ethernet network interface card (NIC)</p> <p>NIC Power Down technology</p> <p>S3/S4/S5 wake on LAN</p> <p>Ethernet cable not included</p>
<b>Wireless</b>	<p>Integrated wireless local area network (WLAN) options by way of wireless module</p> <p>Two WLAN antennas built into display assembly</p> <p>Support for the following WLAN formats:</p> <ul style="list-style-type: none"> <li>• Atheros AR9462 802.11a/b/g/n 2x2 Bluetooth 4.0 Combo Adapter</li> <li>• Broadcom 4313GN 802.11b/g/n 1x1 WiFi and 20702 Bluetooth 4.0 Combo Adapter</li> <li>• Intel Centrino Advanced-N 6235 WLAN module</li> <li>• Intel Centrino Advanced-N 6205 WLAN module</li> </ul> <p>Support for no WLAN option</p> <hr/> <p>Integrated wireless wide area network (WWAN) options by way of wireless module</p> <p>Two world-wide/5-band WWAN antennas built into display assembly</p> <p>Secured by subscriber identity module (SIM, user-accessible inside battery bay)</p> <p>Support for the following WWAN formats:</p> <ul style="list-style-type: none"> <li>• HP hs2350 HSPA+ Mobile Broadband Module</li> <li>• HP lt2523 LTE/HSPA+ Mobile Broadband Module</li> <li>• HP lt2522 LTE/EV-DO Mobile Broadband Module</li> <li>• HP un2430 EV-DO/HSPA Mini Card</li> <li>• HP un2430 EV-DO/HSPA Mobile Broadband Module</li> </ul> <p>Support for no WWAN option</p> <p>Support for WWAN after market option</p>
<b>External media cards</b>	<p>Integrated Smart Card reader</p> <p>Secure Digital (SD) Media reader slot with push-push technology, supporting the following digital card formats:</p> <ul style="list-style-type: none"> <li>• MultiMediaCard (MMC)</li> <li>• MMC+</li> <li>• Secure Digital (SD) Memory Card</li> <li>• SDHC</li> <li>• SDXC</li> </ul>

Category	Description
<b>Ports</b>	<ul style="list-style-type: none"> <li>• Audio-in (mono microphone)/audio-out (stereo headphone) combo jack</li> <li>• Battery connector</li> <li>• DisplayPort 1.1a</li> <li>• Docking connector</li> <li>• HP Smart AC adapter</li> <li>• RJ-45 (Ethernet)</li> <li>• USB 3.0 ports (2: 1 USB 3.0 charging port, 1 USB 3.0 port)</li> <li>• VGA (Dsub 15-pin) supporting: 1920×1200 external resolution @ 75 Hz, hot plug and unplug and autodetection for correct output to wide-aspect vs. standard aspect video</li> </ul>
<b>Keyboard/pointing devices</b>	<p>Chiclet-style keyboard with numeric keypad (upper-left justified), dual-point, spill-resistant with drain, durakeys, backlit (optional)</p> <p>Gesture support: MultiTouch gestures enabled, two-finger scrolling, and pinch-zoom as default</p> <p>Taps enabled by default</p> <p>Support for TouchPad with image sensor</p> <p>Support for 2-way scroll</p>
<b>Power requirements</b>	<p>Supports the following AC adapters:</p> <ul style="list-style-type: none"> <li>• 65-W HP Smart AC adapter (PFC, RC/V, EM, 3-wire)</li> <li>• 65-W HP Smart AC adapter (non-PFC, 3-wire)</li> <li>• 65-W HP travel AC adapter (non-PFC, 3-wire)</li> </ul> <p>Support for 6-cell, 48-Wh, 2.20-Ah and 4-cell, 30-Wh, 2.00-Ah Li ion batteries</p>
<b>Security</b>	<p>Support for security cable lock</p> <p>Support for fingerprint reader and no fingerprint reader option</p> <p>Support for Trusted Platform Module (TPM) 1.2 (Infineon, soldered down) and TPM Enhanced Drive Lock (not supported in Asia and the People's Republic of China)</p> <p>Integrated Smart Card reader (active)</p> <p>Full volume encryption</p> <p>Preboot authentication (password, Smart Card)</p>

---

Category	Description
<b>Operating system</b>	<b>Preinstalled:</b> <ul style="list-style-type: none"><li data-bbox="592 281 1155 306">• Windows® 8 ML 64 with Microsoft Basics (Japan only)</li><li data-bbox="592 333 1222 359">• Windows 8 Professional 64 with Microsoft Basics (Japan only)</li><li data-bbox="592 386 1453 411">• Windows 8 Professional 64 DPK with Windows 7 Professional 64 and 32 (Japan only)</li><li data-bbox="592 438 1206 464">• Windows 7 Home Premium 64 and 32 with Microsoft Basics</li><li data-bbox="592 491 1177 516">• Windows 7 Professional 64 and 32 with Microsoft Basics</li><li data-bbox="592 543 890 569">• Windows 7 Service Pack 1</li><li data-bbox="592 596 724 621">• FreeDOS</li><li data-bbox="592 648 1110 674">• SUSE Linux (SLED; People's Republic of China only)</li></ul>

---

Category	Description
<b>Operating system</b> <i>(continued)</i>	<b>Preinstalled with Microsoft Office:</b> <ul style="list-style-type: none"> <li>• Windows 8 CH 64-bit with Office 2010 Transition OPK (People's Republic of China only)</li> <li>• Windows 8 EM 64-bit with Office 2010 Transition OPK (not available in Japan)</li> <li>• Windows 8 ML 64-bit with Office 2010 Business and Home (Japan only; requires configuration with Office Personal Japan 2010 app AV)</li> <li>• Windows 8 ML 64-bit with Office 2010 Personal (Japan only; requires configuration with Office Personal Japan 2010 app AV)</li> <li>• Windows 8 ML 64-bit with Office 2010 Professional (Japan only; requires configuration with Office Personal Japan 2010 app AV)</li> <li>• Windows 8 ML 64-bit with Office 2010 Transition OPK (not available in Japan)</li> <li>• Windows 8 Professional 64-bit DPK with Windows 7 Professional 64- and 32-bit with Office 2010 Business and Home (Japan only; requires configuration with Office Personal Japan 2010 app AV)</li> <li>• Windows 8 Professional 64-bit DPK with Windows 7 Professional 64- and 32-bit with Office 2010 Personal (Japan only; requires configuration with Office Personal Japan 2010 app AV)</li> <li>• Windows 8 Professional 64-bit DPK with Windows 7 Professional 64- and 32-bit with Office 2010 Professional (Japan only; requires configuration with Office Personal Japan 2010 app AV)</li> <li>• Windows 8 Professional 64-bit DPK with Windows 7 Professional 64- and 32-bit with Office 2010 Starter (not available in Asia-Pacific countries and regions, Japan, or the People's Republic of China)</li> <li>• Windows 8 Professional 64-bit with Office 2010 Business and Home (Japan only; requires configuration with Office Personal Japan 2010 app AV)</li> <li>• Windows 8 Professional 64-bit with Office 2010 Personal (Japan only; requires configuration with Office Personal Japan 2010 app AV)</li> <li>• Windows 8 Professional 64-bit with Office 2010 Professional (Japan only; requires configuration with Office Personal Japan 2010 app AV)</li> <li>• Windows 8 Professional 64-bit with Office 2010 Transition OPK (not available in Japan)</li> <li>• Windows 7 Home Basic 32-bit with Office Starter (emerging markets only)</li> <li>• Windows 7 Home Premium 64- and 32-bit with Office Starter (not available in Japan)</li> <li>• Windows 7 Home Premium 64-bit with Office 2010 Personal (only in Japan)</li> <li>• Windows 7 Home Premium 64-bit with Office 2010 Home &amp; Business (only in Japan)</li> <li>• Windows 7 Home Premium 64-bit with Office 2010 Personal (only in Japan)</li> <li>• Windows 7 Home Premium 64-bit with Office 2010 Professional (only in Japan)</li> </ul>
	<i>(Continued)</i>

Category	Description
<b>Operating system</b> <i>(continued)</i>	<p data-bbox="592 226 1085 254"><b>Preinstalled with Microsoft Office:</b> <i>(Continued)</i></p> <ul data-bbox="592 279 1460 525" style="list-style-type: none"> <li data-bbox="592 279 1372 336">• Windows 7 Professional 64- and 32-bit with Office 2010 Starter (not available in Japan)</li> <li data-bbox="592 361 1396 417">• Windows 7 Professional 64- and 32-bit with Office 2010 Business &amp; Home (only in Japan)</li> <li data-bbox="592 443 1404 470">• Windows 7 Professional 64- and 32-bit with Office 2010 Personal (only in Japan)</li> <li data-bbox="592 495 1436 522">• Windows 7 Professional 64- and 32-bit with Office 2010 Professional (only in Japan)</li> </ul>
	<p data-bbox="592 550 869 577"><b>Restore media—DR-DVD:</b></p> <ul data-bbox="592 602 1460 745" style="list-style-type: none"> <li data-bbox="592 602 1380 659">• Windows 8 (available with any Windows 8 operating system and required with Windows 8 Professional 64-bit DPK with Windows 7 image)</li> <li data-bbox="592 684 1460 741">• Windows 7 (available with any Windows 7 HP, Windows 7 Professional loc, Windows 7 HB, or Windows 8 Professional 64-bit DPK with Windows 7 image)</li> </ul>
	<p data-bbox="592 770 869 798"><b>Restore media—OS-DVD:</b></p> <ul data-bbox="592 823 1460 1155" style="list-style-type: none"> <li data-bbox="592 823 1444 879">• Windows 8 Professional 64-bit (required with Windows 8 Professional 64-bit DPK with Windows image)</li> <li data-bbox="592 905 1428 961">• Windows 7 Home Basic 32-bit (available with any Windows 7 Home Basic location except Asia-Pacific countries and regions and the People's Republic of China)</li> <li data-bbox="592 987 1444 1043">• Windows 7 Home Premium 64- and 32-bit (available with any Windows 7 Premium location except Asia-Pacific countries and regions and the People's Republic of China)</li> <li data-bbox="592 1068 1460 1150">• Windows 7 Professional 64- and 32-bit (available with any Windows 7 Professional or Windows 8 Professional 64bit DPK with Windows image location except Asia-Pacific countries and regions and the People's Republic of China)</li> </ul>
	<p data-bbox="592 1180 694 1207"><b>Certified:</b></p> <ul data-bbox="592 1232 1109 1318" style="list-style-type: none"> <li data-bbox="592 1232 798 1260">• Microsoft WHQL</li> <li data-bbox="592 1285 1109 1312">• SuSE Linux Enterprise (SLED) 64-bit Service Pack 2</li> </ul>

---

<b>Category</b>	<b>Description</b>
<b>Operating system</b> <i>(continued)</i>	<b>Web-only support:</b> <ul style="list-style-type: none"><li>• Windows 8 32-bit</li><li>• Windows XP Pro 32-bit</li><li>• Windows 7 Enterprise 64- and 32-bit</li><li>• Windows 7 Ultimate 64- and 32-bit</li></ul>
<b>Serviceability</b>	End user replaceable parts: <ul style="list-style-type: none"><li>• AC adapter</li><li>• Battery</li><li>• Hard drive</li><li>• Keyboard</li><li>• Memory module</li><li>• Solid-state drive</li><li>• WLAN module</li><li>• WWAN module</li></ul>

---



## 2 External component identification

### Display

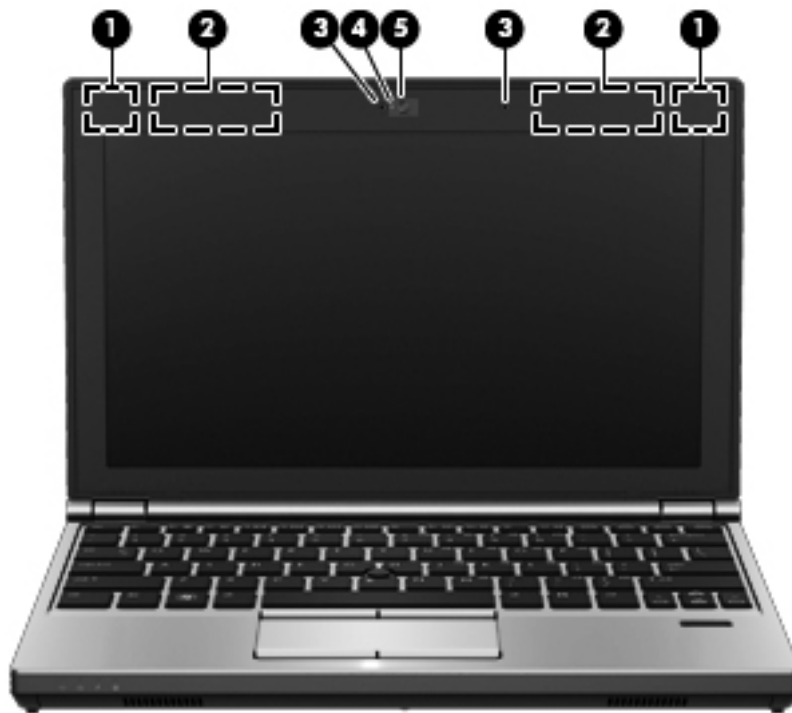

Item	Component	Description
(1)	WLAN antennas (2)*	Send and receive wireless signals to communicate with WLANs (select models only).
(2)	WWAN antennas (2)*	Send and receive wireless signals to communicate with WWANs (select models only).
(3)	Internal microphones (2)	Record sound.
(4)	Webcam light (select models only)	On: The webcam is in use.

Item	Component	Description
(5)	Webcam (select models only)	Records video and captures still photographs.  To use the webcam, do the following: <ul style="list-style-type: none"> <li>In Windows 8—Access Help and Support. From the Start screen, type h, and then select <b>Help and Support</b>.</li> <li>In Windows 7—Select <b>Start &gt; All Programs &gt; Communication and Chat &gt; HP Webcam</b>.</li> </ul>

\*The antennas are not visible from the outside of the computer. For optimal transmission, keep the areas immediately around the antennas free from obstructions. To see wireless regulatory notices, do the following:

- In Windows 8—See the section of the *Regulatory, Safety, and Environmental Notices* that applies to your country or region. To access the user guides, from the Start screen, select the **HP Support Assistant app**, select **My computer**, and then select **User guides**.
- In Windows 7—See the section of the *Regulatory, Safety, and Environmental Notices* that applies to your country or region.

## Buttons and fingerprint reader (select models only)

 **NOTE:** Your computer may look slightly different from the illustration in this section.



Item	Component	Description
(1)	TouchPad on/off button	Turns the TouchPad on and off.
(2)	Fingerprint reader (select models only)	Allows a fingerprint logon instead of a password logon.

# Keys

 **NOTE:** Your computer may look slightly different from the illustration in this section.

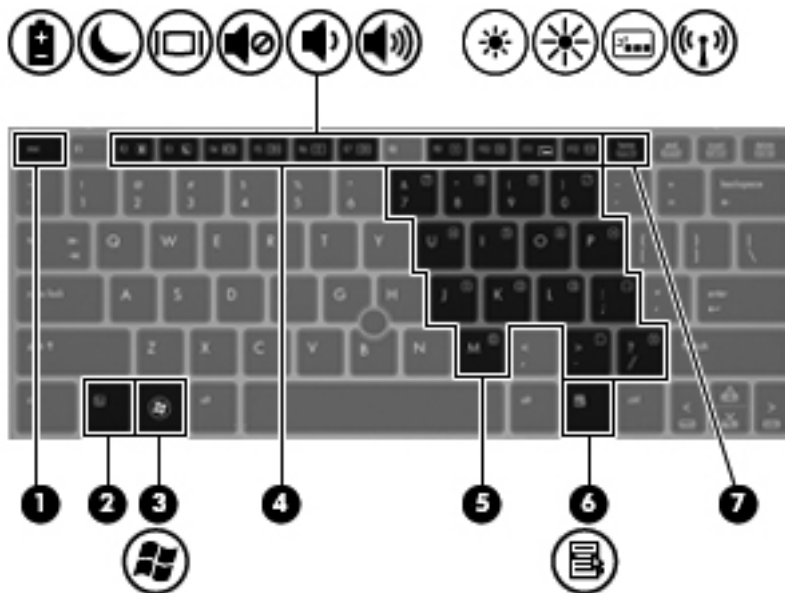

Item	Component	Description
(1)	esc key	Displays system information when pressed in combination with the <a href="#">fn</a> key.
(2)	fn key	Executes frequently used system functions when pressed in combination with a function key, the <a href="#">num lk</a> key, the <a href="#">esc</a> key, or other keys.
(3)	Windows logo key	Displays the Windows Start menu.
(4)	Function keys	Execute frequently used system functions when pressed in combination with the <a href="#">fn</a> key.
(5)	Embedded numeric keypad	When the keypad is turned on, it can be used like an external numeric keypad.  Each key on the keypad performs the function indicated by the icon in the upper-right corner of the key.
(6)	Windows applications key	Displays a shortcut menu for items beneath the cursor.
(7)	num lk key	Turns the embedded numeric keypad on and off when pressed in combination with the <a href="#">fn</a> key.

# Lights

 **NOTE:** Your computer may look slightly different from the illustration in this section.

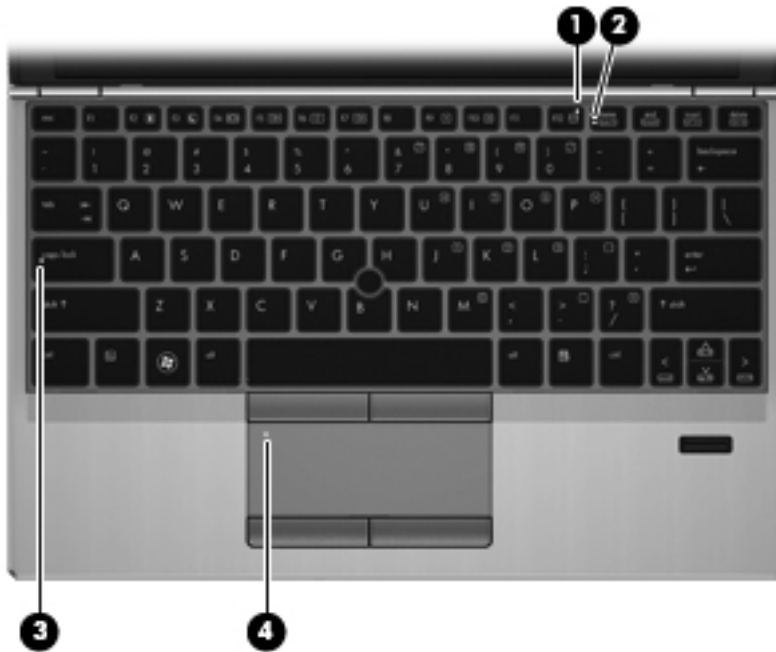

Item	Component	Description
(1)	Wireless light	<ul style="list-style-type: none"><li>Off: An integrated wireless device, such as a WLAN device, a WWAN device, and/or a Bluetooth device, is on (select models only).</li><li>Amber: All wireless devices are off (select models only).</li></ul>
(2)	Num lock light	On: Num lock is on.
(3)	Caps lock light	On: Caps lock is on.
(4)	TouchPad light	<ul style="list-style-type: none"><li>Amber: The TouchPad is off.</li><li>Off: The TouchPad is on.</li></ul>

# TouchPad

 **NOTE:** Your computer may look slightly different from the illustration in this section.

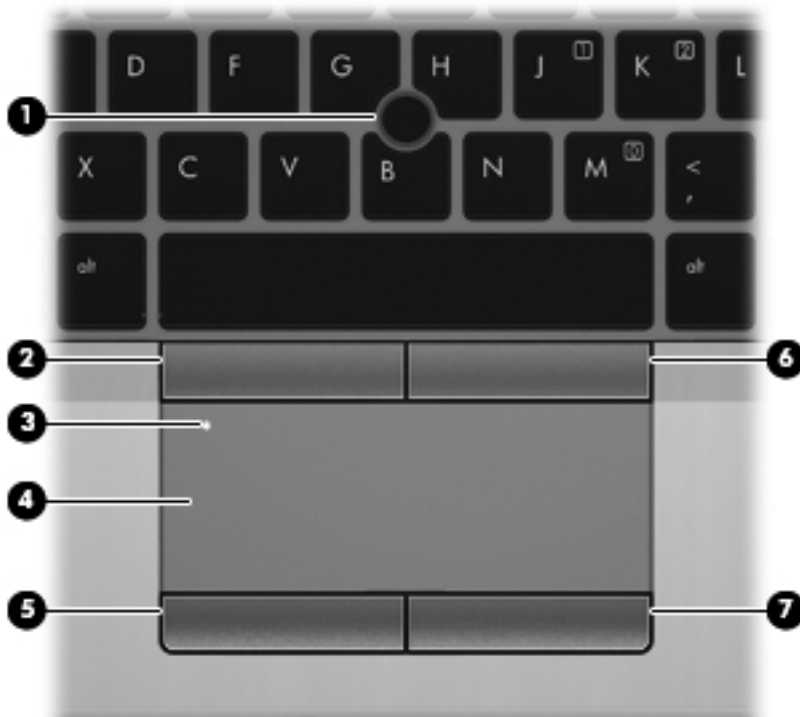

Item	Component	Description
(1)	Pointing stick	Moves the pointer and selects or activates items on the screen.
(2)	Left pointing stick button	Functions like the left button on an external mouse.
(3)	TouchPad on/off button	Turns the TouchPad on or off.
(4)	TouchPad zone	Moves the pointer and selects or activates items on the screen.
(5)	Left TouchPad button	Functions like the left button on an external mouse.
(6)	Right pointing stick button	Functions like the right button on an external mouse.
(7)	Right TouchPad button	Functions like the right button on an external mouse.

# Front

 **NOTE:** Your computer may look slightly different from the illustration in this section.

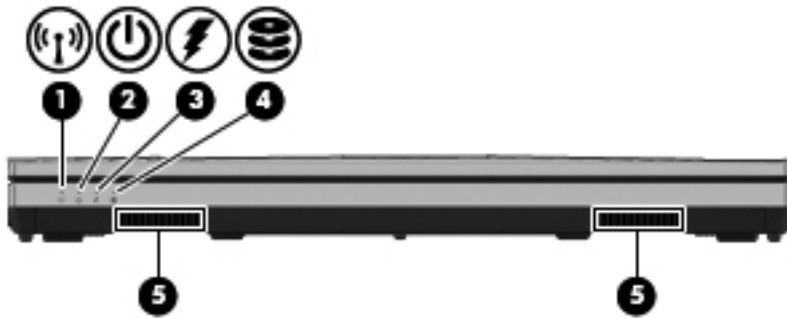

Item	Component	Description
(1)	Wireless light	<ul style="list-style-type: none"> <li>White: An integrated wireless device, such as a WLAN device and/or a WWAN device, is on.</li> <li>Amber: All wireless devices are off.</li> </ul>
(2)	Power light	<ul style="list-style-type: none"> <li>On: The computer is on.</li> <li>Blinking: The computer is in the Sleep state.</li> <li>Off: The computer is off or in Hibernation.</li> </ul>
(3)	AC adapter/Battery light	<ul style="list-style-type: none"> <li>Amber: The computer is connected to external power and the battery is charged from 0 to 90 percent.</li> <li>White: The computer is connected to external power and the battery is charged from 90 to 99 percent.</li> <li>Blinking amber: A battery that is the only available power source has reached a low battery level. When the battery reaches a critical battery level, the battery light begins blinking rapidly.</li> <li>Off: The battery is fully charged.</li> </ul>
(4)	Hard drive light	<ul style="list-style-type: none"> <li>Blinking white: The hard drive is being accessed.</li> <li>Amber: HP 3D DriveGuard has temporarily parked the hard drive.</li> </ul>
(5)	Speakers (2)	<p>Produce SRS Premium Sound or SRS Premium Sound PRO (select models only).</p> <p><b>NOTE:</b> To use the SRS Premium Sound PRO software, do the following:</p> <ul style="list-style-type: none"> <li>Windows 8 – From the Start screen, type <i>SRS</i>, and then select <b>SRS Premium Sound</b>.</li> <li>Windows 7 – Select <b>Start &gt; All Programs &gt; SRS Premium Sound</b>.</li> </ul>

## Left side

 **NOTE:** Your computer may look slightly different from the illustration in this section.

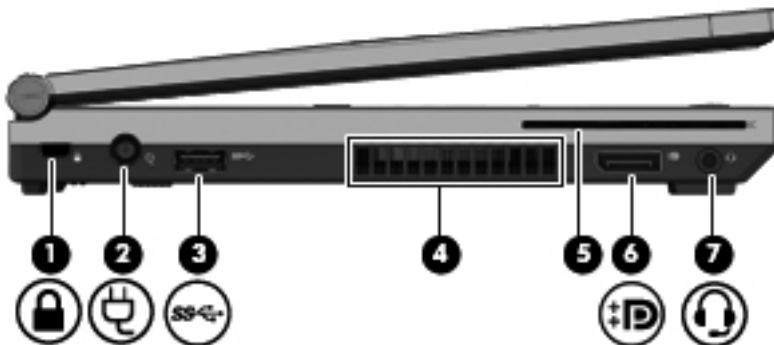

Item	Component	Description
(1)	Security cable slot	Attaches an optional security cable to the computer. <b>NOTE:</b> The security cable is designed to act as a deterrent, but it may not prevent the computer from being mishandled or stolen.
(2)	Power connector	Connects an AC adapter.
(3)	USB 3.0 port	Connects optional USB 3.0 devices and provide enhanced USB power performance.
(4)	Vent	Enables airflow to cool internal components. <b>NOTE:</b> The computer fan starts up automatically to cool internal components and prevent overheating. It is normal for the internal fan to cycle on and off during routine operation.
(5)	Smart Card reader (select models only)	Supports optional smart cards.
(6)	DisplayPort	Connects an optional digital display device, such as a high-performance monitor or projector.
(7)	Audio-out (headphone) jack/Audio-in (microphone) jack	Produces sound when connected to optional powered stereo speakers, headphones, earbuds, a headset, or television audio. Also connects an optional headset microphone. <b>WARNING!</b> To reduce the risk of personal injury, adjust the volume before putting on headphones, earbuds, or a headset. For additional safety information, see the <i>Regulatory, Safety, and Environmental Notices</i> . <b>NOTE:</b> When a device is connected to the jack, the computer speakers are disabled. <b>NOTE:</b> Be sure that the device cable has a 4-conductor connector that supports both audio-out (headphone) and audio-in (microphone).

## Right side

 **NOTE:** Your computer may look slightly different from the illustration in this section.

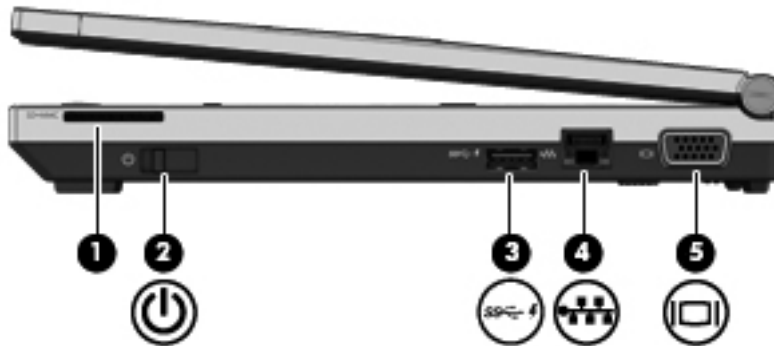

Item	Component	Description
(1)	Media Card reader	Supports the following digital card formats: <ul style="list-style-type: none"><li>• MultiMediaCard (MMC)</li><li>• MMC+</li><li>• Secure Digital (SD) Memory Card</li><li>• SDHC</li><li>• SDXC</li></ul>



Item	Component	Description
(2)	Power switch	<ul style="list-style-type: none"> <li>When the computer is off, slide the switch to turn on the computer.</li> <li>When the computer is on, slide the switch briefly to initiate Sleep.</li> <li>When the computer is in the Suspend state, slide the switch briefly to exit Sleep.</li> <li>When the computer is in Hibernation, slide the switch briefly to exit Hibernation.</li> </ul> <p><b>CAUTION:</b> Sliding and holding the power switch will result in the loss of unsaved information.</p> <p>If the computer has stopped responding and operating system shutdown procedures are ineffective, press and hold the power button for at least 5 seconds to turn off the computer.</p> <p>To learn more about your power settings:</p> <p>Windows 8 — See your power options. From the Start screen, type <code>power</code>, select <b>Settings</b>, and then select <b>Power Options</b>.</p> <p>Windows 7:</p> <ul style="list-style-type: none"> <li>Select <b>Start &gt; Control Panel &gt; System and Security &gt; Power Options</b>.</li> <li>For more information, see the <i>HP Notebook Reference Guide</i>.</li> </ul>
(3)	USB 3.0 charging port	<p>Connects an optional USB 3.0 device and provides enhanced USB power performance. The USB 3.0 charging port can also charge select models of cell phones and MP3 players, even when the computer is off.</p> <p><b>NOTE:</b> A charging USB port (also referred to as a powered USB port) allows you to charge connected USB devices. Standard USB ports will not charge all USB devices or will charge using a low current. Some USB devices require power and require you to use a powered port.</p>
(4)	RJ-45 (network) jack	Connects a network cable.
(5)	External monitor port	Connects an external VGA monitor or projector.

# Bottom

 **NOTE:** Your computer may look slightly different from the illustration in this section.

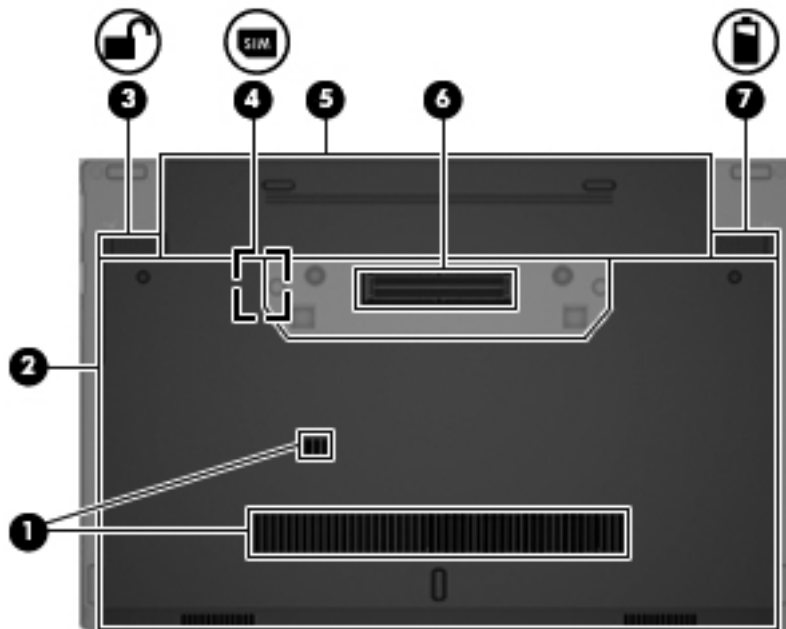

Item	Component	Description
(1)	Vents (2)	Enables airflow to cool internal components.  <b>NOTE:</b> The computer fan starts up automatically to cool internal components and prevent overheating. It is normal for the internal fan to cycle on and off during routine operation.
(2)	Service cover	Provides access to the hard drive bay, the WLAN module slot, the WWAN module slot, and the memory module slots.  <b>CAUTION:</b> To prevent an unresponsive system, replace the wireless module only with a wireless module authorized for use in the computer by the governmental agency that regulates wireless devices in your country or region. If you replace the module and then receive a warning message, remove the module to restore computer functionality, and then contact support through Help and Support.
(3)	Battery lock latch	Releases the battery from the computer.
(4)	SIM slot	Supports a wireless subscriber identity module (SIM) (select models only). The SIM slot is located inside the battery bay.
(5)	Battery bay	Holds the battery.

<b>Item</b>	<b>Component</b>	<b>Description</b>
<b>(6)</b>	Docking connector	Connects an optional docking device.
<b>(7)</b>	Battery release latch	Releases the battery.

---

# 3 Illustrated parts catalog

# Service tag

When ordering parts or requesting information, provide the computer serial number and model number provided on the service tag. It is necessary to remove the battery to obtain these numbers. See [Battery on page 56](#) for battery removal instructions.

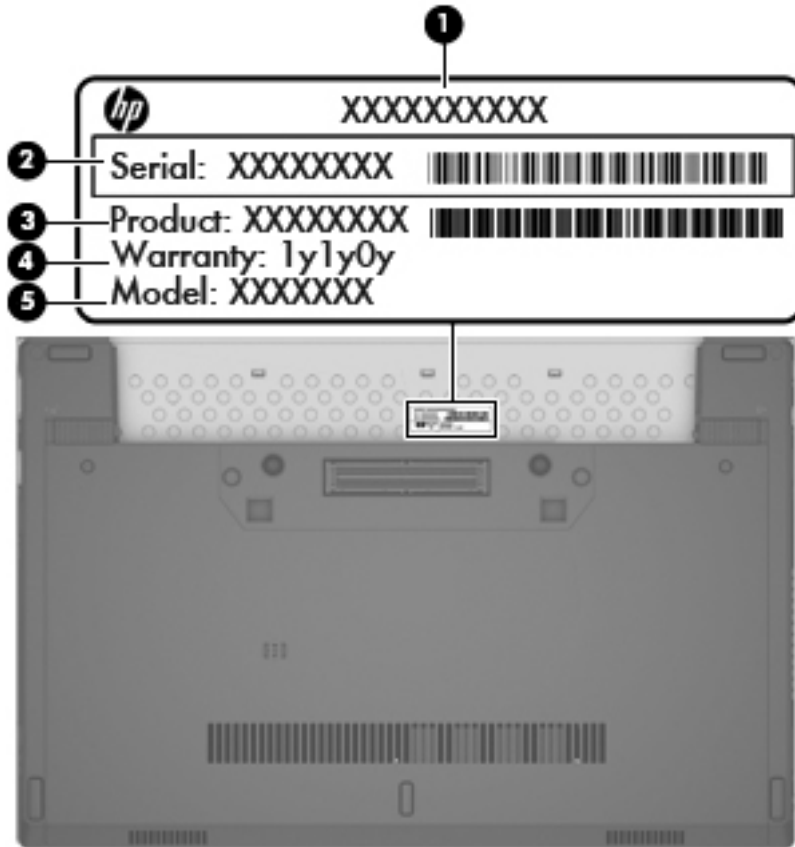

Item	Description	Function
(1)	Product name	This is the product name affixed to the front of the computer.
(2)	Serial number (s/n)	This is an alphanumeric identifier that is unique to each product.
(3)	Part number/Product number (p/n)	This number provides specific information about the product's hardware components. The part number helps a service technician to determine what components and parts are needed.
(4)	Warranty period	This number describes the duration of the warranty period for the computer.
(5)	Model description	This is the alphanumeric identifier used to locate documents, drivers, and support for the computer.

# Computer major components

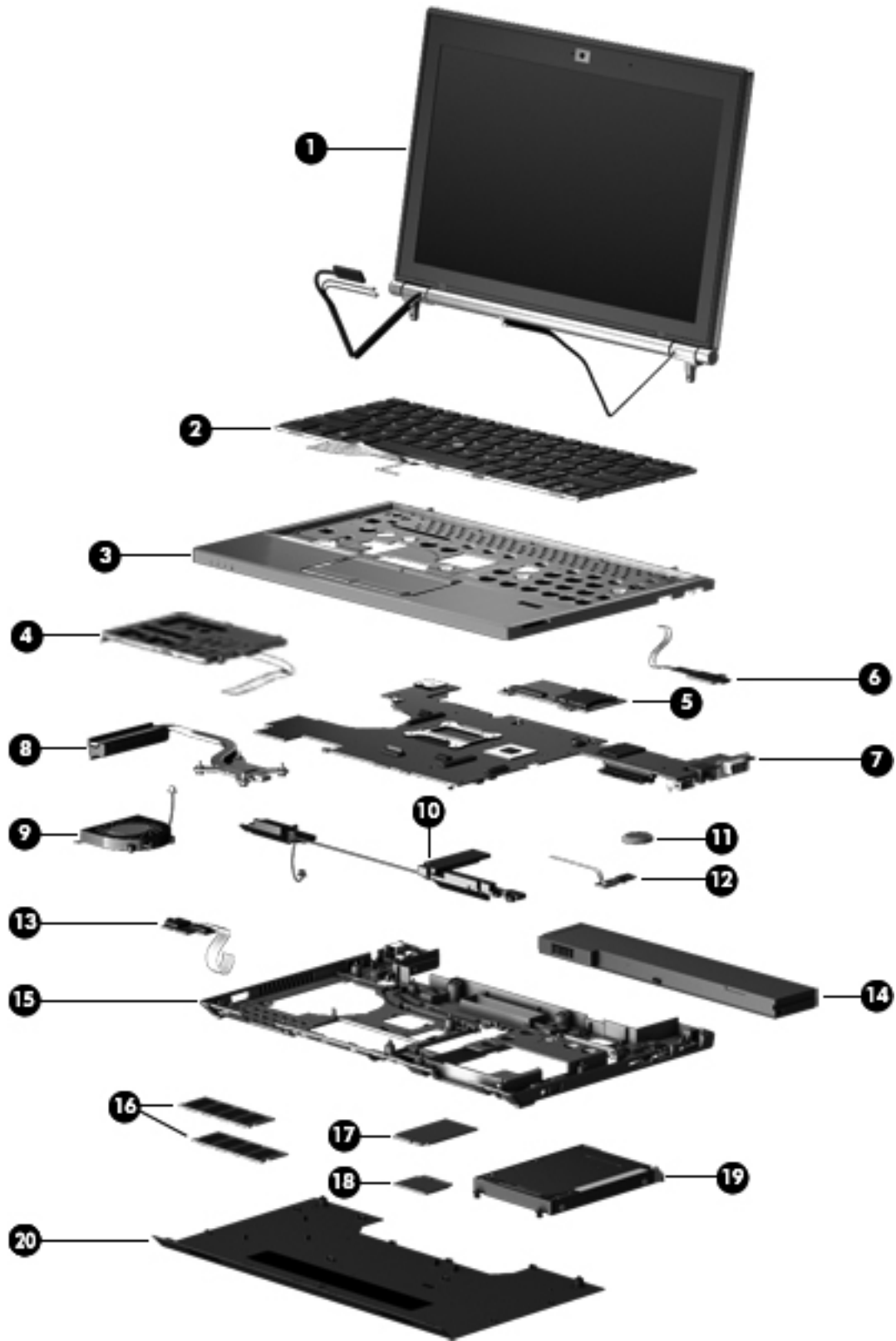

Item	Component	Spare part number
(1)	<b>Display assembly:</b> The display assembly is spared at the subcomponent level only. For more display assembly spare part information, see <a href="#">Display assembly subcomponents on page 31</a> .	
(2)	<b>Keyboard</b> with backlight and pointing stick (includes keyboard cable, backlight cable, and pointing stick cable):	
	For use only on computer models equipped with the Windows 8 Standard and Professional operating system:	
	For use in Belgium	705614-A41
	For use in Brazil	705614-201
	For use in Bulgaria	705614-261
	For use in Canada	705614-DB1
	For use in the Czech Republic and Slovakia	705614-FL1
	For use in Denmark	705614-081
	For use in France	705614-051
	For use in Germany	705614-041
	For use in Greece	705614-151
	For use in Hungary	705614-211
	For use in Iceland	705614-DD1
	For use in India	705614-D61
	For use in Israel	705614-BB1
	For use in Italy	705614-061
	For use in Japan	705614-291
	For use in Latin America	705614-161
	For use in the Netherlands	705614-B31
	For use in Norway	705614-091
	For use in Northwest Africa	705614-FP1
	For use in Portugal	705614-131
	For use in Romania	705614-271
	For use in Russia	705614-251
	For use in Saudi Arabia	705614-171
	For use in Slovenia	705614-BA1
	For use in South Korea	705614-AD1
	For use in Spain	705614-071
	For use in Sweden and Finland	705614-B71
	For use in Switzerland	705614-BG1
	For use in Taiwan	705614-AB1

<b>Item</b>	<b>Component</b>	<b>Spare part number</b>
	For use in Thailand	705614-281
	For use in Turkey	705614-141
	For use in the United Kingdom and Singapore	705614-031
	For use in the United States	705614-001
	For use only on computer models equipped with the Windows 7 operating system:	
	For use in Belgium	693363-A41
	For use in Brazil	693363-201
	For use in Bulgaria	693363-261
	For use in Canada	693363-DB1
	For use in the Czech Republic and Slovakia	693363-FL1
	For use in Denmark	693363-081
	For use in France	693363-051
	For use in Germany	693363-041
	For use in Greece	693363-151
	For use in Hungary	693363-211
	For use in Iceland	693363-DD1
	For use in India	693363-D61
	For use in Israel	693363-BB1
	For use in Italy	693363-061
	For use in Japan	693363-291
	For use in Latin America	693363-161
	For use in the Netherlands	693363-B31
	For use in Norway	693363-091
	For use in Northwest Africa	693363-FP1
	For use in Portugal	693363-131
	For use in Romania	693363-271
	For use in Russia	693363-251
	For use in Saudi Arabia	693363-171
	For use in Slovenia	693363-BA1
	For use in South Korea	693363-AD1
	For use in Spain	693363-071
	For use in Sweden and Finland	693363-B71



<b>Item</b>	<b>Component</b>	<b>Spare part number</b>
	For use in Switzerland	693363-BG1
	For use in Taiwan	693363-AB1
	For use in Thailand	693363-281
	For use in Turkey	693363-141
	For use in the United Kingdom and Singapore	693363-031
	For use in the United States	693363-001
	<b>Keyboard</b> with pointing stick (includes keyboard cable and pointing stick cable):	
	For use only on computer models equipped with the Windows 8 Standard and Professional operating system:	
	For use in Belgium	705613-A41
	For use in Brazil	705613-201
	For use in Bulgaria	705613-261
	For use in Canada	705613-DB1
	For use in the Czech Republic and Slovakia	705613-FL1
	For use in Denmark	705613-081
	For use in France	705613-051
	For use in Germany	705613-041
	For use in Greece	705613-151
	For use in Hungary	705613-211
	For use in Iceland	705613-DD1
	For use in India	705613-D61
	For use in Israel	705613-BB1
	For use in Italy	705613-061
	For use in Japan	705613-291
	For use in Latin America	705613-161
	For use in the Netherlands	705613-B31
	For use in Norway	705613-091
	For use in Northwest Africa	705613-FP1
	For use in Portugal	705613-131
	For use in Romania	705613-271
	For use in Russia	705613-251
	For use in Saudi Arabia	705613-171
	For use in Slovenia	705613-BA1

<b>Item</b>	<b>Component</b>	<b>Spare part number</b>
	For use in South Korea	705613-AD1
	For use in Spain	705613-071
	For use in Sweden and Finland	705613-B71
	For use in Switzerland	705613-BG1
	For use in Taiwan	705613-AB1
	For use in Thailand	705613-281
	For use in Turkey	705613-141
	For use in the United Kingdom and Singapore	705613-031
	For use in the United States	705613-001
	For use in Belgium	693362-A41
	For use in Brazil	693362-201
	For use in Bulgaria	693362-261
	For use in Canada	693362-DB1
	For use in the Czech Republic and Slovakia	693362-FL1
	For use in Denmark	693362-081
	For use in France	693362-051
	For use in Germany	693362-041
	For use in Greece	693362-151
	For use in Hungary	693362-211
	For use in Iceland	693362-DD1
	For use in India	693362-D61
	For use in Israel	693362-BB1
	For use in Italy	693362-061
	For use in Japan	693362-291
	For use in Latin America	693362-161
	For use in the Netherlands	693362-B31
	For use in Norway	693362-091
	For use in Northwest Africa	693362-FP1
	For use in Portugal	693362-131
	For use in Romania	693362-271
	For use in Russia	693362-251
	For use in Saudi Arabia	693362-171

Item	Component	Spare part number
	For use in Slovenia	693362-BA1
	For use in South Korea	693362-AD1
	For use in Spain	693362-071
	For use in Sweden and Finland	693362-B71
	For use in Switzerland	693362-BG1
	For use in Taiwan	693362-AB1
	For use in Thailand	693362-281
	For use in Turkey	693362-141
	For use in the United Kingdom and Singapore	693362-031
	For use in the United States	693362-001
<b>(3)</b>	<b>Top cover</b> (includes TouchPad):	
	<b>NOTE:</b> The top cover spare part kit includes the TouchPad but does not include a TouchPad cable. The TouchPad cable is included in the Cable Kit, spare part number 693306-001.	
	For use on computer models equipped with a fingerprint reader	693317-001
	For use on computer models not equipped with a fingerprint reader	694507-001
<b>(4)</b>	<b>Smart Card reader assembly</b> (includes cable)	693312-001
<b>(5)</b>	<b>Media Card reader assembly</b>	693353-001
	<b>NOTE:</b> The Media Card reader assembly spare part kit does not include a Media Card reader assembly cable. The Media Card reader assembly cable is included in the Cable Kit, spare part number 693306-001.	
<b>(6)</b>	<b>Fingerprint reader board</b> (includes bracket and cable)	693349-001
<b>(7)</b>	<b>System board</b> (includes replacement thermal material):	
	For use in all countries and regions except the People's Republic of China:	
	Equipped with an Intel Quad Core i7-3687U 2.10-GHz processor (SC turbo up to 3.30-GHz, 1600-MHz FSB, 4.0-MB L3 cache, 17 W) and the Windows 8 Standard operating system	714520-501
	Equipped with an Intel Quad Core i7-3687U 2.10-GHz processor (SC turbo up to 3.30-GHz, 1600-MHz FSB, 4.0-MB L3 cache, 17 W) and the Windows 8 Professional operating system	714520-601
	Equipped with an Intel Quad Core i7-3687U 2.10-GHz processor (SC turbo up to 3.30-GHz, 1600-MHz FSB, 4.0-MB L3 cache, 17 W) and the Windows 7 operating system	714520-001
	Equipped with an Intel Quad Core i7-3667U 1.80-GHz processor (SC turbo up to 2.90-GHz, 4.0-MB L3 cache, 17 W) and the Windows 8 Standard operating system	693360-501
	Equipped with an Intel Quad Core i7-3667U 1.80-GHz processor (SC turbo up to 2.90-GHz, 4.0-MB L3 cache, 17 W) and the Windows 8 Professional operating system	693360-601

<b>Item</b>	<b>Component</b>	<b>Spare part number</b>
	Equipped with an Intel Quad Core i7-3667U 1.80-GHz processor (SC turbo up to 2.90-GHz, 4.0-MB L3 cache, 17 W) and the Windows 7 operating system	693360-001
	Equipped with an Intel Dual Core i5-3437U 1.90-GHz processor (SC turbo up to 2.90-GHz, 1600-MHz FSB, 3.0-MB L3 cache, 17 W) and the Windows 8 Standard operating system	714519-501
	Equipped with an Intel Dual Core i5-3437U 1.90-GHz processor (SC turbo up to 2.90-GHz, 1600-MHz FSB, 3.0-MB L3 cache, 17 W) and the Windows 8 Professional operating system	714519-601
	Equipped with an Intel Dual Core i5-3437U 1.90-GHz processor (SC turbo up to 2.90-GHz, 1600-MHz FSB, 3.0-MB L3 cache, 17 W) and the Windows 7 operating system	714519-001
	Equipped with an Intel Dual Core i5-3427U 1.70-GHz processor (SC turbo up to 2.70-GHz, 3.0-MB L3 cache, 17 W) and the Windows 8 Standard operating system	693358-501
	Equipped with an Intel Dual Core i5-3427U 1.70-GHz processor (SC turbo up to 2.70-GHz, 3.0-MB L3 cache, 17 W) and the Windows 8 Professional operating system	693358-601
	Equipped with an Intel Dual Core i5-3427U 1.70-GHz processor (SC turbo up to 2.70-GHz, 3.0-MB L3 cache, 17 W) and the Windows 7 operating system	693358-001
	Equipped with an Intel Dual Core i5-3317U 1.70-GHz processor (SC turbo up to 2.60-GHz, 3.0-MB L3 cache, 17 W) and the Windows 8 Standard operating system	693357-501
	Equipped with an Intel Dual Core i5-3317U 1.70-GHz processor (SC turbo up to 2.60-GHz, 3.0-MB L3 cache, 17 W) and the Windows 8 Professional operating system	693357-601
	Equipped with an Intel Dual Core i5-3317U 1.70-GHz processor (SC turbo up to 2.60-GHz, 3.0-MB L3 cache, 17 W) and the Windows 7 operating system	693357-001
	Equipped with an Intel Dual Core i5-3217U 1.70-GHz processor (SC turbo up to 2.60-GHz, 3.0-MB L3 cache, 17 W) and the Windows 8 Standard operating system	693356-501
	Equipped with an Intel Dual Core i5-3217U 1.70-GHz processor (SC turbo up to 2.60-GHz, 3.0-MB L3 cache, 17 W) and the Windows 8 Professional operating system	693356-601
	Equipped with an Intel Dual Core i3-3217U 1.80-GHz processor (3.0-MB L3 cache, 17 W) and the Windows 7 operating system	693356-001
	For use only in the People's Republic of China:	
	Equipped with an Intel Quad Core i7-3667U 1.80-GHz processor (SC turbo up to 2.90-GHz, 4.0-MB L3 cache, 17 W) and the Windows 7 operating system	694511-001
	Equipped with an Intel Dual Core i5-3427U 1.70-GHz processor (SC turbo up to 2.70-GHz, 3.0-MB L3 cache, 17 W) and the Windows 7 operating system	694510-001
	Equipped with an Intel Dual Core i5-3317U 1.70-GHz processor (SC turbo up to 2.60-GHz, 3.0-MB L3 cache, 17 W) and the Windows 7 operating system	694509-001
	Equipped with an Intel Dual Core i3-3217U 1.80-GHz processor (3.0-MB L3 cache, 17 W) and the Windows 7 operating system	694508-001
<b>(8)</b>	<b>Heat sink</b> (includes replacement thermal material)	693307-001

Item	Component	Spare part number
(9)	<b>Fan</b> (includes cable)	693308-001
(10)	<b>Speakers</b> (include cables and 4 rubber isolators)	693354-001
(11)	<b>RTC battery</b>	651038-001
(12)	<b>Power switch board</b> (includes cable)	693352-001
(13)	<b>Audio board</b>	693351-001
	<b>NOTE:</b> The audio board spare part kit does not include an audio board cable. The audio board cable is included in the Cable Kit, spare part number 693306-001.	
(14)	<b>Battery</b> (Li-ion):	
	6-cell, 48-Wh, 2.2-Ah	685988-001
	4-cell, 30-Wh, 2.0-Ah	671604-001
(15)	<b>Base enclosure</b> (includes battery release latch assembly, rubber feet, and service cover release latch assembly)	693301-001
	<b>Rubber Kit</b> (not illustrated, includes base enclosure and display bezel screw covers)	693355-001
(16)	<b>Memory modules</b> (PC3-12800, 1666-MHz, DDR3):	
	8-GB	670034-001
	4-GB	641369-001
	2-GB	652972-001
(17)	<b>WWAN module:</b>	
	HP hs2350 HSPA+ Mobile Broadband Module	668969-001
	HP lt2523 LTE/HSPA+ Mobile Broadband Module	710790-001
	HP lt2522 LTE/EV-DO Mobile Broadband Module	710789-001
	HP un2430 EV-DO/HSPA Mini Card	702080-001
	HP un2430 EV-DO/HSPA Mobile Broadband Module	634400-001
(18)	<b>WLAN module:</b>	
	Atheros AR9462 802.11a/b/g/n 2x2 Bluetooth 4.0 Combo Adapter	676786-001
	Broadcom 4313GN 802.11b/g/n 1x1 WiFi and 20702 Bluetooth 4.0 Combo Adapter	657325-001
	Intel Centrino Advanced-N 6235 WLAN module	670292-001
	Intel Centrino Advanced-N 6205 WLAN module	631954-001
(19)	<b>Hard drive</b> (does not include hard drive bracket, hard drive connector adapter, or screws):	
	750-GB, 7200-rpm, 9.5-mm	633252-001
	500-GB, 7200-rpm, 9.5-mm self-encrypting drive	683801-001
	500-GB, 7200-rpm, 9.5-mm	634925-001
	320-GB, 7200-rpm, 9.5-mm	641672-001

<b>Item</b>	<b>Component</b>	<b>Spare part number</b>
	<b>Hard Drive Hardware Kit</b> (not illustrated, includes hard drive bracket, hard drive connector adapter, and screws)	693350-001
	<b>Solid-state drive</b> (not illustrated, does not include bracket, connector, or screws):	
	256-GB SATA III self-encrypting solid-state drive	693545-001
	240-GB SATA III solid-state drive	702247-001
	180-GB SATA III solid-state drive	693544-001
	160-GB SATA II solid-state drive	694673-001
	128-GB SATA III solid-state drive	693543-001
<b>(20)</b>	<b>Service cover</b>	
	Includes label indicating "Made in China"	693315-001
	Includes label indicating country of origin	704017-001

# Display assembly subcomponents

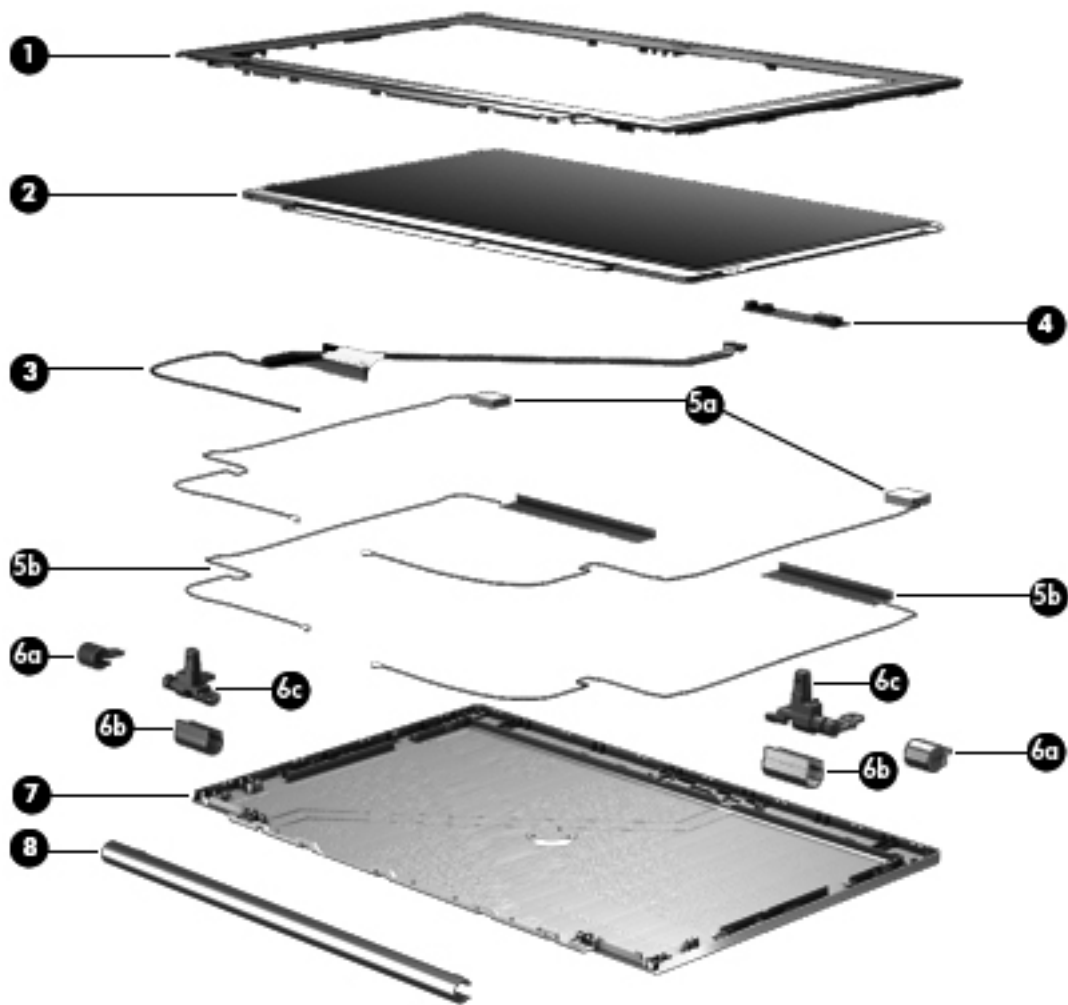

Item	Component	Spare part number
<b>(1)</b>	<b>Display bezel:</b>	
	For use on computer models equipped with a webcam	693302-001
	For use on computer models not equipped with a webcam	693303-001
<b>(2)</b>	<b>11.6 in, HD, LED, AG, SVA display panel</b>	693361-001
	<b>Display Cable Kit</b> , includes:	693305-001
<b>(3)</b>	Display panel cable and webcam/microphone module cable	
<b>(4)</b>	<b>Webcam/microphone module</b>	693318-001
	<b>Microphone module</b>	693313-001
	<b>Antenna Kit</b> , includes:	693299-001
<b>(5a)</b>	WLAN antenna cables and transceivers	
<b>(5b)</b>	WWAN antenna cables and transceivers	

<b>Item</b>	<b>Component</b>	<b>Spare part number</b>
	<b>Display Hinge Cover Kit</b> , includes:	693310-001
<b>(6a)</b>	Left and right display hinge caps	
<b>(6b)</b>	Left and right display hinge covers	
<b>(6c)</b>	Left and right display hinges	
<b>(7)</b>	<b>Display enclosure</b>	693300-001
<b>(8)</b>	<b>Display clutch cover</b>	693311-001
	<b>Display Panel Support Kit</b> (not illustrated, includes display enclosure with pre-installed WLAN antenna cables and transceivers and WWAN antenna cables and transceivers)	693309-001



# Cable Kit



Item	Component	Spare part number
	<b>Cable Kit</b> , includes:	693306-001
(1)	Audio board cable	
(2)	Media Card reader assembly cable	
(3)	TouchPad cable	

# Mass storage devices

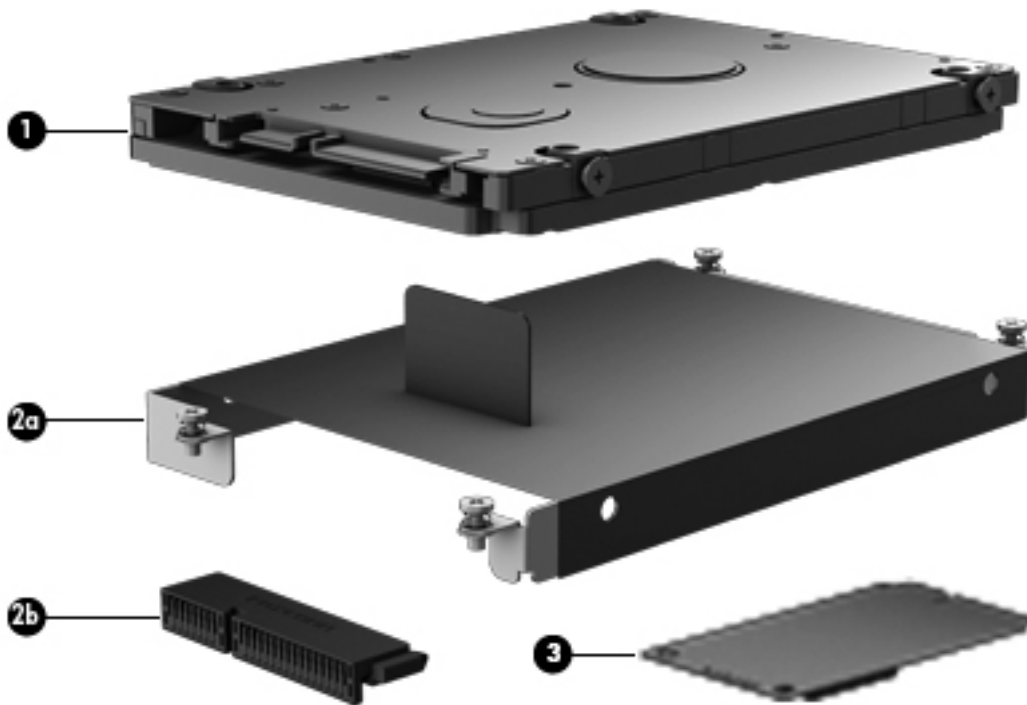

Item	Description	Spare part number
<b>(1)</b>	<b>Hard drive</b> (does not include hard drive bracket, hard drive connector adapter, or screws):	
	750-GB, 7200-rpm, 9.5-mm	633252-001
	500-GB, 7200-rpm, 9.5-mm SED	683801-001
	500-GB, 7200-rpm, 9.5-mm	634925-001
	320-GB, 7200-rpm, 9.5-mm	641672-001
	<b>Hard Drive Hardware Kit</b> , includes:	693350-001
<b>(2a)</b>	Hard drive bracket	
<b>(2b)</b>	Hard drive connector adapter	
	Hard drive bracket screws (not illustrated)	
<b>(3)</b>	<b>Solid-state drive</b> (does not include solid-state drive bracket, solid-state drive connector adapter, or screws):	
	256-GB SATA III self-encrypting solid-state drive	693545-001
	240-GB SATA III solid-state drive	702247-001
	180-GB SATA III solid-state drive	693544-001
	160-GB SATA II solid-state drive	694673-001
	128-GB SATA III solid-state drive	693543-001

## Miscellaneous parts

Component	Spare part number
<b>AC adapter:</b>	
65-W HP Smart AC adapter (PFC, RC/V, EM, 3-wire)	693710-001
65-W HP Smart AC adapter (non-PFC, 3-wire)	693711-001
65-W HP travel AC adapter (non-PFC, 3-wire)	693716-001
<b>HP notebook mini sleeve</b>	656839-001
<b>HP USB optical travel mouse</b>	434594-001
<b>Lock:</b>	
HP notebook combination lock	591699-001
HP notebook keyed cable lock	626729-002
<b>Power cord (3-pin, black, 1.83-m):</b>	
For use in Argentina	490371-D01
For use in Australia	490371-011
For use in Brazil	490371-202
For use in Denmark	490371-081
For use in Europe	490371-021
For use in India	490371-D61
For use in Israel	490371-BB1
For use in Japan	490371-291
For use in North America	490371-001
For use in the People's Republic of China	490371-AA1
For use in South Africa	490371-AR1
For use in South Korea	490371-AD1
For use in Switzerland	490371-111
For use in Taiwan	490371-AB1
For use in Thailand	490371-201
For use in the United Kingdom and Singapore	490371-031
<b>Screw Kit</b>	693316-001

# Sequential part number listing

Spare part number	Description
434594-001	HP USB optical travel mouse
490371-001	Power cord for use in North America (3-pin, black, 1.83-m)
490371-011	Power cord for use in Australia (3-pin, black, 1.83-m)
490371-021	Power cord for use in Europe (3-pin, black, 1.83-m)
490371-031	Power cord for use in the United Kingdom and Singapore (3-pin, black, 1.83-m)
490371-081	Power cord for use in Denmark (3-pin, black, 1.83-m)
490371-111	Power cord for use in Switzerland (3-pin, black, 1.83-m)
490371-201	Power cord for use in Thailand (3-pin, black, 1.83-m)
490371-202	Power cord for use in Brazil (3-pin, black, 1.83-m)
490371-291	Power cord for use in Japan (3-pin, black, 1.83-m)
490371-AA1	Power cord for use in the People's Republic of China (3-pin, black, 1.83-m)
490371-AB1	Power cord for use in Taiwan (3-pin, black, 1.83-m)
490371-AD1	Power cord for use in South Korea (3-pin, black, 1.83-m)
490371-AR1	Power cord for use in South Africa (3-pin, black, 1.83-m)
490371-BB1	Power cord for use in Israel (3-pin, black, 1.83-m)
490371-D01	Power cord for use in Argentina (3-pin, black, 1.83-m)
490371-D61	Power cord for use in India (3-pin, black, 1.83-m)
591699-001	HP notebook combination lock
626729-002	HP notebook keyed cable lock
631954-001	Intel Centrino Advanced-N 6205 WLAN module
633252-001	750-GB, 7200-rpm, 9.5-mm hard drive (does not include hard drive bracket, hard drive connector adapter, or screws)  <b>NOTE:</b> The hard drive bracket, hard drive connector adapter, and screws are included in the Hard Drive Hardware Kit, spare part number 693350-001.
634400-001	HP un2430 EV-DO/HSPA Mobile Broadband Module
634925-001	500-GB, 7200-rpm, 9.5-mm hard drive (does not include hard drive bracket, hard drive connector adapter, or screws)  <b>NOTE:</b> The hard drive bracket, hard drive connector adapter, and screws are included in the Hard Drive Hardware Kit, spare part number 693350-001.
641369-001	4-GB memory module (PC3, 12800, 1600-MHz)

Spare part number	Description
641672-001	320-GB, 7200-rpm, 9.5-mm hard drive (does not include hard drive bracket, hard drive connector adapter, or screws)  <b>NOTE:</b> The hard drive bracket, hard drive connector adapter, and screws are included in the Hard Drive Hardware Kit, spare part number 693350-001.
651038-001	RTC battery
652972-001	2-GB memory module (PC3, 12800, 1600-MHz)
656839-001	HP notebook mini sleeve
657325-001	Broadcom 4313GN 802.11b/g/n 1x1 WiFi and 20702 Bluetooth 4.0 Combo Adapter
668969-001	HP hs2350 HSPA+ Mobile Broadband Module
670034-001	8-GB memory module (PC3, 12800, 1600-MHz)
670292-001	Intel Centrino Advanced-N 6235 WLAN module
671604-001	4-cell, 30-Wh, 2.00-Ah, Li-ion battery
676786-001	Atheros AR9462 802.11a/b/g/n 2x2 Bluetooth 4.0 Combo Adapter
683801-001	500-GB, 7200-rpm, 9.5-mm SED hard drive (does not include hard drive bracket, hard drive connector adapter, or screws)  <b>NOTE:</b> The hard drive bracket, hard drive connector adapter, and screws are included in the Hard Drive Hardware Kit, spare part number 693350-001.
685988-001	6-cell, 48-Wh, 2.20-Ah, Li-ion battery
693299-001	Antenna Kit (includes WLAN antenna cables and transceivers and WWAN antenna cables and transceivers)
693300-001	Base enclosure (includes rubber feet, service cover release latch assembly, and battery release latch assembly)
693301-001	Display enclosure
693302-001	Display bezel for use on computer models equipped with webcam
693303-001	Display bezel for use on computer models not equipped with webcam
693305-001	Display Cable Kit
693306-001	Cable Kit (includes audio board cable, SD Card reader board cable, and TouchPad cable)
693307-001	Heat sink (includes replacement thermal material)
693308-001	Fan (includes cable)
693309-001	Display Panel Support Kit (includes display enclosure with pre-installed WLAN antenna cables and transceivers and WWAN antenna cables and transceivers)
693310-001	Display Hinge Cover Kit (includes left and right display hinges, left and right display hinge caps, and left and right display hinge covers)
693311-001	Display clutch cover
693312-001	Smart Card reader assembly (includes cable)
693313-001	Microphone module

Spare part number	Description
693315-001	Service cover (includes label indicating "Made in China")
693316-001	Screw Kit
693317-001	Top cover for use on computer models equipped with a fingerprint reader (includes TouchPad) <b>NOTE:</b> The top cover spare part kit includes the TouchPad but does not include a TouchPad cable. The TouchPad cable is included in the Cable Kit, spare part number 693306-001.
693318-001	Webcam/microphone module
693349-001	Fingerprint reader board (includes bracket and cable)
693350-001	Hard Drive Hardware Kit (includes hard drive bracket, hard drive connector adapter, and screws)
693351-001	Audio board
693352-001	Power switch board (includes cable)
693353-001	Media Card reader assembly <b>NOTE:</b> The Media Card reader assembly spare part kit does not include a Media Card reader assembly cable. The Media Card reader assembly cable is included in the Cable Kit, spare part number 693306-001.
693354-001	Speakers (include cables and 4 rubber isolators)
693355-001	Rubber Kit (includes base enclosure and display bezel screw covers)
693356-001	System board equipped with an Intel Dual Core i3-3217U 1.80-GHz processor and the Windows 7 operating system for use in all countries and regions except the People's Republic of China and the Ukraine (3.0-MB L3 cache, 17 W; includes replacement thermal material)
693356-501	System board equipped with an Intel Dual Core i3-3217U 1.80-GHz processor and the Windows 8 Standard operating system for use in all countries and regions except the People's Republic of China and the Ukraine (3.0-MB L3 cache, 17 W; includes replacement thermal material)
693356-601	System board equipped with an Intel Dual Core i3-3217U 1.80-GHz processor and the Windows 8 Professional operating system for use in all countries and regions except the People's Republic of China and the Ukraine (3.0-MB L3 cache, 17 W; includes replacement thermal material)
693357-001	System board equipped with an Intel Dual Core i5-3317U 1.70-GHz processor (SC turbo up to 2.60-GHz) and the Windows 7 operating system for use in all countries and regions except the People's Republic of China and the Ukraine (3.0-MB L3 cache, 17 W; includes replacement thermal material)
693357-501	System board equipped with an Intel Dual Core i5-3317U 1.70-GHz processor (SC turbo up to 2.60-GHz) and the Windows 8 Standard operating system for use in all countries and regions except the People's Republic of China and the Ukraine (3.0-MB L3 cache, 17 W; includes replacement thermal material)
693357-601	System board equipped with an Intel Dual Core i5-3317U 1.70-GHz processor (SC turbo up to 2.60-GHz) and the Windows 8 Professional operating system for use in all countries and regions except the People's Republic of China and the Ukraine (3.0-MB L3 cache, 17 W; includes replacement thermal material)
693358-001	System board equipped with an Intel Dual Core i5-3427U 1.70-GHz processor (SC turbo up to 2.70-GHz) and the Windows 7 operating system for use in all countries and regions except the People's Republic of China and the Ukraine (3.0-MB L3 cache, 17 W; includes replacement thermal material)

<b>Spare part number</b>	<b>Description</b>
693358-501	System board equipped with an Intel Dual Core i5-3427U 1.70-GHz processor (SC turbo up to 2.70-GHz) and the Windows 8 Standard operating system for use in all countries and regions except the People's Republic of China and the Ukraine (3.0-MB L3 cache, 17 W; includes replacement thermal material)
693358-601	System board equipped with an Intel Dual Core i5-3427U 1.70-GHz processor (SC turbo up to 2.70-GHz) and the Windows 8 Professional operating system for use in all countries and regions except the People's Republic of China and the Ukraine (3.0-MB L3 cache, 17 W; includes replacement thermal material)
693360-001	System board equipped with an Intel Dual Core i7-3667U 1.80-GHz processor (SC turbo up to 2.90-GHz) and the Windows 7 operating system for use in all countries and regions except the People's Republic of China and the Ukraine (4.0-MB L3 cache, 17 W; includes replacement thermal material)
693360-501	System board equipped with an Intel Dual Core i7-3667U 1.80-GHz processor (SC turbo up to 2.90-GHz) and the Windows 8 Standard operating system for use in all countries and regions except the People's Republic of China and the Ukraine (4.0-MB L3 cache, 17 W; includes replacement thermal material)
693360-601	System board equipped with an Intel Dual Core i7-3667U 1.80-GHz processor (SC turbo up to 2.90-GHz) and the Windows 8 Professional operating system for use in all countries and regions except the People's Republic of China and the Ukraine (4.0-MB L3 cache, 17 W; includes replacement thermal material)
693361-001	11.6 in, HD, LED, AG, SVA display panel
693362-001	Keyboard with pointing stick for use on computer models equipped with the Windows 7 operating system in the United States (includes keyboard cable and pointing stick cable)
693362-031	Keyboard with pointing stick for use on computer models equipped with the Windows 7 operating system in the United Kingdom and Singapore (includes keyboard cable and pointing stick cable)
693362-041	Keyboard with pointing stick for use on computer models equipped with the Windows 7 operating system in Germany (includes keyboard cable and pointing stick cable)
693362-051	Keyboard with pointing stick for use on computer models equipped with the Windows 7 operating system in France (includes keyboard cable and pointing stick cable)
693362-061	Keyboard with pointing stick for use on computer models equipped with the Windows 7 operating system in Italy (includes keyboard cable and pointing stick cable)
693362-071	Keyboard with pointing stick for use on computer models equipped with the Windows 7 operating system in Spain (includes keyboard cable and pointing stick cable)
693362-081	Keyboard with pointing stick for use on computer models equipped with the Windows 7 operating system in Denmark (includes keyboard cable and pointing stick cable)
693362-091	Keyboard with pointing stick for use on computer models equipped with the Windows 7 operating system in Norway (includes keyboard cable and pointing stick cable)
693362-131	Keyboard with pointing stick for use on computer models equipped with the Windows 7 operating system in Portugal (includes keyboard cable and pointing stick cable)
693362-141	Keyboard with pointing stick for use on computer models equipped with the Windows 7 operating system in Turkey (includes keyboard cable and pointing stick cable)
693362-151	Keyboard with pointing stick for use on computer models equipped with the Windows 7 operating system in Greece (includes keyboard cable and pointing stick cable)

<b>Spare part number</b>	<b>Description</b>
693362-161	Keyboard with pointing stick for use on computer models equipped with the Windows 7 operating system in Latin America (includes keyboard cable and pointing stick cable)
693362-171	Keyboard with pointing stick for use on computer models equipped with the Windows 7 operating system in Saudi Arabia (includes keyboard cable and pointing stick cable)
693362-201	Keyboard with pointing stick for use on computer models equipped with the Windows 7 operating system in Brazil (includes keyboard cable and pointing stick cable)
693362-211	Keyboard with pointing stick for use on computer models equipped with the Windows 7 operating system in Hungary (includes keyboard cable and pointing stick cable)
693362-251	Keyboard with pointing stick for use on computer models equipped with the Windows 7 operating system in Russia (includes keyboard cable and pointing stick cable)
693362-261	Keyboard with pointing stick for use on computer models equipped with the Windows 7 operating system in Bulgaria (includes keyboard cable and pointing stick cable)
693362-271	Keyboard with pointing stick for use on computer models equipped with the Windows 7 operating system in Romania (includes keyboard cable and pointing stick cable)
693362-281	Keyboard with pointing stick for use on computer models equipped with the Windows 7 operating system in Thailand (includes keyboard cable and pointing stick cable)
693362-291	Keyboard with pointing stick for use on computer models equipped with the Windows 7 operating system in Japan (includes keyboard cable and pointing stick cable)
693362-A41	Keyboard with pointing stick for use on computer models equipped with the Windows 7 operating system in Belgium (includes keyboard cable and pointing stick cable)
693362-AB1	Keyboard with pointing stick for use on computer models equipped with the Windows 7 operating system in Taiwan (includes keyboard cable and pointing stick cable)
693362-AD1	Keyboard with pointing stick for use on computer models equipped with the Windows 7 operating system in South Korea (includes keyboard cable and pointing stick cable)
693362-B31	Keyboard with pointing stick for use on computer models equipped with the Windows 7 operating system in the Netherlands (includes keyboard cable and pointing stick cable)
693362-B71	Keyboard with pointing stick for use on computer models equipped with the Windows 7 operating system in Sweden and Finland (includes keyboard cable and pointing stick cable)
693362-BA1	Keyboard with pointing stick for use on computer models equipped with the Windows 7 operating system in Slovenia (includes keyboard cable and pointing stick cable)
693362-BB1	Keyboard with pointing stick for use on computer models equipped with the Windows 7 operating system in Israel (includes keyboard cable and pointing stick cable)
693362-BG1	Keyboard with pointing stick for use on computer models equipped with the Windows 7 operating system in Switzerland (includes keyboard cable and pointing stick cable)
693362-D61	Keyboard with pointing stick for use in on computer models equipped with the Windows 7 operating system India (includes keyboard cable and pointing stick cable)
693362-DB1	Keyboard with pointing stick for use on computer models equipped with the Windows 7 operating system in Canada (includes keyboard cable and pointing stick cable)
693362-DD1	Keyboard with pointing stick for use on computer models equipped with the Windows 7 operating system in Iceland (includes keyboard cable and pointing stick cable)



<b>Spare part number</b>	<b>Description</b>
693362-FL1	Keyboard with pointing stick for use on computer models equipped with the Windows 7 operating system in the Czech Republic and Slovakia (includes keyboard cable and pointing stick cable)
693362-FP1	Keyboard with pointing stick for use on computer models equipped with the Windows 7 operating system in Northwest Africa (includes keyboard cable and pointing stick cable)
693363-001	Keyboard with backlight and pointing stick for use on computer models equipped with the Windows 7 operating system in the United States (includes keyboard cable and pointing stick cable)
693363-031	Keyboard with backlight and pointing stick for use on computer models equipped with the Windows 7 operating system in the United Kingdom and Singapore (includes keyboard cable and pointing stick cable)
693363-041	Keyboard with backlight and pointing stick for use on computer models equipped with the Windows 7 operating system in Germany (includes keyboard cable, backlight cable, and pointing stick cable)
693363-051	Keyboard with backlight and pointing stick for use on computer models equipped with the Windows 7 operating system in France (includes keyboard cable, backlight cable, and pointing stick cable)
693363-061	Keyboard with backlight and pointing stick for use on computer models equipped with the Windows 7 operating system in Italy (includes keyboard cable, backlight cable, and pointing stick cable)
693363-071	Keyboard with backlight and pointing stick for use on computer models equipped with the Windows 7 operating system in Spain (includes keyboard cable, backlight cable, and pointing stick cable)
693363-081	Keyboard with backlight and pointing stick for use on computer models equipped with the Windows 7 operating system in Denmark (includes keyboard cable, backlight cable, and pointing stick cable)
693363-091	Keyboard with backlight and pointing stick for use on computer models equipped with the Windows 7 operating system in Norway (includes keyboard cable, backlight cable, and pointing stick cable)
693363-131	Keyboard with backlight and pointing stick for use on computer models equipped with the Windows 7 operating system in Portugal (includes keyboard cable, backlight cable, and pointing stick cable)
693363-141	Keyboard with backlight and pointing stick for use on computer models equipped with the Windows 7 operating system in Turkey (includes keyboard cable, backlight cable, and pointing stick cable)
693363-151	Keyboard with backlight and pointing stick for use on computer models equipped with the Windows 7 operating system in Greece (includes keyboard cable, backlight cable, and pointing stick cable)
693363-161	Keyboard with backlight and pointing stick for use on computer models equipped with the Windows 7 operating system in Latin America (includes keyboard cable, backlight cable, and pointing stick cable)
693363-171	Keyboard with backlight and pointing stick for use on computer models equipped with the Windows 7 operating system in Saudi Arabia (includes keyboard cable, backlight cable, and pointing stick cable)

<b>Spare part number</b>	<b>Description</b>
693363-201	Keyboard with backlight and pointing stick for use on computer models equipped with the Windows 7 operating system in Brazil (includes keyboard cable, backlight cable, and pointing stick cable)
693363-211	Keyboard with backlight and pointing stick for use on computer models equipped with the Windows 7 operating system in Hungary (includes keyboard cable, backlight cable, and pointing stick cable)
693363-251	Keyboard with backlight and pointing stick for use on computer models equipped with the Windows 7 operating system in Russia (includes keyboard cable, backlight cable, and pointing stick cable)
693363-261	Keyboard with backlight and pointing stick for use on computer models equipped with the Windows 7 operating system in Bulgaria (includes keyboard cable, backlight cable, and pointing stick cable)
693363-271	Keyboard with backlight and pointing stick for use on computer models equipped with the Windows 7 operating system in Romania (includes keyboard cable, backlight cable, and pointing stick cable)
693363-281	Keyboard with backlight and pointing stick for use on computer models equipped with the Windows 7 operating system in Thailand (includes keyboard cable, backlight cable, and pointing stick cable)
693363-291	Keyboard with backlight and pointing stick for use on computer models equipped with the Windows 7 operating system in Japan (includes keyboard cable, backlight cable, and pointing stick cable)
693363-A41	Keyboard with backlight and pointing stick for use on computer models equipped with the Windows 7 operating system in Belgium (includes keyboard cable, backlight cable, and pointing stick cable)
693363-AB1	Keyboard with backlight and pointing stick for use on computer models equipped with the Windows 7 operating system in Taiwan (includes keyboard cable, backlight cable, and pointing stick cable)
693363-AD1	Keyboard with backlight and pointing stick for use on computer models equipped with the Windows 7 operating system in South Korea (includes keyboard cable, backlight cable, and pointing stick cable)
693363-B31	Keyboard with backlight and pointing stick for use on computer models equipped with the Windows 7 operating system in the Netherlands (includes keyboard cable, backlight cable, and pointing stick cable)
693363-B71	Keyboard with backlight and pointing stick for use on computer models equipped with the Windows 7 operating system in Sweden and Finland (includes keyboard cable, backlight cable, and pointing stick cable)
693363-BA1	Keyboard with backlight and pointing stick for use on computer models equipped with the Windows 7 operating system in Slovenia (includes keyboard cable, backlight cable, and pointing stick cable)
693363-BB1	Keyboard with backlight and pointing stick for use on computer models equipped with the Windows 7 operating system in Israel (includes keyboard cable, backlight cable, and pointing stick cable)
693363-BG1	Keyboard with backlight and pointing stick for use on computer models equipped with the Windows 7 operating system in Switzerland (includes keyboard cable, backlight cable, and pointing stick cable)

Spare part number	Description
693363-D61	Keyboard with backlight and pointing stick for use on computer models equipped with the Windows 7 operating system in India (includes keyboard cable, backlight cable, and pointing stick cable)
693363-DB1	Keyboard with backlight and pointing stick for use on computer models equipped with the Windows 7 operating system in Canada (includes keyboard cable, backlight cable, and pointing stick cable)
693363-DD1	Keyboard with backlight and pointing stick for use on computer models equipped with the Windows 7 operating system in Iceland (includes keyboard cable, backlight cable, and pointing stick cable)
693363-FL1	Keyboard with backlight and pointing stick for use on computer models equipped with the Windows 7 operating system in the Czech Republic and Slovakia (includes keyboard cable, backlight cable, and pointing stick cable)
693363-FP1	Keyboard with backlight and pointing stick for use on computer models equipped with the Windows 7 operating system in Northwest Africa (includes keyboard cable, backlight cable, and pointing stick cable)
693543-001	128-GB SATA III solid-state drive
693544-001	180-GB SATA III solid-state drive
693545-001	256-GB SATA III self-encrypting solid-state drive
693710-001	65-W HP Smart AC adapter (RC/V, EM, 3-wire)
693711-001	65-W HP Smart AC adapter (non-PFC, 3-wire)
693716-001	65-W HP travel AC adapter (non-PFC, 3-wire)
694507-001	Top cover for use on computer models not equipped with a fingerprint reader (includes TouchPad)  <b>NOTE:</b> The top cover spare part kit includes the TouchPad but does not include a TouchPad cable. The TouchPad cable is included in the Cable Kit, spare part number 693306-001.
694508-001	System board equipped with Intel Dual Core i3-3217U 1.80-GHz processor for use only in the People's Republic of China (3.0-MB L3 cache, 17 W; includes replacement thermal material)
694509-001	System board equipped with Intel Dual Core i5-3317U 1.70-GHz processor (SC turbo up to 2.60-GHz) for use only in the People's Republic of China (3.0-MB L3 cache, 17 W; includes replacement thermal material)
694510-001	System board equipped with Intel Dual Core i5-3427U 1.70-GHz processor (SC turbo up to 2.70-GHz) for use only in the People's Republic of China (3.0-MB L3 cache, 17 W; includes replacement thermal material)
694511-001	System board equipped with Intel Dual Core i7-3667U 1.80-GHz processor (SC turbo up to 2.90-GHz) for use only in the People's Republic of China (4.0-MB L3 cache, 17 W; includes replacement thermal material)
694512-001	Processor bracket
694673-001	160-GB SATA II solid-state drive
702080-001	HP un2430 EV-DO/HSPA Mini Card
702247-001	240-GB SATA III solid-state drive
704017-001	Service cover (includes label indicating country of origin)

<b>Spare part number</b>	<b>Description</b>
705613-001	Keyboard with pointing stick for use on computer models equipped with the Windows 8 Standard or Professional operating system in the United States (includes keyboard cable and pointing stick cable)
705613-031	Keyboard with pointing stick for use on computer models equipped with the Windows 8 Standard or Professional operating system in the United Kingdom and Singapore (includes keyboard cable and pointing stick cable)
705613-041	Keyboard with pointing stick for use on computer models equipped with the Windows 8 Standard or Professional operating system in Germany (includes keyboard cable and pointing stick cable)
705613-051	Keyboard with pointing stick for use on computer models equipped with the Windows 8 Standard or Professional operating system in France (includes keyboard cable and pointing stick cable)
705613-061	Keyboard with pointing stick for use on computer models equipped with the Windows 8 Standard or Professional operating system in Italy (includes keyboard cable and pointing stick cable)
705613-071	Keyboard with pointing stick for use on computer models equipped with the Windows 8 Standard or Professional operating system in Spain (includes keyboard cable and pointing stick cable)
705613-081	Keyboard with pointing stick for use on computer models equipped with the Windows 8 Standard or Professional operating system in Denmark (includes keyboard cable and pointing stick cable)
705613-091	Keyboard with pointing stick for use on computer models equipped with the Windows 8 Standard or Professional operating system in Norway (includes keyboard cable and pointing stick cable)
705613-131	Keyboard with pointing stick for use on computer models equipped with the Windows 8 Standard or Professional operating system in Portugal (includes keyboard cable and pointing stick cable)
705613-141	Keyboard with pointing stick for use on computer models equipped with the Windows 8 Standard or Professional operating system in Turkey (includes keyboard cable and pointing stick cable)
705613-151	Keyboard with pointing stick for use on computer models equipped with the Windows 8 Standard or Professional operating system in Greece (includes keyboard cable and pointing stick cable)
705613-161	Keyboard with pointing stick for use on computer models equipped with the Windows 8 Standard or Professional operating system in Latin America (includes keyboard cable and pointing stick cable)
705613-171	Keyboard with pointing stick for use on computer models equipped with the Windows 8 Standard or Professional operating system in Saudi Arabia (includes keyboard cable and pointing stick cable)
705613-201	Keyboard with pointing stick for use on computer models equipped with the Windows 8 Standard or Professional operating system in Brazil (includes keyboard cable and pointing stick cable)
705613-211	Keyboard with pointing stick for use on computer models equipped with the Windows 8 Standard or Professional operating system in Hungary (includes keyboard cable and pointing stick cable)
705613-251	Keyboard with pointing stick for use on computer models equipped with the Windows 8 Standard or Professional operating system in Russia (includes keyboard cable and pointing stick cable)
705613-261	Keyboard with pointing stick for use on computer models equipped with the Windows 8 Standard or Professional operating system in Bulgaria (includes keyboard cable and pointing stick cable)
705613-271	Keyboard with pointing stick for use on computer models equipped with the Windows 8 Standard or Professional operating system in Romania (includes keyboard cable and pointing stick cable)
705613-281	Keyboard with pointing stick for use on computer models equipped with the Windows 8 Standard or Professional operating system in Thailand (includes keyboard cable and pointing stick cable)

<b>Spare part number</b>	<b>Description</b>
705613-291	Keyboard with pointing stick for use on computer models equipped with the Windows 8 Standard or Professional operating system in Japan (includes keyboard cable and pointing stick cable)
705613-A41	Keyboard with pointing stick for use on computer models equipped with the Windows 8 Standard or Professional operating system in Belgium (includes keyboard cable and pointing stick cable)
705613-AB1	Keyboard with pointing stick for use on computer models equipped with the Windows 8 Standard or Professional operating system in Taiwan (includes keyboard cable and pointing stick cable)
705613-AD1	Keyboard with pointing stick for use on computer models equipped with the Windows 8 Standard or Professional operating system in South Korea (includes keyboard cable and pointing stick cable)
705613-B31	Keyboard with pointing stick for use on computer models equipped with the Windows 8 Standard or Professional operating system in the Netherlands (includes keyboard cable and pointing stick cable)
705613-B71	Keyboard with pointing stick for use on computer models equipped with the Windows 8 Standard or Professional operating system in Sweden and Finland (includes keyboard cable and pointing stick cable)
705613-BA1	Keyboard with pointing stick for use on computer models equipped with the Windows 8 Standard or Professional operating system in Slovenia (includes keyboard cable and pointing stick cable)
705613-BB1	Keyboard with pointing stick for use on computer models equipped with the Windows 8 Standard or Professional operating system in Israel (includes keyboard cable and pointing stick cable)
705613-BG1	Keyboard with pointing stick for use on computer models equipped with the Windows 8 Standard or Professional operating system in Switzerland (includes keyboard cable and pointing stick cable)
705613-D61	Keyboard with pointing stick for use on computer models equipped with the Windows 8 Standard or Professional operating system in India (includes keyboard cable and pointing stick cable)
705613-DB1	Keyboard with pointing stick for use on computer models equipped with the Windows 8 Standard or Professional operating system in Canada (includes keyboard cable and pointing stick cable)
705613-DD1	Keyboard with pointing stick for use on computer models equipped with the Windows 8 Standard or Professional operating system in Iceland (includes keyboard cable and pointing stick cable)
705613-FL1	Keyboard with pointing stick for use on computer models equipped with the Windows 8 Standard or Professional operating system in the Czech Republic and Slovakia (includes keyboard cable and pointing stick cable)
705613-FP1	Keyboard with pointing stick for use on computer models equipped with the Windows 8 Standard or Professional operating system in Northwest Africa (includes keyboard cable and pointing stick cable)
705614-001	Keyboard with backlight and pointing stick for use on computer models equipped with the Windows 8 Standard or Professional operating system in the United States (includes keyboard cable, backlight cable, and pointing stick cable)
705614-031	Keyboard with backlight and pointing stick for use on computer models equipped with the Windows 8 Standard or Professional operating system in the United Kingdom and Singapore (includes keyboard cable, backlight cable, and pointing stick cable)
705614-041	Keyboard with backlight and pointing stick for use on computer models equipped with the Windows 8 Standard or Professional operating system in Germany (includes keyboard cable, backlight cable, and pointing stick cable)
705614-051	Keyboard with backlight and pointing stick for use on computer models equipped with the Windows 8 Standard or Professional operating system in France (includes keyboard cable, backlight cable, and pointing stick cable)

<b>Spare part number</b>	<b>Description</b>
705614-061	Keyboard with backlight and pointing stick for use on computer models equipped with the Windows 8 Standard or Professional operating system in Italy (includes keyboard cable, backlight cable, and pointing stick cable)
705614-071	Keyboard with backlight and pointing stick for use on computer models equipped with the Windows 8 Standard or Professional operating system in Spain (includes keyboard cable, backlight cable, and pointing stick cable)
705614-081	Keyboard with backlight and pointing stick for use on computer models equipped with the Windows 8 Standard or Professional operating system in Denmark (includes keyboard cable, backlight cable, and pointing stick cable)
705614-091	Keyboard with backlight and pointing stick for use on computer models equipped with the Windows 8 Standard or Professional operating system in Norway (includes keyboard cable, backlight cable, and pointing stick cable)
705614-131	Keyboard with backlight and pointing stick for use on computer models equipped with the Windows 8 Standard or Professional operating system in Portugal (includes keyboard cable, backlight cable, and pointing stick cable)
705614-141	Keyboard with backlight and pointing stick for use on computer models equipped with the Windows 8 Standard or Professional operating system in Turkey (includes keyboard cable, backlight cable, and pointing stick cable)
705614-151	Keyboard with backlight and pointing stick for use on computer models equipped with the Windows 8 Standard or Professional operating system in Greece (includes keyboard cable, backlight cable, and pointing stick cable)
705614-161	Keyboard with backlight and pointing stick for use on computer models equipped with the Windows 8 Standard or Professional operating system in Latin America (includes keyboard cable, backlight cable, and pointing stick cable)
705614-171	Keyboard with backlight and pointing stick for use on computer models equipped with the Windows 8 Standard or Professional operating system in Saudi Arabia (includes keyboard cable, backlight cable, and pointing stick cable)
705614-201	Keyboard with backlight and pointing stick for use on computer models equipped with the Windows 8 Standard or Professional operating system in Brazil (includes keyboard cable, backlight cable, and pointing stick cable)
705614-211	Keyboard with backlight and pointing stick for use on computer models equipped with the Windows 8 Standard or Professional operating system in Hungary (includes keyboard cable, backlight cable, and pointing stick cable)
705614-251	Keyboard with backlight and pointing stick for use on computer models equipped with the Windows 8 Standard or Professional operating system in Russia (includes keyboard cable, backlight cable, and pointing stick cable)
705614-261	Keyboard with backlight and pointing stick for use on computer models equipped with the Windows 8 Standard or Professional operating system in Bulgaria (includes keyboard cable, backlight cable, and pointing stick cable)
705614-271	Keyboard with backlight and pointing stick for use on computer models equipped with the Windows 8 Standard or Professional operating system in Romania (includes keyboard cable, backlight cable, and pointing stick cable)
705614-281	Keyboard with backlight and pointing stick for use on computer models equipped with the Windows 8 Standard or Professional operating system in Thailand (includes keyboard cable, backlight cable, and pointing stick cable)

<b>Spare part number</b>	<b>Description</b>
705614-291	Keyboard with backlight and pointing stick for use on computer models equipped with the Windows 8 Standard or Professional operating system in Japan (includes keyboard cable, backlight cable, and pointing stick cable)
705614-A41	Keyboard with backlight and pointing stick for use on computer models equipped with the Windows 8 Standard or Professional operating system in Belgium (includes keyboard cable, backlight cable, and pointing stick cable)
705614-AB1	Keyboard with backlight and pointing stick for use on computer models equipped with the Windows 8 Standard or Professional operating system in Taiwan (includes keyboard cable, backlight cable, and pointing stick cable)
705614-AD1	Keyboard with backlight and pointing stick for use on computer models equipped with the Windows 8 Standard or Professional operating system in South Korea (includes keyboard cable, backlight cable, and pointing stick cable)
705614-B31	Keyboard with backlight and pointing stick for use on computer models equipped with the Windows 8 Standard or Professional operating system in the Netherlands (includes keyboard cable, backlight cable, and pointing stick cable)
705614-B71	Keyboard with backlight and pointing stick for use on computer models equipped with the Windows 8 Standard or Professional operating system in Sweden and Finland (includes keyboard cable, backlight cable, and pointing stick cable)
705614-BA1	Keyboard with backlight and pointing stick for use on computer models equipped with the Windows 8 Standard or Professional operating system in Slovenia (includes keyboard cable, backlight cable, and pointing stick cable)
705614-BB1	Keyboard with backlight and pointing stick for use on computer models equipped with the Windows 8 Standard or Professional operating system in Israel (includes keyboard cable, backlight cable, and pointing stick cable)
705614-BG1	Keyboard with backlight and pointing stick for use on computer models equipped with the Windows 8 Standard or Professional operating system in Switzerland (includes keyboard cable, backlight cable, and pointing stick cable)
705614-D61	Keyboard with backlight and pointing stick for use on computer models equipped with the Windows 8 Standard or Professional operating system in India (includes keyboard cable, backlight cable, and pointing stick cable)
705614-DB1	Keyboard with backlight and pointing stick for use on computer models equipped with the Windows 8 Standard or Professional operating system in Canada (includes keyboard cable, backlight cable, and pointing stick cable)
705614-DD1	Keyboard with backlight and pointing stick for use on computer models equipped with the Windows 8 Standard or Professional operating system in Iceland (includes keyboard cable, backlight cable, and pointing stick cable)
705614-FL1	Keyboard with backlight and pointing stick for use on computer models equipped with the Windows 8 Standard or Professional operating system in the Czech Republic and Slovakia (includes keyboard cable, backlight cable, and pointing stick cable)
705614-FP1	Keyboard with backlight and pointing stick for use on computer models equipped with the Windows 8 Standard or Professional operating system in Northwest Africa (includes keyboard cable, backlight cable, and pointing stick cable)
710789-001	HP Lt2522 LTE/EV-DO Mobile Broadband Module
710790-001	HP Lt2523 LTE/HSPA+ Mobile Broadband Module

Spare part number	Description
713763-001	500-GB, 7200-rpm, 9.5-mm hard drive (does not include hard drive bracket, hard drive connector adapter, or screws)  <b>NOTE:</b> The hard drive bracket, hard drive connector adapter, and screws are included in the Hard Drive Hardware Kit, spare part number 693350-001.
714519-001	System board equipped with an Intel Dual Core i5-3437U 1.90-GHz (SC turbo up to 2.90-GHz) processor and the Windows 7 operating system for use in all countries and regions (1600-MHz FSB, 3.0-MB L3 cache, 17 W; includes replacement thermal material)
714519-501	System board equipped with an Intel Dual Core i5-3437U 1.90-GHz (SC turbo up to 2.90-GHz) processor and the Windows 8 Standard operating system for use in all countries and regions (1600-MHz FSB, 3.0-MB L3 cache, 17 W; includes replacement thermal material)
714519-601	System board equipped with an Intel Dual Core i5-3437U 1.90-GHz (SC turbo up to 2.90-GHz) processor and the Windows 8 Professional operating system for use in all countries and regions (1600-MHz FSB, 3.0-MB L3 cache, 17 W; includes replacement thermal material)
714520-001	System board equipped with an Intel Quad Core i7-3687U 2.10-GHz (SC turbo up to 3.30-GHz) processor and the Windows 7 operating system for use in all countries and regions (1600-MHz FSB, 4.0-MB L3 cache, 17 W; includes replacement thermal material)
714520-501	System board equipped with an Intel Quad Core i7-3687U 2.10-GHz (SC turbo up to 3.30-GHz) processor and the Windows 8 Standard operating system for use in all countries and regions (1600-MHz FSB, 4.0-MB L3 cache, 17 W; includes replacement thermal material)
714520-601	System board equipped with an Intel Quad Core i7-3687U 2.10-GHz (SC turbo up to 3.30-GHz) processor and the Windows 8 Professional operating system for use in all countries and regions (1600-MHz FSB, 4.0-MB L3 cache, 17 W; includes replacement thermal material)



---

# 4 Removal and replacement procedures

## Preliminary replacement requirements

### Tools required

You will need the following tools to complete the removal and replacement procedures:

- Flat-bladed screw driver
- Magnetic screw driver
- Phillips P0 and P1 screw drivers

### Service considerations

The following sections include some of the considerations that you must keep in mind during disassembly and assembly procedures.

---

 **NOTE:** As you remove each subassembly from the computer, place the subassembly (and all accompanying screws) away from the work area to prevent damage.

---

### Plastic parts

 **CAUTION:** Using excessive force during disassembly and reassembly can damage plastic parts. Use care when handling the plastic parts. Apply pressure only at the points designated in the maintenance instructions.

---

### Cables and connectors

 **CAUTION:** When servicing the computer, be sure that cables are placed in their proper locations during the reassembly process. Improper cable placement can damage the computer.

---

Cables must be handled with extreme care to avoid damage. Apply only the tension required to unseat or seat the cables during removal and insertion. Handle cables by the connector whenever possible. In all cases, avoid bending, twisting, or tearing cables. Be sure that cables are routed in such a way that they cannot be caught or snagged by parts being removed or replaced. Handle flex cables with extreme care; these cables tear easily.

## Drive handling

**⚠ CAUTION:** Drives are fragile components that must be handled with care. To prevent damage to the computer, damage to a drive, or loss of information, observe these precautions:

Before removing or inserting a hard drive, shut down the computer. If you are unsure whether the computer is off or in Hibernation, turn the computer on, and then shut it down through the operating system.

Before handling a drive, be sure that you are discharged of static electricity. While handling a drive, avoid touching the connector.

Before removing a diskette drive or optical drive, be sure that a diskette or disc is not in the drive and be sure that the optical drive tray is closed.

Handle drives on surfaces covered with at least one inch of shock-proof foam.

Avoid dropping drives from any height onto any surface.

After removing a hard drive, an optical drive, or a diskette drive, place it in a static-proof bag.

Avoid exposing an internal hard drive to products that have magnetic fields, such as monitors or speakers.

Avoid exposing a drive to temperature extremes or liquids.

If a drive must be mailed, place the drive in a bubble pack mailer or other suitable form of protective packaging and label the package "FRAGILE."

---

## Grounding guidelines

### Electrostatic discharge damage

Electronic components are sensitive to electrostatic discharge (ESD). Circuitry design and structure determine the degree of sensitivity. Networks built into many integrated circuits provide some protection, but in many cases, ESD contains enough power to alter device parameters or melt silicon junctions.

A discharge of static electricity from a finger or other conductor can destroy static-sensitive devices or microcircuitry. Even if the spark is neither felt nor heard, damage may have occurred.

An electronic device exposed to ESD may not be affected at all and can work perfectly throughout a normal cycle. Or the device may function normally for a while, then degrade in the internal layers, reducing its life expectancy.

**⚠ CAUTION:** To prevent damage to the computer when you are removing or installing internal components, observe these precautions:

Keep components in their electrostatic-safe containers until you are ready to install them.

Before touching an electronic component, discharge static electricity by using the guidelines described in this section.

Avoid touching pins, leads, and circuitry. Handle electronic components as little as possible.

If you remove a component, place it in an electrostatic-safe container.

The following table shows how humidity affects the electrostatic voltage levels generated by different activities.

**⚠ CAUTION:** A product can be degraded by as little as 700 V.

<b>Typical electrostatic voltage levels</b>			
<b>Event</b>	<b>Relative humidity</b>		
	<b>10%</b>	<b>40%</b>	<b>55%</b>
Walking across carpet	35,000 V	15,000 V	7,500 V
Walking across vinyl floor	12,000 V	5,000 V	3,000 V
Motions of bench worker	6,000 V	800 V	400 V
Removing DIPS from plastic tube	2,000 V	700 V	400 V
Removing DIPS from vinyl tray	11,500 V	4,000 V	2,000 V
Removing DIPS from Styrofoam	14,500 V	5,000 V	3,500 V
Removing bubble pack from PCB	26,500 V	20,000 V	7,000 V
Packing PCBs in foam-lined box	21,000 V	11,000 V	5,000 V

## Packaging and transporting guidelines

Follow these grounding guidelines when packaging and transporting equipment:

- To avoid hand contact, transport products in static-safe tubes, bags, or boxes.
- Protect ESD-sensitive parts and assemblies with conductive or approved containers or packaging.
- Keep ESD-sensitive parts in their containers until the parts arrive at static-free workstations.
- Place items on a grounded surface before removing items from their containers.
- Always be properly grounded when touching a component or assembly.
- Store reusable ESD-sensitive parts from assemblies in protective packaging or nonconductive foam.
- Use transporters and conveyors made of antistatic belts and roller bushings. Be sure that mechanized equipment used for moving materials is wired to ground and that proper materials are selected to avoid static charging. When grounding is not possible, use an ionizer to dissipate electric charges.

## Workstation guidelines

Follow these grounding workstation guidelines:

- Cover the workstation with approved static-shielding material.
- Use a wrist strap connected to a properly grounded work surface and use properly grounded tools and equipment.
- Use conductive field service tools, such as cutters, screw drivers, and vacuums.
- When fixtures must directly contact dissipative surfaces, use fixtures made only of static-safe materials.
- Keep the work area free of nonconductive materials, such as ordinary plastic assembly aids and Styrofoam.
- Handle ESD-sensitive components, parts, and assemblies by the case or PCM laminate. Handle these items only at static-free workstations.
- Avoid contact with pins, leads, or circuitry.
- Turn off power and input signals before inserting or removing connectors or test equipment.

## Equipment guidelines

Grounding equipment must include either a wrist strap or a foot strap at a grounded workstation.

- When seated, wear a wrist strap connected to a grounded system. Wrist straps are flexible straps with a minimum of one megohm  $\pm 10\%$  resistance in the ground cords. To provide proper ground, wear a strap snugly against the skin at all times. On grounded mats with banana-plug connectors, use alligator clips to connect a wrist strap.
- When standing, use foot straps and a grounded floor mat. Foot straps (heel, toe, or boot straps) can be used at standing workstations and are compatible with most types of shoes or boots. On conductive floors or dissipative floor mats, use foot straps on both feet with a minimum of one megohm resistance between the operator and ground. To be effective, the conductive must be worn in contact with the skin.

The following grounding equipment is recommended to prevent electrostatic damage:

- Antistatic tape
- Antistatic smocks, aprons, and sleeve protectors
- Conductive bins and other assembly or soldering aids
- Nonconductive foam
- Conductive tabletop workstations with ground cords of one megohm resistance
- Static-dissipative tables or floor mats with hard ties to the ground
- Field service kits
- Static awareness labels
- Material-handling packages
- Nonconductive plastic bags, tubes, or boxes
- Metal tote boxes
- Electrostatic voltage levels and protective materials

The following table lists the shielding protection provided by antistatic bags and floor mats.

<b>Material</b>	<b>Use</b>	<b>Voltage protection level</b>
Antistatic plastics	Bags	1,500 V
Carbon-loaded plastic	Floor mats	7,500 V
Metallized laminate	Floor mats	5,000 V

# Component replacement procedures

This chapter provides removal and replacement procedures.

There are as many as 61 screws that must be removed, replaced, and/or loosened when servicing the computer. Make special note of each screw size and location during removal and replacement.

## Service tag

When ordering parts or requesting information, provide the computer serial number and model number provided on the service tag. It is necessary to remove the battery to obtain these numbers. See [Battery on page 56](#) for battery removal instructions.

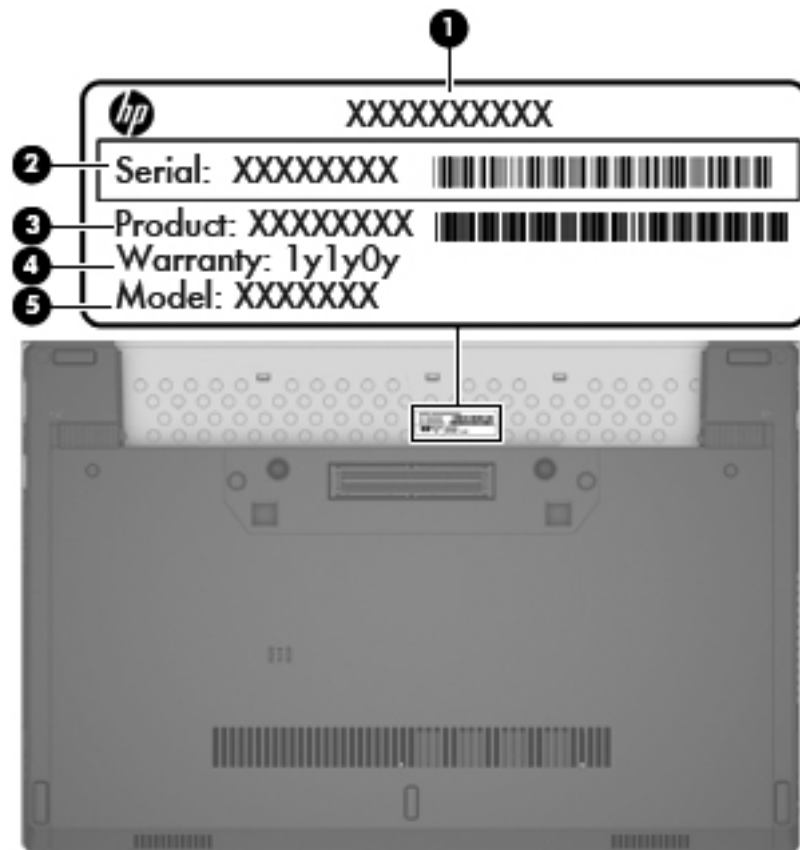

Item	Component	Description
(1)	Product name	This is the product name affixed to the front of the computer.
(2)	Serial number (s/n)	This is an alphanumeric identifier that is unique to each product.
(3)	Part number/Product number (p/n)	This number provides specific information about the product's hardware components. The part number helps a service technician determine what components and parts are needed.

Item	Component	Description
(4)	Warranty period	This number describes the duration of the warranty period for the computer.
(5)	Model description	This is the alphanumeric identifier used to locate documents, drivers, and support for the computer.

## Computer feet

The computer feet are adhesive-backed rubber pads. There are four rectangular rubber feet that attach to the base enclosure in the locations illustrated below.

The feet are included in the Rubber Kit, spare part number 693355-001.

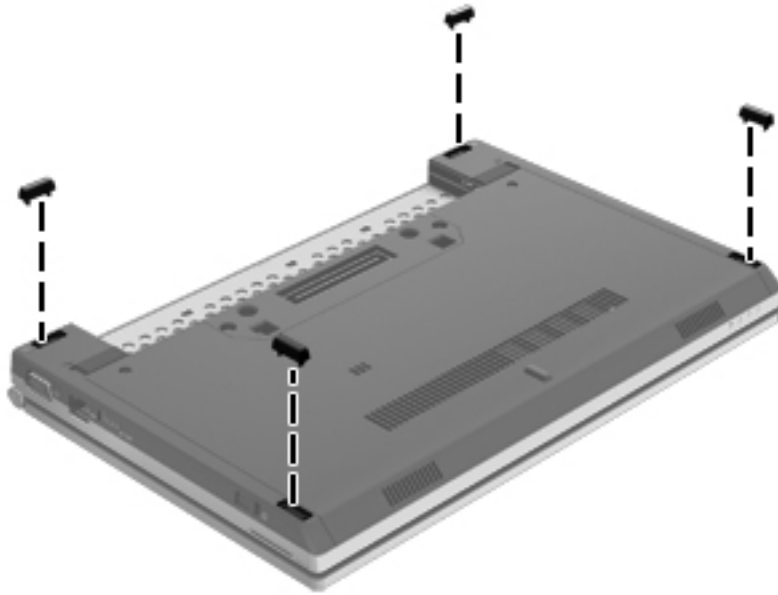

## Battery

Description	Spare part number
6-cell, 48-Wh, 2.2-Ah	685988-001
4-cell, 30-Wh, 2.0-Ah	671604-001

Before disassembling the computer, follow these steps:

1. Turn off the computer. If you are unsure whether the computer is off or in Hibernation, turn the computer on, and then shut it down through the operating system.
2. Disconnect the power from the computer by unplugging the power cord from the computer.
3. Disconnect all external devices from the computer.

Remove the battery:

1. Position the computer upside-down on a flat surface, with the battery bay toward you.
2. Slide the battery lock latch **(1)**, and then slide the battery release latch **(2)** to release the battery.
3. Remove the battery **(3)** from the computer.

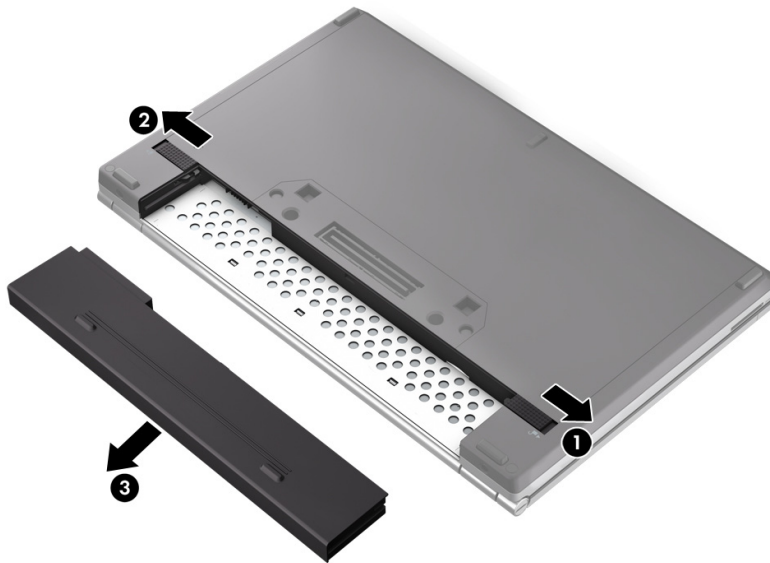

Install the battery by inserting it into the battery bay until you hear a click. The battery lock latch and the battery release latch automatically reset when the battery is installed.



## SIM

 **NOTE:** This section applies only to computer models with WWAN capability.

 **NOTE:** If there is a SIM inserted in the SIM slot, it must be removed before disassembling the computer. Be sure that the SIM is reinserted in the SIM slot after reassembling the computer.

Before removing the SIM, follow these steps:

1. Turn off the computer. If you are unsure whether the computer is off or in Hibernation, turn the computer on, and then shut it down through the operating system.
2. Disconnect the power from the computer by unplugging the power cord from the computer.
3. Disconnect all external devices from the computer.
4. Remove the battery (see [Battery on page 56](#)).

Remove the SIM:

1. Press in on the SIM **(1)**. (The SIM partially ejects from the SIM slot.)
2. Remove the SIM **(2)** from the SIM slot.

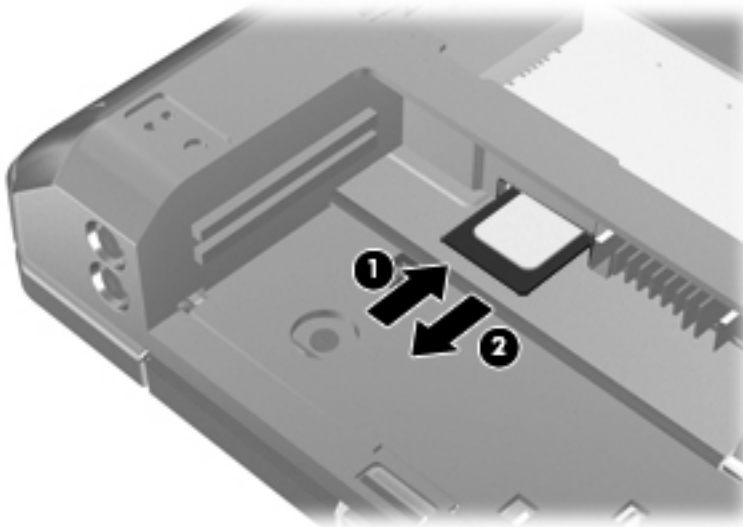

Reverse this procedure to install the SIM.

## Service cover

Description	Spare part number
Includes label indicating "Made in China"	693315-001
Includes label indicating country of origin	704017-001

Before removing the service cover, follow these steps:

1. Turn off the computer. If you are unsure whether the computer is off or in Hibernation, turn the computer on, and then shut it down through the operating system.
2. Disconnect the power from the computer by unplugging the power cord from the computer.
3. Disconnect all external devices from the computer.
4. Remove the battery (see [Battery on page 56](#)).

Remove the service cover:

1. Loosen the two Phillips PM2.0×5.5 screws **(1)** that secure the service cover to the computer.
2. Slide the service cover **(2)** forward to disengage the cover from the computer.
3. Remove the service cover **(3)** by lifting it straight up and away from the computer.

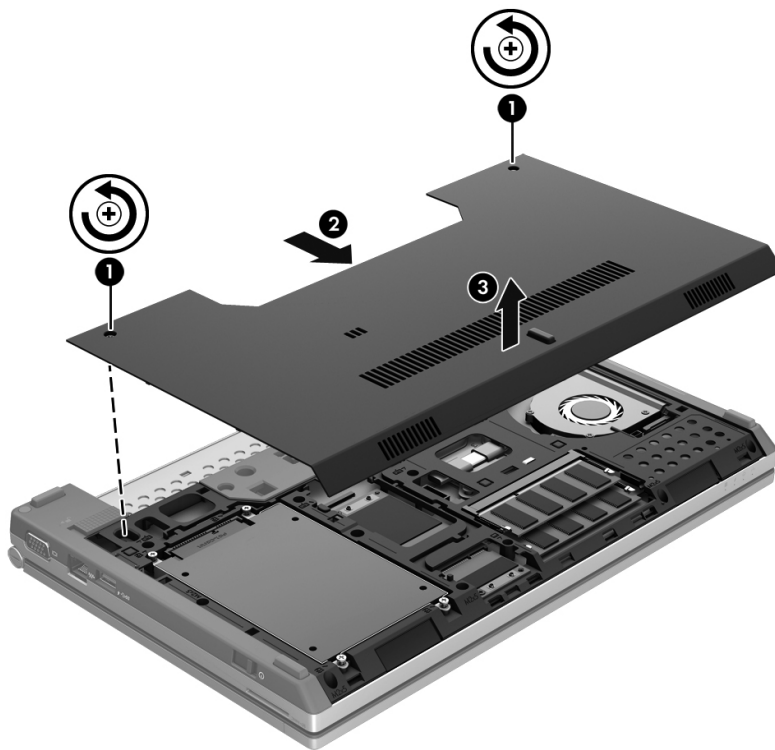

Reverse the removal procedures to install the service cover.

## Hard drive



**NOTE:** The hard drive spare part kit does not include the hard drive bracket, hard drive connector adapter, or screws.

Description	Spare part number
750-GB, 7200-rpm, 9.5-mm	633252-001
500-GB, 7200-rpm, 9.5-mm SED	683801-001
500-GB, 7200-rpm, 9.5-mm	634925-001
320-GB, 7200-rpm, 9.5-mm	641672-001
Hard Drive Hardware Kit (includes the hard drive bracket, hard drive connector adapter, and screws)	693350-001

Before removing the hard drive, follow these steps:

1. Turn off the computer. If you are unsure whether the computer is off or in Hibernation, turn the computer on, and then shut it down through the operating system.
2. Disconnect the power from the computer by unplugging the power cord from the computer.
3. Disconnect all external devices from the computer.
4. Remove the battery (see [Battery on page 56](#)).
5. Remove the service cover (see [Service cover on page 58](#)).

Remove the hard drive:

1. Loosen the four Phillips PM2.0×5.5 screws (**1**) that secure the hard drive to the computer.

2. Use the hard drive tab **(2)** to disconnect the hard drive from the system board and remove the hard drive from the computer.

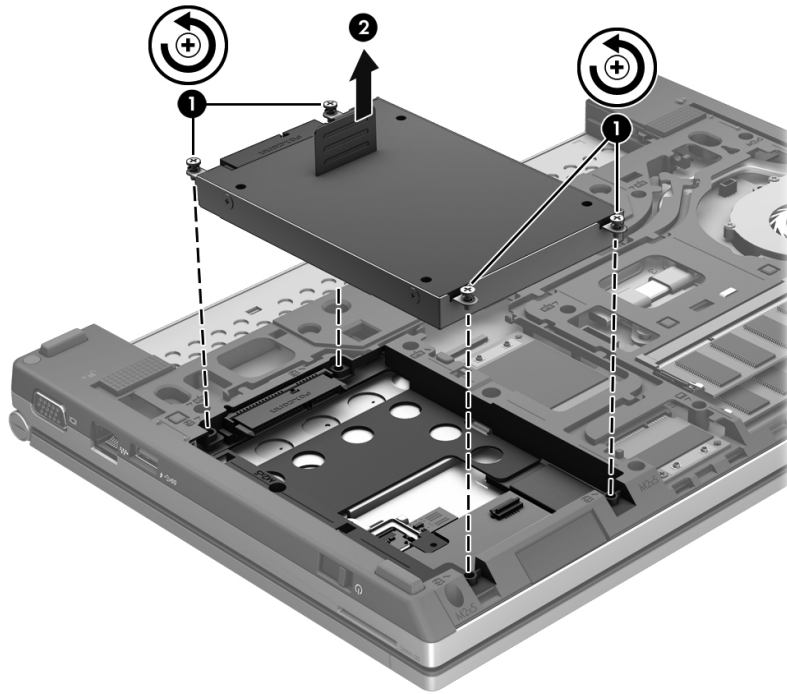

3. If it is necessary to disassemble the hard drive, perform the following steps:
  - a. Position the hard drive with the connector toward you.
  - b. Disconnect the hard drive connector adapter **(1)** from the hard drive.
  - c. Remove the four Phillips PM2.9×4.1 screws **(2)** that secure the hard drive bracket to the hard drive.
  - d. Lift the left side of the hard drive bracket **(3)** until it rests at an angle.
  - e. Remove the hard drive bracket **(4)** from the hard drive.

The hard drive bracket, hard drive connector adapter, and screws are available in the Hard Drive Hardware Kit, spare part number 693350-001.

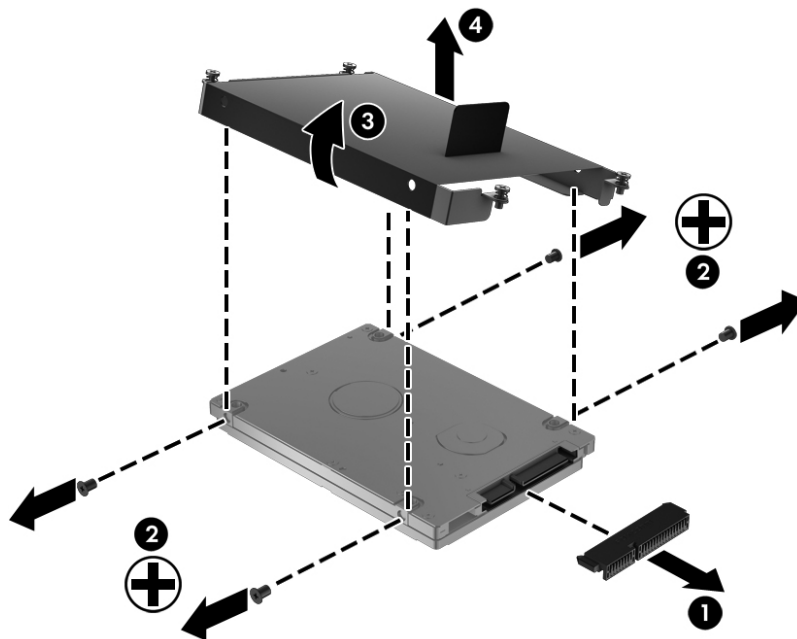

Reverse this procedure to reassemble and install the hard drive.

## Fingerprint reader board

Description	Spare part number
Fingerprint reader board (includes bracket and cable)	693349-001

Before removing the fingerprint reader board, follow these steps:

1. Turn off the computer. If you are unsure whether the computer is off or in Hibernation, turn the computer on, and then shut it down through the operating system.
2. Disconnect the power from the computer by unplugging the power cord from the computer.
3. Disconnect all external devices from the computer.
4. Remove the battery (see [Battery on page 56](#)).
5. Remove the service cover (see [Service cover on page 58](#)).
6. Remove the hard drive (see [Hard drive on page 59](#)).

Remove the fingerprint reader board:

1. Release the zero insertion force (ZIF) connector to which the fingerprint reader board cable is attached, and then disconnect the fingerprint reader board cable **(1)** from the SD Card reader board.
2. Remove the Phillips PM2.0x2.0 screw **(2)** that secures the fingerprint reader board bracket to the top cover.

3. Lift the rear edge of the fingerprint reader board bracket **(3)**, and then remove the bracket.
4. Remove the fingerprint reader board and cable **(4)**.

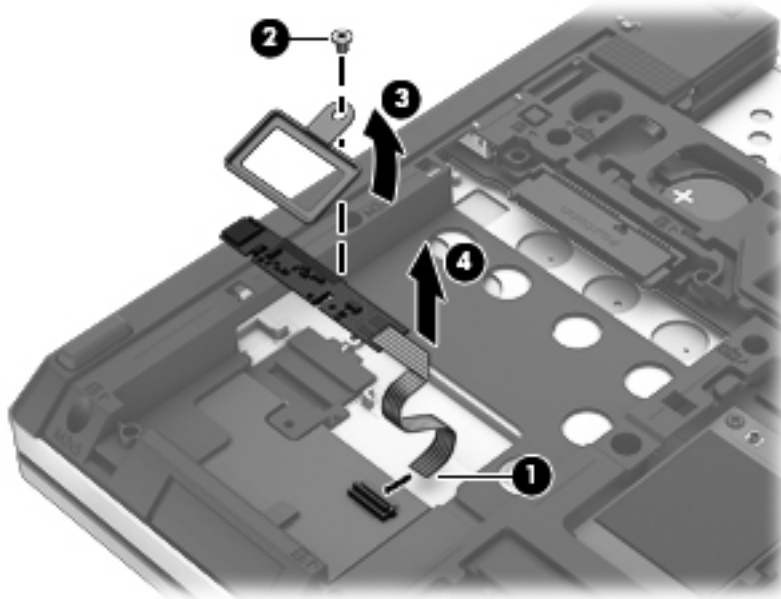

Reverse this procedure to install the fingerprint reader board.

## WLAN module

Description	Spare part number
Atheros AR9462 802.11a/b/g/n 2x2 Bluetooth 4.0 Combo Adapter	676786-001
Broadcom 4313GN 802.11b/g/n 1x1 WiFi and 20702 Bluetooth 4.0 Combo Adapter	657325-001
Intel Centrino Advanced-N 6235 WLAN module	670292-001
Intel Centrino Advanced-N 6205 WLAN module	631954-001

**CAUTION:** To prevent an unresponsive system, replace the wireless module only with a wireless module authorized for use in the computer by the governmental agency that regulates wireless devices in your country or region. If you replace the module and then receive a warning message, remove the module to restore device functionality, and then contact technical support.

Before removing the WLAN module, follow these steps:

1. Turn off the computer. If you are unsure whether the computer is off or in Hibernation, turn the computer on, and then shut it down through the operating system.
2. Disconnect the power from the computer by unplugging the power cord from the computer.
3. Disconnect all external devices from the computer.

4. Remove the battery (see [Battery on page 56](#)).
5. Remove the service cover (see [Service cover on page 58](#)).

Remove the WLAN module:

1. Disconnect the WLAN antenna cables **(1)** from the terminals on the WLAN module.

 **NOTE:** The WLAN antenna cable labeled “1” connects to the WLAN module “Main” terminal labeled “1”. The WLAN antenna cable labeled “2” connects to the WLAN module “Aux” terminal labeled “2”. If the computer is equipped with an 802.11a/b/g/n WLAN module, the yellow WLAN antenna cable connects to the middle terminal on the WLAN module.

2. Remove the Phillips PM2.0×3.0 screw **(2)** that secures the WLAN module to the base enclosure. (The WLAN module tilts up.)
3. Remove the WLAN module **(3)** by pulling the module away from the slot at an angle.

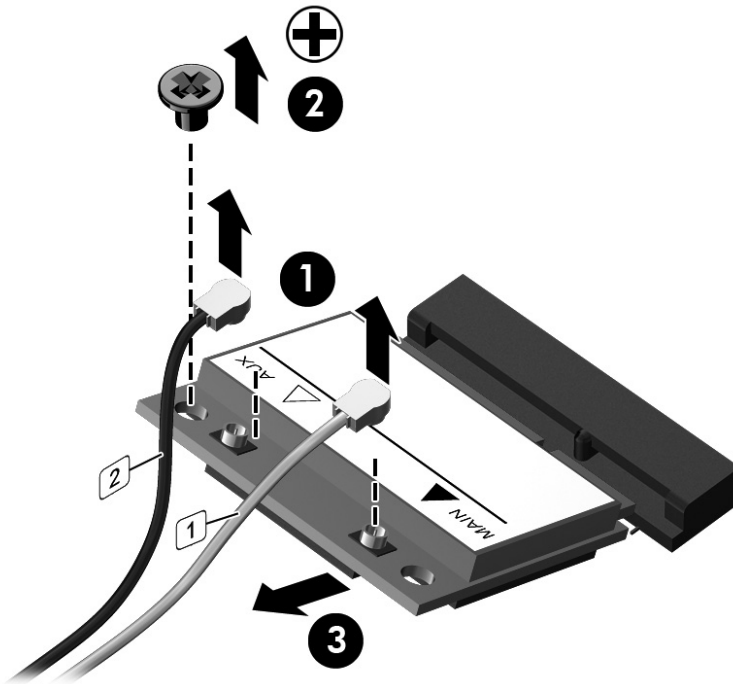

 **NOTE:** If the WLAN antenna cables are not connected to the terminals on the WLAN module, the protective sleeves must be installed on the antenna connectors, as shown in the following illustration.

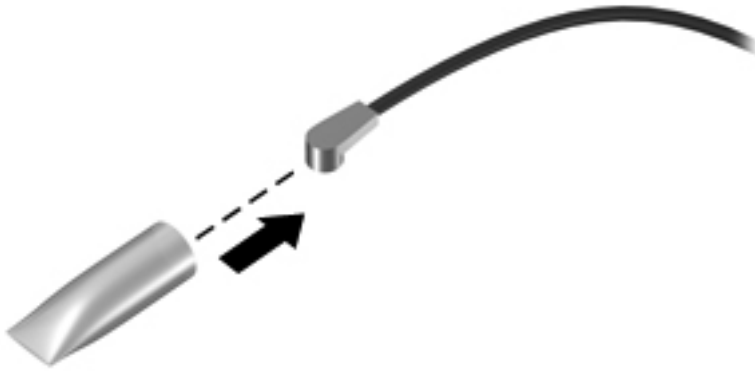

Reverse this procedure to install the WLAN module.

## WWAN module

 **NOTE:** The WWAN module and the WLAN module are not interchangeable.

Description	Spare part number
HP hs2350 HSPA+ Mobile Broadband Module	668969-001
HP lt2523 LTE/HSPA+ Mobile Broadband Module	710790-001
HP lt2522 LTE/EV-DO Mobile Broadband Module	710789-001
HP un2430 EV-DO/HSPA Mini Card	702080-001
HP un2430 EV-DO/HSPA Mobile Broadband Module	634400-001

Before removing the WWAN module, follow these steps:

1. Turn off the computer. If you are unsure whether the computer is off or in Hibernation, turn the computer on, and then shut it down through the operating system.
2. Disconnect the power from the computer by unplugging the power cord from the computer.
3. Disconnect all external devices from the computer.
4. Remove the battery (see [Battery on page 56](#)).
5. Remove the service cover (see [Service cover on page 58](#)).

Remove the WWAN module:

1. Disconnect the WWAN antenna cables **(1)** from the terminals on the WWAN module.

 **NOTE:** The red WWAN antenna cable is connected to the WWAN module “Main” terminal. The blue WWAN antenna cable is connected to the WWAN module “Aux” terminal.

2. Remove the Phillips PM2.0×3.0 screw **(2)** that secures the WWAN module to the base enclosure. (The WWAN module tilts up.)



3. Remove the WWAN module (3) by pulling the module away from the slot at an angle.

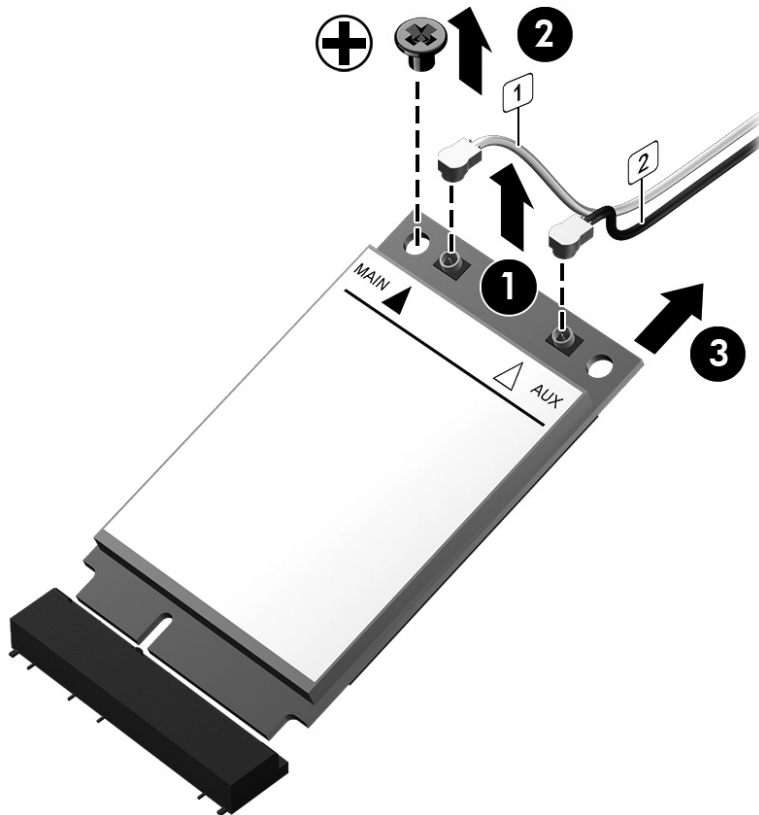

 **NOTE:** If the WWAN antenna cables are not connected to the terminals on the WWAN module, the protective sleeves must be installed on the antenna connectors, as shown in the following illustration.

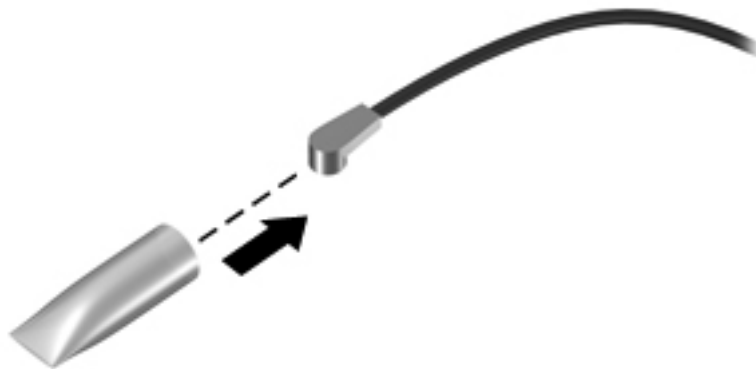

Reverse this procedure to install the WWAN module.

## Memory module

 **NOTE:** Primary and expansion memory is installed in a stacked configuration in the bottom of the computer.

Description	Spare part number
8-GB memory module (PC3, 12800, 1600-MHz)	670034-001
4-GB memory module (PC3, 12800, 1600-MHz)	641369-001
2-GB memory module (PC3, 12800, 1600-MHz)	652972-001

### Update BIOS before adding memory modules

Before adding new memory, make sure you update the computer to the latest BIOS.

 **CAUTION:** Failure to update the computer to the latest BIOS prior to installing new memory may result in various system problems.

To update BIOS:

1. Navigate to [www.hp.com](http://www.hp.com).
2. Click **Support & Drivers > click Drivers & Software**.
3. In the **Enter a product name/number box**, type the computer model information, and then click **Search**.
4. Click the link for the computer model.
5. Select the operating system, and then click **Next**.
6. Under **Step 2: Select a Download**, click the **BIOS** link.
7. Click the link for the most recent BIOS.
8. Click the **Download** button, and then follow the on-screen instructions.

Before removing a memory module, follow these steps:

1. Turn off the computer. If you are unsure whether the computer is off or in Hibernation, turn the computer on, and then shut it down through the operating system.
2. Disconnect the power from the computer by unplugging the power cord from the computer.
3. Disconnect all external devices from the computer.
4. Remove the battery (see [Battery on page 56](#)).
5. Remove the service cover (see [Service cover on page 58](#)).

Remove the memory module:

1. Spread the retaining tabs **(1)** on each side of the memory module slot to release the memory module. (The edge of the module opposite the slot rises away from the computer.)

2. Remove the memory module **(2)** by pulling the module away from the slot at an angle.

 **NOTE:** The computer uses two memory slots. The top slot houses the expansion memory module. The bottom slot houses the primary memory module.

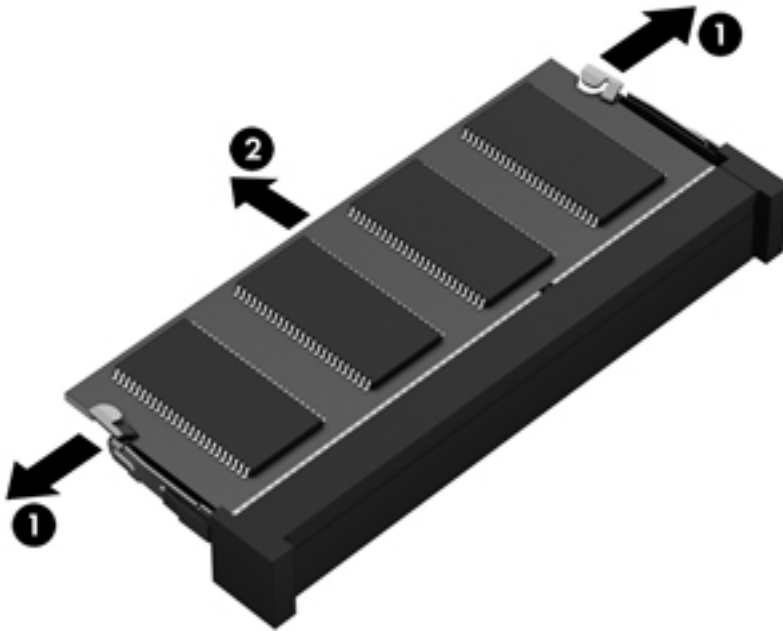

Reverse this procedure to install a memory module.

## Fan

Description	Spare part number
Fan (includes cable)	693308-001

Before removing the fan, follow these steps:

1. Turn off the computer. If you are unsure whether the computer is off or in Hibernation, turn the computer on, and then shut it down through the operating system.
2. Disconnect the power from the computer by unplugging the power cord from the computer.
3. Disconnect all external devices from the computer.
4. Remove the battery (see [Battery on page 56](#)).
5. Remove the service cover (see [Service cover on page 58](#)).

Remove the fan:

1. Disconnect the fan cable **(1)** from the system board.
2. Remove the two Phillips PM2.0×3.4 screws **(2)** that secure the fan to the top cover.
3. Lift the left side of the fan **(3)** until it rests at an angle, and then remove the fan.

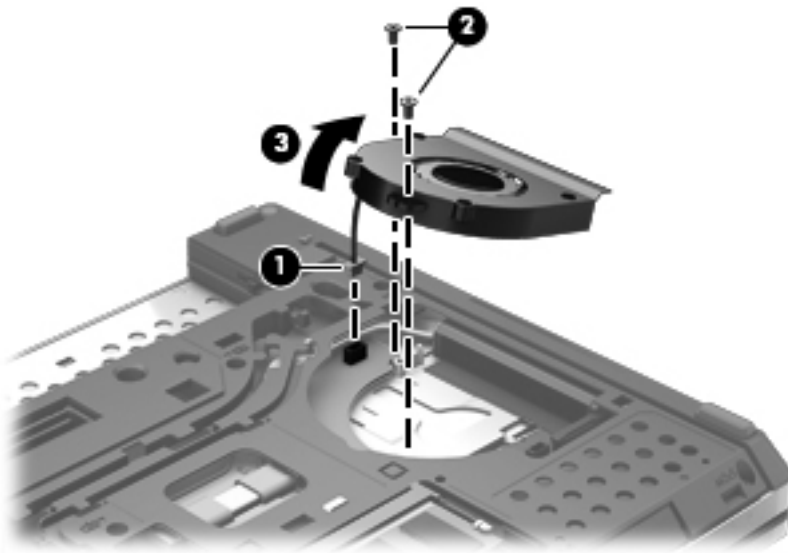

Reverse this procedure to install the fan.

# Keyboard

For use in country/region	Spare part number	For use in country/region	Spare part number
Keyboard with backlight and pointing stick (includes keyboard cable, backlight cable, and pointing stick cable):			
For use only on computer models equipped with the Windows 8 Standard and Professional operating system:		For use in the Netherlands	705614-B31
For use in Belgium	705614-A41	For use in Norway	705614-091
For use in Brazil	705614-201	For use in Northwest Africa	705614-FP1
For use in Bulgaria	705614-261	For use in Portugal	705614-131
For use in Canada	705614-DB1	For use in Romania	705614-271
For use in the Czech Republic and Slovakia	705614-FL1	For use in Russia	705614-251
For use in Denmark	705614-081	For use in Saudi Arabia	705614-171
For use in France	705614-051	For use in Slovenia	705614-BA1
For use in Germany	705614-041	For use in South Korea	705614-AD1
For use in Greece	705614-151	For use in Spain	705614-071
For use in Hungary	705614-211	For use in Sweden and Finland	705614-B71
For use in Iceland	705614-DD1	For use in Switzerland	705614-BG1
For use in India	705614-D61	For use in Taiwan	705614-AB1
For use in Israel	705614-BB1	For use in Thailand	705614-281
For use in Italy	705614-061	For use in Turkey	705614-141
For use in Japan	705614-291	For use in the United Kingdom and Singapore	705614-031
For use in Latin America	705614-161	For use in the United States	705614-001
For use only on computer models equipped with the Windows 7 operating system:		For use in the Netherlands	693363-B31
For use in Belgium	693363-A41	For use in Norway	693363-091
For use in Brazil	693363-201	For use in Northwest Africa	693363-FP1
For use in Bulgaria	693363-261	For use in Portugal	693363-131
For use in Canada	693363-DB1	For use in Romania	693363-271
For use in the Czech Republic and Slovakia	693363-FL1	For use in Russia	693363-251
For use in Denmark	693363-081	For use in Saudi Arabia	693363-171
For use in France	693363-051	For use in Slovenia	693363-BA1
For use in Germany	693363-041	For use in South Korea	693363-AD1

<b>For use in country/region</b>	<b>Spare part number</b>	<b>For use in country/region</b>	<b>Spare part number</b>
For use in Greece	693363-151	For use in Spain	693363-071
For use in Hungary	693363-211	For use in Sweden and Finland	693363-B71
For use in Iceland	693363-DD1	For use in Switzerland	693363-BG1
For use in India	693363-D61	For use in Taiwan	693363-AB1
For use in Israel	693363-BB1	For use in Thailand	693363-281
For use in Italy	693363-061	For use in Turkey	693363-141
For use in Japan	693363-291	For use in the United Kingdom and Singapore	693363-031
For use in Latin America	693363-161	For use in the United States	693363-001
Keyboard with pointing stick (includes keyboard cable and pointing stick cable):			
For use only on computer models equipped with the Windows 8 Standard and Professional operating system:		For use in the Netherlands	705613-B31
For use in Belgium	705613-A41	For use in Norway	705613-091
For use in Brazil	705613-201	For use in Northwest Africa	705613-FP1
For use in Bulgaria	705613-261	For use in Portugal	705613-131
For use in Canada	705613-DB1	For use in Romania	705613-271
For use in the Czech Republic and Slovakia	705613-FL1	For use in Russia	705613-251
For use in Denmark	705613-081	For use in Saudi Arabia	705613-171
For use in France	705613-051	For use in Slovenia	705613-BA1
For use in Germany	705613-041	For use in South Korea	705613-AD1
For use in Greece	705613-151	For use in Spain	705613-071
For use in Hungary	705613-211	For use in Sweden and Finland	705613-B71
For use in Iceland	705613-DD1	For use in Switzerland	705613-BG1
For use in India	705613-D61	For use in Taiwan	705613-AB1
For use in Israel	705613-BB1	For use in Thailand	705613-281
For use in Italy	705613-061	For use in Turkey	705613-141
For use in Japan	705613-291	For use in the United Kingdom and Singapore	705613-031
For use in Latin America	705613-161	For use in the United States	705613-001
For use only on computer models equipped with the Windows 7 operating system:		For use in the Netherlands	693362-B31
For use in Belgium	693362-A41	For use in Norway	693362-091
For use in Brazil	693362-201	For use in Northwest Africa	693362-FP1

<b>For use in country/region</b>	<b>Spare part number</b>	<b>For use in country/region</b>	<b>Spare part number</b>
For use in Bulgaria	693362-261	For use in Portugal	693362-131
For use in Canada	693362-DB1	For use in Romania	693362-271
For use in the Czech Republic and Slovakia	693362-FL1	For use in Russia	693362-251
For use in Denmark	693362-081	For use in Saudi Arabia	693362-171
For use in France	693362-051	For use in Slovenia	693362-BA1
For use in Germany	693362-041	For use in South Korea	693362-AD1
For use in Greece	693362-151	For use in Spain	693362-071
For use in Hungary	693362-211	For use in Sweden and Finland	693362-B71
For use in Iceland	693362-DD1	For use in Switzerland	693362-BG1
For use in India	693362-D61	For use in Taiwan	693362-AB1
For use in Israel	693362-BB1	For use in Thailand	693362-281
For use in Italy	693362-061	For use in Turkey	693362-141
For use in Japan	693362-291	For use in the United Kingdom and Singapore	693362-031
For use in Latin America	693362-161	For use in the United States	693362-001

Before removing the keyboard, follow these steps:

- 1.** Turn off the computer. If you are unsure whether the computer is off or in Hibernation, turn the computer on, and then shut it down through the operating system.
- 2.** Disconnect the power from the computer by unplugging the power cord from the computer.
- 3.** Disconnect all external devices from the computer.
- 4.** Remove the battery (see [Battery on page 56](#)).
- 5.** Remove the service cover (see [Service cover on page 58](#)).

Remove the keyboard:

1. Loosen the four Phillips captive screws that secure the keyboard to the computer.

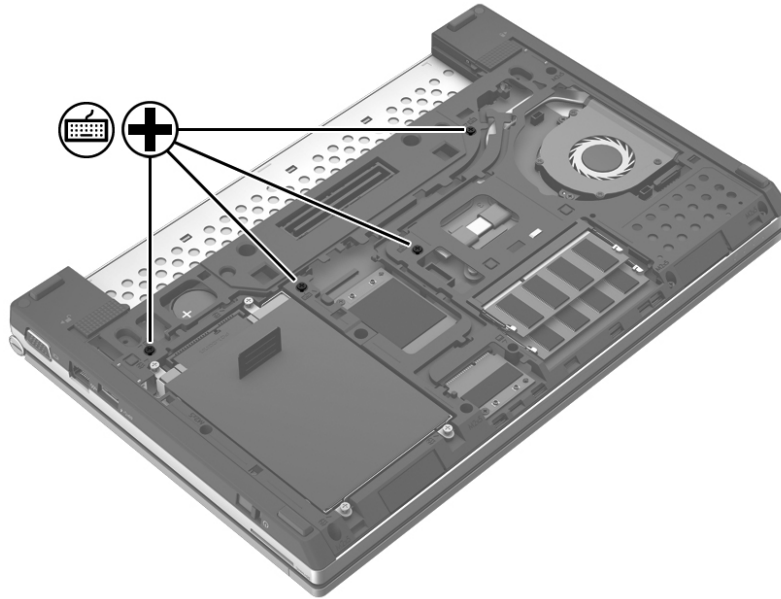

2. Rest and secure the computer on its left side.
3. Partially open the computer.



4. Insert a screw driver or similar thin tool into the keyboard release opening in the battery bay, and then press on the back of the keyboard until the keyboard disengages from the computer.

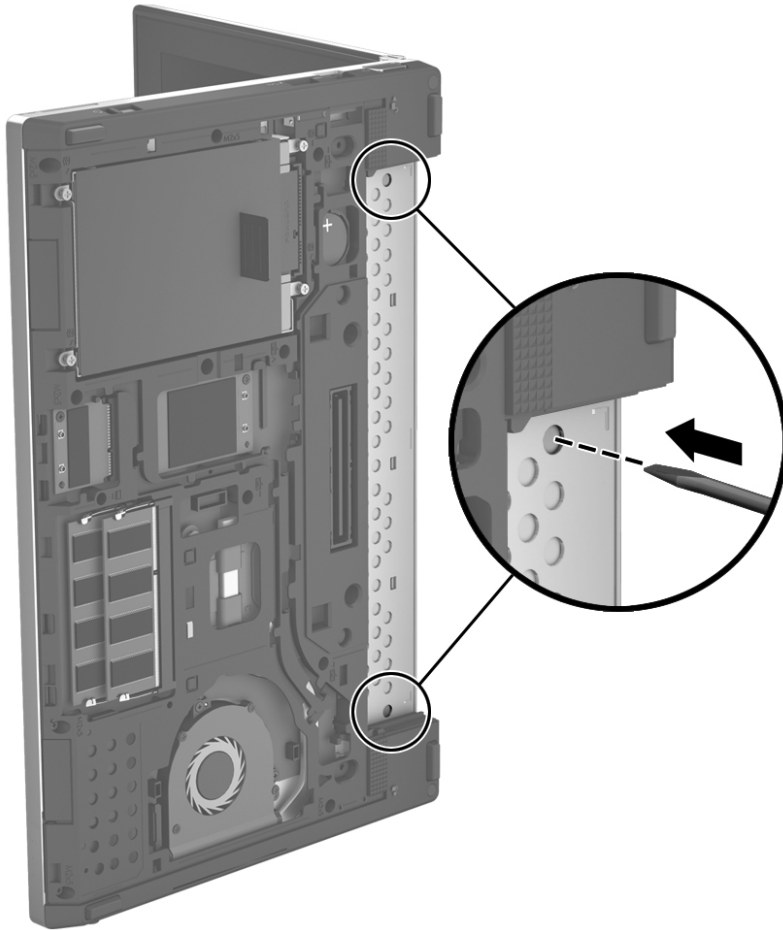

5. Turn the computer right-side up with the front toward you.
6. Open the computer.
7. Lift the rear edge of the keyboard **(1)** until the keyboard rests at an angle.
8. Slide the keyboard **(2)** toward the display until the tabs on the front edge of the keyboard disengage from the slots in the top cover.

9. Swing the top edge of the keyboard up and forward **(3)** until it rests upside down on the palm rest.

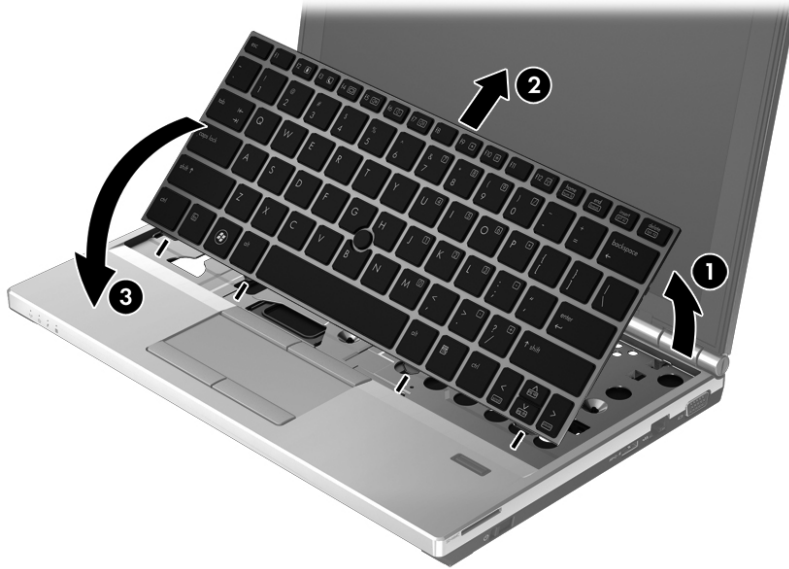

---

 **NOTE:** The keyboard backlight cable is present on select models only.

---

10. Release the ZIF connector **(1)** to which the keyboard backlight cable is attached, and then disconnect the keyboard backlight cable **(2)** from the system board.
11. Release the ZIF connector **(3)** to which the keyboard cable is attached, and then disconnect the keyboard cable **(4)** from the system board.

- 12.** Release the ZIF connector **(5)** to which the pointing stick cable is attached, and then disconnect the pointing stick cable **(6)** from the system board.

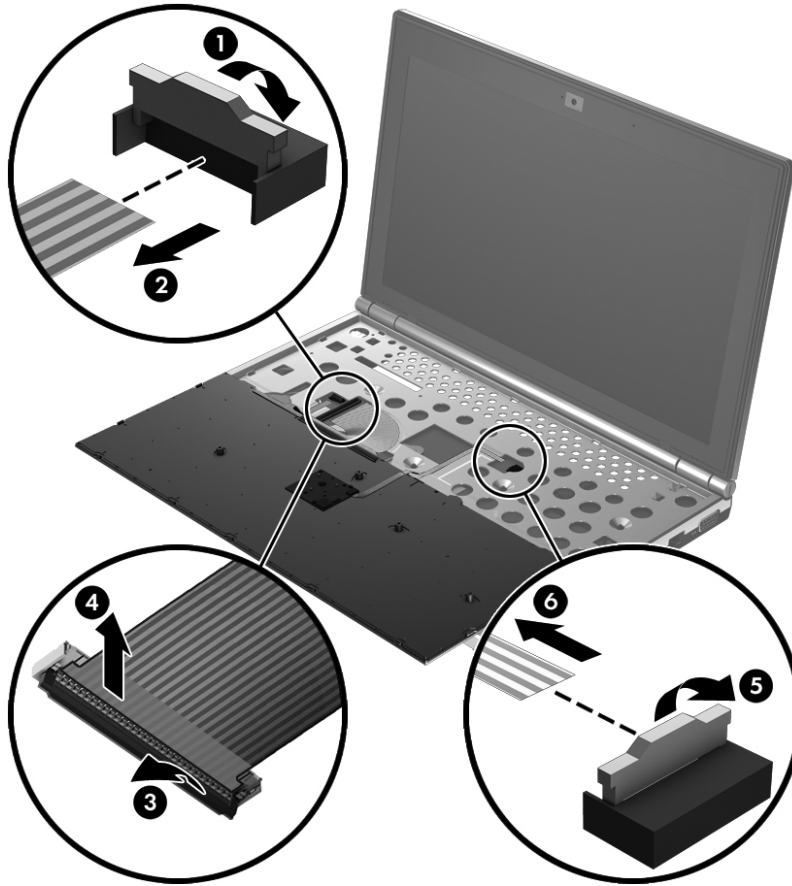

- 13.** Remove the keyboard.

Reverse this procedure to install the keyboard.

## Base enclosure

Description	Spare part number
Base enclosure (includes battery release latch assembly, rubber feet, and service cover release latch assembly)	693301-001

Before removing the base enclosure, follow these steps:

1. Turn off the computer. If you are unsure whether the computer is off or in Hibernation, turn the computer on, and then shut it down through the operating system.
2. Disconnect the power from the computer by unplugging the power cord from the computer.
3. Disconnect all external devices from the computer.
4. Remove the battery (see [Battery on page 56](#)), and then remove the following components:
  - a. Service cover (see [Service cover on page 58](#))
  - b. Hard drive (see [Hard drive on page 59](#))
  - c. WLAN module (see [WLAN module on page 62](#))
  - d. WWAN module (see [WWAN module on page 64](#))
  - e. Keyboard (see [Keyboard on page 69](#))



**NOTE:** When replacing the base enclosure, be sure to remove the following components from the defective base enclosure and install them on the replacement base enclosure:

- Audio board (see [Audio board on page 80](#))
- Speakers (see [Speakers on page 81](#))
- Power switch board (see [Power switch board on page 83](#))

Remove the base enclosure:

1. Close the computer.
2. Turn the computer upside down, with the front toward you.

3. Disconnect the following cables from the system board:
  - (1) Display panel cable
  - (2) Power switch board cable
  - (3) Speaker cable
  - (4) Audio board cable

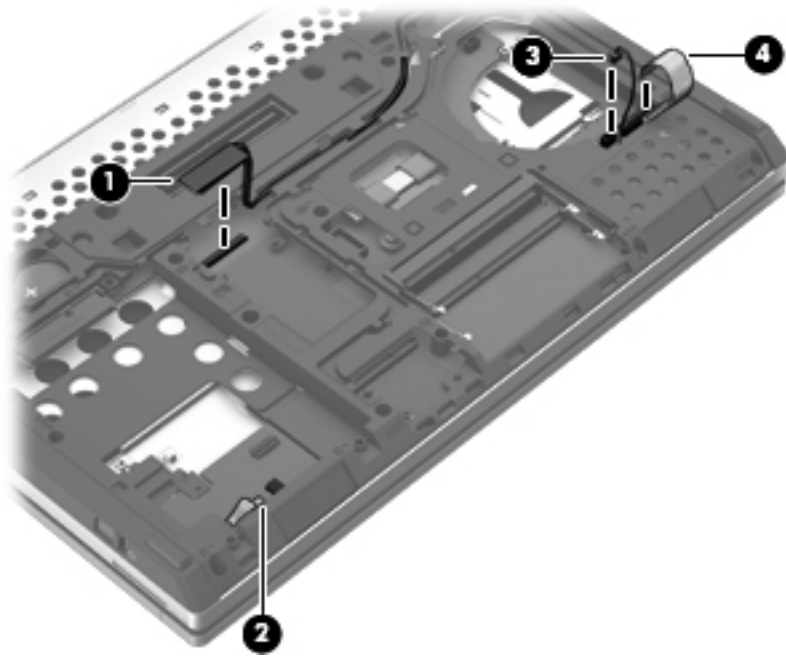

4. Release the display panel cable and wireless antenna cables (1) from the clips (2) and routing channels built into the base enclosure.

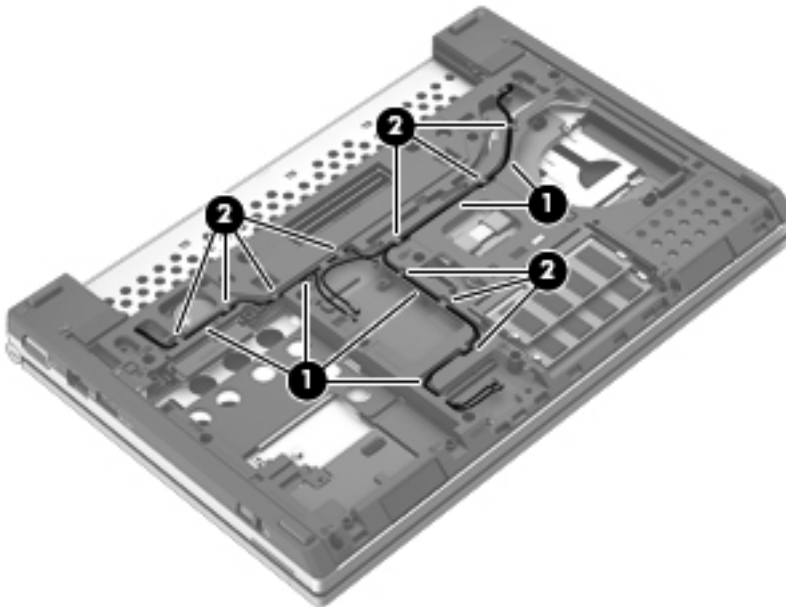

5. Remove the two rubber screw covers **(1)** and **(2)** in the rear corners of the base enclosure.

The rubber screw covers are included in the Rubber Kit, spare part number 693355-001.

 **NOTE:** The rubber screw covers are different sizes. The longer rubber screw cover **(2)** should be installed in the rear/right corner.

6. Remove the ten Torx TM2.0x5.6 screws **(3)** that secure the base enclosure to the computer.

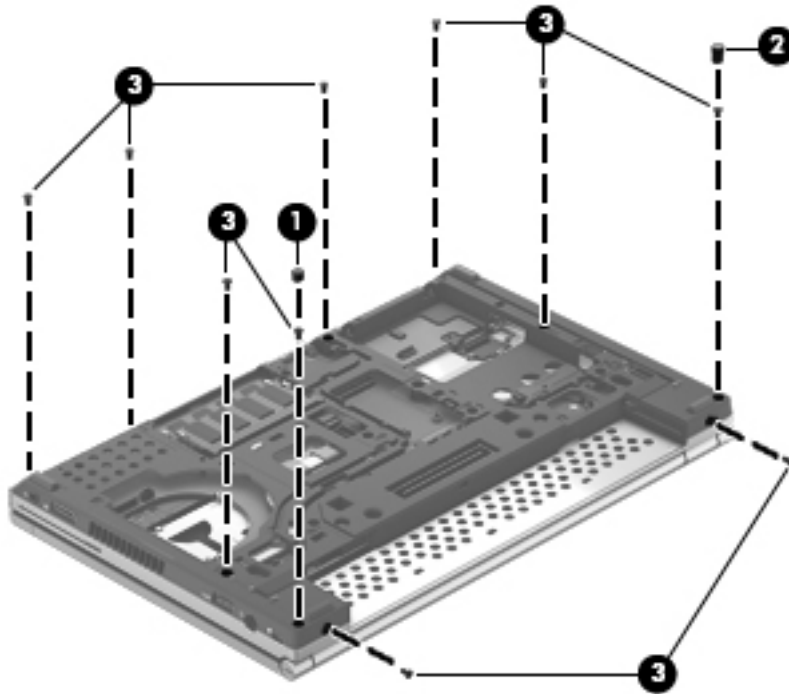

7. Remove the two Torx TM2.0x3.7 screws from the docking station alignment guide holes that secure the base enclosure to the computer.

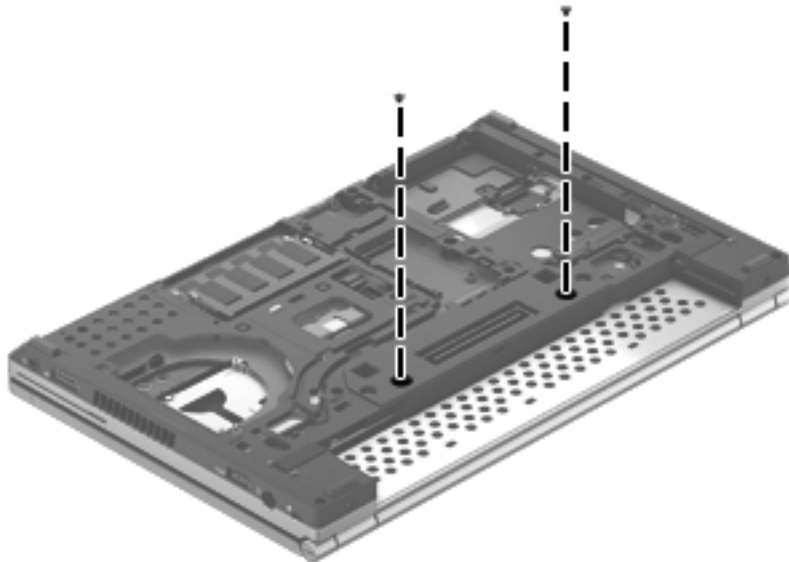

8. Position the computer with the front toward you.

9. Disengage the base enclosure **(1)** from the top cover, making sure to guide the left-side wireless antenna cables **(2)** through the base enclosure left-side opening **(3)** and the right-side wireless antenna cables **(4)** through the base enclosure right-side opening **(5)**.

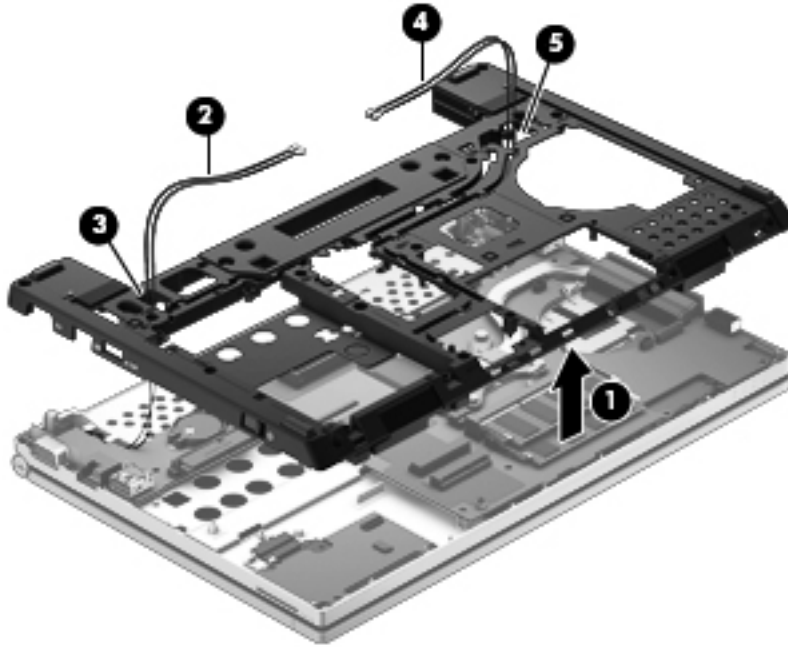

10. Remove the base enclosure

Reverse this procedure to install the base enclosure.

## Audio board



**NOTE:** The audio board spare part kit does not include an audio board cable. The audio board cable is included in the Cable Kit, spare part number 693306-001.

Description	Spare part number
Audio board	693351-001

Before removing the audio board, follow these steps:

1. Turn off the computer. If you are unsure whether the computer is off or in Hibernation, turn the computer on, and then shut it down through the operating system.
2. Disconnect the power from the computer by unplugging the power cord from the computer.
3. Disconnect all external devices from the computer.
4. Remove the battery (see [Battery on page 56](#)), and then remove the following components:
  - a. Service cover (see [Service cover on page 58](#))
  - b. Hard drive (see [Hard drive on page 59](#))
  - c. WLAN module (see [WLAN module on page 62](#))
  - d. WWAN module (see [WWAN module on page 64](#))
  - e. Keyboard (see [Keyboard on page 69](#))
  - f. Base enclosure (see [Base enclosure on page 76](#))

Remove the audio board:

1. Turn the base enclosure right side up, with the front toward you.
2. Remove the Phillips PM2.0×3.7 screw **(1)** that secures the audio board to the base enclosure.
3. Lift the right side of the audio board **(2)** until it rests at an angle.



4. Remove the audio board **(3)** and cable.

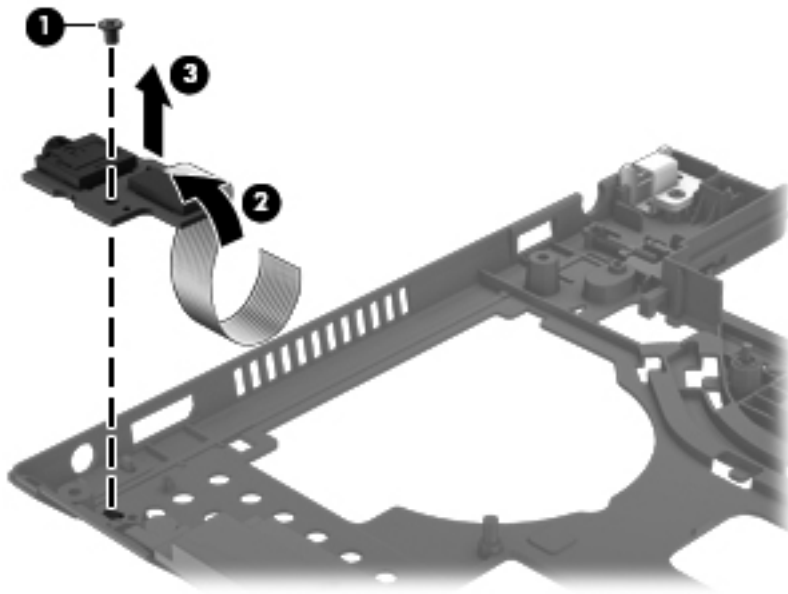

Reverse this procedure to install the audio board.

## Speakers

Description	Spare part number
Speakers (include cables and 4 rubber isolators)	655792-001

Before removing the speakers, follow these steps:

1. Turn off the computer. If you are unsure whether the computer is off or in Hibernation, turn the computer on, and then shut it down through the operating system.
2. Disconnect the power from the computer by unplugging the power cord from the computer.
3. Disconnect all external devices from the computer.
4. Remove the battery (see [Battery on page 56](#)), and then remove the following components:
  - a. Service cover (see [Service cover on page 58](#))
  - b. Hard drive (see [Hard drive on page 59](#))
  - c. WLAN module (see [WLAN module on page 62](#))
  - d. WWAN module (see [WWAN module on page 64](#))
  - e. Keyboard (see [Keyboard on page 69](#))
  - f. Base enclosure (see [Base enclosure on page 76](#))

Remove the speakers:

1. Turn the base enclosure right side up, with the front toward you.
2. Release the speaker cable **(1)** from the clips built into the base enclosure.
3. Remove the four Phillips PM2.5×5.9 screws **(2)** that secure the speakers to the base enclosure.
4. Remove the speakers **(3)**.

 **NOTE:** The speakers include four rubber isolators that are installed in the screw holes **(4)**. These isolators are crucial to the performance of the speakers.

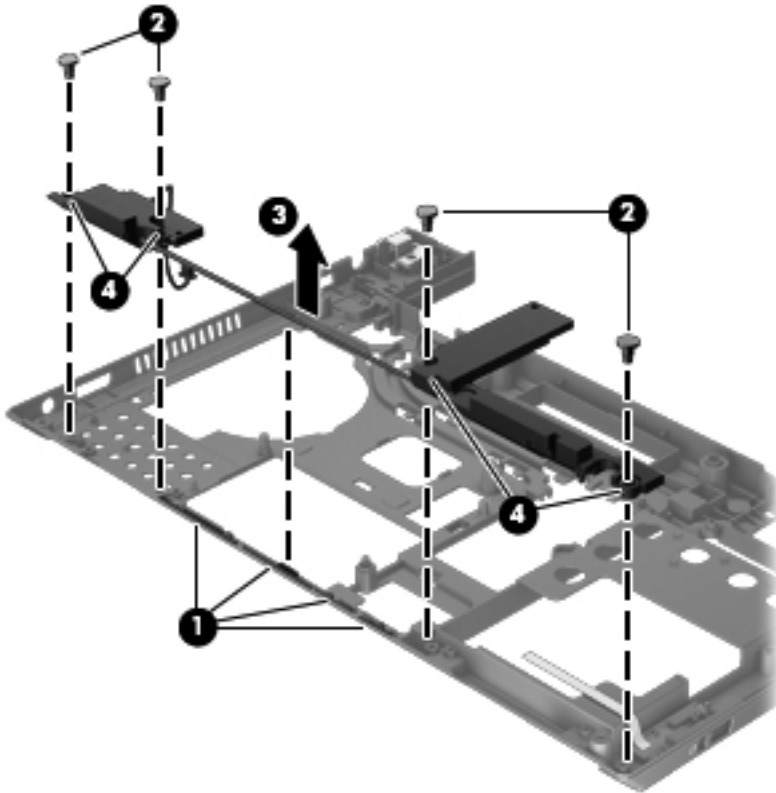

Reverse this procedure to install the speakers.

## Power switch board

Description	Spare part number
Power switch board (includes cable)	693352-001

Before removing the power switch board, follow these steps:

1. Turn off the computer. If you are unsure whether the computer is off or in Hibernation, turn the computer on, and then shut it down through the operating system.
2. Disconnect the power from the computer by unplugging the power cord from the computer.
3. Disconnect all external devices from the computer.
4. Remove the battery (see [Battery on page 56](#)), and then remove the following components:
  - a. Service cover (see [Service cover on page 58](#))
  - b. Hard drive (see [Hard drive on page 59](#))
  - c. WLAN module (see [WLAN module on page 62](#))
  - d. WWAN module (see [WWAN module on page 64](#))
  - e. Keyboard (see [Keyboard on page 69](#))
  - f. Base enclosure (see [Base enclosure on page 76](#))

Remove the power switch board:

1. Turn the base enclosure right side up, with the front toward you.
2. Remove the Phillips PM2.0×3.4 screw **(1)** that secures the power switch board to the base enclosure.

3. Remove the power switch board (2).

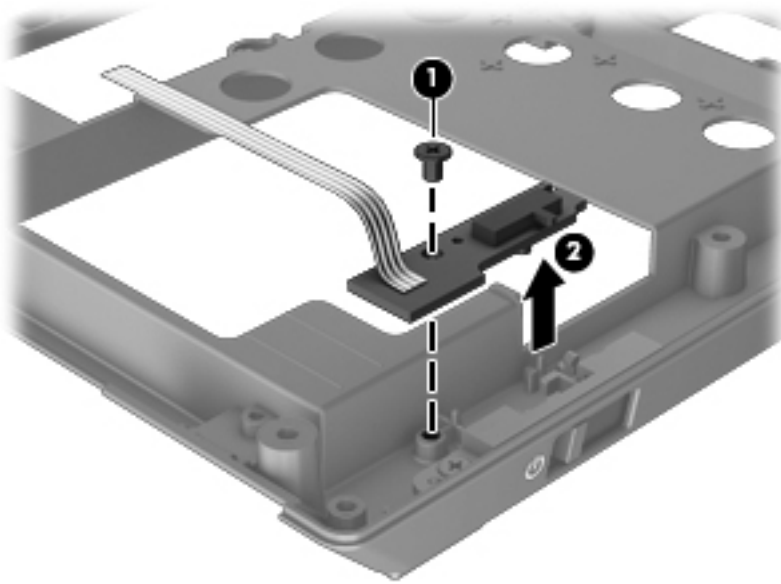

Reverse this procedure to install the power switch board.

## Media Card reader assembly

 **NOTE:** The Media Card reader assembly spare part kit does not include a Media Card reader assembly cable. The Media Card reader assembly cable is included in the Cable Kit, spare part number 693306-001.

Description	Spare part number
Media Card reader assembly	693353-001

Before removing the Media Card reader assembly, follow these steps:

1. Turn off the computer. If you are unsure whether the computer is off or in Hibernation, turn the computer on, and then shut it down through the operating system.
2. Disconnect the power from the computer by unplugging the power cord from the computer.
3. Disconnect all external devices from the computer.
4. Remove the battery (see [Battery on page 56](#)), and then remove the following components:
  - a. Service cover (see [Service cover on page 58](#))
  - b. Hard drive (see [Hard drive on page 59](#))
  - c. WLAN module (see [WLAN module on page 62](#))
  - d. WWAN module (see [WWAN module on page 64](#))

- e. Keyboard (see [Keyboard on page 69](#))
- f. Base enclosure (see [Base enclosure on page 76](#))

Remove the Media Card reader assembly:

1. Release the ZIF connector to which the fingerprint reader board cable is attached, and then disconnect the fingerprint reader board cable **(1)** from the Media Card reader assembly.
2. Remove the two Phillips PM2.0×3.4 screws **(1)** that secure the Media Card reader assembly to the top cover.

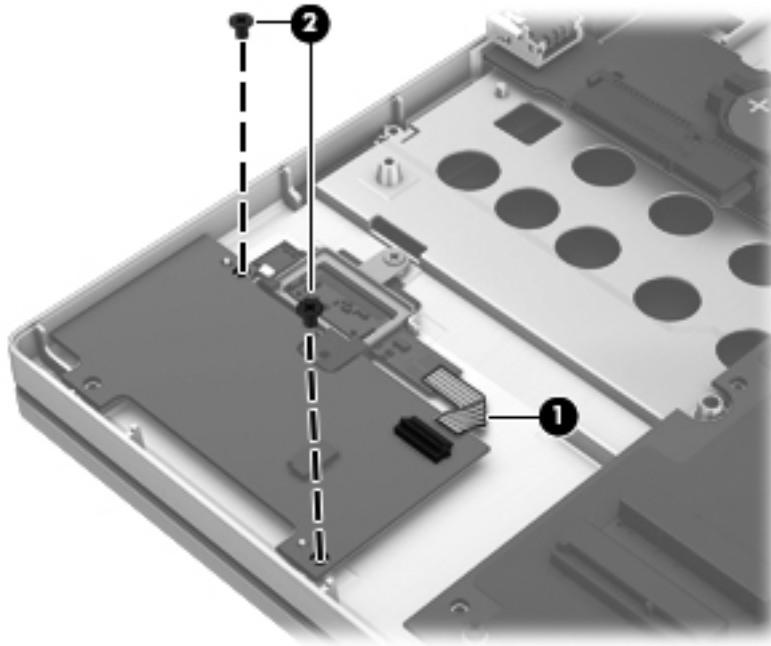

3. Lift the front edge of the Media Card reader assembly **(1)**, and then swing the assembly **(2)** up and to the left.

4. Release the ZIF connector to which the Media Card reader assembly cable is attached, and then disconnect the Media Card reader assembly cable **(3)** from the Media Card reader assembly.

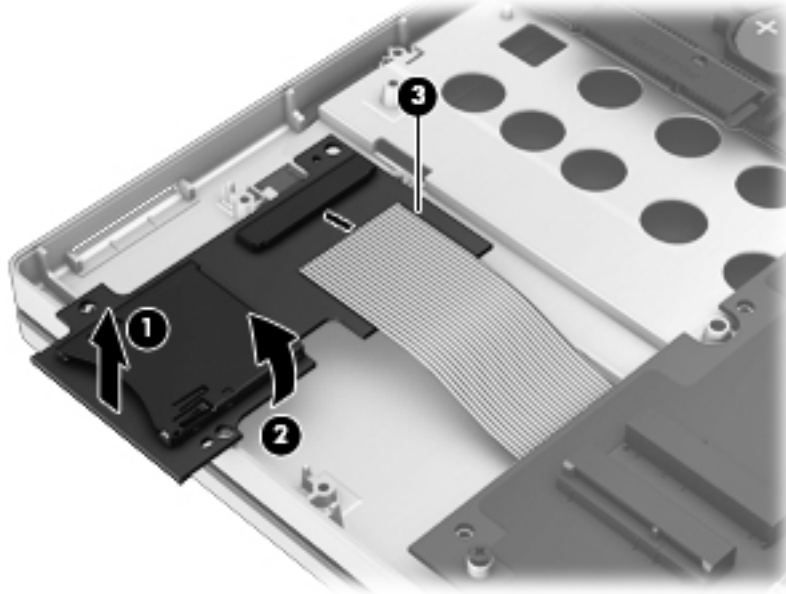

5. Remove the Media Card reader assembly.

Reverse this procedure to install the Media Card reader assembly.

## RTC battery

Description	Spare part number
RTC battery	651038-001

Before removing the RTC battery, follow these steps:

1. Turn off the computer. If you are unsure whether the computer is off or in Hibernation, turn the computer on, and then shut it down through the operating system.
2. Disconnect the power from the computer by unplugging the power cord from the computer.
3. Disconnect all external devices from the computer.
4. Remove the battery (see [Battery on page 56](#)), and then remove the following components:
  - a. Service cover (see [Service cover on page 58](#))
  - b. Hard drive (see [Hard drive on page 59](#))
  - c. WLAN module (see [WLAN module on page 62](#))
  - d. WWAN module (see [WWAN module on page 64](#))

- e. Keyboard (see [Keyboard on page 69](#))
- f. Base enclosure (see [Base enclosure on page 76](#))

Remove the RTC battery:

- ▲ Use a thin, non-conductive tool **(1)** to remove the RTC battery **(2)** from the socket on the system board.

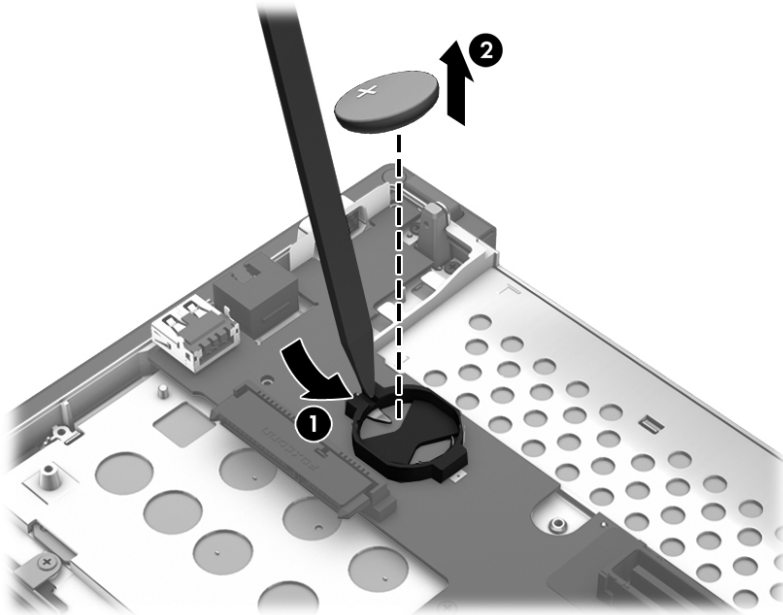

Reverse this procedure to install the RTC battery. When installing the RTC battery, make sure the “+” sign faces up.

## System board



**NOTE:** The system board spare part kit includes replacement thermal material.

Description	Spare part number
For use in all countries and regions except the People's Republic of China:	
Equipped with an Intel Quad Core i7-3687U 2.10-GHz processor (SC turbo up to 3.30-GHz, 1600-MHz FSB, 4.0-MB L3 cache, 17 W) and the Windows 8 Standard operating system	714520-501
Equipped with an Intel Quad Core i7-3687U 2.10-GHz processor (SC turbo up to 3.30-GHz, 1600-MHz FSB, 4.0-MB L3 cache, 17 W) and the Windows 8 Professional operating system	714520-601
Equipped with an Intel Quad Core i7-3687U 2.10-GHz processor (SC turbo up to 3.30-GHz, 1600-MHz FSB, 4.0-MB L3 cache, 17 W) and the Windows 7 operating system	714520-001
Equipped with an Intel Quad Core i7-3667U 1.80-GHz processor (SC turbo up to 2.90-GHz, 4.0-MB L3 cache, 17 W) and the Windows 8 Standard operating system	693360-501
Equipped with an Intel Quad Core i7-3667U 1.80-GHz processor (SC turbo up to 2.90-GHz, 4.0-MB L3 cache, 17 W) and the Windows 8 Professional operating system	693360-601
Equipped with an Intel Dual Core i7-3667U 1.80-GHz processor (SC turbo up to 2.90-GHz, 4.0-MB L3 cache, 17 W) and the Windows 7 operating system	693360-001
Equipped with an Intel Dual Core i5-3437U 1.90-GHz processor (SC turbo up to 2.90-GHz, 1600-MHz FSB, 3.0-MB L3 cache, 17 W) and the Windows 8 Standard operating system	714519-501
Equipped with an Intel Dual Core i5-3437U 1.90-GHz processor (SC turbo up to 2.90-GHz, 1600-MHz FSB, 3.0-MB L3 cache, 17 W) and the Windows 8 Professional operating system	714519-601
Equipped with an Intel Dual Core i5-3437U 1.90-GHz processor (SC turbo up to 2.90-GHz, 1600-MHz FSB, 3.0-MB L3 cache, 17 W) and the Windows 7 operating system	714519-001
Equipped with an Intel Dual Core i5-3427U 1.70-GHz processor (SC turbo up to 2.70-GHz, 3.0-MB L3 cache, 17 W) and the Windows 8 Standard operating system	693358-501
Equipped with an Intel Dual Core i5-3427U 1.70-GHz processor (SC turbo up to 2.70-GHz, 3.0-MB L3 cache, 17 W) and the Windows 8 Professional operating system	693358-601
Equipped with Intel Dual Core i5-3427U 1.70-GHz processor (SC turbo up to 2.70-GHz, 3.0-MB L3 cache, 17 W) and the Windows 7 operating system	693358-001
Equipped with an Intel Dual Core i5-3317U 1.70-GHz processor (SC turbo up to 2.60-GHz, 3.0-MB L3 cache, 17 W) and the Windows 8 Standard operating system	693357-501
Equipped with an Intel Dual Core i5-3317U 1.70-GHz processor (SC turbo up to 2.60-GHz, 3.0-MB L3 cache, 17 W) and the Windows 8 Professional operating system	693357-601
Equipped with Intel Dual Core i5-3317U 1.70-GHz processor (SC turbo up to 2.60-GHz, 3.0-MB L3 cache, 17 W) and the Windows 7 operating system	693357-001
Equipped with an Intel Dual Core i5-3217U 1.70-GHz processor (SC turbo up to 2.60-GHz, 3.0-MB L3 cache, 17 W) and the Windows 8 Standard operating system	693356-501
Equipped with an Intel Dual Core i5-3217U 1.70-GHz processor (SC turbo up to 2.60-GHz, 3.0-MB L3 cache, 17 W) and the Windows 8 Professional operating system	693356-601
Equipped with Intel Dual Core i3-3217U 1.80-GHz processor (3.0-MB L3 cache, 17 W) and the Windows 7 operating system	693356-001



Description	Spare part number
For use only in the People's Republic of China:	
Equipped with Intel Dual Core i7-3667U 1.80-GHz processor (SC turbo up to 2.90-GHz), 4.0-MB L3 cache, 17 W	694511-001
Equipped with Intel Dual Core i5-3427U 1.70-GHz processor (SC turbo up to 2.70-GHz), 3.0-MB L3 cache, 17 W	694510-001
Equipped with Intel Dual Core i5-3317U 1.70-GHz processor (SC turbo up to 2.60-GHz), 3.0-MB L3 cache, 17 W	694509-001
Equipped with Intel Dual Core i3-3217U 1.80-GHz processor, 3.0-MB L3 cache, 17 W	694508-001

Before removing the system board, follow these steps:

1. Turn off the computer. If you are unsure whether the computer is off or in Hibernation, turn the computer on, and then shut it down through the operating system.
2. Disconnect the power from the computer by unplugging the power cord from the computer.
3. Disconnect all external devices from the computer.
4. Remove the battery (see [Battery on page 56](#)), and then remove the following components:
  - a. Service cover (see [Service cover on page 58](#))
  - b. Hard drive (see [Hard drive on page 59](#))
  - c. WLAN module (see [WLAN module on page 62](#))
  - d. WWAN module (see [WWAN module on page 64](#))
  - e. Fan (see [Fan on page 68](#))
  - f. Keyboard (see [Keyboard on page 69](#))
  - g. Base enclosure (see [Base enclosure on page 76](#))

 **NOTE:** When replacing the system board, be sure that the following components are removed from the defective system board and installed on the replacement system board:

- SIM (see [SIM on page 57](#))
- Memory module (see [Memory module on page 66](#))
- RTC battery (see [RTC battery on page 86](#))
- Heat sink (see [Heat sink on page 91](#))

Remove the system board:

1. Remove the two Phillips PM2.0×3.4 screws **(1)** that secure the system board to the top cover.

2. Lift the rear edge of the system board **(2)** and swing it up and forward until it rests upside down in front of the computer.

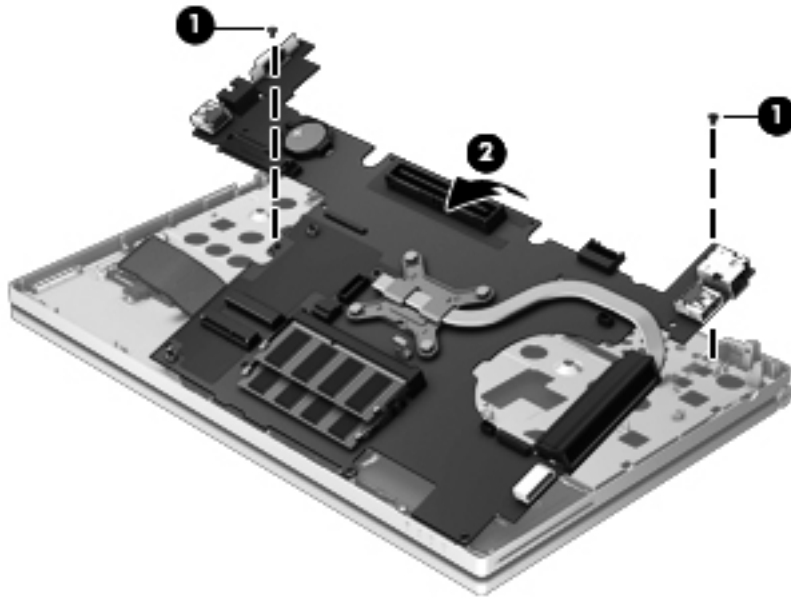

3. Release the ZIF connector to which the TouchPad cable is connected, and then disconnect the TouchPad cable **(1)** from the system board.
4. Release the ZIF connector to which the Smart Card reader board cable is connected, and then disconnect the Smart Card reader board cable **(2)** from the system board.

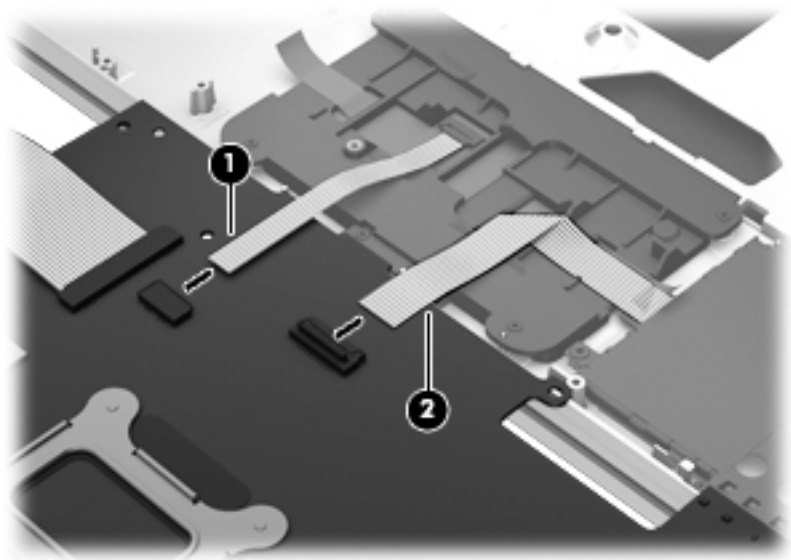

5. Remove the system board.

Reverse this procedure to install the system board.

# Heat sink

Description	Spare part number
Heat sink (includes replacement thermal material)	693307-001

Before removing the heat sink, follow these steps:

1. Turn off the computer. If you are unsure whether the computer is off or in Hibernation, turn the computer on, and then shut it down through the operating system.
2. Disconnect the power from the computer by unplugging the power cord from the computer.
3. Disconnect all external devices from the computer.
4. Remove the battery (see [Battery on page 56](#)), and then remove the following components:
  - a. Service cover (see [Service cover on page 58](#))
  - b. Hard drive (see [Hard drive on page 59](#))
  - c. WLAN module (see [WLAN module on page 62](#))
  - d. WWAN module (see [WWAN module on page 64](#))
  - e. Fan (see [Fan on page 68](#))
  - f. Keyboard (see [Keyboard on page 69](#))
  - g. Base enclosure (see [Base enclosure on page 76](#))
  - h. System board (see [System board on page 88](#))

Remove the heat sink:

1. Following the 1, 2, 3, 4 sequence stamped into the heat sink, loosen the four captive Phillips screws (**1**) that secure the heat sink to the system board.

**2.** Remove the heat sink **(2)**.

 **NOTE:** Due to the adhesive quality of the thermal material located between the heat sink and the system board components, it may be necessary to move the heat sink from side to side to detach it.

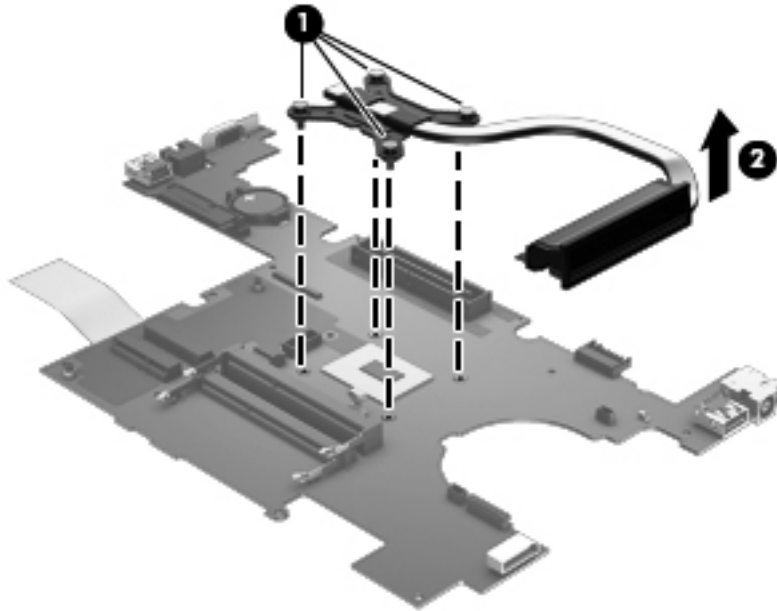

 **NOTE:** The thermal material must be thoroughly cleaned from the surfaces of the heat sink and the system board components each time the heat sink is removed. Replacement thermal material is included with the heat sink and system board spare part kits. Thermal paste is used on the processor **(1)** and the heat sink section **(2)** that services it.

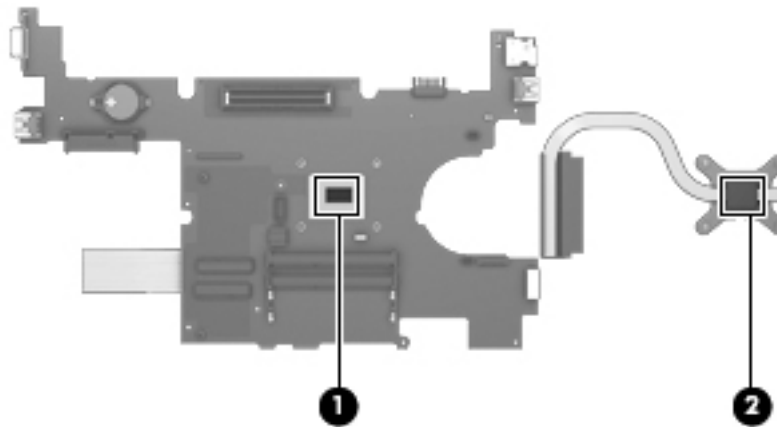

Reverse this procedure to install the heat sink.

## Smart Card reader assembly

Description	Spare part number
Smart Card reader assembly (includes cable)	693312-001

Before removing the Smart Card reader assembly, follow these steps:

1. Turn off the computer. If you are unsure whether the computer is off or in Hibernation, turn the computer on, and then shut it down through the operating system.
2. Disconnect the power from the computer by unplugging the power cord from the computer.
3. Disconnect all external devices from the computer.
4. Remove the battery (see [Battery on page 56](#)), and then remove the following components:
  - a. Service cover (see [Service cover on page 58](#))
  - b. Hard drive (see [Hard drive on page 59](#))
  - c. WLAN module (see [WLAN module on page 62](#))
  - d. WWAN module (see [WWAN module on page 64](#))
  - e. Fan (see [Fan on page 68](#))
  - f. Keyboard (see [Keyboard on page 69](#))
  - g. Base enclosure (see [Base enclosure on page 76](#))
  - h. System board (see [System board on page 88](#))

Remove the Smart Card reader assembly:

1. Remove the two Phillips PM2.0×3.4 screws **(1)** that secure the Smart Card reader assembly to the top cover.
2. Slide the Smart Card reader assembly **(2)** to the left to release it from the clips built into the top cover.

3. Remove the Smart Card reader assembly **(3)**.

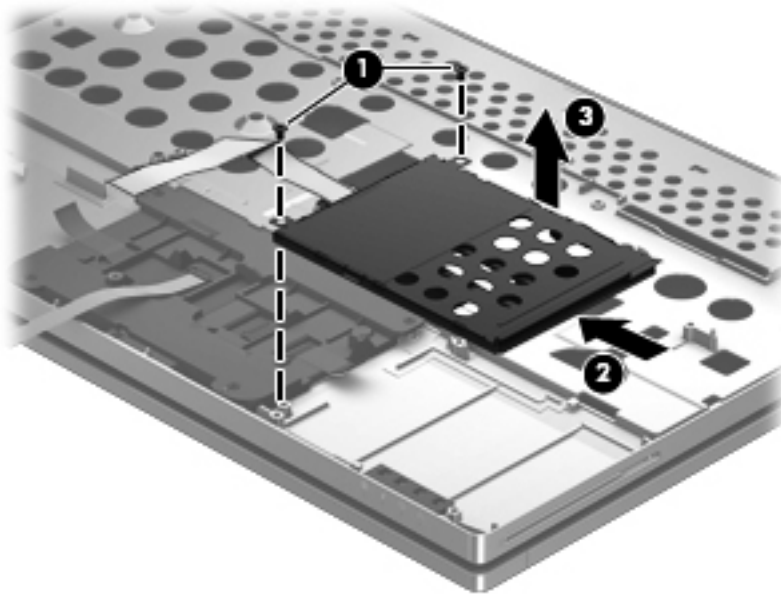

Reverse this procedure to install the Smart Card reader assembly.

## Top cover

 **NOTE:** The top cover spare part kit includes the TouchPad. The TouchPad cable is included in the Cable Kit, spare part number 693306-001.

Description	Spare part number
For use on computer models equipped with a fingerprint reader	693317-001
For use on computer models not equipped with a fingerprint reader	694507-001

 **NOTE:** The display assembly is spared at the subcomponent level only. For more display assembly spare part information, see the individual removal subsections.

Before removing the display assembly, follow these steps:

1. Turn off the computer. If you are unsure whether the computer is off or in Hibernation, turn the computer on, and then shut it down through the operating system.
2. Disconnect the power from the computer by unplugging the power cord from the computer.
3. Disconnect all external devices from the computer.
4. Remove the battery (see [Battery on page 56](#)), and then remove the following components:
  - a. Service cover (see [Service cover on page 58](#))
  - b. Hard drive (see [Hard drive on page 59](#))
  - c. WLAN module (see [WLAN module on page 62](#))

- d. WWAN module (see [WWAN module on page 64](#))
- e. Fan (see [Fan on page 68](#))
- f. Keyboard (see [Keyboard on page 69](#))
- g. Base enclosure (see [Base enclosure on page 76](#))
- h. System board (see [System board on page 88](#))

 **NOTE:** When replacing the top cover, be sure to remove the following components from the defective top cover and install them on the replacement top cover:

- Fingerprint reader board (see [Fingerprint reader board on page 61](#))
- Media Card reader assembly (see [Media Card reader assembly on page 84](#))
- Smart Card reader assembly (see [Smart Card reader assembly on page 93](#))

Remove the top cover:

1. Release the left-side wireless antenna cables **(1)** from the clips **(2)** and routing channel built into the top cover.
2. Release the display panel cable **(3)** and right-side wireless antenna cables from the clips **(4)** and routing channel built into the top cover.
3. Remove the two Phillips PM2.0x5.0 screws **(5)** that secure the top cover to the display assembly.

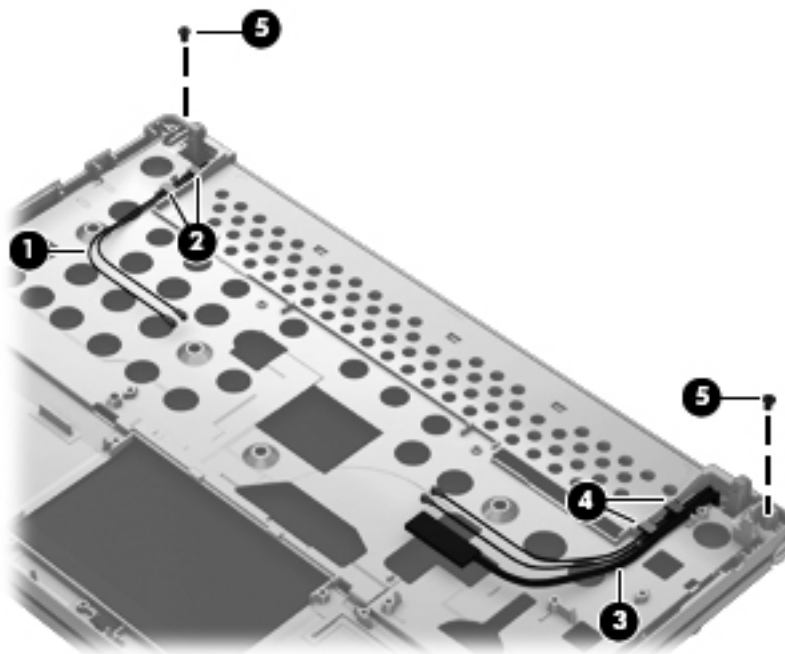

4. Disengage the top cover **(1)** from the display assembly, making sure to guide the left-side wireless antenna cables **(2)** through the top cover left-side opening **(3)** and the display panel cable **(4)** and the right-side wireless antenna cables through the top cover right-side opening **(5)**.

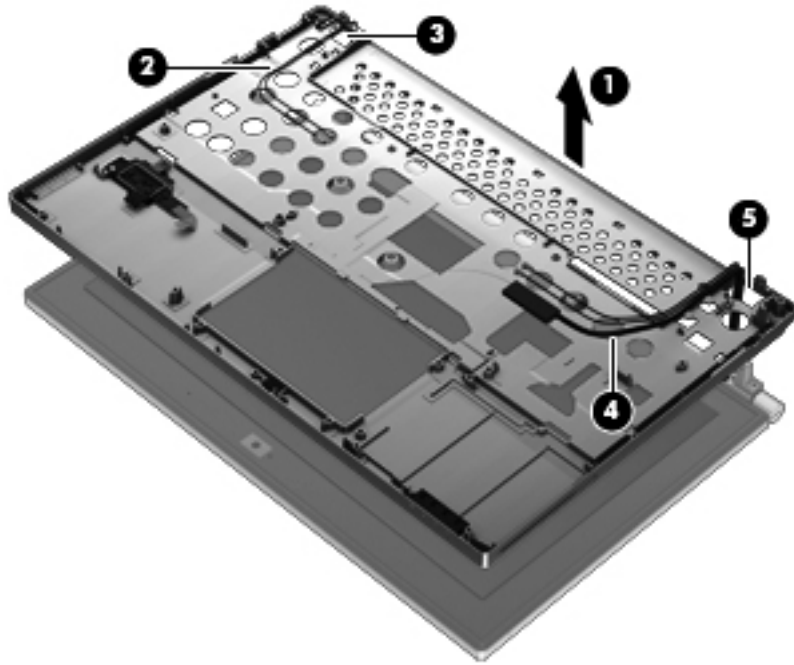

Reverse this procedure to install the top cover.



## Display assembly subcomponents

 **NOTE:** The display assembly is spared at the subcomponent level only. For more display assembly spare part information, see the individual removal subsections.

---

To access the display assembly subcomponents, follow these steps:

1. Turn off the computer. If you are unsure whether the computer is off or in Hibernation, turn the computer on, and then shut it down through the operating system.
2. Disconnect the power from the computer by unplugging the power cord from the computer.
3. Disconnect all external devices from the computer.
4. Remove the battery (see [Battery on page 56](#)), and then remove the following components:
  - a. Service cover (see [Service cover on page 58](#))
  - b. Hard drive (see [Hard drive on page 59](#))
  - c. Optical drive (see [Hard drive on page 59](#))
  - d. WLAN module (see [WLAN module on page 62](#))
  - e. WWAN module (see [WWAN module on page 64](#))
  - f. Fan (see [Fan on page 68](#))
  - g. Keyboard (see [Keyboard on page 69](#))
  - h. Base enclosure (see [Base enclosure on page 76](#))
  - i. System board (see [System board on page 88](#))
1. If it is necessary to replace the display bezel or any of the display assembly subcomponents:
  - a. Remove the display bezel screw covers **(1)**.

The display bezel screw covers are available in the Rubber Kit, spare part number 693355-001.
  - b. Remove the two Phillips PM2.0×4.2 screws **(2)** that secure the display bezel and the display clutch cover to the display assembly.

- c. Remove the display clutch cover **(3)**.

The display clutch cover is available using spare part number 693311-001.

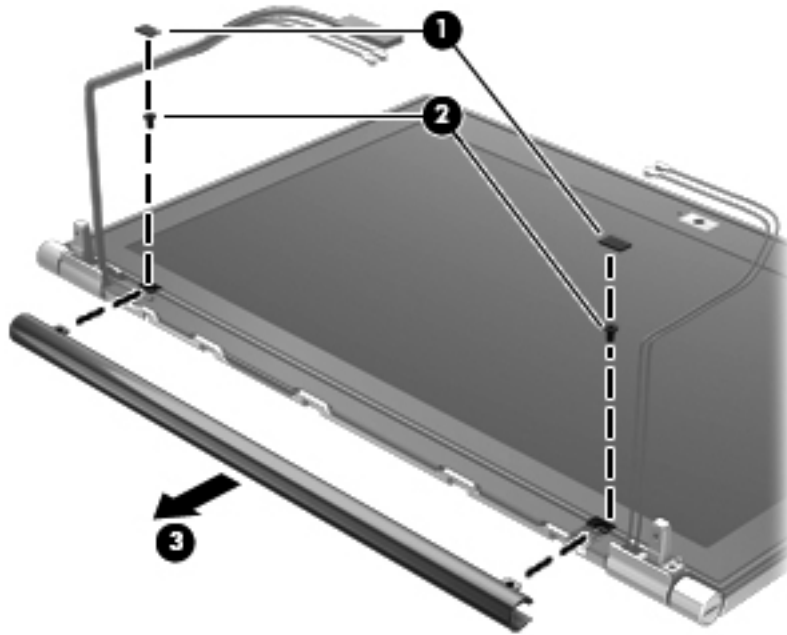

- d. Flex the inside edges of the bottom edge **(1)**, the left and right sides **(2)**, and the top edge **(3)** of the display bezel until the bezel disengages from the display enclosure.

- e. Remove the display bezel **(4)**.

The display bezel is available using spare part numbers 693302-001 (for use on computer models equipped with a webcam) and 693303-001 (for use on computer models not equipped with a webcam).

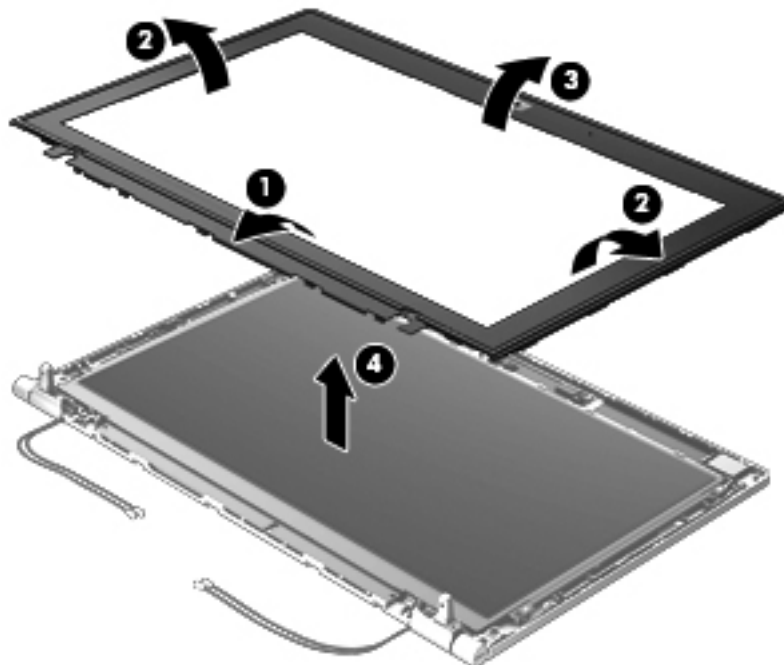

2. If it is necessary to replace the display hinges, display hinge covers, and/or display hinge caps:
  - a. Remove the two Phillips PM2.0×4.2 screws **(1)** that secure the display hinge to the display enclosure.
  - b. Remove the display hinge **(2)** from the display enclosure.
  - c. Remove the display hinge cap **(3)** from the display hinge.
  - d. Remove the Phillips PM2.0×4.2 screw **(4)** that secures the display hinge cover to the display hinge.
  - e. Remove the display hinge cover **(5)** from the display hinge.

The display hinges, display hinge caps, and display hinge covers are included in the Display Hinge Cover Kit, spare part number 693310-001.

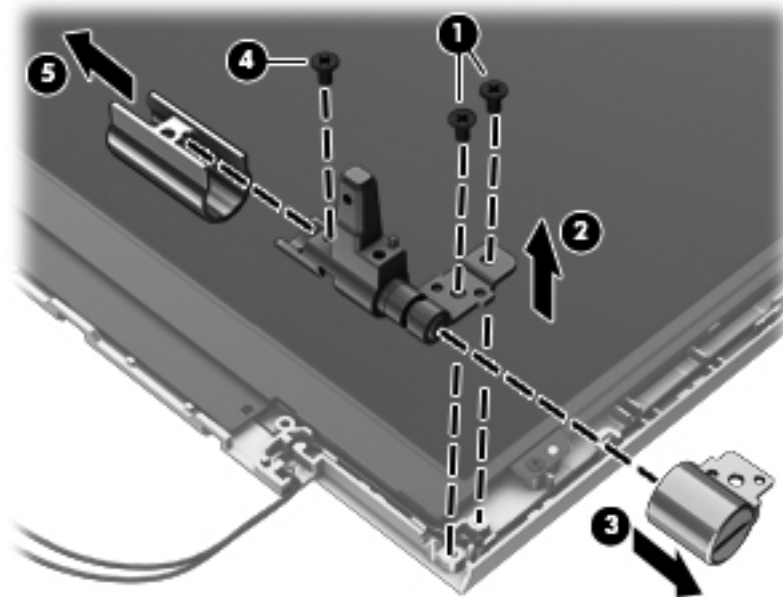

3. If it is necessary to replace the display panel:
  - a. Remove the four Phillips PM2.0×4.2 screws **(1)** that secure the display panel to the display enclosure.

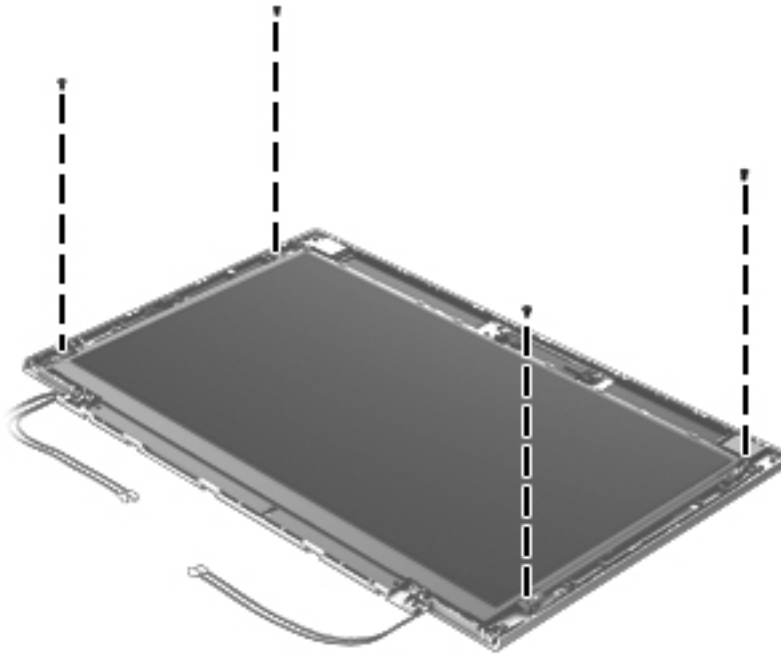

- b. Release the display panel cable **(1)** from the clips **(2)** and routing channel built into the bottom edge of the display enclosure.

---

**⚠ CAUTION:** Before turning the display panel upside down, make sure the work surface is clear of tools, screws, and any other foreign objects. Failure to follow this caution can result in damage to the display panel.

---

- c. Lift the top edge of the display panel **(3)** and swing it up and forward until it rests upside down in front of the display enclosure.
  - d. Release the adhesive support strip **(4)** that secures the display panel cable to the display panel.
  - e. Release the support bar **(5)** that secures the display panel cable to the display panel.

- f. Disconnect the display panel cable **(6)** from the display panel.

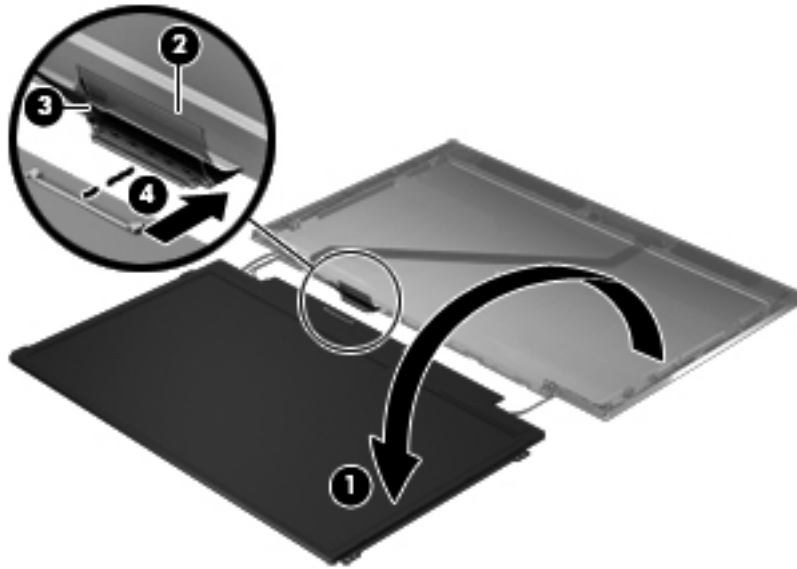

- g. Remove the display panel.

The display panel is available using spare part number 693361-001.

4. If it is necessary to replace the display panel cable:

- a. Disconnect the display panel cable **(1)** from the webcam/microphone module.
- b. Remove the display panel cable **(2)**.

The display panel cable is included in the Display Cable Kit, spare part number 693305-001.

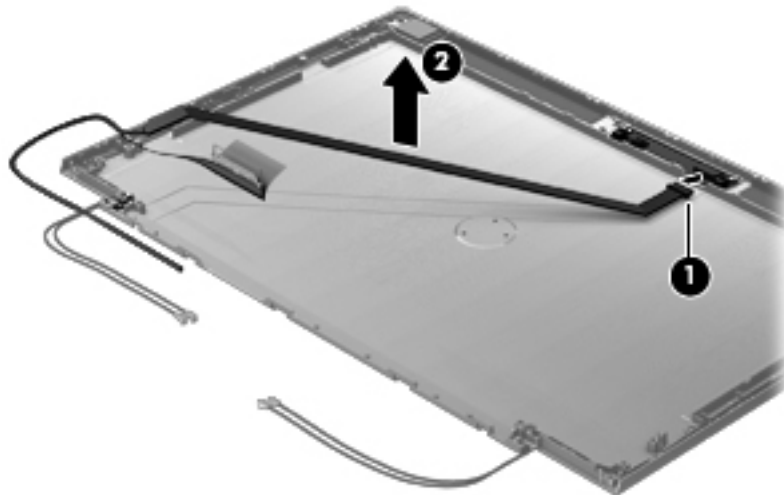

5. If it is necessary to replace the webcam/microphone module:

**⚠ CAUTION:** Handle the webcam/microphone module with caution. The module has a thin profile and is susceptible to damage when not handled carefully.

- a. Detach the webcam/microphone module **(1)** from the display enclosure. (The webcam/microphone module is attached to the display enclosure with double-sided tape.)
- b. Detach the webcam/microphone module cable **(2)** from the display enclosure. (The webcam/microphone module cable is attached to the display enclosure with double-sided tape.)
- c. Disconnect the webcam/microphone module cable **(3)** from the webcam/microphone module.
- d. Remove the webcam/microphone module **(4)**.

The webcam/microphone module is available using spare part number 693318-001. The microphone module is available using spare part number 693313-001.

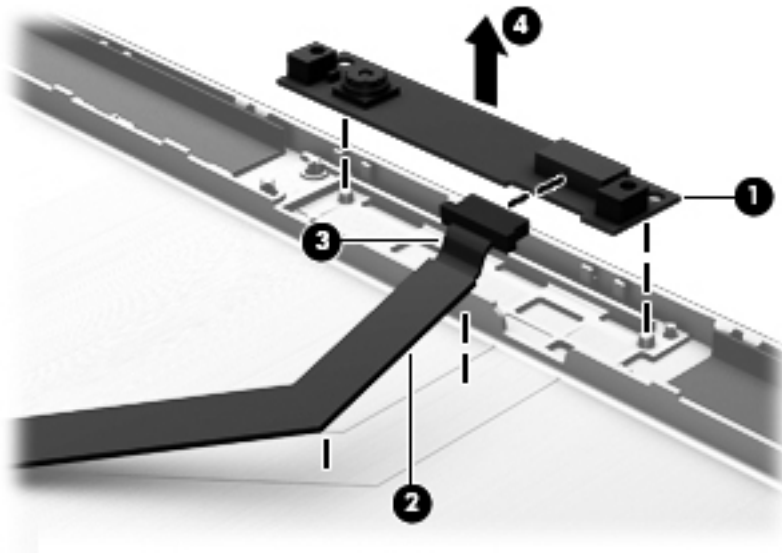

6. If it is necessary to replace the WLAN antenna cables and transceivers:

- a. Detach the WLAN antenna transceivers **(1)** from the display enclosure. (The WLAN antenna transceivers are attached to the display enclosure with double-sided tape.)
- b. Release the WLAN antenna cables from the clips **(2)** and routing channel built into the display enclosure.

- c. Remove the WLAN antenna cables and transceivers **(3)**. The WLAN antenna cables and transceivers are included in the Antenna Kit, spare part number 693299-001.

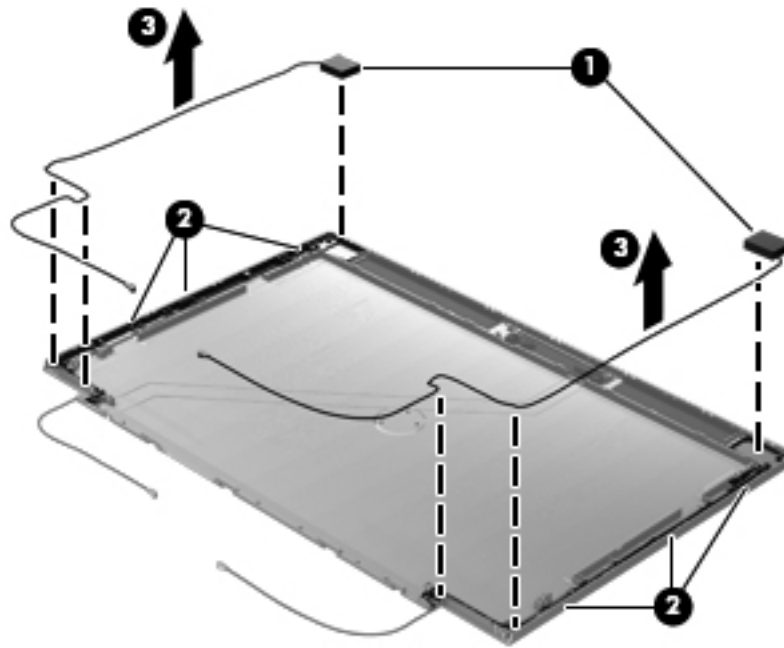

- 7. If it is necessary to replace the WWAN antenna cables and transceivers:
  - a. Detach the WWAN antenna transceivers **(1)** from the display enclosure. (The WWAN antenna transceivers are attached to the display enclosure with double-sided tape.)
  - b. Release the WWAN antenna cables from the clips **(2)** and routing channel built into the display enclosure.

- c. Remove the WWAN antenna cables and transceivers **(3)**. The WWAN antenna cables and transceivers are included in the Antenna Kit, spare part number 693299-001.

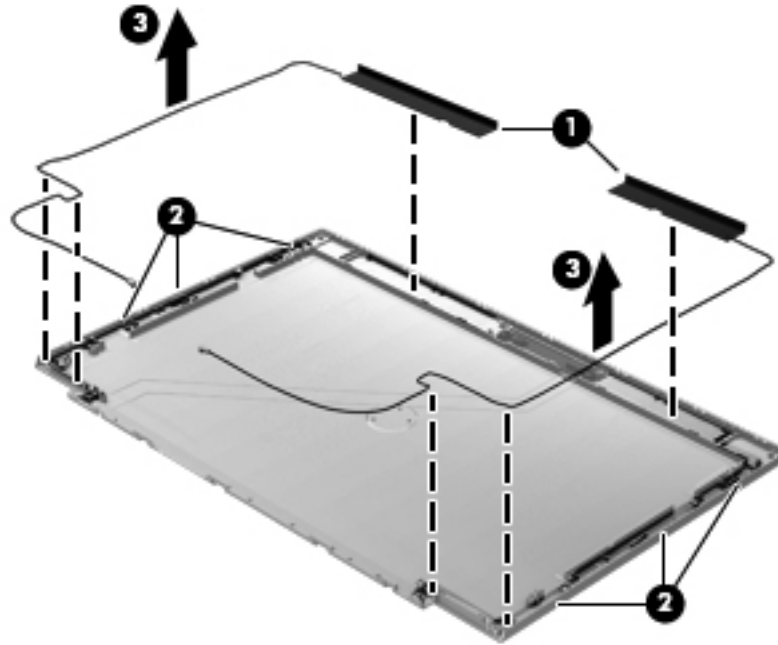

Reverse this procedure to reassemble and install the display assembly.



---

# 5 Computer Setup (BIOS) and Advanced System Diagnostics

## Windows 8

### Using Computer Setup

Computer Setup, or Basic Input/Output System (BIOS), controls communication between all the input and output devices on the system (such as disk drives, display, keyboard, mouse, and printer). Computer Setup includes settings for the types of devices installed, the startup sequence of the computer, and the amount of system and extended memory.

---

 **NOTE:** Use extreme care when making changes in Computer Setup. Errors can prevent the computer from operating properly.

---

### Starting Computer Setup

---

 **NOTE:** An external keyboard or mouse connected to a USB port can be used with Computer Setup only if USB legacy support is enabled.

---

To start Computer Setup, follow these steps:

1. Turn on or restart the computer, and then press **esc** while the “Press the ESC key for Startup Menu” message is displayed at the bottom of the screen.
2. Press **f10** to enter Computer Setup.

## Navigating and selecting in Computer Setup

To navigate and select in Computer Setup, follow these steps:

1. Turn on or restart the computer, and then press **esc** while the “Press the ESC key for Startup Menu” message is displayed at the bottom of the screen.
  - To select a menu or a menu item, use the **tab** key and the keyboard arrow keys and then press **enter**, or use a pointing device to click the item.
  - To scroll up and down, click the up arrow or the down arrow in the upper-right corner of the screen, or use the up arrow key or the down arrow key.
  - To close open dialog boxes and return to the main Computer Setup screen, press **esc**, and then follow the on-screen instructions.



---

**NOTE:** You can use either a pointing device (TouchPad, pointing stick, or USB mouse) or the keyboard to navigate and make selections in Computer Setup.

---

2. Press **f10** to enter Computer Setup.

To exit Computer Setup menus, choose one of the following methods:

- To exit Computer Setup menus without saving your changes:

Click the **Exit** icon in the lower-left corner of the screen, and then follow the on-screen instructions.

– or –

Use the **tab** key and the arrow keys to select **File > Ignore Changes and Exit**, and then press **enter**.

- To save your changes and exit Computer Setup menus:

Click the **Save** icon in the lower-left corner of the screen, and then follow the on-screen instructions.

– or –

Use the **tab** key and the arrow keys to select **File > Save Changes and Exit**, and then press **enter**.

Your changes go into effect when the computer restarts.

## Restoring factory settings in Computer Setup

---

 **NOTE:** Restoring defaults will not change the hard drive mode.

---

To return all settings in Computer Setup to the values that were set at the factory, follow these steps:

1. Turn on or restart the computer, and then press **esc** while the “Press the ESC key for Startup Menu” message is displayed at the bottom of the screen.
2. Press **f10** to enter Computer Setup.
3. Use a pointing device or the arrow keys to select **File > Restore Defaults**.
4. Follow the on-screen instructions.
5. To save your changes and exit, click the **Save** icon in the lower-left corner of the screen, and then follow the on-screen instructions.

– or –

Use the arrow keys to select **File > Save Changes and Exit**, and then press **enter**.

Your changes go into effect when the computer restarts.

---

 **NOTE:** Your password settings and security settings are not changed when you restore the factory settings.

---

## Updating the BIOS

Updated versions of the BIOS may be available on the HP website.

Most BIOS updates on the HP website are packaged in compressed files called *SoftPaqs*.

Some download packages contain a file named *Readme.txt*, which contains information regarding installing and troubleshooting the file.

## Determining the BIOS version

To determine whether available BIOS updates contain later BIOS versions than those currently installed on the computer, you need to know the version of the system BIOS currently installed.

BIOS version information (also known as *ROM date* and *System BIOS*) can be displayed by pressing **fn + esc** (if you are already in Windows) or by using Computer Setup.

1. Start Computer Setup.
2. Use a pointing device or the arrow keys to select **File > System Information**.
3. To exit Computer Setup without saving your changes, click the Exit icon in the lower-left corner of the screen, and then follow the on-screen instructions.

– or –

Use the **tab** key and the arrow keys to select **File > Ignore Changes and Exit**, and then press **enter**.

## Downloading a BIOS update

 **CAUTION:** To reduce the risk of damage to the computer or an unsuccessful installation, download and install a BIOS update only when the computer is connected to reliable external power using the AC adapter. Do not download or install a BIOS update while the computer is running on battery power, docked in an optional docking device, or connected to an optional power source. During the download and installation, follow these instructions:

Do not disconnect power on the computer by unplugging the power cord from the AC outlet.

Do not shut down the computer or initiate Sleep.

Do not insert, remove, connect, or disconnect any device, cable, or cord.

1. From the Start screen, type `h`, and then select **Help and Support**.
2. In the **Help and Support** search box, type `maintain`, and then follow the on-screen instructions to identify your computer and access the BIOS update you want to download.
3. At the download area, follow these steps:
  - a. Identify the BIOS update that is later than the BIOS version currently installed on your computer. Make a note of the date, name, or other identifier. You may need this information to locate the update later, after it has been downloaded to your hard drive.
  - b. Follow the on-screen instructions to download your selection to the hard drive.

Make a note of the path to the location on your hard drive where the BIOS update is downloaded. You will need to access this path when you are ready to install the update.

 **NOTE:** If you connect your computer to a network, consult the network administrator before installing any software updates, especially system BIOS updates.

BIOS installation procedures vary. Follow any instructions that are displayed on the screen after the download is complete. If no instructions are displayed, follow these steps:

1. From the Start screen, type `e`, and then click **File Explorer**.
2. Double-click your hard drive designation. The hard drive designation is typically Local Disk (C:).
3. Using the hard drive path you recorded earlier, open the folder on your hard drive that contains the update.
4. Double-click the file that has an `.exe` extension (for example, `filename.exe`).

The BIOS installation begins.

5. Complete the installation by following the on-screen instructions.

 **NOTE:** After a message on the screen reports a successful installation, you can delete the downloaded file from your hard drive.

## Using Advanced System Diagnostics

Advanced System Diagnostics allows you to run diagnostic tests to determine if the computer hardware is functioning properly. The following diagnostic tests are available in Advanced System Diagnostics:

- **System Tune-Up**—This group of additional tests checks your computer to make sure that the main components are functioning correctly. System Tune-Up runs longer and more comprehensive tests on memory modules, hard drive SMART attributes, the hard drive surface, the battery (and battery calibration), video memory, and the WLAN module status.
- **Start-up test**—This test analyzes the main computer components that are required to start the computer.
- **Run-in test**—This test repeats the start-up test and checks for intermittent problems that the start-up test does not detect.
- **Hard disk test**—This test analyzes the physical condition of the hard drive, and then checks all data in every sector of the hard drive. If the test detects a damaged sector, it attempts to move the data to a good sector.
- **Memory test**—This test analyzes the physical condition of the memory modules. If it reports an error, replace the memory modules immediately.
- **Battery test**—This test analyzes the condition of the battery and calibrates the battery if necessary. If the battery fails the test, contact HP support to report the issue and purchase a replacement battery.
- **BIOS Management**—You can update or rollback the version of the BIOS on the system. Do not shut down or remove external power during the process. You will be given a confirmation screen before your BIOS is modified. Select **BIOS update**, **BIOS Rollback**, or **Back to main menu**.

You can view system information and error logs or select languages in the Advanced System Diagnostics window.

To start Advanced System Diagnostics:

1. Turn on or restart the computer. While the “Press the ESC key for Startup Menu” message is displayed in the lower-left corner of the screen, press **esc**. When the Startup Menu is displayed, press **f2**.
2. Click the diagnostic test you want to run, and then follow the on-screen instructions.



---

**NOTE:** NOTE: you need to stop a diagnostics test while it is running, press **esc**.

---

# Windows 7

Computer Setup, or Basic Input/Output System (BIOS), controls communication between all the input and output devices on the system (such as disk drives, display, keyboard, mouse, and printer). Computer Setup includes settings for the types of peripherals installed, the startup sequence of the computer, and the amount of system and extended memory.

---

 **NOTE:** Use extreme care when making changes in Computer Setup. Errors can prevent the computer from operating properly.

---

## Starting Computer Setup

---

 **NOTE:** An external keyboard or mouse connected to a USB port can be used with Computer Setup only if USB legacy support is enabled.

---

To start Computer Setup, follow these steps:

1. Turn on or restart the computer, and then press **esc** while the “Press the ESC key for Startup Menu” message is displayed at the bottom of the screen.
2. Press **f10** to enter Computer Setup.

## Using Computer Setup

### Navigating and selecting in Computer Setup

To navigate and select in Computer Setup, follow these steps:

1. Turn on or restart the computer, and then press **esc** while the “Press the ESC key for Startup Menu” message is displayed at the bottom of the screen.
  - To select a menu or a menu item, use the **tab** key and the keyboard arrow keys and then press **enter**, or use a pointing device to click the item.
  - To scroll up and down, click the up arrow or the down arrow in the upper-right corner of the screen, or use the up arrow key or the down arrow key.
  - To close open dialog boxes and return to the main Computer Setup screen, press **esc**, and then follow the on-screen instructions.

---

 **NOTE:** You can use either a pointing device (TouchPad, pointing stick, or USB mouse) or the keyboard to navigate and make selections in Computer Setup.

---

2. Press **f10** to enter Computer Setup.

To exit Computer Setup menus, choose one of the following methods:

- To exit Computer Setup menus without saving your changes, click the **Exit** icon in the lower-left corner of the screen, and then follow the on-screen instructions.  
  
– or –  
  
Use the **tab** key and the arrow keys to select **File > Ignore Changes and Exit**, and then press **enter**.
- or –
- To save your changes and exit Computer Setup menus, click the **Save** icon in the lower-left corner of the screen, and then follow the on-screen instructions.  
  
– or –  
  
Use the **tab** key and the arrow keys to select **File > Save Changes and Exit**, and then press **enter**.

Your changes go into effect when the computer restarts.

## Restoring factory settings in Computer Setup

---

 **NOTE:** Restoring defaults will not change the hard drive mode.

---

To return all settings in Computer Setup to the values that were set at the factory, follow these steps:

1. Turn on or restart the computer, and then press **esc** while the “Press the ESC key for Startup Menu” message is displayed at the bottom of the screen.
2. Press **f10** to enter Computer Setup.
3. Use a pointing device or the arrow keys to select **File > Restore Defaults**.
4. Follow the on-screen instructions.
5. To save your changes and exit, click the **Save** icon in the lower-left corner of the screen, and then follow the on-screen instructions.

– or –

Use the arrow keys to select **File > Save Changes and Exit**, and then press **enter**.

Your changes go into effect when the computer restarts.

---

 **NOTE:** Your password settings and security settings are not changed when you restore the factory settings.

---

## Updating the BIOS

Updated versions of the BIOS may be available on the HP Web site.

Most BIOS updates on the HP Web site are packaged in compressed files called SoftPaqs.

Some download packages contain a file named Readme.txt, which contains information regarding installing and troubleshooting the file.

## Determining the BIOS version

To determine whether available BIOS updates contain later BIOS versions than those currently installed on the computer, you need to know the version of the system BIOS currently installed.

BIOS version information (also known as *ROM date* and *System BIOS*) can be displayed as follows:

1. Start Computer Setup.
2. Use a pointing device or the arrow keys to select **File > System Information**.
3. To exit Computer Setup without saving your changes, click the **Exit** icon in the lower-left corner of the screen, and then follow the on-screen instructions.

– or –

Use the **tab** key and the arrow keys to select **File > Ignore Changes and Exit**, and then press **enter**.

---

 **NOTE:** You can also determine the BIOS version by turning on or restarting the computer, pressing the **esc** key while the “Press the ESC key for Startup Menu” message is displayed at the bottom of the screen, and then pressing the **f1** key. Follow the on-screen instructions to exit this screen.

---

## Downloading a BIOS update

 **CAUTION:** CAUTION: To reduce the risk of damage to the computer or an unsuccessful installation, download and install a BIOS update only when the computer is connected to reliable external power using the AC adapter. Do not download or install a BIOS update while the computer is running on battery power, docked in an optional docking device, or connected to an optional power source. During the download and installation, follow these instructions:

Do not disconnect power from the computer by unplugging the power cord from the AC outlet.

Do not shut down the computer or initiate Suspend or Hibernation.

Do not insert, remove, connect, or disconnect any device, cable, or cord.

1. Open your Web browser. For U.S. support, go to <http://www.hp.com/go/contactHP>. For worldwide support, go to [http://welcome.hp.com/country/us/en/wwcontact\\_us.html](http://welcome.hp.com/country/us/en/wwcontact_us.html).
2. Follow the on-screen instructions to identify your computer and access the BIOS update you want to download.



3. Click the option for software and driver downloads, type your computer model number in the product box, and then press **enter**. Follow the on-screen instructions to identify your computer and access the BIOS update you want to download.
4. Click your specific product from the models listed.
5. Click the appropriate operating system.
6. Go to the BIOS section and download the BIOS software package.
7. Follow the installation instructions as provided with the downloaded BIOS software package.

---

 **NOTE:** After a message on the screen reports a successful installation, you can delete the downloaded file from your hard drive.

---

## Using Advanced System Diagnostics

Advanced System Diagnostics allows you to run diagnostic tests to determine if the computer hardware is functioning properly. The following diagnostic tests are available in Advanced System Diagnostics:

- **Start-up test**—This test analyzes the main computer components that are required to start the computer.
- **Run-in test**—This test repeats the start-up test and checks for intermittent problems that the start-up test does not detect.
- **Hard disk test**—This test analyzes the physical condition of the hard drive, and then checks all data in every sector of the hard drive. If the test detects a damaged sector, it attempts to move the data to a good sector.
- **Memory test**—This test analyzes the physical condition of the memory modules. If it reports an error, replace the memory modules immediately.
- **Battery test**—This test analyzes the condition of the battery and calibrates the battery if necessary. If the battery fails the test, contact support to report the issue and purchase a replacement battery.
- **System Tune-Up**—This group of additional tests checks your computer to make sure that the main components are functioning correctly. System Tune-Up runs longer and more comprehensive tests on memory modules, hard drive SMART attributes, the hard drive surface, the battery (and battery calibration), video memory, and the WLAN module status.

You can view system information and error logs in the Advanced System Diagnostics window.

To start Advanced System Diagnostics:

1. Turn on or restart the computer. While the “Press the ESC key for Startup Menu” message is displayed in the lower-left corner of the screen, press **esc**. When the Startup Menu is displayed, press **f2**.
2. Click the diagnostic test you want to run, and then follow the on-screen instructions.

---

 **NOTE:** If you need to stop a diagnostics test while it is running, press **esc**.

---

# SuSE Linux (SLED)

Computer Setup, or Basic Input/Output System (BIOS), controls communication between all the input and output devices on the system (such as disk drives, display, keyboard, mouse, and printer). Computer Setup includes settings for the types of peripherals installed, the startup sequence of the computer, and the amount of system and extended memory.

---

 **NOTE:** Use extreme care when making changes in Computer Setup. Errors can prevent the computer from operating properly.

---

## Starting Computer Setup

---

 **NOTE:** An external keyboard or mouse connected to a USB port can be used with Computer Setup only if USB legacy support is enabled.

---

To start Computer Setup, follow these steps:

1. Turn on or restart the computer, and then press `esc` while the “Press the ESC key for Startup Menu” message is displayed at the bottom of the screen.
2. Press `f10` to enter Computer Setup.

## Using Computer Setup

### Navigating and selecting in Computer Setup

To navigate and select in Computer Setup, follow these steps:

1. Turn on or restart the computer, and then press `esc` while the “Press the ESC key for Startup Menu” message is displayed at the bottom of the screen.
  - To select a menu or a menu item, use the `tab` key and the keyboard arrow keys and then press `enter`, or use a pointing device to click the item.
  - To scroll up and down, click the up arrow or the down arrow in the upper-right corner of the screen, or use the up arrow key or the down arrow key.
  - To close open dialog boxes and return to the main Computer Setup screen, press `esc`, and then follow the on-screen instructions.

---

 **NOTE:** You can use either a pointing device (TouchPad, pointing stick, or USB mouse) or the keyboard to navigate and make selections in Computer Setup.

---

2. Press `f10` to enter Computer Setup.

To exit Computer Setup menus, choose one of the following methods:

- To exit Computer Setup menus without saving your changes, click the **Exit** icon in the lower-left corner of the screen, and then follow the on-screen instructions.

– or –

Use the [tab](#) key and the arrow keys to select **File > Ignore Changes and Exit**, and then press [enter](#).

– or –

- To save your changes and exit Computer Setup menus, click the **Save** icon in the lower-left corner of the screen, and then follow the on-screen instructions.

– or –

Use the [tab](#) key and the arrow keys to select **File > Ignore Changes and Exit**, and then press [enter](#).

Your changes go into effect when the computer restarts.

## Restoring factory settings in Computer Setup

---

 **NOTE:** Restoring defaults will not change the hard drive mode.

---

To return all settings in Computer Setup to the values that were set at the factory, follow these steps:

1. Turn on or restart the computer, and then press [esc](#) while the “Press the ESC key for Startup Menu” message is displayed at the bottom of the screen.
2. Press [f10](#) to enter Computer Setup.
3. Use a pointing device or the arrow keys to select **File > Restore Defaults**.
4. Follow the on-screen instructions.
5. To save your changes and exit, click the **Save** icon in the lower-left corner of the screen, and then follow the on-screen instructions.

– or –

Use the arrow keys to select **File > Save Changes and Exit**, and then press [enter](#).

Your changes go into effect when the computer restarts.

---

 **NOTE:** Your password settings and security settings are not changed when you restore the factory settings.

---

## Updating the BIOS

Updated versions of the BIOS may be available on the HP Web site.

Most BIOS updates on the HP Web site are packaged in compressed files called SoftPaqs.

Some download packages contain a file named Readme.txt, which contains information regarding installing and troubleshooting the file.

## Determining the BIOS version

To determine whether available BIOS updates contain later BIOS versions than those currently installed on the computer, you need to know the version of the system BIOS currently installed.

BIOS version information (also known as *ROM date* and *System BIOS*) can be displayed as follows:

1. Start Computer Setup.
2. Use a pointing device or the arrow keys to select **File > System Information**.
3. To exit Computer Setup without saving your changes, click the **Exit** icon in the lower-left corner of the screen, and then follow the on-screen instructions.

– or –

Use the **tab** key and the arrow keys to select **File > Ignore Changes and Exit**, and then press **enter**.



**NOTE:** You can also determine the BIOS version by turning on or restarting the computer, pressing the **esc** key while the “Press the ESC key for Startup Menu” message is displayed at the bottom of the screen, and then pressing the **f1** key. Follow the on-screen instructions to exit this screen.

## Downloading a BIOS update

**CAUTION:** CAUTION: To reduce the risk of damage to the computer or an unsuccessful installation, download and install a BIOS update only when the computer is connected to reliable external power using the AC adapter. Do not download or install a BIOS update while the computer is running on battery power, docked in an optional docking device, or connected to an optional power source. During the download and installation, follow these instructions:

Do not disconnect power from the computer by unplugging the power cord from the AC outlet.

Do not shut down the computer or initiate Suspend or Hibernation.

Do not insert, remove, connect, or disconnect any device, cable, or cord.

1. Open your web browser. For U.S. support, go to <http://www.hp.com/go/contactHP>. For worldwide support, go to [http://welcome.hp.com/country/us/en/wwcontact\\_us.html](http://welcome.hp.com/country/us/en/wwcontact_us.html).
2. Follow the on-screen instructions to identify your computer and access the BIOS update you want to download.
3. Click the option for software and driver downloads, type your computer model number in the product box, and then press **enter**. Follow the on-screen instructions to identify your computer and access the BIOS update you want to download.
4. Click your specific product from the models listed.
5. Click the appropriate operating system.
6. Go to the BIOS section and download the BIOS software package.
7. Follow the installation instructions as provided with the downloaded BIOS software package.

## Using Advanced System Diagnostics

Advanced System Diagnostics allows you to run diagnostic tests to determine if the computer hardware is functioning properly. The following diagnostic tests are available in Advanced System Diagnostics:

- **Start-up test**—This test analyzes the main computer components that are required to start the computer.
- **Run-in test**—This test repeats the start-up test and checks for intermittent problems that the start-up test does not detect.
- **Hard disk test**—This test analyzes the physical condition of the hard drive, and then checks all data in every sector of the hard drive. If the test detects a damaged sector, it attempts to move the data to a good sector.
- **Memory test**—This test analyzes the physical condition of the memory modules. If it reports an error, replace the memory modules immediately.
- **Battery test**—This test analyzes the condition of the battery and calibrates the battery if necessary. If the battery fails the test, contact support to report the issue and purchase a replacement battery.
- **System Tune-Up**—This group of additional tests checks your computer to make sure that the main components are functioning correctly. System Tune-Up runs longer and more comprehensive tests on memory modules, hard drive SMART attributes, the hard drive surface, the battery (and battery calibration), video memory, and the WLAN module status.

You can view system information and error logs in the Advanced System Diagnostics window.

To start Advanced System Diagnostics:

1. Turn on or restart the computer. While the “Press the ESC key for Startup Menu” message is displayed in the lower-left corner of the screen, press **esc**. When the Startup Menu is displayed, press **f2**.
2. Click the diagnostic test you want to run, and then follow the on-screen instructions.



---

**NOTE:** If you need to stop a diagnostics test while it is running, press **esc**.

---

# 6 Specifications

## Computer specifications

	Metric	U.S.
<b>Dimensions</b>		
Width	<b>29.20 cm</b>	11.50 in
Depth	<b>19.20 cm</b>	7.56 in
Height	<b>2.65 cm</b>	1.04 in
<b>Weight</b> (equipped with 4-cell battery, hard drive, 1 memory module, and WLAN module)	<b>1.33 kg</b>	2.93 lbs
<b>Input power</b>		
Operating voltage and current	18.5 V dc @ 3.5 A - 65 W	
	18.5 V dc @ 3.5 A - 65 W, Slim Adapter	
	19.5 V dc @ 3.33 A - 65 W	
<b>Temperature</b>		
Operating	<b>5°C to 35°C</b>	41°F to 95°F
Nonoperating	<b>-20°C to 60°C</b>	-4°F to 140°F
<b>Relative humidity</b> (noncondensing)		
Operating	10% to 90%	
Nonoperating	5% to 95%	
<b>Maximum altitude</b> (unpressurized)		
Operating	<b>-15 m to 3,048 m</b>	-50 ft to 10,000 ft
Nonoperating	<b>-15 m to 12,192 m</b>	-50 ft to 40,000 ft
<b>NOTE:</b> Applicable product safety standards specify thermal limits for plastic surfaces. The device operates well within this range of temperatures.		

## 11.6-inch SGA display specifications

	<b>Metric</b>	<b>U.S.</b>
<b>Dimensions</b>		
Height	<b>14.70 cm</b>	5.79 in
Width	<b>25.90 cm</b>	10.20 in
Diagonal	<b>29.50 cm</b>	11.61 in
<b>Number of colors</b>	Up to 16.8 million	
<b>Contrast ratio</b>	200:1 (typical)	
<b>Brightness</b>	200 nits (typical)	
<b>Pixel resolution</b>		
Pitch	<b>0.197 × 0.197 mm</b>	
Format	1366 × 768	
Configuration	RGB vertical stripe	
<b>Backlight</b>	LED	
<b>Character display</b>	80 × 25	
<b>Total power consumption</b>	2.0 W	
<b>Viewing angle</b>	±65° horizontal, ±50° vertical (typical)	

# Hard drive specifications

	<b>750-GB*</b>	<b>500-GB*</b>	<b>320-GB*</b>
<b>Dimensions</b>			
Height	9.5 mm	9.5 mm	9.5 mm
Length	100.2 mm	100.4 mm	100.4 mm
Width	69.9 mm	69.9 mm	69.9 mm
Weight	110 g	110 g	110 g
<b>Interface type</b>			
	SATA	SATA	SATA
<b>Transfer rate</b>			
Synchronous (maximum)	1.1 GB/sec	1.1 GB/sec	1.1 GB/sec
Security	ATA security	ATA security	ATA security
<b>Seek times</b> (typical read, including setting)			
Single track	2.0 ms	1.5 ms	1.5 ms
Average (read/write)	12/16 ms	11/13 ms	11/13 ms
Maximum	22 ms	22 ms	22 ms
<b>Logical blocks</b>			
	1,465,149,168	976,773,168	628,142,448
<b>Disk rotational speed</b>			
	7200 rpm	7200 rpm	7200 rpm
<b>Operating temperature</b>			
	0°C to 60°C (32°F to 140°F)		
*1 GB = 1 billion bytes when referring to hard drive storage capacity. Actual accessible capacity is less.			
<b>NOTE:</b> Certain restrictions and exclusions apply. Contact technical support for details.			



---

# 7 Backup and recovery

## Windows 8

To protect your information, use Windows backup and restore utilities to back up individual files and folders, back up your entire hard drive, create system repair media (select models only) by using the installed optical drive (select models only) or an optional external optical drive, or create system restore points. In case of system failure, you can use the backup files to restore the contents of your computer.

From the Start screen, type `restore`, click **Settings**, and then select from the list of displayed options.

 **NOTE:** For detailed instructions on various backup and restore options, perform a search for these topics in Help and Support. From the Start screen, type `h`, and then select **Help and Support**.

In case of system instability, HP recommends that you print the recovery procedures and save them for later use.

 **NOTE:** Windows includes the User Account Control feature to improve the security of your computer. You may be prompted for your permission or password for tasks such as installing software, running utilities, or changing Windows settings. Refer to Help and Support for more information. From the Start screen, type `h`, and then select **Help and Support**.

## Backing up your information

Recovery after a system failure is as good as your most recent backup. You should create system repair media and your initial backup immediately after initial system setup. As you add new software and data files, you should continue to back up your system on a regular basis to maintain a reasonably current backup. As you add new software and data files, you should continue to back up your system on a regular basis to maintain a reasonably current backup. The system repair media (select models only) are used to start up (boot) the computer and repair the operating system in case of system instability or failure. Your initial and subsequent backups allow you to restore your data and settings if a failure occurs.

From the Start screen, type `backup`, click **Settings**, and then select **Save backup copies of your files with File History**.

You can back up your information to an optional external hard drive or a network drive.

Note the following when backing up:

- Store personal files in the Documents library, and back it up regularly.
- Back up templates that are stored in their associated programs.
- Save customized settings that appear in a window, toolbar, or menu bar by taking a screen shot of your settings. The screen shot can be a time-saver if you have to reset your preferences.

To create a backup using Backup and Restore:

---

 **NOTE:** Be sure that the computer is connected to AC power before you start the backup process.

 **NOTE:** The backup process may take over an hour, depending on file size and the speed of the computer.

---

1. From the Start screen, type `backup`, click **Settings**, and then select from the list of displayed options.
2. Follow the on-screen instructions to set up your backup, create a system image (select models only), or create system repair media (select models only).

## Performing a system recovery

In case of system failure or instability, the computer provides the following tools to recover your files:

- Windows recovery tools: You can use Windows Backup and Restore to recover information you have previously backed up. You can also use Windows Startup Repair to fix problems that might prevent Windows from starting correctly.
- `f11` recovery tools: You can use the `f11` recovery tools to recover your original hard drive image. The image includes the Windows operating system and software programs installed at the factory.

---

 **NOTE:** If you are unable to boot (start up) your computer and you cannot use the system repair media you previously created (select models only), you must purchase Windows 8 operating system media to reboot the computer and repair the operating system. For additional information, see the “Using Windows 8 operating system media (purchased separately)” section.

---

## Using the Windows recovery tools

To recover information you previously backed up:

- ▲ From the Start screen, type `h`, and then select **Help and Support**.

To recover your information using Startup Repair, follow these steps:

---

 **CAUTION:** Some Startup Repair options will completely erase and reformat the hard drive. All files you have created and any software installed on the computer are permanently removed. When reformatting is complete, the recovery process restores the operating system, as well as the drivers, software, and utilities from the backup used for recovery.

---

1. If possible, back up all personal files.
2. If possible, check for the presence of the HP Recovery partition and the Windows partition.

From the Start screen, type `e`, and then click **File Explorer**.

– or –

From the Start screen, type `c`, and then select **Computer**.

---

 **NOTE:** If the Windows partition and the HP Recovery partition are not listed, you must recover your operating system and programs using the Windows 8 operating system DVD and the Driver Recovery media (both purchased separately). For additional information, see the “Using Windows 8 operating system media (purchased separately)” section.

---

3. If the Windows partition and the HP Recovery partition are listed, restart the computer. After Windows has loaded, press and hold the `shift` key while clicking **Restart**.
4. Select **Startup Repair**.
5. Follow the on-screen instructions.

---

 **NOTE:** For additional information on recovering information using the Windows tools, perform a search for these topics in Help and Support. From the Start screen, type `h`, and then select **Help and Support**.

---

## Using f11 recovery tools

---

 **CAUTION:** Using `f11` completely erases hard drive contents and reformats the hard drive. All files that you have created and any software that you have installed on the computer are permanently removed. The `f11` recovery tool reinstalls the operating system and HP programs and drivers that were installed at the factory. Software not installed at the factory must be reinstalled.

---

To recover the original hard drive image using `f11`:

1. If possible, back up all personal files.
2. If possible, check for the presence of the HP Recovery partition: From the Start screen, type `c`, and then select **Computer**.

---

 **NOTE:** If the HP Recovery partition is not listed, you must recover your operating system and programs using the Windows 8 operating system media and the Driver Recovery media (both purchased separately). For additional information, see the “Using Windows 8 operating system media (purchased separately)” section.

---

3. If the HP Recovery partition is listed, restart the computer, and then press `esc` while the “Press the ESC key for Startup Menu” message is displayed at the bottom of the screen.

4. Press **f11** while the “Press <F11> for recovery” message is displayed on the screen.
5. Follow the on-screen instructions.

## Using Windows 8 operating system media (purchased separately)

To order a Windows 8 operating system DVD, go to <http://www.hp.com/support>, select your country or region, and follow the on-screen instructions. You can also order the DVD by calling support. For contact information, see the Worldwide Telephone Numbers booklet included with the computer.

---

 **CAUTION:** Using a Windows 8 operating system media completely erases hard drive contents and reformats the hard drive. All files that you have created and any software that you have installed on the computer are permanently removed. When reformatting is complete, the recovery process helps you restore the operating system, as well as drivers, software, and utilities.

---

To initiate recovery using a Windows 8 operating system DVD:

---

 **NOTE:** This process takes several minutes.

---

1. If possible, back up all personal files.
2. Restart the computer, and then insert the Windows 8 operating system DVD into the optical drive before the Windows operating system loads.
3. When prompted, press any keyboard key.
4. Follow the on-screen instructions.

After the repair is completed:

1. Eject the Windows 8 operating system media and then insert the *Driver Recovery* media.
2. Install the Hardware Enabling Drivers first, and then install Recommended Applications.

## Using Windows Refresh for quick and easy recovery

When your computer is not working properly and you need to regain system stability, the Windows Refresh option allows you to start fresh and keep what is important to you.

---

 **IMPORTANT:** Refresh removes any traditional applications that were not originally installed on the system at the factory.

 **NOTE:** During Refresh, a list of removed traditional applications will be saved so that you have a quick way to see what you might need to reinstall. See Help and Support for instructions on reinstalling traditional applications. From the Start screen, type **h**, and then select **Help and Support**.

 **NOTE:** You may be prompted for your permission or password when using Refresh. See Windows Help and Support for more information. From the Start screen, type **h**, and then select **Help and Support**.

---

To start Refresh:

1. On the Start screen, point to the far-right upper or lower corner of the screen to display the charms.
2. Click **Settings**.
3. Click **Change PC settings** in the bottom-right corner of the screen, and then select **General** from the PC settings screen.
4. Under **Refresh your PC without affecting your files**, select **Get started**, and follow the on-screen instructions.

## Remove everything and reinstall Windows

Sometimes you want to perform detailed reformatting of your computer, or you want to remove personal information before you give away or recycle your computer. The process described in this section provides a speedy, simple way to return the computer to its original state. This option removes all personal data, apps, and settings from your computer, and reinstalls Windows.

---

 **IMPORTANT:** This option does not provide backups of your information. Before using this option, back up any personal information you wish to retain.

---

You can initiate this option by using the **f11** key or from the Start screen.

To use the **f11** key:

1. Press **f11** while the computer boots.  
– or –  
Press and hold **f11** as you press the power button.
2. Select **Troubleshoot** from the boot options menu.
3. Select **Reset your PC**, and follow the on-screen instructions.

To use the Start screen:

1. On the Start screen, point to the far-right upper or lower corner of the screen to display the charms.
2. Click **Settings**.
3. Click **Change PC settings** in the bottom-right corner of the screen, and then select **General** from the PC settings screen.
4. Under **Remove everything and reinstall Windows**, select **Get started**, and follow the on-screen instructions.

## Using HP Software Setup

HP Software Setup can be used to reinstall drivers or select software that has been corrupted or deleted from the system.

1. From the Start screen, type `HP Software Setup`, and select **Apps**.
2. Open HP Software Setup.
3. Follow the on-screen directions to reinstall drivers or select software.

## Windows 7

To protect your information, use Windows Backup and Restore to back up individual files and folders, back up your entire hard drive (select models only), create system repair discs (select models only) with the installed optical drive (select models only) or an optional external optical drive, or create system restore points. In case of system failure, you can use the backup files to restore the contents of your computer.

Windows Backup and Restore provides the following options:

- Creating a system repair disc (select models only) by using the installed optical drive (select models only) or an optional external optical drive
- Backing up your information
- Creating a system image (select models only)
- Scheduling automatic backups (select models only)
- Creating system restore points
- Recovering individual files
- Restoring the computer to a previous state
- Recovering information using recovery tools

---

 **NOTE:** For detailed instructions, perform a search for these topics in Help and Support.

In case of system instability, HP recommends that you print the recovery procedures and save them for later use.

 **NOTE:** Windows includes the User Account Control feature to improve the security of your computer. You may be prompted for your permission or password for tasks such as installing software, running utilities, or changing Windows settings. See Help and Support for more information.

---

## Creating recovery media with HP Recovery Disc Creator

HP Recovery Disc Creator is a software program that offers an alternative way to create recovery media. After you successfully set up the computer, you can create recovery media using HP Recovery Disc Creator. This recovery media allows you to reinstall your original operating system as well as select drivers and applications if the hard drive becomes corrupted.

HP Recovery Disc Creator can create two kinds of recovery DVDs as follows:

- Windows DVD—Installs the operating system without additional drivers or applications.
- Driver DVD—Installs specific drivers and applications only, in the same way that the HP Software Setup utility installs drivers and applications.

### Creating recovery media

---

 **NOTE:** The Windows DVD can be created only once. Thereafter, the option to create that media will not be available.

---

1. Select **Start > All Programs > Productivity and Tools > HP Recovery Disc Creator**.
2. Select **Driver DVD** or **Windows DVD**.
3. From the drop-down menu, select the drive for burning the recovery media.
4. Click the **Burn** button to start the burning process.

### Backing up your information

Recovery after a system failure is as good as your most recent backup. Immediately after setting up the computer, you should create system repair discs (select models only) using the installed optical drive (select models only) or an optional external optical drive and back up your system. As you add new software and data files, you should continue to back up your system on a regular basis to maintain a reasonably current backup. The system repair discs (select models only) are used to start up (boot) the computer and repair the operating system in case of system instability or failure. Your initial and subsequent backups allow you to restore your data and settings if a failure occurs.

You can back up your information to an optional external hard drive, a network drive, or discs.

Note the following when backing up:

- Store personal files in the Documents library, and back it up regularly.
- Back up templates that are stored in their associated programs.
- Save customized settings that appear in a window, toolbar, or menu bar by taking a screen shot of your settings. The screen shot can be a time-saver if you have to reset your preferences.
- When backing up to discs, use any of the following types of discs (purchased separately): CD-R, CD-RW, DVD+R, DVD+R DL, DVD-R, DVD-R DL, or DVD±RW. The discs you use will depend on the type of optical drive you are using.

---

 **NOTE:** DVDs and DVDs with double-layer (DL) support store more information than CDs, so using them for backup reduces the number of recovery discs required.

---

- When backing up to discs, number each disc before inserting it into the external drive.

To create a backup using Backup and Restore:

---

 **NOTE:** Be sure that the computer is connected to AC power before you start the backup process.

---

 **NOTE:** The backup process may take over an hour, depending on file size and the speed of the computer.

---

1. Select **Start > All Programs > Maintenance > Backup and Restore**.
2. Follow the on-screen instructions to set up your backup, create a system image (select models only), or create a system repair disc (select models only).

## Performing a system recovery

In case of system failure or instability, the computer provides the following tools to recover your files:

- Windows recovery tools: You can use Windows Backup and Restore to recover information you have previously backed up. You can also use Windows Startup Repair to fix problems that might prevent Windows from starting correctly.
- f11 recovery tools: You can use the f11 recovery tools to recover your original hard drive image. The image includes the Windows operating system and software programs installed at the factory.

---

 **NOTE:** If you are unable to boot (start up) your computer and you cannot use the system repair discs you previously created (select models only), you must purchase a Windows 7 operating system DVD to reboot the computer and repair the operating system. For additional information, see the Using a Windows 7 operating system DVD (purchased separately) section.

---

## Using the Windows recovery tools

To recover information you previously backed up:

1. Select **Start > All Programs > Maintenance > Backup and Restore**.
2. Follow the on-screen instructions to recover your system settings, your computer (select models only), or your files.

To recover your information using Startup Repair, follow these steps:

---

 **CAUTION:** Some Startup Repair options completely erase hard drive contents and reformat the hard drive. All files you have created and any software installed on the computer are permanently removed. When reformatting is complete, the recovery process restores the operating system, as well as the drivers, software, and utilities from the backup used for recovery.

---

1. If possible, back up all personal files.
2. If possible, check for the presence of the Windows partition.

To check for the Windows partition, select **Start > Computer**.



3. If the Windows partition is listed, restart the computer, and then press **f8** before the Windows operating system loads.
4. Select **Startup Repair**.
5. Follow the on-screen instructions.

---

 **NOTE:** For additional information on recovering information using the Windows tools, perform a search for these topics in Help and Support.

---

## Using **f11** recovery tools

 **CAUTION:** Using **f11** recovery tools completely erases hard drive contents and reformats the hard drive. All files you have created and any software installed on the computer are permanently removed. The **f11** recovery tool reinstalls the operating system and HP programs and drivers that were installed at the factory. Software not installed at the factory must be reinstalled.

---

To recover the original hard drive image using **f11**:

1. If possible, back up all personal files.
2. If possible, check for the presence of the HP Recovery partition: click **Start**, right-click **Computer**, click **Manage**, and then click **Disk Management**.

 **NOTE:** If the HP Recovery partition has been deleted, the **f11** restore option will not function. You must recover your operating system and programs using the Windows 7 operating system DVD and the Driver Recovery disc (both purchased separately) if the Windows partition and the HP Recovery partition are not listed. For additional information, see the Using a Windows 7 operating system DVD (purchased separately) section.

---

3. If the HP Recovery partition is listed, restart the computer, and then press **esc** while the “Press the ESC key for Startup Menu” message is displayed at the bottom of the screen.
4. Press **f11** while the “Press <F11>” for recovery” message is displayed on the screen.
5. Follow the on-screen instructions.

## Using a Windows 7 operating system DVD (purchased separately)

To order a Windows 7 operating system DVD, go to the HP website. For U.S. support, go to <http://www.hp.com/go/contactHP>. For worldwide support, go to [http://welcome.hp.com/country/us/en/wwcontact\\_us.html](http://welcome.hp.com/country/us/en/wwcontact_us.html). You can also order the DVD by calling support. For contact information, see the *Worldwide Telephone Numbers* booklet included with the computer.

---

 **CAUTION:** Using a Windows 7 operating system DVD completely erases hard drive contents and reformats the hard drive. All files you have created and any software installed on the computer are permanently removed. When reformatting is complete, the recovery process helps you restore the operating system, as well as drivers, software, and utilities.

---

To initiate recovery using a Windows 7 operating system DVD:

---

 **NOTE:** This process takes several minutes.

---

1. If possible, back up all personal files.
2. Restart the computer, and then insert the Windows 7 operating system DVD into the optical drive before the Windows operating system loads.
3. When prompted, press any keyboard key.
4. Follow the on-screen instructions.
5. Click **Next**.
6. Select **Repair your computer**.
7. Follow the on-screen instructions.

After the repair is completed:

1. Eject the Windows 7 operating system DVD, and then insert the Driver Recovery disc.
2. Install the Hardware Enabling Drivers first, and then install Recommended Applications.

# SuSE Linux (SLED)

Recovery after a system failure is as good as your most recent backup. As you add new software and data files, you should continue to back up your system on a regular basis to maintain a reasonably current backup.

Your computer includes tools provided by HP to help you safeguard your information and retrieve it if ever needed.

## Creating backups

1. Create restore media immediately after you set up the computer. For more information, see the “Performing a system recovery” section.
2. As you add files, routinely create a backup of your system and personal information.

## Backing up your information

You should back up your computer files on a regular schedule to maintain a current backup. You can manually back up your information to an optional external drive, a network drive, or discs. Back up your system at the following times:

- At regularly scheduled times
- Before the computer is repaired or restored
- Before you add or modify hardware or software

To back up your home directory files using **Backup Manager Settings**:

1. Select **Computer > More Applications > Tools > Backup Manager Settings**, and click **Backup my home directory**.
2. Click **Storage Destination Location**, and then select a location to back up your information.
3. Click **Schedule**, and then select a time schedule to perform backups at a regularly scheduled time.

To immediately back up your information, click the **Backup Now** check box.



**NOTE:** Before you back up your information, be sure you have designated a location to save the backup files.

4. Click **Save and Backup** to start the backup and to save the backup settings.

To restore backup files:

1. Select **Computer > More Applications > Tools > Backup Manager Restore**.
2. Click **Backup Source**, and then select the location of the backup files.
3. Click **Restore Destination**, and then select the destination to restore the files.

4. To restore all files from the selected location, click **Restore all files**. To restore select files only, click **Restore selected files**, click **Select Files** and then select the files to be restored.
5. Under **Restore Point**, click the time and date of the backup.



**NOTE:** If multiple backups have been performed, click **Use the latest version** to restore the latest version.

6. Click **Restore** to start restoring the files, or click **Cancel** to cancel the operation.

## Performing a system recovery

Recovery allows you to repair or restore the computer to its original factory state. You can create an HP Factory Image Restore DVD, using an installed or an external DVD±RW optical drive.



**CAUTION:** CAUTION: Using Recovery completely erases hard drive contents and reformats the hard drive. All files you have created and any software installed on the computer are permanently removed. The recovery tool reinstalls the original operating system and HP programs and drivers that were installed at the factory. Software, drivers, and updates not installed by HP must be manually reinstalled. Personal files must be restored from a backup.

To restore the computer using the HP Factory Image Restore DVD, you must first create the recovery disc. To create the recovery disc:



**NOTE:** HP recommends that you create the HP Factory Image Restore DVD in the event of a system failure.

1. Select **Computer > More Applications**.
2. In the left pane, click **Tools**, and then click **Create HP Factory Image Restore DVD** in the right pane.
3. Follow the on-screen instructions to create an image file to burn a recovery disc.

To restore the computer from the recovery disc, follow these steps:

1. If possible, back up all personal files.
2. Insert the HP Factory Image Restore DVD into the optical drive and restart the computer.
3. As the computer is restarting, press **F9** to open the Computer Setup boot option menu.
4. Press the down arrow to select **Restore SLED HP-BNB preload image** from the **Linux boot** menu, and then press **enter**.
5. Using the arrow keys, select **Yes** when prompted: **Do you want to start the System-Restore?**
6. Follow the on-screen instructions.

## USB Recovery option (select models only)

The USB Recovery Disk On Key (flash drive) option allows you to create a backup image of the SLED operating system installed on select HP Business Notebooks. This Disk On Key may be used to restore the system to the original factory state when the F11 recovery option is not available. This process should be done on first obtaining the computer.

 **CAUTION:** The USB recovery option does not preserve data present on the computer's hard drive or on the Disk On Key used for the recovery process. Back up any data on the Disk on Key or the notebook that will be recovered before starting.

 **NOTE:** HP recommends that you create the USB Recovery Disk in the event of a system failure. The Disk On Key used for this process should be 4 GB or larger.

Creating a USB Recovery Disk On Key

1. Connect the USB Disk On Key to a USB port on the computer.
2. Select **Computer > More applications > Tools > Create Recovery USB**.
3. Enter the root password when prompted.
4. Select **USB Disk On Key** from the list.
5. Click **OK**.
6. A question dialog will remind you that the data on the USB key will be destroyed. To continue, click **OK**. Otherwise, click **Cancel** and back up the contents of the Disk On Key on another computer.
7. The backup process will display a status dialog box while the backup is in progress.

 **NOTE:** A file browser window with the Disk On Key Contents displayed will pop up when the key is mounted. You may close the file browser window if desired. Once the USB Recovery Key has been created, the status dialog will close. The USB Recovery Key is ready for use.

Recovering from a USB Recovery Disk On Key

 **CAUTION:** Before starting the Recovery process, make sure any data on the system to be recovered has been backed up. The recovery process destroys all data on the system to be recovered.

1. Turn off the computer.
2. Connect the USB Disk On Key to a USB port on the computer.
3. Turn on the computer while holding down the **f9** key.
4. Once the system has booted, the **Boot Options** menu should appear.
5. Using the arrow keys, select **USB Disk On Key** and press **enter**.

 **NOTE:** The description may vary from one USB key to another. Any entry other than Optical Disk Drive, Notebook Hard Drive or Notebook Ethernet should be the USB Recovery Disk On Key.

6. Once the USB Recovery Disk On Key has been selected, press **enter**. The USB Recovery Disk On Key will boot.

7. Once the USB Recovery Disk On Key has booted, a dialog box will prompt, “Do you want to start the System-Restore?” If data on the computer has not been backed up, use the tab key and select No. The system will reboot. Back up the system data and repeat the previous steps. If no data should be saved from the computer, use the tab key to select **Yes**. Press enter to begin the recovery process.
8. After the files are copied to the system, follow the on-screen instructions.

## Remove everything and reinstall SLED

Sometimes you want to perform detailed reformatting of your computer, or you want to remove personal information before you give away or recycle your computer. The process described in this section provides a speedy, simple way to return the computer to its original state. This option removes all personal data, applications, and settings from your computer, and reinstalls the Linux operating system.

---

 **IMPORTANT:** This option does not provide backups of your information. Before using this option, back up any personal information you wish to retain.

---

You can initiate this option by using the f11 key.

To use the f11 key:

Press f11 while the computer boots.

– or –

Press and hold f11 as you press the power button.

The following options are available:

- Cancel/Reboot—Reboots the system. No recovery or restore activity is performed.
- Recover/Repair System—This option repairs a system that is not working properly and preserves user data.
- Restore Factory System—This option restores the system back to the original factory state. User data is not preserved.

Select an option and follow the on-screen instructions.

---

## 8 Power cord set requirements

The wide-range input feature of the computer permits it to operate from any line voltage from 100 to 120 volts AC, or from 220 to 240 volts AC.

The 3-conductor power cord set included with the computer meets the requirements for use in the country or region where the equipment is purchased.

Power cord sets for use in other countries and regions must meet the requirements of the country or region where the computer is used.

### Requirements for all countries

The following requirements are applicable to all countries and regions:

- The length of the power cord set must be at least **1.0 m** (3.3 ft) and no more than **2.0 m** (6.5 ft).
- All power cord sets must be approved by an acceptable accredited agency responsible for evaluation in the country or region where the power cord set will be used.
- The power cord sets must have a minimum current capacity of 10 amps and a nominal voltage rating of 125 or 250 V AC, as required by the power system of each country or region.
- The appliance coupler must meet the mechanical configuration of an EN 60 320/IEC 320 Standard Sheet C13 connector for mating with the appliance inlet on the back of the computer.

## Requirements for specific countries and regions

Country/region	Accredited agency	Applicable note number
Australia	EANSW	1
Austria	OVE	1
Belgium	CEBC	1
Canada	CSA	2
Denmark	DEMKO	1
Finland	FIMKO	1
France	UTE	1
Germany	VDE	1
Italy	IMQ	1
Japan	METI	3
The Netherlands	KEMA	1
Norway	NEMKO	1
The People's Republic of China	COC	5
South Korea	EK	4
Sweden	SEMKO	1
Switzerland	SEV	1
Taiwan	BSMI	4
The United Kingdom	BSI	1
The United States	UL	2

1. The flexible cord must be Type HO5VV-F, 3-conductor, 1.0-mm<sup>2</sup> conductor size. Power cord set fittings (appliance coupler and wall plug) must bear the certification mark of the agency responsible for evaluation in the country or region where it will be used.
2. The flexible cord must be Type SPT-3 or equivalent, No. 18 AWG, 3-conductor. The wall plug must be a two-pole grounding type with a NEMA 5-15P (15 A, 125 V) or NEMA 6-15P (15 A, 250 V) configuration.
3. The appliance coupler, flexible cord, and wall plug must bear a "T" mark and registration number in accordance with the Japanese Dentori Law. The flexible cord must be Type VCT or VCTF, 3-conductor, 1.00-mm<sup>2</sup> conductor size. The wall plug must be a two-pole grounding type with a Japanese Industrial Standard C8303 (7 A, 125 V) configuration.
4. The flexible cord must be Type RVV, 3-conductor, 0.75-mm<sup>2</sup> conductor size. Power cord set fittings (appliance coupler and wall plug) must bear the certification mark of the agency responsible for evaluation in the country or region where it will be used.
5. The flexible cord must be Type VCTF, 3-conductor, 0.75-mm<sup>2</sup> conductor size. Power cord set fittings (appliance coupler and wall plug) must bear the certification mark of the agency responsible for evaluation in the country or region where it will be used.



---

## 9 Recycling

When a non-rechargeable or rechargeable battery has reached the end of its useful life, do not dispose of the battery in general household waste. Follow the local laws and regulations in your area for battery disposal.

HP encourages customers to recycle used electronic hardware, HP original print cartridges, and rechargeable batteries. For more information about recycling programs, see the HP Web site at <http://www.hp.com/recycle>.

---

# Index

- A**
  - AC adapter, spare part numbers 35, 43
  - AC adapter/battery light 14
  - antenna
    - locations 9
    - removal 102, 103
    - spare part number 31, 37, 103, 104
  - Antenna Kit, spare part number 31, 37, 104
  - audio board
    - removal 80
    - spare part number 29, 38, 80
  - audio board cable, illustrated 33
  - audio, product description 2
  - audio-in jack 15
  - audio-out jack 15
- B**
  - base enclosure
    - removal 76
    - spare part number 29, 37, 76
  - battery
    - removal 56
    - spare part numbers 29, 37, 56
  - battery bay 18
  - battery lock latch 18
  - battery release latch 19
  - bottom components 18
  - button components 10
  - buttons
    - pointing stick 13
    - TouchPad 13
    - TouchPad on/off 10, 13
- C**
  - Cable Kit
    - components 33
    - spare part number 33, 37
  - cables, service considerations 49
  - caps lock light 12
  - chipset, product description 1
  - components
    - bottom 18
    - buttons 10
    - display 9
    - fingerprint reader 10
    - front 14
    - keys 11
    - left-side 15
    - lights 12
    - right-side 16
    - TouchPad 13
  - computer feet
    - location 55
    - spare part number 55
  - computer major components 22
  - computer part number 54
  - computer specifications 118
  - connectors, service considerations 49
- D**
  - display
    - components 9
    - specifications 119
  - display assembly subcomponents 31
  - display bezel
    - removal 97
    - spare part numbers 31, 37, 98
  - Display Cable Kit, spare part number 31, 37, 101
  - display clutch cover
    - removal 98
    - spare part number 32, 37, 98
  - display enclosure, spare part number 32, 37
  - display hinge
    - removal 99
    - spare part number 32, 37, 99
  - display hinge cap
    - removal 99
    - spare part number 32, 37, 99
  - display hinge cover
    - removal 99
    - spare part number 32, 37, 99
  - Display Hinge Cover Kit, spare part number 32, 37, 99
  - display panel
    - product description 1
    - removal 100
    - spare part number 31, 39, 101
  - display panel cable
    - removal 101
    - spare part number 31, 37, 101
  - Display Panel Support Kit, spare part number 32, 37
  - DisplayPort 15
  - docking connector, location 19
  - drives, preventing damage 50
- E**
  - electrostatic discharge 50
  - equipment guidelines 53
  - esc key 11
  - Ethernet, product description 3
  - external monitor port 17

## F

fan  
removal 68  
spare part number 29, 37, 68

feet  
location 55  
spare part number 55

fingerprint reader 10

fingerprint reader board  
removal 61  
spare part number 27, 38, 61

fn key 11

front component 14

function keys 11

## G

graphics, product description 1

grounding guidelines 50

guidelines  
equipment 53  
grounding 50  
packaging 52  
transporting 52  
workstation 52

## H

hard drive  
precautions 50  
product description 2  
removal 59  
spare part numbers 29, 34, 36, 37, 48, 59  
specifications 120

hard drive bracket  
illustrated 34  
removal 60

hard drive connector adapter  
illustrated 34  
removal 60

Hard Drive Hardware Kit  
contents 34  
spare part number 30, 34, 38, 59

hard drive light 14

headphone jack 15

heat sink  
removal 91  
spare part number 28, 37, 91

## J

jacks  
audio-in 15  
audio-out 15  
headphone 15  
microphone 15  
network 17  
RJ-45 17

## K

key components 11

keyboard  
product description 4  
removal 69  
spare part numbers 23, 25, 39, 40, 41, 42, 43, 44, 45, 46, 47, 69

keys  
esc 11  
fn 11  
function 11  
num lk 11  
Windows applications key 11  
Windows logo key 11

## L

left-side components 15

light components 12

lights  
AC adapter/battery 14  
caps lock 12  
hard drive 14  
num lock 12  
power 14  
TouchPad 12  
webcam 9  
wireless 12, 14

lock, spare part numbers 35, 36

## M

mass storage device  
illustrated 34  
precautions 50  
spare part numbers 34

Media Card reader assembly  
removal 84  
spare part number 27, 38, 84

Media Card reader assembly  
cable, illustrated 33

Media Card reader, location 16

memory module  
product description 2  
removal 66  
spare part numbers 36, 37, 66

microphone  
location 9  
product description 2

microphone jack 15

microphone module  
removal 102  
spare part number 31, 37, 102

model description 55

model name 1

monitor port 17

mouse, spare part number 35, 36

## N

network jack 17

num lk key 11

num lock light, location 12

numeric keypad 11

## O

operating system, product description 5

## P

packaging guidelines 52

plastic parts, service considerations 49

pointing device, product description 4

pointing stick 13

pointing stick button 13

ports  
DisplayPort 15  
external monitor 17  
monitor 17  
product description 4  
USB 15  
USB 3.0 charging 17

power connector 15

power cord  
set requirements 135  
spare part numbers 35, 36

power light 14

power requirements, product description 4

power switch 17

- power switch board
  - removal 83
  - spare part number 29, 38, 83
- processor bracket, spare part number 43
- processor, product description 1
- product description
  - audio 2
  - chipset 1
  - display panel 1
  - Ethernet 3
  - external media cards 3
  - graphics 1
  - hard drive 2
  - keyboard 4
  - memory module 2
  - microphone 2
  - operating system 5
  - pointing device 4
  - ports 4
  - power requirements 4
  - processors 1
  - product name 1
  - security 4
  - serviceability 8
  - solid-state drive 2
  - video 2
  - wireless 3
- product name 1, 54
- product number 54

## R

- removal/replacement
  - preliminaries 49
  - procedures 54
- right-side components 16
- RJ-45 jack 17
- RTC battery
  - removal 86
  - spare part number 29, 37, 86
- Rubber Kit, spare part number 29, 38

## S

- Screw Kit, spare part number 35, 38
- security cable slot 15
- security, product description 4
- serial number 54

- service considerations
  - cables 49
  - connectors 49
  - plastic parts 49
- service cover
  - location 18
  - removal 58
  - spare part numbers 30, 38, 43, 58
- service tag 21, 54
- serviceability, product description 8
- SIM slot, location 18
- SIM, removal 57
- sleeve, spare part number 35, 37
- Smart Card reader assembly
  - removal 93
  - spare part number 27, 37, 93
- Smart Card reader, location 15
- solid-state drive
  - precautions 50
  - product description 2
  - spare part numbers 30, 34, 43
- speakers 14
  - removal 81
  - spare part number 29, 38, 81
- specifications
  - computer 118
  - display 119
  - hard drive 120
- system board
  - removal 88
  - spare part numbers 27, 38, 39, 43, 48, 88

## T

- tools required 49
- top cover
  - removal 94
  - spare part numbers 27, 38, 43
- TouchPad button 13
- TouchPad cable, illustrated 33
- TouchPad components 13
- TouchPad light 12
- TouchPad on/off button 10, 13
- TouchPad zone 13
- transporting guidelines 52

## U

- USB 3.0 charging port 17
- USB port 15

## V

- vents 15, 18
- video, product description 2

## W

- warranty period 55
- webcam 10
- webcam light 9
- webcam/microphone module
  - spare part number 31, 38, 102
- webcam/microphone module cable
  - removal 102
- Windows applications key 11
- Windows logo key 11
- wireless antenna
  - locations 9
  - removal 102, 103
  - spare part number 31, 37, 103, 104
- Wireless Antenna Kit, spare part number 103
- wireless light 12, 14
- wireless, product description 3
- WLAN module
  - removal 62
  - spare part numbers 29, 36, 37, 62
- workstation guidelines 52
- WWAN module
  - removal 64
  - spare part numbers 29, 36, 37, 43, 47, 64

