

HP Scitex FB7600

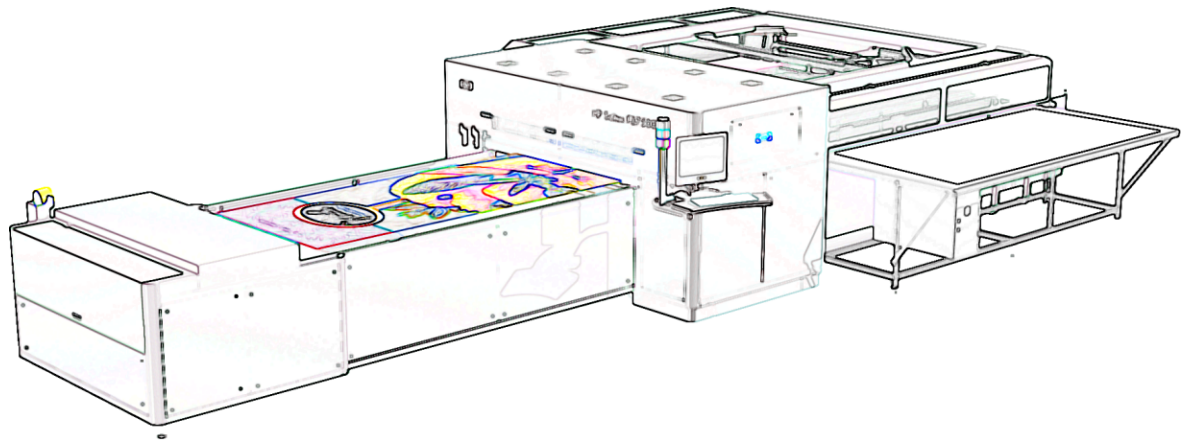

Essential Health and Safety Instructions



English Version

Important Notice

The information contained herein is subject to change without notice. The only warranties for HP products and services are set forth in the express warranty statements accompanying such products and services. Nothing herein should be construed as constituting an additional warranty. HP shall not be liable for technical or editorial errors or omissions contained herein.

This document is delivered subject to the following conditions and restrictions:

This document contains proprietary information of HP Scitex (the "Company"). Such information is hereby supplied solely for the purpose of assisting authorized users of HP Scitex industrial presses (the "System").

Without the express prior written permission of HP Scitex, no part of the contents hereof may be used for any other purposes, disclosed to any person or firm, or reproduced by any means.

The text and drawings herein are for the purposes of illustration and reference only. The specifications on which they are based are subject to change without notice.

The names HP, HP Scitex, and the HP logo are registered trademarks or service marks of Hewlett-Packard. The mark HP Scitex FB7600 and HP Scitex FB7500 are trademarks of the Company.

Other company and brand, product and service names are for identification purposes only and may be trademarks or registered trademarks of their respective holders. Data is subject to change without notice.

Catalog No: CX194-04230

Document ID: emr_na-c03626182

Copyright © 2012 Hewlett-Packard Development Company, L.P.

All Rights Reserved

Revision B

October 2012

Disclaimer

The Company shall not be liable for any damages, costs and expenses (including, without limitation, damages in connection with bodily injuries, consequential damages and damages for loss of profits), incurred by the customer or by any third party, whether in action, in contract, tort or otherwise, arising out of, or in connection with, the System, its installation and/or operation, and any related accessories, products, parts, components or materials, except as, and to the extent, expressly specified in the applicable purchase contract.

Limited Warranty

The Company does not provide any warranty with respect to the System, its installation and/or operation, and any related accessories, products, parts, components or materials, except as, and to the extent, expressly specified in the applicable purchase contract.

Local Regulations

The customer is required to strictly follow the applicable international, regional, federal and state laws, regulations and standards, and nothing in this guide shall be construed as instructing or otherwise requiring or allowing the customer to violate such laws, regulations and standards. However, if and to the extent permitted by law, in case of inconsistency or contradiction between any requirement or procedure contained in this guide and any such laws, regulations and standards, the customer shall follow the stricter between the requirements and procedures specified in this guide and the requirements and procedures specified in any such laws, regulations or standards.

HP Scitex has assured the system compliance to the relevant standards, as stated in the Declaration of Conformity (see page 43) and marked on the name plate label.

Conventions

The safety hazard caution conventions used in this guide (and supplementary HP Scitex FB7600 documentation) are provided for the identification of safety hazards. They are used to identify conditions or actions for which a specific hazard is known to exist, and that may, cause personal injury and/or equipment malfunction.

The conventions are classified into the following categories: **Danger** and **Caution**. Examples are shown below:

Danger



Danger indicates a hazard with a high level of risk which, if not avoided, could result in death or serious injury.

Caution



Caution indicates a hazard with a low level of risk which, if not avoided, could result in minor or moderate injury, and/or damage to the equipment.

Other Conventions

The following conventions are used to draw your attention to important points which are beyond or in addition to the regular information in this book:



Note Notes are used to identify an explanation, or provide additional information for purposes of clarification.



Tip Tips provide useful shortcuts or recommendations.



Reference References are provided to refer you to further information in this document or another guide.

Contact Information

European Contact: Hewlett-Packard GmbH, HQ-TRE, Herrenberger Strasse 140, 71034 Boeblingen, Germany

USA Contact: Hewlett-Packard Company, HPCC, 20555 S.H. 249 Houston, Texas, 77070

Australia Contact: Hewlett-Packard Australia Ltd, Product regulations Manger, 31-41 Joseph Street, Blackburn, Victoria, 3130, Australia

Table of Contents

Customer's Responsibilities	1
Site Readiness	1
Electrical/Lighting Requirements	1
Safety Requirements	1
Pneumatic Requirements	1
Environmental Requirements	1
RIP and Networking Requirements	2
Miscellaneous	2
Safety Information	3
About FB7600 Printer	3
Safe Operation Guidelines	4
General	4
Electrical Shock Hazards	5
Fire Hazards	6
Explosion Hazard	7
Provision for an Eye Wash Station	7
Mechanical Safety	8
Measured Noise Levels	8
Handling Inks and Solvent	8
Cleaning with Solvent and Alcohol	10
Waste Disposal	10
Danger Zone and Warning Labels	11
UV System Safety	12
Introduction	12
High Voltage	12
Fire Risk	12
UV Ink and Generated Products	12
Noise	13
Safety Precautions While Servicing	13
Safety UV Curing	14
Permissible UV Exposure Levels	17
Shutting Down the Entire UV System	18
Environmental Notices	18
Battery Disposal (California)	18
Use of Sensitive Receivers	19
First Aid Treatment	19
Inhalation	19
Eye Contact	19
Skin Contact	19

IEC Symbols	19
Safety Warning Labels	20
Emergency Safety Devices	22
Emergency Stop Buttons	23
Service Key	24
Unloader Lift Safety Frame	25
Personal Safety — Working with the Printer	25
Site Preparation Requirements	27
System Components	27
Floor Surface and Strength	28
Electrical Requirements	28
Power Line Disturbances	31
Surge Protection	31
Grounding	31
Pneumatic Requirements	32
Air Compressor	32
Air Dryer	32
Environmental Requirements	32
Lighting	32
Temperature and Humidity	33
Ventilation and Fume Extraction	34
Delivery Instructions	35
Required Tools and Equipment	35
Unloading the Main Machine Frame Crate	37
FB7600 Maintenance	41
Declaration of Conformity	43

Customer's Responsibilities

The items shown below are the customer's responsibility and are not supplied by HP Scitex. Specifications and/or recommendations for each item are indicated in the appropriate sections:

Site Readiness

- **Professional carrier**
- **Design of the print production area**
- **Pit (optional)** - Deepening the foot print area of the lift

Electrical/Lighting Requirements

- **Mains power outlet - 3-phase** (in accordance with local regulations of country of installation) and connection of the electrical cabinet and UV electrical cabinet to the mains power
- **Sufficient lightning of the print production area**

Safety Requirements

- **Eye Wash station and First Aid facilities**
- **Fire extinguisher**
- **Hazardous waste container**

Pneumatic Requirements

- **Compressed air with wall-mounted air outlet** and connection to the FB7600 pneumatic system
- **Active air dryer (air condenser)**
- **Vacuum pump connection** to the FB7600 vacuum system

Environmental Requirements

- **Blower for Bridge Ventilation**
- **Maintaining temperature and humidity** (both in the print production and in the storage areas)
- **Ventilation and fume extraction** (connection of the fume extraction duct to the extraction blower)
- **Ink and solvent storage cabinets**

RIP and Networking Requirements

- RIP hardware
- Network connection
- Internet connection
- Phone line for remote support
- Call me @ HP preparations

Miscellaneous

- Distilled water for the UV cooler
- All pre-installation preparations not specifically provided for in the sales contract. These may include the following:
 - Cost of building/modifications at the installation site, as applicable.
 - Booking the services of a specialist moving contractor (equipped with the required crane) to unload and move the equipment on the scheduled installation date.
 - All pre-installation work prior to delivery and installation of the system.
 - Final preparation and cleaning of the site prior to installation.
 - For better serviceability of the FB7600, a small 2-step ladder should be prepared, prior to installation, as shown below.

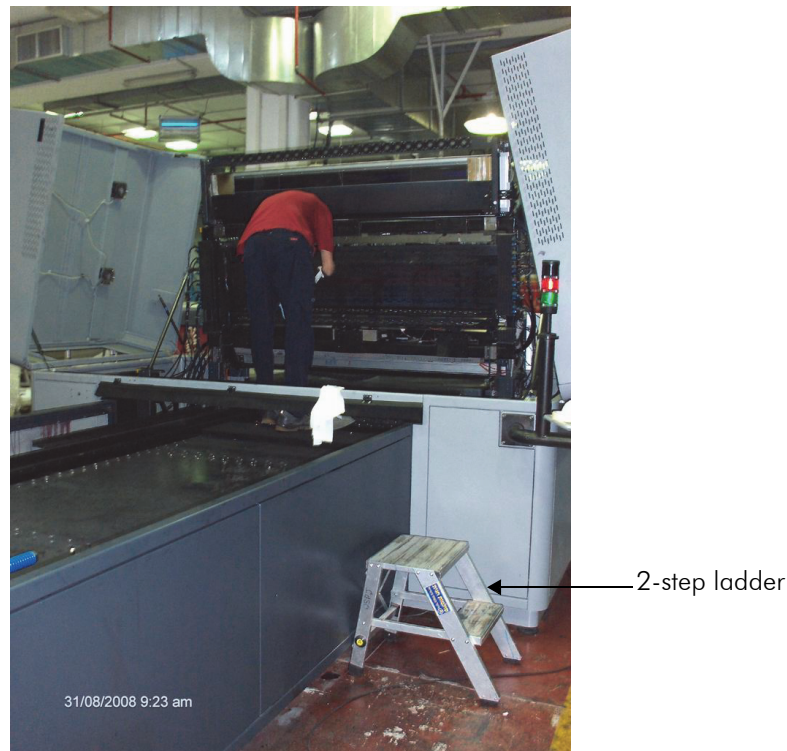

Figure 1-1 2-Step Ladder

Safety Information

About FB7600 Printer

The FB7600 printer is a sheet-fed UV industrial flatbed digital printing press. It is mainly composed of the main chassis, loading/unloading system, flatbed printing table, printing bridge, and UV curing system. The machine prints on sheet-fed media using UV ink.

There are two methods of loading substrate sheets: 3/4 Automatic loading and Manual loading. Before starting a print run, the machine operator selects the loading method in the machine software.

- **3/4 Automatic loading** - the substrates are placed by the machine operator on the loader table one by one and pushed towards the loader entrance.

The loader aligns and feeds the substrates onto the printing table. If there is more than one copy, the second substrate is placed immediately after the loader has returned to its home position, even if the first substrate is still being printed.

When the printing cycle is complete, the system automatically unloads the first substrate and stacks it on the unloader lift. Simultaneously, it feeds the second substrate onto the printing table.

- **Manual loading** - using the machine software, the operator moves the printing table to the manual loading position and manually places the substrate sheet on the printing table against the registration pins. The operator presses the red button; the system activates the vacuum to the printing table and lowers the registration pins.

The operator starts printing and after the print run is complete, manually unloads the substrate from the printing table.

Installation and disassembly of the machine should be done by HP service personnel only. Recycling and disposal should be done according to the local laws and regulations.

Although the product has been tested against safety standards that cover the intended use and the reasonably foreseeable misuse, the operator must avoid any misuse and always follow all the safety recommendation contained in this guide.

Maintenance and replacement of spare parts should be carried out only by HP service personnel, or by a person who has been trained and authorized by HP to maintain the machine.

Safe Operation Guidelines

The printer is designed and manufactured to ensure maximum safety operation. It should be installed, operated, and maintained by qualified users (authorized by HP Scitex) in strict compliance with the safety precautions, warnings, and operating instructions provided by HP Scitex.

General

- The HP Scitex FB7600 has been designed to meet the safety requirements applicable to printing equipment. However, anyone attempting to operate the system must be fully aware of potential safety hazards. See [Personal Safety – Working with the Printer](#) on page 25.
- HP Scitex is not responsible for any injury or damage to the machine caused by use of the machine other than its intended use as described in the manuals supplied by HP Scitex.
- The product should be installed, maintained, and serviced by qualified field service engineers (authorized by HP Scitex), in accordance with the information, procedures, and instructions provided by HP Scitex.
- The system in whole, or in part, should not be modified in any way without obtaining the prior written approval of HP Scitex.
- The owner should make certain that only properly trained, fully qualified personnel are authorized to operate and maintain the FB7600. An authorized operators list should be maintained. Unauthorized personnel should not be allowed access to the system.
- It is important that this, and all other HP Scitex FB7600 guides, should be kept close at hand, studied carefully, and reviewed periodically by the authorized technicians. However, the manufacturer or vendor of the equipment makes no representation that the act of reading this guide – or any other HP Scitex FB7600 guide – renders the reader qualified to operate, test, or calibrate the system.
- Authorized operators should wear buttoned-up shirt sleeves and closed shoes when operating the FB7600 printer.
- The HP Scitex FB7600 must have a dedicated power supply, which must not - under any circumstances - be used for additional equipment.
- Pipes and cables that connect the external components (such as the UV cabinet and the PDU) to the machine must be protected with a secure, metal cover of 170 mm height.
- Before performing any maintenance procedure, shut down the system and padlock the main power switch on the electrical cabinet in the **OFF** position.



Figure 1-2 Lock-out of the Main Power Switch

Electrical Shock Hazards

Danger



Internal circuits use high voltage, capable of causing serious injury. Do NOT dismantle the electrical cabinet, or attempt to remove or open system covers or plugs!

Danger



In case a local authorized electrician open the electrical cabinet, he should be aware that after turning off the main power switch on the electrical cabinet, some components inside of it stay energized (main circuit breaker, EMC filters, and distribution box phase connection). In the UV electrical cabinet, after turning off the UV main isolator, the main circuit breaker and EMC filters stay energized.

- Do not connect the printer to the main power switch unless all emergency switches are reset.
- When working with electrical components, make sure the printer is disconnected from the mains power supply.
- Place the printer on clean tiled or concrete floors. Anti-static carpeting or anti-static tiles reduce the hazardous accumulation of static charge near the printer.

- It is the customer's responsibility to ensure that electrical works comply with the local electrical code and the relevant laws and regulations. The customer should provide qualified and registered electricians to perform operations as required by these laws and regulations.
- In general, HP service personnel are authorized to perform maintenance operations in all printer's parts and subassemblies, but not for the site electrical infrastructure and printer's connections to this structure. Safe isolation of the printer from power prior to service operations shall be done according to local regulations, and is under the customer's responsibility.
- When servicing any electrical components, especially the vacuum pump cabinet or loader cabinet, turn off the main power switch and padlock it (see [Figure 1-2](#) on page 5).

Danger Only a certified electrician is authorized to carry out any electrical work.



Fuses blown within 36 hours of being replaced may indicate malfunctioning electrical circuits within the system. Have qualified service personnel check the system, and do not attempt to replace the fuse again!

Danger An electrical hazard may exist if any light, monitor, or visual indicator stays ON. To prevent possible injury, immediately turn OFF the switch in the mains power supply box on the wall.



Fire Hazards

UV-based inks used with the HP Scitex FB7600 have **flammable** and **irritant** properties. Their combustion products include oxides of carbon.

Danger Extreme care must be taken when handling inks and solvent to prevent the risk of fire. Do not permit smoking or naked flames in the print production or storage areas and ensure that warning signs (see [Figure 1-3](#) below) are prominently displayed in appropriate positions.



Figure 1-3 Warning Signs

Always keep two 6 kg fire extinguishers near each HP Scitex FB7600. Never use water to extinguish a fire! In the event of a fire, switch the electricity **OFF** before extinguishing the fire. Use a carbon dioxide fire extinguisher only.

Danger Conductive fluids that seep into the active circuit components of the system may cause short circuits, which can result in electrical fires. Therefore, do not place any liquid or food on any part of the system.



Explosion Hazard

Do not plug in or turn on power to the system if hazardous substances are detected in the environment. Should these substances be detected after the system has been turned on, do not attempt to unplug it, or turn off power. Evacuate and ventilate the area before turning off power to the system.

Danger



Extreme care must be taken when handling inks and solvent, to prevent the risk of explosion. Do not operate the system in the presence of explosive liquids, vapors, or gases. Keep all sources of ignition away from the printer and work area.

Provision for an Eye Wash Station



When installing the HP Scitex FB7600, it is important to provide an eye wash station and shower. If the system operator accidentally splashes ink or solvent into the eyes, he/she must be able to flush his/her eyes immediately with copious amounts of clean water or sterile eye-wash solution, and maintain flushing for a minimum of 15 consecutive minutes. In case ink or solvent splashes onto the skin, the operator should flush it using a shower. The provision of these facilities may help to reduce the risk of irritation and possible damage to the eyes and/or skin.

Eye wash facilities may be provided by plumbing a system into a specific area (reasonably close to the print production area), or installing a commercially available eye wash station. These facilities should be located at a distance of no more than 15 m (50 ft) from the print production area, and unobstructed access should be maintained at all times.

The services of a plumber will be required for installation of the types of eye wash fountains shown below (see [Figure 1-4](#)). Alternatively, commercially available eye wash products (eye wash bottles containing sterile solution or sealed flushing systems) may be used.

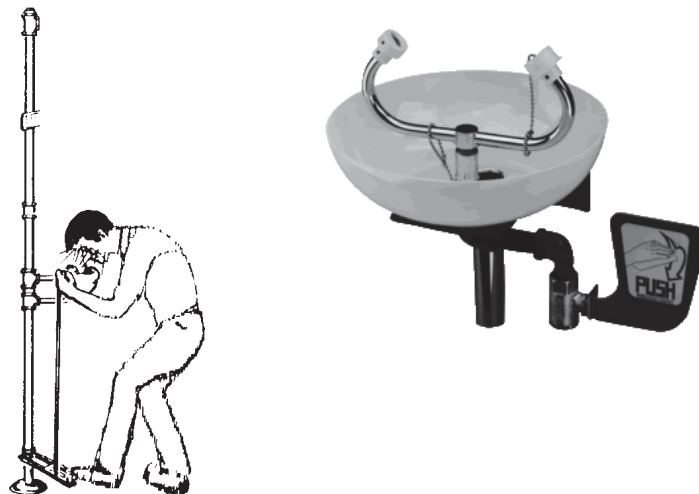

Figure 1-4 Eye Wash Fountains

Mechanical Safety

- Tools and loose parts, as well as loose sheets and paper scraps, must be removed from the machine before operation.
- Make sure no one is within the Danger Zone when operating the FB7600.
- Do not touch any moving parts.
- Do not put your hand in the machine during operation.
- Do not print on reflective materials.
- Do not neutralize or bypass the built-in safety systems, including the interlocks, safety controllers and SICK safety scanner.
- Machine contains moving parts that might cause severe injuries if contacted. Do not open fixed covers, unless authorized to do so and then only after removing the hazards from which the cover is protecting.
- The printing bridge tilt movement is still enabled when the hood covers are open, to allow its service. Bridge up/down command should be activated only after it is verified that there is no person in the nearest area. While the bridge is tilting, the operator should observe and ensure no one is entering the danger zones.

Measured Noise Levels

The table below indicates the measured noise levels at various locations around the machine during different states of operation.

Location	Operation	Standby Mode	Startup
Loader	78.2 dBA	63.2 dBA	83.2 dBA
Operator Stand	78.6 dBA	63.9 dBA	83.2 dBA
Unloader	78.6 dBA	72.2 dBA	83.2 dBA
Ambient	55.9 dBA		



Note The above noise levels were measured with the vacuum pump positioned near the machine.

Handling Inks and Solvent

Danger



UV-based inks used with the HP Scitex FB7600 have flammable and irritant properties. Their combustion products include oxides of carbon.

Reference



Refer to the MSDS for information on the inks and constituents:
<http://www8.hp.com/us/en/hp-information/environment/msds-specs.html>

Under normal conditions of anticipated use, with appropriate handling and adherence to the safety precautions, the materials used with the HP Scitex FB7600 do not present health hazards. However, when handling inks and solvents used with the FB7600, operators should always take the following precautions:



- Extreme care must be taken when handling inks and solvent, in order to prevent the risk of explosion.
- Do not operate the system in the presence of explosive liquids, vapors or gases.
- Avoid contact with skin and eyes and wear the safety goggles and gloves provided for protection against splashing. Do not handle inks or solvents when wearing only contact lenses without goggles.
- Wear respiratory protection (active carbon mouth filters) when pouring inks or solvents, or when cleaning the machine, in order to avoid inhalation of solvent fumes and vapors.
- Wear suitable clothing and shoes whenever in the print production and storage areas.
- Keep all sources of ignition far away from the printer and from the print production and storage areas.
- Make sure not to lift heavy loads that can cause you damages, use lifting accessories to avoid the risk. Such loads can be media piles and ink containers.
- Maintain good ventilation in the print production area.
- Ensure that the print production area is kept clean and organized.
- Store inks and solvents in tightly closed, upright containers in normal, cool warehouse conditions.
- Surfaces where any ink spillage or leakage has occurred must be wiped clean immediately.
- Avoid poisoning by washing hands before eating, after smoking, and before leaving the site.

Caution

Use only HP Scitex UV inks and solvents approved by HP Scitex.



- Do not plug in or turn on power to the system if hazardous substances are detected in the environment. Should these substances be detected after the system has been turned on, do not attempt to unplug it, or turn off power. Evacuate and ventilate the area before turning off power to the system.

Caution

Always make sure that all main ink tank lids are properly closed.



Cleaning with Solvent and Alcohol

In addition to the safety precautions listed above, it is recommended to observe the following precautions when cleaning FB7600 components with solvent (MF10) or alcohol (for example, ethanol):

- Apply solvent and alcohol to wiping paper or a lint-free cloth before starting to clean. Avoid applying solvent or alcohol directly to FB7600 components.
- Close the container and move it out of the vicinity of the FB7600. When a cleaning procedure that includes the use of solvent or alcohol is finished, make sure to do the following before resuming operation:
 - Dispose of any used paper or cloth that may contain traces of solvent or alcohol, according to local environmental regulations.
 - Operate the waste pump to empty the waste bath of any possible traces of solvent or alcohol.
 - Verify that all FB7600 components that have been cleaned with solvent or alcohol are completely dry before resuming machine operation.

Note



The use of solvent and alcohol is restricted in California, and may be restricted in other areas, due to its high VOC (volatile organic compound) content. Therefore, in these restricted use areas, you must first clean the component using a dry, lint-free cloth and compressed air. If any cured ink remains, it can be cleaned using a lint-free cloth moistened with solvent or alcohol (as specified in the chapters that follow).

Waste Disposal



Verify that a covered fireproof container, clearly labeled as hazardous waste, is available for disposal of waste solvent and ink.

This container must be electrically grounded during transfer of liquids into or from the container. If solvent-soaked rags or absorbents are used to clean the area, dispose of them in a closed fireproof container and label as hazardous waste.

Contact local fire safety, occupational safety and hazardous waste disposal regulatory agencies for information about specific storage and disposal requirements for wastes associated with the printer. Waste containers should not be discharged in sewers and are banned from landfills.

Danger Zone and Warning Labels

The Danger Zone around the FB7600 printing table is designated as shown in [Figure 1-5](#) on page 11. Upon installation of the printer, the Danger Zone will be clearly marked with yellow/black striped cautionary adhesive tape.

Danger



The Danger Zone is extremely hazardous when the printer is in operation and proper safety guidelines must be followed to ensure a safe work environment.

To prevent possible injury, the SICK programmable safety scanner (see [Unloader Lift Safety Frame](#) on page 25) is mounted on the rear left corner of the machine chassis. The SICK scans the Danger Zone and stops the print run and movement of all machine components when someone enters the SICK area during the printer operation.

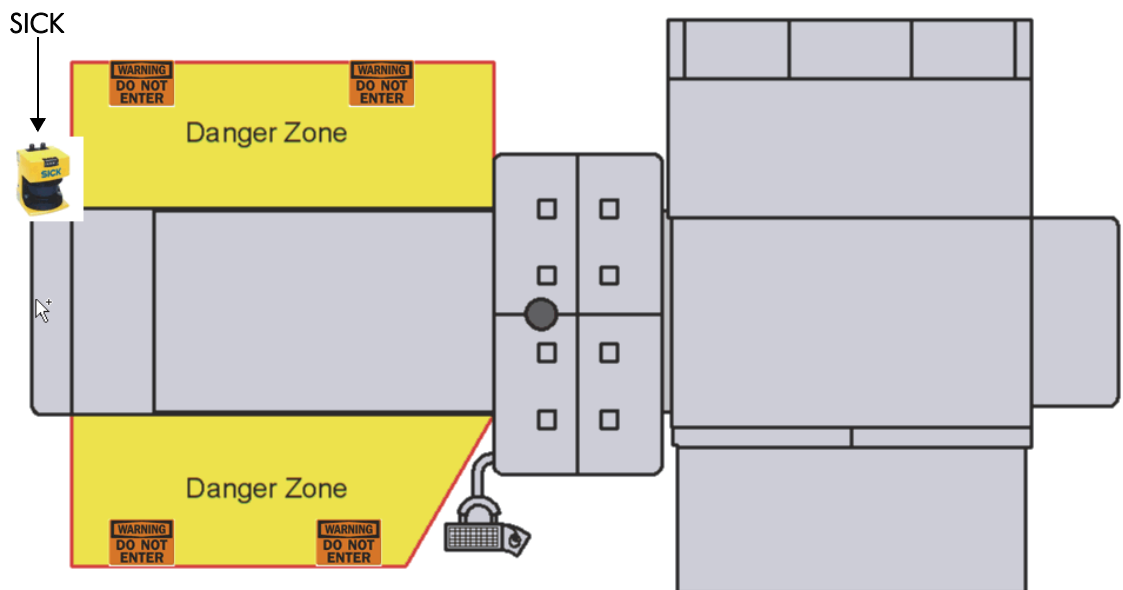

Figure 1-5 FB7600 Danger Zone



Figure 1-6 SICK Safety Scanner

Danger



To make sure no one enters the SICK area when operating the FB7600, the customer should install the "Do not enter!" warning labels as shown in [Figure 1-5](#) on page 11.

UV System Safety

Introduction

All equipment is designed and manufactured to International Safety Standards to ensure that the health and safety of the operator is protected at all times. This is conditional on equipment being installed correctly by qualified personnel and operating instructions being strictly adhered to.

Everyone who is required to work with the UV system in any way (including installers, operators, service engineers, and so on), must be made familiar with these safety instructions. The equipment is designed for the curing of UV inks. This equipment is not designed for use in hazardous areas (i.e. it is not flameproof). There are certain substances that can represent a safety hazard if not handled correctly.

High Voltage

The UV system works at high voltages. It is therefore essential that the operator switch the equipment off immediately should any fault develop.

Unless stated otherwise in this manual, the operator should not attempt to service the equipment, but should instead call a qualified electrician who is trained to service this type of equipment.

Fire Risk

With lamps running at 800 degrees Centigrade, there is always a risk of fire should any substrate be under or in the lamp vicinity, or in the event of a build-up of fluff, dirt or powder within the lamp housing.

Should such a situation occur, the operator must:

- Switch off the equipment immediately. If a fire extinguisher is to be used, make sure it is of a type which is suitable for use with electrical equipment, as described in [Fire Hazards](#) on page 6.
- A suitable fire extinguisher should be available near the unit.
- The equipment is fitted with high temperature lamps. It is not designed to operate close to low flash point materials (solvents, etc.).

UV Ink and Generated Products

The relevant safety data sheets from the ink manufacturer must be followed when handling UV inks.

The materials used in UV inks and varnishes are of a toxic nature. Before handling, it is essential all operators are conversant with the instructions provided by the supplier of these materials as to their safe use and disposal.

During operation, there is a possibility that an odor may be generated.

Noise

When the UV system is functioning, the auxiliary equipment, such as fans and coolers, produce noise. Noise levels can increase when the noise from the printing equipment is included in the readings. For more information, see [Mechanical Safety](#) on page 8.

Safety Precautions While Servicing

Important Information

Danger



This equipment operates at high voltage and is therefore potentially dangerous. All precautions must be taken in servicing this equipment. The equipment must be disconnected at the main circuit breakers before opening any of the access doors.

Shutting Down before Servicing

It is compulsory to shut down the UV system (see [Shutting Down the Entire UV System](#) on page 18) before performing the following service procedure:

- Cleaning the UV cooler water filter

In addition, it is compulsory to power down the machine **and** the UV system before performing the following service procedures:

- Cleaning the quartz plate
- Replacing the UV lamp
- Cleaning the UV lamp housing reflectors
- Replacing the UV lamp housing filters

Note



For information about performing these procedures, see the chapters that follow. For information about shutting down the machine.

Earth Leakage

This equipment is fitted with a high voltage leak detector circuit. If high voltage leaks to earth occur due to a fault, the leak detector detects the leak and switches off the equipment immediately.

The fault-finding circuit must be checked regularly, at least once a day, to ensure that it is functioning correctly.

Control System Cleaning

It is essential that all contactors and relays are kept clean and free of dirt and dust. These should be checked regularly, particularly in extremely dusty or powder-charged working rooms.

High Voltage Connections

Careful checks should be kept on the lamp connections and high voltage connections within the equipment head to make sure that these do not become dirty or coated with powder or other possible conducting material. They should be cleaned regularly (whenever the lamp is changed, and possibly more

often in a particularly heavily polluted atmosphere). Also, while changing the lamps, a careful check should be made of the high voltage leads to make sure that no deterioration has occurred. Dirty contacts may cause a potential hazard.

Danger



Accessing and cleaning electrical components must be done only after the machine has been shut down and disconnected from mains power.

High Temperatures

UV system operates at very high temperatures and the inside components become very hot during machine operation, which may cause personal injury. Therefore, when maintaining the equipment, a reasonable time (15 minutes) should be allowed before access is attempted.

Safety UV Curing

UV Radiation

UV radiation is generated from UV lamps and can be harmful if operator exposure exceeds recommended levels (see [Permissible UV Exposure Levels](#) on page 17).

Danger



To avoid exposure, always work with the UV flaps in the "up" position (see [Figure 1-7](#)).

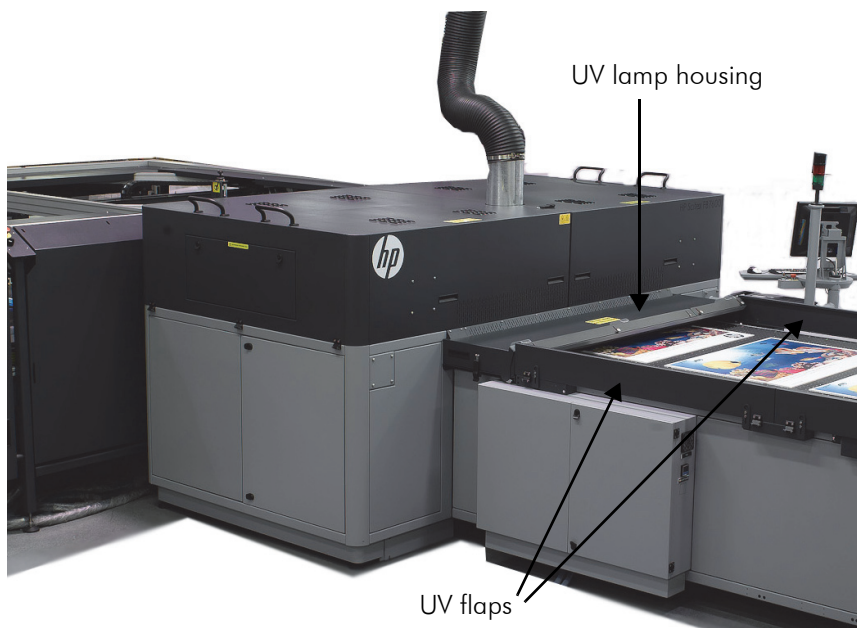

Figure 1-7 UV Flaps in the "Up" Position

All equipment is adequately guarded, shielded and interlocked to prevent accidental operator exposure.

Equipment should be annually checked for UV radiation levels.

Radiation is in the wavelength bands A, B, and C. Exposure to UV radiation can result in:

- Reddening of skin
- Headaches
- Sore eyes

If any symptoms appear, investigations should be carried out.

First Aid

Skin – No treatment can be made immediately. However, soothing cream can be applied to the affected area.

Eyes – For exposure, seek medical attention immediately.

Ozone Gas

Ozone is generated by the reaction of short-wave UV radiation with air. Ozone is a gas that readily reverts to oxygen when mixed with atmospheric air as it is removed from the source of UV radiation. The quantity of ozone produced equals 0.001 cu.ft/kW hr.

Ozone checks using a Draeger measuring device should be carried out every 6 months, or immediately if an operator can smell ozone.

Outlet duct concentration is 0.3 PPM in a typical system. The threshold limit value (TLV) is 0.1 PPM in a working atmosphere.

Precautions

Ozone has an irritant action on the mouth and throat and the Factory Inspectorate recommendation is that the level of ozone in the atmosphere of a factory should not exceed 0.1 PPM (TLV). Most people can smell ozone at about one third of the TLV.

If there is any doubt as to whether the TLV is being exceeded, the company should take measurements to check whether the extraction system is adequate to keep the atmosphere well below 0.1 PPM.

If ozone is detected:

- 1 Shut down the system.
- 2 Check the ducting for leaks.
- 3 Before restarting, check the working area with an ozone meter.

First Aid

If a person is overcome by ozone, take the following precautions:

- 1 Remove the patient to a warm uncontaminated atmosphere and loosen tight clothing at the neck and waist.
- 2 Keep the patient at rest.
- 3 If the patient has difficulty in breathing, oxygen may be administered provided that suitable apparatus and a trained operator are available.
- 4 If breathing is weak or has ceased, contact Emergency medical services immediately.
- 5 Seek medical aid.

Ozone poisoning should be treated symptomatically. This may include bed rest, analgesics to relieve pain, and antibiotics as may be prescribed by a medical practitioner.

Mercury

Mercury is a silver colored liquid which is contained in medium pressure mercury arc lamps. Under normal operating conditions mercury presents no hazard as it is contained in the quartz tube of the lamp. Mercury is toxic and must not be consumed or handled directly on the skin. It is recommended that protective gloves and eye protection is worn when handling UV lamps.

In the event of spillage:

- 1 Use personal protective equipment to protect the eyes and skin, and prevent ingestion and inhalation.
- 2 Contain the spill with wet sand and clean it up with a dustpan and brush. Do not use a vacuum cleaner, as it will become contaminated and be a source of mercury vapor.
- 3 Spread a 50/50 mix of calcium hydroxide and sulphur over the affected area and allow to dry. Repeat until there is no visible trace of mercury. Special attention should be given to cracks and imperfections in the affected surface.

First Aid

- Eyes – Flush with plenty of water for 15 minutes, occasionally lifting the eyelids. OBTAIN MEDICAL ATTENTION.
- Skin – Flush with plenty of soap and water for 15 minutes. Remove contaminated clothes and shoes. OBTAIN MEDICAL ATTENTION.
- Ingestion – OBTAIN MEDICAL ATTENTION.
- Inhalation – OBTAIN MEDICAL ATTENTION.

Lamp Disposal

Sensible precautions should be followed when disposing of mercury arc lamps.

- 1 Insert the old lamp in the tube provided with the new lamp, seal and repack in the box provided.
- 2 Dispose of the lamp using an approved waste management company or refer to your local authority.

Permissible UV Exposure Levels



Danger To avoid exposure to UV radiation, always turn off the UV system (see [Shutting Down the Entire UV System](#) on page 18) if any of the machine covers is opened for more than six minutes.

Table 1. Permissible Ultra Violet Exposures As Recommended By The American Conference Of Government And Industrial Hygienists

Duration of Exposure (per day)	Effective Irradiance E Micro Watts/cm sq.
8 hours	0.1
4 hours	0.2
2 hours	0.4
1 hours	0.8
30 minutes	1.7
15 minutes	3.3
10 minutes	5.0
5 minutes	10
1 minute	50
30 seconds	100
10 seconds	300
1 second	3000
0.5 seconds	6000
0.1 seconds	30000

Permissible exposure time in seconds for exposure to actinic ultra-violet radiation incident upon the unprotected skin or eye may be determined with reference to table above, which provides exposure times corresponding to effective irradiance in micro watts/cm².

Shutting Down the Entire UV System

The entire UV system must be completely shut down before all procedures which involve exposing internal electrical components.

To perform a complete shut down of the UV system:

- 1 From the UV electrical cabinet, turn the main isolator to the **OFF** position.



Figure 1-8 UV Main Isolator turned OFF

- 2 Padlock the main isolator in the **OFF** position, as shown in Figure 1-9.



Figure 1-9 UV Main Isolator locked in the OFF position

Danger



To prevent accidental turning on of the main isolator, it is essential to lock the isolator in the OFF position.

Environmental Notices

Battery Disposal (California)

Attention California users: This product's real-time clock battery or coin-cell battery may contain perchlorate and may require special handling when recycled or disposed of in California.

See <http://www.dtsc.ca.gov/hazardouswaste/perchlorate/>

Use of Sensitive Receivers

The use of sensitive radio communication devices (receivers) operating in VHF band (180 MHz) should be avoided within **30 meters** on all sides of the HP Scitex FB7600 printer.

First Aid Treatment

The following guidelines are recommended in the event of first aid measures being required:

Inhalation

Move the operator to fresh air immediately. If there is respiratory distress, administer oxygen and seek medical attention.

Eye Contact

Rinse immediately with copious amounts of water. If redness or soreness persists, seek medical advice.

Skin Contact

Wash the affected area with soap and water. Seek medical advice in the event of ensuing dermatological problems.

IEC Symbols

The system may have labels with one or more of the following symbols attached.

These symbols indicate the IEC standards to which the HP Scitex industrial presses.

Table 1-1 IEC Symbols







Symbol	IEC Standard
	Alternating Current
	Protective Earthing Point
	Functional Earth Ground

Table 1-1 IEC Symbols

Symbol	IEC Standard
	Danger, Caution - consult accompanying documents
	Electrical Shock Hazard
	UV Radiation

Safety Warning Labels

Various safety warning labels are affixed to the HP Scitex FB7600 in prominent positions. Table 1-2 shows a list of the system's safety warning labels, indicating the description and locations of each one.

Table 1-2 Safety Warning Labels



Label	Description	Location
	Electrical hazard warning. Indicates a potentially hazardous situation which, if not avoided, could result in death or serious injury.	<ul style="list-style-type: none"> • Electrical cabinet • Water pump
	<p>Hazardous Voltage/High Voltage/Electrical Shock Hazard:</p> <ul style="list-style-type: none"> • Hazardous voltage/high voltage behind this door/panel. • Do not operate machine with doors opened or panel removed. • Turn off main power, lock out/tag out before servicing machine. 	<ul style="list-style-type: none"> • On all cabinet doors containing hazardous voltage components • On all hazardous voltage components covers • On all high voltage components covers • On high voltage components
	<p>Hot surface - Do not touch:</p> <ul style="list-style-type: none"> • Risk of burning/scalding. • Do not touch. • Allow time to cool down after turning power off. 	<ul style="list-style-type: none"> • On UV lamp enclosure • On UV system parts

Table 1-2 Safety Warning Labels











Label	Description	Location
	<p>Authorized personnel only:</p> <ul style="list-style-type: none"> • Risk behind this door/cover • Do not open • Access by authorized personnel only 	<ul style="list-style-type: none"> • On UV electrical cabinet doors and covers • On electrical cabinet door • On ink cabinet door • On BLSC cabinet doors • On bridge covers • On loader cabinet door
	<p>Read Documentation: Indicates a potentially hazardous situation which, if not avoided, could result in death or serious injury.</p>	<ul style="list-style-type: none"> • Operator station
	<p>Crushing hazard from moving parts/belts:</p> <ul style="list-style-type: none"> • Hands injury risk • Hand entanglement • Moving parts can crush and cut • Stay clear while operating the machine • Do not remove guards 	<ul style="list-style-type: none"> • Near belt and pulley on the printing bridge
	<p>Crushing hazard between moving parts/multi-sheet loader table:</p> <ul style="list-style-type: none"> • Hands injury risk • Hand entanglement • Keep hand away from pinch point when folding/unfolding ML table 	<ul style="list-style-type: none"> • On ML table
	<p>Safety ground connection</p>	<p>Various locations throughout the machine, such as the main grounding bus bar</p>
	<p>Main earth - caution: Disconnecting main earth may cause electric shock.</p>	<ul style="list-style-type: none"> • Electrical cabinet • Loader pneumatic panel • On the machine chassis, under the bridge
	<p>Emergency Stop (EMS): Indicates the Emergency Stop button, which immediately cuts off the power for the motion and UV systems.</p>	<p>Around each Emergency Stop button (4 locations):</p> <ul style="list-style-type: none"> • Operator arm • Loader frame • Unloader frame (2)

Table 1-2 Safety Warning Labels

Label	Description	Location
	Emergency Stop (EMS): Stops motion when activated.	<ul style="list-style-type: none"> Above Emergency Stop button guards (ML table)
	Flammable liquids: <ul style="list-style-type: none"> Do not smoke Do not use open flame 	<ul style="list-style-type: none"> Near ink containers
	Tripping/falling hazard: <ul style="list-style-type: none"> Do not step/Climb the bridge upper hoods 	<ul style="list-style-type: none"> On the printing bridge upper hoods
	Tripping/falling hazard: <ul style="list-style-type: none"> Do not stand on the bridge upper hoods 	<ul style="list-style-type: none"> On the printing bridge upper hoods

Emergency Safety Devices

The HP Scitex FB7600 is fitted with the following types of emergency safety devices:

- PILZ safety controller
- Emergency Stop buttons
- Service key
- Safety interlocks
- SICK safety scanner
- Unloader lift safety frame

The operator must be familiar with the location and operation of each type of safety device. Emergency safety devices must be accessible at all times.

Danger



Emergency Stop safety devices must not be connected to the UPS. All safety devices fitted to the HP Scitex FB7600 must be maintained and tested on a regular basis.

Emergency Stop Buttons

The Emergency Stop buttons on the FB7600 printer (total of 4) are located on the operator arm, on the loader frame (right side), and on the unloader frame (one on the right and one on the left side).

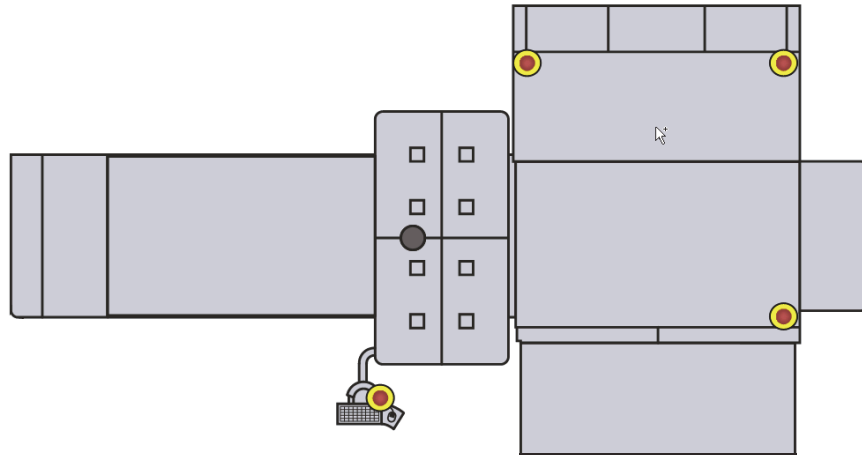

Figure 1-10 FB7600 Emergency Stop Button Locations

If any of the emergency switches is activated, the electrical cabinet output voltage is cut for the motion system (except for the NIP motor) and for the UV system.

The following warning message appears on the operator console:

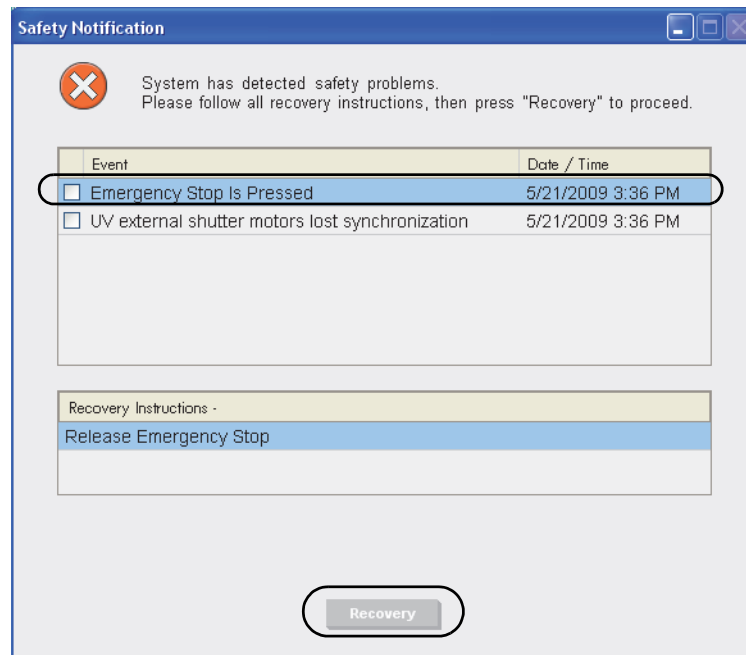

Figure 1-11 Emergency Stop Warning Message

To resume printing, release the Emergency Stop button and click **Recovery**.

Important



The Emergency Stop buttons should be used only in case of emergency.

Service Key

The Service key (see [Figure 1-12](#)) is an Emergency Stop button with an additional feature. When the key is removed, the emergency mode cannot be canceled accidentally until the key is returned.

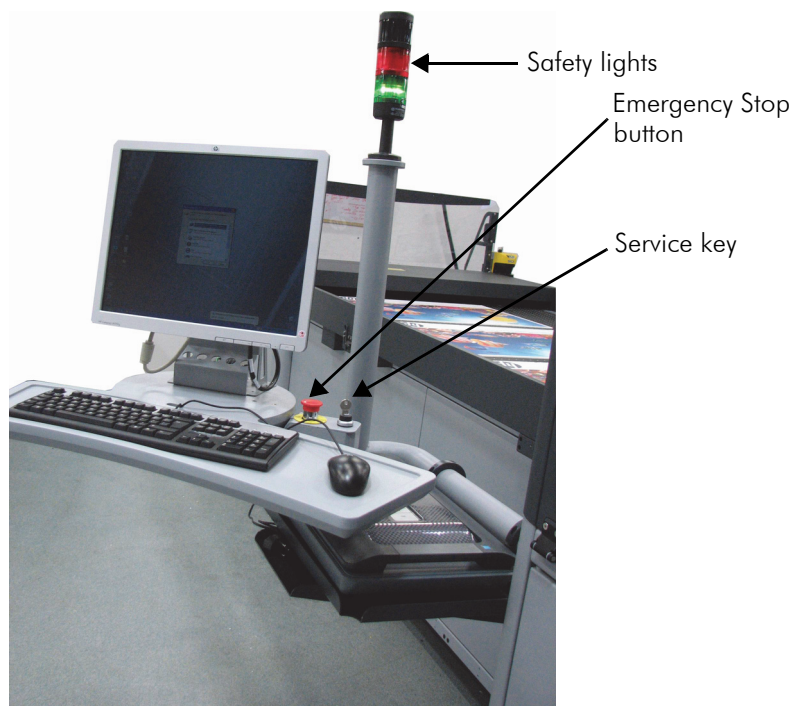

Figure 1-12 Emergency Safety Devices on the Operator Station

Unloader Lift Safety Frame

The Safety Frame is located in the bottom of the unloader lift, around the perimeter (see Figure 1-13).

Any contact with the Safety Frame activates the safety switch and stops the lift.



Figure 1-13 Unloader Lift Safety Frame

Personal Safety — Working with the Printer

Take the following precautions when working with the printer in order to ensure your personal safety:

- All personnel must read and understand this manual, and be alerted to the potential hazards indicated by the safety labels before operating this printer.
- Only a trained and authorized person is to be permitted to service and operate this printer.
- Training should include instruction in printer operation under normal conditions, and how to stop and turn off the printer in emergency situations.
- Never access the internal parts of the printer for any reason until you have switched off the Service key on the operator station.
- Always turn off and padlock the main power switch while you are on top of or inside printer. Always place a "Do Not Touch Printer" sign on the operator station when working on the printer.
- Always turn off and padlock the main power switch when servicing the printer's electrical components.
- When servicing inside the printer (media loading/unloading, paper jam, or other activities), use the Service key on the operator station.

- Never change or override the function of the printer's electrical interlocks or other "shutdown" switches.
- Before starting the printer, verify that all persons are outside the Danger Zone of the printer, and that the printer is free of paper scraps, wraps, and jams.
- Do not operate the printer with uncovered long hair, loose clothing, or jewelry, as these may get entangled in the printer.
- Keep the areas around the printer's loading and unloading points clear of obstructions that could endanger personnel.
- Do not alter the safety characteristics of this equipment under any circumstances.
- Perform routine inspections and corrective/preventive maintenance measures on the printer to ensure proper operation and safety.
- Never clean or service the printer while it is operating.
- Never look directly at the UV light source.
- When servicing the UV lamps, allow the lamps ample time to cool first, as the UV lamp units can burn the skin.
- Avoid smoking, eating, or drinking within the print production area.
- Follow the fire prevention precautionary methods described in this chapter.
- While the printer is operating, always stand at the operator station. Do not approach the printing area, and keep your hands far from all moving parts.
- While the printer is operating, certified operators and HP Scitex FSEs only are permitted in the print production area.
- While loading and unloading heavy materials, wear steel-toed safety boots.
- Do not operate the printer while under the influence of drugs or alcohol.

Site Preparation Requirements

System Components

Table 1-3 Dimensions and Weight of HP Scitex FB7600 System Units

Crate	Unpacked LWH	Packed LWH	Weight Unpacked/Packed
Main frame (without covers)	10.5 x 2.35 x 1.45 m 34.5 x 6.3 x 4.3 ft	10.7 x 2.4 x 2.34 m 35.1 x 7.9 x 7.7 ft	5560/7000 kg 12258/15432 lb
Main Electrical Cabinet (PDU)	1.8 x 0.55 x 1.95 m 5.9 x 1.8 x 6.4 ft	2.01 x 0.76 x 2.1 m 6.6 x 2.5 x 6.9	678/785 kg 1495/1731 lb
UV System Electrical Cabinet	1 x 1 x 1.8 m 3.3 x 3.3 x 5.9 ft	1.06 x 1.12 x 2.15 m 3.5 x 3.7 x 7.0 ft	426/546 kg 939/1204 lb
UV Cooler	1.8 x 0.65 x 0.8 m 5.9 x 2.1 x 2.4 ft	2.0 x 0.88 x 0.98 m 6.56 x 2.88 x 3.2 ft	135/265 kg 298/584 lb
UV Blower	0.85 x 0.6 x 2 m 2.7 x 1.9 x 6.6 ft	0.96 x 0.76 x 1.0 m 3.15 x 2.5 x 3.3 ft	90/140 kg 198/308 lb
Vacuum Pump	1.52 x 0.9 x 1.27 m 4.99 x 2.95 x 4.17 ft	1.68 x 1.14 x 1.56 m 5.5 x 3.7 x 5.1 ft	367/485 kg 809/1069 lb
Loader Table and Accessories	N/A	3.60 x 1.91 x 1.09 m 11.8 x 6.3 x 3.6 ft	430/700 kg 948/1543 lb
Unloader Lift	3.2 x 1.60 x 0.3 m 10.5 x 5.25 x 0.98 ft	3.38 x 1.75 x 0.66 m 11 x 5.7 x 2.2 ft	TBD/1053 kg TBD/2321 lb
Media	TBD	3.25 x 1.7 x 0.5 m 10.7 x 5.6 x 1.6 m	430/500 kg 948/1102 lb
Multi-Sheet Loader Table (optional)	3.27 x 1.38 x 0.9 m 10.73 x 4.53 x 2.95 ft	3.76 x 1.51 x 1.30 m 12.34 x 4.95 x 4.27 m	TBD/900 kg TBD/1984 lb

Floor Surface and Strength

Note



The customer is strictly responsible for surface and load-bearing compliance.

When planning the print production area, it is important to ensure that the floor surface is solid, smooth, level, and free from any holes or indentations.

Floor covering material must be non-flammable, durable and easy to clean.

The floor of the print production area, as well as that on machine's way from the unpacking area, must be strong enough to support the entire weight of the printer, including all accompanying equipment.

Floor load-bearing capabilities for the building in which the FB7600 printer is to be installed require consulting a construction engineer.

Note



Installation of the machine loader requires drilling eight (8) holes into the floor.

The following information is provided to assist the engineer:

- The floor must be strong enough to support the machine, loaded with 300 kg, while standing on its 6 supporting pads.
- The machine weight is 5560 kg (12258 lb).
- The vacuum unit weight is 367 kg (809 lb).
- A single supporting pad foot print is 115 x 115 mm (4.5 x 4.5 in.)
- The floor must be leveled with a maximum incline of 0.2%.

Danger



If the floor surface in the print production area is to be tiled, the tiles should be firmly cemented into position with tile cement applied to the full area of each tile base (and not just in the center). Tiles must be non-flammable (made of marble, stone, etc.).

Wood flooring is not allowed. So you can keep the tiles section, just mention the tiles must be non-flammable.

Failure to do this may not provide adequate support to heavy system components and could result in personal injury or damage to the printer during installation.

Electrical Requirements



This section provides the electrical specifications of the HP Scitex FB7600 printer. Every system may be adapted to the mains power voltage of the country of installation.

- As a safety precaution, the FB7600 printer should be hard wired to a wall-mounted circuit breaker (or PDU). This outlet should be suitably rated to meet the power requirements of the FB7600 printer, and should be in accordance with the wiring standards of the country of installation.
- All electrical cables that are stretched between the PDU and the machine components should be protected against mechanical hazard using suitable protection.

- Table 1-4 and Table 1-5 on page 29 show the electrical requirements and power consumption of the FB7600 system.
- Figure 1-14 shows the recommended power connection of the FB7600 system.
- A dedicated power outlet should be provided for the White Ink Backup unit located in the BLSC cabinet (see Figure 1-14).



Note: In case that the system is powered by a generator, electrical requirements are the same as for the mains.

- In countries where voltage is lower, a **suitable step-up transformer** must be used.
- In countries where voltage is higher, a **suitable step-down transformer** must be used.



Important It is the responsibility of the customer to contact a local authorized electrician to prepare the site with the proper wiring, circuit breakers, fuses (and power transformer if necessary), and then to connect the HP Scitex FB7600 system to the mains power outlet.

Table 1-4 Electrical Requirements

Unit	Connection type	Voltage input	CB Rating	Power Line Ø
Printing unit	5-wire connection, 3 + N + G	380 - 480 V between phases, 50/60 (±3 Hz)	3 x 40 A	6 AWG
UV system	4-wire connection, 3 + G	380 - 480 V between phases, 50/60 (±3 Hz)	3 x 160 A	1/0 AWG

Table 1-5 Power Consumption

Unit	Nominal	Maximum
Printing unit	30 A, 17 kW	30 A, 17 kW
UV system	68 A(*), 25 kW	120 A, 40 kW

(*) This is the measured average/nominal power consumption while using the default UV power setting. In case a user changes the default setting, the nominal power consumption may increase by up to 40%.

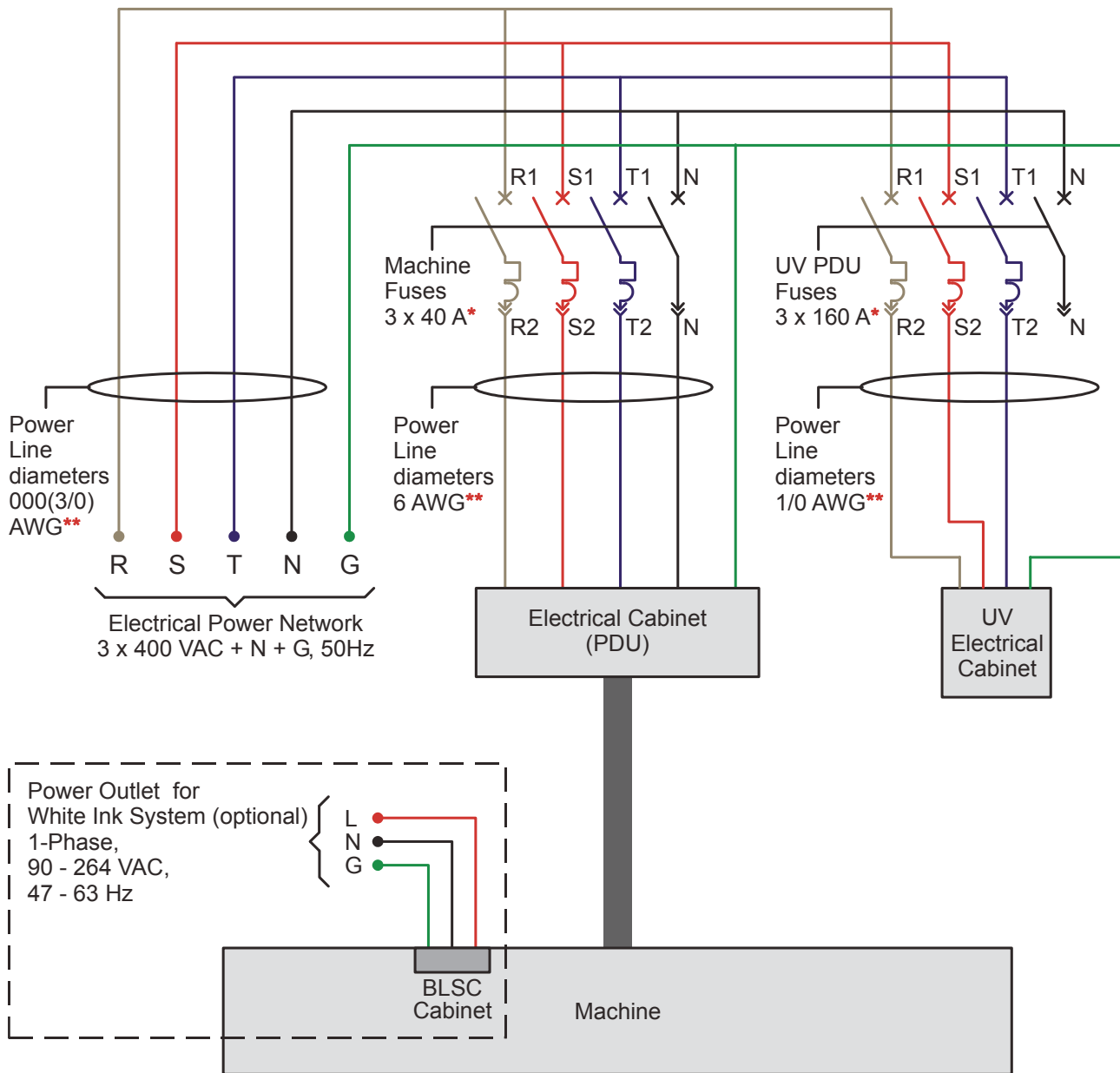

* The indicated currents and wire diameters are the HP-recommended ratings for circuit breakers. For actual power usage values, refer to Power Requirement tables. To determine the suitable circuit breaker and fuse ratings for your site, you must consult your local authorized electrician.
 Recommended standard fuse types: A Type or B Type gG Curve

** All cables for main, machine and UV inline should be supplied by the customer. Power line length and diameters should be calculated according to the system final position from the electric supply line.

Figure 1-14 FB7600 Recommended Power Connection

Power Line Disturbances

- Reliable operation of the FB7600 computer system depends on the availability of relatively noise-free AC power.
- Lighting, line faults, or the power switching commonly found in machinery in factory environments can generate line transients that far exceed the peak value of the applied voltage. If not reduced, these microsecond pulses can disrupt system operation.
- Voltage transients must be tested when all machinery and air-conditioning equipment are operating normally and the FB7600 system is turned on. Voltage spikes should not exceed +5 or -10%.
- All potential noise-generating equipment (e.g. fans, fluorescent lighting and air-conditioning systems) must be kept separate from the power source used for the FB7600 printer.

Surge Protection

- The end-user facility should provide the proper surge protection, which will be suitable for their specific installation.
- In order to ensure optimum performance and reliability, the FB7600 printer should be protected from variations in line voltage, which are common to production printing environments. Power lines should be regulated accordingly, using a dedicated power conditioning unit, unless the lines are centrally regulated. The air-conditioning unit should include a surge protector in order to avoid lightning damages.

Grounding

The FB7600 printer must be connected to a special ground line in order to protect the operator and the printer and minimize electrostatic affects.

Grounding equipment for the FB7600 printer and all connecting equipment must be installed to ensure smooth and trouble-free operation.

The following grounding requirements must be fulfilled:

- Grounding wires should be insulated and at least equal in size to the phase conductors.
- Ground impedance must be less than 0.1 ohms.
- The installation of a single point and dedicated ground.
- Power stabilizer equipment that is supplied by three uninterrupted phase wires and one uninterrupted copper ground wire from the main building service panel. These should run in the same conduit and should be at least equal in size to the phase wires.

Pneumatic Requirements

The supply of compressed air to the HP Scitex FB7600 printer may be by way of a central air supply system, or with the use of a dedicated air compressor. In either situation, a wall-mounted air outlet will be required. This should have a quick-coupler fitting and be located near the FB7600 printer.

Air Compressor

Air compressor requirements:

Operating pressure: 6 - 8 bars (88.2 - 117.6 psi)

Flow rate: Minimum of 1200 liters/ min (43 CFM)

Air cleanliness: The air should be filtered to 5 microns before reaching the FB7600 printer.

Reservoir size: 400 lit.

Air Dryer

An air dryer is required to ensure that the supplied air to the system is moisture free.

Air dryer requirements:

Operating pressure: 6 - 8 bars (88.2 - 117.6 psi)

Flow rate: Minimum of 1200 liter/ min (43 CFM) at 6 - 8 bars (88.2 -117.6psi)

Dew point: 2°C (35.6°F)

Environmental Requirements

Lighting



Whenever the FB7600 printer is in operation, the print production area should be well illuminated to provide the operator with optimal conditions for checking print production (color, alignment, etc.).

If there is insufficient natural light, the installation of supplementary artificial lighting will be required.

Caution



To avoid curing of the ink while the bridge is in vertical position (during maintenance), the following guidelines are recommended:

- Do not position a light source directly above the printing bridge. If there is one directly above the printer, it should be turned off while the bridge is in vertical position for more than a few seconds.
- The power density of a light source above the bridge should not exceed 3mW/cm².
- Sunlight is a real risk in case there is an open window that allows direct sunlight into the room and towards the exposed bridge. Make sure that such windows are shut.

In general, if the bridge is left in vertical position for more than a few moments, it should be covered.

Temperature and Humidity

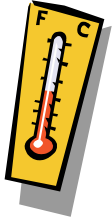

Temperature and humidity, both in the print production and in the storage areas can affect the print output results. If not maintained within the recommended values, as shown below, they may have an adverse effect on the print quality and/or damage sensitive electronic devices in the system.

The following factors should be considered and submitted to the air-conditioning engineer to assist in designing the climate control unit:

- Room construction and layout
- Heat emission produced by the heat emitting elements in the production room
- FB7600 printer, UV lamp and power supply
- Vacuum pumps - if located within the print production area
- Other heat emitting devices such as lights and other machines
- Number of persons in the print production area
- Air extraction from the production room by the ventilation and fume extraction hood

Print Production Area

Room temperature: 15 - 30°C (59 - 86°F)

Relative humidity: not less than 50% Rh



Note

In order not to interfere with the SICK safety scanner operation, the humidifiers in the production area should be positioned not closer than 10 m away from the printer's Danger Zone (see [Figure 1-5](#) on page 11).

Caution



Very low relative humidity increases the risk of damage to sensitive electronic devices caused by Electrostatic Discharges (ESD). Excessive humidity may also cause corrosion problems and moisture contamination within the equipment.

Ventilation and Fume Extraction



Exhaust Fan

To prevent the accumulation of hazardous vapors, sufficient ventilation must be provided by the customer to exchange the air in the area surrounding the FB7600 printer. The FB7600 printer is equipped with a built in fume extraction system but nevertheless the customer must ensure that the site and, in particular, the area surrounding the FB7600 printer complies with all applicable local legislation and guidance relating to ventilation and HP recommends a minimum of **4 air changes per hour** within a 4 meter area surrounding the printer. Detailed air ventilation designs are based on site specific information and equipment. The customer should consult a ventilation/fume extraction professional familiar with local workplace and environmental legislation and guidance.

Reference



Refer to the MSDS for information on the inks and constituents:

<http://www8.hp.com/us/en/hp-information/environment/msds-specs.html>

UV Blower

The UV blower with its silencer is supplied with the FB7600 system.

Fumes produced during the ink curing process as well as ozone and heat produce by the UV lamp should be extracted from the production area, using an adequate UV blower. The silencer dimensions: 12" (300 mm) diameter, 47.2" (1200 mm) length.

The UV blower should be positioned inside the building as far as possible from the printer. The maximum distance is 15 m (see on page 32).

The customer should provide a **10" (250 mm)** sealed rigid duct from the UV blower to the outside atmosphere (out of the building) or to the site central extraction system.

Delivery Instructions

Unloading and moving the HP Scitex FB7600 printer and all system components is the responsibility of the customer.

The system should be delivered to certified HP service engineers/installers, unless otherwise notified by the your local Installation Manager.



Do not unload and/or unpack the system without the presence and approval of the HP Engineer/Installer. Delivering, unloading and conveying the FB7600 system should be performed by a minimum of four persons, provided by the rigging company.

The HP Scitex FB7600 system (including accessories and media) is delivered to the customer site in a total of 9 crates. For dimensions and weights of all crates, see [Table 1-3](#) on page 27. The largest crate, which contains the machine's main frame, is delivered on an open flatbed truck. The rest of the crates arrive in a closed truck with a box trailer.

Required Tools and Equipment

- **Crane accessories** - including steel beam, chains, heavy duty straps, etc., as shown in [Figure 1-15](#).

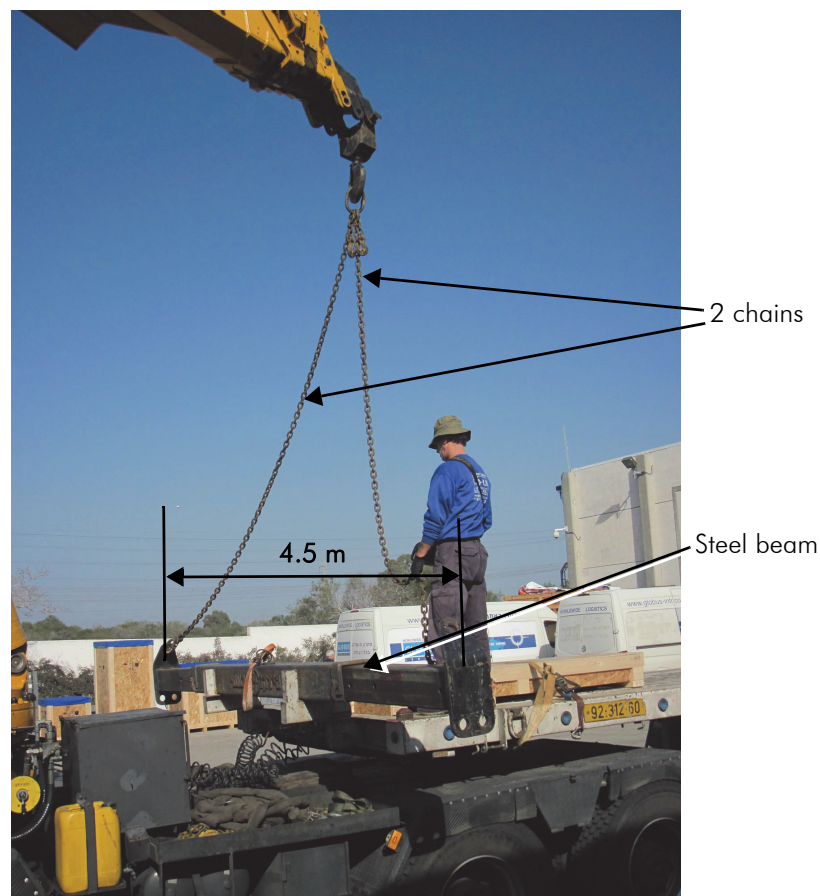

Figure 1-15 Crane Lifting Accessories – Steel Beam and Chain

Chain specifications:

- Lifting capacity of each chain - minimum 8.2 tons
- Link diameter - 16 mm

Important



Chains must be attached to the ends of a beam and not to its middle so that a beam will be compressed rather than bent.

Steel beam specifications:

- Lifting capacity - 9 ton
- Length - 4.5 m
- A beam can be manufactured from (3 options):
 - Rectangular profile 10x10 cm, thickness minimum 5 mm
 - Rectangular profile 12x8 cm, thickness minimum 5 mm
 - Profile IPN (Double I), 18 cm height

Heavy duty straps:

- Four (4) 3-meter straps, lifting capacity 5 tons each one
- 9 shackles, lifting capacity 6.5 tons

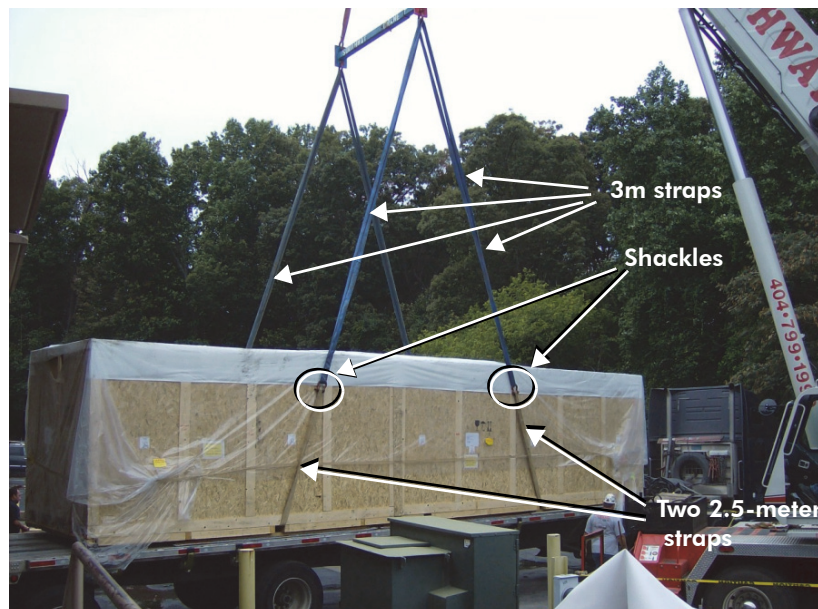

Figure 1-16 Lifting the Crate

The unpacked machine should be lifted using the **eyebolts** located on the machine chassis.

Unloading the Main Machine Frame Crate

Note Prior to arrival, mark the printer final position using masking tape.



The main machine frame crate is delivered on a flatbed truck, as shown in Figure 1-17.



Figure 1-17 Flatbed Truck Delivering the Main Machine Frame Crate

A heavy duty crane with a steel beam and straps wrapped around the crate should be used to lift the main machine frame crate off of the flatbed truck.

Caution It is strictly forbidden to use a forklift to lift the main machine frame crate at any time!



The only way to lift the machine crate is to use the crane with accessories.

The forklift can be used to lift the other remaining smaller crates.

Figure 1-18 through Figure 1-20 show the process of lifting the main frame crate.



Figure 1-18 Heavy Duty Crane with a Steel Beam and Straps



Figure 1-19 Crane Ready to be Lifted



Figure 1-20 Lifting the Crate with the Heavy Crane

The main machine frame crate can be unpacked outside or inside the building, depending on the weather conditions.

Once lifted, the crane can place the machine either the ground (if the machine is unpacked outside) or into the building (for unpacking inside). When unpacking inside the building, dollies should be used to move the crate to the desired position.

Before unloading the main crate, three pairs of dollies and one dolly with arm should be positioned underneath the crate, as shown in Figure 1-21.

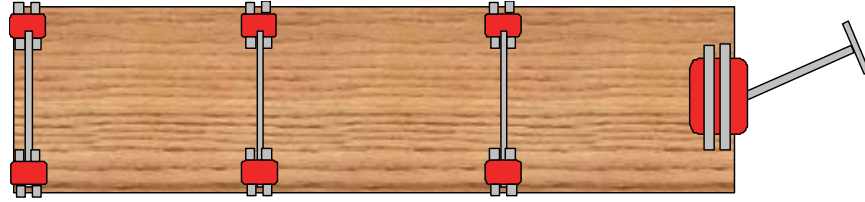

Figure 1-21 Positioning Dollies Underneath the Main Crate (Bottom View)

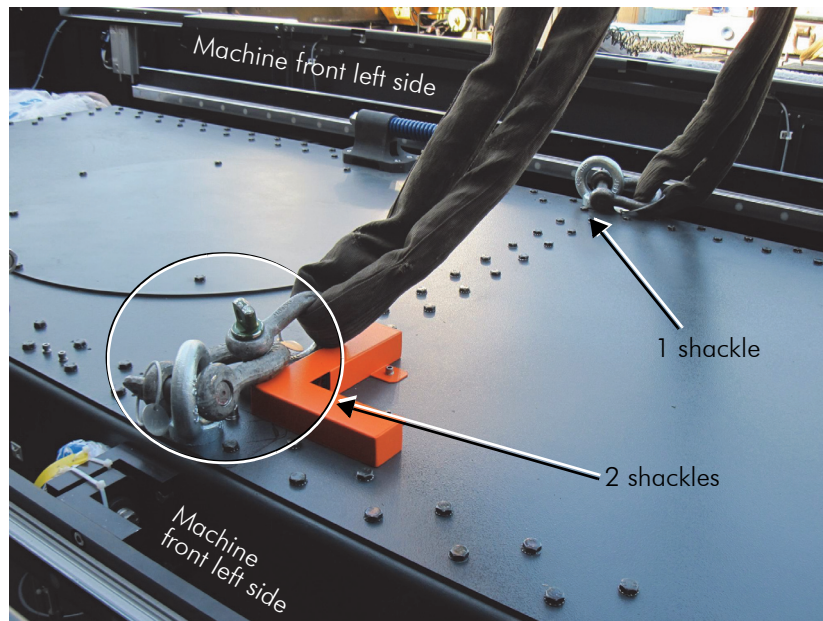

Figure 1-22 Lifting the Unpacked Machine with Crane and Accessories, Using Four Eyebolts

Caution It is strictly forbidden to use a forklift to lift the machine frame at any time.



The only way to lift the uncrated machine is by using the crane with accessories and lifting it by the four dedicated eyebolts (attached to the machine).

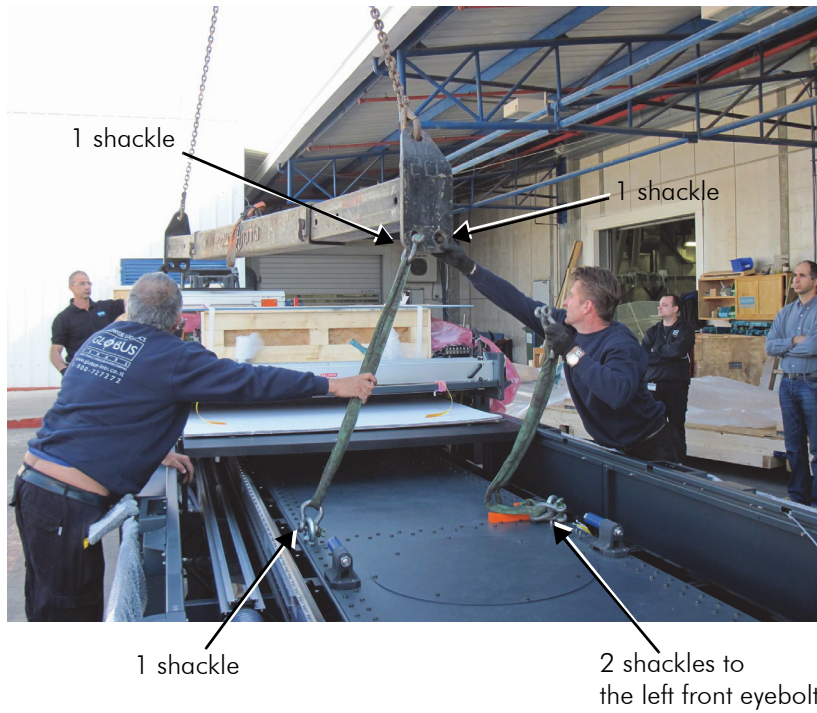

Figure 1-23 Lifting the Unpacked Machine

FB7600 Maintenance

Table 1-6 FB7600 Maintenance Procedures

Maintenance	Procedures
Daily	Visual Checks and General Cleaning Checking the Pneumatic System Monitoring the Ink Level in Ink Containers Emptying the Waste Tank Testing Earth Leakage in the UV Electrical Cabinet Checking the Water Level in the UV System
Weekly	Cleaning the Printing Table 70 Cleaning the Quartz Plates in the UV Lamp Housing Checking the Loading/Unloading Suction Cups Cleaning the Rising Media Flaps Manually Wiping a Print Head Cleaning the Printing Bridge Cleaning the Guards Cleaning the Cooling Fans and Surroundings Cleaning the Vacuum Knife Emptying the Separator Bath Checking the HT Contactors Counter in the UV System
Monthly	Replacing the UV Lamp Cleaning the UV Lamp Reflectors Cleaning the UV Cooler Water Filter Cleaning the UV Cooler Radiators Cleaning the UV Lamp Housing Filters Checking for Leaks in the UV Cooler

Table 1-6 FB7600 Maintenance Procedures

Maintenance	Procedures
Bi-Monthly	<ul style="list-style-type: none"> Checking the Emergency Stop Safety Devices Lubricating the Linear Bearings Greasing the X-Encoder Bearing Checking the External Shutter Checking the Z-Axis Shaft Coupling VCU Preventive Maintenance Preparation for Maintenance Checking Integrity of the VCU Bearings Checking Integrity of VCU Belt and VCU Profile
6-Monthly	<ul style="list-style-type: none"> Replacing the Ink Filters
Annual	<ul style="list-style-type: none"> Checking the Gas Springs
As Needed	<ul style="list-style-type: none"> Missing Nozzles Compensation (MNC) Procedure Automatic MNC Procedure Manual MNC Procedure Manually Wiping the Print Head Replacing a Print Head Replacing the Loading/Unloading Suction Cups

Declaration of Conformity



DECLARATION OF CONFORMITY

according to ISO/IEC 17050-1 and EN 17050-1

Supplier's Name: Hewlett-Packard Company

DoC N°: TLVVA-0901-03

Supplier's Address: 8b Hatzoran st.
P.O. Box 8743,
New Industrial Area 42505 Netanya,
Israel

Declares, that the product

Product Name: HP Scitex FB7500; HP Scitex FB7600

Regulatory Model Number: TLVVA-0901

Product Options: ALL

Conforms to the following Product Specifications:

Safety: EN ISO 12100-1:2003+A1:2009
EN ISO 12100-2:2003+A1:2009
EN 60204-1:2006+A1 :2009
EN 12198-1: 2000+A1 :2008, EN 12198-2: 2002+A1 :2008,
EN 12198-3: 2002+A1 :2008
EN1010-1:2004 + A1:2010, EN1010-2:2002 +A1:2010
IEC 60950-1:2005
EN 60950-1:2006 +A11:2009
IEC TR 60825-9:1999

EMC: EN55011:2009+A1:2010/ CISPR 11:2009+A1:2010 Group 1, Class A
EN 61000-6-2:2005
EN 61000-6-4:2007

Additional Information:

The product herewith complies with the requirements of the Machinery Directive 2006/42/EC, the Low Voltage Directive 2006/95/EC and the EMC Directive 2004/108/EC, and carries the CE-marking accordingly.

Local contact for regulatory topics only:

European Contact: Hewlett-Packard GmbH, HQ-TRE, Herrenberger Strasse 140, 71034 Boeblingen, Germany
USA Contact: Hewlett-Packard Company, HPCC, 20555 S.H. 249 Houston, Texas, 77070
Australia Contact: Hewlett-Packard Australia Ltd, Product regulations Manger, 31-41 Joseph Street, Blackburn, Victoria, 3130, Australia

