



V191, LV1911, W1971a, W1972a, W1952a, W1972b  
V195, LV2011, LV2011q, W2071d, W2072a, W2072b, W2052a  
XGGF W2271d, LV2311, W2371d  
User Guide



© 2011,2012,2013 Hewlett-Packard Development Company, L.P. Microsoft, Windows, and Windows Vista are either trademarks or registered trademarks of Microsoft Corporation in the United States and/or other countries.

The only warranties for HP products and services are set forth in the express warranty statements accompanying such products and services. Nothing herein should be construed as constituting an additional warranty. HP shall not be liable for technical or editorial errors or omissions contained herein.

This document contains proprietary information that is protected by copyright. No part of this document may be photocopied, reproduced, or translated to another language without the prior written consent of Hewlett-Packard Company.

Document Part Number: 672294-001

Eighth Edition (September 2013)

---

## About This Guide

This guide provides information on setting up the monitor, installing drivers, using the on-screen display menu, troubleshooting and technical specifications.

 **WARNING!** Text set off in this manner indicates that failure to follow directions could result in bodily harm or loss of life.

 **CAUTION:** Text set off in this manner indicates that failure to follow directions could result in damage to equipment or loss of information.

 **NOTE:** Text set off in this manner provides important supplemental information.

# Table of Contents

## About This Guide

### 1. Product Features

HP LCD Monitors .....	1
-----------------------	---

### 2. Safety and Maintenance Guidelines

Important Safety Information .....	2
Safety Precautions .....	2
Maintenance Guidelines .....	3
Cleaning the Monitor .....	3

### 3. Setting Up the Monitor

Unpacking the Monitor .....	4
Installing the Monitor .....	4
Connecting Monitor Cables .....	7
Connecting the Audio Cable (Select Models) .....	7
High-Bandwidth Digital Content Protection (HDCP) (Available on Select Models) .....	8
Connecting the Power Cable .....	8
Adjusting the Tilt .....	9

### 4. Operating the Monitor

CD Software and Utilities .....	10
Installing Drivers .....	10
Installing the monitor driver software from the CD .....	10
Downloading updated drivers from the Internet .....	10
Front-Panel Controls .....	11
Using the On-Screen Display (OSD) .....	12
Selecting Video Input Connectors .....	16
Identifying Monitor Conditions .....	16
Adjusting Screen Quality .....	17
Power-Saver Feature .....	17
Sleep Timer Mode .....	18

### A. Troubleshooting

Solving Common Problems .....	19
Getting Support from hp.com .....	20
Preparing to Call Technical Support .....	20
Locating the Rating Label .....	20

### B. Technical Specifications

HP LCD Monitors .....	21
Preset Video Modes .....	23
LCD Monitor Quality and Pixel Policy .....	24

### C. Agency Regulatory Notices

Federal Communications Commission Notice .....	25
Modifications .....	25
Cables .....	25
Declaration of Conformity for Products Marked with the FCC Logo (United States Only) .....	26
European Union Regulatory Notice .....	26
Canadian Notice .....	27
Avis Canadien .....	27
German Ergonomics Notice .....	27
Japanese Notice .....	27
Korean Notice .....	27
Power Cord Set Requirements .....	28
Japanese Power Cord Requirements .....	28

Disposal of Waste Equipment by Users in Private Household in the European Union . . . . . 29  
    Chemical Substances . . . . . 29  
    HP Recycling Program . . . . . 29  
    Restriction of Hazardous Substances (RoHS) . . . . . 29  
    Turkey EEE Regulation . . . . . 30  
    Ukraine Restriction of Hazardous Substances . . . . . 30

---

# 1. Product Features

---

## HP LCD Monitors

---

The HP LCD (liquid crystal display) monitors have an active matrix, thin-film transistor (TFT) screen with the following features:

- Large diagonal display
- Maximum graphics resolution:
  - 1366 x 768 @ 60Hz (18.5 in.)
  - 1600 x 900 @ 60Hz (19.5 in. 20 in.)
  - 1920 x 1080 @ 60Hz (21.5 in. 23 in.)
- Plus full-screen support for lower resolutions
- VGA analog signal
- DVI digital signal on select models
- Easy viewing from a sitting or standing position, or while moving from one side of the monitor to the other
- Tilt adjustment
- Removable base
- Built in stereo speakers on select models
- Security lock slot for a locking security cable (security cable sold separately)
- Plug and Play capability, if supported by your computer system
- On-Screen Display (OSD) adjustments in several languages for easy setup and screen optimization
- Power Saver to reduce energy consumption
- HDCP (High Bandwidth Digital Content Protection) on DVI input for select models
- Software and utilities CD, containing the following:
  - Drivers
  - Documents

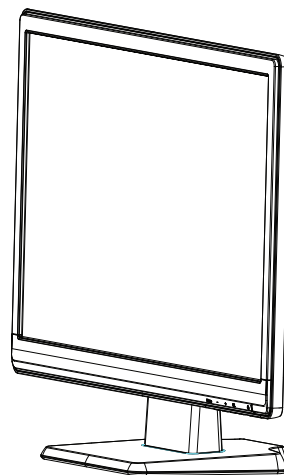

---

## 2. Safety and Maintenance Guidelines

---

### Important Safety Information

A power cord is included with the monitor. If another cord is used, use only a power source and connection appropriate for this monitor. For information on the correct power cord set to use with the monitor, refer to the "Connecting the Power Cable" .

⚠ **WARNING!** To reduce the risk of electric shock or damage to the equipment:

- Do not disable the power cord grounding feature. The grounding plug is an important safety feature.
- Plug the power cord in a grounded (earthed) outlet that is easily accessible at all times.
- Disconnect power from the product by unplugging the power cord from the electrical outlet.

For your safety, do not place anything on power cords or cables. Arrange them so that no one may accidentally step on or trip over them. Do not pull on a cord or cable. When unplugging from the electrical outlet, grasp the cord by the plug.

To reduce the risk of serious injury, read the Safety and Comfort Guide . It describes proper workstation, setup, posture, and health and work habits for computer users, and provides important electrical and mechanical safety information. This guide is located on the Web at <http://www.hp.com/ergo> and/or on the documentation CD, if one is included with the monitor.

⚠ **CAUTION:** For the protection of the monitor, as well as the computer, connect all power cords for the computer and its peripheral devices (such as a monitor, printer, scanner) to some form of surge protection device such as a power strip or Uninterruptible Power Supply (UPS). Not all power strips provide surge protection; the power strips must be specifically labeled as having this ability. Use a power strip whose manufacturer offers a Damage Replacement Policy so you can replace the equipment, if surge protection fails.

Use the appropriate and correctly sized furniture designed to properly support your HP LCD monitor.

⚠ **WARNING:** LCD monitors that are inappropriately situated on dressers, book cases, shelves, desks, speakers, chests, or carts may fall over and cause personal injury. Care should be taken to route all cords and cables connected to the LCD monitor so that they can not be pulled, grabbed, or tripped over.

---

### Safety Precautions

- Use only a power source and connection compatible with this monitor, as indicated on the label/back plate of the monitor.
- Be sure the total ampere rating of the products connected to the outlet does not exceed the current rating of the electrical outlet, and the total ampere rating of the products connected to the power cord does not exceed the rating of the power cord. Look on the power label to determine the ampere rating (Amps or A) for each device.
- Install your monitor near a power outlet that you can easily reach. Disconnect the monitor by grasping the plug firmly and pulling it from the outlet. Never disconnect the monitor by pulling the cord.



- Do not allow anything to rest on the power cord. Do not walk on the cord.

---

## Maintenance Guidelines

To enhance the performance and extend the life of the monitor:

- Do not open the monitor cabinet or attempt to service this product yourself. Adjust only those controls that are covered in the operating instructions. If the monitor is not operating properly or has been dropped or damaged, contact an authorized HP dealer, reseller, or service provider.
- Use only a power source and connection appropriate for this monitor, as indicated on the label/back plate of the monitor.
- Be sure the total ampere rating of the products connected to the outlet does not exceed the current rating of the electrical outlet, and the total ampere rating of the products connected to the cord does not exceed the rating of the cord. Look on the power label to determine the ampere rating (AMPS or A) for each device.
- Install the monitor near an outlet that you can easily reach. Disconnect the monitor by grasping the plug firmly and pulling it from the outlet. Never disconnect the monitor by pulling the cord.
- Turn the monitor off when not in use. You can substantially increase the life expectancy of the monitor by using a screen saver program and turning off the monitor when not in use.
- Slots and openings in the cabinet are provided for ventilation. These openings must not be blocked or covered. Never push objects of any kind into cabinet slots or other openings.
- Do not drop the monitor or place it on an unstable surface.
- Do not allow anything to rest on the power cord. Do not walk on the cord.
- Keep the monitor in a well-ventilated area, away from excessive light, heat or moisture.
- When removing the monitor base, you must lay the monitor face down on a soft area to prevent it from getting scratched, defaced, or broken.

## Cleaning the Monitor

1. Turn off the monitor and the computer.
2. Unplug the monitor from the wall outlet or the power brick.
3. Clean the monitor plastics with a clean cloth dampened with water.
4. Clean the monitor screen with an antistatic screen cleaner.

△ **CAUTION:** Do not use benzene, thinner, ammonia, or any other volatile substances to clean the monitor or the screen. These chemicals may damage the cabinet finish as well as the screen.

---

## 3. Setting Up the Monitor

---

### Unpacking the Monitor

1. Unpack the monitor. Make sure all contents are included. Store the packing box.
2. Turn off the computer and other attached devices.
3. Prepare a flat area to assemble the monitor. You may need a flat, soft, protected area for placing the monitor screen-down while preparing it for installation.

---

### Installing the Monitor

You can install the monitor on a desktop or wall-mount it. Place the monitor in a convenient, well-ventilated location near your computer. Connect the monitor cables after you have installed the monitor.

#### Preparing the monitor for desktop use

1. Set the monitor screen face down on a flat, soft, protected table or desk surface with the support column overhanging the edge.

△ **CAUTION:** The screen is fragile. Avoid touching or applying pressure to the LCD screen; doing so can cause damage.

2. Press the column onto the monitor support column until it locks in place.

Figure 3-1 Attaching the Monitor Column

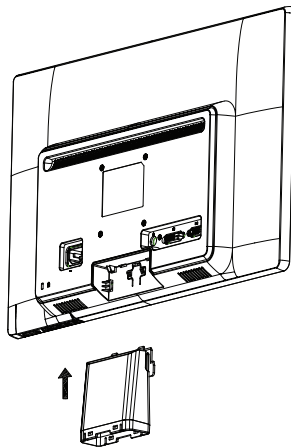

3. Press the base into the column until it locks in position.

Figure 3-2 Attaching the Base

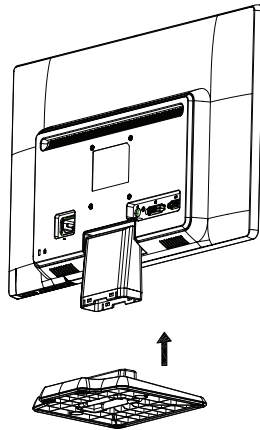

4. Lift the monitor to an upright position and place on a flat, stable surface.

Figure 3-3 Monitor in upright position

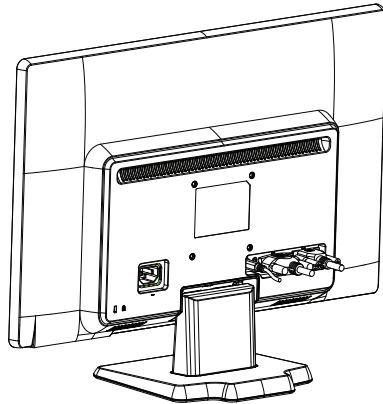

### Preparing the monitor for wall-mounting

1. Check the stability of the wall-mounting fixture.

**⚠ WARNING!** To reduce the risk of personal injury or of damage to the equipment, check that the wall-mounting fixture is adequately installed and secured before attaching the monitor. Refer to the instructions supplied with the wall-mounting fixture and check that it is capable of supporting the monitor.

2. Disconnect the power cable and any other cables from the monitor.
3. Place the monitor face down on a flat, protected surface.

4. Slide the base away from the bottom of the monitor.

Figure 3-4 Sliding the base away from the monitor

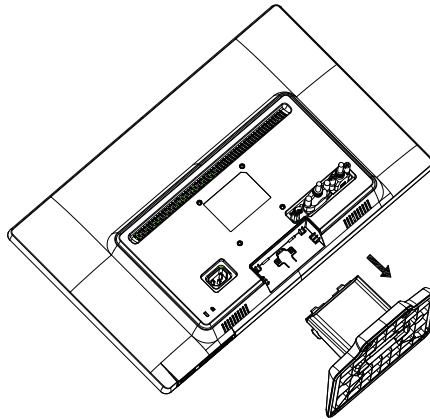

5. Four threaded holes are exposed. These holes are for screws to attach the swing arm or other mounting fixture to the back of the monitor.
6. Follow the instructions included with the mounting fixture to ensure that the monitor is safely attached. The four threaded holes that are on the back of the panel are compliant with the VESA standard for mounting flat-panel monitors.
7. Attach a swing arm or other mounting fixture.

---

## Connecting Monitor Cables

### Connecting the VGA (Analog) Cable or DVI-D (Digital) Cable

Use a VGA video cable or a DVI-D cable to connect your monitor to your computer. To use DVI, you must have a DVI-compliant graphic card. Connectors are located on the back of the monitor. Be sure the computer and monitor are turned off and unplugged.

1. To connect the VGA cable

Connect one end of the VGA video cable to the back of the monitor and the other end to the VGA video connector on the computer.

2. To connect the DVI-D cable (provided with select models)

Connect one end of the DVI-D video cable to the back of the monitor and the other end to the DVI-D video connector on the computer. You can use this cable only if your computer has a DVI compliant graphics card installed. The monitor DVI-D connector and cable are included.

Figure 3-5 Connecting the VGA or a DVI-D cable - connector locations may vary

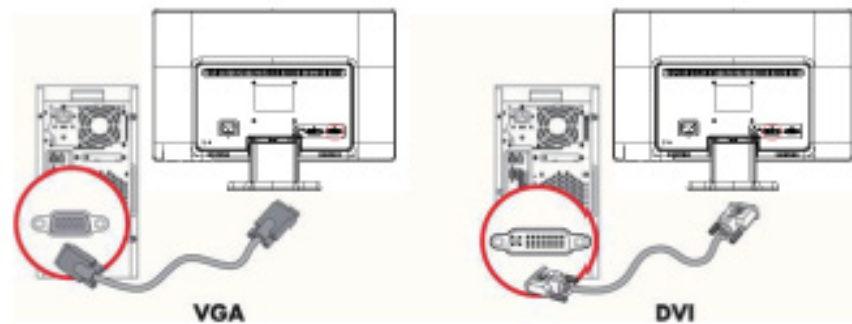

 **NOTE:** When using a VGA or DVI signal, you must connect your audio separately because a VGA or DVI signal converts only video data, not audio data.

---

## Connecting the Audio Cable (Select Models)

Connect the built-in monitor speakers to the computer by using the audio cable as shown in the following illustration

Figure 3-6 connecting the Audio Cables - connector locations may vary

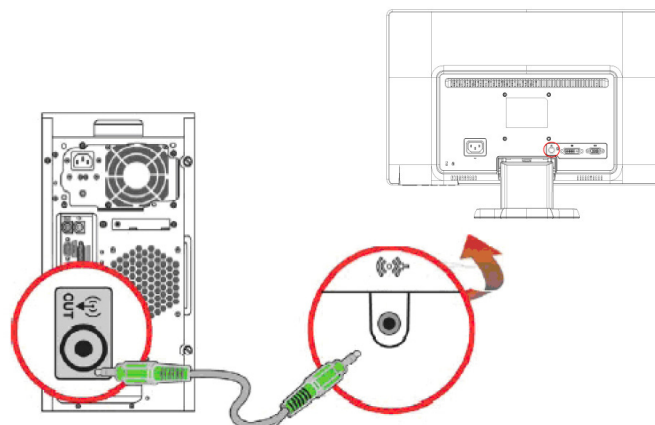

---

## High-Bandwidth Digital Content Protection (HDCP) (Available on Select Models)

Your monitor supports HDCP and can receive high-definition content. High-definition content is available in many sources, such as Blue-ray Disc devices or HDTV air or cable broadcasts. If you do not have an HDCP-enabled monitor, you will see a blank screen or a lower resolution picture when playing high-definition protected content. Your computer graphics card and monitor must both support HDCP to display protected content.

---

## Connecting the Power Cable

1. Follow all Electrical and Power Warnings

**⚠ WARNING!** To reduce the risk of electric shock or damage to your equipment: Do not disable the power cord grounding plug. The grounding plug is an important safety feature.

Plug the power cord into a grounded (earthed) electrical outlet.

Be sure that the grounded power outlet you plug the power cord into is easily accessible to the operator and located as close to the equipment as possible. A power cord should be routed so that it is not likely to be walked on or pinched by items that are placed upon it or against it.

Do not place anything on power cords or cables. Arrange them so that no one may accidentally step on or trip over them. Do not pull on a cord or cable.

See "Technical Specifications" (Appendix B) for additional information.

Figure 3-7 Connecting the power cable

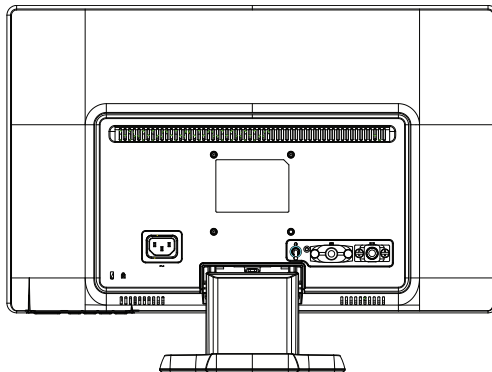

2. Connect one end of the power cable to the monitor and the other end to a grounded electrical outlet.

**⚠ WARNING!** To prevent injury from electrical shock, you should do one of the following if a properly grounded electrical outlet is not available: (1) You should use an electrical outlet adapter that provides proper grounding. (2) You should have a properly grounded electrical outlet installed.

---

## Adjusting the Tilt

For optimal viewing, adjust the screen tilt to your own preference, as follows:

1. Face the front of the monitor and hold the base so that you do not topple the monitor while changing the tilt.
2. Adjust the tilt by moving the top edge of the monitor either toward or away from you, without touching the screen.

Figure 3-8 Tilt adjustment

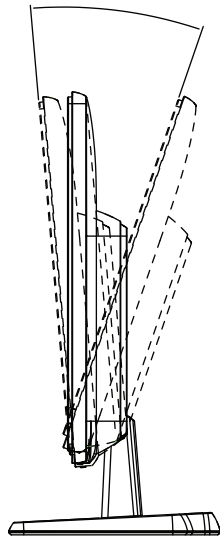

---

## 4. Operating the Monitor

---

### CD Software and Utilities

The CD that is included with this monitor contains drivers and software that you can install on your computer.

#### Installing Drivers

If you determine that you need to update the drivers, you can install the monitor driver INF and ICM files from the CD, or download them from the Internet.

#### Installing the monitor driver software from the CD

To install the monitor driver software from the CD:

1. Insert the CD in your computer CD drive. The CD menu appears.
2. Select the language.
3. Click **Install Monitor Driver Software**.
4. Follow the on-screen instructions.
5. Ensure that the proper resolutions and refresh rates appear in the Display Control Panel settings.

Refer to the Windows® operating system documentation for more information.

 **NOTE:** You might need to install the digitally signed monitor drivers (INF or ICM files) manually from the CD, in case of an installation error. Refer to the "Driver Software Readme" file on the CD for instructions (in English only).

#### Downloading updated drivers from the Internet

To download the latest version of drivers and software files from the HP Support site:

1. Refer to: **<http://www.hp.com/support>** .
2. Select your country/region.
3. Select **Download Drivers and Software**.
4. Enter the model number of your monitor. The software download pages for your monitor are displayed.
5. Download and install the driver and software files by following the instructions on the download pages.
6. Ensure that your system meets the requirements.



## Front-Panel Controls

The monitor buttons are located on the bottom of the front panel

Figure 4-1 Front-panel control buttons

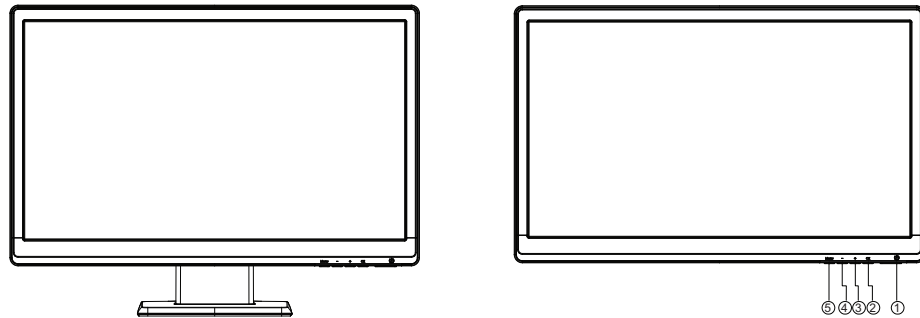

No.	Icon	Description
1	<b>Power</b>	Turns the monitor on or puts it in standby or sleep mode. The Power button is located on the bottom or front of the monitor depending on the model.
2	<b>OK</b>	If the OSD menu is on, press to select the highlighted menu item. If the OSD menu is inactive, press to activate the auto adjustment feature to optimize the screen image.
3	<b>+</b>	If the OSD menu is on, press to navigate forward through the OSD menu and increase adjustment levels. If the OSD menu is inactive, press to activate the source button that chooses the video signal input (VGA or DVI)
4	<b>-</b>	If the OSD menu is on, press to navigate backward through the OSD menu and decrease adjustment levels. If the OSD menu is inactive, press to activate the volume adjustment bar, press - or + to adjust volume.(with audio model only)
5	<b>Menu</b>	Opens, selects, or exits the OSD menu.















---

## Using the On-Screen Display (OSD)











The following table lists the On-Screen Display (OSD) menu selections and their functional descriptions. After changing an OSD menu item, and if the menu screen has these options, you may choose to:

- **Cancel** - to return to the previous menu level.
- **Save and Return** - to save all changes and return to the OSD Main Menu screen. This Save and Return option is only active if you change a menu item.









## OSD MENU

Icon	Main Menu	Submenu	Description
	Brightness	Adjustable scale	Adjusts the brightness level of the screen. The factory default range is 90.
	Contrast	Adjustable scale	Adjusts the contrast level of the screen. The factory default range is 80.
	Color		Selects the screen color. The factory default is 6500K or Custom Color, depending on the model.
		Warm (5000K)	Changes color to slightly reddish white.
		Standard (6500K)	Uses standard colors (default).
		Cool (9300K)	Changes color to slightly blueish white.
		Custom (RGB)	Selects and adjusts your own color scales: <ul style="list-style-type: none"> <li>• Red Color - sets your own red color levels</li> <li>• Green Color - sets your own green color levels</li> <li>• Blue Color - sets your own blue color levels</li> </ul>
	Image Control		Adjusts the screen Image. (VGA Input only)
		Auto Adjustment	Automatically adjusts the screen Image.
		Clock	Minimizes any vertical bars or strips visible on the screen background. Adjusting the Clock will also change the horizontal screen Image.
		Clock Phase	Adjusts the focus of the display. This adjustment allows you to remove any horizontal noise and clear or sharpen the image of characters.
		Horizontal Position	Adjusts the position of the screen Image left and right.
		Vertical Position	Adjusts the position of the screen Image up and down.
		Custom Scaling	Selects the method on how displayed information on the monitor will be formatted. Select: <ul style="list-style-type: none"> <li>• Fill to Screen - image fills the entire screen and may look distorted or elongated because of non-proportional scaling of height and width.</li> <li>• Fill to Aspect Ratio - image is sized to fit the screen and maintains proportional image.</li> </ul>
		Sharpness	Adjusts the screen image to look sharper or soft.
		Dynamic Contrast Ratio	Turns Dynamic Contrast Ratio On or Off. The factory default is Off.
	OSD Control		Provides a menu for adjusting the on-screen display (OSD) controls.
		Horizontal OSD Position	Changes the viewing position of the OSD menu to the left or right area of the screen. The factory default range is 97.
		Vertical OSD Position	Changes the viewing position of the OSD menu to the top or bottom area of the screen. The factory default range is 18.

## OSD MENU

Icon	Main Menu	Submenu	Description
		OSD Transparency	Adjust to view the background information through the OSD.
		OSD Timeout	Sets the time duration in seconds that the OSD is visible after the last button is pressed. The range is 5 - 60 seconds. The factory default is 30 seconds.
	Management		Selects the OSD and power management features of the monitor.
		Power Saver	Enables the power saving feature. Select: <ul style="list-style-type: none"> <li>• On</li> <li>• Off</li> </ul> <p>The factory default is On.</p>
		Power on Recall	Restores power to the monitor following an unexpected removal of power. Select: <ul style="list-style-type: none"> <li>• On</li> <li>• Off</li> </ul> <p>The factory default is On.</p>
		Mode Display	Displays the resolution, refresh rate and frequency information on the screen each time the OSD Main Menu is accessed. Select: <ul style="list-style-type: none"> <li>• On</li> <li>• Off</li> </ul> <p>The factory default is On.</p>
		Monitor Status	Displays the operating status of the monitor each time the monitor is powered on. Select the location to display the status to: <ul style="list-style-type: none"> <li>• Top</li> <li>• Middle</li> <li>• Bottom</li> <li>• Off</li> </ul> <p>The factory default is Top.</p>
		DDC/CI Support	Allows the computer to control some OSD menu features such as brightness, contrast and color temperature. Set to: <ul style="list-style-type: none"> <li>• On</li> <li>• Off</li> </ul> <p>The factory default is On.</p>
		Bezel Power LED	Turns off the power LED on the front panel of the monitor. The factory default is On.
		Volume	Adjusts the volume level, (on select models)

## OSD MENU

Icon	Main Menu	Submenu	Description
		Sleep Timer	Provides the timer adjustment menu options: <ul style="list-style-type: none"> <li>• Set Current Time-sets the current time in hours and minutes</li> <li>• Set Sleep Time-sets the time you want to place the monitor In sleep mode</li> <li>• Set on Time-sets the time you want the monitor to wake up from sleep mode</li> <li>• Timer-sets the Sleep Timer feature On or Off. The default setting Is Off</li> <li>• Sleep Now-Immediately sets the monitor to enter sleep mode</li> </ul>
	Language		Selects the language in which the OSD menu Is displayed. The factory default Is English.
	Information		Selects and displays important information about the monitor.
		Current Settings	Provides the current input video mode.
		Recommended Settings	Provides the recommended resolution mode and refresh rate for the monitor.
		Serial Number	Reports the serial number of the monitor. The serial number Is needed if contacting HP technical support.
		FW Version	Reports the firmware version of the monitor.
		Backlight Hours	Reports the total hours of backlight operation.
		Service Support	<a href="http://www.hp.com/support">http://www.hp.com/support</a>
	Factory Reset		Returns all OSD menu settings and DDC/CI controls to the factory default settings, except the Language.
	Source Control (on select models)		Selects the video input signal. By priority of DVI, VGA.
		DVI	Selects DVI as the video input signal.
		VGA	Selects VGA as the video input signal.
		Default Source	Selects the default or primary video input signal when the monitor is connected to two active and valid video sources. The monitor will automatically determine the video format. The choices are: <ul style="list-style-type: none"> <li>• DVI</li> <li>• VGA</li> </ul>
		Auto-Switch Source	Turns the system's automatic video signal input to On or Off. The factory default is On.
	Exit		Exits the OSD menu screen.

---

## Selecting Video Input Connectors

The input connectors are:

- VGA connector (analog)
- DVI-D connector (digital) (Select Models)

The monitor automatically determines which inputs have valid video signals, and displays the image.

You can connect the VGA cable, the DVI-D cable, or both. If both cables are installed, the default input selection is DVI. The source of input can be switched using the Input Select option in the OSD menu.

---

## Identifying Monitor Conditions

Special messages will appear on the monitor screen when identifying the following monitor conditions:

- **Monitor Status** - When the monitor is powered on or when the input source signal is changed, a Monitor Status message is displayed for five seconds. The message shows which input is the current active signal, the status of the auto-switch source setting (On or Off), the default source signal, the current preset display resolution, and the recommended preset display resolution.
- **Input Signal Out of Range** - Change resolution setting to 1366 x 768 @ 60Hz (18.5 in.), 1600 x 900 @ 60Hz (19.5 in. 20 in.), 1920 x 1080 @ 60Hz (21.5 in. 23 in.). Indicates the monitor does not support the input signal because the resolution and/or refresh rate are set higher than the monitor supports.
- **No Source Signal** - Indicates the monitor is not receiving a video signal from the PC on the monitor video input connector. Check to determine if the PC or input signal source is off or in the power saving mode.
- **Auto Adjustment in Progress** - Indicates the auto-adjustment function is active.
- **Monitor Going to Sleep** - Indicates the screen display is entering a sleep mode.
- **Check Video Cable** - Indicates the video cable is not properly connected to the computer.
- **OSD Lockout** - The OSD can be enabled or disabled by pressing and holding the Menu button on the front panel for 10 seconds. If the OSD is locked, the warning message OSD Lockout displays for ten seconds.
  - If the OSD is locked, press and hold the Menu button for 10 seconds to unlock the OSD.
  - If the OSD is unlocked, press and hold the Menu button for 10 seconds to lock the OSD.
- **Power Button Lockout** - Indicates the power button is locked. If the power button is locked, the warning message Power Button Lockout displays.
  - If the power button is locked, press and hold the power button for 10 seconds to unlock the power button function.
  - If the power button is unlocked, press and hold the power button for 10 seconds to lock out the power button function.
- **Dynamic Contrast Ratio On** - Indicates that Dynamic Contrast Ratio has been turned on. This occurs if Dynamic Contrast Ratio is turned on in the Image Control OSD menu.
- **Dynamic Contrast Ratio Off** - Indicates that Dynamic Contrast Ratio has been turned off. This occurs if Dynamic Contrast Ratio is turned off in the Image Control OSD menu.

---

## Adjusting Screen Quality

The auto adjustment feature automatically fine-tunes the image quality for display size, position, clock, and phase each time a new video mode is displayed. For more precise adjustments of VGA input, run the Auto Adjustment software on the CD. If you want additional image quality improvement, use the Clock and Phase controls of the monitor to fine tune the image. See "Optimizing Analog Video" in this chapter.

### Optimizing Analog Video

Some monitors contain advanced circuitry that allow the monitor to function as a standard analog monitor. Two controls in the OSD menu can be adjusted to improve analog image performance:

**Clock** - Increase or decrease the value to minimize any vertical bars or stripes visible on the screen background.

**Phase** - Increase or decrease the value to minimize video distortion or video jitter.

Use these controls only when the auto adjustment function does not provide a satisfactory monitor image in analog mode. To obtain the best results:

1. Allow the monitor to warm up for 30 minutes before adjusting.
2. Access the OSD menu, then select Image Control.
3. Set the main Clock settings correctly first, because the Phase settings depend on the main Clock settings. When adjusting the Clock and Phase values, if the monitor images become distorted, continue adjusting the values until the distortion disappears. To restore the factory settings, access the OSD menu, select Factory Reset , and then select Yes .

---

## Power-Saver Feature

When the monitor is in normal operating mode, the Power light is blue and the monitor uses the normal watts of power. For power usage, refer to "Technical Specifications" (Appendix B). The monitor also supports a power-saver mode that is controlled by the computer. When the monitor is in the reduced-power state, the monitor screen is blank, the backlight is off, and the Power light is amber. The monitor uses minimum power. When the monitor is "awakened," a brief warm-up period occurs before the monitor returns to normal operating mode. The energy-saving reduced power state activates if the monitor does not detect either the horizontal sync signal or the vertical sync signal. The power-saver feature must be activated on your computer for this feature to work. Refer to your computer documentation for instructions on setting energy-saver features (sometimes called power-management features).

 **NOTE:** The energy-saver feature works only when the monitor is connected to computers that have energy-saver features.

---

## Sleep Timer Mode

The Sleep Timer mode is an energy-saving feature that enables you to set a time for the monitor to power on and off at the same time every day. This also extends the life of the backlight bulbs in the monitor. The Sleep Timer has five settings:

- Set Current Time
- Set Sleep Time
- Set On Time
- Timer: On/Off
- Sleep Now

To set the timer:

1. Press the Menu button on the monitor front panel to display the OSD Menu.
2. Scroll down and highlight Management.
3. Press the OK button to select Management.
4. Scroll down and highlight and select Sleep Timer > Set Current Time.

**Note:** You must set the current local time before you reset the time for Sleep Time or On Time. Note that the time is displayed in a 24-hour clock format. For example, 1:15 p.m. is displayed as 13 hours 15 minutes.

A power failure or loss of power to the monitor will cause the timer to reset to 00:00. If this occurs, you will need to reset the sleep timer mode.

5. Press the OK button once to enter the adjustment mode for hours.
6. Press the - (Minus) or + (Plus) button to adjust the hour.
7. Press the OK button again to enter the time for minutes.
8. Press the - (Minus) or + (Plus) button to adjust the minutes.
9. Press the OK button to lock in the time chosen.
10. After setting the current time, the highlight automatically skips to Set Sleep Time. Repeat steps 6 through 9 to set Sleep Time.
11. If you do not want to set Sleep Time, press the OK button twice, then select Save and Return to exit the menu.
12. After setting Sleep Time, the highlight automatically skips to Set On Time. Repeat steps 6 through 9 to set On Time.
13. Set the Timer mode to On to activate the Sleep Timer settings.
14. When you are finished, select Save and Return to exit the menu.

The fifth selection, Sleep Now, turns the monitor backlights off immediately and stays in sleep mode until the next On Time activates or a monitor button is pressed.



## A. Troubleshooting

### Solving Common Problems

The following table lists possible problems, the possible cause of each problem, and the recommended solutions:

#### Problem Solution

Problem & Question	Possible Solutions
Power LED Is Not ON	<ul style="list-style-type: none"> <li>Make sure the power button is ON and the Power Cord is properly connected to a grounded power outlet and to the monitor.</li> </ul>
No Plug & Play	<ul style="list-style-type: none"> <li>In order for the Plug &amp; Play feature of the monitor to work, you need a Plug &amp; Play compatible computer &amp; video card. Check with your computer manufacturer. Also check the monitor's video cable and make sure none of the pins are bent.</li> <li>Make sure the HP Monitor Drivers are installed (HP Monitor Drivers are available at : <a href="http://www.hp.com/support">http://www.hp.com/support</a>)</li> </ul>
Picture Is Fuzzy & Has Ghosting Shadowing Problem	<ul style="list-style-type: none"> <li>Adjust the Contrast and Brightness Controls.</li> <li>Make sure you are not using an extension cable or switch box. We recommend plugging the monitor directly to the video card output connector on the back of your computer.</li> </ul>
Picture Bounces, Flickers Or Wave Pattern Is Present In The Picture	<ul style="list-style-type: none"> <li>Move electrical devices that may cause electrical interference as far away from the monitor as possible.</li> <li>Use the maximum refresh rate your monitor is capable of at the resolution your are using.</li> </ul>
Monitor Is Stuck In Active Off-Mode	<ul style="list-style-type: none"> <li>The Computer Power Switch should be in the ON position.</li> <li>The Computer Video Card should be snugly seated in its slot.</li> <li>Make sure the monitor's video cable is properly connected to the computer.</li> <li>Inspect the monitor's video cable and make sure none of the pins are bent.</li> </ul>
Missing one of the primary colors (RED, GREEN, or BLUE)	<ul style="list-style-type: none"> <li>Inspect the monitor's video cable and make sure that none of the pins are bent.</li> <li>Make sure the monitor's video cable is properly connected to the computer.</li> </ul>
Screen image is not centered or sized properly	<ul style="list-style-type: none"> <li>Adjust Horizontal Position and Vertical Position or press hot-key (OK).</li> </ul>
Picture has color defects (white does not look white)	<ul style="list-style-type: none"> <li>Adjust RGB color or select color temperature</li> </ul>
Horizontal or vertical disturbances on the screen	<ul style="list-style-type: none"> <li>Use Windows shut-down mode. Adjust CLOCK and Clock Phase or press the OK button to display ideal setting</li> </ul>

---

## Getting Support from hp.com

Before you contact customer service, refer to HP Technical Support at:  
<http://www.hp.com/support>

Select your country/region, and then follow the links to the support page for your monitor.

---

## Preparing to Call Technical Support

If you cannot solve a problem by using the troubleshooting tips in this section, you might have to call technical support. For technical support contact information, refer to the printed documentation included with the monitor.

**Have the following information available when you call:**

- Monitor model number (located on label on back of monitor)
- Monitor serial number (located on label on back of monitor or in the OSD display in the Information menu)
- Purchase date on invoice
- Conditions under which the problem occurred
- Error messages received
- Hardware configuration
- Name and version of hardware and software you are using

---

## Locating the Rating Label

The rating label on the monitor provides the product number and serial number. You may need these numbers when contacting HP about your monitor model.

The rating label is on the back of the monitor.

## B. Technical Specifications

All specifications represent the typical specifications provided by HP's component manufacturers; actual performance may vary either higher or lower.

### HP LCD Monitors

Face treatment: Glare polarizer with hard coating

Input terminal:

VGA connector

DVI-D 24-pin D-type connector (select models)

Table B-1 Model V191, LV1911, W1971a, W1972a, W1952a, W1972b

V195, LV2011, LV2011q, W2071d, W2072a, W2072b, W2052a

XGFEW2271d, LV2311, W2371d

Specifications:	18.5(in.)	19.5 (in.)	20(in.)
Display Type:	TFT LCD active matrix	TFT LCD active matrix	TFT LCD active matrix
Viewable Image Size	47.0 cm (18.5 in.) diagonal	49.411cm(19.5in.)diagonal	50.8 cm (20 in.) diagonal
Tilt	-4° (+/-1)~+18° (+/-1)	-4° (+/-1)~+18° (+/-1)	-4° (+/-1)~+18° (+/-1)
Maximum Weight (unpacked)	2.7 kg(5.9 lbs)	2.9 kg(6.38 lbs)	3.5 kg(7.7 lbs)
Dimensions (h x w x d)	339.5mm x446.1 mm x170.2mm 13.37 x 17.56 x 6.7 in	300.43mm x 484.53 mm x 170mm 11.83 x 19.08 x 6.69 in	356.6mm x 477.3 mm x 170.2mm 14 x 18.8 x 6.7 in (W2071d: 358.2mm x 484.5mm x 170.1mm 14.1 x 19.07 x 6.7 in)
Maximum Graphics Resolution	1366 x 768 @ 60 Hz	1600 x 900 @ 60 Hz	1600 x 900 @ 60 Hz
Optimum Graphics Resolution	1366 x 768 @ 60 Hz	1600 x 900 @ 60 Hz	1600 x 900 @ 60 Hz
Text Mode	720 x 400	720 x 400	720 x 400
Dot Pitch	0.3 x 0.3 mm	0.2712 x 0.2626 mm	0.2768 x 0.2768 mm
Horizontal Frequency (analog mode)	24 to 83 kHz	24 to 83 kHz	24 to 83 kHz
Vertical Frequency (analog mode)	50 to 76 Hz	50 to 76 Hz	50 to 76 Hz
Operating Temperature	41° to 95°F (5° to 35°C)	41° to 95°F (5° to 35°C)	41° to 95°F (5° to 35°C)
Non-Operating Temperature	-4° to 140°F (-20° to 60°C)	-4° to 140° F (-20° to 60°C)	-4° to 140° F (-20° to 60°C)
Operating Humidity	15% to 90%	15% to 90%	15% to 90%
Non-Operating Humidity	5% to 90%	5% to 90%	5% to 90%
Power Source	100-240V~, 50/60 Hz	100-240V~, 50/60 Hz	100-240V~, 50/60 Hz
Power Consumption	26 watts (W)	24 watts (W)	26 watts (W)
Sleep Power Consumption	<0.5 watts (W)	<0.5 watts (W)	<0.5 watts (W)

<b>Specifications:</b>	<b>22(in.)</b>	<b>23(in.)</b>
Display Type:	TFT LCD active matrix	TFT LCD active matrix
Viewable Image Size	54.61cm (21.5in.)diagonal	58.42 cm (23 in.) diagonal
Tilt	-4° (+/-1)~+18° (+/-1)	-4° (+/-1)~+18° (+/-1)
Maximum Weight (unpacked)	3.4 kg(7.5 lbs)	3.4 kg(7.5 lbs)
Dimensions (h x w x d)	377.17mm x 517.13 mm x 184.35mm 14.85 x 20.36 x 7.26 in	396.2mm x 554.5 mm x 185.2mm 15.6 x 21.8 x 7.3 in
Maximum Graphics Resolution	1920 x 1080 @ 60 Hz	1920 x 1080 @ 60 Hz
Optimum Graphics Resolution	1920 x 1080 @ 60 Hz	1920 x 1080 @ 60 Hz
Text Mode	720 x 400	720 x 400
Dot Pitch	0.248 x 0.248 mm	0.265 x 0.265 mm
Horizontal Frequency (analog mode)	24 to 94 kHz	24 to 94 kHz
Vertical Frequency (analog mode)	50 to 76 Hz	50 to 76 Hz
Operating Temperature	41° to 95°F (5° to 35°C)	41° to 95°F (5° to 35°C)
Non-Operating Temperature	-4° to 140° F (-20° to 60°C)	-4° to 140°F (-20° to 60°C)
Operating Humidity	15% to 90%	15% to 90%
Non-Operating Humidity	5% to 90%	5% to 90%
Power Source	100-240V~, 50/60 Hz	100-240V~, 50/60 Hz
Power Consumption	29 watts (W)	31 watts (W)
Sleep Power Consumption	<0.5 watts (W)	<0.5 watts (W)

## Preset Video Modes

The monitor automatically recognizes many preset video input modes that will appear properly sized and centered on the screen.

Table B-2 Factory Preset Video Input Modes,  
V191, LV1911, W1971a, W1972a, W1952a, W1972b

Item	Preset Resolution	Horizontal Frequency (kHz)	Vertical Frequency (Hz)
1	640 x 480	31.47	59.94
2	720 x 400	31.47	70.09
3	800 x 600	37.88	60.32
4	1024 x 768	48.36	60.00
5	1280 x 720	45.00	60.00
6	1280 x 1024	63.98	60.02
7	1366 x 768	48.00	60.00

Table B-3 Factory Preset Video Input Modes,  
V195, LV2011, LV2011q, W2071d, W2072a, W2072b, W2052a

Item	Preset Resolution	Horizontal Frequency (kHz)	Vertical Frequency (Hz)
1	640 x 480	31.47	59.94
2	720 x 400	31.47	70.09
3	800 x 600	37.88	60.32
4	1024 x 768	48.36	60.00
5	1280 x 720	45.00	60.00
6	1280 x 1024	63.98	60.02
7	1440 x 900	55.93	59.88
8	1600 x 900	60.00	60.00

Table B-4 Factory Preset Video Input Modes, LV2311, W2371d

Item	Preset Resolution	Horizontal Frequency (kHz)	Vertical Frequency (Hz)
1	640 x 480	31.47	59.94
2	720 x 400	31.47	70.09
3	800 x 600	37.88	60.32
4	1024 x 768	48.36	60.00
5	1280 x 720	45.00	60.00
6	1280 x 1024	63.98	60.02
7	1440 x 900	55.94	59.89
8	1680 x 1050	65.29	60.00
9	1920 x 1080	67.5	60.00

Table B-5 Factory Preset Video Input Modes, XGFEN2271d

Item	Preset Resolution	Horizontal Frequency (kHz)	Vertical Frequency (Hz)
1	640 x 480	31.47	59.94
2	720 x 400	31.47	70.09
3	800 x 600	37.88	60.32
4	1024 x 768	48.36	60.00
5	1280 x 720	45.00	60.00
6	1280 x 1024	63.98	60.02
7	1440 x 900	55.94	59.89
8	1600 x 900	60.00	60.00
9	1680 x 1050	65.29	60.00
10	1920 x 1080	67.5	60.00

## LCD Monitor Quality and Pixel Policy

Your LCD Monitor uses high-precision technology, manufactured according to high standards, to help guarantee trouble-free performance. Nevertheless, the display may have cosmetic imperfections that appear as small bright or dark spots. This is common to all LCD displays used in products supplied by all vendors and is not specific to your LCD Monitor. These imperfections are caused by one or more defective pixels or subpixels.

A pixel consists of one red, one green, and one blue subpixel. A defective whole pixel is always turned on (a bright spot on a dark background), or it is always off (a dark spot on a bright background). The first is the more visible of the two. A defective subpixel (dot defect) is less visible than a defective whole pixel, and is small and only visible on a specific background.

To locate defective pixels, the monitor should be viewed under normal operating conditions and in normal operating mode at a supported resolution and refresh rate, from a distance of approximately 50 cm (16 inches). We expect that, over time, the industry will continue to improve its ability to produce displays with fewer cosmetic imperfections, and we will adjust guidelines as improvements are made. For more information about your LCD Monitor, refer to the HP Web site at: <http://www.hp.com/support>.

---

## C. Agency Regulatory Notices

---

### Federal Communications Commission Notice

This equipment has been tested and found to comply with the limits for a Class B digital device, pursuant to Part 15 of the FCC Rules. These limits are designed to provide reasonable protection against harmful interference in a residential installation. This equipment generates, uses, and can radiate radio frequency energy and, if not installed and used in accordance with the instructions, may cause harmful interference to radio communications. However, there is no guarantee that interference will not occur in a particular installation. If this equipment does cause harmful interference to radio or television reception, which can be determined by turning the equipment off and on, the user is encouraged to try to correct the interference by one or more of the following measures:

Reorient or relocate the receiving antenna.

Increase the separation between the equipment and the receiver.

Connect the equipment into an outlet on a circuit different from that to which the receiver is connected.

Consult the dealer or an experienced radio or television technician for help.

### Modifications

The FCC requires the user to be notified that any changes or modifications made to this device that are not expressly approved by Hewlett Packard Company may void the user's authority to operate the equipment.

### Cables

Connections to this device must be made with shielded cables with metallic RFI/EMI connector hoods to maintain compliance with FCC Rules and Regulations.

---

## Declaration of Conformity for Products Marked with the FCC Logo (United States Only)

This device complies with Part 15 of the FCC Rules. Operation is subject to the following two conditions:

1. This device may not cause harmful interference.
2. This device must accept any interference received, including interference that may cause undesired operation.

For questions regarding the product, contact:

Hewlett Packard Company

P. O. Box 692000, Mail Stop 530113

Houston, Texas 77269-2000

Or, call 1-800-HP-INVENT (1-800 474-6836)

For questions regarding this FCC declaration, contact:

Hewlett Packard Company

P. O. Box 692000, Mail Stop 510101

Houston, Texas 77269-2000

Or, call (281) 514-3333

To identify this product, refer to the Part, Series, or Model number found on the product.

---

## European Union regulatory notice Declaration of Conformity

Products bearing the CE marking comply with one or more of the following EU Directives as may be applicable: Low Voltage Directive 2006/95/EC, EMC Directive 2004/108/EC, Ecodesign Directive 2009/125/EC; R&TTE Directive 1999/5/EC, and RoHS Directive 2011/65/EU. Compliance with these directives is assessed using applicable European Harmonised Standards.

The full Declaration of Conformity can be found at the following web site:

<http://www.hp.eu/certificates>. (Search with the product model name or its Regulatory Model Number (RMN), which may be found on the regulatory label.)

The point of contact for regulatory matters is Hewlett-Packard GmbH, Dept./MS: HQ-TRE, Herrenberger Strasse 140, 71034 Boeblingen, GERMANY.



---

## Canadian Notice

This Class B digital apparatus meets all requirements of the Canadian Interference-Causing Equipment Regulations.

---

## Avis Canadien

Cet appareil numérique de la classe B respecte toutes les exigences du Règlement sur le matériel brouilleur du Canada.

---

## German Ergonomics Notice

HP products which bear the "GS" approval mark, when forming part of a system comprising HP brand computers, keyboards and monitors that bear the "GS" approval mark, meet the applicable ergonomic requirements. The installation guides included with the products provide configuration information.

---

## Japanese Notice

この装置は、クラスB情報技術装置です。この装置は、家庭環境で使用することを目的としていますが、この装置がラジオやテレビジョン受信機に近接して使用されると、受信障害を引き起こすことがあります。取扱説明書に従って正しい取り扱いをして下さい。

VCCI-B

---

## Korean Notice

B급 기기  
(가정용 방송통신기기)

이 기기는 가정용(B급)으로 전자파적합등록을 한 기기로서 주로 가정에서 사용하는 것을 목적으로 하며, 모든 지역에서 사용할 수 있습니다.

---

## Power Cord Set Requirements

The monitor power supply is provided with Automatic Line Switching (ALS). This feature allows the monitor to operate on input voltages between 100–120V~ or 200–240V.

The power cord set (flexible cord or wall plug) received with the monitor meets the requirements for use in the country where you purchased the equipment.

If you need to obtain a power cord for a different country, you should purchase a power cord that is approved for use in that country.

The power cord must be rated for the product and for the voltage and current marked on the product's electrical ratings label. The voltage and current rating of the cord should be greater than the voltage and current rating marked on the product. In addition, the cross-sectional area of the wire must be a minimum of 0.75 mm<sup>2</sup> or 18 AWG, and the length of the cord must be between 6 feet (1.8 m) and 12 feet (3.6 m).

If you have questions about the type of power cord to use, contact an authorized HP service provider. A power cord should be routed so that it is not likely to be walked on or pinched by items placed upon it or against it. Particular attention should be paid to the plug, electrical outlet, and the point where the cord exits from the product.

## Japanese Power Cord Requirements

For use in Japan, use only the power cord received with this product.

△ **CAUTION:** Do not use the power cord received with this product on any other products.

---

## Disposal of Waste Equipment by Users in Private Household in the European Union

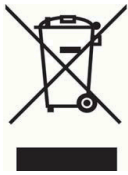

This symbol means do not dispose of your product with your other household waste. Instead, you should protect human health and the environment by handing over your waste equipment to a designated collection point for the recycling of waste electrical and electronic equipment. For more information, please contact your household waste disposal service or go to <http://www.hp.com/recycle>.

### Chemical Substances

HP is committed to providing our customers with information about the chemical substances in our products as needed to comply with legal requirements such as REACH (Regulation EC No 1907/2006 of the European Parliament and Council). A chemical information report for this product can be found at <http://www.hp.com/go/reach>.

### HP Recycling Program

HP encourages customers to recycle used electronic hardware, HP original print cartridges, and rechargeable batteries. For more information about recycling programs, go to <http://www.hp.com/recycle>.

### Restriction of Hazardous Substances (RoHS)

A Japanese regulatory requirement, defined by specification JIS C 0950, 2005, mandates that manufacturers provide Material Content Declarations for certain categories of electronic products offered for sale after July 1, 2006. To view the JIS C 0950 material declaration for this product, visit <http://www.hp.com/go/jisc0950>

2008年、日本における製品含有表示方法、JISC0950が公示されました。製造事業者は、2006年7月1日以降に販売される電気・電子機器の特定化学物質の含有につきまして情報提供を義務付けられました。製品の部材表示につきましては、[www.hp.com/go/jisc0950](http://www.hp.com/go/jisc0950)を参照してください。

## 产品中有毒有害物质或元素的名称及含量

根据中国《电子信息产品污染控制管理办法》

### LCD 显示器

部件名称	有毒有害物质或元素					
	铅 (Pb)	汞 (Hg)	镉 (Cd)	六价铬 (Cr(VI))	多溴联苯 (PBB)	多溴二苯醚 (PBDE)
液晶显示屏 - CCFL	X	X	○	○	○	○
液晶显示屏 - WLED	X	○	○	○	○	○
机箱 / 其他	X	○	○	○	○	○

○: 表示该有毒或有害物质在该部件所有均质材料中的含量均在 SJ/T11363-2006 标准规定的限量要求以下。

X: 表示该有毒或有害物质至少在该部件的某一均质材料中的含量超出 SJ/T11363-2006 标准规定的限量要求。

表中标有 "X" 的所有部件都符合欧盟 RoHS 法规, 即“欧洲议会和欧洲理事会 2003 年 1 月 27 日关于在电子电气设备中限制使用某些有害物质的 2002/95/EC 号指令”。

注: 环保使用期限的参考标识取决于产品正常工作的温度和湿度等条件。

## Turkey EEE Regulation

In Conformity with the EEE Regulation

EEE Yönetmeliğine Uygundur

## Ukraine Restriction of Hazardous Substances

Обладнання відповідає вимогам Технічного регламенту щодо обмеження використання деяких небезпечних речовин в електричному та електронному обладнанні, затвердженого постановою Кабінету Міністрів України від 3 грудня 2008 № 1057.

The equipment complies with requirements of the Technical Regulation, approved by the Resolution of Cabinet of Ministry of Ukraine as of December 3, 2008, in terms of restrictions for the use of certain dangerous substances in electrical and electronic equipment.