

Getting Started

HP Notebook

© Copyright 2013 Hewlett-Packard Development Company, L.P.

Bluetooth is a trademark owned by its proprietor and used by Hewlett-Packard Company under license. AMD is a registered trademark of Advanced Micro Devices, Inc. in the U.S. and other countries. Microsoft and Windows are U.S. registered trademarks of Microsoft Corporation. SD Logo is a trademark of its proprietor.

The information contained herein is subject to change without notice. The only warranties for HP products and services are set forth in the express warranty statements accompanying such products and services. Nothing herein should be construed as constituting an additional warranty. HP shall not be liable for technical or editorial errors or omissions contained herein.

Second Edition: July 2013

First Edition: May 2013

Document Part Number: 720721-002

Product notice

This guide describes features that are common to most models. Some features may not be available on your computer.

To obtain the latest information in this guide, contact support. For U.S. support, go to <http://www.hp.com/go/contactHP>. For worldwide support, go to http://welcome.hp.com/country/us/en/wwcontact_us.html.

Software terms

By installing, copying, downloading, or otherwise using any software product preinstalled on this computer, you agree to be bound by the terms of the HP End User License Agreement (EULA). If you do not accept these license terms, your sole remedy is to return the entire unused product (hardware and software) within 14 days for a refund subject to the refund policy of your place of purchase.

For any further information or for requesting a full refund of the computer, please contact your local point of sale (the seller).

Safety warning notice

 **WARNING!** To reduce the possibility of heat-related injuries or of overheating the computer, do not place the computer directly on your lap or obstruct the computer air vents. Use the computer only on a hard, flat surface. Do not allow another hard surface, such as an adjoining optional printer, or a soft surface, such as pillows or rugs or clothing, to block airflow. Also, do not allow the AC adapter to come into contact with the skin or a soft surface, such as pillows or rugs or clothing, during operation. The computer and the AC adapter comply with the user-accessible surface temperature limits defined by the International Standard for Safety of Information Technology Equipment (IEC 60950).

Table of contents

1 Welcome	1
Finding information	2
2 Getting to know your computer	4
Top	4
TouchPad	4
Lights	5
Buttons and fingerprint reader (select models only)	6
Keys	8
Front	9
Right	11
Left	11
Display	13
Bottom	14
3 Networking	15
Using an Internet service provider (ISP)	15
Connecting to a wireless network	16
Connecting to an existing WLAN	16
Setting up a new WLAN network	16
Configuring a wireless router	17
Protecting your WLAN	17
4 Keyboard and pointing devices	18
Using the keyboard	18
Identifying the hot keys	18
Using keypads	19
Using the embedded numeric keypad (select models only)	19
Turning the embedded numeric keypad on and off	20
Switching key functions on the embedded numeric keypad	20
Using the integrated numeric keypad (select models only)	20
Using an optional external numeric keypad	20
Using pointing devices	21
Setting pointing device preferences	21
Using the TouchPad	21
Turning the TouchPad off and on	21

Navigating	22
Selecting	22
Using TouchPad gestures	22
Scrolling	23
Pinching/Zooming	23
Rotating	23
5 Maintenance	25
Inserting or removing the battery	25
Using the optional security screw	26
Removing or replacing the service door	27
Removing the service door	27
Replacing the service door	28
Replacing or upgrading the hard drive	29
Removing the hard drive	29
Installing a hard drive	31
Adding or replacing memory modules	32
Using the DreamColor display (select models only)	34
Updating programs and drivers	34
Cleaning your computer	35
Cleaning products	35
Cleaning procedures	35
Cleaning the display	35
Cleaning the sides and cover	35
Cleaning the TouchPad and keyboard	35
6 Backup and recovery	37
Creating recovery media with HP Recovery Disc Creator	37
Creating recovery media	38
Backing up your information	38
Performing a system recovery	39
Using the Windows recovery tools	39
Using f11 recovery tools	40
Using a Windows 7 operating system DVD (purchased separately)	40
7 Support	41
Contacting support	41
Labels	42

8 Specifications	43
Input power	43
Operating environment	43
Index	44

1 Welcome

After you set up and register the computer, it is important to take the following steps:

- **Connect to the Internet**—Set up your wired or wireless network so that you can connect to the Internet. For more information, see [Networking on page 15](#).
- **Update your antivirus software**—Protect your computer from damage caused by viruses. The software is preinstalled on the computer and includes a limited subscription for free updates. For more information, see the *HP Notebook Reference Guide*. For instructions on accessing this guide, see [Finding information on page 2](#).
- **Get to know your computer**—Learn about your computer features. See [Getting to know your computer on page 4](#) and [Keyboard and pointing devices on page 18](#) for additional information.
- **Find installed software**—Access a list of the software preinstalled on the computer. Select **Start > All Programs**. For details about using the software included with the computer, see the software manufacturer's instructions, which may be provided with the software or on the manufacturer's website.

Finding information

The computer comes with several resources to help you perform various tasks.

Resources	For information about
<i>Setup Instructions</i> poster	<ul style="list-style-type: none">• How to set up the computer• Help to identify computer components
<i>HP Notebook Reference Guide</i> To access this guide on your computer: Select Start > Help and Support > User Guides .	<ul style="list-style-type: none">• Power management features• How to maximize battery life• How to use the multimedia features of the computer• How to protect the computer• How to care for the computer• How to update the software• How to install certain components• How to create a wired and/or wireless network
Help and Support To access Help and Support, select Start > Help and Support . NOTE: For U.S. support, go to http://www.hp.com/go/contactHP . For worldwide support, go to http://welcome.hp.com/country/us/en/wwcontact_us.html .	<ul style="list-style-type: none">• Operating system information• Software, driver, and BIOS updates• Troubleshooting tools• How to access support
<i>Regulatory, Safety, and Environmental Notices</i> To access this guide: Select Start > Help and Support > User Guides .	<ul style="list-style-type: none">• Regulatory and safety information• Battery disposal information
<i>Safety & Comfort Guide</i> To access this guide: Select Start > Help and Support > User Guides . – or – Go to http://www.hp.com/ergo .	<ul style="list-style-type: none">• Proper workstation setup, posture, health, and work habits• Electrical and mechanical safety information
<i>Worldwide Telephone Numbers</i> booklet This booklet is provided with your computer.	HP support telephone numbers
HP website For U.S. support, go to http://www.hp.com/go/contactHP . For worldwide support, go to http://welcome.hp.com/country/us/en/wwcontact_us.html .	<ul style="list-style-type: none">• Support information• Ordering parts and finding additional help• Accessories available for the device

Resources	For information about
<i>Limited Warranty*</i>	Warranty information
To access the warranty:	
Select Start > Help and Support > User Guides > View Warranty Information.	
– or –	
Go to http://www.hp.com/go/orderdocuments .	
*You can find the expressly provided HP Limited Warranty applicable to your product located with the user guides on your computer and/or on the CD/DVD provided in the box. In some countries/regions, HP may provide a printed HP Limited Warranty in the box. For some countries/regions where the warranty is not provided in printed format, you may request a printed copy from http://www.hp.com/go/orderdocuments or write to:	
<ul style="list-style-type: none">● North America: Hewlett-Packard, MS POD, 11311 Chinden Blvd., Boise, ID 83714, USA● Europe, Middle East, Africa: Hewlett-Packard, POD, Via G. Di Vittorio, 9, 20063, Cernusco s/Naviglio (MI), Italy● Asia Pacific: Hewlett-Packard, POD, P.O. Box 200, Alexandra Post Office, Singapore 9115077	
When you request a printed copy of your warranty, please include your product number, warranty period (found on your service label), name, and postal address.	
IMPORTANT: Do NOT return your HP product to the addresses above. For U.S. support, go to http://www.hp.com/go/contactHP . For worldwide support, go to http://welcome.hp.com/country/us/en/wwcontact_us.html .	

2 Getting to know your computer

Top

TouchPad

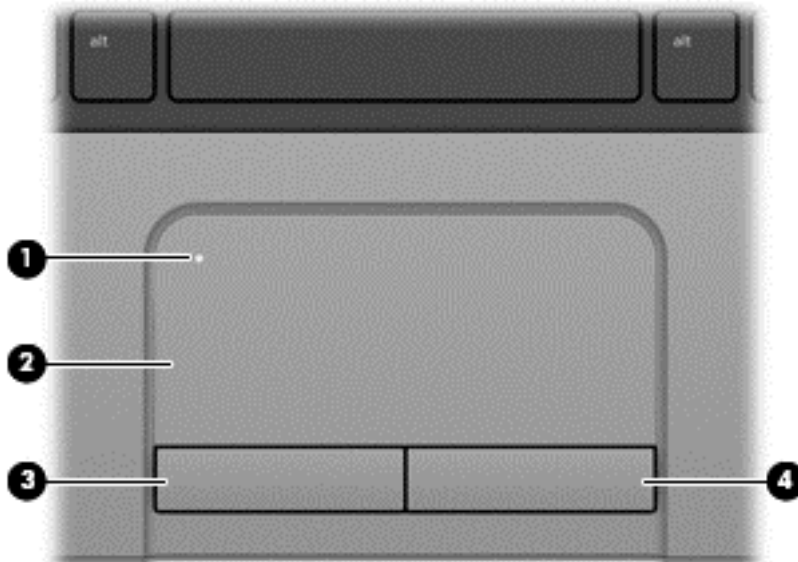



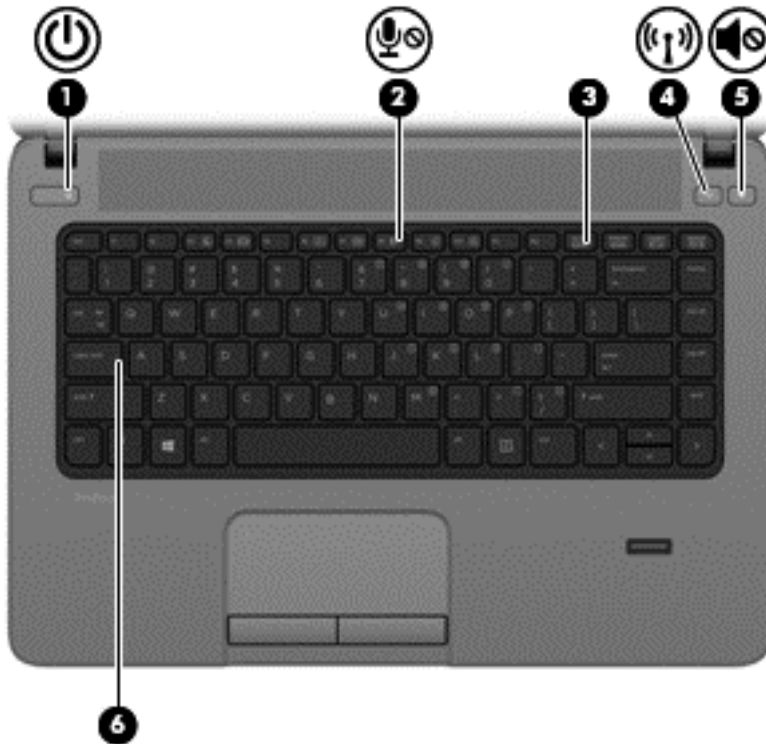

Component	Description
(1) TouchPad on/off button	Turns the TouchPad on and off.
(2) TouchPad zone	Moves the pointer and selects or activates items on the screen.
(3) Left TouchPad button	Functions like the left button on an external mouse.
(4) Right TouchPad button	Functions like the right button on an external mouse.

Lights

 **NOTE:** Your computer may look slightly different from the illustration in this section.





Component	Description
(1)  Power light	<ul style="list-style-type: none">On: The computer is on.Blinking: The computer is in the Sleep state.Off: The computer is off or in Hibernation.
(2)  Microphone mute light	Amber: The microphone is off.
(3) Num lock light	On: Num lock is on.
(4)  Wireless light	<ul style="list-style-type: none">White: An integrated wireless device, such as a wireless local area network (WLAN) device and/or a Bluetooth® device, is on.Amber: All wireless devices are off.
(5)  Mute light	<ul style="list-style-type: none">Off: Computer sound is on.Amber: Computer sound is off.
(6) Caps lock light	On: Caps lock is on.

Buttons and fingerprint reader (select models only)

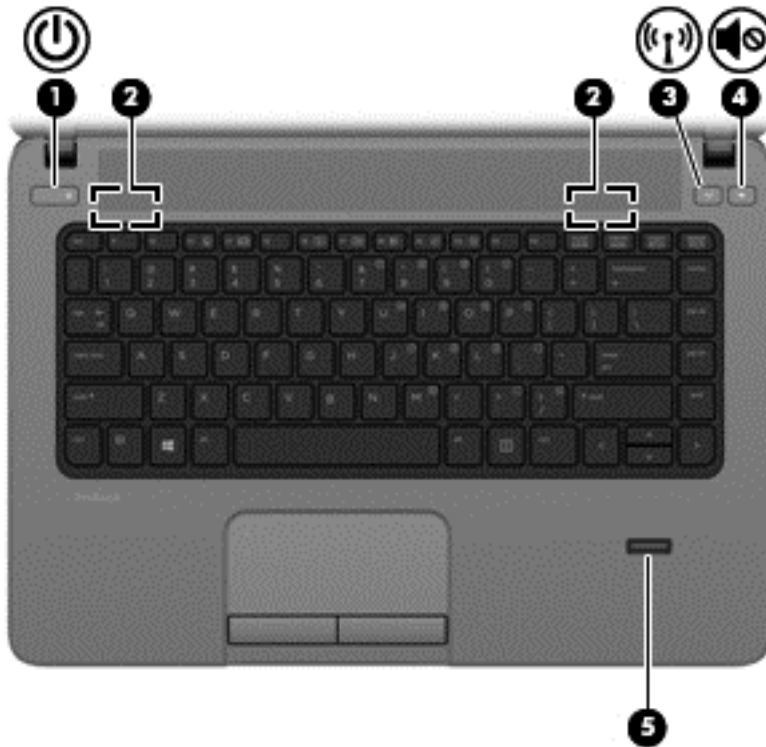
 **NOTE:** Your computer may look slightly different from the illustration in this section.





Component	Description
(1)  Power button	<ul style="list-style-type: none"> • When the computer is off, press the button to turn on the computer. • When the computer is on, press the button briefly to initiate Sleep. • When the computer is in the Sleep state, press the button briefly to exit Sleep. • When the computer is in Hibernation, press the button briefly to exit Hibernation. <p>If the computer has stopped responding and Microsoft® Windows® shutdown procedures are ineffective, press and hold the power button for at least 5 seconds to turn off the computer.</p> <p>To learn more about your power settings:</p> <ul style="list-style-type: none"> • Select Start > Control Panel > System and Security > Power Options. • For more information, see the <i>HP Notebook Reference Guide</i>.
(2) Speakers (2)	<p>Produce DTS Sound+ (select models only).</p> <p>NOTE: To use the DTS Sound+ software, select Start > All Programs > DTS Sound+.</p>

Component	Description
(3)  Wireless button	Turns the wireless feature on or off but does not establish a wireless connection.
(4)  Volume mute button	Mutes and restores speaker sound.
(5) Fingerprint reader (select models only)	Allows a fingerprint logon to Windows, instead of a password logon.

Keys

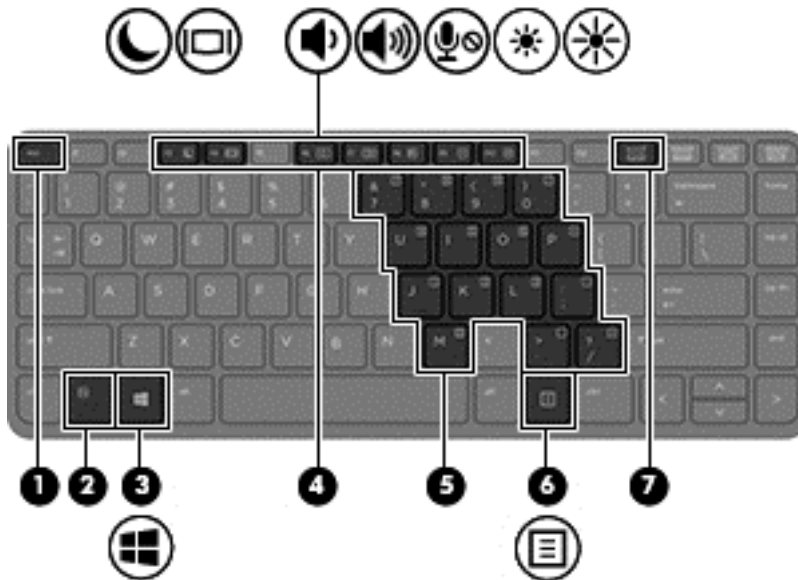
 **NOTE:** Refer to the illustration that most closely matches your computer.



Component	Description
(1) <code>esc</code> key	Displays system information when pressed in combination with the <code>fn</code> key.
(2) <code>fn</code> key	Executes frequently used system functions when pressed in combination with a function key, the <code>num lk</code> key, the <code>esc</code> key, or other keys. For more information, see Keyboard and pointing devices on page 18 .
(3)  Windows logo key	Displays the Windows Start menu.
(4) Function keys	Execute frequently used system functions when pressed in combination with the <code>fn</code> key. For more information, see Keyboard and pointing devices on page 18 .
(5) Embedded numeric keypad	When the keypad is turned on, it can be used like an external numeric keypad. Each key on the keypad performs the function indicated by the icon in the upper-right corner of the key.
(6)  Windows applications key	Displays a shortcut menu for items beneath the cursor.
(7) <code>num lk</code> key	Turns the embedded numeric keypad on and off when pressed in combination with the <code>fn</code> key. Alternates between the navigational and numeric functions on the integrated numeric keypad.

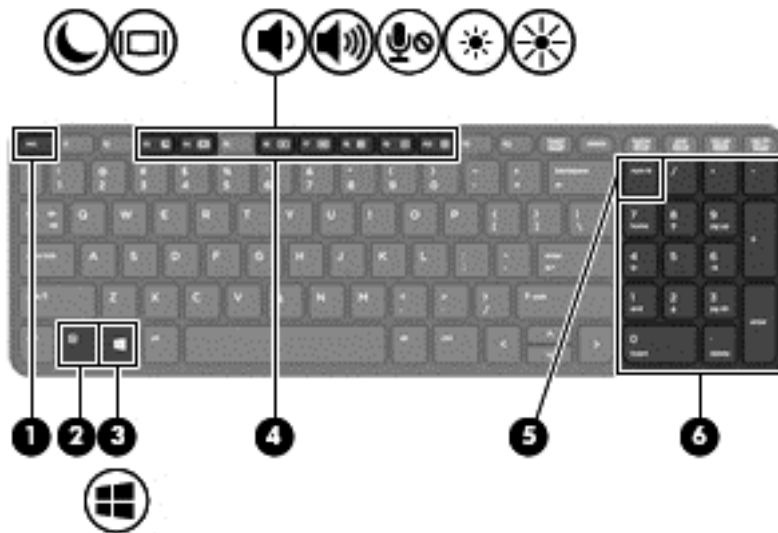

Component	Description
(1) esc key	Displays system information when pressed in combination with the fn key.
(2) fn key	Executes frequently used system functions when pressed in combination with a function key, the num lk key, the esc key, or other keys. For more information, see Keyboard and pointing devices on page 18 .
(3)  Windows logo key	Displays the Windows Start menu.
(4) Function keys	Execute frequently used system functions when pressed in combination with the fn key. For more information, see Keyboard and pointing devices on page 18 .
(5) num lk key	Turns the embedded numeric keypad on and off when pressed in combination with the fn key. Alternates between the navigational and numeric functions on the integrated numeric keypad.
(6) Integrated numeric keypad	When num lk has been enabled, it can be used like an external numeric keypad. To alternate between this numeric function and the navigational function (indicated by the directional arrows on the keys), press the num lk key.





Front

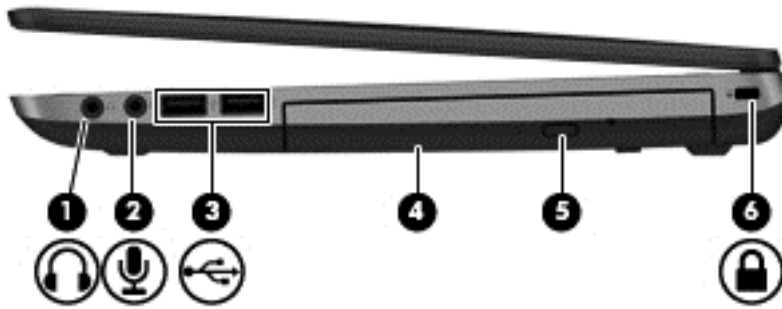

Component		Description
(1)	 Hard drive light	<ul style="list-style-type: none">• Blinking white: The hard drive is being accessed.• Amber: HP 3D DriveGuard has temporarily parked the hard drive. <p>NOTE: For information on HP 3D DriveGuard, see the <i>HP Notebook Reference Guide</i>.</p>
(2)	Media Card Reader	Reads data from and writes data to digital memory cards such as Secure Digital (SD).





Right

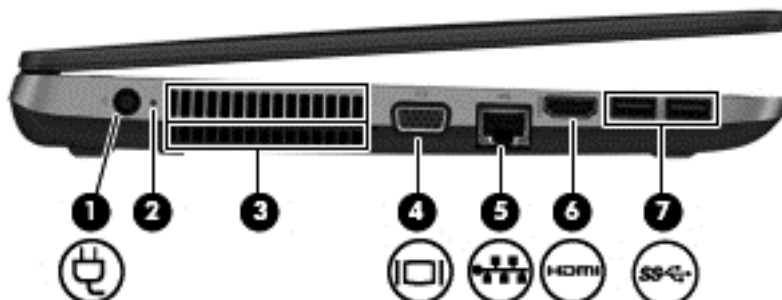

Component	Description
(1)  Audio-out (headphone) jack	Produces sound when connected to optional powered stereo speakers, headphones, earbuds, a headset, or television audio. WARNING! To reduce the risk of personal injury, adjust the volume before putting on headphones, earbuds, or a headset. For additional safety information, see the <i>Regulatory, Safety, and Environmental Notices</i> . NOTE: When a device is connected to the jack, the computer speakers are disabled.
(2)  Audio-in (microphone) jack	Connects an optional computer headset microphone, stereo array microphone, or monaural microphone.
(3)  USB 2.0 ports (2)	Connect an optional USB device. For more information about USB devices, see the <i>HP Notebook Reference Guide</i> .
(4) Optical drive (select models only)	Reads an optical disc. NOTE: On select models, the optical drive also writes to an optical disc.
(5) Optical drive eject button (select models only)	Releases the disc tray.
(6)  Security cable slot	Attaches an optional security cable to the computer. NOTE: The security cable is designed to act as a deterrent, but it may not prevent the computer from being mishandled or stolen.

Left



Component	Description
(1)  Power connector	Connects an AC adapter.
(2) AC adapter light/battery light	<ul style="list-style-type: none"> • White: The computer is connected to external power and the battery is charged from 90 to 99 percent. • Amber: The computer is connected to external power and the battery is charged from 0 to 89 percent. • Blinking amber: A battery that is the only available power source has reached a low battery level. When the battery reaches a critical battery level, the battery light begins blinking rapidly. • Off: The computer is fully charged.
(3) Vent	<p>Enables airflow to cool internal components.</p> <p>NOTE: The computer fan starts up automatically to cool internal components and prevent overheating. It is normal for the internal fan to cycle on and off during routine operation.</p>
(4)  External monitor port	Connects an external VGA monitor or projector.
(5)  RJ-45 (network) jack RJ-45 (network) lights (2)	<p>Connects a network cable.</p> <ul style="list-style-type: none"> • Green: The network is connected. • Amber: Activity is occurring on the network.
(6)  HDMI port	Connects an optional video, audio, digital, or video device, such as a high-definition television.
(7)  USB 3.0 ports (2)	Connect optional USB 3.0 devices and provide enhanced USB power performance.

Display

 **NOTE:** Your computer may look slightly different from the illustration in this section.

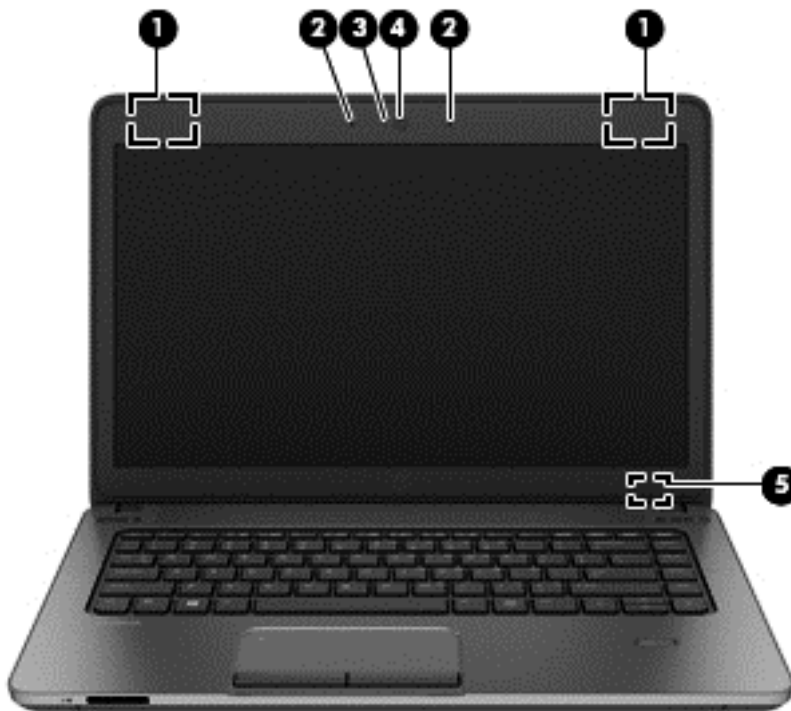



Component	Description
(1) WLAN antennas (2)*	Send and receive wireless signals to communicate with wireless local area networks (WLAN).
(2) Internal microphone(s) (1 or 2 depending on model)	Record sound.
(3) Webcam light (select models only)	On: The webcam is in use.
(4) Webcam (select models only)	Records video and captures still photographs. To use the webcam, select Start > All Programs > Communication and Chat > CyberLink YouCam .
(5) Internal display switch	Turns off the display or initiates Sleep if the display is closed while the power is on. NOTE: The display switch is not visible from the outside of the computer.

*The antennas are not visible from the outside of the computer. For optimal transmission, keep the areas immediately around the antennas free from obstructions. To see wireless regulatory notices, see the section of the *Regulatory, Safety, and Environmental Notices* that applies to your country or region. These notices are located in Help and Support.

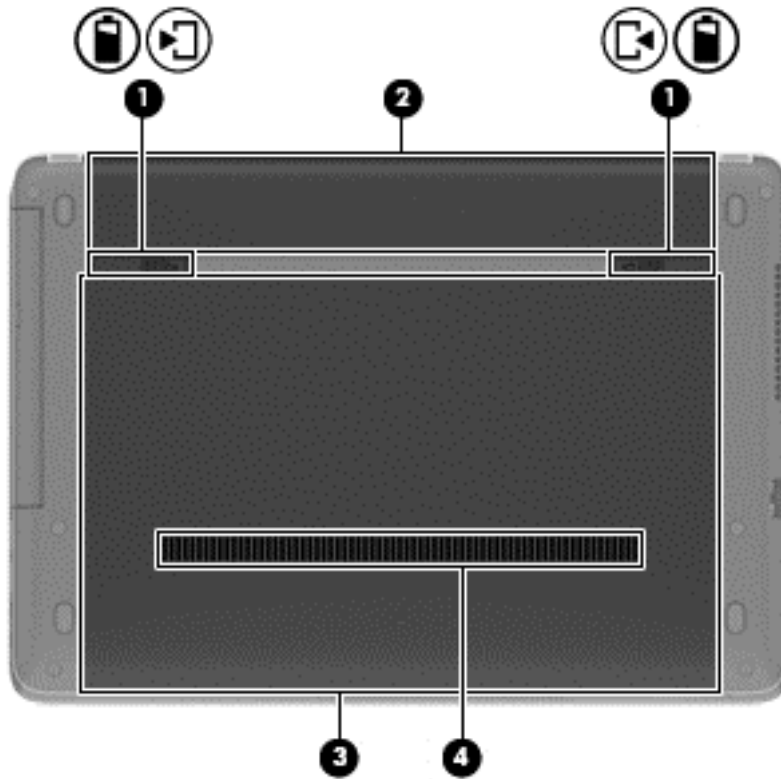
Bottom



Component	Description
<p>(1)  Battery and service door release latches</p> <p></p>	<ul style="list-style-type: none"> Releases the battery from the battery bay by sliding the release latches one time. When the battery has been removed from the battery bay, releases the service door from the computer by sliding the release latches a second time.
(2) Battery bay	Holds the battery.
(3) Service door	<p>Provides access to the hard drive bay, the wireless LAN (WLAN) module slot, and the memory module slots.</p> <p>CAUTION: To prevent an unresponsive system, replace the wireless module only with a wireless module authorized for use in the computer by the governmental agency that regulates wireless devices in your country or region. If you replace the module and then receive a warning message, remove the module to restore computer functionality, and then contact support through Help and Support.</p>
(4) Vent	<p>Enables airflow to cool internal components.</p> <p>NOTE: The computer fan starts up automatically to cool internal components and prevent overheating. It is normal for the internal fan to cycle on and off during routine operation.</p>

3 Networking

 **NOTE:** Internet hardware and software features vary depending on computer model and your location.

Your computer may support one or both of the following types of Internet access:

- **Wireless**—For mobile Internet access, you can use a wireless connection. For more information, see [Connecting to an existing WLAN on page 16](#) or [Setting up a new WLAN network on page 16](#).
- **Wired**—You can access the Internet by connecting to a wired network. For information on connecting to a wired network, see the *HP Notebook Reference Guide*.

Using an Internet service provider (ISP)

Before you can connect to the Internet, you must establish an ISP account. Contact a local ISP to purchase Internet service and a modem. The ISP will help set up the modem, install a network cable to connect your wireless computer to the modem, and test the Internet service.

 **NOTE:** Your ISP will give you a user ID and password to access the Internet. Record this information and store it in a safe place.

The following features will help you set up a new Internet account or configure the computer to use an existing account:

- **Internet Services & Offers (available in some locations)**—This utility assists with signing up for a new Internet account and configuring the computer to use an existing account. To access this utility, select **Start > All Programs > Communication and Chat**.
- **ISP-provided icons (available in some locations)**—These icons may be displayed either individually on the Windows desktop or grouped in a desktop folder named Online Services. To set up a new Internet account or configure the computer to use an existing account, double-click an icon, and then follow the on-screen instructions.
- **Windows Connect to the Internet Wizard**—You can use the Windows Connect to the Internet Wizard to connect to the Internet in any of these situations:
 - You already have an account with an ISP.
 - You do not have an Internet account and want to select an ISP from the list provided within the wizard. (The list of ISP providers is not available in all regions.)
 - You have selected an unlisted ISP, and the ISP has provided you with information such as a specific IP address and POP3 and SMTP settings.

To access the Windows Connect to the Internet Wizard and instructions for using it, select **Start > Control Panel > Network and Internet > Network and Sharing Center**.

 **NOTE:** If you are prompted within the wizard to choose between enabling or disabling Windows Firewall, choose to enable the firewall.

Connecting to a wireless network

Wireless technology transfers data across radio waves instead of wires. Your computer may be equipped with one or more of the following wireless devices:

- Wireless local area network (WLAN) device
- Bluetooth device

For more information on wireless technology and connecting to a wireless network, see the *HP Notebook Reference Guide* and information and website links provided in Help and Support.

Connecting to an existing WLAN

1. Turn on the computer.
2. Be sure that the WLAN device is on.
3. Click the network icon in the notification area, at the far right of the taskbar.
4. Select a WLAN to connect to.

 **NOTE:** If no WLANs are listed, you may be out of range of a wireless router or access point.

 **NOTE:** If you do not see the WLAN you want to connect to, click **Open Network and Sharing Center**, and then click **Set up a new connection or network**. A list of options is displayed. You can choose to manually search for and connect to a network or to create a new network connection.

5. Click **Connect**.
6. If the network is a security-enabled WLAN, you are prompted to enter a network security code. Type the code, and then click **OK** to complete the connection.

Setting up a new WLAN network

Required equipment:

- A broadband modem (either DSL or cable) (purchased separately) **(1)** and high-speed Internet service purchased from an Internet service provider (ISP)
- A wireless router (purchased separately) **(2)**
- Your new wireless computer **(3)**

 **NOTE:** Some modems have a built-in wireless router. Check with your ISP to determine what type of modem you have.

The illustration shows an example of a completed WLAN network installation that is connected to the Internet. As your network grows, additional wireless and wired computers can be connected to the network to access the Internet.

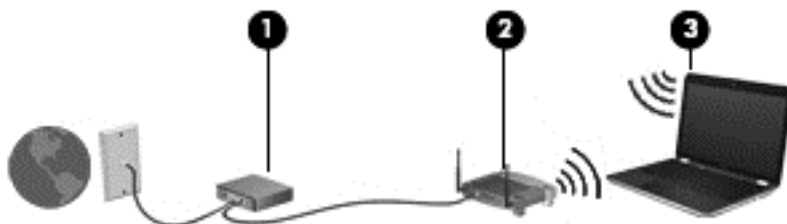

Configuring a wireless router

For help in setting up a WLAN, see the information provided by your router manufacturer or your ISP.

The Windows operating system also provides tools to help you set up a new wireless network. To use the Windows tools to set up your network:

- Select **Start > Control Panel > Network and Internet > Network and Sharing Center > Set up a new connection or network > Set up a network**. Then follow the on-screen instructions.



NOTE: It is recommended that you initially connect your new wireless computer to the router by using the network cable provided with the router. When the computer successfully connects to the Internet, you can disconnect the cable, and then access the Internet through your wireless network.

Protecting your WLAN

When you set up a WLAN or access an existing WLAN, always enable security features to protect your network from unauthorized access.

For information on protecting your WLAN, see the *HP Notebook Reference Guide*.

4 Keyboard and pointing devices









Using the keyboard

Identifying the hot keys

A hot key is a combination of the **fn** key (1) and either the **esc** key (2), or one of the function keys (3).

To use a hot key:

- ▲ Briefly press the **fn** key, and then briefly press the second key of the hot key combination.

Hot key combination	Description
 fn+esc	Displays system information.
 fn+f3	Initiates Sleep, which saves your information in system memory. The display and other system components turn off and power is conserved. To exit Sleep, briefly press the power button. CAUTION: To reduce the risk of information loss, save your work before initiating Sleep. NOTE: If a critical battery level occurs while the computer is in the Sleep state, the computer initiates Hibernation and the information stored in system memory is saved to the hard drive. The function of the fn+f3 hot key can be changed. For example, you can set the fn+f3 hot key to initiate Hibernation instead of Sleep. In all Windows operating system windows, references to the <i>sleep button</i> apply to the fn+f3 hot key.
 fn+f4	Switches the screen image among display devices connected to the system. For example, if a monitor is connected to the computer, fn+f4 alternates the screen image from computer display to monitor display to simultaneous display on both the computer and the monitor. Most external monitors receive video information from the computer using the external VGA video standard. The fn+f4 hot key can also alternate images among other devices that are receiving video information from the computer.
 fn+ f6	Decreases speaker volume.
 fn+f7	Increases speaker volume.
 fn+f8	Mutes or restores microphone sound
 fn+f9	Decreases the screen brightness level.
 fn+f10	Increases the screen brightness level.

Using keypads

The computer includes an embedded numeric keypad or an integrated numeric keypad. The computer also supports an optional external numeric keypad, or an optional external keyboard that includes a numeric keypad.

Using the embedded numeric keypad (select models only)

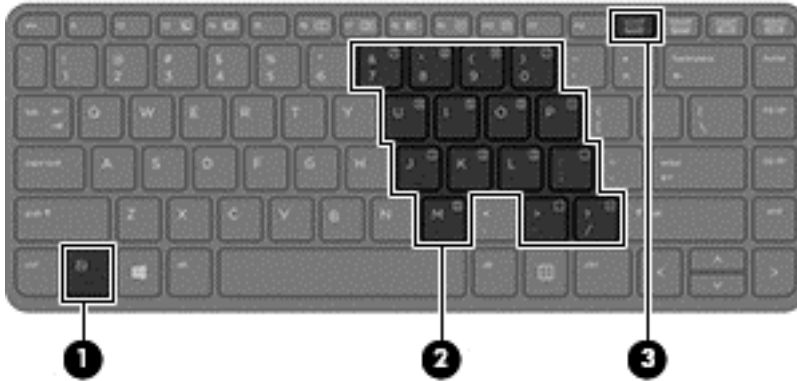

Component	Description
(1) <code>fn</code> key	Turns the embedded numeric keypad on and off when pressed in combination with the <code>num lk</code> key. NOTE: The embedded numeric keypad will not function while an external keyboard or numeric keypad is connected to the computer.
(2) Embedded numeric keypad	When the keypad is turned on, it can be used like an external numeric keypad. Each key on the keypad performs the function indicated by the icon in the upper-right corner of the key.
(3) <code>num lk</code> key	Turns the embedded numeric keypad on and off when pressed in combination with the <code>fn</code> key. NOTE: The keypad function that is active when the computer is turned off is reinstated when the computer is turned back on.

Turning the embedded numeric keypad on and off

Press **fn+num lk** to turn on the embedded numeric keypad. Press **fn+num lk** again to turn off the keypad.

 **NOTE:** The embedded numeric keypad is turned off while an external keyboard or numeric keypad is connected to the computer.

Switching key functions on the embedded numeric keypad

You can temporarily alternate the functions of keys on the embedded numeric keypad between their standard keyboard functions and their keypad functions:

- To use the navigational function of a keypad key while the keypad is off, press and hold the **fn** key while pressing the keypad key.
- To use the standard function of a keypad key while the keypad is on:
 - Press and hold the **fn** key to type in lowercase.
 - Press and hold **fn+shift** to type in uppercase.

Using the integrated numeric keypad (select models only)

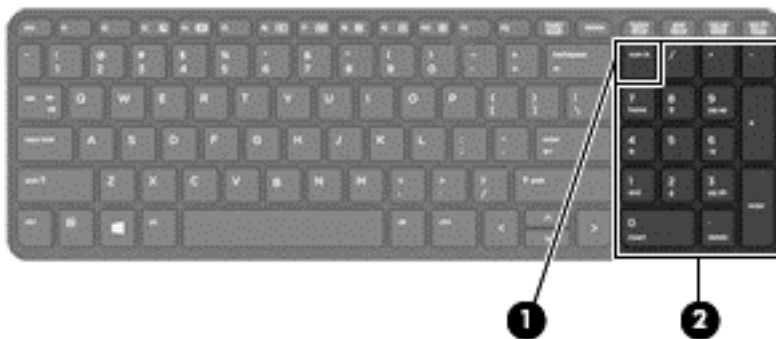

Component	Description
(1) num lk key	Alternates between the navigational and numeric functions on the integrated numeric keypad. NOTE: The keypad function that is active when the computer is turned off is reinstated when the computer is turned back on.
(2) Integrated numeric keypad	Set at the factory to function like an external numeric keypad. To alternate between this numeric function and the navigational function (indicated by the directional arrows on the keys), press the num lk key.

Using an optional external numeric keypad

Keys on most external numeric keypads function differently according to whether num lock is on or off. (Num lock is turned off at the factory.) For example:

- When num lock is on, most keypad keys type numbers.
- When num lock is off, most keypad keys function like the arrow, page up, or page down keys.

When num lock on an external keypad is turned on, the num lock light on the computer is turned on. When num lock on an external keypad is turned off, the num lock light on the computer is turned off.

To turn num lock on or off on an external keypad as you work:

- ▲ Press the **num lk** key on the external keypad, not on the computer.

Using pointing devices

 **NOTE:** In addition to the pointing devices included with your computer, you can use an external USB mouse (purchased separately) by connecting it to one of the USB ports on the computer.

Setting pointing device preferences

Use Mouse Properties in Windows to customize settings for pointing devices, such as button configuration, click speed, and pointer options.

To access Mouse Properties:

- Select **Start > Devices and Printers**. Then right-click the device representing your computer, and select **Mouse settings**.

Using the TouchPad



To move the pointer, slide one finger across the TouchPad in the direction you want the pointer to go. Use the left and right TouchPad buttons like the buttons on an external mouse.

Turning the TouchPad off and on

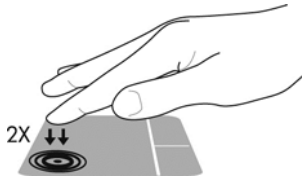
To turn the TouchPad off and on, quickly double-tap the TouchPad on/off button.



The TouchPad light and onscreen display icons indicate the TouchPad status. The following table shows and describes the TouchPad display icons.

TouchPad light	Icon	Description
Amber		Indicates that the TouchPad is off.
Off		Indicates that the TouchPad is on.

Navigating

To move the pointer, slide one finger across the TouchPad in the direction you want the pointer to go.

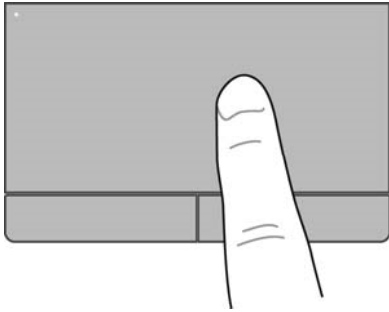

Selecting

Use the left and right TouchPad buttons like the corresponding buttons on an external mouse.

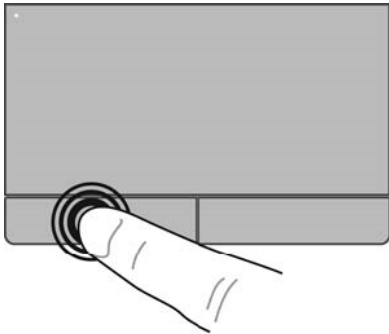

Using TouchPad gestures

The TouchPad supports a variety of gestures. To use TouchPad gestures, place two fingers on the TouchPad at the same time.



NOTE: TouchPad gestures are not supported in all programs.

To view the demonstration of a gesture:

1. Click the **Show hidden icons** icon in the notification area, at the far right of the taskbar.
2. Click the **Synaptics Pointing Device** icon , and then click **Pointing Device Properties**.
3. Click the **Device Settings** tab, select the device in the window that is displayed, and then click **Settings**.
4. Select the gesture to activate the demonstration.

To turn the gestures on and off:

1. Click the **Show hidden icons** icon in the notification area, at the far right of the taskbar.
2. Click the **Synaptics Pointing Device** icon , and then click **Pointing Device Properties**.
3. Click the **Device Settings** tab, select the device in the window that is displayed, and then click **Settings**.

4. Select the check box next to the gesture that you want to turn on or off.
5. Click **Apply**, and then click **OK**.

Scrolling

Scrolling is useful for moving up, down, or sideways on a page or image. To scroll, place two fingers slightly apart on the TouchPad, and then drag them across the TouchPad in an up, down, left, or right motion.

 **NOTE:** Scrolling speed is controlled by finger speed.

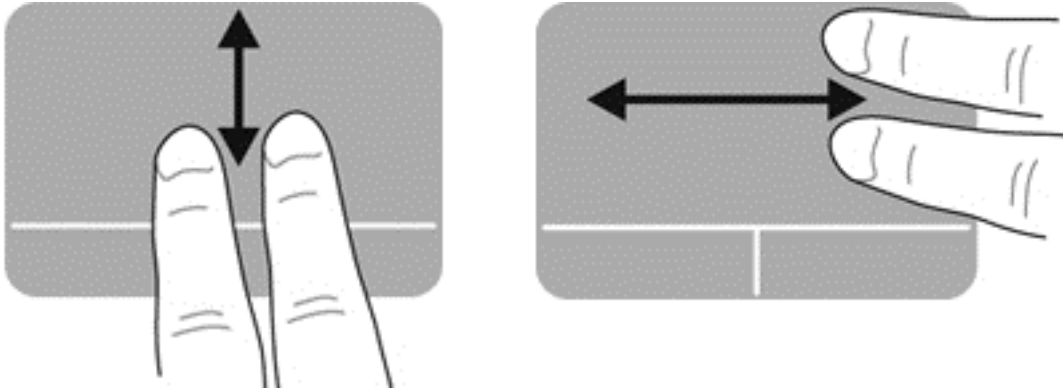

Pinching/Zooming

Pinching allows you to zoom in or out on images or text.

- Zoom in by placing two fingers together on the TouchPad, and then moving them apart.
- Zoom out by placing two fingers apart on the TouchPad, and then moving them together.

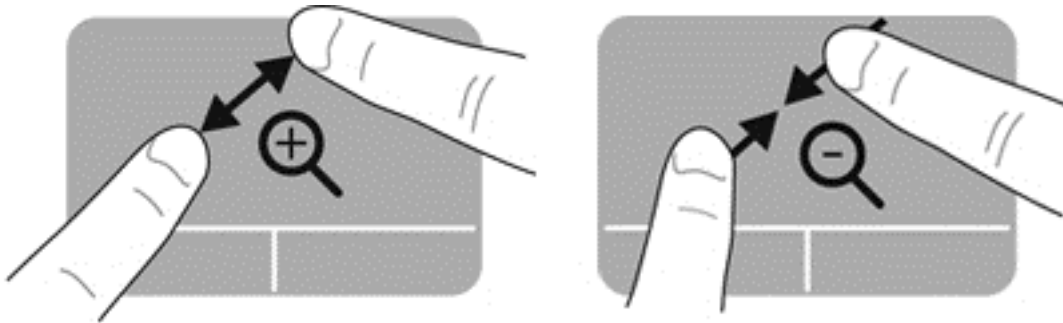

Rotating

Rotating allows you to rotate items such as photos. To rotate, anchor your left forefinger in the TouchPad zone. Move the right forefinger around the anchored finger in a sweeping motion, moving from 12 o'clock to 3 o'clock. To reverse the rotation, move your right forefinger from 3 o'clock to 12 o'clock.

 **NOTE:** Rotating must be done within the TouchPad zone.

 **NOTE:** Rotating is disabled at the factory.

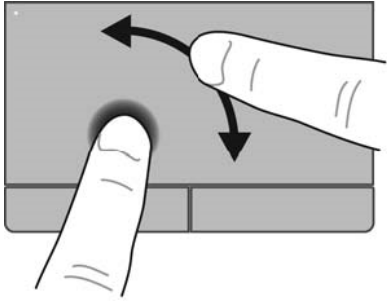

5 Maintenance

Inserting or removing the battery

 **NOTE:** For additional information on using the battery, see the *HP Notebook Reference Guide*.

To insert the battery:

- ▲ Insert the battery into the battery bay, aligning the tabs on the battery **(1)** with the notches on the computer, and then press the battery **(2)** down until it is seated.

The battery automatically locks into place.

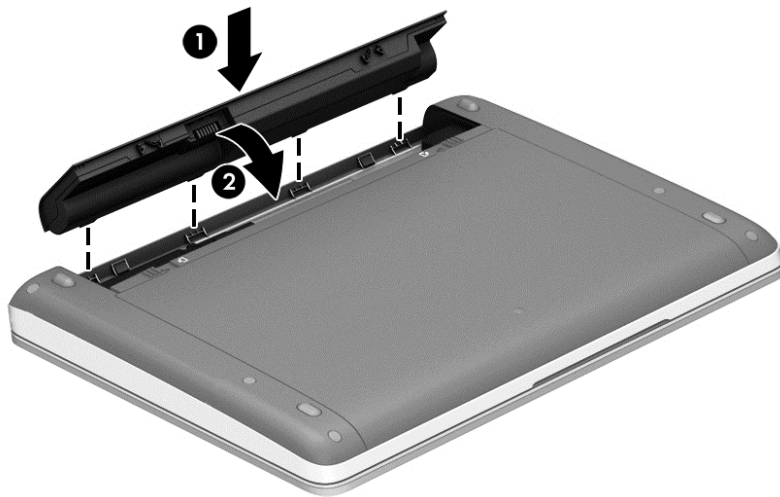

To remove the battery:

 **CAUTION:** Removing a battery that is the sole power source for the computer can cause loss of information. To prevent loss of information, save your work and initiate Hibernation or shut down the computer through Windows before removing the battery.

1. Slide the battery release latches **(1)** to release the battery.

 **NOTE:** You can slide the battery release latches simultaneously or you can slide them one at a time.

2. Tilt the battery upward (2), and remove it from the computer.



Using the optional security screw



NOTE: Refer to the illustration that most closely matches your computer.

Use the optional security screw to lock the service door to the bottom of the computer. When not in use, it can be stored inside the battery bay.

To use the security screw:

1. Remove the battery.

CAUTION: Removing a battery that is the sole power source for the computer can cause loss of information. To prevent loss of information, save your work and shut down the computer through Windows before removing the battery.

2. Remove the security screw from inside the battery bay (1) and insert it (2) to lock the service door in place.

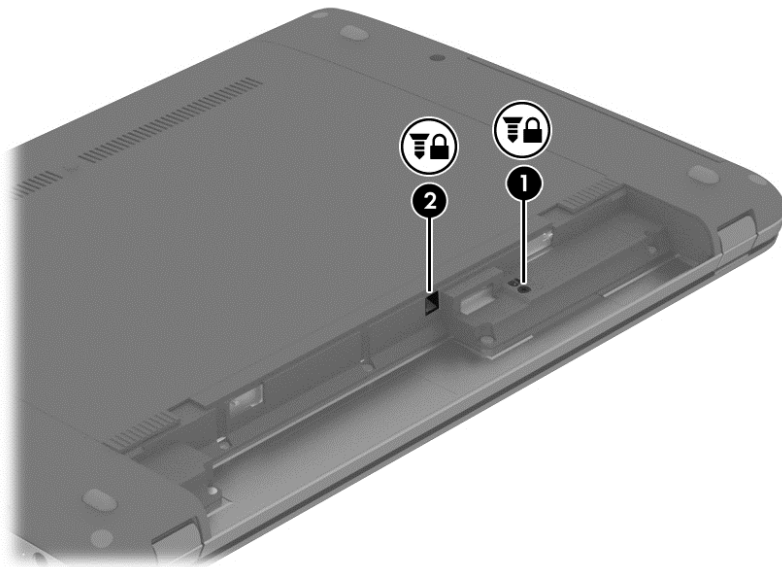
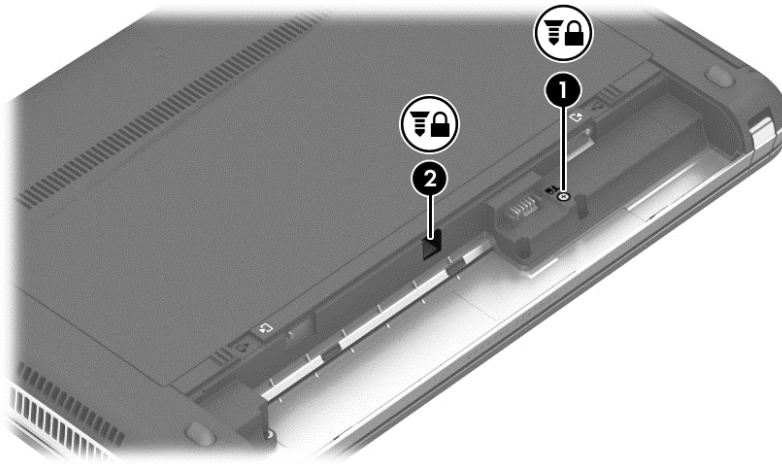

Removing or replacing the service door

⚠ CAUTION: To prevent information loss or an unresponsive system:

Save your work and shut down the computer before adding or replacing a memory module or hard drive.

If you are not sure whether the computer is off or in Hibernation, turn the computer on by pressing the power button. Then shut down the computer through the operating system.

Removing the service door

Remove the service door to access the memory module slot, hard drive, regulatory label, and other components.

To remove the service door:

1. Remove the battery (see [Inserting or removing the battery on page 25](#)).
2. With the battery bay toward you, remove the security screw (1) (if the optional screw is being used, see [Using the optional security screw on page 26](#)), and then slide the service door release latches (2) to release the service door.

 **NOTE:** You can slide the service door release latches simultaneously or you can slide them one at a time.

3. Slide the service door towards the front of the computer (3) and lift (4) to remove the service door.

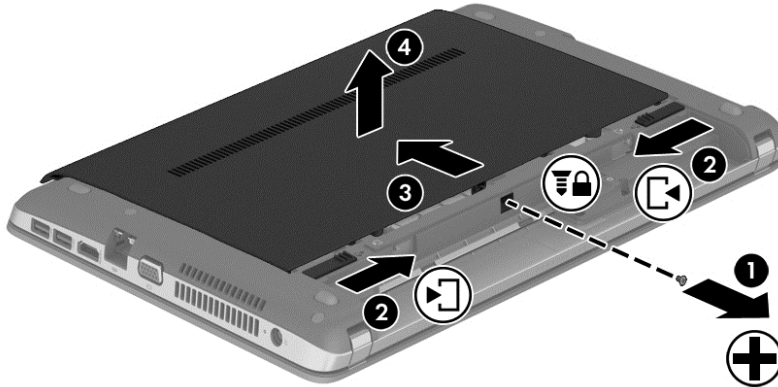

Replacing the service door

Replace the service door after accessing the memory module slot, hard drive, regulatory label, and other components.

To replace the service door:

1. Tilt the service door down to align the tabs on the service door with the latches on the computer (1).
2. Insert the alignment tabs (2) on the rear edge of the service door with the notches on the computer.

 **NOTE:** The release latches automatically lock the service door into place (3).

3. With the battery bay toward you, slide the service door towards the battery bay until the service door snaps into place (4) and, if you choose to, insert and tighten the optional screw (5) to hold the service door in place (see [Using the optional security screw on page 26](#)).

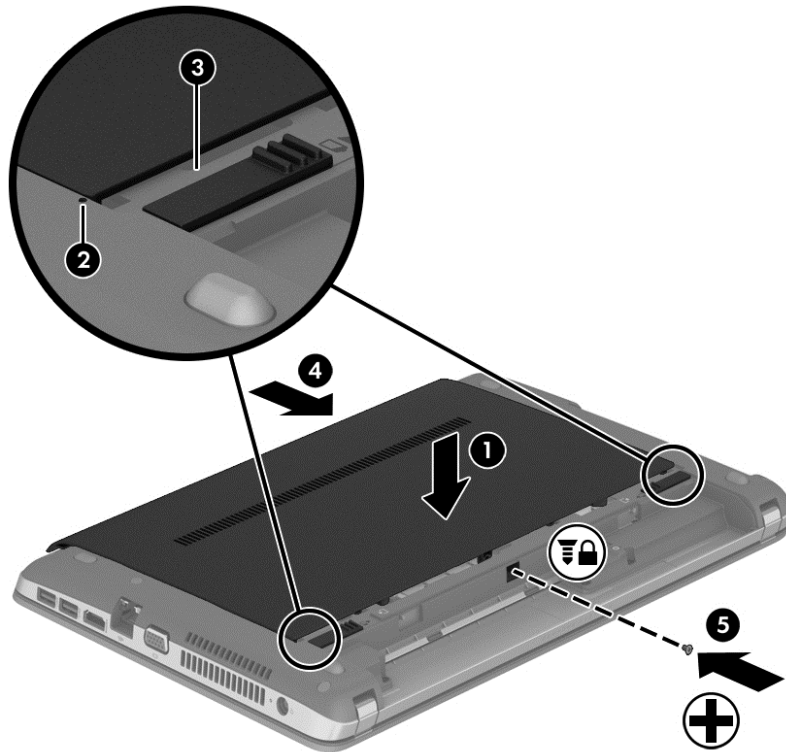

4. Insert the battery (see [Inserting or removing the battery on page 25](#)).

Replacing or upgrading the hard drive

CAUTION: To prevent information loss or an unresponsive system:

Shut down the computer before removing the hard drive from the hard drive bay. Do not remove the hard drive while the computer is on, in the Sleep state, or in Hibernation.

If you are not sure whether the computer is off or in Hibernation, turn the computer on by pressing the power button. Then shut down the computer through the operating system.

Removing the hard drive

To remove a hard drive:

1. Save your work and shut down the computer.
2. Disconnect AC power and external devices connected to the computer.
3. Turn the computer upside down on a flat surface.
4. Remove the battery and the battery (see [Inserting or removing the battery on page 25](#)).
5. Remove the service door (see [Removing or replacing the service door on page 27](#)).

6. Loosen the 4 hard drive screws.

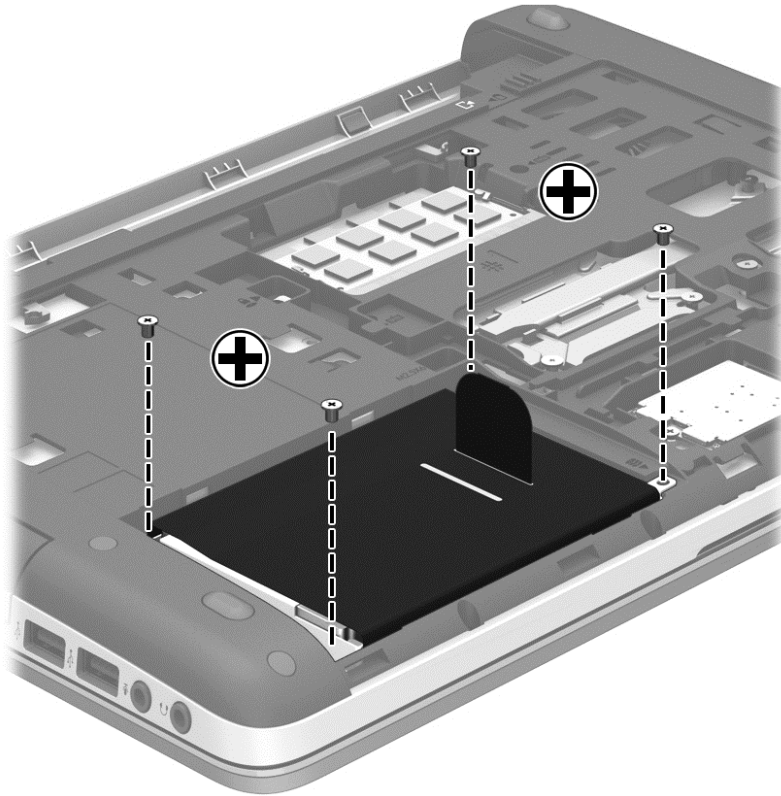

7. Pull the hard drive tab (1) to the left to disconnect the hard drive.
8. Lift the hard drive (2) out of the hard drive bay.

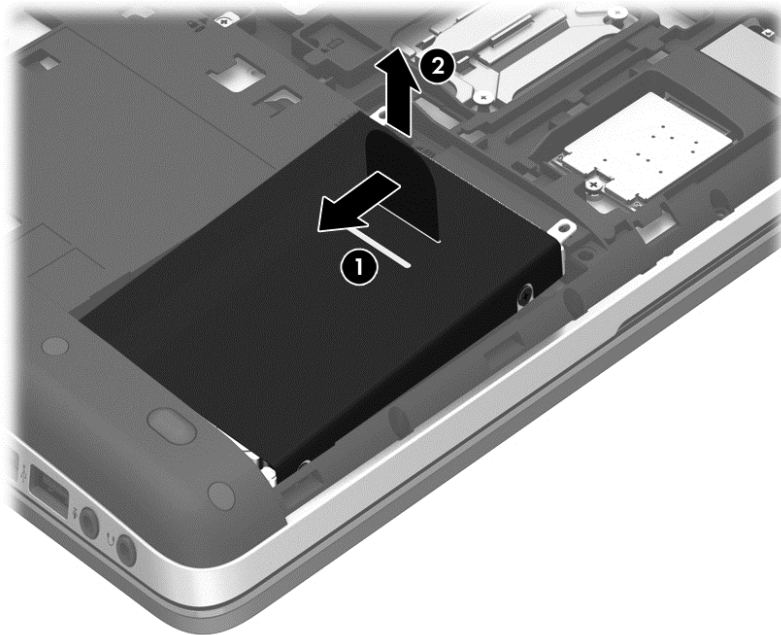

Installing a hard drive

To install the hard drive:

1. Angle the hard drive **(1)** into the hard drive bay, and then lower the hard drive **(2)** into the hard drive bay.
2. Pull the hard drive tab **(3)** to the right until the hard drive is seated.

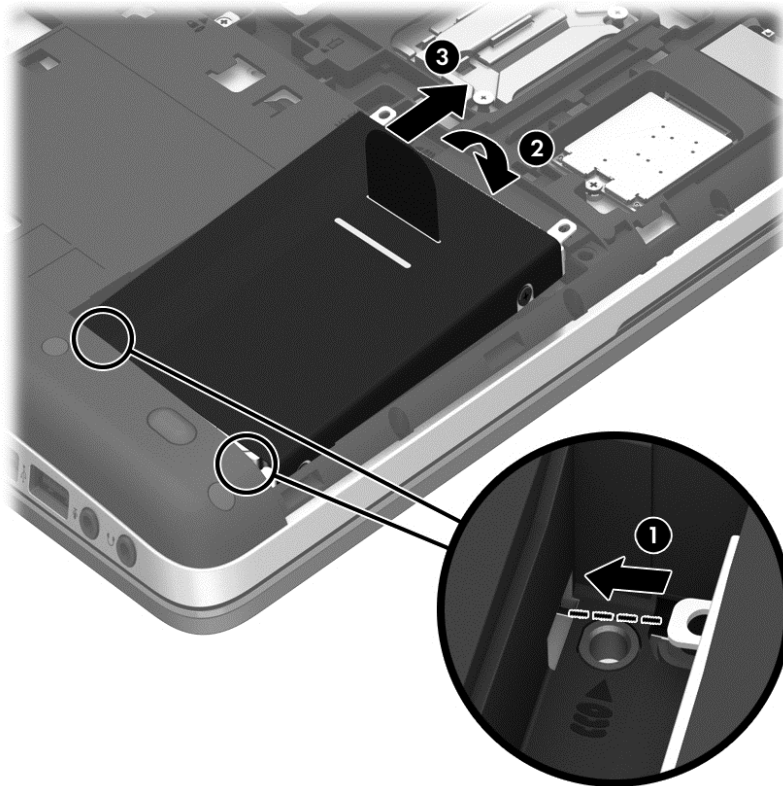

3. Tighten the 4 screws to secure the hard drive.

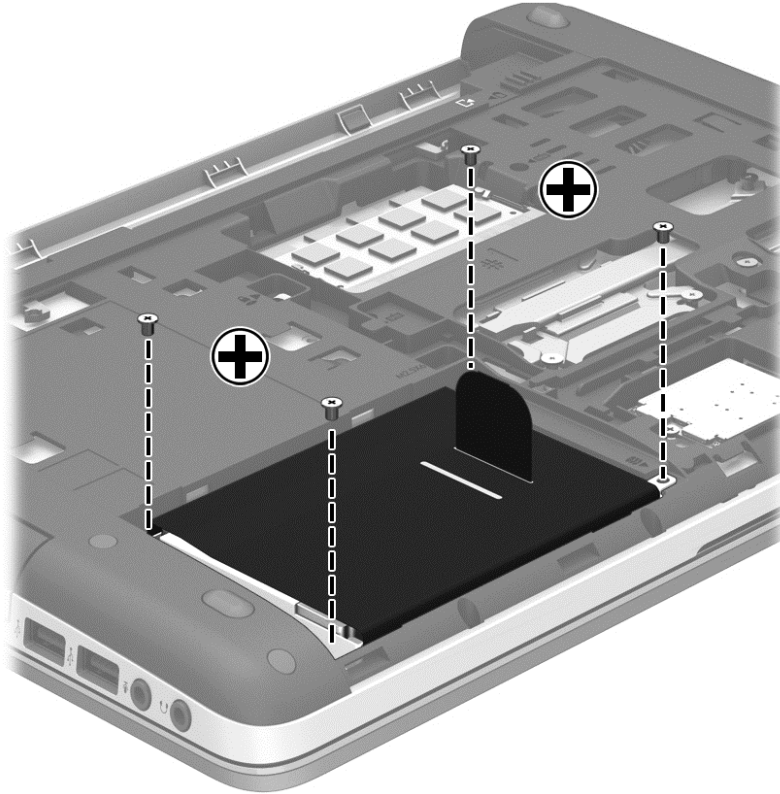

4. Replace the service door (see [Removing or replacing the service door on page 27](#)).
5. Replace the battery and the battery (see [Inserting or removing the battery on page 25](#)).
6. Turn the computer right-side up, and then reconnect AC power and external devices to the computer.
7. Turn on the computer.

Adding or replacing memory modules

The computer has two memory module slots. The capacity of the computer can be upgraded by adding a memory module to the vacant expansion memory module slot or by upgrading the existing memory module in the primary memory module slot.

WARNING! To reduce the risk of electric shock and damage to the equipment, unplug the power cord and remove all batteries before installing a memory module.

CAUTION: Electrostatic discharge (ESD) can damage electronic components. Before beginning any procedure, ensure that you are discharged of static electricity by touching a grounded metal object.

NOTE: To use a dual-channel configuration when adding a second memory module, be sure that both memory modules are identical.

To add or replace a memory module:

⚠ CAUTION: To prevent information loss or an unresponsive system:

Shut down the computer before adding or replacing memory modules. Do not remove a memory module while the computer is on, in the Sleep state, or in Hibernation.

If you are not sure whether the computer is off or in Hibernation, turn the computer on by pressing the power button. Then shut down the computer through the operating system.

1. Save your work and shut down the computer.
2. Disconnect AC power and external devices connected to the computer.
3. Turn the computer upside down on a flat surface.
4. Remove the battery (see [Inserting or removing the battery on page 25](#)).
5. Remove the service door (see [Removing or replacing the service door on page 27](#)).
6. If you are replacing a memory module, remove the existing memory module:
 - a. Pull away the retention clips **(1)** on each side of the memory module.
The memory module tilts up.
 - b. Grasp the edge of the memory module **(2)**, and then gently pull the memory module out of the memory module slot.

⚠ CAUTION: To prevent damage to the memory module, hold the memory module by the edges only. Do not touch the components on the memory module.

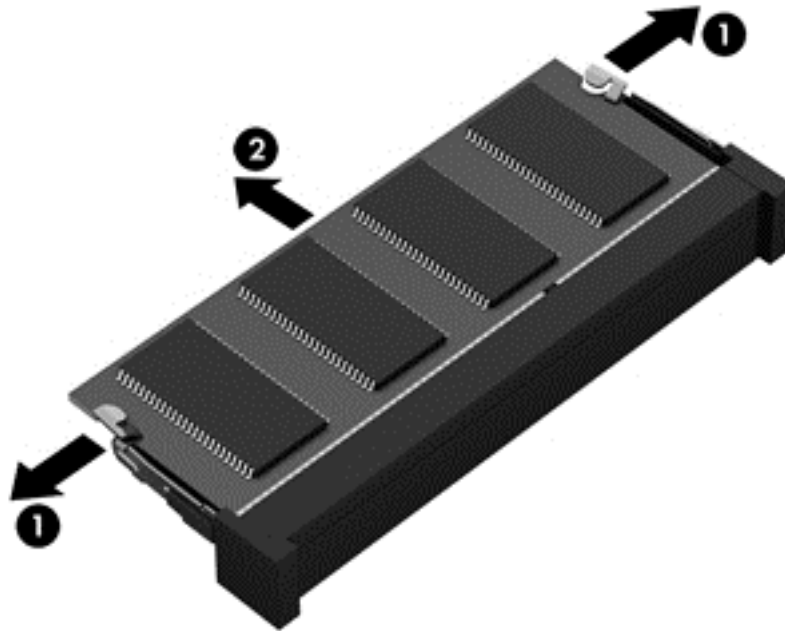

To protect a memory module after removal, place it in an electrostatic-safe container.

7. Insert a new memory module:

⚠ CAUTION: To prevent damage to the memory module, hold the memory module by the edges only. Do not touch the components on the memory module.

- a. Align the notched edge **(1)** of the memory module with the tab in the memory module slot.
- b. With the memory module at a 45-degree angle from the surface of the memory module compartment, press the module **(2)** into the memory module slot until it is seated.

- c. Gently press the memory module (3) down, applying pressure to both the left and right edges of the memory module, until the retention clips snap into place.

CAUTION: To prevent damage to the memory module, be sure that you do not bend the memory module.

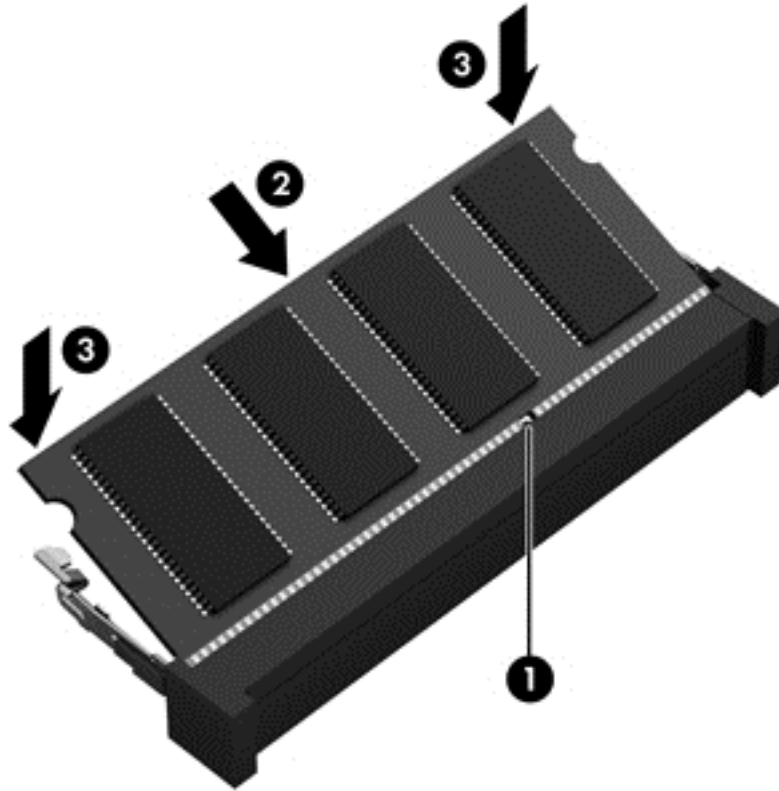

8. Replace the service door (see [Removing or replacing the service door on page 27](#)).
9. Replace the battery (see [Inserting or removing the battery on page 25](#)).
10. Turn the computer right-side up, and then reconnect AC power and external devices to the computer.
11. Turn on the computer.

Using the DreamColor display (select models only)

Computer models with the HP DreamColor display include the preinstalled HP Mobile Display Assistant software. You can use this program to adjust display color settings such as preset color space, white point/color temperature, and luminance/brightness.

- ▲ To access Mobile Display Assistant, click the Mobile Display Assistant icon in the notification area, at the far right of the taskbar, or select **Start > All Programs > Productivity and Tools > Mobile Display Assistant**.

Updating programs and drivers

HP recommends that you update your programs and drivers on a regular basis with the latest versions. For U.S. support, go to <http://www.hp.com/go/contactHP>. For worldwide support, go to http://welcome.hp.com/country/us/en/wwcontact_us.html.

Cleaning your computer

Cleaning products

Use the following products to safely clean and disinfect your computer:

- Dimethyl benzyl ammonium chloride 0.3 percent maximum concentration (For example: germicidal disposable wipes. These wipes come in a variety of brand names.)
- Alcohol-free glass cleaning fluid
- Water with mild soap solution
- Dry microfiber cleaning cloth or a chamois (static-free cloth without oil)
- Static-free cloth wipes

 **CAUTION:** Avoid the following cleaning products:

Strong solvents, such as alcohol, acetone, ammonium chloride, methylene chloride, and hydrocarbons, which can permanently damage the surface of the computer.

Fibrous materials, such as paper towels, which can scratch the computer. Over time, dirt particles and cleaning agents can get trapped in the scratches.

Cleaning procedures

Follow the procedures in this section to safely clean your computer.

 **WARNING!** To prevent electric shock or damage to components, do not attempt to clean your computer while it is turned on:

1. Turn off the computer.
2. Disconnect external power.
3. Disconnect all powered external devices.

 **CAUTION:** Do not spray cleaning agents or liquids directly on any computer surface. Liquids dripped on the surface can permanently damage internal components.

Cleaning the display

Gently wipe the display using a soft, lint-free cloth moistened with an *alcohol-free* glass cleaner. Be sure that the display is dry before closing the display.

Cleaning the sides and cover

To clean and disinfect the sides and door, use a soft microfiber cloth or chamois moistened with one of the cleaning solutions listed previously or use an acceptable germicidal disposable wipe.

 **NOTE:** When cleaning the cover of the computer, use a circular motion to aid in removing dirt and debris.

Cleaning the TouchPad and keyboard

 **WARNING!** To reduce the risk of electric shock or damage to internal components, do not use a vacuum cleaner attachment to clean the keyboard. A vacuum cleaner can deposit household debris on the keyboard surface.

 **CAUTION:** When cleaning the TouchPad and keyboard, do not let liquids drip between the keys. This can permanently damage internal components.

- To clean and disinfect the TouchPad and keyboard, use a soft microfiber cloth or chamois moistened with one of the cleaning solutions listed previously or use an acceptable germicidal disposable wipe.
- To prevent keys from sticking and to remove dust, lint, and particles from the keyboard, use a can of compressed air with a straw extension.

6 Backup and recovery

To protect your information, use Windows Backup and Restore to back up individual files and folders, back up your entire hard drive (select models only), create system repair discs (select models only) with the installed optical drive (select models only) or an optional external optical drive, or create system restore points. In case of system failure, you can use the backup files to restore the contents of your computer.

Windows Backup and Restore provides the following options:

- Creating a system repair disc (select models only) by using the installed optical drive (select models only) or an optional external optical drive
- Backing up your information
- Creating a system image (select models only)
- Scheduling automatic backups (select models only)
- Creating system restore points
- Recovering individual files
- Restoring the computer to a previous state
- Recovering information using recovery tools

 **NOTE:** For detailed instructions, perform a search for these topics in Help and Support.

In case of system instability, HP recommends that you print the recovery procedures and save them for later use.

 **NOTE:** Windows includes the User Account Control feature to improve the security of your computer. You may be prompted for your permission or password for tasks such as installing software, running utilities, or changing Windows settings. See Help and Support for more information.

Creating recovery media with HP Recovery Disc Creator

HP Recovery Disc Creator is a software program that offers an alternative way to create recovery media. After you successfully set up the computer, you can create recovery media using HP Recovery Disc Creator. This recovery media performs a system recovery if the hard drive becomes corrupted. A system recovery reinstalls the original operating system and the software programs installed at the factory, and then configures the settings for the programs.

HP Recovery Disc Creator can create two kinds of recovery DVDs as follows:

- Windows DVD—Installs the operating system without additional drivers or applications. Choosing this selection creates a DVD that restores the original operating system and the software programs installed at the factory.
- Driver DVD—Installs specific drivers and applications only, in the same way that the HP Software Setup utility installs drivers and applications.

Creating recovery media

 **NOTE:** Operating system recovery media can be created only once. Thereafter, the option to create that media will not be available.

1. Select **Start > All Programs > Security and Protection > HP Recovery Disc Creator**.
2. Select **Driver DVD** or **Windows DVD**.
3. From the drop-down menu, select the drive for burning the recovery media.
4. Click the **Burn** button to start the burning process.

Backing up your information

Recovery after a system failure is as good as your most recent backup. Immediately after software setup, you should create system repair discs (select models only) using HP Recovery Disc Creator using the installed optical drive (select models only) or an optional external optical drive and back up your system. As you add new software and data files, you should continue to back up your system on a regular basis to maintain a reasonably current backup. The system repair discs (select models only) are used to start up (boot) the computer and repair the operating system in case of system instability or failure. Your initial and subsequent backups allow you to restore your data and settings if a failure occurs.

You can back up your information to an optional external hard drive, a network drive, or discs.

Note the following when backing up:

- Store personal files in the Documents library, and back it up regularly.
- Back up templates that are stored in their associated programs.
- Save customized settings that appear in a window, toolbar, or menu bar by taking a screen shot of your settings. The screen shot can be a time-saver if you have to reset your preferences.
- When backing up to discs, use any of the following types of discs (purchased separately): CD-R, CD-RW, DVD+R, DVD+R DL, DVD-R, DVD-R DL, or DVD±RW. The discs you use will depend on the type of optical drive you are using.

 **NOTE:** DVDs and DVDs with double-layer (DL) support store more information than CDs, so using them for backup reduces the number of recovery discs required.

- When backing up to discs, number each disc before inserting it into the external drive.

To create a backup using Backup and Restore:

 **NOTE:** Be sure that the computer is connected to AC power before you start the backup process.

 **NOTE:** The backup process may take over an hour, depending on file size and the speed of the computer.

1. Select **Start > All Programs > Maintenance > Backup and Restore**.
2. Follow the on-screen instructions to set up your backup, create a system image (select models only), or create a system repair disc (select models only).

Performing a system recovery

In case of system failure or instability, the computer provides the following tools to recover your files:

- Windows recovery tools: You can use Windows Backup and Restore to recover information you have previously backed up. You can also use Windows Startup Repair to fix problems that might prevent Windows from starting correctly.
- f11 recovery tools: You can use the f11 recovery tools to recover your original hard drive image. The image includes the Windows operating system and software programs installed at the factory.

 **NOTE:** If you are unable to boot (start up) your computer and you cannot use the system repair discs you previously created (select models only), you must purchase a Windows 7 operating system DVD to reboot the computer and repair the operating system. For additional information, see [Using a Windows 7 operating system DVD \(purchased separately\) on page 40](#).

Using the Windows recovery tools

To recover information you previously backed up:

1. Select **Start > All Programs > Maintenance > Backup and Restore**.
2. Follow the on-screen instructions to recover your system settings, your computer (select models only), or your files.

To recover your information using Startup Repair, follow these steps:

 **CAUTION:** Using Startup Repair completely erases hard drive contents and reformats the hard drive. All files you have created and any software installed on the computer are permanently removed. When reformatting is complete, the recovery process restores the operating system, as well as the drivers, software, and utilities from the backup used for recovery.

1. If possible, back up all personal files.
2. If possible, check for the presence of the Windows partition and the HP Recovery partition.

To check for the Windows partition, select **Start > Computer**.

To check for the HP Recovery partition, click **Start**, right-click **Computer**, click **Manage**, and then click **Disk Management**.

 **NOTE:** If the HP Recovery partition has been deleted, the f11 restore option will not function. You must recover your operating system and programs using the Windows 7 operating system DVD and the *Driver Recovery* disc (both purchased separately) if the Windows partition and the HP Recovery partition are not listed. For additional information, see [Using a Windows 7 operating system DVD \(purchased separately\) on page 40](#).

3. If the Windows partition and the HP Recovery partition are listed, restart the computer, and then press f8 before the Windows operating system loads.
4. Select **Startup Repair**.
5. Follow the on-screen instructions.

 **NOTE:** For additional information on recovering information using the Windows tools, perform a search for these topics in Help and Support.

Using f11 recovery tools

 **CAUTION:** Using **f11** recovery tools completely erases hard drive contents and reformats the hard drive. All files you have created and any software installed on the computer are permanently removed. The **f11** recovery tool reinstalls the operating system and HP programs and drivers that were installed at the factory. Software not installed at the factory must be reinstalled.

To recover the original hard drive image using **f11**:

1. If possible, back up all personal files.
2. If possible, check for the presence of the HP Recovery partition: click **Start**, right-click **Computer**, click **Manage**, and then click **Disk Management**.

 **NOTE:** If the HP Recovery partition is not listed, you must recover your operating system and programs using the Windows 7 operating system DVD and the *Driver Recovery* disc (both purchased separately). For additional information, see [Using a Windows 7 operating system DVD \(purchased separately\) on page 40](#).

3. If the HP Recovery partition is listed, restart the computer, and then press **esc** while the “Press the ESC key for Startup Menu” message is displayed at the bottom of the screen.
4. Press **f11** while the “Press <F11> for recovery” message is displayed on the screen.
5. Follow the on-screen instructions.

Using a Windows 7 operating system DVD (purchased separately)

To order a Windows 7 operating system DVD, go to the HP website. For U.S. support, go to <http://www.hp.com/go/contactHP>. For worldwide support, go to http://welcome.hp.com/country/us/en/wwcontact_us.html. You can also order the DVD by calling support. For contact information, see the *Worldwide Telephone Numbers* booklet included with the computer.

 **CAUTION:** Using a Windows 7 operating system DVD completely erases hard drive contents and reformats the hard drive. All files you have created and any software installed on the computer are permanently removed. When reformatting is complete, the recovery process helps you restore the operating system, as well as drivers, software, and utilities.

To initiate recovery using a Windows 7 operating system DVD:

 **NOTE:** This process takes several minutes.

1. If possible, back up all personal files.
2. Restart the computer, and then insert the Windows 7 operating system DVD into the optical drive before the Windows operating system loads.
3. When prompted, press any keyboard key.
4. Follow the on-screen instructions.
5. Click **Next**.
6. Select **Repair your computer**.
7. Follow the on-screen instructions.

After the repair is completed:

1. Eject the Windows 7 operating system DVD, and then insert the *Driver Recovery* disc.
2. Install the Hardware Enabling Drivers first, and then install Recommended Applications.

7 Support

Contacting support

If the information provided in this user guide, in the *HP Notebook Reference Guide*, or in Help and Support does not address your questions, you can contact support. For U.S. support, go to <http://www.hp.com/go/contactHP>. For worldwide support, go to http://welcome.hp.com/country/us/en/wwcontact_us.html.

Here you can:

- Chat online with an HP technician.



NOTE: When support chat is not available in a particular language, it is available in English.

- E-mail support.
- Find support telephone numbers.
- Locate an HP service center.

Labels

The labels affixed to the computer provide information you may need when you troubleshoot system problems or travel internationally with the computer:

- Service label—Provides important information, including the following:

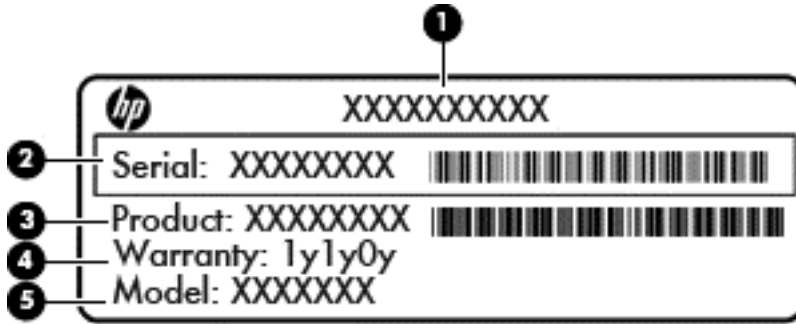

Component	
(1)	Product name
(2)	Serial number (s/n)
(3)	Part number/Product number (p/n)
(4)	Warranty period
(5)	Model description (select models only)

Have this information available when you contact support. The service label is affixed inside the battery bay.

- Microsoft® Certificate of Authenticity—Contains the Windows Product Key. You may need the Product Key to update or troubleshoot the operating system. The Microsoft Certificate of Authenticity is affixed inside the battery bay.
- Regulatory label—Provides regulatory information about the computer. The regulatory label is affixed inside the service door.
- Wireless certification label or labels (select models only)—Provide information about optional wireless devices and the approval markings of some of the countries or regions in which the devices have been approved for use. If your computer model includes one or more wireless devices, one or more certification labels are included with your computer. You may need this information when traveling internationally. Wireless certification labels are affixed inside the battery bay.

8 Specifications

Input power

The power information in this section may be helpful if you plan to travel internationally with the computer.

The computer operates on DC power, which can be supplied by an AC or a DC power source. The AC power source must be rated at 100–240 V, 50–60 Hz. Although the computer can be powered from a standalone DC power source, it should be powered only with an AC adapter or a DC power source supplied and approved by HP for use with this computer.

The computer can operate on DC power within the following specifications.

Input Power	Rating
Operating voltage and current	19.5 V dc @ 3.33 A - 65 W
	19.5 V dc @ 4.62 A - 90 W

 **NOTE:** This product is designed for IT power systems in Norway with phase-to-phase voltage not exceeding 240 V rms.

 **NOTE:** The computer operating voltage and current can be found on the system regulatory label.

Operating environment

Factor	Metric	U.S.
Temperature		
Operating	5°C to 35°C	41°F to 95°F
Nonoperating	-20°C to 60°C	-4°F to 140°F
Relative humidity (noncondensing)		
Operating	10% to 90%	10% to 90%
Nonoperating	5% to 95%	5% to 95%
Maximum altitude (unpressurized)		
Operating	-15 m to 3,048 m	-50 ft to 10,000 ft
Nonoperating	-15 m to 12,192 m	-50 ft to 40,000 ft

Index

- A**
 - audio-in (microphone) jack, identifying 11
 - audio-out (headphone) jack, identifying 11
- B**
 - Backup and Restore 38
 - battery bay, identifying 14
 - battery release latches 14
 - battery, replacing 25
 - Bluetooth label 42
 - buttons
 - left TouchPad 4
 - optical drive eject 11
 - power 6
 - right TouchPad 4
 - volume mute 7
 - wireless 7
- C**
 - caps lock light, identifying 5
 - caring for your computer 35
 - Certificate of Authenticity label 42
 - cleaning your computer 35
 - components
 - bottom 14
 - display 13
 - front 9
 - left side 11
 - right side 11
 - top 4
 - connector
 - power 12
- D**
 - display image, switching 18
- E**
 - embedded numeric keypad, identifying 8, 19
 - esc key, identifying 8, 9
 - external monitor port 12
- F**
 - f11 recovery 40
 - fingerprint reader, identifying 7
 - fn key, identifying 8, 9, 18
 - function keys
 - identifying 8, 9
- H**
 - hard drive
 - identifying 14
 - installing 31
 - removing 29
 - hard drive light 10
 - hard drive recovery 40
 - HDMI port, identifying 12
 - headphone (audio-out) jack 11
 - hot keys
 - adjusting volume 18
 - decrease screen brightness 18
 - decrease speaker sound 18
 - description 18
 - increase screen brightness 18
 - increase speaker sound 18
 - mutes microphone sound 18
 - Sleep 18
 - switching screen image 18
 - using 18
- I**
 - input power 43
 - integrated numeric keypad, identifying 9, 20
 - integrated webcam light, identifying 13
 - internal display switch 13
 - internal microphones, identifying 13
 - Internet connection setup 16
 - ISP, using 15
- J**
 - jacks
 - audio-in (microphone) 11
 - audio-out (headphone) 11
 - RJ-45 (network) 12
- K**
 - keyboard hot keys, identifying 18
 - keypad, external
 - num lock 21
 - using 20
 - keypads
 - embedded numeric 8
 - identifying 19, 20
 - integrated numeric 9
 - keys
 - esc 8, 9
 - fn 8, 9
 - function 8, 9
 - Windows applications 8
 - Windows logo 8, 9
- L**
 - labels
 - Bluetooth 42
 - Microsoft Certificate of Authenticity 42
 - regulatory 42
 - service 42
 - wireless certification 42
 - WLAN 42
 - latches,
 - battery release 14
 - service door release 14
 - lights
 - AC adapter 12
 - caps lock 5
 - hard drive 10
 - microphone mute 5
 - mute 5
 - num lock 5
 - power 5
 - RJ-45 (network) 12
 - webcam 13
 - wireless 5

M

Media Card Reader, identifying 10
memory module
 identifying 14
 inserting 33
 removing 33
 replacing 32
microphone (audio-in) jack,
 identifying 11
microphone mute hot key,
 identifying 18
microphone mute light 5
Microsoft Certificate of Authenticity
 label 42
mouse, external
 setting preferences 21
mute light 5

N

num lk key, identifying 19, 20
num lock light 5
num lock, external keypad 21

O

operating environment 43
operating system
 Microsoft Certificate of
 Authenticity label 42
 Product Key 42
optical drive eject button,
 identifying 11
optical drive, identifying 11

P

pinching TouchPad gesture 23
pointing devices, setting
 preferences 21
ports
 external monitor 12
 HDMI 12
 USB 11, 12
power button, identifying 6
power connector, identifying 12
power lights 5
Product Key 42
product name and number,
 computer 42

R

recovery partition 40

regulatory information
 regulatory label 42
 wireless certification labels 42
restoring the hard drive 40
RJ-45 (network) jack, identifying 12
RJ-45 (network) lights,
 identifying 12

S

screen brightness keys 18
screen image, switching 18
scrolling TouchPad gesture 23
security cable slot 11
security screw, using 26
serial number 42
service door 14, 42
 removing or replacing 27
service door release latches 14
service label, computer 42
setup of WLAN 16
speakers, identifying 6
system repair disc 37
system restore points 37

T

TouchPad
 buttons 4
 using 21
TouchPad gestures
 pinching 23
 scrolling 23
 zooming 23
TouchPad zone
 identifying 4
traveling with the computer 42

U

USB ports, identifying 11, 12

V

vents, identifying 12, 14
volume keys, identifying 18

W

webcam 13
 identifying 13
webcam light, identifying 13
Windows 7 operating system
 DVD 40

Windows applications key,
 identifying 8
Windows Backup and Restore 37
Windows logo key, identifying 8,
 9
wireless certification label 42
wireless light 5
wireless network (WLAN),
 equipment needed 16
wireless network, connecting 16
wireless router, configuring 17
wireless setup 16
WLAN
 connecting 16
 protecting 17
WLAN antennas, identifying 13
WLAN device 42
WLAN label 42

Z

zooming TouchPad gesture 23