



# DESIGNJET L26500 / L26100 printer series

## Maintenance and troubleshooting guide

### **Legal notices**

The information contained herein is subject to change without notice.

The only warranties for HP Products and services are set forth in the express warranty statement accompanying such products and services. Nothing herein should be construed as constituting an additional warranty. HP shall not be liable for technical or editorial errors or omissions contained herein.

You can find the expressly provided HP Limited Warranty applicable to your product in the start menu on your PC and/or in the CD/DVD provided in the box. For some countries/regions a printed HP Limited Warranty is provided in the box. In countries/regions where the warranty is not provided in printed format, you may request a printed copy from <http://www.hp.com/go/orderdocuments/>, or write to:

North America: Hewlett Packard, MS POD,  
11311 Chinden Blvd, Boise, ID 83714, USA.

Europe, Middle East, Africa: Hewlett-Packard,  
POD, Via G. Di Vittorio 9, 20063 Cernusco s/  
Naviglio (MI), Italy.

Asia, Pacific: Hewlett-Packard, POD, P.O. Box  
200, Alexandra Post Office, Singapore 911507.

Please include your product number, warranty period (found on your serial number label), name and postal address.

### **Trademarks**

Microsoft® and Windows® are U.S. registered trademarks of Microsoft Corporation.

---

# Table of contents

<b>1 Safety precautions</b> .....	<b>1</b>
General safety guidelines .....	1
Electrical shock hazard .....	1
Heat hazard .....	2
Fire hazard .....	2
Mechanical hazard .....	2
Heavy substrate hazard .....	3
Ink handling .....	3
Warnings and cautions .....	3
Warning labels .....	3
<b>2 Printer status</b> .....	<b>5</b>
Check printer status .....	5
Check the status of the ink system .....	5
Check the status of the ink cartridges .....	6
Check the status of a printhead .....	6
Check the file system .....	7
Printer alerts .....	7
<b>3 Firmware update</b> .....	<b>9</b>
<b>4 Hardware maintenance</b> .....	<b>11</b>
Ink system tips .....	11
Align the printheads .....	11
Check substrate porosity .....	12
Clean the electrical connections on a printhead .....	13
Clean the exterior of the printer .....	16
Clean the platen .....	17
Clean (recover) the printheads .....	19
Clean the substrate-advance sensor window .....	19
Clean and lubricate the carriage rail .....	20
Maintain the ink cartridges .....	22
Move or store the printer .....	22
Replace an ink cartridge .....	23

Replace the ink maintenance kit .....	27
Replace a printhead .....	30
Replace the printhead cleaning kit .....	35
Service maintenance .....	39
<b>5 Substrate settings .....</b>	<b>41</b>
Download media presets .....	41
Add a new substrate .....	41
Faster printing .....	51
Color calibration .....	51
Color profiles .....	52
Color reproduction tricks .....	52
<b>6 Troubleshoot print-quality issues .....</b>	<b>53</b>
General printing advice .....	53
Use the printhead status plot .....	53
Graininess .....	54
Horizontal banding .....	55
Vertical banding .....	57
The print is deformed into a curved shape .....	57
Misaligned colors .....	58
Color intensity varies .....	58
Lack of sharpness .....	59
Black areas look hazy .....	59
Ink smears .....	59
Subtle stains or uneven appearance .....	59
The ink smudges when touched, or looks oily .....	60
The dimensions of the print are wrong .....	60
Tiling issues .....	60
<b>7 Troubleshoot substrate issues .....</b>	<b>63</b>
The substrate cannot be loaded successfully .....	63
The substrate is mispositioned .....	63
The substrate has jammed .....	64
The substrate is deformed or wrinkled .....	66
The substrate has shrunk or expanded .....	66
The substrate has bow deformation .....	67
The automatic cutter does not work .....	68
Take-up reel substrate jam .....	68
Take-up reel does not wind .....	68
<b>8 Troubleshoot ink-system issues .....</b>	<b>71</b>
Ink maintenance kit needs to be installed .....	71

Cannot insert an ink cartridge .....	71
Cannot insert a printhead .....	71
Cannot insert the printhead cleaning cartridge .....	71
Front panel recommends reseating or replacing a printhead .....	71
Clean the printheads .....	72
Align the printheads .....	72
<b>9 Troubleshoot other issues .....</b>	<b>75</b>
The printer cannot get an IP address .....	75
Cannot access the Embedded Web Server .....	75
The printer is not printing .....	76
The software program slows down or stalls while generating the print job .....	76
The printer seems slow .....	76
Cannot access files on the hard disk .....	77
Communication failures between computer and printer .....	77
The platen rollers squeak .....	77
<b>10 Front-panel error messages .....</b>	<b>79</b>
Printer logs .....	84
<b>11 When you need help .....</b>	<b>85</b>
Introduction .....	85
Documentation .....	85
Customer Self Repair .....	85
HP Customer Care Centers .....	85
Service information .....	86
<b>Appendix A Summary of common printing problems .....</b>	<b>87</b>
<b>Index .....</b>	<b>89</b>



---

# 1 Safety precautions

Before using your printer, read the following safety precautions to make sure you use the equipment safely.

You are expected to have the appropriate technical training and experience necessary to be aware of hazards to which you may be exposed in performing a task, and take appropriate measures to minimize the risks to yourself and to other people.

## General safety guidelines

- Refer to the installation instructions before connecting the printer to the supply.
- There are no operator-serviceable parts inside the printer except those covered by HP's Customer Self Repair program (see <http://www.hp.com/go/selfrepair/>). Refer servicing of other parts to qualified service personnel.
- Turn off the printer, unplug both power cords from the power outlets, and call your service representative in any of the following cases.
  - The power cord or plug is damaged.
  - Liquid has entered the printer.
  - There is smoke or an unusual smell coming from the printer.
  - The printer has been dropped or the drying or curing module damaged.
  - The printer's built-in Residual Current Circuit Breaker (Ground Fault Circuit Interrupter) has been repeatedly tripped.
  - The printer is not operating normally.
- Turn off the printer and unplug both power cords from the power outlets in either of the following cases.
  - During a thunderstorm
  - During a power failure

## Electrical shock hazard

---

 **WARNING!** The drying and curing modules operate at hazardous voltages capable of causing death or serious personal injury.

---

The printer uses two power cords. Unplug both power cords before servicing the printer. The printer must be connected to earthed mains outlets only.

To avoid the risk of electric shock:

- Do not attempt to dismantle the drying and curing modules or the electrical control cabinet.
- Do not remove or open any other closed system covers or plugs.
- Do not insert objects through slots in the printer.
- Test the functionality of the Residual Current Circuit Breaker (RCCB) every 6 months.

## Heat hazard

The drying and curing subsystems of the printer operate at high temperatures and can cause burns if touched. To avoid personal injury, take the following precautions.

- Do not touch the internal enclosures of the printer's drying and curing modules. Even after opening the window latch that disconnects drying and curing power, the internal surfaces could be hot.
- Take special care when accessing the substrate path.

## Fire hazard

The drying and curing subsystems of the printer operate at high temperatures. Call your service representative if the printer's built-in Residual Current Circuit Breaker (Ground Fault Circuit Interrupter) is repeatedly tripped.

To avoid the risk of fire, take the following precautions.

- Use the power supply voltage specified on the nameplate.
- Connect the power cords to dedicated lines, each protected by a branch circuit breaker according to the rating of the wall socket. Do not use a power strip (relocatable power tap) to connect both power cords.
- Use only the power cords supplied by HP with the printer. Do not use a damaged power cord. Do not use the power cords with other products.
- Do not insert objects through slots in the printer.
- Take care not to spill liquid on the printer.
- Do not use aerosol products that contain flammable gases inside or around the printer.
- Do not block or cover the openings of the printer.
- Do not attempt to dismantle the drying or curing module, or the electrical control cabinet.
- Ensure that the operating temperature of the substrate loaded recommended by the manufacturer is not exceeded. If this information is not available from the manufacturer, do not load substrates that cannot be used at an operating temperature under 125°C (257°F).
- Do not load substrates with auto-ignition temperatures below 300°C (572°F). See note below.



**NOTE:** Test method based on EN ISO 6942:2002; Evaluation of materials and material assemblies when exposed to a source of radiant heat, method B. The test conditions, to determine the temperature when the substrate starts ignition (either flame or glow) were: Heat flux density: 30 kW/m<sup>2</sup>, copper calorimeter, K type thermocouple.

## Mechanical hazard

The printer has moving parts that could cause injury. To avoid personal injury, take the following precautions when working close to the printer.



- Keep your clothing and all parts of your body away from the printer's moving parts.
- Avoid wearing necklaces, bracelets and other hanging objects.
- If your hair is long, try to secure it so that it will not fall into the printer.
- Take care that sleeves or gloves do not get caught in the printer's moving parts.
- Avoid standing close to the fans, which could cause injury and could also affect print quality (by obstructing the air flow).
- Do not touch gears or moving rolls during printing.

## Heavy substrate hazard

Special care must be taken to avoid personal injury when handling heavy substrates.

- Handling heavy substrate rolls may require more than one person. Care must be taken to avoid back strain and/or injury.
- Consider using a forklift, pallet truck or other handling equipment.
- When handling heavy substrate rolls, wear personal protective equipment including boots and gloves.

## Ink handling

Your printer does not use solvent inks and does not have the traditional problems associated with them. However, HP recommends that you wear gloves when handling ink system components.





## Warnings and cautions



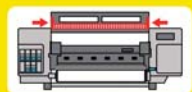

The following symbols are used in this manual to ensure the proper use of the printer and to prevent the printer from being damaged. Follow the instructions marked with these symbols.

 **WARNING!** Failure to follow the guidelines marked with this symbol could result in serious personal injury or death.

 **CAUTION:** Failure to follow the guidelines marked with this symbol could result in minor personal injury or damage to the product.

## Warning labels

Label	Explanation
	Risk of burns. Do not touch the internal enclosures of drying and curing modules of the printer.
  	Risk of burns. Do not touch the drying enclosure of the printer. Even after opening the window latch, which disconnects the power to the drying and curing modules, the internal surfaces could be hot.

Label	Explanation
	<p>Electric shock hazard. The printer has two input power cords. A voltage is still present in the drying and curing modules after the main switch is turned off. There are no operator-serviceable parts inside the printer. Refer servicing to qualified service personnel. Disconnect all power cords before servicing.</p>
<p><b>SEE INSTALLATION INSTRUCTIONS BEFORE CONNECTING TO THE SUPPLY.</b></p>	<p>See installation instructions before connecting to the supply. Ensure that the input voltage is within the printer's rated voltage range. The printer requires two dedicated lines, each protected by a branch circuit breaker according to the rating of the wall socket outlet. Use only earthed mains outlets and the power cords supplied by HP with the printer.</p>
	<p>Risk of trapped hands. Do not push the roll while loading. Lift the loading table to ease the spindle into the printer.</p>
	<p>Risk of trapped fingers. Do not touch spindle gears while moving.</p>
	<p>Do not put objects on top of the printer. Do not cover the top fans.</p>
	<p>You are recommended to wear gloves when handling ink cartridges, printhead cleaning cartridges and the printhead cleaning container.</p>

## 2 Printer status

### Check printer status

You can check the current status of the printer in the following ways:

- The Embedded Web Server displays the status of the printer, the loaded substrate and the ink system.

To use the Embedded Web Server, enter your printer's URL into your Web browser. The URL is displayed on the printer's front panel: it is **http://192.168.1.1** in the example below:

Ready for substrate

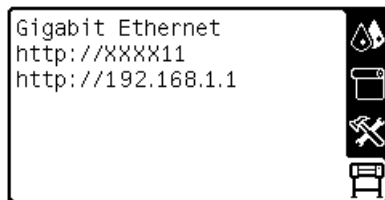

- The front panel displays the ink levels by default; otherwise, you can see the ink levels by selecting the Ink System icon . In addition, the most important current alert, if any, is displayed in the front panel.

### Check the status of the ink system

1. Access the Embedded Web Server (see above).
2. Go to the Supplies page on the **Main** tab.



The Supplies page shows you the status of the loaded substrate, the ink cartridges, the printheads, the heaters, the printhead cleaning kit, the ink funnel and the ink maintenance kit.

The traffic light shows whether maintenance is required. For further information, click **View details**.

## Check the status of the ink cartridges

To view the ink levels in your ink cartridges, go to the printer's front panel and select the  icon.

Click the + sign for more details, or use the ink menu.

You can also view the status of the ink cartridges in the Embedded Web Server.

### Ink menu procedure

1. On the front panel, select the  icon, then select **Ink cartridge information**.
2. Select the cartridge about which you want information.
3. The front panel shows the following information:
  - Color
  - Product name
  - Product number
  - Serial number
  - Status
  - Ink level, if known
  - Total ink capacity in milliliters
  - Expiration date
  - Warranty status
  - Manufacturer

## Check the status of a printhead

The printer automatically checks and services the printheads after each print. Follow these steps to get more information on your printheads.

1. On the front panel, select the  icon, then select **Printhead information**.
2. Select the printhead for which you want to see information.
3. The front panel shows the following information:
  - Colors
  - Product name
  - Product number
  - Serial number
  - Status (see [Front-panel error messages on page 79](#))
  - Volume of ink it has used
  - Warranty status

You can also use the Embedded Web Server to check the printhead status and the warranty status.



**NOTE:** If the warranty status is **See warranty note**, this indicates that non-HP ink is being used. Printer service or repairs required as a result of using "non-HP" ink are not covered under warranty. See the *Legal Information* document for detailed warranty implications.

## Check the file system

It is possible to check the integrity of the file system on the printer's hard disk, and automatically correct any errors. You are recommended to do this about once every six months, or if you notice any trouble in accessing files on the hard disk.

To execute the file system check, go to the front panel and select the  icon, then select **File system check**.

If the printer is aware of damage to the file system, for instance after a severe software problem, it may start a file system check automatically. This can take about half an hour.

## Printer alerts

The printer can communicate two types of alerts:

- **Errors:** When the printer is unable to print.
- **Warnings:** When the printer needs attention for an adjustment, such as a calibration, preventive maintenance or ink cartridge replacement.

Printer alerts appear in the front panel and in the Embedded Web Server. In some cases, the printer may also make an audible beep to draw your attention to the alert. If you do not want to hear the beeps, you can disable them from the front panel.

- **Front-panel display:** The front panel shows only one alert at a time, which is judged to be the most important. It generally requires the user to press the **OK** key for confirmation, but in the case of a warning, it disappears after a while. Some alerts reappear when the printer is idle and there is nothing more important to report.
- **Embedded Web Server:** The alert displayed in the front panel also appears in the top right corner of the Embedded Web Server window.

An alert may require you to perform a maintenance operation; see [Hardware maintenance on page 11](#).

The following alerts require a service engineer:

- **Service Maintenance Kit 1**
- **Service Maintenance Kit 2**
- **Service Maintenance Kit 3**



---

## 3 Firmware update

The printer's various functions are controlled by software that resides in the printer, also known as firmware.

From time to time, firmware updates from Hewlett-Packard become available. These updates increase the printer's functionality and enhance its features.

Firmware updates can be downloaded from HP's Web site (<http://www.hp.com/go/graphic-arts/>) and installed in your printer using the printer's Embedded Web Server.

To access the Embedded Web Server from any computer, see [Check printer status on page 5](#).

In the Embedded Web Server, select the **Setup** tab and then **Firmware update**.

Follow the on-screen instructions to download the firmware file and store it on your hard disk. Then select the downloaded file and click **Update**.

If you experience very slow progress while uploading the firmware file to the printer, the reason could be that you are using a proxy server. In that case, try bypassing the proxy server and accessing the Embedded Web Server directly.

- In Internet Explorer 6 for Windows, go to **Tools > Internet Options > Connections > LAN Settings**, and select the **Bypass proxy server for local addresses** check box. Alternatively, for more precise control, click the **Advanced** button and add the printer's IP address to the list of exceptions, for which the proxy server is not used.
- In Firefox 3.0 for Windows, go to **Tools > Options > Network > Connection > Settings**, and select the **Direct connection to the Internet** check box. Alternatively, when the **Manual proxy configuration** check box is selected, add the printer's IP address to the list of exceptions, for which the proxy server is not used.
- In Firefox 2.0 for Linux, go to **Edit > Preferences > Network > Connection > Settings**, and select the **Direct connection to the Internet** check box. Alternatively, when the **Manual proxy configuration** check box is selected, add the printer's IP address to the list of exceptions, for which the proxy server is not used.





---

## 4 Hardware maintenance

For the tasks in this chapter, you may need the User Maintenance Kit that was provided with your printer.

### Ink system tips

For best results, always follow these guidelines:

- Follow the instructions on the front panel during installation.
- Allow the printer and the printhead cleaning cartridge to clean the printheads automatically.
- Avoid unnecessary removal of the ink cartridges and printheads.
- The ink cartridges should never be removed while the printer is printing. They should be removed only when the printer is ready for you to replace them. The front panel guides you through the replacement procedure.
- Make sure that you comply with all applicable laws and regulations when disposing of ink system consumables.



---

**NOTE:** Shake the ink cartridges and printheads vigorously before installing them.

---

### Align the printheads

The printer performs printhead alignment whenever printheads are replaced. If no substrate is loaded when a printhead is replaced, the printer will perform the alignment the next time you load substrate.

You may also be recommended to align the printheads to solve a print-quality problem.

#### Automatic alignment

First make sure that you have a roll of opaque, white substrate loaded in the printer. Colored substrates, glossy canvas, and transparent materials such as translucent bond, clear film, tracing substrate, and vellum are not suitable for automatic printhead alignment; for these substrates, you should align the printheads manually (see [Manual alignment on page 12](#)).

To request printhead alignment from the front panel (if the alignment is not performed automatically), select the  icon, then select **Image quality maintenance > Align printheads > Auto PH alignment**.

To request printhead alignment from the Embedded Web Server, select the **Setup** tab, then select **Printhead alignment > Automatic printhead alignment > Print**.

The process takes about 10 minutes and starts immediately, unless an image is currently being printed. If a print job is in process, the alignment will be done as soon as the current print job is finished.

## Manual alignment

To request a manual printhead alignment from the front panel, select the  icon, then select **Image quality maintenance > Align printheads > Manual PH alignment > Print alignment pattern**.

To request manual printhead alignment from the Embedded Web Server, select the **Setup** tab, then select **Printhead alignment > Manual printhead alignment > Print**.

The printer prints 17 rows labelled from A to Q. Inspect the print and write down the number of the straightest line in each row (for example, A:9).



When you have done this, enter the correction values into the front panel or the Embedded Web Server.

To enter the correction values in the front panel, select the  icon, then select **Image quality maintenance > Align printheads > Manual PH alignment > Enter correction values**. Enter each value into the window labelled with the same letter as the corresponding pattern.

To enter the correction values in the Embedded Web Server, select the **Setup** tab, then select **Printhead alignment > Manual printhead alignment**, and enter each value into the window labelled with the same letter as the corresponding pattern.

## Check substrate porosity

To check the porosity of your substrate, proceed as follows.

1. If the printer has any substrate loaded, unload it.
2. Cut a piece of self-adhesive vinyl white gloss 15 × 50 mm (0.6 × 2 in) in size.
3. Stick it to the platen as shown.



4. Load the substrate that you want to check.
5. Open your RIP software.

6. Download the test file from inside the printer: **[http://printerIP/hp/device/webAccess/images/Ink\\_trespassing\\_check.pdf](http://printerIP/hp/device/webAccess/images/Ink_trespassing_check.pdf)**, where *printerIP* is the IP address of your printer.
7. Print the test file using the number of passes and media profile that you intend to use in future with this substrate (or a similar profile in terms of ink limit).
8. Unload the substrate.
9. Remove the strip of self-adhesive vinyl from the platen.



10. Compare the optical density (darkness) of the strip with the gray rectangle below.

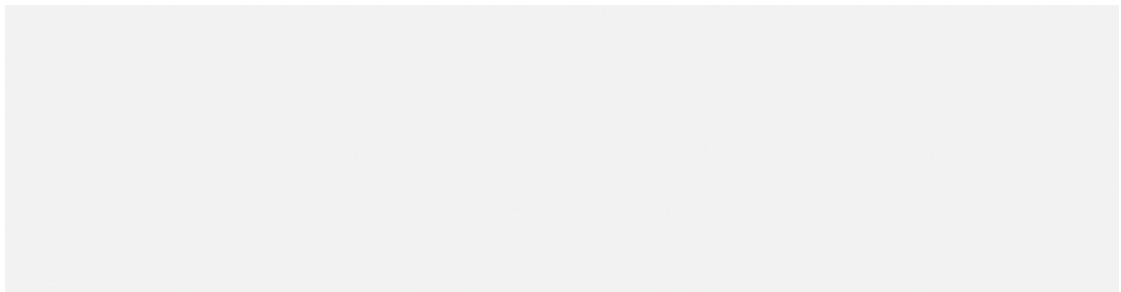

- If the strip is completely white (has no ink on it), the tested substrate is non-porous and can be used for printing as described in the *User's guide*.
- If the strip is lighter than the gray rectangle above, the tested substrate can be used for printing, but the platen should be cleaned immediately after each printing session (see [Clean the platen on page 17](#)).
- If the strip is darker than the gray rectangle above, the tested substrate is too porous, and is not supported for use with your printer.

## Clean the electrical connections on a printhead

It is possible that the printer will not recognize a printhead after it has been installed. This can happen when ink builds up on the electrical connections between the printhead and the printhead carriage. Under these circumstances, HP recommends that you clean the electrical connections on the printhead. However, routine cleaning of the connections when no problems are apparent is *not* recommended.

A carriage interconnect wiper is included with your printer in the User Maintenance Kit.

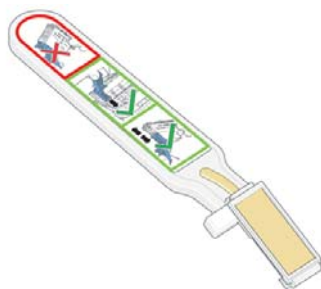

Use this to clean the electrical interconnects on both the printhead carriage and the printhead if the **Reset** or **Replace** message persists next to the printhead on the front-panel display.

1. Remove a new pre-moistened replacement sponge from its pouch.

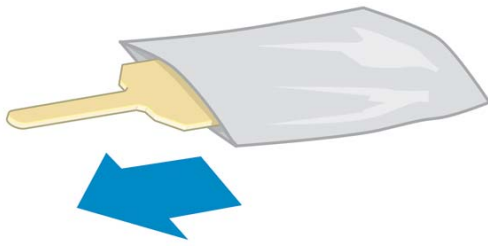

A supply of sponges is included in the box with the wiper. If all sponges have been used, more can be obtained by calling your service representative.

2. Open the carriage interconnect wiper.



3. Load the sponge by positioning the sponge on the face of the carriage interconnect wiper with the shorter tab in the locating slot.

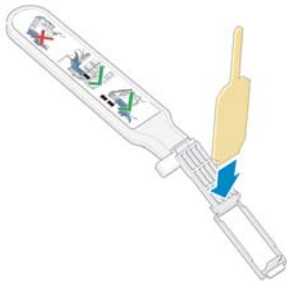

4. Close the carriage interconnect wiper, trapping the sponge in place.

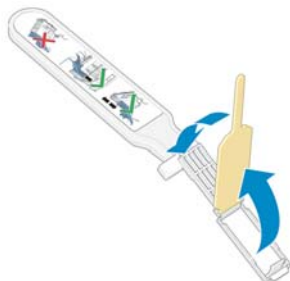

5. Open the printhead carriage latch and extract the printhead that is causing the problem, as indicated on the front panel. See [Replace a printhead on page 30](#).

6. Insert the carriage interconnect wiper into the printhead slot at the back. Wipe the electrical contacts by inserting the tool between the electrical connections at the back of the slot and the steel spring, with the sponge facing away from you and towards the electrical contacts. Try to avoid picking up any ink deposit that may have accumulated on the bottom surface of the slot.

**CAUTION:** If the carriage remains in the central part of the printer for more than 7 minutes, it attempts to return to its home position to the right.

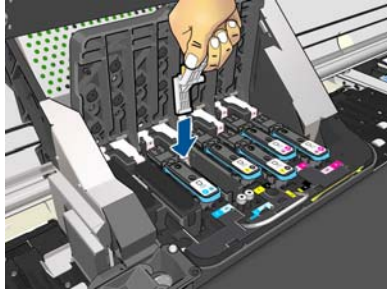

7. Rub the sponge against the contacts with a *light* force along the entire depth of the flex connector, inserting the wiper as far as allowed by the mechanical stop on the tool.

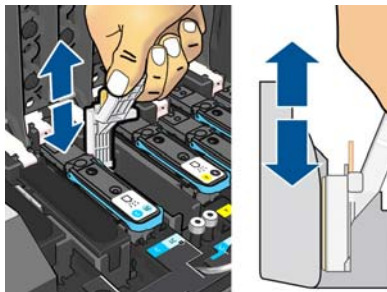

8. Take special care to clean all contacts thoroughly, including the ones at the lowest point of the connector.

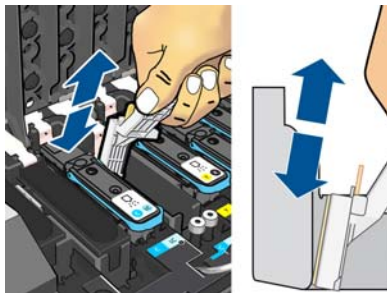

9. Using the same sponge, clean the lower strip of electrical contacts on the printhead (unless the printhead is new). Avoid touching the upper set of electrical contacts.

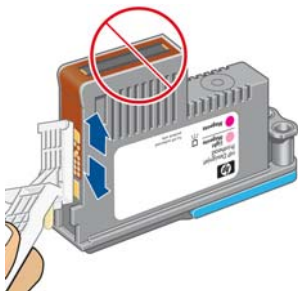

**CAUTION:** Do not touch the surface of the printhead that contains the nozzles, because the nozzles are easily damaged.

10. After waiting a few moments to allow both connectors to dry, replace the printhead into the printhead carriage. See [Replace a printhead on page 30](#).
11. After completing the cleaning process, open the carriage interconnect wiper by pulling on the sponge tab.



12. Remove the soiled sponge from the carriage interconnect wiper.

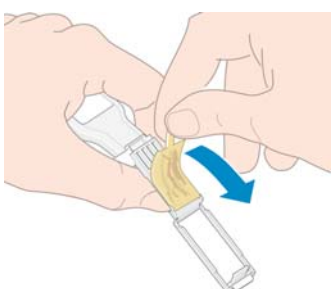

13. Dispose of the soiled sponge in a safe place to prevent the transfer of ink onto hands and clothing.

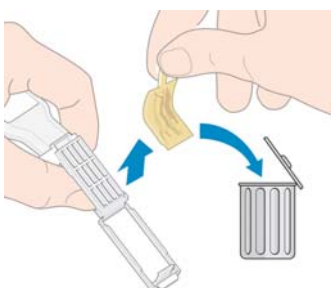

If the front panel continues to show the **Reseat** or **Replace** message, replace the printhead or call your service representative.

## Clean the exterior of the printer

Use a damp sponge or a soft cloth and a mild household cleaner such as non-abrasive liquid soap to clean the outside of the printer and all other parts of the printer that you regularly touch as part of normal operation (for example, ink cartridge drawer handles).

There may be some dampness from condensation under the fans of the curing module, which should be wiped with a dry cloth.

- 
- WARNING!** To avoid an electric shock, make sure that the printer is turned OFF and unplugged before you clean it. Do not let water get inside the printer.
  - CAUTION:** Do not use abrasive cleaners on the printer.
-

## Clean the platen

You should clean your printer's platen every few months, or when necessary.

 **NOTE:** If you print on wide substrate after having printed on narrower substrate, you may find that the left side of the platen has become dirty. If this contaminated section of the platen is not cleaned, it could leave marks on the back of the substrate.

 **CAUTION:** Be careful not to damage the substrate-advance sensor when cleaning the platen. The sensor is the very small rectangular window (less than 1 cm<sup>2</sup>) found close to the third pinchwheel from the right. See [Clean the substrate-advance sensor window on page 19](#).

Follow these instructions to clean the platen.

1. Unload all substrate from the printer. See the *User's guide*.
2. Turn off the printer and wait until it has cooled down, then unlock and open the printer window.

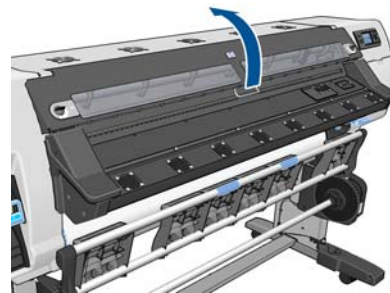
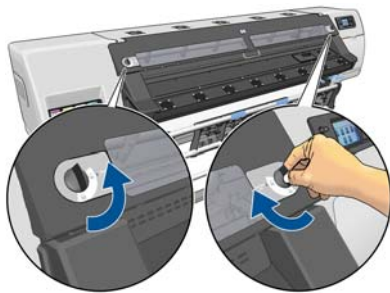

3. Use a clean, absorbent lint-free cloth to thoroughly wipe any wet ink from the cutter groove, cutter ramp and platen.
4. With a dry brush, remove dry, loosened ink deposits from the cutter groove and cutter ramp. A brush is available in the User Maintenance Kit.

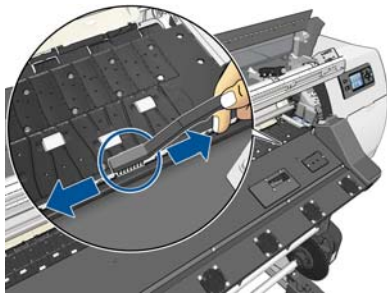

5. With the same dry brush, remove dry, loosened ink deposits from the platen surface.

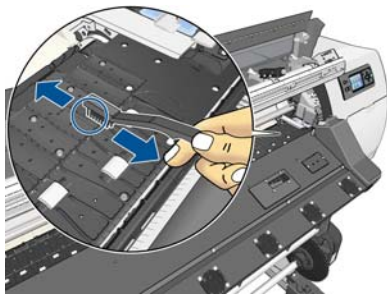

6. Slightly dampen the used cloth with 95% ethanol to wipe the remaining dry ink deposits from the platen.

 **NOTE:** 95% ethanol is not provided in the User Maintenance Kit.

 **CAUTION:** Ethanol is highly flammable. Observe the manufacturer's safety precautions.

**CAUTION:** Do not use commercial cleaners or abrasive cleaners. Do not wet the platen directly, because you will leave too much moisture behind, which could damage the substrate advance sensor.

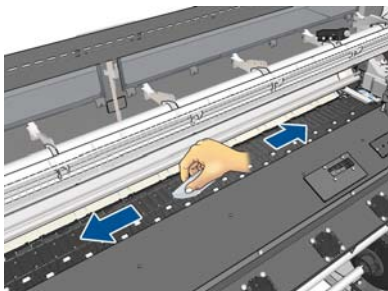

7. Use the damp cloth to remove remaining dry ink deposits from the cutter ramp.

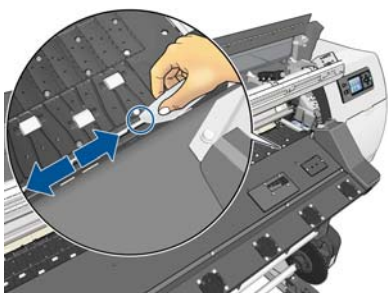

8. Use a dry cloth to clean the exposed part of the wheels. Ideally, you should clean the entire circumference of these wheels.

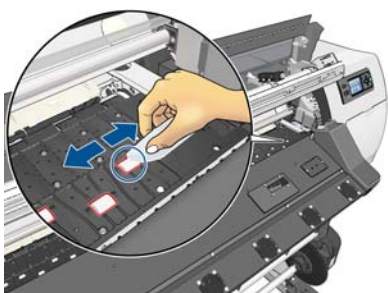

9. Remove the 95% ethanol and the cloth from the vicinity of the printer.
10. Wait 3 or 4 minutes to let the ethanol evaporate, before turning on the printer and reloading the substrate.
11. With a 1 mm diameter pin ensure that the vacuum holes are not obstructed, especially the holes that are covered by the most-used substrate sizes.

## Clean after porous substrates

If you print on a porous substrate (through which ink can pass), you should clean the platen immediately after each printing session. Do not, for instance, leave the printer overnight or load a new roll without cleaning the platen first.



When printing on a textile or thin substrate, you may find condensation in the input area of the printer. You are recommended to wipe it away with a dry cloth, at least before loading a new roll.



## Clean (recover) the printheads

To clean the printheads (which often enables them to recover from problems), go to the printer's front panel and select the  icon, then select **Image quality maintenance** > **Clean printheads**. Specify which printheads you would like to clean. You can clean all of the printheads or only some of them. Select from the following options.

- Print test plot
- Clean all
- Clean LC-C
- Clean Y-MK
- Clean LM-M

Cleaning all printheads takes about 5 minutes. Cleaning any two printheads takes about 3 minutes.

---

 **NOTE:** Cleaning all printheads uses more ink than cleaning a single pair.

---

## Clean the substrate-advance sensor window

The substrate-advance sensor is the very small rectangular window (less than 1 square centimeter in size) close to the third pinchwheel from the right.

HP recommends that you clean the substrate-advance sensor window whenever you clean the print platen and if you are experiencing print quality issues.

1. Unload the substrate by using the front panel procedure. See the *User's guide*.
2. Turn off the printer and wait until it has cooled down.

3. Wipe the sensor with one of the cotton swabs provided in the User Maintenance Kit, slightly dampened with 95% ethanol, to remove dried ink.

 **NOTE:** 95% ethanol is not provided in the User Maintenance Kit.

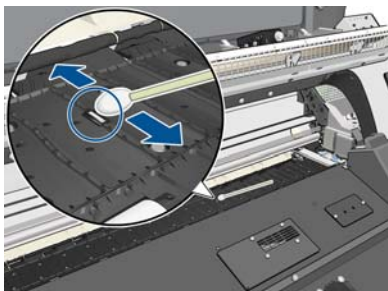

If the sensor window is heavily coated with dried ink, you may need to apply some pressure while wiping, helping the cotton to absorb the ink. Continue cleaning with fresh swabs until the cotton stays clean and the sensor window looks clean. When reflecting ambient light, a clean sensor shows a blue-colored reflection that should extend uniformly across its whole surface. You can see this reflection by moving closer and slightly changing your angle of view.

4. Remove the 95% ethanol and the cotton swabs from the vicinity of the printer.
5. Wait three or four minutes to let the ethanol evaporate, before turning on the printer and reloading the substrate.

## Clean and lubricate the carriage rail

 **NOTE:** Under some workflows, or/and site conditions such as in warm ambient temperature, which are above the printer's operation specification (above 30°C(86°F)), or if there is significant ambient dust; the lubrication of the slider rods can be reduced or affected, which can in turn affect the performance of the printer.

 **NOTE:** A visual explanation of the procedure to clean and lubricate the carriage rail can be found here: <http://www.hp.com/go/L26500/videos>

1. To gain access to the carriage, go to the front panel and select the  icon, then select **Carriage rail lubrication**.
2. Unlock and open the window.

3. Clean the carriage rail using a lint-free cloth dampened with 95% ethanol. Take care to clean the whole rail, including the part under the left cover.

 **NOTE:** 95% ethanol is not provided in the Maintenance Kit.

 **CAUTION:** Ethanol is highly flammable. Observe the manufacturer's safety precautions.

**CAUTION:** Do not use commercial cleaners or abrasive cleaners.

**CAUTION:** While cleaning, be careful not to damage the metal strip located on top of the rail.

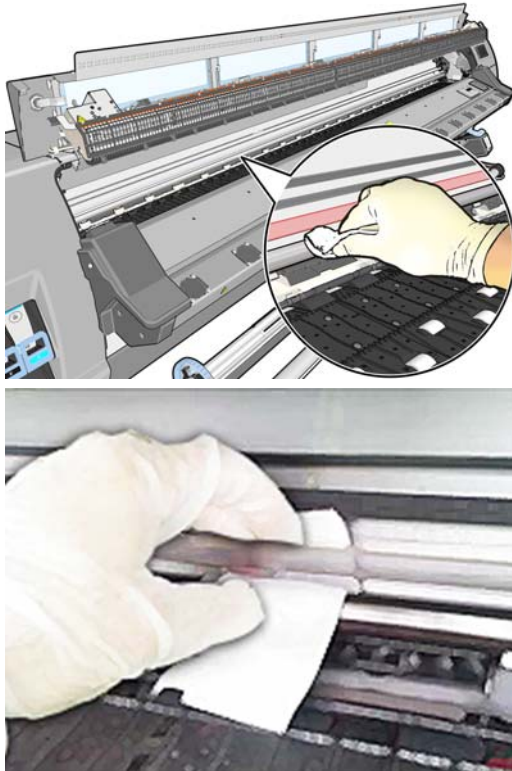

4. Wait until the rail is dry, then close the window. The carriage moves to the center of the printer so that you can reach the part of the rail under the right cover.
5. Unlock and open the printer window.
6. Clean the carriage rail area under the right cover as described in step 3.
7. Take the bottle of oil from the Maintenance Kit that is supplied with your printer (a replacement kit can be ordered if necessary).

8. Deposit a very thin zig-zag trickle of oil along the rail on both sides of the carriage. There is a video showing the process here: <http://www.hp.com/go/L26500/videos>

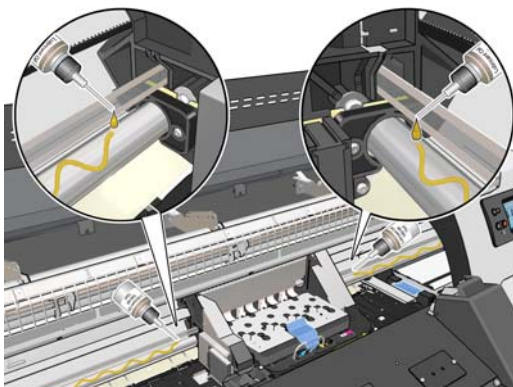

 **NOTE:** While lubricating, be careful not to drop oil on the metal strip located on top of the rail.

9. Clean the substrate jam reflector using a lint-free cloth dampened with distilled water. If you find dried ink that you cannot remove, try using a lint-free cloth dampened with 95% ethanol.

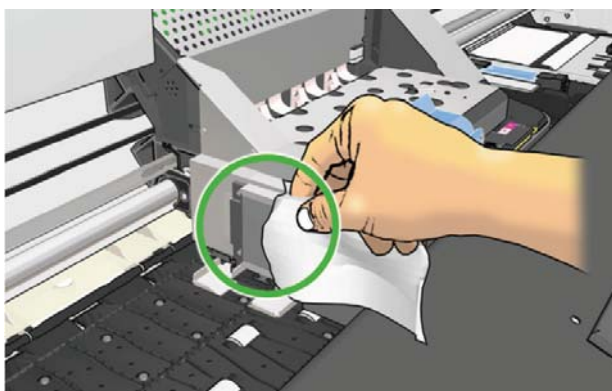

10. Press **OK** at the front panel.
11. Close and lock the window.
12. The Carriage Assembly moves along the rail to distribute the oil along the rail.
13. The Front Panel prompts for confirmation that the lubrication processes has been done. Press **OK** to confirm.

## Maintain the ink cartridges

During the normal lifetime of a cartridge, no specific maintenance is required. You should replace a cartridge when it has reached its expiration date. See the ink cartridge information on the front panel for the expiration date.

## Move or store the printer

If you need to move your printer or store it for an extended period of time, prepare it correctly to avoid possible damage.

1. Do not remove the ink cartridges, printheads or printhead cleaning cartridge.
2. Make sure that no substrate is loaded.
3. Make sure that the printhead carriage is located in the service station (at the right end of the printer).

4. Make sure that the **Ready** message appears on the front panel.
5. Turn off the power by using the **Power** button on the front panel.
6. Also switch off the power switch at the rear of the printer.
7. Disconnect the two power cables and any cables that connect the printer to a network, a computer, or a scanner.
8. If you have a take-up reel installed, remove the take-up reel sensor and cable-housing unit from the foot of the printer stand. When reinstalling the housing unit, make sure that the wheel on the foot of the printer stand is pointing forward.
9. If you intend to turn the printer upside down or on its side, first remove the waste management system (see [Replace the ink maintenance kit on page 27](#) and [Replace the printhead cleaning kit on page 35](#)).
10. For correct environmental storage conditions, see the specifications in the *User's guide*.

 **NOTE:** If the printer or ink cartridges are moved from a cold location to a warm and humid location, water from the atmosphere can condensate on the printer parts and cartridges and can result in ink leaks and printer errors. In this case, HP recommends that you wait at least 3 hours before turning on the printer or installing the ink cartridges, to allow the condensate to evaporate.

## Replace an ink cartridge

Ink cartridges should be replaced for the following two reasons:

- The ink cartridge is very low and you want to replace it with a full cartridge for unattended printing. You can use the remaining ink in the first cartridge at a more convenient time.
- The ink cartridge is empty or faulty, and you must replace it to continue printing.

C cartridge is out of ink

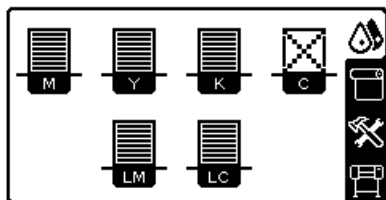

 **CAUTION:** The procedure to remove an ink cartridge must be initiated from the front panel. Do not remove an ink cartridge until the front panel prompts you. If you remove an ink cartridge incorrectly, the printer may subsequently reject that cartridge.

**CAUTION:** Remove an ink cartridge only if you are ready to insert another one.

**CAUTION:** Avoid touching pins, leads and circuitry when handling ink cartridges because these elements are sensitive to electrostatic discharge, which can reduce the life expectancy of the device.

 **WARNING!** Make sure that the printer wheels are locked (the brake lever is pressed down) to prevent the printer from moving.

### Remove an ink cartridge

1. On the printer's front panel, select the  icon, then select **Replace ink cartridges**.

## Ink

- ▶ Replace ink cartridges
- ▶ Replace printheads
- ▶ Replace PH cleaning kit
- ▶ Replace ink mainten. kit
- ▶ Repair ink mainten. kit
- ▣ Image quality maintenance
- ▣ Ink cartridge information

2. Grip the blue tab in front of the cartridge that you want to remove.



3. Pull the blue tab down and then pull it outwards, towards you.





4. The cartridge comes out, in its drawer.

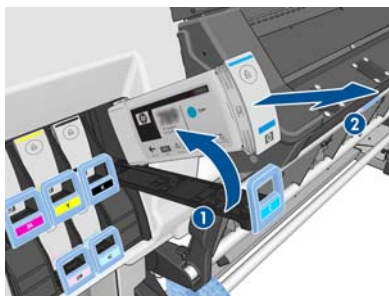

- Lift the cartridge out of its drawer.



 **NOTE:** Avoid touching the end of the cartridge that is inserted into the printer, because the connection might be coated with ink.

 **NOTE:** If necessary, store a partially-used ink cartridge in the same position as if it were inserted in the printer. Avoid using a partially-used cartridge that has been stored on its end.

- The front-panel display identifies the missing ink cartridge.

Ink cartridge missing.  
Install ink cartridge

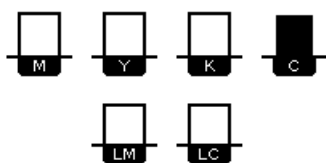

### Insert an ink cartridge

- Pick up the new ink cartridge and find the label that identifies the ink color. Hold the ink cartridge so that you can see the label at the top of the side that is facing you.
- Check that the colored label above the empty slot in the printer matches the color of the label on the cartridge.
- Shake the cartridge vigorously for about 15 seconds.



- Insert the ink cartridge into the cartridge drawer.



5. Slide the drawer and cartridge into the slot until they lock into position.



6. The front-panel display confirms that all cartridges have been correctly inserted.

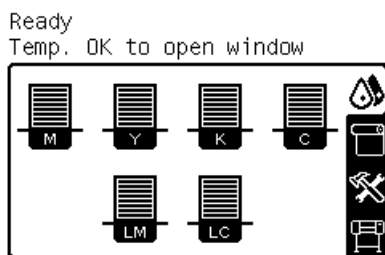

## Refilled and non-HP ink cartridges

HP recommends that you replace an empty cartridge with a new HP cartridge.

The use of refilled or non-HP ink cartridges has several disadvantages.

- If printer failure or damage is attributable to the use of a non-HP or refilled ink cartridge, HP will charge its standard time and materials charges to service the printer for the particular failure or damage.
- If failure or damage to printheads, ink cartridges, or other ink supplies is attributable to the use of non-HP, expired or refilled ink cartridge, HP is not responsible for the cost of replacement.
- Print quality may be impaired.
- The printer will be unable to estimate the ink level in the cartridge, and will report it as empty.

If you decide to use refilled or non-HP ink cartridges, you will need to follow these instructions to make the printer use a cartridge that it believes to be empty.

**CAUTION:** Running completely out of ink can damage the printheads. Damage attributable to printing with empty ink cartridges is not covered under warranty. Forcing the printer to accept empty cartridges will empty the ink delivery system as well. Once emptied, ink must be used to refill the system and reprime the printhead when a new ink cartridge is installed.

1. Install the cartridge in the printer (see [Replace an ink cartridge on page 23](#)).
2. The front panel will complain that the cartridge is empty, and the cartridge removal process will start. Press the **Cancel** key to stop this automatic process.
3. At the front panel, select the  icon.
4. Highlight **Replace ink cartridges**, but do not select it.
5. Press the **Cancel** key and the **Up** key at the same time, and hold them down for at least two seconds.
6. The front panel will display a series of warning messages. In response to each message, press the **Cancel** key to cancel the process, or the **Select** key to confirm that you wish to continue.



When you have pressed **Select** in response to all warning messages, the front panel will give the usual ink cartridge status display, but the refilled or non-HP cartridge will be shown as empty with a warning sign.

## Replace the ink maintenance kit

The ink maintenance kit contains the ink funnel, the ink tube assembly and the ink filter. The front panel prompts you when these components need to be replaced.

 **NOTE:** When you have removed the ink tube assembly, you cannot reuse it: you must install a new assembly.

1. Open the ink maintenance kit and remove the spare ink tube cap, which will be used to cover the end of the old ink tube.
2. On the printer's front panel, select the  icon, then select **Replace ink mainten. kit**.

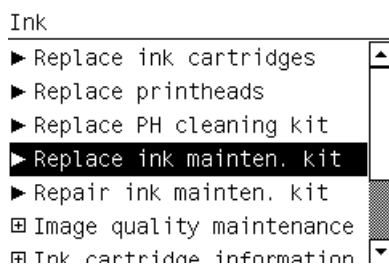

3. Pull the bottom of the ink tube assembly out of the printhead cleaning container.



4. Cover the end of the old ink tube with the spare cap from the ink maintenance kit, to prevent ink from falling out of the tube.



5. Unlock and open the window.

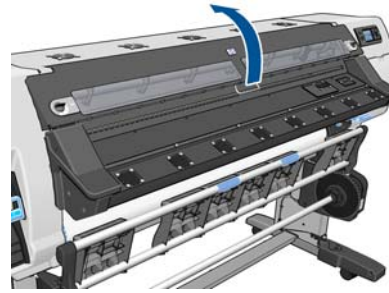
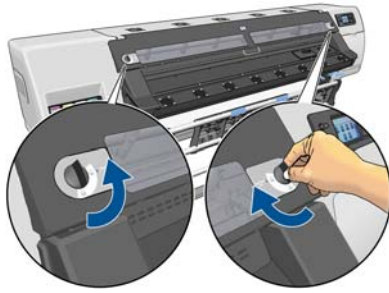

6. Locate the ink funnel.



7. Pull the slider with one finger while removing the ink funnel with the other hand.

 **NOTE:** You are recommended to wear gloves.

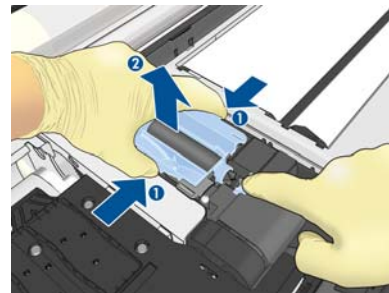

8. Remove the ink tube assembly support and the ink tube assembly.

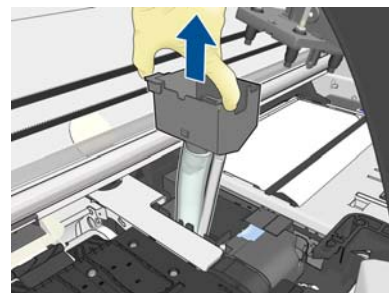

9. Insert the new ink tube assembly.

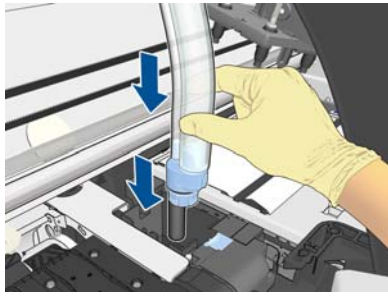

- 10.** Pull the slider with one finger while inserting the new ink funnel with the other hand.

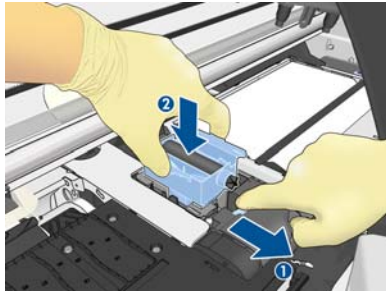

- 11.** Press the ink funnel into place.

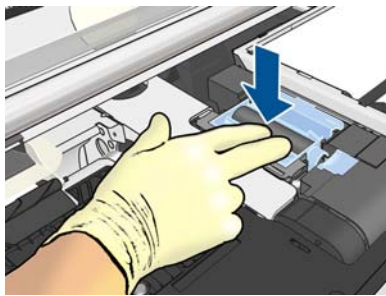

- 12.** Remove the cap from the bottom of the ink tube assembly.



- 13.** Insert the bottom of the ink tube assembly into the printhead cleaning container.



14. Open the ink filter cover.

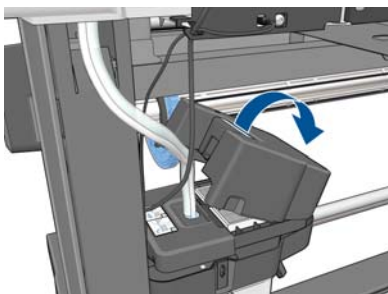

15. Remove the old ink filter and insert a new one.

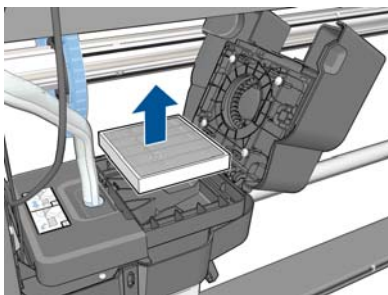

16. Close the ink filter cover.
17. Close and lock the window.

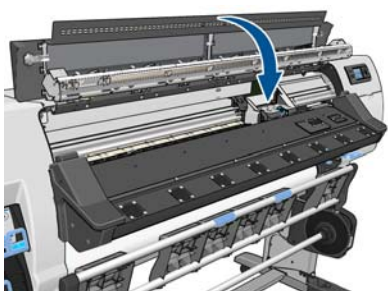

## Replace a printhead

### Remove a printhead

1. On the printer's front panel, select the  icon, then select **Replace printheads**.

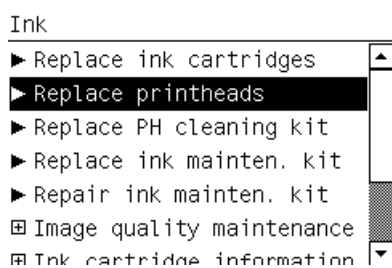

2. The carriage moves to the removal position.

 **CAUTION:** If the carriage remains in the removal position for more than 3 minutes without inserting or removing any printheads, it will attempt to return back to its home position to the right.

3. When the carriage has stopped moving, the front panel prompts you to open the printer window. Unlock and open the window.

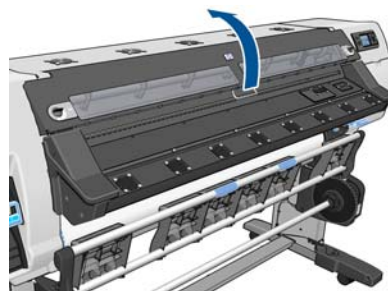
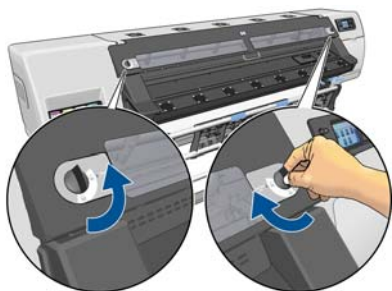

4. Locate the carriage on the right side of the printer.

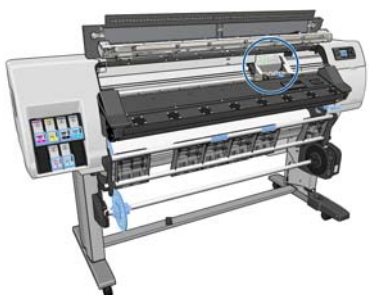

**⚠ CAUTION:** Avoid touching the printer's drying enclosure, which may be hot.

5. Pull up and release the latch on top of the carriage.

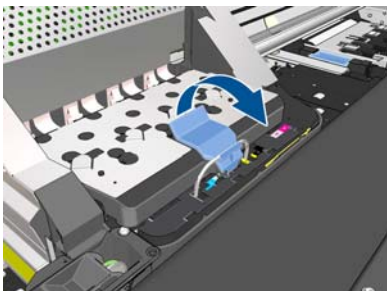

6. Lift up the cover. This provides access to the printheads.

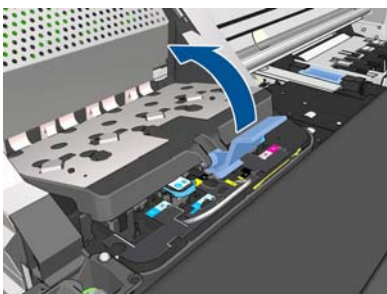

7. To remove a printhead, lift up the blue handle.

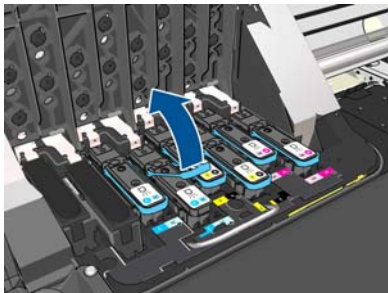

8. Using the blue handle, gently disengage the printhead.



9. Gently pull the blue handle upward until the printhead is released from the carriage.

**CAUTION:** Do not pull abruptly. That action can damage the printhead.

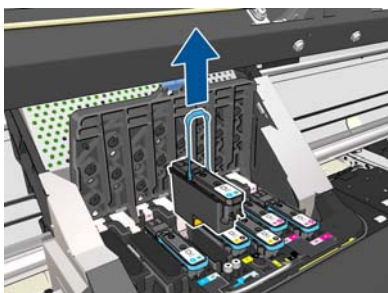

10. The front-panel display identifies the missing printhead.

C-LC printhead is missing

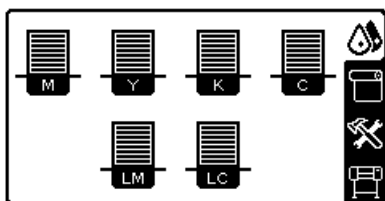

### Insert a printhead

1. If the printhead is new, shake it vigorously before removing the protective caps. Hold the printhead upright (with the protective caps facing down) and shake the printhead vigorously in a smooth up and down motion for about 15 seconds.

**NOTE:** Be careful not to strike the printhead against anything while shaking it, because this could cause damage.



2. Remove the orange protective caps by pulling them down.

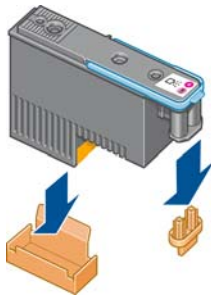

3. The printhead is designed to prevent you from accidentally inserting it into the wrong slot. Check that the colored label on the printhead matches the colored label of the carriage slot into which the printhead is to be inserted.
4. Insert the new printhead into its correct slot in the carriage.

**CAUTION:** Insert the printhead slowly and vertically, straight down. It can be damaged if you insert it too quickly, or at an angle, or if you rotate it as you insert it.

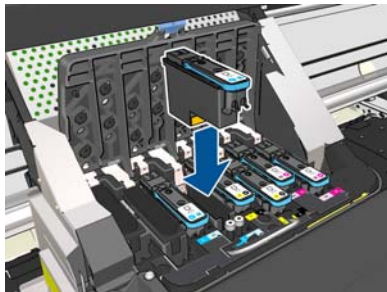

5. Push down as indicated by the arrow.

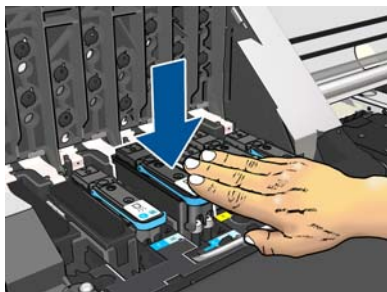

**CAUTION:** You might feel some resistance when installing the new printhead, so you need to press it down firmly but smoothly. You should hear a beep and see confirmation on the front-panel display that the printhead has been inserted.

6. Insert all of the other printheads that need to be installed, and close the carriage cover.

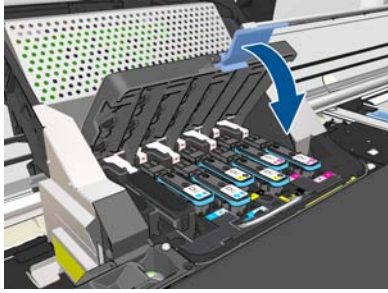

7. Make sure that the end of the latch catches the wire loop on the near side of the carriage.

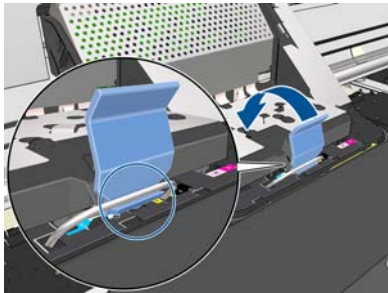

8. Lower the latch to rest on the carriage cover.



When all of the printheads have been inserted correctly and the printer has accepted them, the printer beeps.



**NOTE:** If the printer does not beep when you insert the printhead and the **Replace** message appears on the front-panel display, you might need to reinsert the printhead.

9. Close and lock the printer window.

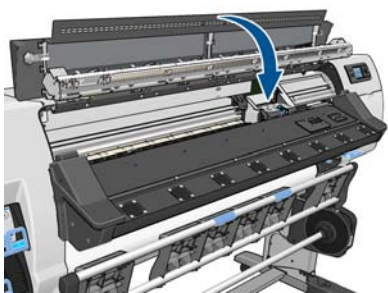

10. The front-panel display confirms that all of the printheads are correctly inserted. The printer starts checking and preparing the printheads. The default routine process, when all printheads are changed, takes up to 18 minutes. If the printer identifies a problem when preparing the printheads, the process takes longer, up to 30 minutes. For a single printhead insertion, the time varies between 10 and 20 minutes. After all printheads are checked and prepared, the printhead realignment procedure runs automatically if substrate is loaded.



# Replace the printhead cleaning kit

The printhead cleaning kit contains the printhead cleaning cartridge, the ink funnel and the ink filter.

When the front panel prompts you to replace the printhead cleaning kit, you should replace first the printhead cleaning cartridge, then the ink funnel, then the printhead cleaning container and ink filter.

 **NOTE:** The printhead cleaning container is not contained in the kit, but should be replaced at the same time. Therefore, make sure that you have a new printhead cleaning container ready, as well as a new printhead cleaning kit.

 **TIP:** If you want to remove and inspect the printhead cleaning cartridge at any time, you can start the following procedure. If you put the old printhead cleaning cartridge back into the printer after inspecting it, the procedure ends at that point.

1. On the printer's front panel, select the  icon, then select **Replace PH cleaning kit**.

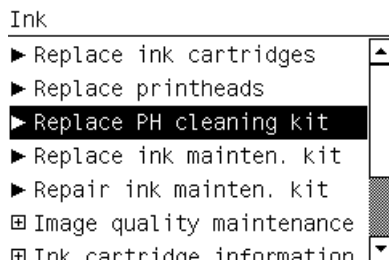

2. The printhead cleaning cartridge is located in a slot underneath the front panel, at the front of the printer. Open the door.

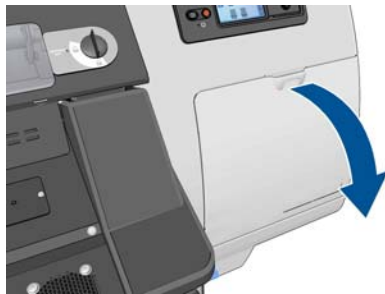

Follow these precautions when removing a printhead cleaning cartridge:

- Be careful not to get ink on your hands. Ink may be on, around and inside the replaced printhead cleaning cartridge.
- Always handle and store the replaced printhead cleaning cartridge upright to avoid spilling any ink.

 **WARNING!** Make sure that the printer wheels are locked (the brake lever is pressed down) to prevent the printer from moving.

3. The printhead cleaning cartridge has a handle on the front. To remove the cartridge, press inward and upward as indicated by the arrow, until the cartridge is released.



4. Lift up the printhead cleaning cartridge to remove it from the slot, and slide it out.



5. The plastic bag in which the new printhead cleaning cartridge comes can be used to dispose of the old printhead cleaning cartridge.
6. Remove the plastic cover from the new printhead cleaning cartridge.

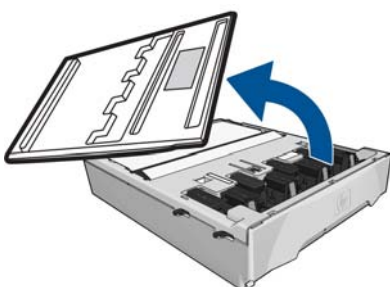

7. Insert the printhead cleaning cartridge into the slot, in the direction indicated by the arrow.



8. When the printhead cleaning cartridge has been pushed all the way in, press inwards and downwards as indicated, until it clicks into place.



 **NOTE:** The front panel will not show the new printhead cleaning cartridge until the door is closed.

9. When you have inserted the printhead cleaning cartridge into the printer, close the door.

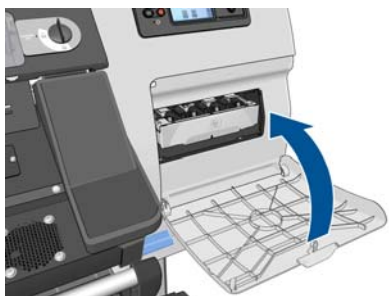

10. Unlock and open the window.

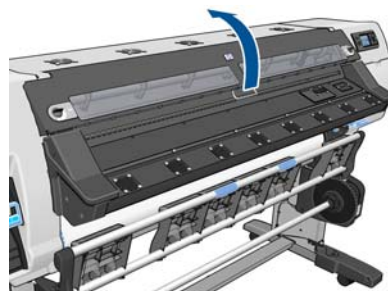
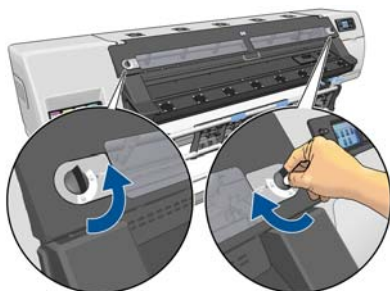

11. Locate the ink funnel.



12. Pull the slider with one finger while removing the ink funnel with the other hand.

 **NOTE:** You are recommended to wear gloves.

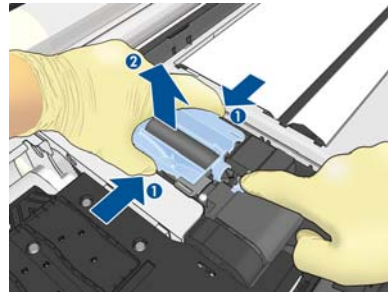
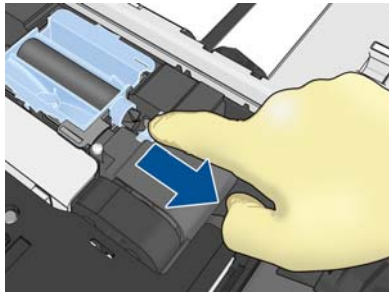

- 13.** Pull the slider with one finger while inserting the new ink funnel with the other hand.

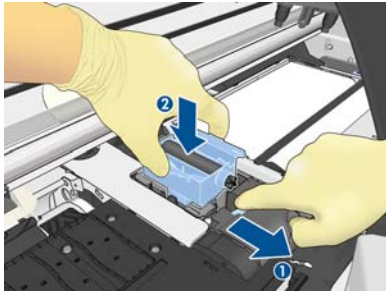

- 14.** Press the ink funnel into place.

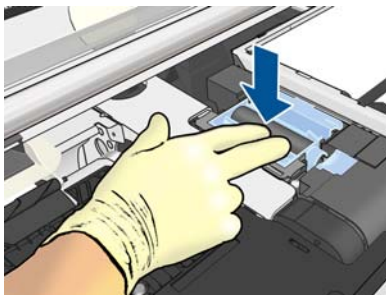

- 15.** Close and lock the window.

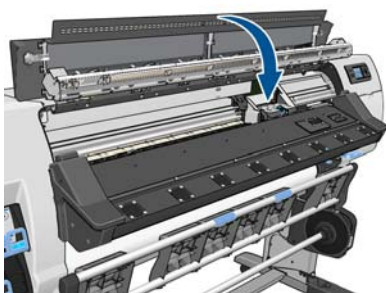

- 16.** Open the ink filter cover.

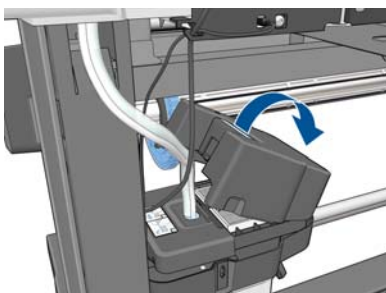

17. Remove the old ink filter and insert a new one.

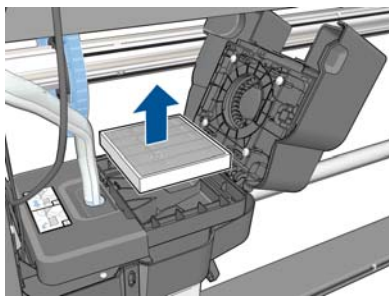

18. Close the ink filter cover.
19. Remove the printhead cleaning container.

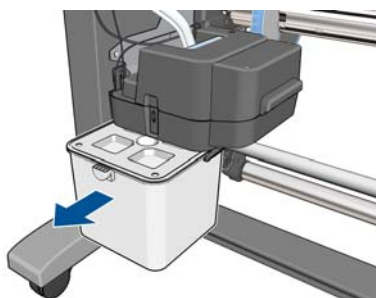

20. Insert the new printhead cleaning container.

 **NOTE:** Before it can resume printing, the printer needs all the ink cartridges, printheads and printhead cleaning cartridge to be installed, and the printer window and printhead cleaning cartridge door to be closed.

## Service maintenance

During the life of your printer, components that are used constantly can wear out.

To avoid having these components degrade to the point that the printer breaks down, the printer keeps track of the number of cycles that the printer carriage makes across the axis of the printer, and also monitors the total quantity of ink used.

The printer uses these numbers to track the need for service maintenance, and displays one of the following messages on the front panel:

- **Service Maintenance Kit 1**
- **Service Maintenance Kit 2**
- **Service Maintenance Kit 3**

These messages mean that some components are nearing the end of their lives. You can continue printing for quite some time, depending on your use of the printer. However, HP strongly recommends that you call your service representative and arrange for a service maintenance visit. The service engineer can then replace the worn parts on-site, which will prolong the life of the printer.

The benefits of arranging a service engineer's visit when these messages appear on the front panel are two-fold:

- The printer components can be replaced at a time that is convenient for you, and so will not disturb your daily workflow.
- During a service maintenance visit, the service engineer replaces several parts at once. This eliminates the need for repeat visits.



---

# 5 Substrate settings

## Download media presets

Each supported substrate has its own characteristics. The printer changes the way it prints on each different substrate. The RIP requires a description of the requirements of each substrate. This description is called the “media preset”.

The media preset contains the ICC color profile, which describes the color characteristics of the substrate. It also contains information about other characteristics (RIP and printer settings) and requirements of the substrate that are not directly related to color. Media presets for your printer are installed in the RIP.

The RIP contains media presets for only the most commonly used substrates. If you buy a substrate for which your RIP has no preset, you can obtain a preset for a new substrate in the following ways:

- Try to download the media preset from the substrate manufacturer’s Web site.
- If it is not there, try to download it from the RIP company’s Web site.
- If it is not there, check availability using the HP Media Finder search application located at <http://www.hp.com/go/latexmediafinder/>
- If you cannot find it anywhere, create a new media preset in the RIP. See [Add a new substrate on page 41](#).
- Further information can be found at and <http://www.hp.com/go/L26100/solutions/>.

## Add a new substrate

This section is provided in case you decide to make your own media preset. Normally there is no need to do this if you can find ready-made presets for all the substrates that you use.

## Summary

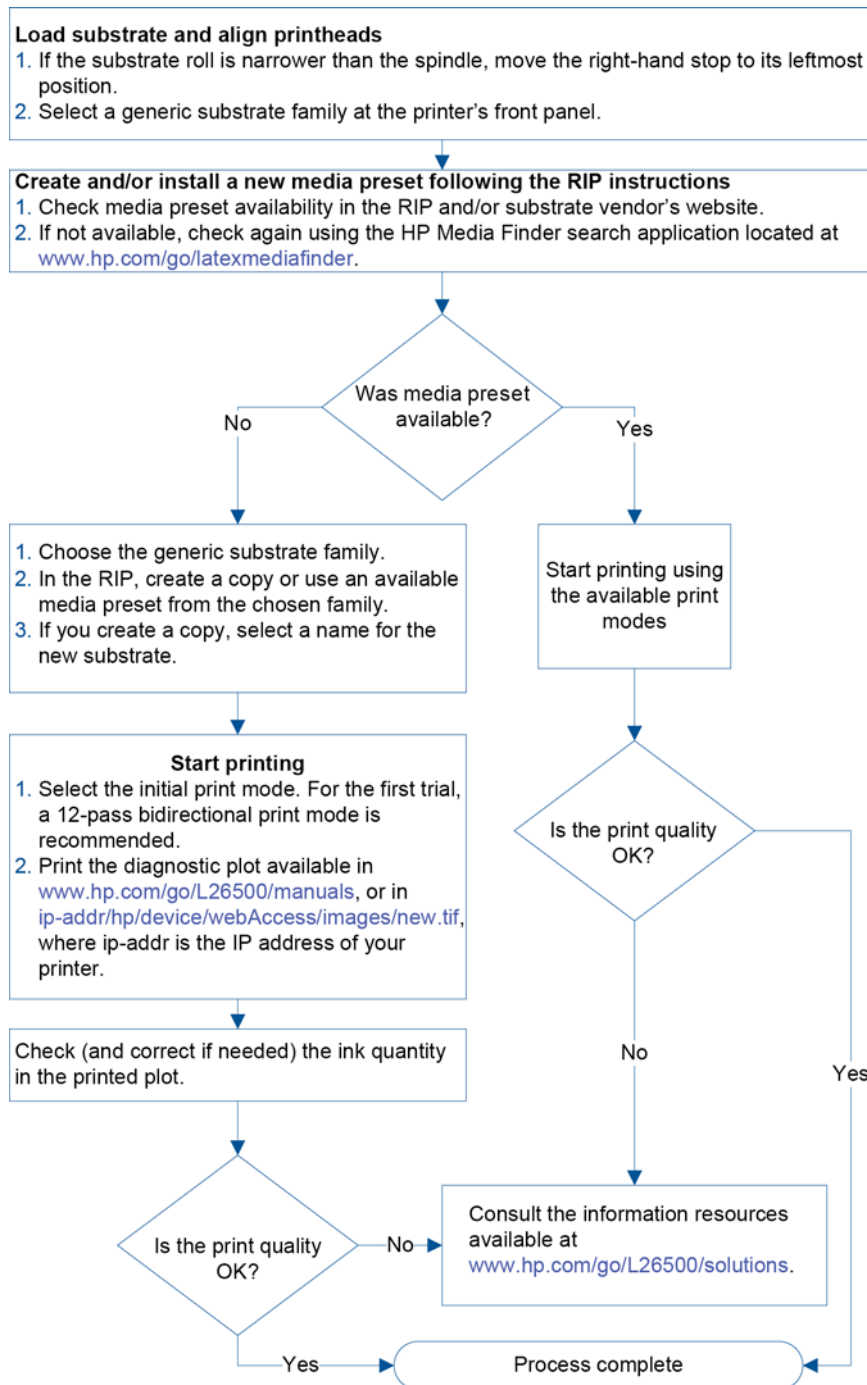

## Select printer settings and color profile

The correct printer settings for your substrate may be available from your RIP vendor or substrate vendor. If not, you can start by copying printer settings from a similar substrate of the same family. For more information on substrate families, see the *User's guide*.

If you cannot find a similar substrate for some reason, here are some recommended default settings for each substrate family.



Substrate family	Drying temp.	Curing temp.	Heating airflow	Auto-tracking (OMAS)	Cutter	Substrate-advance compensation	Input tension	Vacuum
Self-adhesive	55	110	30	Yes	Yes	0	15	25
Banner	50	110	45	Yes	No	0	15	5
Textile	55	100	45	Yes	No	0	15	20
Film	55	95	30	Yes	Yes	0	15	25
Synthetic paper	50	80	30	Yes	Yes	0	15	40
Paper-aqueous	45	70	30	Yes	Yes	0	15	20
Paper-solvent	50	90	30	Yes	Yes	0	15	25
Low-temperature substrate	50	80	30	Yes	Yes	0	15	40
Mesh	50	95	30	Yes	Yes	0	15	30

The various settings mentioned above are described below.

Setting	Description	If too low	If too high
Passes	The number of passes specifies how many times the printheads will print over the same area of the substrate.	The amount of ink fired per time unit is larger and ink has less time to dry on the substrate. This may create coalescence and banding. The boundaries between passes may be more visible. However, printing speed is relatively high.	Colors are vivid, print quality is high. However, printing speed is relatively low. A lower curing temperature is needed, otherwise the substrate may be deformed.
Drying temp.	The heat applied in the printing zone removes water and fixes the image to the substrate.	Print-quality defects such as banding, bleeding and coalescence may occur.	Thermal marks may be seen on the substrate; they may appear as vertical bands in some colors. The substrate may wrinkle on the platen, causing vertical banding, ink smears or substrate jams.
Curing temp.	Curing is needed to coalesce the latex, creating a polymeric film which acts as a protective layer, while at the same time removing the remaining co-solvents from the print. Curing is vital to ensure the durability of the printed images.	The print may emerge not fully polymerized, so that the ink smears when rubbed. The print may appear wet, after printing or later. You may need to increase the number of passes to achieve adequate curing.	The substrate may wrinkle under the curing module, causing defects such as blisters or liner detachment. The substrate wrinkles may also cause vertical banding or ink smears at the beginning of the following plot.
Heating airflow	Airflow helps to remove the evaporated water from the print zone and thus allows more efficient drying.	In general, use the substrate family default value.	
Substrate advance compensation	Your printer was calibrated at the factory to ensure that it advances the substrate accurately when using supported substrates in normal environmental conditions. However, you may find it useful to adjust the substrate advance when printing in an unusual but stable temperature or humidity level, or if the substrate-advance sensor is not working.	You may see horizontal banding or grain.	You may see horizontal banding or grain.

Setting	Description	If too low	If too high
Input tension	Tension is applied to the substrate from the input spindle. It needs to be constant over the full width of the substrate, thus substrate load is a critical operation.	The substrate skews and may become increasingly wrinkled in the printing zone. Also, substrate advance may be irregular, resulting in horizontal banding.	The substrate may be permanently deformed or damaged. Substrate advance problems may appear in extreme cases.
Vacuum	The vacuum applied to the substrate at the printing zone helps to hold the substrate down on the print platen, keeping the distance to the printheads constant.	The substrate may lift up off the platen and touch the printheads. This can smear the printed image, cause vertical banding, cause a substrate jam or even damage the printheads.	For sticky substrates, friction could be too high and substrate advance irregular, resulting in horizontal banding or irregular grainy patches.
Bidirectional	Specifies whether printheads print in both directions, when moving from left to right and from right to left.	If Bidirectional is selected, the amount of ink fired per unit of time is larger, and therefore print quality defects such as coalescence and banding may occur, especially at the sides of the plot. However, printing speed is high.	If Bidirectional is unchecked then the printing is unidirectional and the speed is relatively low.  <b>TIP:</b> You are recommended to keep Bidirectional selected in all cases, increasing the number of passes if necessary to avoid coalescence and banding.
High ink level	The maximum quantity of ink will be laid on the substrate (the High ink level option available only when the number of passes is 10 or more). The ink quantity may be reduced by the RIP color profile.	If not selected, colors may look washed-out.	If selected, there can be excess of ink and some problems related to poor drying and curing.  <b>TIP:</b> Select High ink level for backlit and some textile applications, or if you want high color saturation.
Cutter	The printer's built-in cutter can cut the substrate automatically between each print.	Disable the cutter in the following cases: <ul style="list-style-type: none"> <li>You want to increase the speed of printing.</li> <li>You want to use the take-up reel.</li> <li>You want to cut the substrate manually.</li> <li>The leading edge of the substrate tends to curl and cause substrate jams.</li> </ul> <p>In some cases, the cutter is automatically disabled.</p>	
Auto tracking (OMAS)	The substrate-advance sensor (also known as the Optical Media Advance Sensor, OMAS) is located under the print platen; it can track the substrate advance automatically.	Disable the sensor in the following cases: <ul style="list-style-type: none"> <li>The substrate allows ink to pass through to the platen. Clean the sensor after using this substrate.</li> <li>You are instructed to do so by the front panel, because the sensor is dirty or unable to track this particular substrate.</li> </ul>	



## Load the substrate and print the diagnostic plot

1. Load the substrate in the normal way, paying particular attention to the following points.

- The stop at the right-hand end of the spindle has two possible positions on the spindle. Always use the leftmost position if possible. Use the rightmost position only if the substrate roll requires the full width of the spindle.
  - Turn off the substrate-advance sensor (OMAS) in the RIP if the substrate is transparent or dark, or if the printer recommends you to do so.
  - Align the printheads.
2. Open the HP diagnostic chart in the RIP. The chart is stored in your printer, at <http://ip-addr/hp/device/webAccess/images/new.tif>, where *ip-addr* is the IP address of your printer. You can also find it at <http://www.hp.com/go/L26500/manuals/> and <http://www.hp.com/go/L26100/manuals/>.
  3. Select a suitable number of passes for the substrate family. See [Select the number of passes on page 47](#).
  4. Print the plot.

## Change settings while printing

You can use the front panel to change the following settings while printing.

- To change temperature and vacuum settings while printing: select the  icon, then **Image quality maintenance > Adjust printing params**, and choose the setting that you want to adjust. You can use the arrow keys to adjust the curing temperature, the drying temperature or the vacuum pressure. The changes that you make take effect immediately, but they are not saved: the next job will use the settings in the media profile as usual.
- To change substrate advance calibration while printing (in case of banding): select the  icon, then **Image quality maintenance > Substrate advance calib > Adjust substrate advance**. You can use the arrow keys to adjust the substrate advance. The changes that you make take effect immediately, but they are not saved for the next job. See also [Substrate advance adjustment on the fly on page 56](#).
- To enable or disable extra printhead cleaning while printing: select the  icon, then **Image quality maintenance > Enable extra PH cleaning** or **Disable extra PH cleaning**. In this case, the change of setting *is* saved for subsequent jobs.



**NOTE:** Extra printhead cleaning shortens the life of the printhead cleaning cartridge.

## Advanced settings

Here are some more advanced settings, which you are not recommended to change, unless you have problems that you cannot resolve any other way.

The drying and curing temperatures used by the printer are determined by adding the offset to the base temperature. The base temperatures shown in the table are the default values for each substrate family, but may be changed by the printer depending on the printer settings in use. You cannot change the base temperatures yourself, but you can change the offsets. The base warm-up drying temperature is determined by the RIP.

Your RIP may have an option to return all settings to their default values.

Substrate family	Warm-up drying temperature offset	Warm-up curing temperature	Warm-up curing temperature offset	Cool-down drying temperature	Cool-down drying temperature offset	Cool-down curing temperature	Cool-down curing temperature offset	Minimum drying power
Self-adhesive	10	95	0	80	0	95	0	0.7
Banner	10	95	0	80	0	90	0	0.7

Substrate family	Warm-up drying temperature offset	Warm-up curing temperature	Warm-up curing temperature offset	Cool-down drying temperature	Cool-down drying temperature offset	Cool-down curing temperature	Cool-down curing temperature offset	Minimum drying power
Textile	5	85	0	80	0	90	0	0.7
Film	5	85	0	80	0	100	0	0.7
Synthetic paper	5	80	0	75	0	85	0	0
Paper-aqueous	5	60	0	75	0	85	0	0
Paper-solvent	10	75	0	75	0	90	0	0.7
Low-temp.	10	80	0	75	0	85	0	0
Mesh	10	85	0	80	0	85	0	0.7

The various settings mentioned above are described below.

Setting	Description	If too low	If too high
Warm-up drying temperature	The base temperature that the substrate in the print zone must reach before printing starts.	This setting is determined by the RIP. You cannot change it.	
Warm-up drying temperature offset	This offset is added to the base warm-up drying temperature, and the total is displayed in the front panel while the printer is preparing to print.	Bleeding or coalescence may appear in the first 200-300 mm of the print.	A longer time to start printing is required. Vertical banding or ink smears may occur.
Warm-up curing temperature	The base temperature that the substrate in the curing zone must reach before printing starts.	This setting is determined by the printer. You cannot change it.	
Warm-up curing temperature offset	This offset is added to the base warm-up curing temperature, and the total is displayed in the front panel while the printer is preparing to print.	The beginning of the print is not fully dry, or looks oily.	Substrate degradation (blisters, adhesive detachment) at the beginning of the print.
Cool-down drying temperature	The base temperature at which the substrate can be under the drying module without being damaged. At the end of a job, the substrate is not stopped until this temperature is reached.	This setting is determined by the printer. You cannot change it.	
Cool-down drying temperature offset	This offset is added to the base cool-down drying temperature.	A long time is needed to finish the print.	The substrate at the beginning of the next print may be damaged, because it has stopped moving under too high a temperature. This case is uncommon.
Cool-down curing temperature	The base temperature at which the substrate can be under the curing module without being damaged. At the end of a job, the substrate is not stopped until this temperature is reached.	This setting is determined by the printer. You cannot change it.	

Setting	Description	If too low	If too high
Cool-down curing temperature offset	This offset is added to the base cool-down curing temperature.	A long time is needed to finish the print.	The end of the print may be damaged if the cutter is disabled.
Minimum drying power	The minimum power applied in the drying module while printing, so the substrate does not cool too much in lightly inked areas.	A heavily inked area that comes after a lightly inked area will have bleeding or coalescence defects.	The substrate is damaged in blank or lightly inked areas of the print, especially with a high number of passes.

## Temperature profile

Many of the main and advanced substrate settings are related to temperature control, since this is a critical area for correct printing results with latex inks on a wide variety of substrates. The diagram below graphically represents the evolution of drying and curing temperatures during the various printing phases.

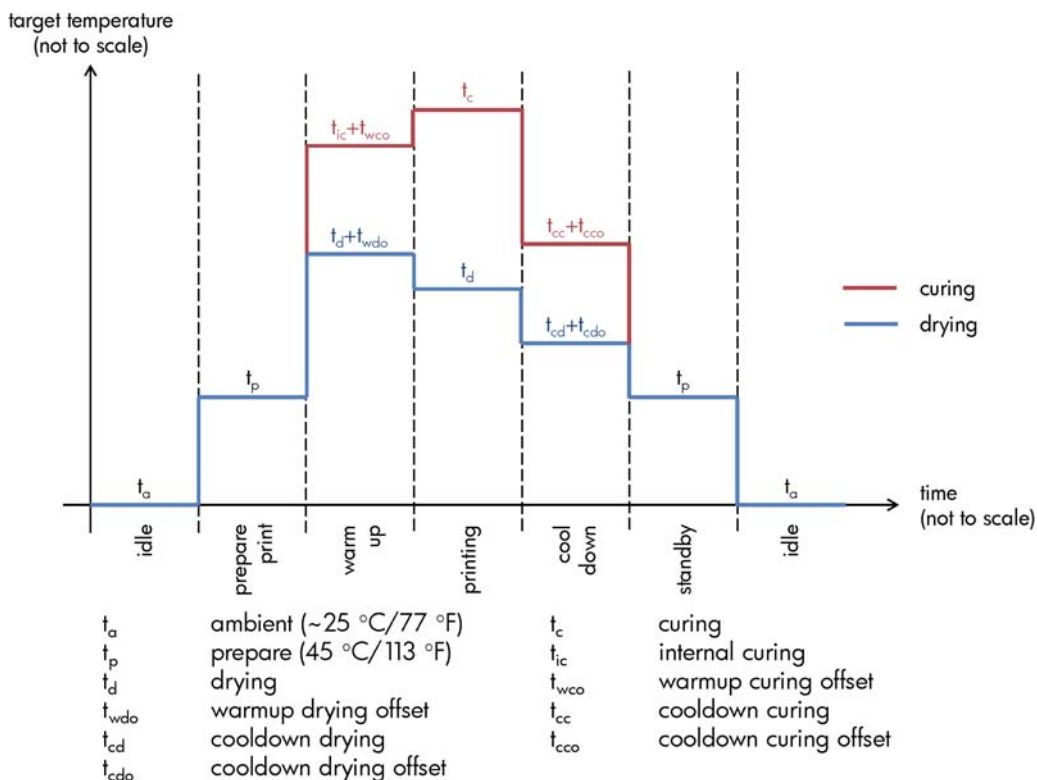

**NOTE:** Target temperatures and time are not to scale. For the specific values used for a given substrate type (family), consult the main and advanced settings tables above.

**NOTE:**  $t_p$  time can be modified through the printer's front panel.

## Select the number of passes

Increasing the number of passes will tend to improve the print quality but reduce the speed of printing.

Passes	Uni/bidir	Self adhesive	Banner	Textile	Film	Synthetic paper	Paper aqueous	Paper solvent	Low temp.	Mesh
4	Bidir	No	No	No	No	No	No	No	No	No
6	Bidir	Maybe	Start here	No	No	No	Start here	Maybe	Maybe	No
8	Bidir	Start here	Yes	No	No	No	Yes	Start here	Start here	Start here

Passes	Uni/bidir	Self adhesive	Banner	Textile	Film	Synthetic paper	Paper aqueous	Paper solvent	Low temp.	Mesh
10	Bidir	Yes	Yes	No	No	No	Yes	Yes	Yes	Yes
12	Bidir	Yes	Yes	Start here	Maybe	Maybe	Yes	Yes	Yes	Yes
16	Bidir	Yes	Yes	Yes	Start here	Start here	Yes	Yes	Yes	Yes
18*	Bidir	Yes	Yes	Yes	Yes	Yes	Yes	Yes	Yes	Yes
20 to 32	Bidir	Yes	Yes	Yes	Yes	Yes	Yes	Yes	Yes	Yes

\* Unlike other printmodes, the 18-pass printmode has 1200 dpi x 1200 dpi input data resolution at 1 bpp (1 bit per pixel). Therefore, to generate a 18-pass media preset you should start either from an existing 18-pass preset or from scratch. In the same way, do not clone an 18-pass media preset to generate a preset with a print mode other than 18-pass.

## Key

- **Bidir:** bidirectional
- **No:** not recommended
- **Maybe:** may be worth trying for extra speed
- **Start here, Yes:** recommended

 **NOTE:** More specific settings for many substrates from different vendors are available in the HP Media Finder at <http://www.hp.com/go/latexmediafinder/>.

## Check the quantity of ink on the substrate

Check that the ink quantities in your media preset are adequate. Look at the color patches in the HP diagnostic chart and check that the patches have the correct amount of ink using the guidelines below:

1. **Too much ink:** There are several possible symptoms of this problem.
  - The last two or three scales of the chart look the same.



- Vertical bands.

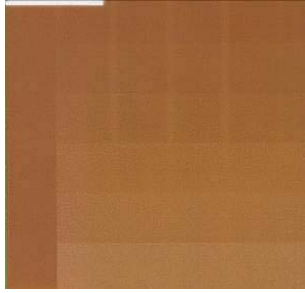

- Horizontal bands.

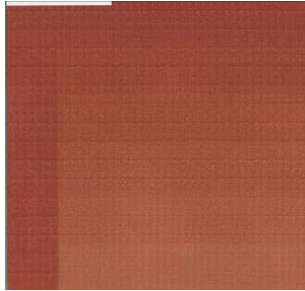

- Coalescence, grain (can be caused by an excess of light ink).

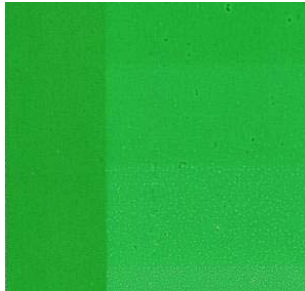

Try reducing the amount of ink in your RIP software, then reprint the chart and check again.

You may have chosen a media preset that uses more ink than your substrate allows. Consult your RIP documentation to make sure you're applying the right media preset, and to find out how to lower the total ink limits of the media preset. For a quick solution, you could change to a different media preset that uses less ink: for example, paper-aqueous presets use less ink than self-adhesive presets.

2. **Correct amount of ink:** The top level of each patch shows a smooth gradient, there are no visible defects and increasing amounts of ink result in increasing color density.

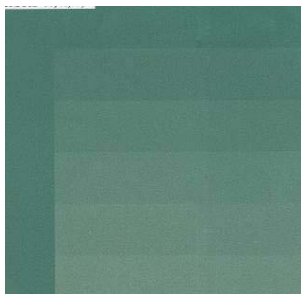

**3. Too little ink:** The whole chart looks washed out.

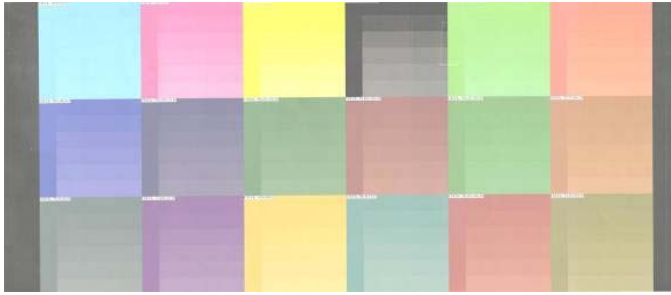

Try increasing the amount of ink in your RIP software, then reprint the chart and check again.

You may have chosen a media preset that uses less ink than your substrate allows. Consult your RIP documentation to make sure you're applying the right media preset, and to find out how to increase the total ink limits of the media preset. For a quick solution, you could change to a different media preset that uses more ink: for example, self-adhesive presets use more ink than paper-aqueous presets.



**NOTE:** Backlit and some textile substrates usually need to be used with the “High Ink Limit” option enabled in the RIP.



## Faster printing

The obvious way to increase speed is to reduce the number of print passes, although this will tend to reduce print quality. Bear in mind the following considerations.

- With fewer than 10 passes, you may see an increase in grain.
- With fewer than 8 passes, the printer is more sensitive to substrate advance problems.
- With fewer than 8 passes, you may need to reduce the ink quantity to improve print quality.
- If you want to use the high ink level option, you must use at least 10 passes.
- As you reduce the number of passes, the best curing temperature may be more difficult to find, and may be more sensitive to the ambient temperature and humidity.

Here are some other suggestions for increasing the speed of printing.

- Concatenating prints saves time, because one can be sent while another is being printed.
- Disable the cutter: select the  icon, then select **Substrate handling options > Enable cutter > Off**. With most substrates, this saves some time at the end of the printing process.
- Increase the cool-down curing temperatures. This also saves some time at the end of the printing process, but may cause slight substrate deformation, depending on the substrate.

See also [The printer seems slow on page 76](#).

## Color calibration

The purpose of color calibration is to produce consistent colors with the specific printheads, inks and substrate that you are using, and in your particular environmental conditions. After color calibration, you can expect to get identical prints from your printer on different occasions.

Color calibration can be launched from your RIP software; see your RIP documentation for details.

In outline, the process consists of the following steps.

1. A calibration test chart is printed.
2. The HP Embedded Spectrophotometer (or, if you prefer, a different spectrophotometer) scans and measures the test chart.
3. The RIP uses the measurements to calculate the necessary correction factors for consistent color printing on that substrate.

Color calibration with the Embedded Spectrophotometer is not recommended for the following substrate types. It may be possible to calibrate some of these substrates by using an external color measurement device.

- Non-opaque substrates such as clear film, backlit substrates, and some textiles.
- Substrates with an uneven surface, such as perforated vinyl or punched-window substrates.
- Substrates that suffer deformation from drying and curing, such as paper-based substrates.
- Very elastic substrates, such as some textiles without liner.

Substrates suitable for color calibration include even-surfaced adhesive vinyls (neither punched nor perforated), PVC banners and some opaque, stiff textiles.

Some textiles require the take-up reel for successful printing. However, the take-up reel may fail to cope with the backward movement of the substrate between the printing and scanning phases of color calibration. To avoid this problem, proceed as follows.

1. Ensure that the take-up reel is enabled.
2. Advance the substrate until the loop-shaper reaches its lowest position.
3. Manually rewind the take-up reel, using the buttons on the take-up reel motor, to collect the substrate and raise the loop-shaper until it almost touches the take-up reel spindle.
4. Set the take-up reel's wind direction to neutral.
5. Launch color calibration from the RIP.
6. When the color calibration has finished, you can re-enable the take-up reel.

## Color profiles

Color calibration provides consistent colors, but consistent colors are not necessarily accurate. For instance, if your printer prints all colors as black, its colors may be consistent but they are not accurate.

In order to print accurate colors, it is necessary to convert the color values in your files to the color values that will produce the correct colors from your printer, your inks and your substrate. A color profile is a description of a printer, ink and substrate combination that contains all the information needed for these color conversions.

These color conversions are performed by your Raster Image Processor (RIP), not by the printer. For further information on the use of color profiles, see the documentation for your application software and for your RIP.

In addition to the color profiles used for printing, you may wish to calibrate and profile your monitor (display device), so that the colors you see on the screen relate more closely to those that you see on your prints.

## Color reproduction tricks

Latex inks are a new technology, and there are some important guidelines when doing color separations (such as when creating or modifying a new media preset within your RIP) that will help to optimize the printer output in terms of color gamut, ink usage and print quality. These are as follows:

- To achieve the best dark colors in vinyl gloss and other substrates, use as much black and as little composite (CMY) as possible when creating the ICC profile.
- Light inks should be avoided as much as possible in high-density colors such as secondaries and tertiaries (dark red, blue, green, ...).
- Light inks should be restricted to the lowest-density colors, starting the use of dark inks as early as possible. Typically, a color of more than 50% density should not contain any light inks.
- Light inks should be used at no more than 50% of maximum quantity. An excessive amount of light inks can create gloss artifacts in vinyl gloss substrates.

Please refer to your RIP documentation for details of how to create or modify media presets.

Presets for HP-branded substrates have been created following the above recommendations in order to optimize black and dark colors. You can find the HP media preset for your substrate family at <http://www.hp.com/go/latexmediafinder/>.

---

# 6 Troubleshoot print-quality issues

## General printing advice

Use the following approach when you have any print-quality problem:

- Make sure that the substrate type that you select on the front panel, and in your RIP software, is the same as the substrate type that is loaded in the printer. Make sure that the substrate type has been calibrated.

 **CAUTION:** If you have the wrong substrate type selected, you could experience poor print quality and incorrect colors, and perhaps even damage to the printheads.

- Make that you are using the correct media profile for your substrate, or that you have followed the correct procedure to generate a new media profile (see [Add a new substrate on page 41](#)).
- Make sure that you are using appropriate print-quality settings in your RIP software.
- Make sure that you are using the correct ICC profile for your substrate and print-quality settings.
- Make sure that your environmental conditions (temperature, humidity) are in the recommended range. See the *User's guide*.
- Make sure that your ink cartridges have not passed their expiration dates. See [Maintain the ink cartridges on page 22](#).
- Avoid touching the substrate while printing is in progress.

## Use the printhead status plot

The printhead status plot consists of patterns that are designed to highlight printhead-reliability problems. It helps you to check the performance of the printheads that are currently installed in your printer, and to determine whether any printhead is experiencing clogging or other problems.

### Print the printhead status plot

To print the printhead status plot:

1. Use the same substrate type that you were using when you detected a problem.
2. Check that the selected substrate type is the same as the substrate type that is loaded into the printer.
3. On the printer's front panel, select the  icon, then select **Image quality maintenance > Print all test plots**.

### Interpret the printhead status plot

The print consists of small dashes, one for each nozzle on each printhead.

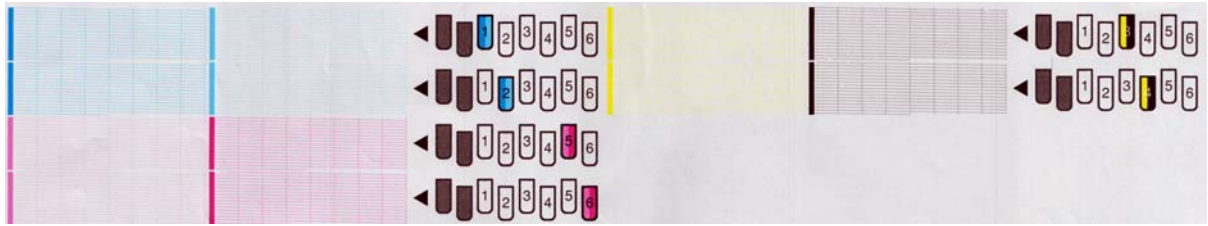

For each individual colored pattern, make sure that most of the dashes are present.

## Corrective action

1. Clean any faulty printheads. See [Clean the printheads on page 72](#). Then reprint the printhead status plot to see whether the problem has been solved.
2. If the problem persists, clean the printheads again, and reprint the printhead status plot to see whether the problem has been solved.
3. If the problem continues to persist, replace any persistently faulty printheads. See [Replace a printhead on page 30](#).

## What to do if problems persist

If you still experience print-quality problems after applying the advice in this chapter, here are some additional tips to consider:

- Try selecting a higher print-quality option in your RIP software.
- Check that your printer firmware is up to date. See [Firmware update on page 9](#).
- Check that you have the correct settings in your software program.
- Call your service representative. See [When you need help on page 85](#).

## Graininess



If you see this kind of problem:

- Ensure that the vertical correction option is disabled in the RIP and in the front panel. At the front panel, select the  icon, then select **Image quality maintenance > Disable vertical correct**. (if this option is available).
- The printheads may be misaligned. This is likely if you have not aligned the printheads for a long time, or if there has been a substrate jam. Align the printheads if necessary (see [Align the printheads on page 11](#)). You can check whether it is necessary by using the printhead status plot (see [Use the printhead status plot on page 53](#)).
- If you are printing with eight or more passes, the substrate advance may need adjustment. See [Adjust the substrate advance on page 56](#).

- Use a higher number of passes: you will probably see less grain with ten or more passes.
- If graininess is more visible in dark or saturated colors, there may be a problem of ink coalescence. Try lowering the ink quantity.

If the problem persists, call your service representative. See [When you need help on page 85](#).

## Horizontal banding

Try the following remedies if your printed image suffers from added horizontal lines as shown (the color may vary).



- If bands affect mostly dark or saturated colors, or only area fills near the edges of the substrate, the cause could be insufficient drying of the ink, or an inaccurate color profile. Try the following suggestions.
  - Reduce the ink quantity.
  - Increase the number of passes.
  - Modify your media preset as suggested in [Color reproduction tricks on page 52](#).
- If bands affect all colors across the width of the printed image, the cause is probably a substrate advance problem. Use the front panel to adjust the substrate advance on the fly (see [Substrate advance adjustment on the fly on page 56](#)). If you have dark bands, increase the substrate advance; if you have light bands, decrease it. When you find the right adjustment, store the value in the RIP for future prints on the same substrate.

Another cause could be a fiber attached to one of the printheads. Turn off the printer and allow it to cool down, then remove the printheads one at a time and remove any fibers that you see attached to them.

- If bands affect only some colors, the cause could be a defective printhead.
  - Print the printhead status plot (see [Use the printhead status plot on page 53](#)). If necessary, clean the printheads (see [Clean \(recover\) the printheads on page 19](#)).
  - Clean the printheads again.
  - Align the printheads (see [Align the printheads on page 11](#)). If necessary, align them manually.
  - Print the printhead status plot again. Identify the printhead with the greatest number of blocked nozzles, and replace it.
  - If bands appear and disappear intermittently, go to the front panel and select the  icon, then **Image quality maintenance > Enable extra PH cleaning**. Remember to disable this option when you no longer need it, because it shortens the life of the printhead cleaning kit.
- If bands affect most of the colors, the printheads could be misaligned. This is likely if you have not aligned the printheads for a long time, or if there has been a substrate jam. Align the printheads if

necessary (see [Align the printheads on page 11](#)). You can check whether it is necessary by using the printhead status plot (see [Use the printhead status plot on page 53](#)).

- If banding occurs mostly in black areas, create a new color profile using pure black and not a mixture of other colors. See your RIP documentation.

If the problem persists, call your service representative (see *the User's guide*).

## Adjust the substrate advance

The substrate advance sensor measures the advance of the substrate and compensates for irregularities at every pass of the printheads. However, to fine-tune the quality of your print, you may need to calibrate the rate at which the substrate advances. The substrate advance determines the placement of dots on the substrate. If the substrate is not advanced correctly, light or dark bands appear in the printed image and the grain in the print may increase.

You can modify the substrate advance with the Substrate Advance parameter in the RIP's substrate preset.

1. On the front panel, select the  icon, then select **Image quality maintenance > Substrate advance calibration > Print adjustment plot**. The printer prints a substrate-advance adjustment image.

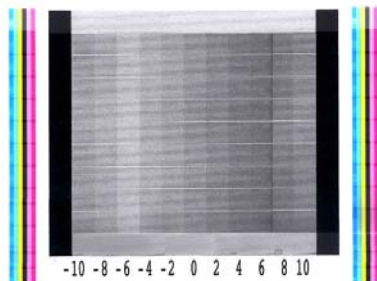

2. The calibration image consists of several columns with a number at the bottom of each one. Locate the lightest of the columns and enter its number into the RIP's Substrate Advance parameter for the current substrate preset. The value chosen in this example should be “-6”.

## Substrate advance adjustment on the fly

If you are using no more than six passes, you can fine-tune the substrate advance while printing: select the  icon, then select **Image quality maintenance > Substrate advance calibration > Adjust substrate advance**. Select a value of change from -10 mm/m to +10 mm/m (or mils/inch). To correct light banding, decrease the value. To correct dark banding, increase the value.

If you are using eight passes or more, a wrong advance adjustment will not produce banding but graininess, which is harder to assess visually. Therefore, in this case you are recommended to use only the adjustment plot.

When you have chosen a value and pressed **OK**, the rest of your job will be printed with that value, but it will be reset to zero at the end of the job. Add the value found to the Substrate Advance value in the RIP preset to print all future jobs with the new setting.

A simpler and faster way to adjust the substrate advance while the printer is printing is by pressing the **Move Substrate** button on the front panel, which then displays the following instructions.

```
Adjust substrate advance _____
      ✓  0.7 mm
▲ to correct dark banding
▼ to correct white banding
Press OK to save or ↶ to quit
```

As you modify the setting, the new setting is applied immediately to the current job by the printer. When you press **OK** to save the value, it is saved in the printer to be used throughout the current job.

## Vertical banding

There are several different kinds of vertical banding that may be seen.

- Wide vertical bands visible by darkness or graininess, typically seen on vinyl and banner substrates in medium-density area fills such as grays, violets and greens
  - Align the printheads. See [Align the printheads on page 11](#).
  - Try the automatic correction for vertical banding provided by the RIP. Depending on your firmware version, this option may also be provided by the front panel: select the  icon, then select **Image quality maintenance** > **Enable vertical correct**. (if this option is available).



**NOTE:** Remember to disable the vertical banding correction when you no longer need it, because it may increase grain.

- Thin vertical bands visible by darkness, typically seen in the first 150–200 mm of the print on vinyl and banner glossy substrates in high-density area fills or in backlit applications
  - Reduce the ink quantity if possible.
  - Disable the cutter.
  - Increase the number of passes.
  - If applicable, tell the RIP to group jobs together, so that printer temperatures remain more stable between jobs.
  - Modify your media preset as suggested in [Color reproduction tricks on page 52](#).
- Irregular or isolated vertical bands
  - Increase the vacuum level in steps of 10 mmH<sub>2</sub>O. Do not exceed the following limits: 20 mmH<sub>2</sub>O for banners, 35 mmH<sub>2</sub>O for vinyl, and 50 mmH<sub>2</sub>O for other substrate families.
  - In backlit applications, increase the number of passes to 20 or more, and change the drying temperature up and down in steps of 5°C.
  - If the banding appears only at the beginning of the print, disable the cutter and advance the substrate manually about 100–150 mm before the first print.

## The print is deformed into a curved shape

This may occur as a result of substrate bow deformation. See [The substrate has bow deformation on page 67](#).

## Misaligned colors

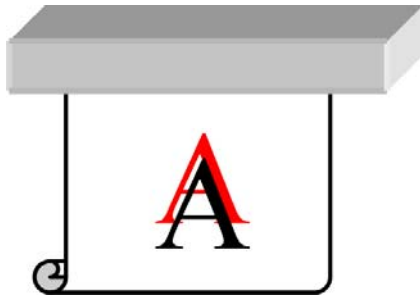

If the colors are misaligned in any direction, the printheads may be misaligned. This is likely if you have not aligned the printheads for a long time, or if there has been a substrate jam. Align the printheads if necessary (see [Align the printheads on page 11](#)). You can check whether it is necessary by using the printhead status plot (see [Use the printhead status plot on page 53](#)).

## Color intensity varies

If some printhead nozzles are in use while others in the same printhead are not, water evaporates slowly from the ink in the unused nozzles, making the color more intense. Thus, in such cases you may notice variations in color intensity in areas where the color of the image should be constant.



If you notice such a problem, there are various possible solutions.

- At the front panel, select the  icon, then select **Image quality maintenance > Enable color variation correction**. This correction will then remain enabled until you disable it.
- If you notice the variation in intensity near one side of the print, try rotating the image by 180 degrees before printing. This may solve the problem in some cases, as all the nozzles are refreshed whenever they enter the service station between passes.
- Use your RIP to add lateral color bars on the side of the plot that is close to the ink supplies. The color bars are designed to exercise all the printhead nozzles, to prevent the problem from occurring.

 **NOTE:** Not all RIPs provide this option.



- Add lateral color bars to the image, manually, before printing. In this case, you can either use the standard colors, or decide to include a particular color in which you have noticed the problem. The recommended width of each color bar is 3 mm.



## Lack of sharpness

If text, lines or solid areas are rough or blurred, the printheads may be misaligned. This is likely if you have not aligned the printheads for a long time, or if there has been a substrate jam. Align the printheads if necessary (see [Align the printheads on page 11](#)). You can check whether it is necessary by using the printhead status plot (see [Use the printhead status plot on page 53](#)).

## Black areas look hazy

If black areas look hazy or not sufficiently black, try these suggestions.

- Increase the number of passes.
- Laminate the print.
- See [Color reproduction tricks on page 52](#).

## Ink smears

Ink smears may be seen on the print for the following reasons.

- The substrate is skewed. Do not ignore the warning message that appears during the loading process if there is significant skew.
- The substrate is not flat in the print zone. Try the following possible solutions.
  - Increase the vacuum level in steps of 10 mmH<sub>2</sub>O. Do not exceed the following limits: 20 mmH<sub>2</sub>O for banners, 35 mmH<sub>2</sub>O for vinyl, and 50 mmH<sub>2</sub>O for other substrate families.
  - Reduce the curing temperature. You will probably need to increase the number of passes in order to achieve adequate curing.
  - Check whether there are fibers on the printheads.

If the problem appears only at the beginning of the print, try the following suggestions.

- Disable the automatic cutter.
- Go to the front panel and select the  icon, then **Substrate handling options > Extra bottom margin**. Set the margin to 100 mm. If that is not enough, try 150 or 200 mm. This extra margin will apply only to jobs that start printing when the printer is idle and when the cutter is disabled.
- Increase the vacuum level in steps of 10 mmH<sub>2</sub>O. Do not exceed the following limits: 20 mmH<sub>2</sub>O for banners, 35 mmH<sub>2</sub>O for vinyl, and 50 mmH<sub>2</sub>O for other substrate families.
- Decrease the warm-up drying temperature in steps of 5°C.
- Decrease the warm-up curing temperature in steps of 5°C.
- Increase the number of passes.
- Make sure that the substrate is stored in the same room in which the printer is located.

## Subtle stains or uneven appearance

Subtle color differences may be seen on some substrates if they are stored partially covered after printing. In the period immediately after printing, such substrates should be stored either totally covered or totally uncovered. It may be advisable to avoid the prolonged contact of two printed faces. This problem tends to disappear if the substrate is left uncovered for some time.

Alternatively, some individual rolls of substrate may have a defective coating. The solution in this case is to use another roll.

## The ink smudges when touched, or looks oily

There are various different circumstances in which these symptoms can be seen.

- When there is a big transition from light to dark colors across the length or width of the substrate  
Increase the minimum drying power.

 **NOTE:** This solution is specific to this problem, and should not be used in other cases, when it could cause further problems.

---

- When the symptoms can be seen only at the start of the first print after the printer has been idle for some time (especially when the start of the print uses a lot of ink)

Increase the warm-up drying temperature offset and the warm-up curing temperature offset. If necessary, increase the stable drying and curing temperatures, or slightly reduce the ink limits.

- When the symptoms can be seen only at the left and right sides of the print

Increase the drying and curing temperatures, decrease the overall ink quantity and/or increase the number of passes.

- When the symptoms can be seen only in certain parts of the print that use a lot of ink

Increase the drying and curing temperatures, decrease the overall ink quantity and/or increase the number of passes.

- When the symptoms can be seen only in the center of the print

Check that all fans are working correctly.

- After reducing the number of passes

Increase the drying and curing temperatures and/or decrease the overall ink quantity.

- When the oily finish appears minutes or hours after printing

Store the print face-up and uncovered; the effect normally disappears after a while.

 **NOTE:** If you decrease the overall ink quantity, you may notice less color saturation.

---

## The dimensions of the print are wrong

As the substrate is heated during the drying and curing processes, some substrates will shrink (and some may expand) after the image has been printed. This may be inconvenient if the print has to be framed or if several prints are to be tiled one next to the other.

See [The substrate has shrunk or expanded on page 66](#).

## Tiling issues

The most common problems when printing tiles are as follows.

- Color degradation within individual tiles

In many cases, individual tiles are long and contain very large areas of solid colors. This combination (long areas of saturated solid colors) may lead to a degradation of printhead performance, which can then cause degradation of the color inside the tile. To solve this problem, go to the front panel and

select the  icon, then **Image quality maintenance > Enable extra PH cleaning**. Remember to disable this option when you no longer need it, because it shortens the life of the printhead cleaning kit.

- Color variation tile to tile

In some cases contiguous tiles with the same background solid color may show differences in color between the right side of the first tile and the left side of the second tile. This is a common issue of inkjet printers (both thermal inkjet and piezo inkjet), where there are slight color variations as the swath advances. Since the biggest color differences are between the left edge and the right edge, the effect may sometimes be seen when putting two tiles together. This issue can easily be overcome by inverting alternate tiles, which has the effect of placing the right side of the first plot next to the right side of the second plot and the left side of the second plot next to the left side of the third, so all contiguous areas have been printed in the same point of the swath and, hence, have the same color. This is a feature that all RIPs have available.

- Dimensional variations from tile to tile

Some specific banner substrates may not have uniform dimensional stability when printing very long tiles. The result is that the length of the tile may be different between the left and the right side (e.g. a 9 meters long tile may be ~1 cm longer on the right side compared to the left side). While this is not noticeable with individual plots, it affects the alignment between panels in tiling applications. Substrate types that show this behavior tend to show it constantly along the roll. So, when present, this issue can easily be overcome by inverting alternative tiles, which has the effect of placing the right side of the first plot next to the right side of the second plot and the left side of the second plot next to the left side of the third, so all contiguous areas belong to the same side of the roll and, hence, have the same length. This is a feature that all RIPs have available.



# 7 Troubleshoot substrate issues

## The substrate cannot be loaded successfully

Here are some suggestions to try if you cannot load the substrate successfully.

- Reread the loading instructions in the *User's guide*, and make sure that you are following them.
- When loading a textile substrate, remember to use the loading accessory, and select **Load with accessory** in the front panel.

Substrate load

- ▶ Load roll
- ▶ Manual load
- ▶ Load with accessory
- ▶ Learn how to load spindle

- If automatic loading is unsuccessful, try manual loading instead.
- The substrate might be loaded at an angle (skewed or mislocated). Make sure that the right edge of the substrate is aligned with the roll on the input spindle.
- The substrate might be crumpled or warped, or have irregular edges.
- If the substrate jams in the substrate path to the platen, the leading edge of the substrate might not be straight or clean. Remove the initial 2 cm (1 in) of substrate from the roll and try again. This might be necessary even with a new roll of substrate.
- Make sure that the spindle is correctly inserted.
- Make sure that the substrate is correctly loaded on the spindle, and that it loads over the roll towards you.
- Make sure that the substrate is wound tightly.

## The substrate is mispositioned

Substrate mispositioned:  
remove substrate

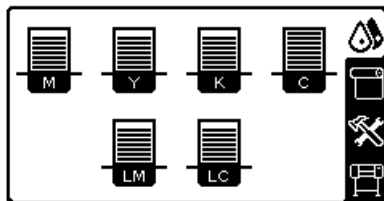

If you see the above display on the front panel, proceed as follows.

1. Lift the substrate lever.
2. Manually reposition the substrate on the platen.

3. Lower the substrate lever.
4. Repeat the above steps until the front panel displays the **Ready** message.

## The substrate has jammed

When a jam occurs, the **Possible substrate jam** message usually appears in the front panel, with one of several error codes (see [Front-panel error messages on page 79](#)).

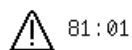

Possible substrate jam.

Caution! Hot surfaces inside the printer. Do not touch heating modules.

Press **OK** to continue

If you are trying to load a very thin or very thick substrate, or a textile, remember to follow the special procedure described in the *User's guide* for loading such substrates.

### Check the substrate path

- This problem can occur when a roll has finished and the end of the roll is stuck to the cardboard core. If this has happened, cut the end of the roll away from the core. Then feed the substrate through the printer, and load a new roll.
- Otherwise, follow the procedure described under [Check the printhead path on page 64](#)

### Check the printhead path

1. Turn off the printer at the front panel, then also switch off the power switch at the rear.

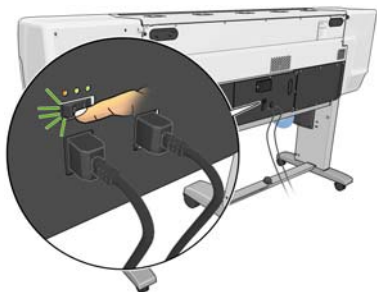

2. Unlock and open the printer window.

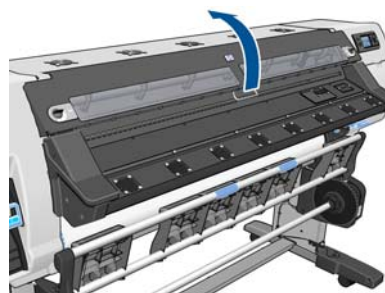
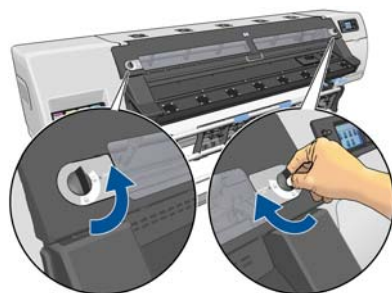

3. Cut the substrate where it enters the printer, and rewind the input roll.
4. Wait for the printer to cool down to room temperature.

5. Try to move the printhead carriage out of the way.

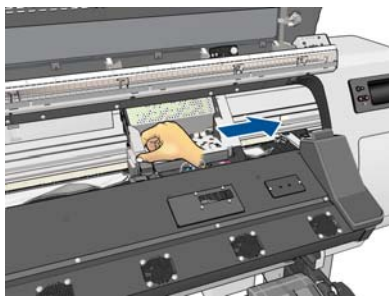

6. Lift the substrate-adjustment lever as far up as it will go.

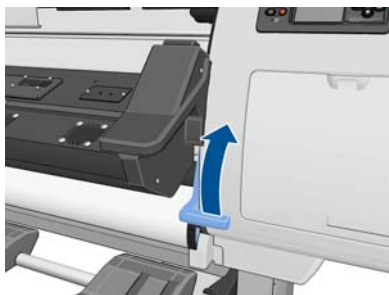

7. Carefully remove as much as possible of the jammed substrate from the top of the printer. Cut the substrate if necessary.

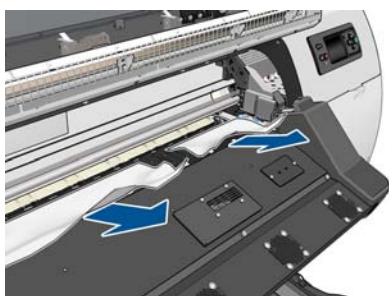

**CAUTION:** Try to avoid pulling the substrate out from the input path, because this reverses the normal direction of movement, and could damage printer parts.

8. Lower the substrate-adjustment lever.
9. Make sure that there are no pieces of substrate left in the printer. In particular, check in and under the curing module, and in the substrate path.
10. Close and lock the window.
11. Turn on the printer.
12. Reload the roll.
13. If some substrate continues to cause an obstruction within the printer, it can often be cleared by loading a rigid substrate type into the printer.
14. If you find that you have print-quality problems after a jam, try realigning the printheads. See [Align the printheads on page 11](#).

## Avoiding substrate jams

Substrate jams may be caused by loading the substrate with too much skew: do not ignore the warning message that appears during the loading process in this case.

They may also be caused by not enough vacuum suction in the printing zone. If you decide to increase the suction, do not exceed the following limits: 20 mmH<sub>2</sub>O for banners, 35 mmH<sub>2</sub>O for vinyl, and 50 mmH<sub>2</sub>O for other substrate families.

If you experience jams only at the beginning of a print, try the following suggestions.

- Disable the automatic cutter.
- Go to the front panel and select the  icon, then **Substrate handling options > Extra bottom margin**. Set the margin to 100 mm. If that is not enough, try 150 or 200 mm. This extra margin will apply only to jobs that start printing when the printer is idle and when the cutter is disabled.
- Increase the vacuum level in steps of 10 mmH<sub>2</sub>O. Do not exceed the following limits: 20 mmH<sub>2</sub>O for banners, 35 mmH<sub>2</sub>O for vinyl, and 50 mmH<sub>2</sub>O for other substrate families.
- Decrease the warm-up drying temperature in steps of 5°C.
- Decrease the warm-up curing temperature in steps of 5°C.
- Increase the number of passes.
- Make sure that the substrate is stored in the same room in which the printer is located.

## The substrate is deformed or wrinkled

If your substrate is deformed or wrinkled by the drying and curing process, change the temperature settings before printing the next job, and advance the substrate, using the [Move Substrate](#) key on the front panel, so that the next job will be printed on undamaged substrate.

If the problem appears only at the beginning of the print, try the following suggestions.

- Disable the automatic cutter.
- Go to the front panel and select the  icon, then **Substrate handling options > Extra bottom margin**. Set the margin to 100 mm. If that is not enough, try 150 or 200 mm. This extra margin will apply only to jobs that start printing when the printer is idle and when the cutter is disabled.
- Increase the vacuum level in steps of 10 mmH<sub>2</sub>O. Do not exceed the following limits: 20 mmH<sub>2</sub>O for banners, 35 mmH<sub>2</sub>O for vinyl, and 50 mmH<sub>2</sub>O for other substrate families.
- Decrease the warm-up drying temperature in steps of 5°C.
- Decrease the warm-up curing temperature in steps of 5°C.
- Increase the number of passes.
- Make sure that the substrate is stored in the same room in which the printer is located.

## The substrate has shrunk or expanded

During the printing process, some substrates may shrink, while others may expand. If this happens, the dimensions of the print will not be correct.

As a general rule, you can expect the following percentages of shrinkage:

- Photorealistic: less than 0.4%
- Paper-solvent, Paper-aqueous: less than 0.5%
- Self-adhesive: less than 1.2%
- Banner: less than 3% shrinkage (if you disable the substrate-advance sensor, less than 7%)



The framing problem may be solved by printing a sample and adjusting the size of the image in the RIP. You may reuse this value for all your future prints with the same substrate, although special care must be taken when using banners, as the shrinkage may vary up to 1% depending on the amount of ink used in the print.

You can expect the following variations from one print to another:

- Photorealistic, Paper-solvent, Paper-aqueous: less than 0.4%
- Self-adhesive: less than 0.7%
- Banner: less than 1%

To solve the tiling problem and improve the repeatability of the printed size, you are recommended to ensure that the substrate-advance sensor is enabled in the RIP's substrate preset, as this will improve the stability of the prints over time. You are also recommended to tile together areas with similar amounts of ink. If this is not possible, print the areas with different amounts of ink as different jobs and modify the length of the job with less ink in the RIP to match its size with the job with high ink content.

Some RIPs may provide a scaling option that allows you to compensate easily for substrate shrinkage or expansion; see your RIP documentation.

## The substrate has bow deformation

The following substrates may suffer from bow deformation during printing, as a result of which the print will appear curved.

- Self-adhesive vinyl substrates (some specific calendared vinyls only)
- Cellulose-based poster papers with no backing nor coating, including HP Photorealistic

This deformation may be particularly noticeable in the following applications.

- Printing images that will later be cut automatically or manually. When there is bow deformation, cutters that are aligned on the sides may lose alignment in the center.
- Poster printing, if the poster is framed or mounted on a straight surface.

The example below shows an original image, the substrate suffering from bow deformation, and the resulting print, also suffering from bow deformation.

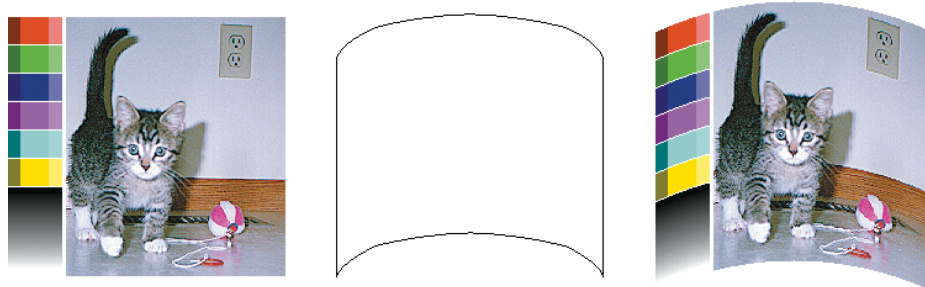

You can use the straightness optimization option in the front panel, or in your RIP software, to compensate for this effect and restore the original shape of your image.

At the front panel, select the  icon, then select **Image quality maintenance > Straightness optimization**, and select a correction value from -15 to +15.



The chosen value should represent the vertical distance in millimeters that the centre of the substrate has moved with respect to the left and right edges. If the deformation moves the center of the substrate in the direction of substrate advance, the correction value should be negative; if in the reverse direction, the correction value should be positive. In practice, the required correction value is normally negative.

 **TIP:** You can use the diagnostic image provided in <http://IPaddress/hp/device/webAccess/diagnostic/StraightnessOptimizationPlot.pdf> (where *IPaddress* is the IP address of your printer) to help you to determine the correct value to apply.

## The automatic cutter does not work

The automatic cutter is turned off in any of the following cases.

- When it has been manually disabled from the front panel: Select the  icon, then **Substrate handling options > Disable cutter**.
- When printing on some particularly heavy substrate types, which it cannot cut.
- When the take-up reel is enabled.

 **TIP:** You can disable the take-up reel from the front panel by selecting the  icon, then **Take-up reel > Disable take-up reel**.

- During double-sided printing.

## Take-up reel substrate jam

If the substrate is severely damaged on the take-up reel spindle, do not use the printer's cutter to cut and remove the substrate. Instead, cut the substrate manually as close as possible to the printer window, then remove the roll.

If the problem remains after removing the substrate jam, unload the take-up reel from the front panel and load it again.

## Take-up reel does not wind

Predictably, if the take-up reel is not winding as anticipated, the printed output is likely to end up on the floor. If the printer recognizes a problem with the take-up reel, it interrupts the print job until the issue is corrected. If the printer does not recognize a problem, the job continues to print. The following table highlights possible issues and solutions.

Take-up reel LED status	Issue	Print job interrupted?	Possible cause	Possible solution
Blinking quickly	Take-up reel is not winding	Yes	The sensor beam was blocked for more than 3 seconds.	Make sure that the take-up reel sensors are not blocked by a strip of substrate or any objects. See the following graphic. Make sure that the collection bin is placed behind the foot brace.  Also ensure that the take-up reel power switch is in the On position.
Blinking slowly	Take-up reel is not winding	No	The sensor cables are loose or unplugged.	Ensure that the sensor cables are correctly secured.

Take-up reel LED status	Issue	Print job interrupted?	Possible cause	Possible solution
Solid red	Take-up reel is not winding	No	There is too much resistance on the take-up reel motor.	Ensure that the substrate is not winding too tightly. A loop-shaping core should be inserted and hanging as shown in the <i>User's guide</i> .
Solid green	Take-up reel is not winding	No	The take-up reel power switch is in the Off position	Ensure that the take-up reel power switch is in the On position.
Solid green	Take-up reel is winding in the wrong direction	No	The take-up reel wind-direction switch is in the wrong winding position.  After 3 seconds, the printer recognizes the problem and interrupts the print job. See the first error listed in this table.	Flip the take-up reel wind-direction switch to the correct position.

The following graphic shows the take-up reel sensors and cable.

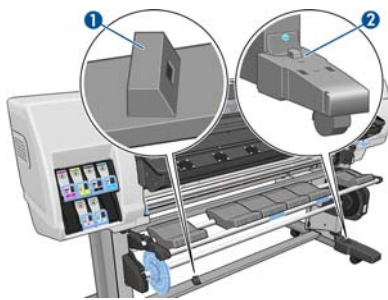

1. Take-up reel sensor
2. Take-up reel sensor and cable housing unit



---

## 8 Troubleshoot ink-system issues

### Ink maintenance kit needs to be installed

If the front panel tells you that the ink maintenance kit needs to be installed, it means that the kit has not been installed in your printer. Perform the normal procedure for replacing the ink maintenance kit (see [Replace the ink maintenance kit on page 27](#)), except that you will not need to remove the old kit.

### Cannot insert an ink cartridge

1. Check that you have the correct type of cartridge (model number).
2. Check that the colored label on the cartridge is the same color as the label on the slot.
3. Check that the cartridge is correctly oriented, the arrow on the front of the ink cartridge should face upwards.

---

 **CAUTION:** Never clean inside the ink cartridge slots.

---

### Cannot insert a printhead

1. Check that you have the correct type of printhead (model number).
2. Check that you have removed the orange protective caps from the printhead.
3. Check that the colored label on the printhead is the same color as the label on the slot.
4. Check that the printhead is correctly oriented (compare with the others).
5. Check that you have closed and latched the printhead cover.

### Cannot insert the printhead cleaning cartridge

Check that the printhead cleaning cartridge has the correct model number and is correctly oriented.

### Front panel recommends reseating or replacing a printhead

1. Remove the printhead and check that it is free from physical damage and from ink stains on the electrical connections.
2. If necessary, clean the electrical connections between the printhead and the carriage. See [Clean the electrical connections on a printhead on page 13](#).
3. Reinsert the printhead into the carriage and check the front panel message.
4. If the problem persists, insert a new printhead.

## Clean the printheads

Periodic printhead cleaning is performed automatically, as long as the printer is kept turned on. However, you should clean the printheads if you are experiencing poor image quality and cannot resolve the issues by other methods. This ensures that there is fresh ink in the nozzles and helps to prevent nozzle clogs.

If you have printed the printhead status plot, you know which colors are failing. Clean the pair of printheads that are not performing adequately. If you are not sure which printheads to clean, clean all of the printheads.

To clean the printheads, go to the printer's front panel and select the  icon, select **Image quality maintenance** > **Clean printheads**, then select which printheads you want to clean. You can clean all of the printheads or only some of them. The choices are as follows.

- Print test plot
- Clean all
- Clean LC-C
- Clean Y-MK
- Clean LM-M

Cleaning all printheads takes about 5 minutes. Cleaning any two printheads takes about 3 minutes.

---

 **NOTE:** Cleaning all printheads uses more ink than cleaning a single pair.

---

## Align the printheads

Precise alignment between printheads is essential for color accuracy, smooth color transitions, and sharp edges in graphical elements. Your printer has an automatic printhead alignment process which runs whenever a printhead has been reseated or replaced.

In the case of a substrate jam, if you have used a custom substrate, or if you are experiencing problems with color accuracy; you might need to align the printheads. See [Align the printheads on page 11](#).

---

 **NOTE:** If you experience a substrate jam, HP recommends that you reseal and align the printheads.

---

 **TIP:** Use the same substrate you intend to print on to align the printheads.

 **WARNING!** Colored substrates, glossy canvas, and transparent materials such as translucent bond, clear film, tracing paper, and vellum are not suitable for aligning the printheads. However, if you must perform printhead alignment with a material that is not supported, make sure you use a material with the same thickness as the material you are going to use for printing.

---

## Reinsert printheads procedure

1. If the printhead alignment process is running and the wrong substrate is loaded, press the **Cancel** button on the front panel.

---

 **CAUTION:** Do not print if the printhead alignment process has been canceled.

---

2. Load the substrate you want to use. Photo paper is recommended for the best results.

---

 **WARNING!** Colored substrates, glossy canvas, and transparent materials such as translucent bond, clear film, tracing paper, and vellum are not suitable for aligning the printheads. However, if you must perform printhead alignment with a material that is not supported, make sure you use a material with the same thickness as the material you are going to use for printing.

---

3. Remove and reinsert all of the printheads. See [Replace a printhead on page 30](#). This starts the printhead alignment process.

 **NOTE:** Make sure the printer window is closed during printhead alignment.

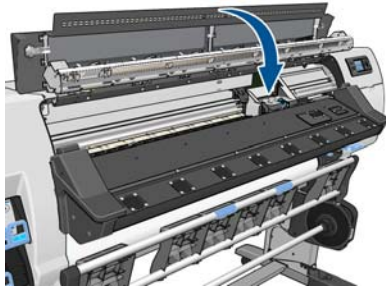



4. The process takes about 6 minutes. Wait until the front panel shows that the process is complete before using the printer.

 **NOTE:** A calibration image is printed during the printhead alignment process. The front panel shows if there were any errors in the process.

## Image Quality Maintenance menu procedure

1. Load the substrate you want to use. Photo paper is recommended for the best results. Plain; bond; and thin, coated substrates are acceptable, but provide marginal results.

 **WARNING!** Colored substrates, glossy canvas, and transparent materials such as translucent bond, clear film, tracing paper, and vellum are not suitable for aligning the printheads. However, if you must perform printhead alignment with a material that is not supported, make sure you use a material with the same thickness as the material you are going to use for printing.

2. Go to the front panel and select the  icon, then select **Image quality maintenance > Align printheads > Auto PH alignment**. The printer verifies that a sufficient amount of substrate exists to perform printhead alignment.
3. If the substrate type that is loaded is acceptable for printhead alignment, the printer performs the alignment and prints an alignment pattern.

 **NOTE:** Make sure the printer window is closed during printhead alignment.

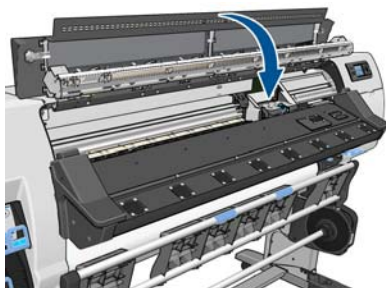

4. The process takes about 5 minutes. Wait until the front panel shows that the process is complete before using the printer.

## Scan errors during alignment

If the alignment process fails, a **Scanning problems** message appears on the front panel. This indicates that the alignment was not completed successfully. Therefore, the printheads are not aligned and the alignment should be repeated before printing. The problem might be because of one of the following scenarios:

- The type of substrate used in the printhead alignment process was not acceptable. Repeat the alignment process using one of the recommended substrate types.
- The printheads are not clean. Clean the printheads. See [Clean the printheads on page 72](#).
- The printer window was open during the printhead alignment process. Repeat the alignment process with the printer window closed.

If the problem persists after following the recommended remedies, try replacing all of the printheads. If the problem persists after replacing the printheads, a failure in the scanning system may exist.



---

## 9 Troubleshoot other issues



### The printer cannot get an IP address

If your network has no DHCP server, the printer cannot automatically retrieve an IP address. In this case, you must set the printer's IP address manually, in the following way.

1. Select the  icon, then select **Connectivity > Gigabit Ethernet > Modify configuration > TCP/IP > IPV4 settings > Config method > Manual**.
2. From the IPV4 Settings menu, select **Manual settings > IP address**.
3. Enter the IP address that you wish to use, and press the **OK** key when finished.

### Cannot access the Embedded Web Server

If you have not done so already, please read the instructions in the *User's guide*.

1. Go to the front panel and select the  icon.
2. Select **Connectivity > Advanced > Embedded Web Server > Allow EWS > On**.
3. Go to the front panel and select the  icon, then select **Connectivity > Gigabit Ethernet > View information**.
4. The information should read: **IP enabled: Yes**. If it does not, you might need to use a different connection.

If you still cannot access the Embedded Web Server, turn the printer off with the **Power** button on the front panel and then turn it on again.

If you experience very slow progress while trying to access the Embedded Web Server, the problem could be that you are using a proxy server. Try bypassing the proxy server and accessing the Embedded Web Server directly.

- In Internet Explorer 6 for Windows, go to **Tools > Internet Options > Connections > LAN Settings**, and select the **Bypass proxy server for local addresses** check box. Alternatively, for more precise control, click the **Advanced** button and add the printer's IP address to the list of exceptions, for which the proxy server is not used.
- In Firefox 3.0 for Windows, go to **Tools > Options > Network > Connection > Settings**, and select the **Direct connection to the Internet** check box. Alternatively, when the **Manual proxy configuration** check box is selected, add the printer's IP address to the list of exceptions, for which the proxy server is not used.
- In Firefox 2.0 for Linux, go to **Edit > Preferences > Network > Connection > Settings**, and select the **Direct connection to the Internet** check box. Alternatively, when the **Manual proxy configuration** check box is selected, add the printer's IP address to the list of exceptions, for which the proxy server is not used.

## The printer is not printing

Possible reasons why a file you have sent from your computer is not printing when expected, include the following:

- There may be a problem with the electrical power. If the printer is not performing and the front panel does not respond, check that the power switch at the rear is on, the residual current circuit breakers are up, the power cable is correctly connected, and the electrical socket is providing power.
- Unusual electromagnetic phenomena may exist, such as strong electromagnetic fields or severe electrical disturbances. Such occurrences can cause the printer to behave strangely, or even stop working. Turn off the printer by using the **Power** button on the front panel, wait until the electromagnetic environment has returned to normal, then turn the printer on again. If the problems persist, call your service representative.
- One of the following substrate scenarios may exist:
  - The substrate name that appears on the front panel does not reflect the substrate that is loaded in the printer.
  - There is not a sufficient amount of substrate on the loaded roll to print the entire job.

Under these conditions, one print job might be printed, while another print job is held in the print queue. To resolve this issue, unload the roll from the printer and load a new roll, using the front panel to guide you through the process.

## The software program slows down or stalls while generating the print job

Large quantities of data might be necessary to generate a high-quality large-format print job. This can cause your software program to slow down significantly or stall. Lowering the print resolution may help to avoid this scenario, however, lowering the print resolution reduces image quality.

## The printer seems slow

Here are some possible explanations.

- If you request the highest possible print quality in the RIP, printing will be relatively slow compared with draft-quality printing.
- Ensure that the substrate loaded in the printer belongs to the substrate family that appears on the front panel.
- Are the printheads in good condition? Printing time tends to increase when a printhead needs cleaning. Check the printhead status on the front panel or through the Embedded Web Server. Clean or replace printheads if necessary.
- Does your image contain high-density black fills? That may increase printing time.
- If your printer is connected to a network, check the following points.
  - Ensure that all components used in the network (network interface cards, routers, switches and cables) are capable of high-speed operation. All network switches should be Gigabit switches or at least 100 Mbits/sec (100 baseT); all network cables should be CAT-5e or better.
  - Ensure that all network cables are well connected and in good physical condition. Damaged cables and poor connections at the Ethernet sockets can seriously degrade performance.
  - Is there a lot of traffic from other devices on the network?

- Ensure that no other device on the network is trying to use the same IP address as the printer.
- Ensure that the Ethernet link speed is Gigabit (or 100 baseT full duplex if Gigabit is not possible in your network). This is normally best achieved by setting the link speed to **Automatic** in the Embedded Web Server. Ensure that the Ethernet switch or router to which the printer is connected is also configured for automatic link speed (this is normally the default case).
- Having checked the network connection to the printer, make similar checks (on cables, link speed settings and duplicated IP addresses) on the connection between the computer and the Ethernet switch or router.
- Remember that firewalls and other software running on the computer may reduce the network speed significantly.

See also the information about printer states in the *User's guide*.

## Cannot access files on the hard disk

If you have trouble accessing files on the printer's hard disk, consider running a file system check. See [Check the file system on page 7](#).

## Communication failures between computer and printer

Some symptoms are:

- The front-panel display does not show the **Receiving** message when you have sent an image to the printer.
- Your computer shows an error message when you try to print, such as error 61:09 or 63:05. See [Front-panel error messages on page 79](#).
- Your computer or printer stalls when transferring data.

To solve a communication problem:

- Make sure that you have selected the correct printer in your RIP.
- Remember that large images usually require more time to receive, process, and print.
- If the printer is connected to your computer through any other intermediate devices, such as switch boxes, buffer boxes, cable adapters, or cable converters, remove the intermediate device and try connecting the printer directly to your computer.
- Try another interface cable.
- Try changing the I/O timeout, which specifies the time that an idle connection is allowed to remain open when the printer is waiting for a remote computer. The default value is 30 seconds. If set to zero, the timeout is disabled and the connection is allowed to remain open indefinitely. To change the I/O timeout, go to the front panel and select the  icon, then **Connectivity > Advanced > Select I/O timeout**.

## The platen rollers squeak

If you notice that the platen rollers are squeaking, call HP support for help: [http://welcome.hp.com/country/us/en/wwcontact\\_us.html](http://welcome.hp.com/country/us/en/wwcontact_us.html)



# 10 Front-panel error messages

Under certain circumstances, a front-panel error message appears. Follow the advice in the Recommendation column to resolve the error.

If an error message appears on the front panel that is *not* included in this list, and you are in doubt of the correct response, call your service representative. See [When you need help on page 85](#).

**Table 10-1** Text messages

Message	Recommendation
[Color] cartridge has expired	Replace the cartridge. See <a href="#">When you need help on page 85</a> .
[Color] cartridge is missing	Insert a cartridge of the correct color. See <a href="#">When you need help on page 85</a> .
[Color] cartridge is out of ink	Replace the cartridge. See <a href="#">When you need help on page 85</a> .
[Color] printhead #[n] error: not present	Insert the correct printhead. See <a href="#">When you need help on page 85</a> .
[Color] printhead #[n] error: please remove	Remove the incorrect printhead and insert a new printhead of the correct type (color and number). See <a href="#">When you need help on page 85</a> .
[Color] printhead #[n] error: replace	Remove and reinsert the same printhead, or try cleaning the electrical connections. See <a href="#">Clean the electrical connections on a printhead on page 13</a> . If the problem persists, remove the non-functional printhead and insert a new printhead. See <a href="#">Replace a printhead on page 30</a> .
[Color] printhead #[n] error: reseal	Remove and reinsert the printhead; try cleaning the electrical connections. See <a href="#">Clean the electrical connections on a printhead on page 13</a> . If necessary, insert a new printhead. See <a href="#">Front panel recommends resealing or replacing a printhead on page 71</a> .
[Color] printhead #[n] out of warranty	The printhead's warranty has ended, because of the length of time it has been in operation or because of the volume of ink used. See the <i>Legal Information</i> .
[Color] printhead #[n] warranty warning	The printhead's warranty may be invalidated by the use of non-HP ink. See the <i>Legal Information</i> .
[Warning] internal failure: Unable to create print	The internal print files are not available in the printer. Load the internal print files through the Embedded Web Server.
Cable is disconnected. Repair ink maintenance kit	At the front panel, select the  icon, then select <b>Repair ink mainten. kit</b> , and follow the instructions on the front panel.
Clean OMAS or disable it at the RIP	Either the substrate-advance sensor is covered with dried ink or dust and needs to be cleaned, or the current substrate is not supported by the substrate-advance sensor, and you are advised to disable it for this substrate.
Ink maint kit almost full	Make sure that you have a new ink maintenance kit available.
Ink maint kit full	Replace the ink maintenance kit. See <a href="#">Replace the ink maintenance kit on page 27</a> .
Ink maintenance kit is not correct. Repair	The ink filter cover is open. Close it.
Ink maintenance kit not installed	The installation of the ink maintenance kit has been cancelled. To complete the installation, see <a href="#">Replace the ink maintenance kit on page 27</a> .
IO error	Restart the printer. If the problem persists, call your service representative. See <a href="#">When you need help on page 85</a> .

**Table 10-1 Text messages (continued)**

Message	Recommendation
IO warning	Try again; if the problem persists, call your service representative. See <a href="#">When you need help on page 85</a> .
PDL Error: Ink system not ready	Clean the printheads. See <a href="#">Clean the printheads on page 72</a> .
PDL Error: Job clipped	The image is too large for the substrate or for the printer. Load larger substrate if possible, or reduce the image size.
PDL Error: memory full	Restart the printer and try resending the job; if necessary, reduce the complexity of the job.
PDL Error: out of substrate	Load more substrate.
PDL Error: parsing error	The print job is unintelligible to the printer. Try to recreate and resend it. Check your cable connections.
PDL Error: print mode error	The substrate type or print quality specified for the job are incorrect. Change the loaded substrate type or the print settings.
PDL Error: printing error	Try sending the job again.
PDL Error: virtual memory full	Restart the printer and try resending the job; if necessary, reduce the complexity of the job.
PH cleaning kit almost full	Make sure that you have a new printhead cleaning kit available.
PH cleaning kit full	Replace the printhead cleaning kit. See <a href="#">Replace the printhead cleaning kit on page 35</a> .
Replace [color] cartridge	Replace the cartridge. See <a href="#">When you need help on page 85</a> .
Reseat [color] cartridge	Remove and reinsert the same cartridge. See <a href="#">When you need help on page 85</a> .
Update: failed. Invalid file	Make sure that you have selected the correct firmware update file. Then try again to perform the update.

Under certain circumstances, a front-panel numeric error message appears. Follow the advice in the Recommendation column to resolve the error.

If an error message appears on the front panel that is *not* included in this list, turn off the printer and then turn it back on. If the problem persists, call your service representative. See [When you need help on page 85](#).

**Table 10-2 Numeric error messages**

Error code	Recommendation
15.01:00	The printer is unable to warm up within a preset time limit. Check that the ambient temperature and input voltage are within printer specifications. If the problem persists, call your service representative. See <a href="#">When you need help on page 85</a> .
15.02:00	The printer is unable to cool down within a preset time limit. Check that the ambient temperature is within printer specifications. Check that all fans are working and unblocked. If the problem persists, call your service representative. See <a href="#">When you need help on page 85</a> .
15.03:00	Excessive heat in the drying module. Check that all fans are working and unblocked. If the problem persists, call your service representative. See <a href="#">When you need help on page 85</a> .
15.04:00	Insufficient heat in the drying module. Check that the ambient temperature is within printer specifications. If the problem persists, call your service representative. See <a href="#">When you need help on page 85</a> .
15.05:00	Infrared sensor error. Check that all fans are working and unblocked. If the problem persists, call your service representative. See <a href="#">When you need help on page 85</a> .

**Table 10-2 Numeric error messages (continued)**

Error code	Recommendation
15.06:00	The drying module has been operating at maximum power for too long. Check that the ink quantity is not too high. Check that the ambient temperature is within printer specifications. If the problem persists, call your service representative. See <a href="#">When you need help on page 85</a> .
16.01:00	The printer is unable to warm up within a preset time limit. Check that the ambient temperature and input voltage are within printer specifications. If the problem persists, call your service representative. See <a href="#">When you need help on page 85</a> .
16.02:00	The printer is unable to cool down within a preset time limit. Check that the ambient temperature is within printer specifications. Check that all fans are working and unblocked. If the problem persists, call your service representative. See <a href="#">When you need help on page 85</a> .
16.03:00	Excessive heat in the curing module. Check that all fans are working and unblocked. If the problem persists, call your service representative. See <a href="#">When you need help on page 85</a> .
16.04:00	Insufficient heat in the curing module. Check that the ambient temperature is within printer specifications. If the problem persists, call your service representative. See <a href="#">When you need help on page 85</a> .
16.05:00	Infrared sensor error. Check that all fans are working and unblocked. If the problem persists, call your service representative. See <a href="#">When you need help on page 85</a> .
16.06:00	The curing module has been operating at maximum power for too long. Check that the ink density is not too high. Check that the ambient temperature is within printer specifications. If the problem persists, call your service representative. See <a href="#">When you need help on page 85</a> .
21:03	Turn off the printer using the front panel and the power switch at the rear. Disconnect the power cords. Reconnect the power cords and turn the printer on again. If the problem persists, call your service representative. See <a href="#">When you need help on page 85</a> .
21.2:10	Printhead cleaning cartridge error. Turn the printer off, remove the printhead cleaning cartridge and check whether the cloth can be manually advanced by using the white gears on its right-hand side. If so, reinsert it. If not, try a new printhead cleaning cartridge. Turn the printer on. If the problem persists, call your service representative. See <a href="#">When you need help on page 85</a> .
24:03	The setup procedure has not been completed. Restart the printer, then restart the setup procedure from the beginning.
26.n:01 (where n = the ink cartridge number)	Remove the ink cartridge and reinstall it in the printer. If the error persists, replace the cartridge with a new one. If the problem persists, call your service representative. See <a href="#">When you need help on page 85</a> .
29:01	The printhead cleaning cartridge is not inserted correctly. Open the printhead cleaning cartridge door on the right side of the printer, make sure that the printhead cleaning cartridge is correctly seated, then close the door. If the problem persists, replace the printhead cleaning cartridge. If the problem persists, call your service representative. See <a href="#">When you need help on page 85</a> .
32:01	The take-up reel is disconnected. If you want to use the take-up reel, turn off the printer and ensure that all take-up reel cables are connected (sensor cables, printer cable). If you do not want to use it, you may need to unload the substrate manually from the take-up reel. Remember to cut the paper first, either manually or by pressing the <a href="#">Move substrate</a> key.
32:01.1	This error occurs when there is a small amount of substrate printed, less than 79 in (200 cm) long. Check that there is no obstacle between the take-up reel optical sensors; that the substrate is attached to the take-up reel spindle; and that the take-up reel switch is in the correct position. If necessary, use the take-up reel arrow keys to wind the substrate; then press <a href="#">OK</a> to resume printing.
32:01.2	This error occurs when there is a small amount of substrate printed, less than 70 in (178 cm) long. The take-up reel sensor detects that the loop shaper is (incorrectly) at the bottom of its path, even though the spindle motor has been rotating for more than 3 seconds. The most probable cause of this error is that you have forgotten to set the switch direction or tape the substrate to the spindle core, when the substrate reaches the floor and blocks the take-up reel's infrared sensors. Check that there is no obstacle between the take-up reel optical sensors; that the substrate is attached to the take-up reel spindle; and that the take-up reel switch is in the correct position. If necessary, use the take-up reel arrow keys to wind the substrate; then press <a href="#">OK</a> to resume printing.

**Table 10-2 Numeric error messages (continued)**

Error code	Recommendation
32:02	This error occurs during printer initialization, to warn you that the take-up reel has been disconnected while the printer was turned off. It also occurs if you try to enable the take-up reel, but it is not connected to the printer. Connect the take-up reel to the printer and press <b>OK</b> to continue.
41:03	Turn off the printer using the front panel and the power switch at the rear. Disconnect the power cords. Open the window and check for any visible obstacles restricting the movement of the drive roller. If there is a wrinkled mass of substrate in the substrate path, lift the substrate adjustment lever and clear the obstruction. Reconnect the power cords and turn the printer on again. If the problem persists, call your service representative. See <a href="#">When you need help on page 85</a> .
42:03	Turn off the printer using the front panel and the power switch at the rear. Disconnect the power cords. Open the window and check for any visible obstacles restricting the movement of the printhead carriage. If there is a wrinkled mass of substrate blocking the carriage, lift the substrate adjustment lever and clear the obstruction. Reconnect the power cords and turn the printer on again. If the problem persists, call your service representative. See <a href="#">When you need help on page 85</a> .
44:10	The waste management fan has failed.
44.1:01	The waste management system cable is disconnected; the cable from the printer cover to the interconnect could be disconnected too.
44.2:01	A switch has failed. Check the waste management system: the ink tube assembly should be connected and the ink filter door closed.
44.3:00	There is a short circuit in the waste management system cable, and perhaps also in the interconnect.
44.4:01	There is noise in the signal of the waste management system. Check that the connector is properly connected.
46:03	Turn off the printer using the front panel and the power switch at the rear. Disconnect the power cords. Reconnect the power cords and turn the printer on again. If the problem persists, call your service representative. See <a href="#">When you need help on page 85</a> .
61:01	<p>The file format is incorrect and the printer cannot process the job. Try the following remedies:</p> <ul style="list-style-type: none"><li>• Turn off the printer by using the <b>Power</b> key on the front panel and the power switch at the back of the printer. Disconnect the power cord, then reconnect the power cord and turn on the printer.</li><li>• Make sure that the RIP supports the printer and that the printer driver is installed in the RIP.</li><li>• Resubmit the file to the printer.</li><li>• Check that your printer firmware is up to date. See <a href="#">Firmware update on page 9</a>.</li><li>• Check that you are using the latest version of your RIP.</li></ul> <p>If the problem persists, call your service representative. See <a href="#">When you need help on page 85</a>.</p>
61:09	The RIP is unable to communicate with the printer. Check that all relevant cables are properly connected, and check whether the RIP has displayed any error message.
63:04	<p>An input/output problem has occurred with the network card. Try the following remedies:</p> <ul style="list-style-type: none"><li>• Make sure that the network cable is correctly connected to the network card.</li><li>• Check that your printer firmware is up to date. See <a href="#">Firmware update on page 9</a>.</li></ul> <p>If the problem persists, call your service representative. See <a href="#">When you need help on page 85</a>.</p>



**Table 10-2 Numeric error messages (continued)**

Error code	Recommendation
63:05	<p>The job is reaching the printer too slowly. The printer cancels the job if there are long pauses of more than 20 s. Try the following remedies:</p> <ul style="list-style-type: none"><li>• Make sure that a 1 Gigabit Ethernet card is correctly installed in the computer with the RIP.</li><li>• Check the RIP for any error messages. Check that the computer with the RIP is working correctly and has the minimum specification required by the RIP. Check that the hard disk is neither full nor excessively fragmented.</li><li>• Check whether the option <b>RIP while printing</b> is enabled. This option can cause slow printing if the computer is not sufficiently powerful.</li><li>• Try reducing the resolution of the job or increasing the number of passes.</li></ul>
73:03	<p>Turn off the printer using the front panel and the power switch at the rear. Disconnect the power cords. Reconnect the power cords and turn the printer on again. Check that the printer has the latest firmware version. If not, update the firmware to the latest version. If the problem persists, call your service representative. See <a href="#">When you need help on page 85</a>.</p>
74:01	<p>An error occurred when uploading the firmware update file. Try the following remedies:</p> <ul style="list-style-type: none"><li>• Turn off the printer by using the <b>Power</b> key on the front panel and the power switch at the back of the printer. Disconnect the power cord, then reconnect the power cord and turn on the printer.</li><li>• Try again to upload the firmware update file to the printer. See <a href="#">Firmware update on page 9</a>.</li></ul> <p>If the problem persists, call your service representative. See <a href="#">When you need help on page 85</a>.</p>
76:03	<p>A “disk out of space” has occurred. Try the following remedies:</p> <ul style="list-style-type: none"><li>• Turn off the printer by using the <b>Power</b> key on the front panel and the power switch at the back of the printer. Disconnect the power cord, then reconnect the power cord and turn on the printer.</li><li>• Resubmit the file to the printer.</li></ul> <p>If the problem persists, call your service representative. See <a href="#">When you need help on page 85</a>.</p>
77:04	<p>An Embedded Web Server internal software error has occurred. Try the following remedies:</p> <ul style="list-style-type: none"><li>• Turn off the printer by using the <b>Power</b> key on the front panel and the power switch at the back of the printer. Disconnect the power cord, then reconnect the power cord and turn on the printer.</li><li>• Check that your printer firmware is up to date. See <a href="#">Firmware update on page 9</a>.</li></ul> <p>If the problem persists, call your service representative. See <a href="#">When you need help on page 85</a>.</p>
78.1:04	<p>The printer has no substrate preset for this substrate. Follow the firmware upgrade procedure to update the printer with the latest substrate presets.</p>
78.2:01	<p>The end of roll has been detected. If this is not the case, unload and reload the substrate.</p>
81:01, 81:03	<p>Open the printer window and make sure that there are no obstacles restricting the movement of the drive roller. If the substrate has jammed and is restricting the movement of the drive roller, see <a href="#">The substrate has jammed on page 64</a>. If the problem persists, call your service representative. See <a href="#">When you need help on page 85</a>.</p>
82:01	<p>There may be a substrate jam, or a dirty carriage reflector. Try cleaning the carriage reflector; if the problem persists, see <a href="#">The substrate has jammed on page 64</a>.</p>
86:01	<p>Open the window and check for any visible obstacles restricting the movement of the printhead carriage. If there is a wrinkled mass of substrate blocking the carriage, lift the substrate adjustment lever and clear the obstruction. If the problem persists, call your service representative. See <a href="#">When you need help on page 85</a>.</p>
98:03	<p>One or more printheads is malfunctioning; use the printhead status plot to find out which. See <a href="#">Use the printhead status plot on page 53</a>.</p>

## Printer logs

If you go to the front panel and select the  icon, then **Printer logs**, you can choose to display on the front panel a log of recent system errors, warnings, or printhead or ink cartridge events.

---

# 11 When you need help

## Introduction

HP Customer Care offers award-winning support to ensure that you get the most from your HP Designjet. HP Customer Care provides comprehensive, proven support expertise and new technologies to give you unique end-to-end support. Services include setup and installation, troubleshooting tools, warranty upgrades, repair and exchange services, phone and Web support, software updates, and self-maintenance services. For more information about HP Customer Care, go to: <http://www.hp.com/go/graphic-arts/>.

## Documentation

The following documents are provided with your printer, and can also be downloaded from <http://www.hp.com/go/L26500/manuals/> and <http://www.hp.com/go/L26100/manuals/>.

- *Site preparation guide*
- *Installation guide*
- *User's guide*
- *Maintenance and troubleshooting guide* (this document)
- *Legal information*

## Customer Self Repair

HP's Customer Self Repair program offers our customers the fastest service under either warranty or contract. It enables HP to ship replacement parts directly to you (the end user) so that you can replace them. Using this program, you can replace parts at your own convenience.

### Convenient, easy to use

- An HP Support Specialist will diagnose and assess whether a replacement part is required to address a defective hardware component.
- Replacement parts are express-shipped; most in-stock parts are shipped the very same day you contact HP.
- Available for most HP products currently under warranty or contract.
- Available in most countries.

For more information about Customer Self Repair, see <http://www.hp.com/go/selfrepair/>.

## HP Customer Care Centers

Help is available to you by telephone. What to do before you call:

- Review the troubleshooting suggestions in this guide.
- Review your RIP's documentation, if relevant.
- Please have the following information available:
  - The printer you are using: the product number, the serial number and the service ID



**NOTE:** This information is available from the front panel: select the  icon, then **View printer information**. You may also find it on a label at the rear of the printer.

- If there is an error code on the front panel, note it down; see [Front-panel error messages on page 79](#)
- The RIP you are using, and its version number
- The software application you are using, and its version number
- The text displayed by the Embedded Web Server when you select **Help > About**

## Telephone number

Your HP Support telephone number is available on the Web: please visit [http://welcome.hp.com/country/us/en/wwcontact\\_us.html](http://welcome.hp.com/country/us/en/wwcontact_us.html).

## Service information

The printer can produce on request a list of many aspects of its current status, some of which may be useful to a service engineer trying to fix a problem. There are two different ways to request this list:

- In the Embedded Web Server, select the **Support** tab and then **Service support > Printer information**.
- From any computer with Internet access, enter the URL of your printer into a Web browser, followed by `/hp/device/webAccess/allServicePlot.htm`. For instance, if the URL of your printer is **http://123.123.123.123**, enter `http://123.123.123.123/hp/device/webAccess/allServicePlot.htm`.

You can request the whole list, which takes a significant time to generate; or you can request specific parts of it. If in doubt, you are recommended to request the whole list (select **All pages**).

If you need to send the list by e-mail, you can save the page as a file from your Web browser, and later send the file. Alternatively, from Internet Explorer you can send the page directly: select **File > Send > Page by E-mail**.

# A Summary of common printing problems

This is a table of common problems and the RIP parameters that can be changed in order to solve the problem. Some possible side-effects are also shown. For a more detailed treatment of any particular problem, please see the relevant chapter in this guide.

Problem	Parameter	Change	Possible side-effects
Durability problems, ink smudges or oily finish	Curing temperature	Increase	Substrate jam, substrate damage, ink smears
	Number of passes	Increase	Slower printing
Substrate jam, substrate damage, ink smears	Curing temperature	Decrease	Less durability (smudges), oily finish
	Vacuum (and disable cutter)	Increase	Substrate skew
	Top and/or bottom margins	Increase	Substrate waste
	Drying temperature	Decrease	Coalescence, banding, less durability (smudges), oily finish
Horizontal or thin vertical banding in saturated area fills	Drying temperature	Increase	Substrate jam, substrate damage, ink smears
	Ink limits	Decrease (depends on RIP)	Reduced color gamut
	Number of passes	Increase	Slower printing
	Modify color separations and dark color generation		
Graininess, color misregistration or lack of sharpness	Align printheads		
	Calibrate substrate advance		
Black areas look hazy or image gloss is not uniform	Modify color separations and dark color generation		
	Drying temperature	Increase	Substrate jam, substrate damage, ink smears
	Number of passes	Increase	Slower printing
	Curing temperature	Decrease	Less durability (smudges), oily finish



---

# Index

## A

- add new substrate 41
- alerts
  - errors 7
- alerts, warnings 7
- application hangs up 76

## B

- bow deformation 67

## C

- calibration
  - color 51
- cannot load substrate 63
- carriage rail, clean and lubricate 20
- caution 3
- clean the platen 17
- clean the printer 16
- clean the substrate-advance sensor window 19
- color calibration 51
- color profile tricks 52
- color profiles 52
- color reproduction tricks 52
- communication problems 77
- curve deformation 67
- Customer Care 85
- Customer Self Repair 85
- cutter
  - disable 51
- cutter does not work 68

## D

- DHCP not available 75
- diagnostic plot 42
- documentation 85
- downloading media presets 41

## E

- Embedded Web Server
  - cannot access 75
  - ink system status 5

## F

- faster printing 51
- file system check 7
- firmware update 9
- front panel error messages
  - all 79
- front-panel options
  - adjust printing params 45
  - adjust substrate advance 45, 56
  - align printheads 73
  - allow EWS 75
  - auto PH alignment 11
  - clean printheads 19, 72
  - disable cutter 68
  - disable take-up reel 68
  - enable color variation correction 58
  - enable extra PH cleaning 45, 55, 61
  - enable vertical correct. 57
  - extra bottom margin 59, 66
  - file system check 7
  - ink cartridge information 6
  - manual PH alignment 12
  - modify configuration 75
  - print all test plots 53
  - printer logs 84
  - printhead information 6
  - repair ink mainten. kit 79
  - replace ink cartridges 23, 26
  - replace ink mainten. kit 27
  - replace PH cleaning kit 35
  - replace printheads 30
  - select I/O timeout 77
  - straightness optimization 67
  - substrate advance calibration 56
  - view information 75
  - view printer information 86

## G

- graininess 54

## H

- HP Customer Care 85
- HP diagnostic plot 42

## I

- ink cartridge
  - cannot insert 71
  - maintenance 22
  - non-HP 26
  - refill 26
  - replace 23
  - status 6
- ink maintenance kit
  - replace 27
- ink maintenance kit needs to be installed 71
- ink system status 5
- ink system tips 11
- IP address, set manually 75

## L

- labels, warning 3
- loading substrate problems 63

## M

- maintenance, service 39
- manuals 85
- media presets
  - downloading 41
- move the printer 22

## N

- non-HP ink cartridges 26

## P

- porosity check 12
- print-quality problems
  - black areas look hazy 59
  - color intensity varies 58
  - general 53
  - graininess 54
  - horizontal banding 55
  - ink smears 59

- ink smudges 60
- lack of sharpness 59
- misaligned colors 58
- stains or uneven print 59
- tiling 60
- vertical banding 57
- wrong size 60
- printer does not print 76
- printer logs 84
- printer status 5
- printhead
  - align 72
  - aligning 11
  - cannot insert 71
  - clean; purge 72
  - cleaning 19
  - cleaning connections 13
  - recovery 19
  - replace 30
  - reseal, reseal 71
  - status 6
- printhead cleaning cartridge
  - cannot insert 71
- printhead cleaning kit
  - replace 35
- printhead status plot 53
- printing faster 51

## R

- refilled ink cartridges 26

## S

- safety labels 3
- safety precautions 1
- service information print 86
- service maintenance 39
- slow printing 76
- statistics
  - ink cartridge 6
- store the printer 22
- straightness optimization 67
- substrate
  - add new 41
  - advance 56
  - advanced settings 45
  - cannot load 63
  - change settings while printing 45
  - check porosity 12
  - settings 42
- substrate bow deformation 67
- substrate expansion 66
- substrate jam 64
  - take-up reel 68

- substrate mispositioned 63
- substrate shrinkage 66
- substrate wrinkled 66
- substrate-advance adjustment 56
- support services
  - HP Customer Care 85

## T

- take-up reel
  - doesn't rewind 68
- telephone number 86
- telephone support 85

## W

- warning 3
- warning labels 3