



DPF 10"

Digital Picture Frame
User Manual

df1010v2

About this Manual

This manual is designed to demonstrate the features of your HP Digital Picture Frame. All information presented is as accurate as possible but is subject to change without notice. HP shall not be liable for technical or editorial errors or omissions contained herein.

For the latest reversion, visit www.hp.com/support.

Copyright

© HP 2013. All rights reserved. No part of this publication may be reproduced, transmitted, transcribed, stored in a retrieval system or translated into any language or computer language, in any form or by any means, electronic, mechanical, magnetic, optical, chemical, manual or otherwise, without the prior written permission by HP.

Disclaimer

HP makes no representations or warranties, either expressed or implied, with respect to the contents hereof and specifically disclaims any warranties, merchantability or fitness for any particular purpose. Further, HP reserves the right to revise this publication and to make changes from time to time in the contents hereof without obligation to notify any person of such revision or changes.

Federal Communications Commission notice

This equipment has been tested and found to comply with the limits for a Class B digital device, pursuant to Part 15 of the FCC Rules. These limits are designed to provide reasonable protection against harmful interference in a residential installation. This equipment generates, uses, and can radiate radio frequency energy and, if not installed and used in accordance with the instructions, may cause harmful interference to radio communications. However, there is no guarantee that interference will not occur in a particular installation.

If this equipment does cause harmful interference to radio or television reception, which can be determined by turning the equipment off and on, the user is encouraged to try to correct the interference by one or more of

the following measures:

- Reorient or relocate the receiving antenna.
- Increase the separation between the equipment and receiver.
- Connect the equipment to an outlet on a circuit different from that to which the receiver is connected.
- Consult the dealer or an experienced radio or television technician for help.

Modifications:

The FCC requires the user to be notified that any changes or modifications made to this device that are not expressly approved by HP may void the user's authority to operate the equipment.

Trademark Recognition

Windows XP/Vista/Windows 7/Windows 8 are registered trademarks of Microsoft Corporation in the United States and/or other countries.

Macintosh and Mac OS are registered trademarks of Apple Inc. In addition, all other companies or product names are trademarks or registered trademarks of their respective companies.

Safety Instructions

Before operating the Picture Frame, carefully read and follow the instructions below.

- Retain this User Manual for future reference.
- Read the safety and operating instructions carefully before using the product. All warnings on the product and in the operating instructions should be observed.
- Do not place this product under direct sunlight or near heat sources, such as in a closed car under sunlight or near a stove. The outer casing of this product may become deformed and the sophisticated sensors inside may become damaged due to excessive heat.
- Do not use this product near water, in the rain or allow any liquid to get inside this product. Water and moisture may cause short-circuit to the electronic components and lead to malfunctions.
- Do not use this product near strong electromagnetic sources,

such as a microwave oven. The electromagnetic interference may cause this product to malfunction.

- Do not drop or apply shock/vibration to this product. Strong impacts may damage the components inside.
- Do not insert objects other than compatible memory cards into the memory card slots of this product. The metal contacts inside the slot can easily become damaged by foreign objects.
- Do not use an unknown power adapter other than the one supplied with the Picture Frame. Connecting this product to an unknown power adapter is very dangerous and may lead to fire or explosion.
- Do not cut, bend, modify, place heavy objects, or step on the power adapter cord. Otherwise the external insulation may be damaged and result in short-circuit or fire.
- If there are strange odors or heat emitting from this product or any signs of malfunction, disconnect the Picture Frame from the power immediately and contact your dealer for inspection or service.
- Use a smooth, soft cloth to clean the surface of the screen. Do not
- Use liquid cleaners or glass cleaners.
- Do not attempt to disassemble or modify this product. There are no user serviceable parts inside this product, and any unauthorized modifications will void the warranty.
- Although the LCD panel is made with high-precision technology and has effective pixels of 99.99% or more, black dots or bright points of light (red, blue or green) may appear constantly on the LCD panel. This is a structural property of the LCD panel and is not a malfunction.

Table of contents

Copyright	i
Disclaimer	i
Safety Instructions.....	ii
Table of contents.....	iv
Key Features	1
What's in the box	2
Overview	3
Operating the Picture Frame.....	5
Using the control buttons.....	5
Using the remote control.....	6
Getting started.....	7
Step 1: Using the adjustable stand.....	7
Step 2: Connecting to power.....	8
Step 3: Basic setup	9
Using the main menu	9
Managing photos	10
Manually copying photos to the internal memory.....	10
Tagging photos to an album	12
Removing photos from an album.....	13
Managing photos by using the TIMELINE album.....	14
Creating a new album.....	15
Modifying an album.....	16
Deleting an album	16
Using other options in the ALBUM menu	16
Deleting photos.....	16

Rotating photos	17
Applying photo effects	17
Viewing photos	18
Running a slideshow by using the TIMELINE album	20
Using Smart Energy Saver™	21
Using CLOCK (EZ Access Button)	22
Selecting a clock skin	22
Switching between Clock view and Slideshow view	22
Using SCRAPBOOK	23
Using SETTINGS	24
Date and Time page	24
General Settings Page	25
Information Page	25
Selecting a language	26
Setting the date and time	27
Step 4: Copying photos to internal memory	28
Step 5: Connecting to a computer	29
Appendix	32
Specifications	32

Thank you for bringing our HP Digital Picture Frame into your home. Now you will be able to view your growing digital picture library in stunning clarity and share great memories with friends and family.

It's a totally new and easier way to enjoy seeing your favorite photos. To get the most out of your new HP product, please read through this entire User Manual before use. And, if you have any questions about our product, please don't return this to the store. Allow us to help you by calling our customer service team.

Sincerely,

The HP Team

Key Features

This Picture Frame is equipped with the following features:

- Clear and bright display.
- Enables you to display photos that are stored on the internal memory, memory card or USB flash drive.
- Smart Energy Saver™ software to select preferred power-saving options.
- Allows you to use albums to manage and sort your photos easily.
- Display photos in slideshow using templates from SCRAPBOOK.
- Multi-language On-Screen Display (OSD) menus.
- Clock and calendar functions.

What's in the box

Carefully open the packing box and ensure that you have the following items.

1. Digital Picture Frame
2. AC power adapter
3. Remote control x 1
4. Quick Start Guide

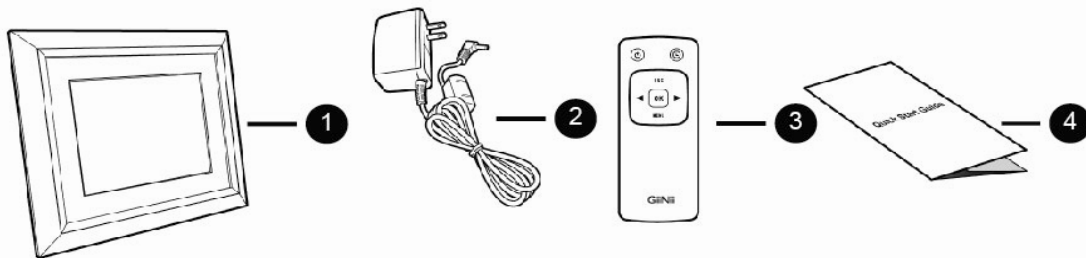

- The appearance and accessories included may vary based on model number.

Overview

Right view

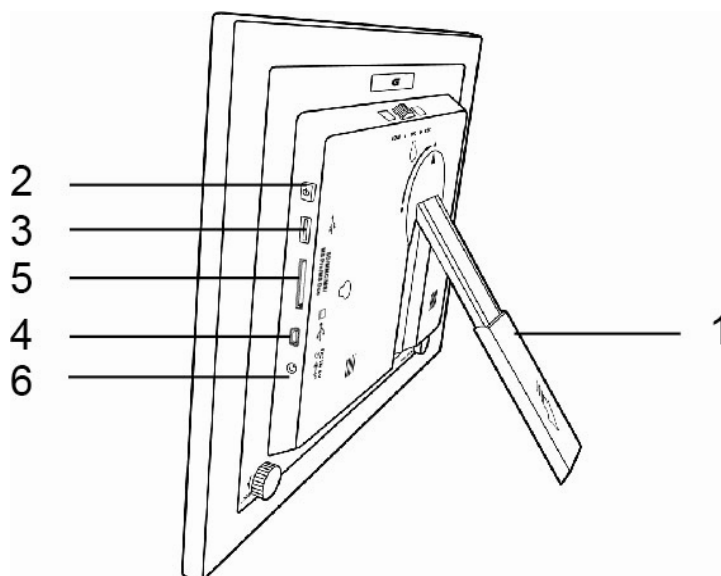

No.	Description
1	Adjustable back stand
2	Power button Press the Power button to turn on/off the Picture Frame.
3	USB Port Allows for a USB flash drive. <ul style="list-style-type: none"> • Play back photos stored on the inserted drive. • Copy photos from the inserted drive to the Picture Frame.
4	Mini USB port Allows you to connect the Picture Frame to a computer to manage the files on the internal memory of the Picture Frame.
5	Memory card slot Allows for an SD™/SDHC™, MultiMediaCard™ (MMC), Memory Stick™ (MS), Memory Stick PRO™ (MS PRO) □ <ul style="list-style-type: none"> • Play back photos stored on the inserted card • Copy photos from the inserted card to the Picture Frame.
6	Power jack Connect one end of the AC power adapter into the power jack and the other end into a power outlet.

Rear view

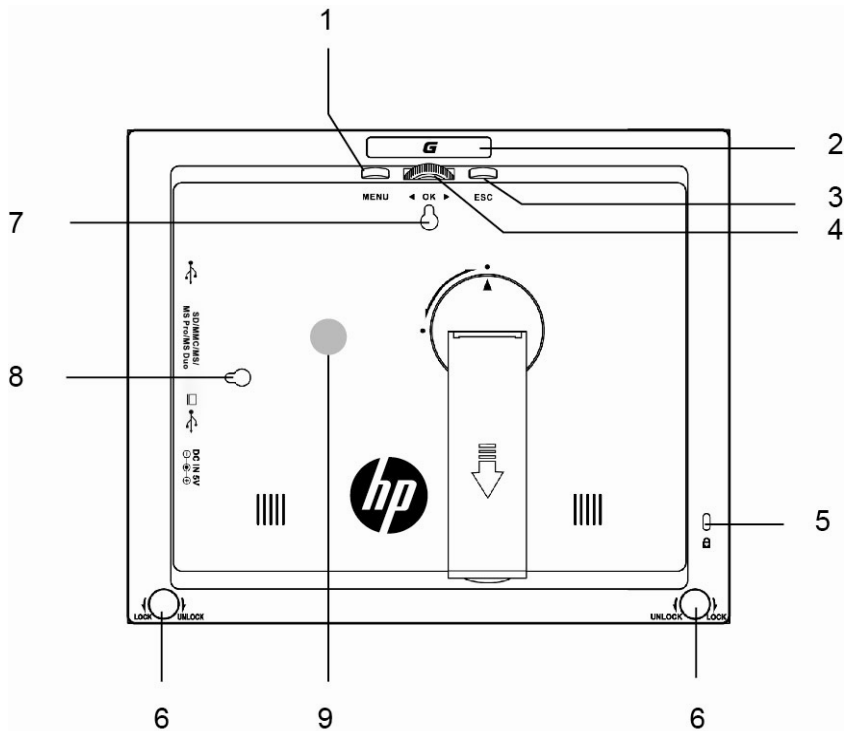

#	Description
1	MENU button See "Using the control buttons" on page 5 for details.
2	EZ Access Button See "Using the control buttons" on page 5 for details.
3	ESC button (ESCAPE button) See "Using the control buttons" on page 5 for details.
4	Scroll wheel/OK button See "Using the control buttons" on page 5 for details.
5	Kensington® security slot You can attach an anti-theft Kensington® lock and cable to this slot to help prevent possible theft.
6	EZ lock System You can use the EZ Lock Screws to lock or unlock the wooden frame.
7	Wall mount hole (for landscape wall mounting) Allows you to hang the Picture frame horizontally on a wall.
8	Wall mount hole (for portrait wall mounting) Allows you to hang the Picture frame vertically on a wall.

Operating the Picture Frame

You can use the control buttons on the back or the supplied remote control to operate the picture frame

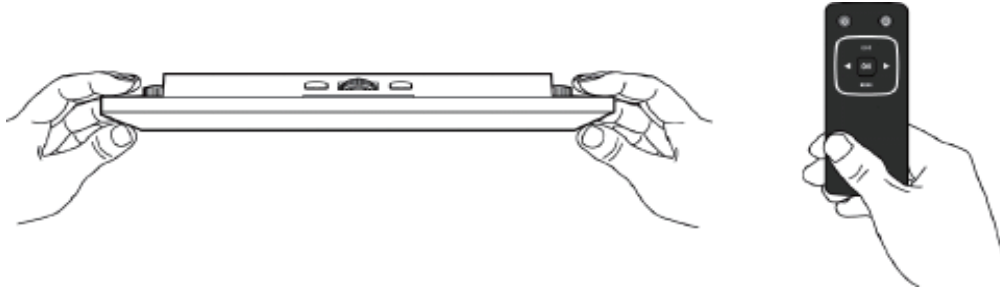

- In this user manual, instructions or examples provided are based upon operation with the remote control. To know how to use the control buttons, refer to "Using the control buttons" on page 5 for details.
- The remote control is supplied with the 7" and 10" models only

Using the control buttons

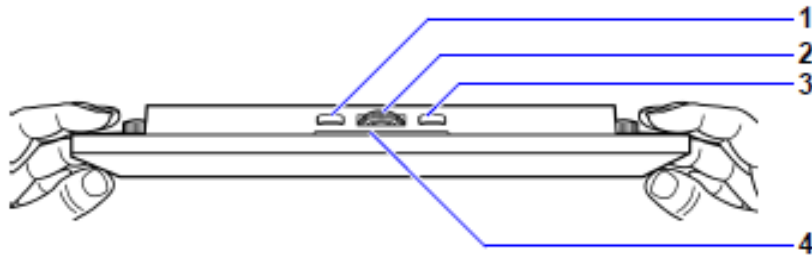

#	Icon	Description
1	ESC	ESC button (ESCAPE button) Cancels current operation and/or returns to the previous page
2	OK	Scroll wheel/ OK button <ul style="list-style-type: none"> • Press this button to enter or confirm your operation /selection. • Scroll this button to the left to select the previous item. • Scroll this button to the right to select the next item.
3	MENU	MENU button Displays the pop-up menu.
4		EZ Access Button Switches between Clock view and Slideshow view

Using the remote control

- Use only the specified battery type [CR2025].
- The batteries are highly flammable; keep away from excessive heat or moisture.

Please remove the plastic strip under the battery before using the remote control for the first time.

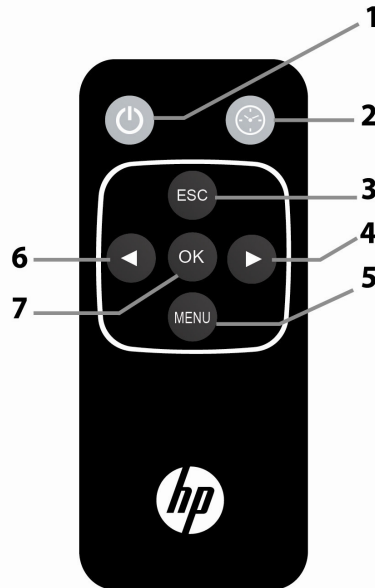

No.	Description
1	ON/OFF Turns unit off
2	EZ Access Button Switches between Clock view and Slideshow view
3	ESC (Escape) Returns to the previous page and/or access menu page
4	RIGHT Moves right or moves to the next item
5	MENU Displays the pop-up menu
6	LEFT Moves to the left or moves to the previous item
7	OK Confirms your selection

Getting started

Step 1: Using the adjustable stand

1. Gently pop out the back stand as shown below

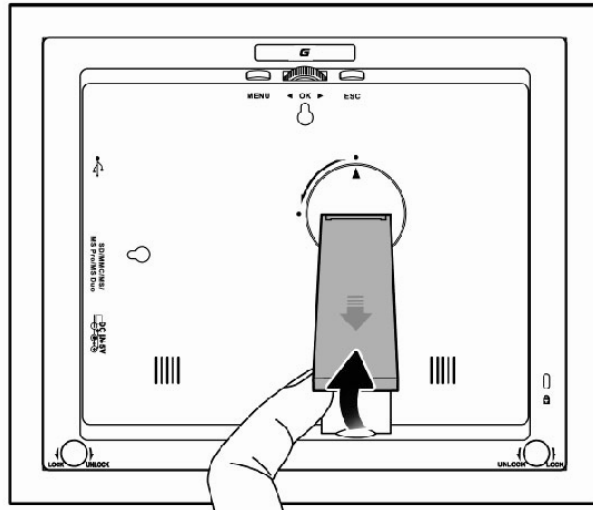

2. To place the Picture Frame horizontally or vertically, you can rotate the back stand by aligning the triangle mark with the rounded points (1 or 2).

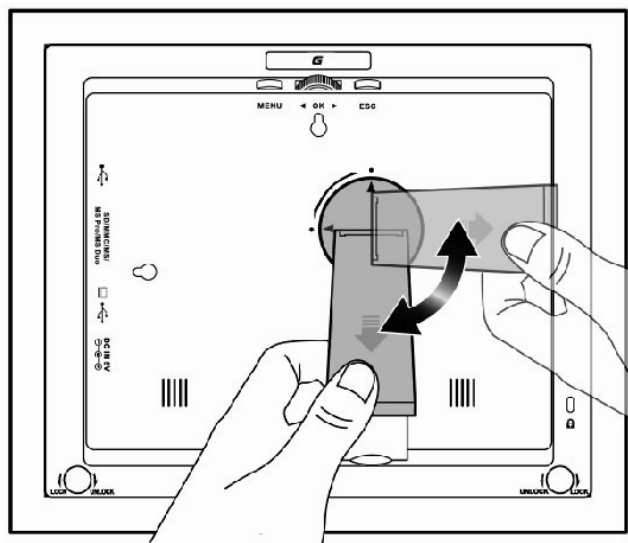

3. Pull out the back stand and adjust accordingly to the preferred viewing angle

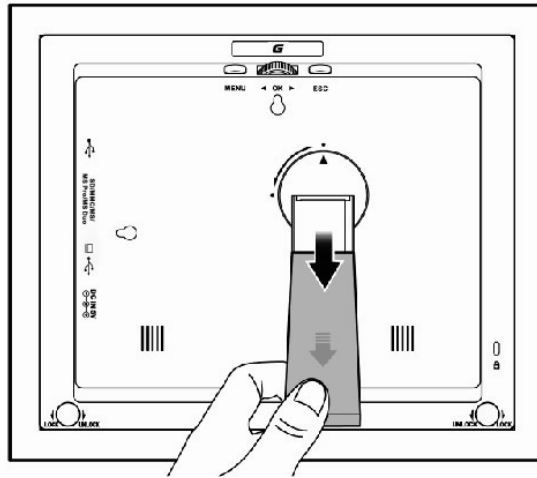

- ✧ It is recommended to place the Picture Frame horizontally, because this direction provides the best viewing and operating experience.
- ✧ By using the wall mount holes, you can hang the Picture Frame horizontally or vertically on the wall.

Step 2: Connecting to power

1. Place the Picture Frame on a flat surface.
2. Connect the power adapter as below (1), and press the Power button to turn on the Picture Frame (2)

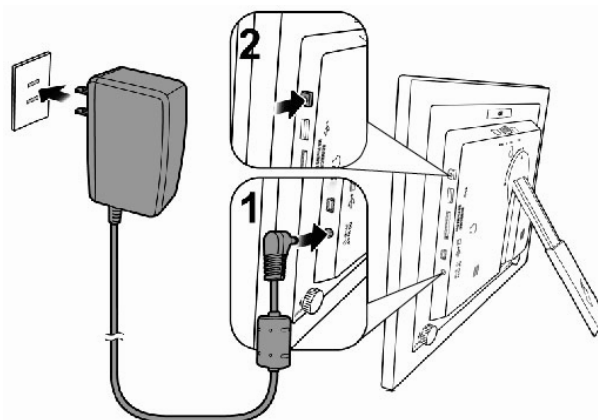

- ✧ Power systems and plug types may vary depending on your country/region.
- ✧ To turn off the Picture Frame, press the Power button

Step 3: Basic setup

Using the main menu

From the main menu, you can scroll to select the desired option, and then press OK. To exit back to the main menu, press "ESC".



No.	Description
1	Smart Energy Saver™ Allows you to select a power-saving option for the Picture Frame. See "Using Smart Energy Saver™ on page 24 for details.
2	CLOCK Allows you to set your favorite clock skins. See "Using CLOCK (EZ Access Button)" on page 25 for details.
3	SCRAPBOOK Allows you to display photos in slideshow with various preloaded templates. See "Using SCRAPBOOK on page 26 for details.
4	PHOTO Allows you to display photos in slideshow. See "Viewing photos" on page 20 for details.
5	ALBUMS Allows you to manage your photos and sort them by using different albums. See "Managing photos" on page 21 for details.
6	SETTINGS Allows you to configure the settings of the Picture Frame. See "Using SETTINGS" on page 14 for details.

Managing photos

You can use the **ALBUM** menu to manage photos on the internal memory, memory card or USB flash drive.

Manually copying photos to the internal memory

In addition to the automatic “Smart Copy” feature, you can manually copy photos from external storage devices to the internal memory and tag photos to an album.

The example below demonstrates how to copy photos from a memory card to the internal memory and tag photos into an album.

1. Insert a compatible memory card to the memory card slot.
2. In the main menu, press ◀ or ▶ to select **ALBUM**, and then press OK.
3. Select **Memory Card**, and then press OK, The screen shows the photos contained on your memory card



4. If there is more than one page, you can press ◀ or ▶ to go to the previous or next page to browse photos. (If not, skip this step.)
5. Press OK to enable the selection mark.
6. Press ◀ or ▶ to move to the photo you wish to select, and then press OK to confirm the selection. The selected photo will have a selection mark.

Repeat Step 6 to select more photos as desired.

If you wish to select all the photos shown on the current page, select "Select All" in the pop-up menu and press OK. Then continue with Step 7.

7. Press **MENU**.

8. From the pop-up menu, press ◀ or ▶ to select **Tag It**, and then press OK

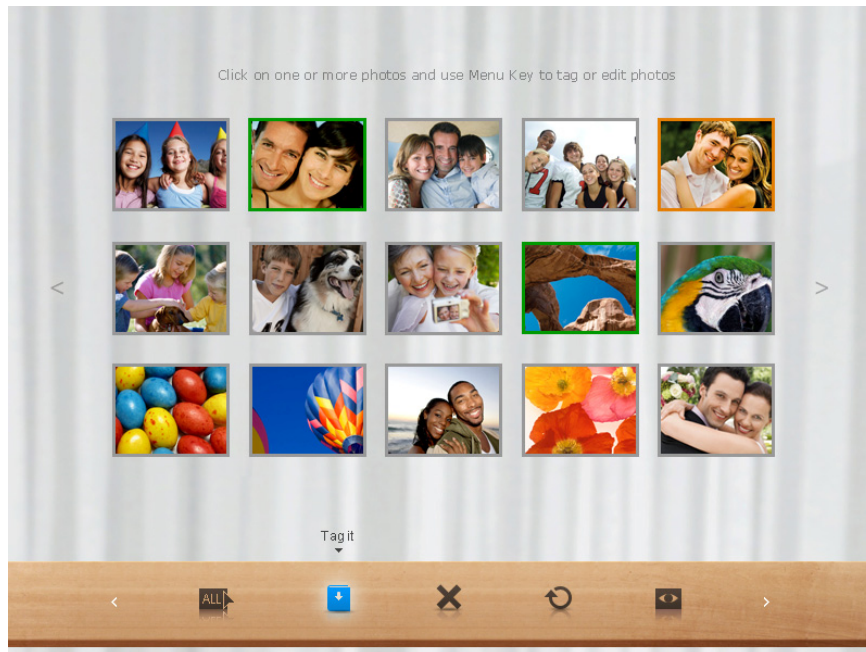

9. Select a default target album to copy and sort the photos into this specified album.



Tagging photos to an album

1. In the main menu, press ◀ or ▶ to select **ALBUM**, and then press OK.

The screen shows:

- The file source, including **USB, Memory Card** and **Internal Memory**.
- The default albums on the internal memory, including **TIMELINE, Pre-install, Uncategorized, Family, Friend and Vacation**.

- ✧ **The “USB” and “Memory Card” file sources will only appear when a USB flash drive and a memory card have been inserted to the Picture Frame.**
- ✧ **For details about the “TIMELINE” album, see "Managing photos by using the TIMELINE album" on page 22.**

2. Press ◀ or ▶ to select the source of your photos, such as the **Internal Memory** album, and then press OK. (You can also select **USB Flash** or **Memory Card**, if available.)



The screen shows all the photos that are available on the internal memory.

3. If there are more than one page, you can press ◀ or ▶ to go to the previous or next page to browse photos (If not, skip this step.)

4. Press OK to enable the selection mark
5. Press ◀ or ▶ to move to the photo you wish to select, and then press OK to confirm the selection. The selected photo will have a selection mark.
 - ✧ **Repeat Step 5 to select more photos as desired.**
6. Press MENU.

If you wish to select all the photos shown on the current page, select “Select All” in the pop-up menu and press OK. Then proceed to Step 7.
7. From the pop-up menu, press ◀ or ▶ to select Tag It, and then press OK
8. Select the destination album for the photos to be store

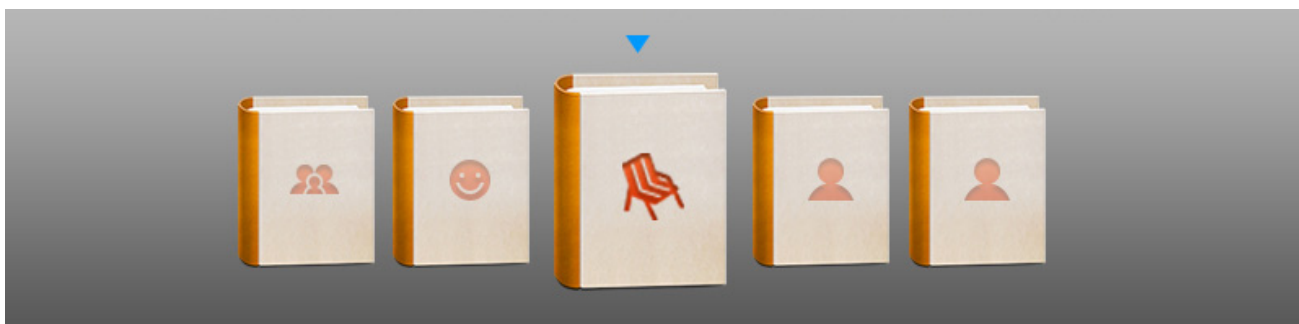

Removing photos from an album

1. In the **ALBUM** menu, press ◀ or ▶ to select an album from which you want to remove the photos, and then press OK. The screen shows the photos in the album.
2. Press OK to enable the selection mark.
3. Press ◀ or ▶ to move to the photo you wish to select, and then press OK to confirm the selection. The selected photo will have a selection mark.
 - Repeat Step 3 to select more photos as desired.**
4. Press “MENU”.

If you wish to select all the photos shown on the current page, select “Select All” in the pop-up menu and press OK. Then proceed to Step 5.

5. From the pop-up menu, press ◀ or ▶ to select **Uncategorized**, and then press OK.

✧ **The photos will be removed from the album, but will not be deleted from the internal memory.**

Managing photos by using the **TIMELINE** album

In **ALBUM**, you can use the **TIMELINE** album to search for photos on the internal memory according to the time span specified.

1. In the **ALBUM** menu, press ◀ or ▶ to select **TIMELINE**, and then press OK.
2. Press OK. When the marks < > appear, press ◀ or ▶ to adjust the settings in the **Year** field, and then press again.

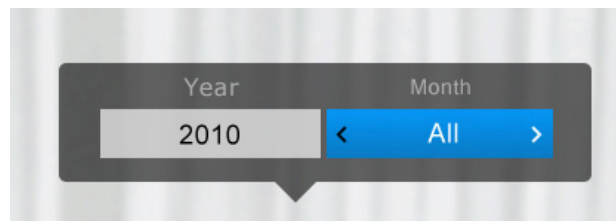

In this step, you can also search for photos taken in a specific period of time under the **TIMELINE** album by pressing **MENU** and selecting the time frame.

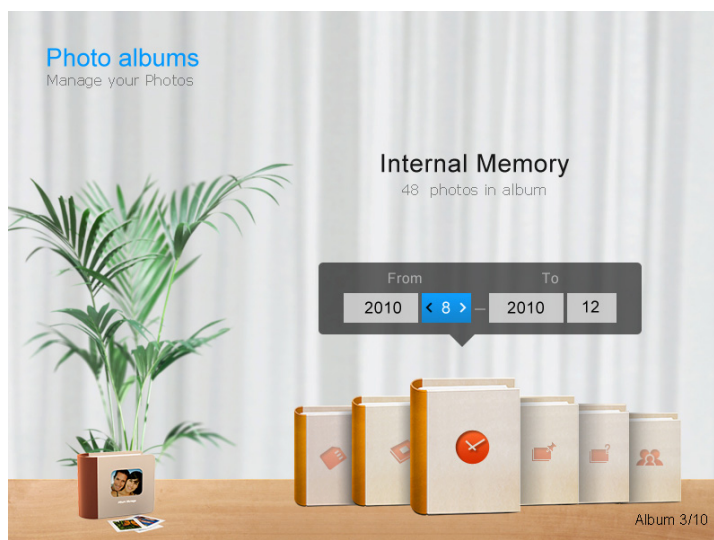

3. Press ► to move to the **Month** field, and repeat Step 2 to adjust the settings.
4. Press ► to move to , and then press OK to start playback.
The photos taken in the time span you specified above will appear on the screen.

Creating a new album

1. In the **ALBUM** menu, press OK to select “+”, and then press OK to create album.
2. In the Album Name field that appears, use the on-screen keyboard to enter a desired name.

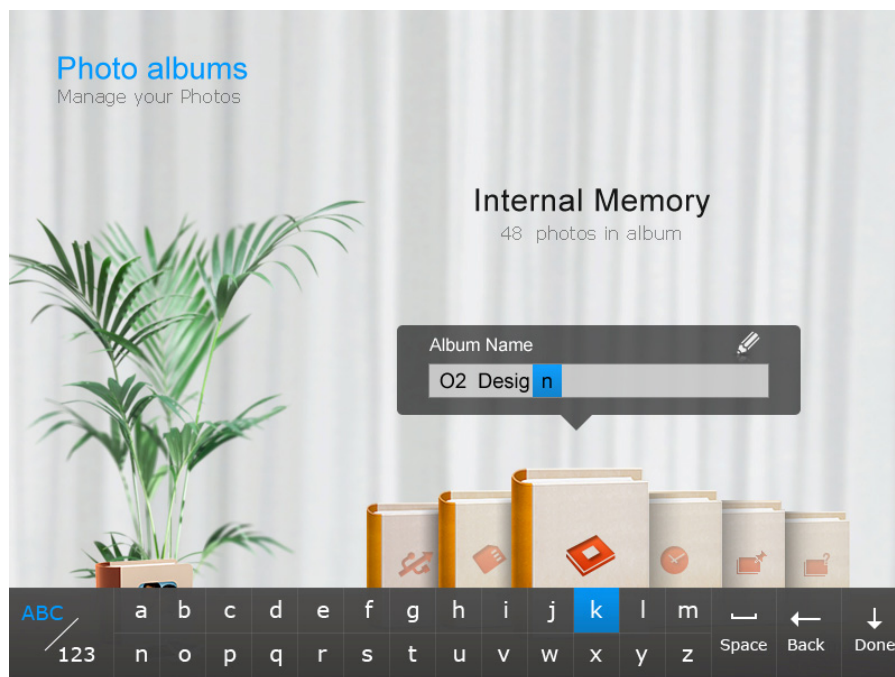

- Press ◀ or ▶ to select a letter, and then press OK to enter the letter.
 - Press **MENU** to toggle between letters and numbers.
 - To add a space, press ◀ or ▶ to move to Space, and then press OK.
3. Now the new album is created.
The Picture Frame allows you to create up to 12 custom albums.

Modifying an album

1. In the **ALBUM** menu, press ◀ or ▶ to select an album for which you wish to modify the album name, and then press MENU.
2. Select **Modify Name**, and then press OK
3. In the **Album Name** field that appears, use the on-screen keyboard to enter a desired name.
4. Once you have finished editing the album name, press ESC to exit.

Deleting an album

1. In the **ALBUM** menu, press ◀ or ▶ to select an album that you wish to delete, and then press MENU.
2. Select **Delete Album**, and then press OK.

Default albums including **TIMELINE**, **Pre-install**, **Family**, **Friends** and **Vacation** cannot be deleted.

Using other options in the ALBUM menu

Deleting photos

1. In the **ALBUM** menu, press ◀ or ▶ to select an album, and then press OK.
2. Press OK to enable the selection mark
3. Press ◀ or ▶ to move to the photo you wish to select, and then press OK to confirm the selection.
The selected photo will have a selection mark.
Repeat Step 3 to select more photos as desired.
4. Press MENU.
If you wish to select all the photos shown on the current page, select “Select All” in the pop-up menu and press OK, then proceed to Step 5.
5. From the pop-up menu, press ◀ or ▶ to select Delete, and then press OK.

Rotating photos

From the pop-up menu, press ◀ or ▶ to select Rotate, and then press OK. The photo will be rotated 90 degrees clockwise.

Repeat Step above if you wish to rotate the photo into other angles.

Applying photo effects

From the pop-up menu, press ◀ or ▶ to select Photo Effects, and then press OK.

Press ◀ or ▶ to select the effect you wish to apply to the selected photo, including SEPIA, ORIGINAL and BLACK & WHITE, and then press OK.

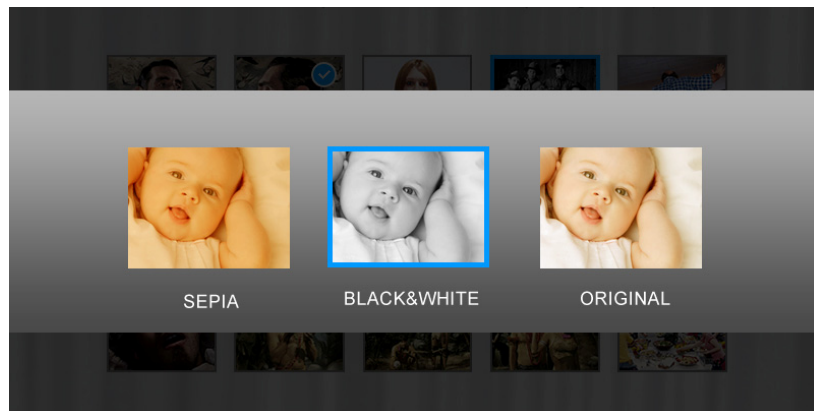

Viewing photos

1. In the main menu, press ◀ or ▶ to select **SLIDESHOW**, and then press **OK**.
 - ✧ The “USB” and “Memory Card” albums only appear when a USB flash drive and a memory card have been inserted to the Picture Frame.
2. Press ◀ or ▶ to select the album that contains the photos you wish to display in slideshow, and then press **OK**.
 - ✧ If you wish to pause the slideshow, press **OK**



3. To configure slideshow settings, press **MENU** to display the pop-up menu. You can adjust the settings below.
 - **Transition Effect:** selects the transition effect you wish to apply to the slideshow.
 - **Slideshow Interval:** selects the slideshow interval between photos.
 - **Play mode:** selects sequent or random order of the playback.

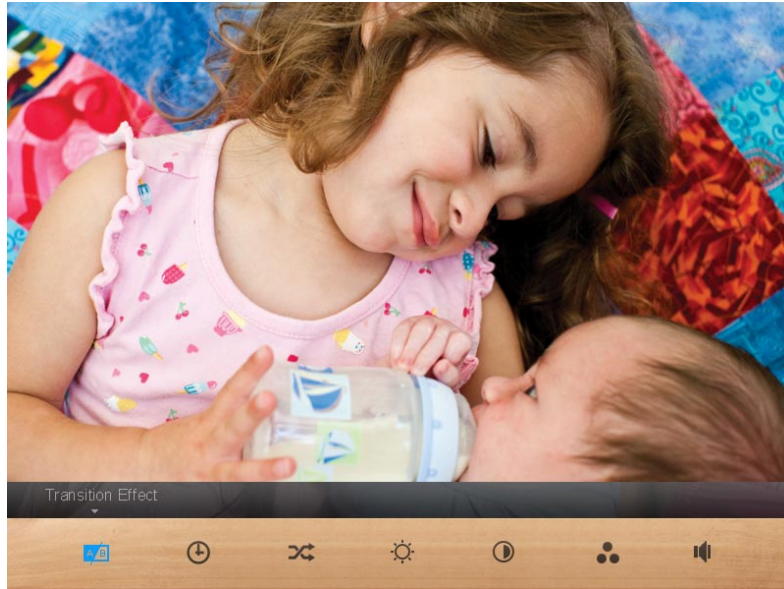

- The default transition effect “Pan & Zoom” does not allow customized interval settings.
- **Brightness:** selects the level of screen brightness.
- **Contrast:** selects the level of contrast.
- **Saturation:** selects the level of saturation.

Running a slideshow by using the **TIMELINE** album

1. In the **SLIDESHOW** menu, press ◀ or ▶ to select **TIMELINE**, and then press OK.
2. In the pop-up screen, specify a time span to include the photos you wish to display in slideshow.

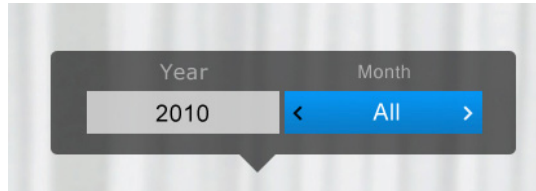

- ✧ In this step, you can also search for photos taken in a specific period of time under the **TIMELINE** album by pressing **MENU** and selecting the time frame.

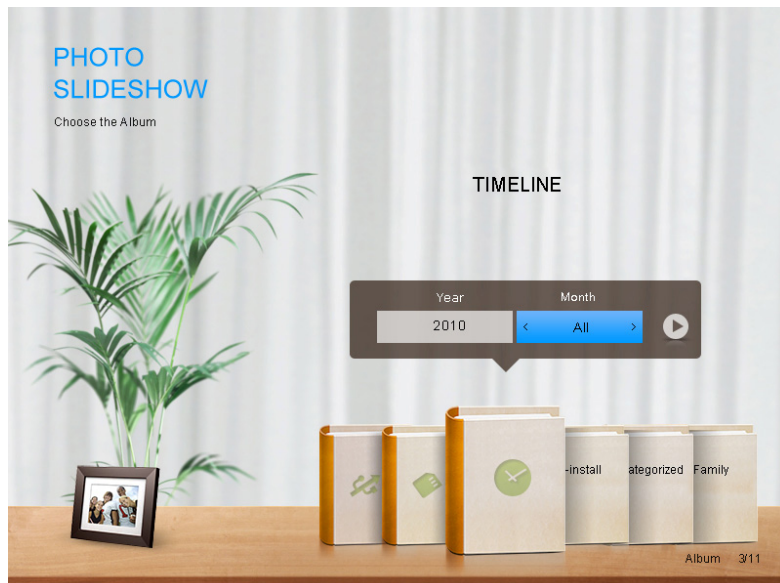

3. Select , and then press OK to start playback.
- ✧ The **TIMELINE** feature only applies to photos stored on the internal memory. Please copy any photos on the USB drive or memory card to the internal memory if you wish to access this feature.

Using Smart Energy Saver™

The Smart Energy Saver™ menu provides various predefined power-saving options.

1. In the main menu, press ◀ or ▶ to select Smart Energy Saver™, and then press OK.
2. Press ◀ or ▶ to select a desired option, and confirm with OK

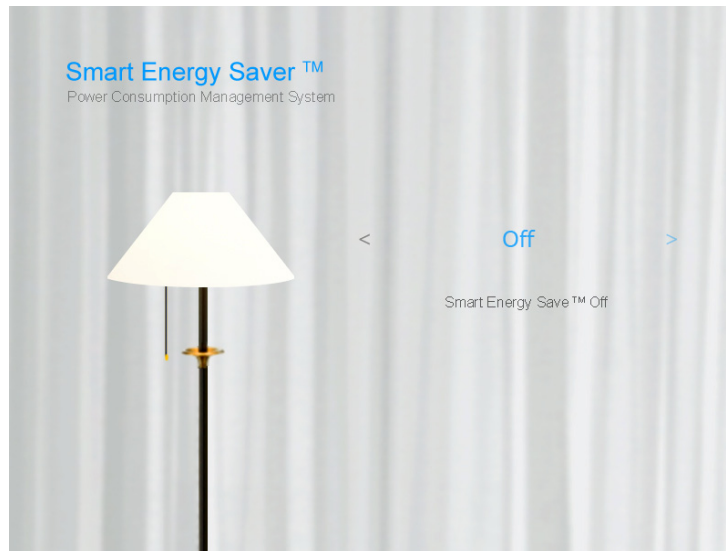

For details about the power-saving options, refer to the table below.

Options	Description
Off	Turns off Smart Energy Saver™ .
Auto 50%	Saves 50% on backlight power consumption during nighttime and automatically resumes normal power consumption during daytime.
Auto 100%	Puts the Picture Frame into sleep mode during nighttime and automatically resume normal backlight power consumption during daytime.
Save 20%	Always saves 20% on backlight power consumption.
Save 50%	Always saves 50% on backlight power consumption.
Customized	Personalize Smart Energy Saver™ hours to your preference.

- ✧ Night time is defined as hours from 9:00 pm to 7:00 am.
- ✧ Daytime is defined as hours from 7:00 am to 9:00 pm.
- ✧ Using Smart Energy Saver™ does not affect the photo quality

Using **CLOCK** (EZ Access Button)

Selecting a clock skin

The Picture Frame provides various preloaded clock and calendar skins. To set a default clock skin to be displayed in Clock view, follow the steps below.

1. In the main menu, press ◀ or ▶ to select **CLOCK**, and then press OK.
2. Press ◀ or ▶ to select a desired skin.

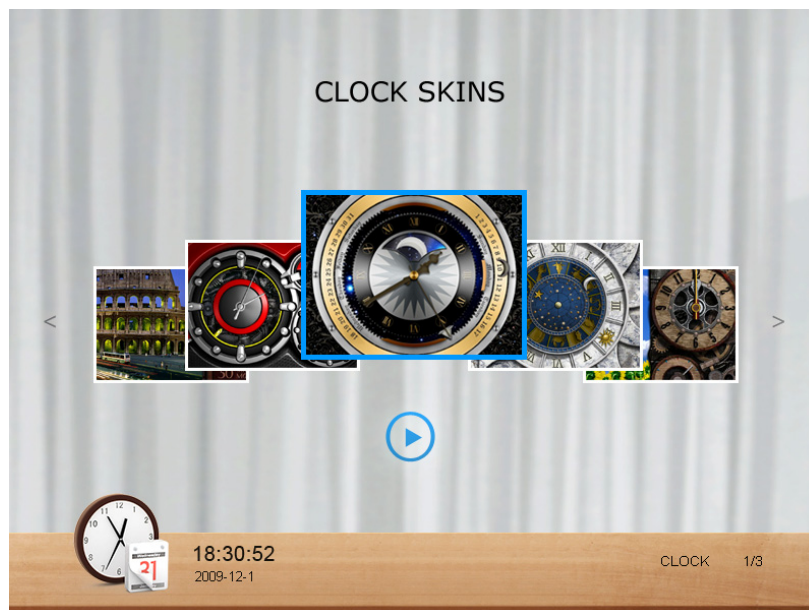

3. Press MENU and select Default.
4. Press OK to set the selected clock skins as default. The default clock skin will be displayed when EZ Access Button is pressed.

Switching between Clock view and Slideshow view

You can press EZ Access Button () to toggle between Clock view and Slideshow view.

- ✧ When switching from Clock view to Slideshow view, the Photo Frame starts the slideshow that was running previously.
- ✧ If the last slideshow was playing from memory card or USB and is no longer available, the Picture Frame will start a slideshow from the Internal Memory.

Using SCRAPBOOK

HP **DIGITAL SCRAPBOOK** feature provides a brand new user experience in enjoying photo slideshows.

1. In the main menu, press ◀ or ▶ to select **SCRAPBOOK**, and then press OK.
2. Press◀ or ▶ to select a template, and then press OK.



3. Select an album that contains the photos you wish to display in slideshow, and then press OK.



The Picture Frame will start to display the photos in slideshow using the selected template.

Using SETTINGS

The **SETTINGS** menu allows you to configure the settings of the Picture Frame.

1. In the main menu, press ◀ or ▶ to select **SETTING**, and then press OK. The **Date and Time** page appears.
2. Press ◀ or ▶ to toggle among **Date and Time**, **General Settings** and **Information** pages.

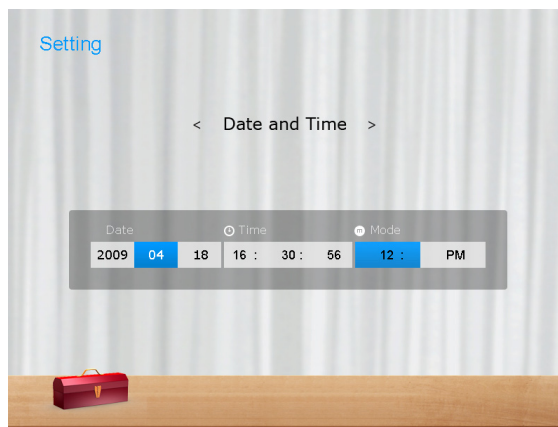

3. Press OK to enter a page, and the first option in that page will be highlighted.
4. Press OK again. When the marks < > appear in the field, press ◀ or ▶ to adjust the settings.
5. Press OK to exit.

Date and Time page

Item	Option	Description
Date	-	Allows you to set the date.
Time	-	Allows you to set the time.
Mode	-	Allows you to select a time format (12-hour clock or 24hour clock).
On Screen Clock	On	On screen display of the digit clock during slideshow mode.
	Off	
Current Time Zone	-	Allows you to select the time zone that matches your current geographic location.
Second Time Zone	-	Allows you to set a second time zone additionally.

General Settings Page

Item	Option	Description
Brightness	1	Allows you to select the level of screen brightness.
	2	
	3	
	4	
	5	
Smart Copy	Determines how photos are copied from the external storage devices to the internal memory when using the Smart Copy feature.	
	Resize	Resizes the photos to save memory space.
	Original	Keeps the original file size.
Smart Cropping	Full-screen	Selects to display photos in original size or full screen.
	Original	
Language	English	Sets up the On-Screen Display (OSD) language.
	Spanish	
	French	
Reset	Yes	Returns all the settings back to system default.
	No	
FW Upgrade	Yes	Upgrades the firmware of the Picture Frame.

Information Page

Item	Option	Description.
Firmware Version	-	Shows the current firmware version.
Total Memory	-	Shows the total capacity of the internal memory.
Free Memory	-	Shows the remaining capacity of the internal memory

Selecting a language

Select a language and set the date and time during the first use of the Picture Frame.

1. In the main menu, press ◀ or ▶ to select SETTINGS, and then press OK.
2. Press ▶, the General Settings page appears.
3. Press OK, press ▶ to go to Language, and then press OK again.
4. Press ◀ or ▶ to select a language you wish to use, and then press OK.
5. Press "ESC" to exit.

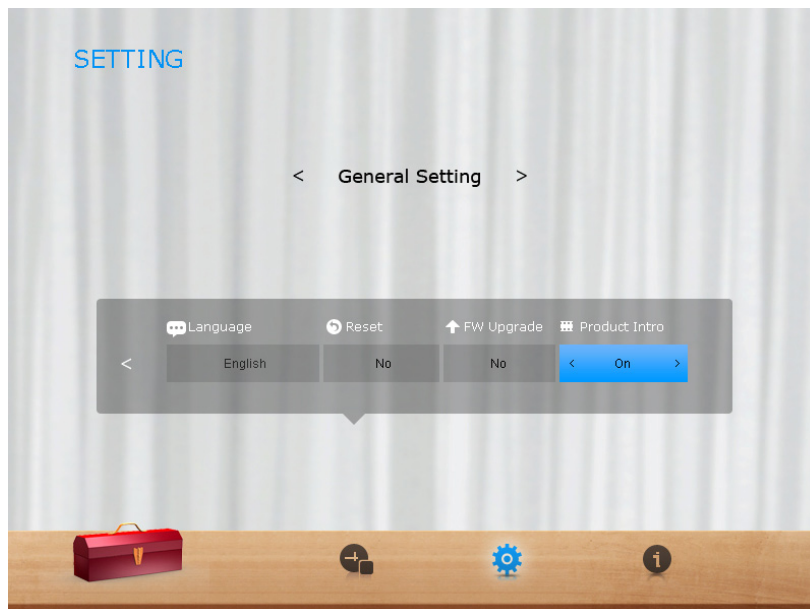

Setting the date and time

1. In the main menu, press ◀ or ▶ to select SETTINGS, and then press OK. The Date and Time page appears.
2. Press OK to highlight the Year field, press ◀ or ▶ to select a year, and then press OK to confirm the setting
3. Press ▶ to move to move to the Month field, press OK to highlight the Month field, press ◀ or ▶ to select a month, and the press OK to confirm the setting.
4. Repeat Step 3 for the remaining fields, including Date, Hour, Minute, Mode, On Screen Clock, Current Time Zone and Second Time Zone.
5. Press “ESC” to exit

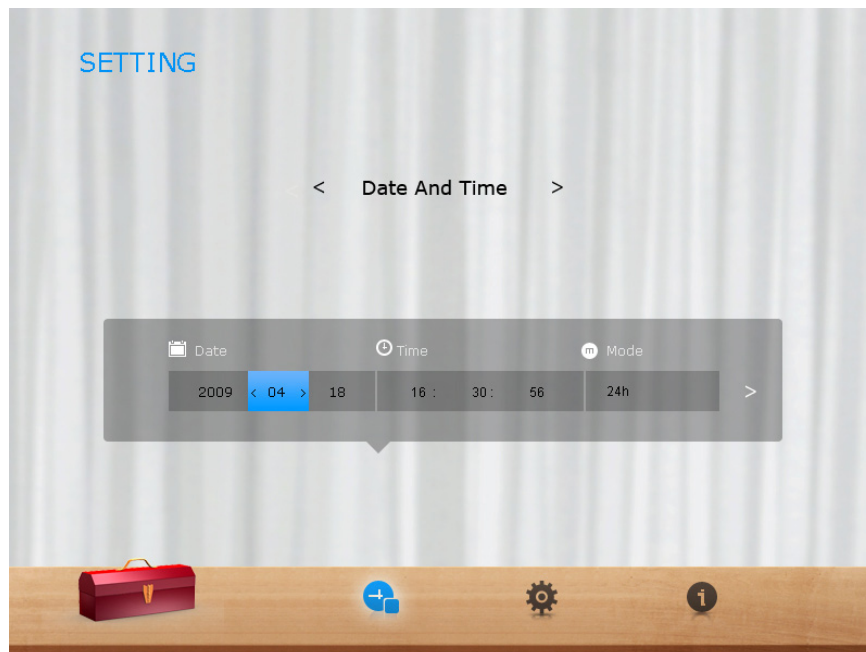

Step 4: Copying photos to internal memory

When inserting a memory card or a USB flash drive, you will be prompted to copy all photos to the internal memory.

If “Smart Copy” is set to “Resize” in the settings menu, photos will be resized to the screen resolution when copied to the internal memory to optimize the storage capacity. Please keep a copy of the original photos on your memory card or USB flash drive. "Smart Copy" is not available with photos transferring via PC.

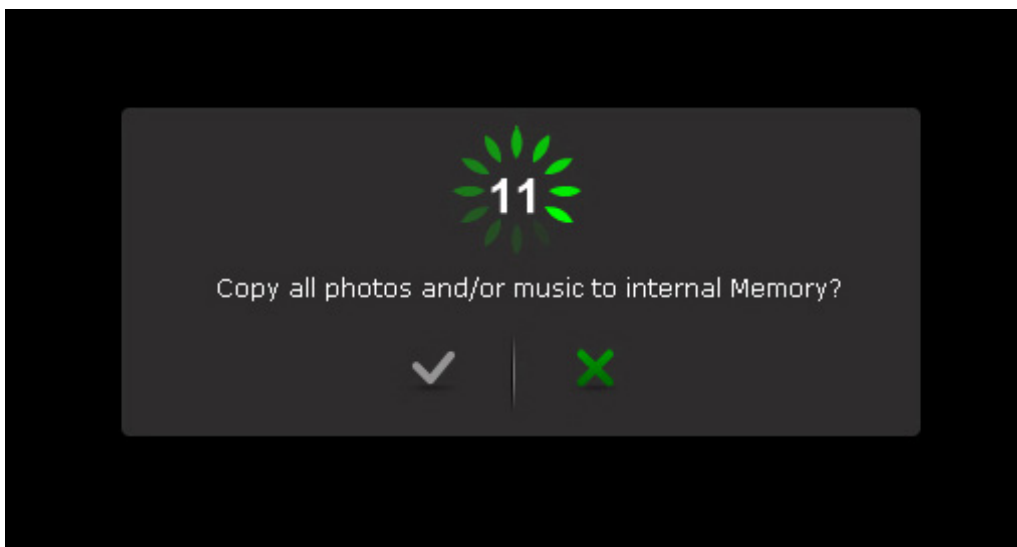

- To copy all photos contained on the inserted memory card (or USB flash drive), select the check mark ✓ and press OK.
- To view photos without copying them to the connection, select the cross mark ✗ and press OK. The Picture Frame will start playing back the photos automatically from the inserted memory card or USB flash drive
- Do not remove the memory card/USB flash drive before the copy process is completed.
- If the files you wish to copy from the memory card/USB flash drive already exists on the internal memory of the Picture Frame, the files will be overwritten when you select ✓ to proceed.

Step 5: Connecting to a computer

You can connect the Picture Frame to a computer using the mini USB cable to easily manage the files in the internal memory.

1. Start the computer and power on the Picture Frame.
2. Connect the smaller end of the USB cable to the mini USB port of the Picture Frame.
3. Connect the other end of the USB cable to a USB port on the computer, making sure the connectors are fully inserted.
4. Once connected, the Picture Frame will enter PC transfer mode automatically.
5. When the computer has detected the connection, the Picture Frame will appear in “My Computer” as “removable disk”.
6. Now you can freely transfer the files on the Picture Frame as you would on other disk drive.

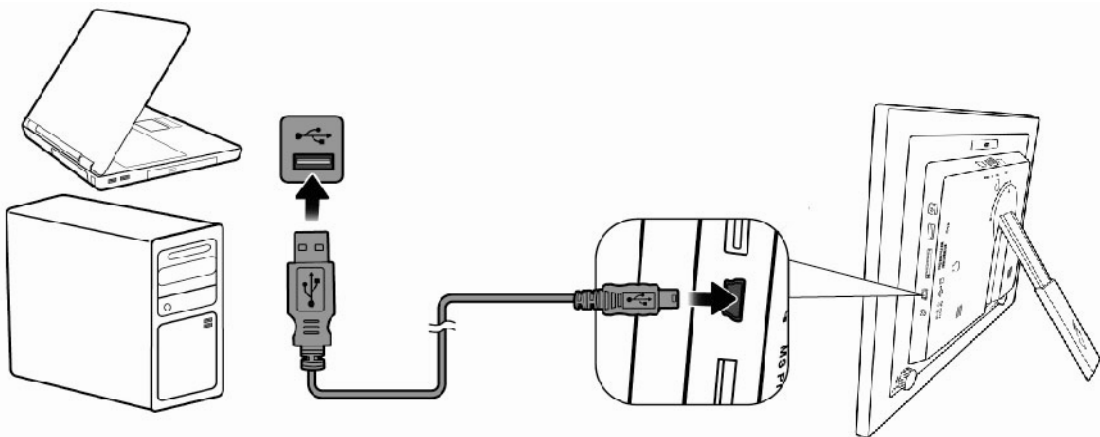

- You can copy photos from the computer to the Picture Frame, and vice versa.
- The files on the memory cards and USB flash drive cannot be viewed / edited via USB connection.

Frequently asked questions

What memory card formats are compatible with the Picture Frame?

SD/SDHC, MMC, MS and MS PRO are compatible with the Picture Frame.

Why do some photos load faster than others?

Higher resolution photos load slower. Using a lower resolution when taking photos will speed up loading time. Smart Copy™ can be used to resize selected images to decrease loading time.

How does auto rotation work?

The Picture Frame will display in a landscape mode if placed on its long side (as shown on your product box). To display your photos in a portrait mode, rotate the Picture Frame on its right side.

Why are my photos appearing upside down?

The Picture Frame is placed upside down. Please rotate the frame.

What types of image files can I view on my Picture Frame?

The Picture Frame supports playback of JPEG, BMP images.

Can I connect my Picture Frame directly to my computer?

You can connect the Picture Frame directly to your computer via a mini USB cable.

Will the tagged photos be reset if I pull out the SD card?

No. The Digital Picture Frame (DPF) will write information into the MetaData of tagged photos. So the DPF will remember the photo's album categorization the next time the SD card is re-inserted to the unit.

The frame slows down significantly on certain photos. What can I do?

This is mainly due to extra processing time needed to decode very large size high resolution files. The DPF's Smart Copy (Resize by default) feature will automatically resize the file based on the unit's screen resolution and will significantly reduce the size of the photo and eliminate this issue. However, please always keep a copy of the original photos on the computer.

The frame froze and will not respond, what can I do?

If the frame freezes, it is easy to restart by unplugging from power, then

press power button again.

Why isn't the TIMELINE feature accessible for photos on my USB drive?

The TIMELINE feature only applies to photos stored on the internal memory. Please copy any photos on the USB drive to the internal memory if you wish to access this feature.

Why can't I tag my photos in my SD card to any albums?

Please check that your SD card is not locked because the DPF will need to be able to write information onto the files in order to tag to Album.

Appendix

Specifications

Specifications are subject to change without prior notice

Model	10"
Screen Size	10"
Backlight type	LED
Aspect ratio	16:9
Panel interface	Digital
Screen resolution	1024x600
Built-in internal memory	256MB
Supported memory card formats	SD/SDHC, MMC, MS, MS PRO
Supported image format	JPEG, BMP
USB port	Mini USB, USB host
USB compliant	Yes
Memory card slots	4-in-1
Input power	AC100-240V
Output power	DC 5V, 1.5A
Automatic photo rotation	Yes
Clock	Yes
Back stand	Foldable
Language support	English, French and Spanish
Plug & Play Compatibility	Windows 8/7/XP /Vista/2000/ MacOS X
Remote control	Yes