



HP EliteDisplay S240ml Monitor

User Guide

© 2014 Hewlett-Packard Development
Company, L.P.

Microsoft and Windows are either
trademarks or registered trademarks of
Microsoft Corporation in the United States
and/or other countries.

The only warranties for HP products and
services are set forth in the express
warranty statements accompanying such
products and services. Nothing herein
should be construed as constituting an
additional warranty. HP shall not be liable
for technical or editorial errors or omissions
contained herein.

This document contains proprietary
information that is protected by copyright.
No part of this document may be
photocopied, reproduced, or translated to
another language without the prior written
consent of Hewlett-Packard Company.

First Edition: May 2014

Document Part Number: 758437-001

About this guide

This guide provides information on monitor features, setting up the monitor, and technical specifications.

 **WARNING!** Text set off in this manner indicates that failure to follow directions could result in bodily harm or loss of life.

 **CAUTION:** Text set off in this manner indicates that failure to follow directions could result in damage to equipment or loss of information.

 **NOTE:** Text set off in this manner provides important supplemental information.

 **TIP:** Text set off in this manner provides helpful hints.

Table of contents

1 Product features	1
2 Setting up and using the monitor	3
Attaching the monitor stand base	3
Rear components	6
Connecting the cables	7
Adjusting the monitor	13
Adjusting the tilt	13
Adjusting the height	14
Front components	15
Turning on the monitor	16
HP watermark and image retention policy	17
Removing the monitor stand	17
Mounting the monitor	19
Locating the rating label	20
Installing a cable lock	20
3 Using the webcam	21
Installing YouCam from the disc	21
Capturing webcam video and snapshots	21
Having a video chat or making conference calls	22
4 Using HP MyRoom	23
Installing HP MyRoom from the disc	23
Downloading HP MyRoom from the Internet	23
Creating a HP MyRoom account	23
5 Using mobile high-definition link (MHL)	24
6 Finding more information	26
Reference guides	26

Product support	26
Appendix A Technical specifications	27
HP S240ml	27
Recognizing preset display resolutions	28
HP S240ml	28
Power adapter	29
Entering user modes	29
Energy saver feature	29

1 Product features



The LCD (liquid crystal display) monitor has an active matrix, wide viewing angle panel. The monitor features include:

- 60.5-cm (23.8-inch) diagonal viewable area display with 1920 x 1080 resolution, plus full-screen support for lower resolutions; includes custom scaling for maximum image size while preserving original aspect ratio
- Ultra-slim bezel IPS monitor
- MHL (mobile high-definition link) 2.0 support for connection with mobile devices
- LED backlight for energy efficiency
- Wide viewing angle to allow viewing from a sitting or standing position, or moving from side-to-side
- Tilt capability -5 to +21 degrees recline
- Removable stand for flexible monitor panel mounting solutions with VESA Standard 100 x 100 mounting pattern
- Video signal input to support HDMI digital with HDMI signal cable provided
- Video signal input to support MHL/HDMI digital with MHL signal cable provided
- Video signal input to support DisplayPort digital with DisplayPort signal cable provided
- Video signal input to support analog VGA with VGA signal cable provided

- Audio input jack with audio cable included
- Integrated webcam and dual microphone array
- Integrated speakers
- Audio output headphone jack
- Supports Windows 7 and Windows 8 operating systems only
- Plug and play capability on Windows 7 and Windows 8
- Security slot provision on rear of monitor for optional cable lock
- On-screen display (OSD) adjustments in several languages for easy setup and screen optimization
- HDCP (High-Bandwidth Digital Content Protection) copy protection on HDMI and DisplayPort inputs
- Software and documentation disc that includes monitor drivers and product documentation
- Energy saver feature to meet requirements for reduced power consumption
- Safety guidelines, certifications, and regulatory notices for this product are available in the *HP LCD Monitors Reference Guide* on the disc included with this monitor

2 Setting up and using the monitor

To set up the monitor, ensure that the power is turned off to the monitor, computer system, and other attached devices, and then follow the instructions below.

⚠ CAUTION: The screen is fragile. Avoid touching or applying pressure to the screen; doing so can cause damage.

Attaching the monitor stand base

1. Remove the monitor with attached stand from its box and lay it on a flat surface covered by a clean, dry cloth.
2. Remove the cover from the base.

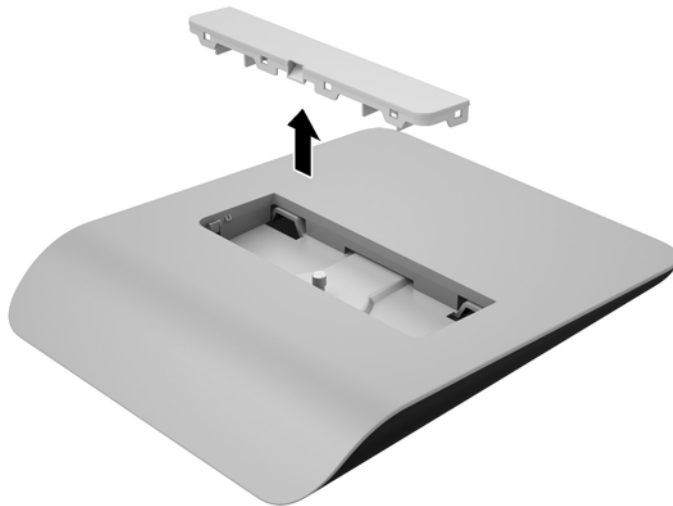

3. Attach the stand base to the stand by tilting the stand base to engage the two tabs on the bottom of the stand riser with the slots in the stand base (1).

4. Rotate the stand base upward so that the flat bottom of the stand riser is fully seated within the recess of the stand base (2).



5. Tighten the captive screw on the underside of the base to secure the base to the stand.



6. Tilt the stand base cover and first insert the edge away from the stand (1), and then press the cover down to snap the cover into place (2).

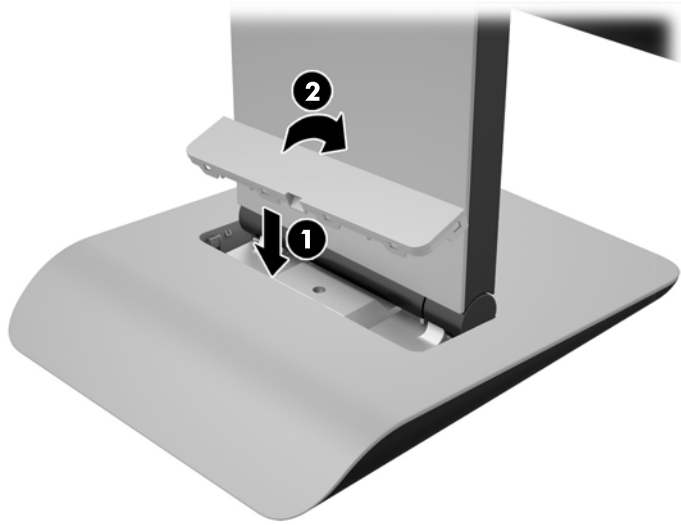

Rear components

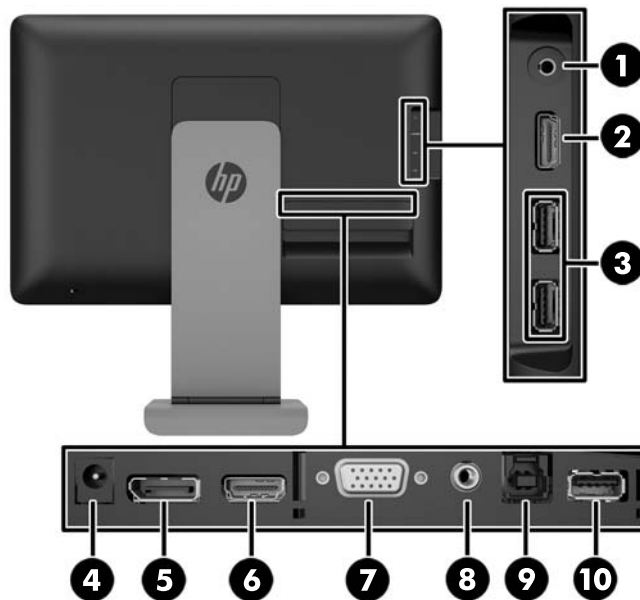

Component	Description
1	Headphone jack Connects the headphone cable (not included) to the monitor.
2	MHL/HDMI connector Connects the MHL cable to the monitor. Can also be used to connect the HDMI cable to the monitor.
3	USB 3.0 (2) connector Connects the USB cable or device to the monitor.
4	DC power connector Connects the DC power cable to the monitor.
5	DisplayPort connector Connects the DisplayPort cable to the monitor.
6	HDMI connector Connects the HDMI cable to the monitor.
7	VGA connector Connects the VGA cable to the monitor.
8	Audio In connector Connects the audio cable from a host computer to the monitor .
9	USB upstream connector Connects the USB cable to the monitor's USB connector and to a host USB port/hub. NOTE: A USB connection between the monitor and computer is required for webcam functionality.
10	USB 3.0 connector Connects the USB cable or device to the monitor.

Connecting the cables

 **NOTE:** Use only the video cable(s) included with the monitor.

Connecting the cables may be easier if you first lay the monitor panel face down on a flat surface covered by a clean, dry cloth.

1. Rotate the bottom of the cable cover up (1) then slide out the top of the cover (2) to remove it.

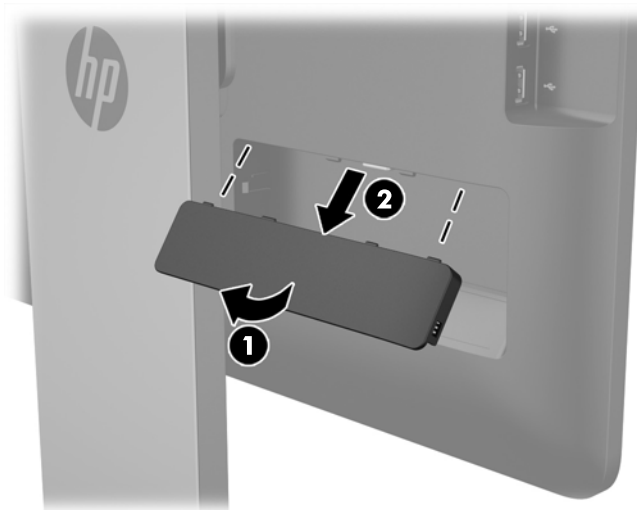

2. Depending on your configuration, connect either the DisplayPort, HDMI, or VGA video cable between the source device and the monitor.

 **NOTE:** The video mode is determined by the video cable used. The monitor will automatically determine which inputs have valid video signals. The inputs can be selected by pressing the **Input** button on the side panel or through the On-Screen Display (OSD) feature by pressing the **Menu** button.

- For DisplayPort digital operation, connect the DisplayPort signal cable to the DisplayPort connector on the rear of the monitor and the other end to the DisplayPort connector on your input device (cable provided).

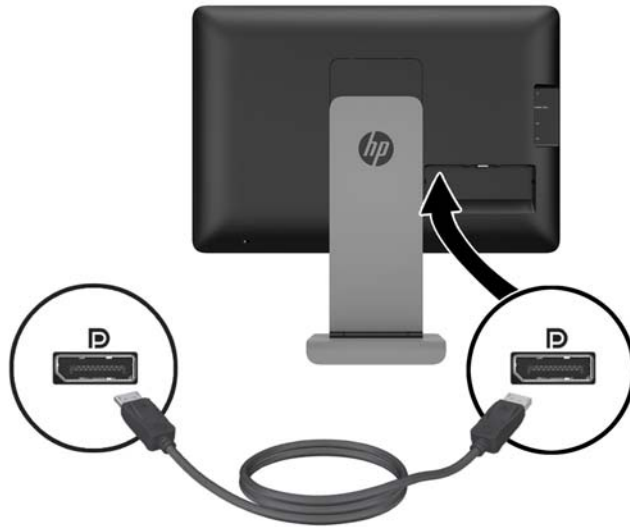

- For HDMI digital operation, connect the HDMI signal cable to the HDMI connector on the rear of the monitor and the other end to the HDMI connector on your input device (cable provided).

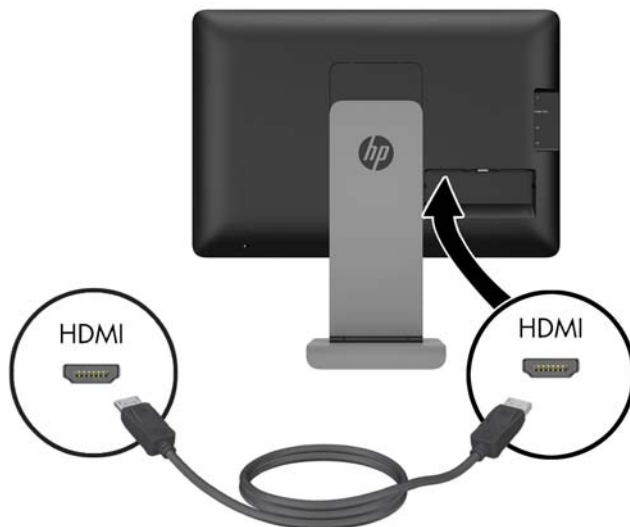

- For VGA analog operation, connect the VGA signal cable to the VGA connector on the rear of the monitor and the other end to the VGA connector on your input device (cable provided).



3. Connect the provided MHL cable to the MHL/HDMI connector on the side of the monitor and the other end of the cable to the Micro USB connector on the mobile device.

 **NOTE:** For more information, see [Using mobile high-definition link \(MHL\) on page 24](#).

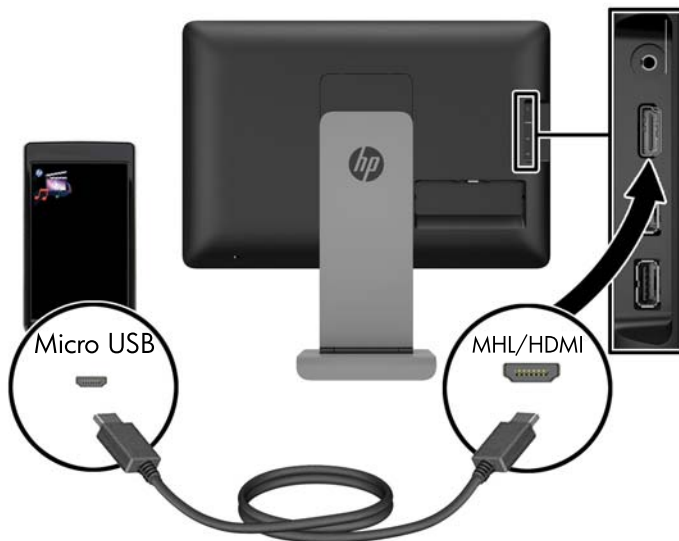

4. Connect one end of the provided USB cable to a USB connector on the rear panel of the computer, and the other end to the USB connector on the monitor.

 **NOTE:** You must connect the USB cable between the computer and monitor for webcam functionality.

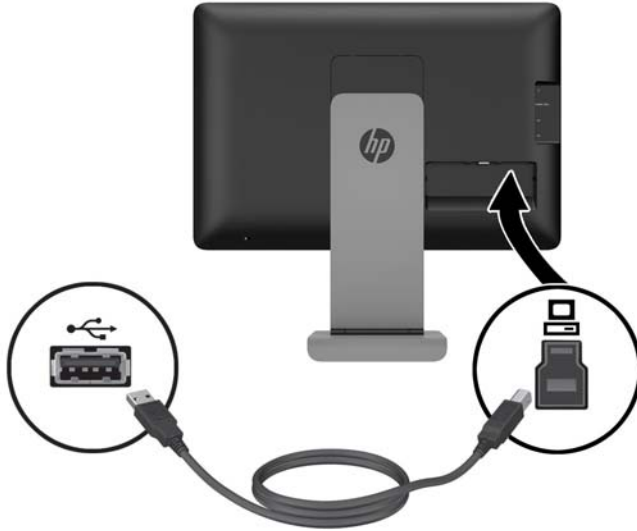

5. Connect a USB device to a USB connector on the side of the monitor.



6. Connect a headphone cable to the headphone jack on the side of the monitor.

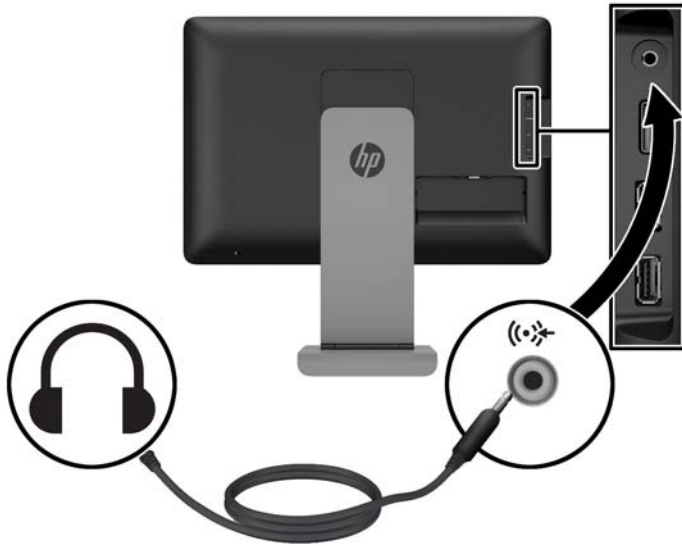

7. Connect the provided audio cable to the audio input connector on the rear of the monitor and the other end to the audio output jack on your input device.

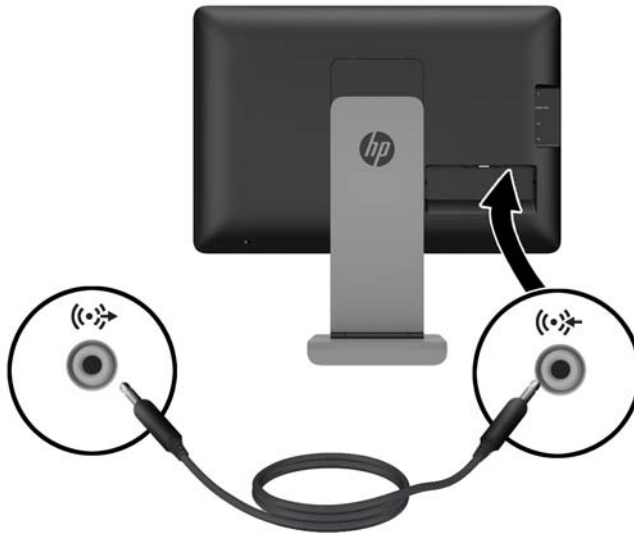

8. Plug the power cord into the power supply brick (1), and then connect the other end of the power cord to an electrical outlet (2). Plug the round end of the power supply cord into the power supply connector on the rear of the monitor (3).

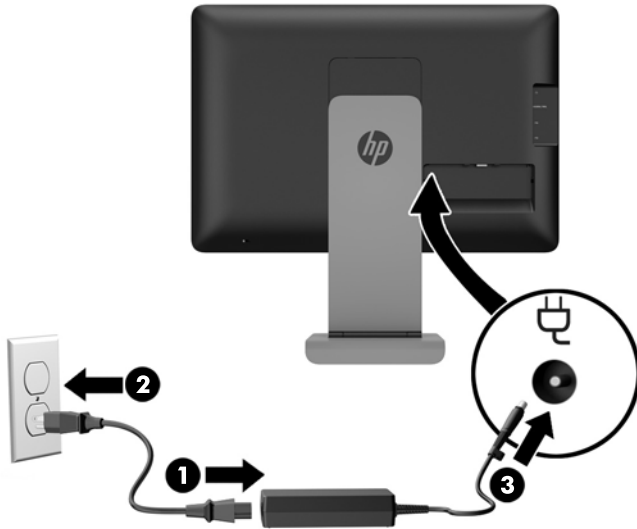

⚠ WARNING! To reduce the risk of electric shock or damage to the equipment:

Plug the power cord into AC outlet that is easily accessible at all times.

Disconnect power from the computer by unplugging the power cord from the AC outlet.

If provided with a 3-pin attachment plug on the power cord, plug the cord into a grounded (earthed) 3-pin outlet. Do not disable the power cord grounding pin, for example, by attaching a 2-pin adapter. The grounding pin is an important safety feature.

9. Replace the cable cover on the rear of the monitor by sliding the tabs on the top of the cover into the slots on the top of the cable connection recess (1) then rotate the cover down and snap into the recess (2) so that it is securely fastened to the rear of the monitor.

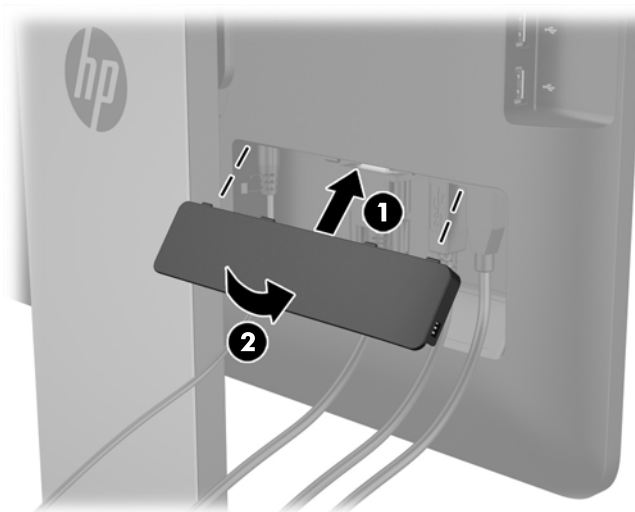

Adjusting the monitor

To reduce the risk of serious injury, read the *Safety & Comfort Guide*. It describes proper workstation, setup, posture, and health and work habits for computer users, and provides important electrical and mechanical safety information. The *Safety & Comfort Guide* is located on the HP website at <http://www.hp.com/ergo>.

Adjusting the tilt

Adjust the tilt to the desired position. To adjust the tilt upward, hold the top of the monitor with two hands and rotate the monitor upward and forward. To adjust the tilt downward, hold the top of the monitor with two hands and rotate the monitor back and down.

The monitor tilt range is -5 to +21 degrees.



Adjusting the height



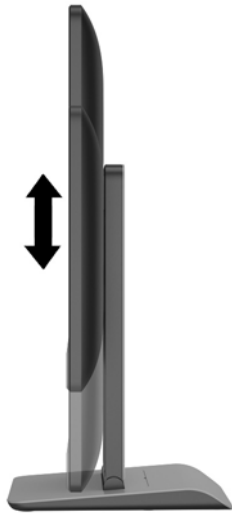

Adjust the height to a comfortable position. To raise the monitor, hold the top of the monitor with two hands and lift the monitor up. To lower the monitor, hold the top of the monitor with two hands and push the monitor down.

The monitor height range is 0 mm to 130 mm.

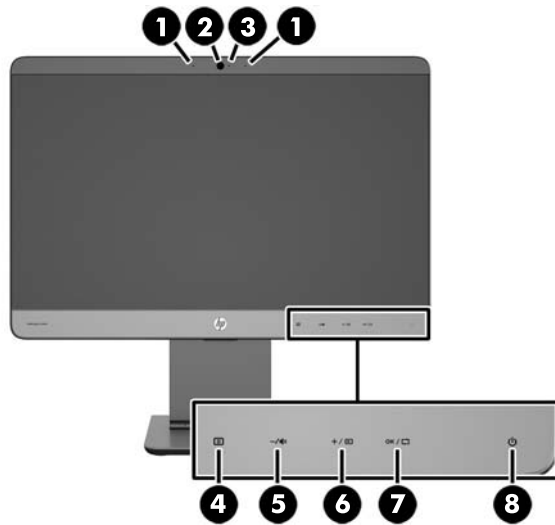

Front components



Component	Description
1	Dual microphone array Integrated into the top of the monitor's bezel.
2	Webcam Integrated into the top of the monitor's bezel.
3	Webcam activity LED Indicates that the Webcam is active
4	 Menu button Opens, selects from, or exits the OSD menu.
5	 Minus/volume button If the OSD menu is on, press to navigate backward through the OSD menu and decrease adjustment levels. If the OSD menu is inactive, press to activate the volume adjustment menu.
6	 Plus/input control If the OSD menu is on, press to navigate forward through the OSD menu and increase adjustment levels. If the OSD menu is inactive, press to activate the input control that chooses the video signal input (DisplayPort, HDMI, MHL/HDMI, or VGA).
7	 OK/auto adjust If the OSD menu is on, press to select the highlighted menu item. If the OSD menu is inactive, press to activate the auto adjustment feature to optimize the screen image (VGA input only).
8	 Power button Turns the monitor on or off.

 **NOTE:** To view an OSD menu simulator, visit the HP Customer Self Repair Services Media Library at <http://www.hp.com/go/sml>.

Turning on the monitor

1. Press the power button on the source device to turn it on.
2. Press the capacitive power button on the lower right front of the monitor to turn it on.

 **NOTE:** When the power button is pressed, the other capacitive button icons light up briefly.

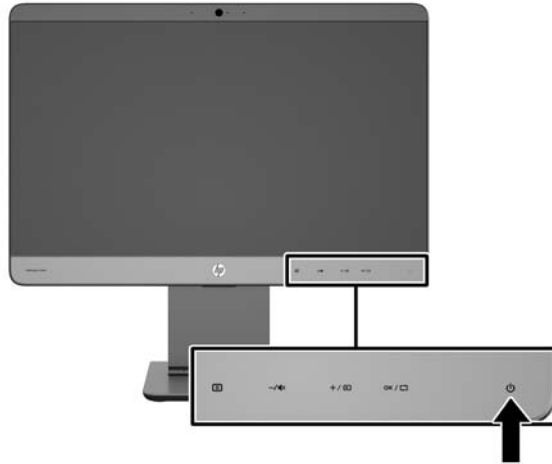

 **CAUTION:** Burn-in image damage may occur on monitors that display the same static image on-screen for 12 or more consecutive hours of non-use. To avoid burn-in image damage on the monitor screen, you should always activate a screen saver application or turn off the monitor when it is not in use for a prolonged period of time. Image retention is a condition that may occur on all LCD screens. Monitors with a “burned-in image” are not covered under the HP warranty.

 **NOTE:** If pressing the power button has no effect, the Power Button Lockout feature may be enabled. To disable this feature, press and hold the monitor power button for 10 seconds.

 **NOTE:** You can disable the power LED in the OSD menu. Press the **Menu** button on the front of the monitor, then select **Management > Bezel Power LED > Off**.

When the monitor is powered on, a status message is displayed for five seconds. The message shows which input (HDMI, DisplayPort, VGA, or MHL) is the current active signal, the status of the auto-switch source setting (On or Off; factory default is On), the default source signal (factory default is DisplayPort), the current preset display resolution, and the recommended preset display resolution.

The monitor automatically scans the signal inputs for an active input and uses that input for the display. If two or more inputs are active, the monitor will display the default input source. If the default source is not one of the active inputs, then the monitor will display the highest ranking priority input. You can change the default source in the OSD by pressing the front panel **Menu** button and selecting **Input Control > Default Input**.

HP watermark and image retention policy

The IPS monitor models are designed with IPS (In-Plane Switching) display technology which provides ultra-wide viewing angles and advanced image quality. IPS monitors are suitable for a wide variety of advanced image quality applications. This panel technology, however, is not suitable for applications that exhibit static, stationary or fixed images for long periods of time without the use of screen savers. These types of applications may include camera surveillance, video games, marketing logos, and templates that are displayed on the screen for a prolonged period of time. Static images may cause image retention damage that could look like stains or watermarks on the monitor's screen.

Monitors in use for 24 hours per day that result in image retention damage are not covered under the HP warranty. To avoid image retention damage, always turn off the monitor when it is not in use or use the power management setting, if supported on your system, to turn off the display when the system is idle.

Removing the monitor stand

You can remove the monitor panel from the stand to install the panel on a wall, a swing arm, or other mounting fixture.

⚠ CAUTION: Before beginning to disassemble the monitor, be sure the monitor is turned off and the power and signal cables are both disconnected. Also disconnect the USB and audio cables connected to the monitor.

1. Disconnect and remove the signal, power, USB, and audio cables from the monitor.
2. Lay the monitor face down on a flat surface covered by a clean, dry cloth so the base extends over the edge of the surface and the monitor is lying flat on the surface.
3. Push the stand cover toward the top of the stand to disengage the "L" tabs (about 1/2 inch) (1), and then lift the cover off the stand riser (2).

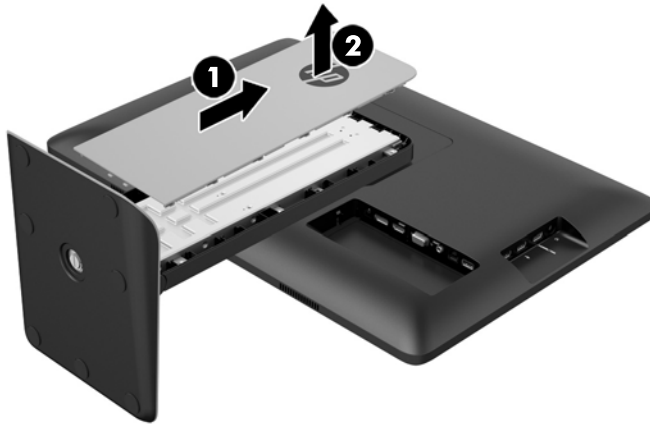

4. Loosen the two captive screws that secure the stand to the display head.

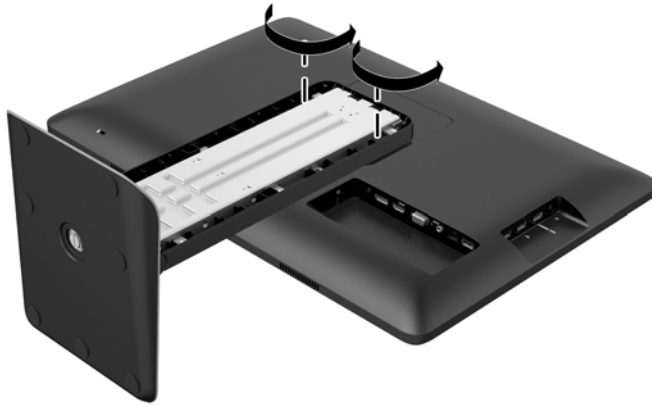

5. Lift the base up after 45 degrees to disengage the stand (1), and then pull the stand off of the monitor (2).



Mounting the monitor

The monitor panel can be attached to a wall, swing arm, or other mounting fixture with a 100 mm x 100 mm mounting pattern.



NOTE: This apparatus is intended to be supported by a UL or CSA listed wall mount bracket.

1. Remove the monitor panel from the stand. Refer to [Removing the monitor stand on page 17](#).



CAUTION: This monitor supports the VESA industry standard 100 mm mounting holes. To attach a third-party mounting solution to the monitor, four 4 mm, 0.7 pitch, and 10 mm long screws are required. Longer screws must not be used because they may damage the monitor. It is important to verify that the manufacturer's mounting solution is compliant with the VESA standard and is rated to support the weight of the monitor display panel. For best performance, it is important to use the power and video cables provided with the monitor.

2. To attach the monitor to a swing arm, insert four 10 mm screws through the holes on the swing arm plate and into the mounting holes on the monitor.

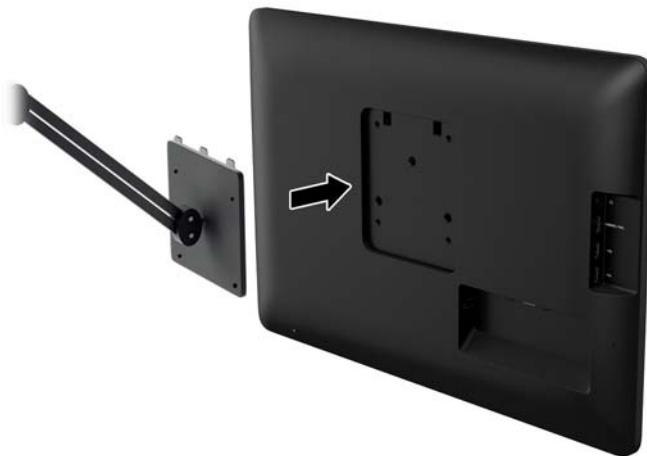

To attach the monitor to other mounting fixtures, follow the instructions included with the mounting fixture to ensure that the monitor is safely attached.

3. Reconnect the cables to the monitor panel.

Locating the rating label

The rating label on the monitor provides the spare part number, product number, and serial number. You may need these numbers when contacting HP about the monitor model. The rating label is located on the rear panel of the monitor behind the cable cover.



Installing a cable lock

You can secure the monitor to a fixed object with an optional cable lock available from HP.

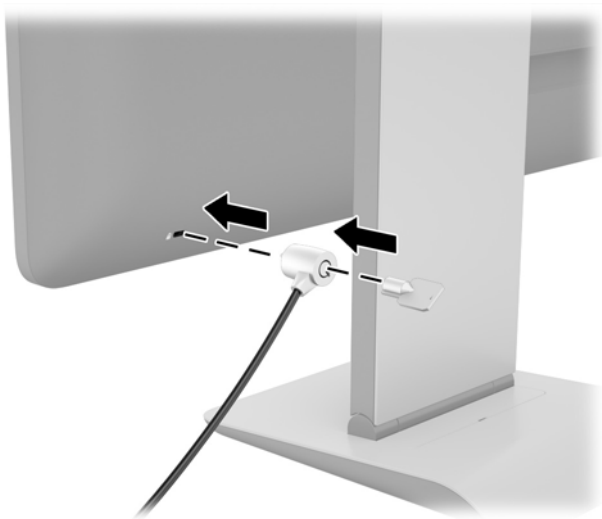

3 Using the webcam

Install CyberLink YouCam software and driver from the disc that came with your monitor. If you do not have an optical disc drive, you may go to <http://www.cyberlink.com/prog/support/cs/index.do>, select your country, and download the YouCam software.



NOTE: USB connectivity between the monitor and PC is required for the webcam to operate.

Use your webcam to:

- Create videos from files on your computer.
- Create snapshots to view, organize, edit, send, and print.
- Create video notes for an enhanced visual calendar and to share.
- Initiate live video chats with Windows Live Messenger or other compatible software program.
- Import live videos into a movie-making program to save, send, stream on the Web, or record to disc.

Installing YouCam from the disc

To install YouCam:

1. Insert the disc that came with your monitor into the computer's optical drive.
2. Select **Install YouCam** and run the setup file.
3. Follow the instructions on the screen.

Capturing webcam video and snapshots

To use CyberLink YouCam after you install it from the provided disc:

1. Click the **Start** button.
2. Click **All Programs**, **CyberLink YouCam**, and then click **CyberLink YouCam** again.
3. Click **Tutorials** to view an instructional video.

Having a video chat or making conference calls

To set up a video chat, you must have a connection to the Internet, and ISP, and software that enables you to make video calls over the Internet. As with chat or instant messenger software, you can use this kind of software to chat with one or more people at a time. This software may require a separate subscription.

The optimal distance for recording sound with the array microphone is about .5 meters (2 feet) away from the microphone.

Before you can set up a video chat:

1. Download an Internet messenger or video phone call program. Make sure the person you are calling has compatible video-calling software.
2. Enable your webcam as the default video input. This is usually done through the video setup in the **Tools** menu in the software program you are using.
3. Send your video call by following the instructions for the video-calling software program.

4 Using HP MyRoom

HP MyRoom is your online meeting room. Connect with business colleagues “face to face” and collaborate with useful tools.

Installing HP MyRoom from the disc

To install HP MyRoom:

1. Insert the disc that came with your monitor into the computer media drive.
2. Select **Install MyRoom** and run the setup file.
3. Follow the instructions on the screen.

Downloading HP MyRoom from the Internet

To download HP MyRoom:

1. Go to <https://www.rooms.hp.com/myroom>.
2. **Select language** of your choice in the upper right-hand corner of the screen. Click **Go** if changing language.
3. Click **Download Now**.
4. Click **Run** to run the file.
5. Follow the instructions on the screen to complete the software installation.

Creating a HP MyRoom account

To begin using HP MyRoom after the software installation is complete:

1. Click **Create New Account**.
2. Enter your name, e-mail address, and set a password.
3. Follow the prompt to validate your e-mail address.
4. Sign in to HP MyRoom.
5. Begin using HP MyRoom by clicking on the Add Contact button.
6. Click the question mark button and select **Documentation** for detailed instructions.

5 Using mobile high-definition link (MHL)

MHL is used to transmit a mirrored image of an attached smart phone or tablet to the monitor while also recharging the device battery. The smart phone or tablet must be attached using the supplied MHL cable.

 **NOTE:** The mobile device must be a certified MHL device. Certified devices are listed at <http://www.mhltech.org/productlist/mobile-devices/>.

1. Verify that the mobile device is a certified MHL device.
2. Connect the HDMI end of the provided MHL signal cable to the MHL/HDMI connector on the side of the monitor and the other end of the cable to the Micro USB connector on the mobile device.

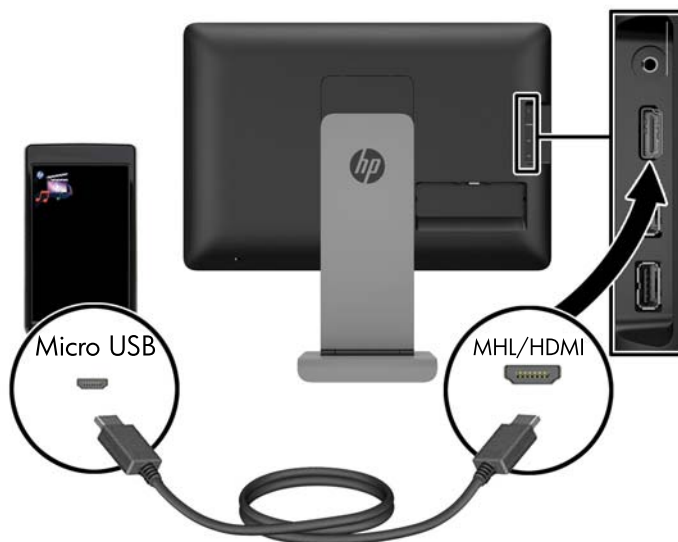

 **NOTE:** The MHL/HDMI connector on the side of the monitor is the only connector that is enabled for connecting MHL mobile devices.

3. If the mobile device screen is locked or the device is in power-saving mode, unlock the screen or deactivate the power-saving mode.
4. Turn on the monitor.

If no other video connection is active, the new input source is automatically detected and the image on the mobile device screen appears on the display.

 **NOTE:** The entire screen is dedicated to the MHL device and cannot be shared with any other video source.

- a. To change the input source to HDMI/MHL if another video connection is active, press + /  and select **MHL**.
- b. If no signal or picture appears, turn the monitor off and then on again.

Screen resolution and picture scale is determined by the mobile device. Images from some mobile devices, are scaled to fill the screen, but they retain the original aspect ratio. If the MHL cable is disconnected, the monitor displays another active video source.

6 Finding more information

Reference guides

Refer to the *HP LCD Monitors Reference Guide* included on the disc with your monitor for additional information on:

- Optimizing monitor performance
- Safety and maintenance guidelines
- Installing software from the disc
- Using the OSD menu
- Downloading software from the Web
- Agency regulatory information
- Troubleshooting and recommended solutions to common problems

Product support

For additional information on using your monitor, go to <http://www.hp.com/support>. Select your country or region, select **Troubleshooting**, and then enter your model in the search window and click the **Go** button.



NOTE: The monitor user guide, reference guide, and drivers are available at <http://www.hp.com/support>.

If the information provided in the guide or in the *HP LCD Monitors Reference Guide* do not address your questions, you can contact support. For U.S. support, go to <http://www.hp.com/go/contactHP>. For worldwide support, go to http://welcome.hp.com/country/us/en/wwcontact_us.html.

Here you can:

- Chat online with an HP technician



NOTE: When support chat is not available in a particular language, it is available in English.

- Find support telephone numbers
- Locate an HP service center

A Technical specifications

 **NOTE:** All specifications represent the typical specifications provided by HP's component manufacturers; actual performance may vary either higher or lower.

HP S240ml

Viewable Image Size	60.5-cm diagonal	23.8-inch diagonal
Maximum Weight (Unpacked)	6.6 kg	14.55 lbs
Dimensions (with stand)		
Height	38.4 cm	15.1 inches
Depth	23.9 cm	9.4 inches
Width	54.0 cm	21.3 inches
Maximum Graphic Resolution	1920 x 1080 (60 Hz) digital input	
Optimum Graphic Resolution	1920 x 1080 (60 Hz) digital input	
Environmental Requirements Temperature		
Operating Temperature	5° to 35° C	41° to 95° F
Storage Temperature	-20° to 60° C	-4° to 140° F
Altitude		
Operating	0 to 5,000 m	0 to 16,400 ft
Storage/Shipment	0 to 12,192 m	0 to 40,000 ft
Power Source	100 – 240 VAC 50/60 Hz external adapter	
Input Terminal	One DisplayPort connector (cable provided), one HDMI connector (cable provided), one VGA connector (cable provided), and one MHL/HDMI connector (cable provided)	

NOTE: For the latest specifications or additional specifications on this product, go to and search for your specific display model to find the model-specific QuickSpecs.

Recognizing preset display resolutions

The display resolutions listed below are the most commonly used modes and are set as factory defaults. This monitor automatically recognizes these preset modes and they will appear properly sized and centered on the screen.

HP S240ml

Table A-1 Factory preset modes

Preset	Pixel format	Horz freq (kHz)	Vert freq (Hz)
1	640 × 480	31.469	59.940
2	720 × 400	31.469	70.087
3	800 × 600	37.879	60.317
4	1024 × 768	48.363	60.004
5	1280 × 720	45.00	60.00
6	1280 × 800	49.702	59.81
7	1280 × 1024	63.981	60.02
8	1440 × 900	55.935	59.887
9	1600 × 900	60.00	60.00
10	1680 × 1050	65.29	59.954
11	1920 × 1080	67.50	60.00

Table A-2 High Definition video formats

Preset	Timing name	Pixel format	Horz freq (kHz)	Vert freq (Hz)
1	480p	720 × 480	31.469	59.94
2	576p	720 × 576	31.25	50
3	720p50	1280 × 720	37.5	50
4	720p60	1280 × 720	45	60
5	1080p50	1920 × 1080	56.25	50
6	1080p60	1920 × 1080	67.5	60

Power adapter

Table A-3 Power Adapters/Model

Manufacturer	Model Number	Power Supply Rating
TPV	ADPC1965	65 W/19 V

Entering user modes

The video controller signal may occasionally call for a mode that is not preset if:

- You are not using a standard graphics adapter.
- You are not using a preset mode.

If this occurs, you may need to readjust the parameters of the monitor screen by using the on-screen display. Your changes can be made to any or all of these modes and saved in memory. The monitor automatically stores the new setting, then recognizes the new mode just as it does a preset mode. In addition to the factory preset modes, there are at least 10 user modes that can be entered and stored.

Energy saver feature

The monitors support a reduced power state. The reduced power state will be entered into if the monitor detects the absence of either the horizontal sync signal and/or the vertical sync signal. Upon detecting the absence of these signals, the monitor screen is blanked, the backlight is turned off, and the power light is turned amber. When the monitor is in the reduced power state, the monitor will utilize 0.5 watts of power. There is a brief warm-up period before the monitor will return to its normal operating mode.

Refer to the computer manual for instructions on setting energy saver features (sometimes called power management features).



NOTE: The above power saver feature only works when connected to computers that have energy saver features.

By selecting the settings in the monitor's sleep timer utility, you can also program the monitor to enter into the reduced power state at a predetermined time. When the monitor's sleep timer utility causes the monitor to enter the reduced power state, the power light blinks amber.