



HP LD4235 and HP LD4735 Digital Signage Displays

User Guide

© 2014 Hewlett-Packard Development Company, L.P. The information contained herein is subject to change without notice.

The only warranties for HP products and services are set forth in the express warranty statements accompanying such products and services. Nothing herein should be construed as constituting an additional warranty. HP shall not be liable for technical or editorial errors or omissions contained herein.

This document contains proprietary information that is protected by copyright. No part of this document may be photocopied, reproduced, or translated to another language without the prior written consent of Hewlett-Packard Company.

Microsoft and Windows are U.S. registered trademarks of the Microsoft group of companies.

First Edition (January 2014)

Document Part Number: 749846-001

About this guide

This guide provides information on setting up the display, troubleshooting, and technical specifications.

 **WARNING!** Text set off in this manner indicates that failure to follow directions could result in bodily harm or loss of life.

 **CAUTION:** Text set off in this manner indicates that failure to follow directions could result in damage to equipment or loss of information.

 **NOTE:** Text set off in this manner provides important supplemental information.

Table of contents

1 Product features	1
HP Digital Signage models	1
Accessories	2
Optional accessories	2
2 Safety and maintenance guidelines	3
Important safety information	3
Maintenance guidelines	3
Cleaning the display	4
3 Assembling and preparing	5
Using the IR receiver	6
Portrait layout	7
Using the security system	7
Mounting on a wall	8
Securing the product to a wall (optional)	9
4 Remote control	10
Remote control buttons	11
5 Using the display	13
Connecting to a Digital Signage media player or computer	13
RGB/VGA connection	14
DisplayPort connection	15
HDMI connection	16
IR receiver connection	17
LAN/VOE connection	18
Connecting the display using LAN/VOE	18
Connecting multiple displays to one player	19
Connecting multiple displays with Video Over Ethernet (VOE)	19
Connecting multiple displays with Tile Mode	19
Adjusting the screen	22
Selecting an image mode	22
Customizing image options	22
Customizing computer display options	23
Adjusting sound	23

Selecting a sound mode	23
Customizing sound options	24
Using additional options	24
Using the input list	24
Adjusting aspect ratio	24
16:9 : This selection will allow you to adjust the picture horizontally, in linear proportion, to fill the entire screen (useful for viewing 4:3 formatted DVDs).	25
Just Scan : This Selection will allow you to view the best quality picture without loss of the original picture in high resolution image.	25
1:1 : The aspect ratio is not adjusted from the original. (Only Display Port PC, HDMI PC, RGB PC)	26
4:3 : This selection will allow you to view a picture with an original 4:3 aspect ratio, black bars will appear on both the left and right of the screen.	26
Zoom : This selection will allow you to view the picture without any alteration, while filling the entire screen. However, the top and bottom of the picture will be cropped.	26
Cinema Zoom : Choose Cinema Zoom when you want to enlarge the picture in correct proportion. Note: When enlarging or reducing the picture, the image may become distorted.	27
6 Customizing settings	28
Accessing main menus	28
PICTURE settings	29
Picture Mode options	30
Advanced control	30
AUDIO settings	31
TIME settings	32
OPTION settings	33
Picture ID	38
NETWORK settings	38
7 Making connections	40
Connecting to a Computer, HD receiver, DVD, or VCR	41
DisplayPort connection	41
HDMI connection	42
Component connection	43
Connecting to the LAN	44
Connecting to a USB	44
Daisy chain displays	45

8 Setting up the display for music, videos, and photos	46
Network status	48
Connecting USB storage devices	48
Browsing files	50
Supported file format	51
Playing videos	52
Viewing photos	55
Listening to music	57
Using PIP/PBP	59
9 Troubleshooting	61
10 Specifications	63
42-inch models	63
Dimensions	65
47-inch models	66
Dimensions	68
Recognizing preset display resolutions	69
DTV mode	70
IR codes	70
11 Agency regulatory notices	72
Federal Communications Commission notice	72
Modifications	72
Cables	72
Declaration of Conformity for products marked with the FCC logo (United States only)	72
Canadian notice	73
Avis Canadien	73
European Union regulatory notice	73
German ergonomics notice	74
Japanese notice	74
Korean notice	74
Power cord set requirements	74
Japanese power cord requirements	74
Product environmental notices	75
Materials disposal	75
Disposal of waste equipment by users in private households in the European Union	75
Chemical substances	75
HP recycling program	75
Restriction of Hazardous Substances (RoHS)	75

Turkey EEE regulation	76
Ukraine Restriction of Hazardous Substances	76

12 Controlling multiple products 77

Connecting the cable	77
RS-232C configurations	77
Communication parameter	78
Command reference list	78
Transmission / Receiving protocol	80
Transmission	80
Acknowledgement	80
01. Power (Command: k a)	80
02. Input Select (Command: x b)	81
03. Aspect Ratio (Command: k c)	81
04. Energy Saving (Command: j q)	82
05. Picture Mode (Command: d x)	82
06. Contrast (Command: k g)	82
07. Brightness (Command: k h)	83
08. Sharpness (Command: k k)	83
09. Color (Command: k i)	83
10. Tint (Command: k j)	83
11. Color Temperature (Command: x u)	84
12. H Position (Command: f q)	84
13. V Position (Command: f r)	84
14. H Size (Command: f s)	85
15. Auto Configuration (Command: j u)	85
16. Balance (Command: k t)	85
17. Sound Mode (Command: d y)	85
18. Treble (Command: k r)	86
19. Bass (Command: k s)	86
20. Speaker (Command: d v)	86
21. Volume Mute (Command: k e)	86
22. Volume Control (Command: k f)	87
23. Time 1 (Year/ Month/ Day) (Command: f a)	87
24. Time 2 (Hour/ Minute/ Second) (Command: f x)	87
25. Off Timer (Repeat Mode/ Time) (Command: f e)	88
26. On Timer (Repeat Mode/ Time) (Command: f d)	89
27. On Timer Input (Command: f u)	91
28. Sleep Time (Command: f f)	92
29. Power On Delay (Command: f h)	92
30. Automatic Standby (Command: m n)	92

31. Auto Off (Command: f g)	93
32. Language (Command: f i)	93
33. ISM mode (Command: j p)	94
34. Auto-Switch Input Select (Command: m i)	94
35. Auto-Switch Input Select (Command: m j)	94
36. Reset (Command: f k)	95
37. Tile Mode (Command: d d)	95
38. Tile Mode Check (Command: d z)	95
39. Tile ID (Command: d i)	96
40. Tile H Position (Command: d e)	96
41. Tile V Position (Command: d f)	96
42. Tile H Size (Command: d g)	97
43. Tile V Size (Command: d h)	97
44. Natural Mode (In Tile Mode) (Command : d j)	97
45. DPM Select (Command: f j)	98
46. Temperature Value (Command: d n)	98
47. Remote Controller Lock/ Key Lock (Command: k m)	98
48. Key (Command: m c)	99
49. OSD Select (Command: k l)	99
50. Elapsed time return (Command: d l)	99
51. Serial No.Check (Command: f y)	99
52. S/W Version (Command: f z)	100
53. White Balance Red Gain (Command: j m)	100
54. White Balance Green Gain (Command: j n)	100
55. White Balance Blue Gain (Command: j o)	100
56. Backlight (Command: m g)	101

1 Product features

HP Digital Signage models

The HP LCD digital signage displays have a wide-aspect active matrix thin-film transistor (TFT) panel. The displays features include the following:

- HP LD4235 model, 106.7 cm (42-inch diagonal) widescreen viewable area display with 1920 x 1080 native resolution
- HP LD4735 model, 119.28 cm (47-inch diagonal) widescreen viewable area display with 1920 x 1080 native resolution
- Viewing angles of 178 degrees horizontal, 178 degrees vertical
- VGA, HDMI, DisplayPort, VOE, USB, IR, and audio inputs
- VGA, DisplayPort, and speaker outputs
- RS232, LAN, and IR external controls
- External speaker option audio support
- USB built-in player, Network utility software, video daisy-chaining using DP and VGA, group IR for tiling (daisy-chain via RS232); Video-over-Ethernet (VOE)
- Support VESA compliant mounting interface:
 - HP LD4235: 200 x 200 mm (7.87 x 7.87 in) hole pattern
 - HP LD4735: 400 x 400 mm (15.75 x 15.75 in) hole pattern
- Network Sign Manager (NSM) software utility provided that allows remote, centralized management and control of HP digital signage displays. Users have the ability to monitor and send commands to all the network connected displays in a subnet from a central location such as a data center. For more information, see the *HP Network Sign Manager User Guide* provided with the display.
- HP Video Over Ethernet (VOE) compatibility that provides a system of software, hardware, and firmware for connecting HP Digital Signage Displays on a network with computers/media players on the same network. For more information, see the *HP Video Over Ethernet User Guide* provided with the display.

Accessories

- Software and documentation disc
- Remote control (includes AAA batteries)
- Power cord
- DisplayPort cable
- HDMI cable
- RGB (VGA) cable
- IR receiver

Optional accessories

Optional accessories (purchased separately) might vary depending on the model.

- Stand kit
- Speaker kit
- Wall mount kit

2 Safety and maintenance guidelines

Important safety information

A power cord is included with the display. If another cord is used, use only a power source and connection appropriate for this display.

 **WARNING!** To reduce the risk of electric shock or damage to the equipment:

- Do not disable the power cord grounding feature. The grounding plug is an important safety feature.
- Plug the power cord in a grounded (earthed) outlet that is easily accessible at all times.
- Disconnect power from the product by unplugging the power cord from the electrical outlet.

For your safety, do not place anything on power cords or cables. Arrange them so that no one can accidentally step on or trip over them. Do not pull on a cord or cable. When unplugging from the electrical outlet, grasp the cord by the plug.

To reduce the risk of serious injury, read the *Safety and Comfort Guide*. It describes proper workstation, setup, posture, and health and work habits for computer users, and provides important electrical and mechanical safety information. This guide is located on the Web at www.hp.com/ergo and/or on the documentation disc, if one is included with the display.

 **CAUTION:** For the protection of the display, as well as the media player/computer, connect all power cords for the media player/computer and its peripheral devices (such as a display, printer, scanner) to some form of surge protection device such as a power strip or Uninterruptible Power Supply (UPS). Not all power strips provide surge protection; the power strips must be specifically labeled as having this ability. Use a power strip whose manufacturer offers a Damage Replacement Policy so you can replace the equipment, if surge protection fails.

Use the appropriate and correctly sized furniture designed to properly support your display.

 **WARNING!** Displays that are inappropriately situated on dressers, bookcases, shelves, desks, speakers, chests, or carts can fall over and cause personal injury.

Care should be taken to route all cords and cables connected to the display so that they cannot be pulled, grabbed, or tripped over.

 **CAUTION:** Do not place the device in a location where water may drip and/or splash on the device.

Do not place an object that contains water, such as a flower vase, on the device.

Maintenance guidelines

To enhance the performance and extend the life of the display:

- Do not open the display cabinet or attempt to service this product yourself. Adjust only those controls that are covered in the operating instructions. If the display is not operating properly or has been dropped or damaged, contact an authorized HP dealer, reseller, or service provider.
- Use only a power source and connection appropriate for this display, as indicated on the label/back plate of the display.
- Be sure the total ampere rating of the products connected to the outlet does not exceed the current rating of the electrical outlet, and the total ampere rating of the products connected to the cord does

not exceed the rating of the cord. Look on the power label to determine the ampere rating (AMPS or A) for each device.

- Install the display near an outlet that you can easily reach. Disconnect the display by grasping the plug firmly and pulling it from the outlet. Never disconnect the display by pulling the cord.
- Turn the display off when not in use. You can substantially increase the life expectancy of the display by using a screen saver program and turning off the display when not in use.

⚠ CAUTION: Burn-in or image sticking might occur on displays which display the same static image on the screen for prolonged periods of time. To avoid burn-in or image sticking and to prolong the life of the display, you should activate one of the four ISM selections in the OSD, activate a screen-saver application, periodically cycle between static information and moving images, or turn off the display when it is not in use for prolonged periods of time.

- Slots and openings in the cabinet are provided for ventilation. These openings must not be blocked or covered. Never push objects of any kind into cabinet slots or other openings.
- Do not drop the display or place it on an unstable surface.
- Do not allow anything to rest on the power cord. Do not walk on the cord.
- Keep the display in a well-ventilated area, away from excessive light, heat or moisture.
- When removing the display base, you must lay the display face down on a soft area to prevent it from getting scratched, defaced, or broken.

Cleaning the display

1. Turn off the display and unplug the power cord from the back of the unit.
2. Dust the display by wiping the screen and the cabinet with a soft, clean antistatic cloth.
3. For more difficult cleaning situations, use a 50/50 mix of water and Isopropyl alcohol.

⚠ CAUTION: Spray the cleaner onto a cloth and use the damp cloth to gently wipe the screen surface. Never spray the cleaner directly on the screen surface. It might seep behind the bezel and damage the electronics.

CAUTION: To clean the display screen or cabinet, do not use cleaners that contain any petroleum-based materials such as benzene or thinner or any volatile substance. These chemicals might damage the display.

3 Assembling and preparing

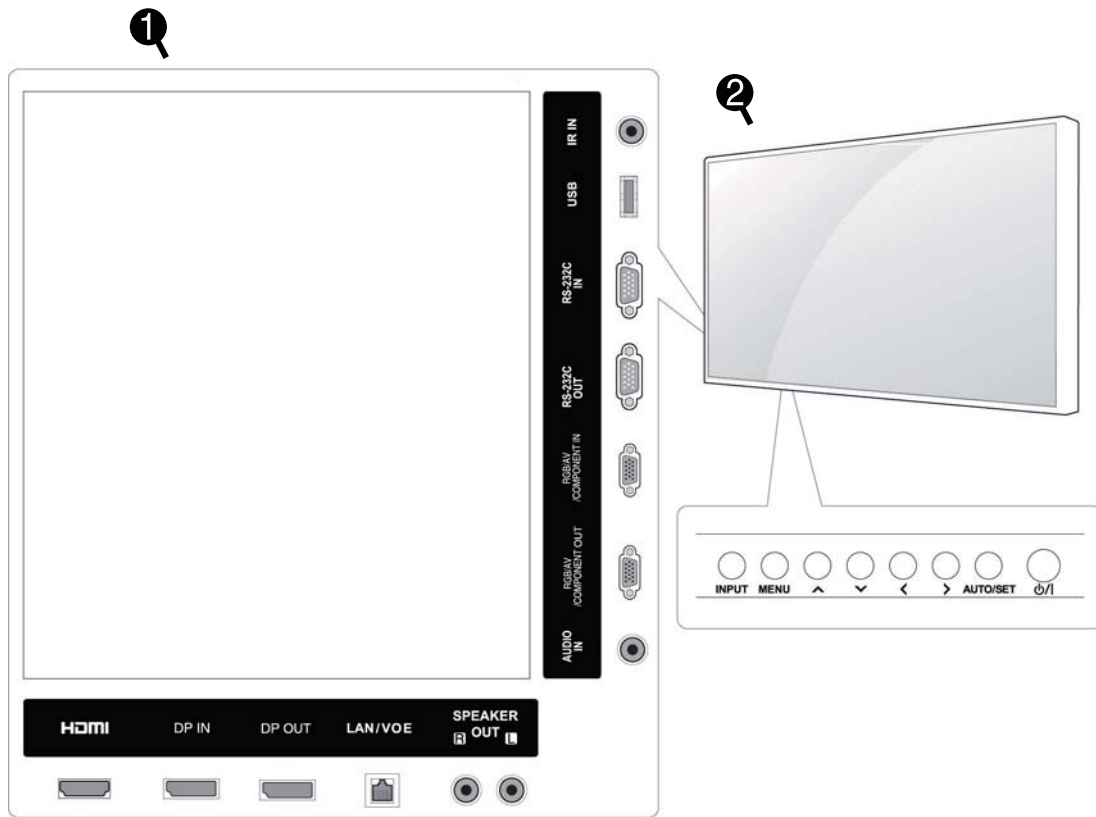

Item	Connection panel	Description
(1)	HDMI	Connects voice or audio input cable.
	DP IN	Connects DisplayPort in cable to the display.
	DP OUT	Connects DisplayPort out cable to the display.
	LAN/VOE	Connects a local area network cable.
	SPEAKER OUT	Connects optional external speakers to the display.
	AUDIO IN	Connects an audio cable to the display.
	RGB/AV COMPONENT OUT	Connects an RGB/AV component out cable to the display.
	RGB/AV COMPONENT IN	Connects an RGB/AV component in cable to the display.
	RS-232C OUT	Connects an RS-232C out cable to the display.
	RS-232C IN	Connects an RS-232C in cable to the display.
	USB	Connects a USB cable to the display.
	IR IN	Connects an IR cable to the display.

Item	Screen marks	Description
(2)	INPUT	Changes the input source.
	MENU	Accesses the main menus, or saves your input and exits the menus.
	▲▼	Moves the selection up and down.
	<>	Adjusts the volume level.
	AUTO/SET	Displays the current signal and mode. Press this button to adjust the screen automatically (RGB mode only).
	⏻/I	Turns the power on or off.

Using the IR receiver

This allows a remote control sensor to be placed in a custom location.

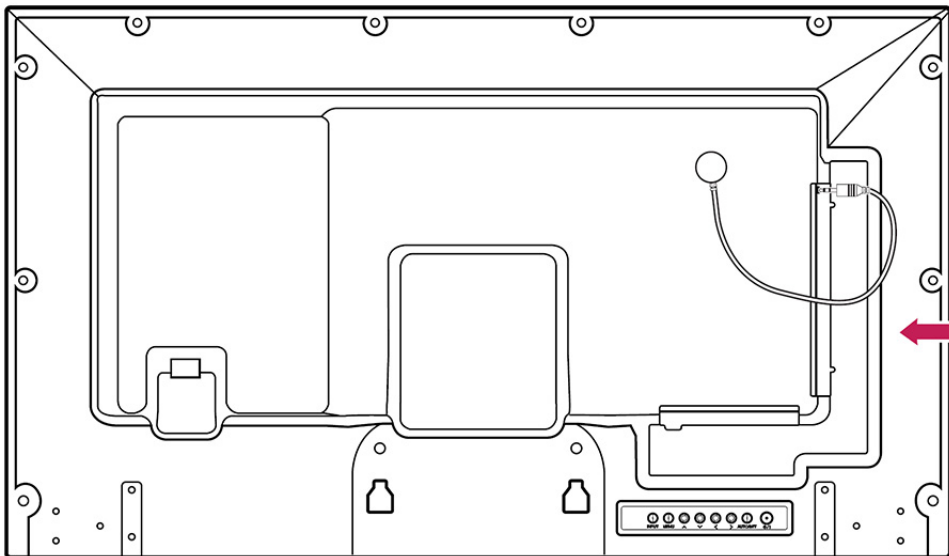

NOTE: The IR receiver is made with a magnet. If it is attached to the side or the bottom of the product, external shocks may cause the IR receiver to fall. It is recommended to attach it to the back of the product.

Portrait layout

To install in portrait orientation, rotate the display counterclockwise 90 degrees when looking at it from the front.

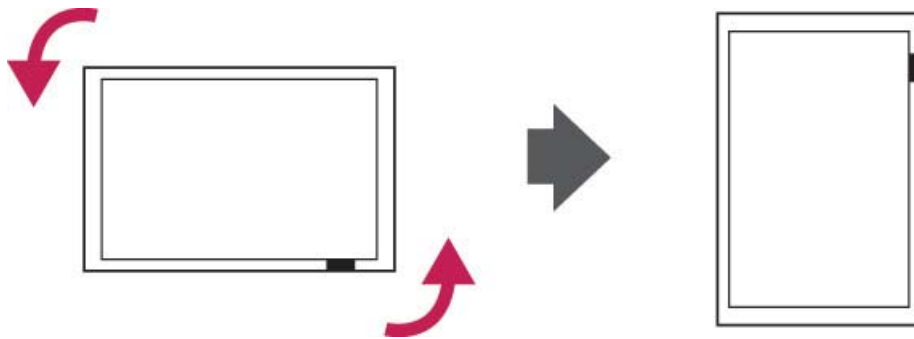

Using the security system

The security system connector is located at the back of the display.

Connect the security system cable between the display and a table.



 **NOTE:** The security system is separately purchased. You can obtain additional accessories from most electronics stores.

Mounting on a wall

For proper ventilation, allow a clearance of 10 cm on each side and from the wall. Detailed installation instructions are available from the manufacturer of the mounting equipment..

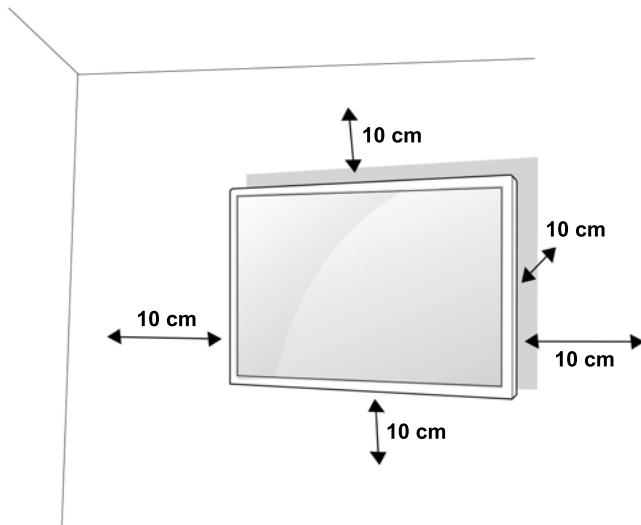

If you intend to mount the display to a wall, attach a wall mounting interface (optional parts) to the back of the set.

When you install the display using a wall mounting interface (optional parts), attach it carefully so it will not fall.

1. Use a wall mount and screws in accordance with VESA Standards.

If you use screws longer than the VESA standard, the display might be damaged internally.

If you use improper screws, the product might be damaged and drop from mounted position. In this case, HP is not responsible for damage.

2. Use VESA standard as follows:
 - 785 mm (31 inch) or greater
 - Fastening screw: Diameter 6.0 mm x Pitch 1.0 mm x Length 10 mm

CAUTION: Disconnect the power cord first, and then move or install the display. Otherwise electric shock may occur.

If you install the display on a ceiling or slanted wall, it may fall and result in severe injury.

Use an authorized HP wall mount and contact the local dealer or qualified personnel.

Do not over tighten the screws as this may cause damage to the display and void your warranty.

Use the screws and wall mounts that meet the VESA standard. Any damages or injuries by misuse or using an improper accessory are not covered by the warranty.

NOTE: The wall mount bracket is optional. You can obtain additional accessories from your local dealer.

The length of screws may differ depending on the wall mount. Be sure to use the proper length.

For more information, refer to the manufacturer's instructions supplied with the wall mount.

Securing the product to a wall (optional)

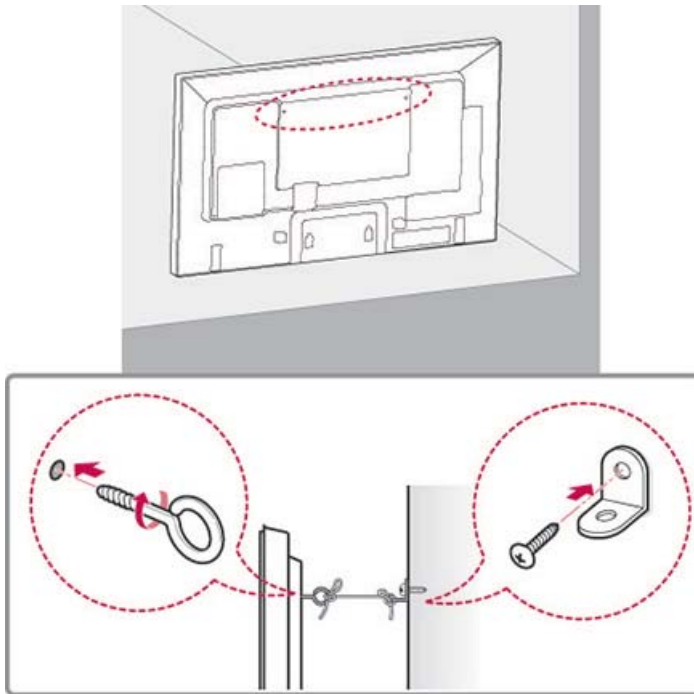

1. Insert and tighten eye-bolts or product brackets and bolts on the back of the product. If there are bolts inserted at the eye-bolts position, remove the bolts first.

 **NOTE:** Eye-bolts or wall brackets are not included with the display.

2. Mount the wall brackets with the bolts to the wall. Match the location of the wall bracket and the eye-bolts on the rear of the product.
3. Connect the eye-bolts and wall brackets tightly with a sturdy rope. Make sure to keep the rope horizontal with the flat surface.

 **CAUTION:** Make sure that children do not climb on or hang on the product.

 **NOTE:** Use a platform or cabinet that is strong and large enough to support the product securely.

Brackets, bolts and ropes are optional. You can obtain additional accessories from your local dealer.

 **WARNING!** If a product is not positioned in a sufficiently stable location, it can be potentially hazardous due to falling. Many injuries, particularly to children, can be avoided by taking simple precautions such as:

- Using cabinets or stands recommended by the manufacturer of the product.
- Only using furniture that can safely support the product.
- Ensuring the product is not overhanging the edge of the supporting furniture.
- Not placing the product on tall furniture (for example, cupboards or bookcases) without anchoring both the furniture and the product to a suitable support.
- Not standing the product on cloth or other materials placed between the product and supporting furniture.
- Educating children about the dangers of climbing on furniture to reach the product or its controls.

4 Remote control

The remote control ships with batteries.

To replace batteries, open the battery cover, replace batteries (1.5 V AAA) matching (+) and (-) ends to the label inside the compartment, and close the battery cover. To remove the batteries, perform the installation actions in reverse.

⚠ CAUTION: Do not mix old and new batteries, as this may damage the remote control.

Make sure to point the remote control to the remote control sensor on the display.

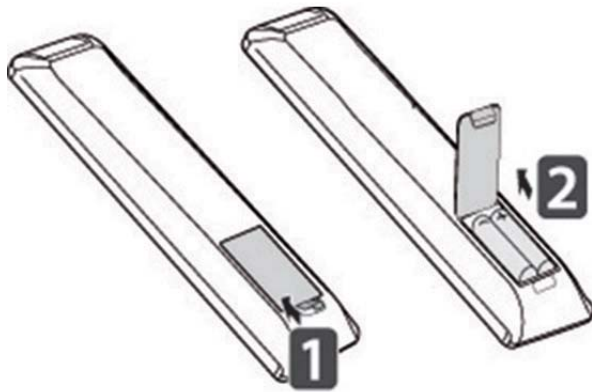

Remote control buttons

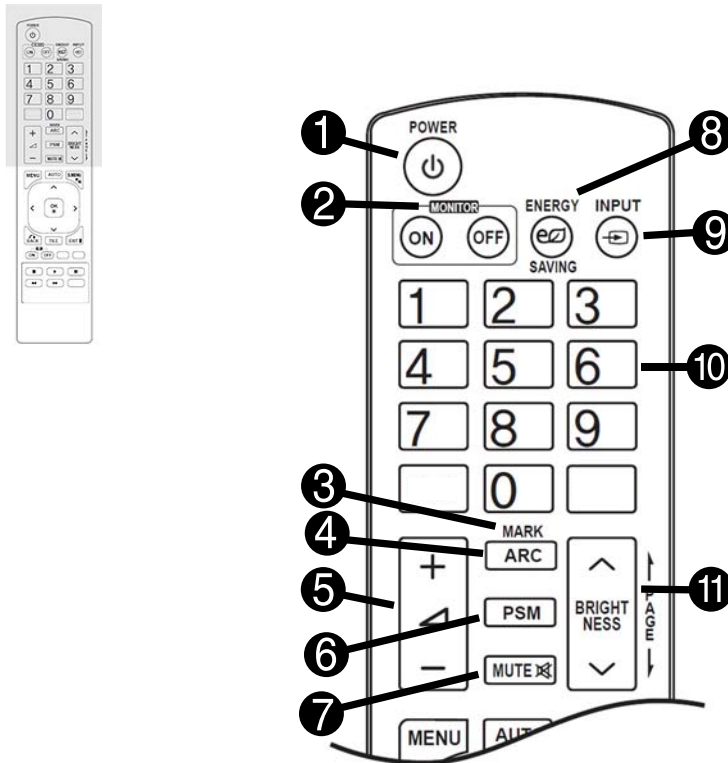

Item	Button	Function	Item	Button	Function
(1)	Power	Turns the display on or off.	(7)	MUTE	Mutes all sound.
(2)	MONITOR ON/OFF	Turns off the display then turns it back on.	(8)	ENERGY SAVING	Adjusts the brightness on the screen to reduce energy consumption.
(3)	MARK	Selects a specific file in USB mode.	(9)	INPUT	Selects Input mode.
(4)	ARC	Selects the aspect ratio.	(10)	Number and alphabet buttons	Enters numerical or alphabetical characters depending on the setting.
(5)	Volume up/down	Adjusts the volume level.	(11)	BRIGHTNESS key	Adjust the brightness by pressing the Up and Down buttons on the remote control. In USB mode, the OSD menu has the Page function to move to the next file list.
(6)	PSM	Selects Picture Status Mode.			

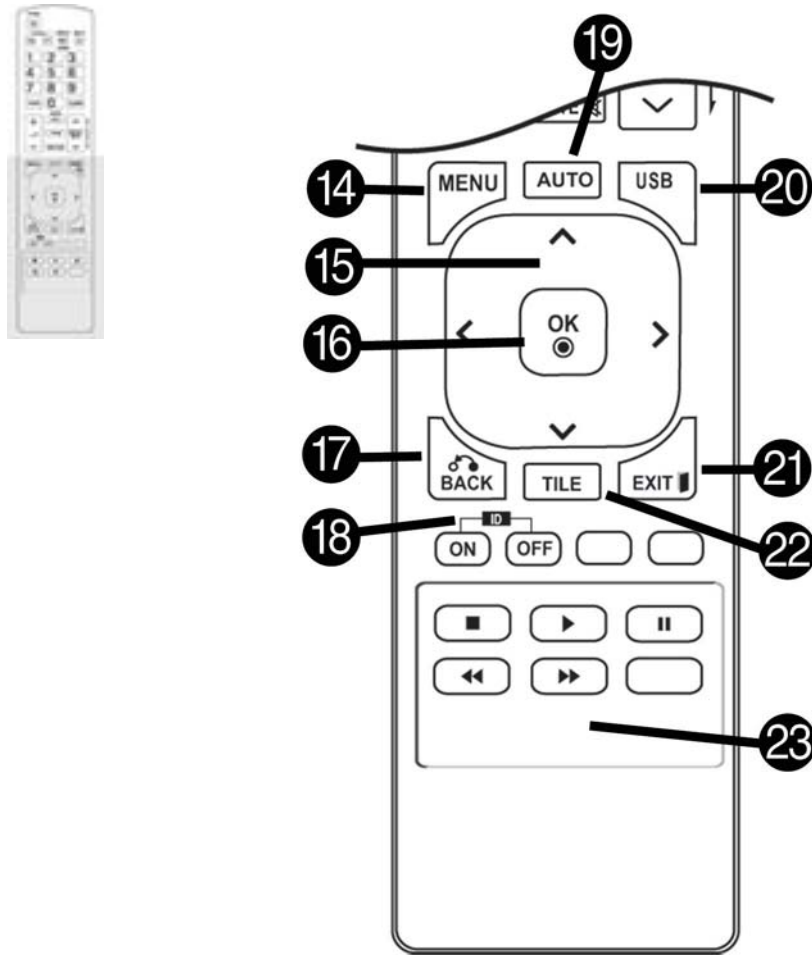

Item	Button	Function	Item	Button	Function
(14)	MENU	Accesses the main menus or saves your input and exits menus.	(19)	AUTO	Automatically adjusts picture position and minimizes image instability (RGB input only).
(15)	Navigation buttons	Scrolls through menus or options.	(20)	USB	Selects USB menu to control the HP Media Sign Player.
(16)	OK	Selects menus or options and confirms your input.	(21)	EXIT	Clears all on-screen displays and returns to display viewing from any menu.
(17)	BACK	Allows the user to move back one step in user interaction function.	(22)	TILE	Selects Tile mode.
(18)	ID ON/OFF	When the number of Picture ID is equal to Set ID, you can control the display you want in multi display mode.	(23)	USB Menu control buttons	Control media playback.

5 Using the display

Connecting to a Digital Signage media player or computer

Your display supports the Plug and Play feature. In Plug and Play, a computer will have a built-in driver for the display, no extra software is needed.



NOTE: It is recommended you use a DisplayPort connection for the best image quality.

Use a shielded signal interface cable, such as D-sub 15 pin signal cable and HDMI cable, with a ferrite core to maintain standard compliance for the product.

If you turn the display on when the set is cold, the screen may flicker. This is normal.

Some red, green, or blue spots may appear on the screen. This is normal.

If you use a cable longer than the D-sub 15 pin signal cable provided, certain images may appear blurry.



Connect the signal input cable and tighten it by turning the screws clockwise.



CAUTION: Do not press the screen with your finger for a long time as this may result in temporary distortion on the screen.

Avoid displaying a fixed image on the screen for a long period of time to prevent image burn. Use a screen saver if possible.

RGB/VGA connection

Transmits an analog video signal from your computer to the display. Connect the computer and the display with a standard RGB/VGA cable as shown in the following illustration. Select RGB/VGA IN connector on display. The audio in cable is not provided with display.

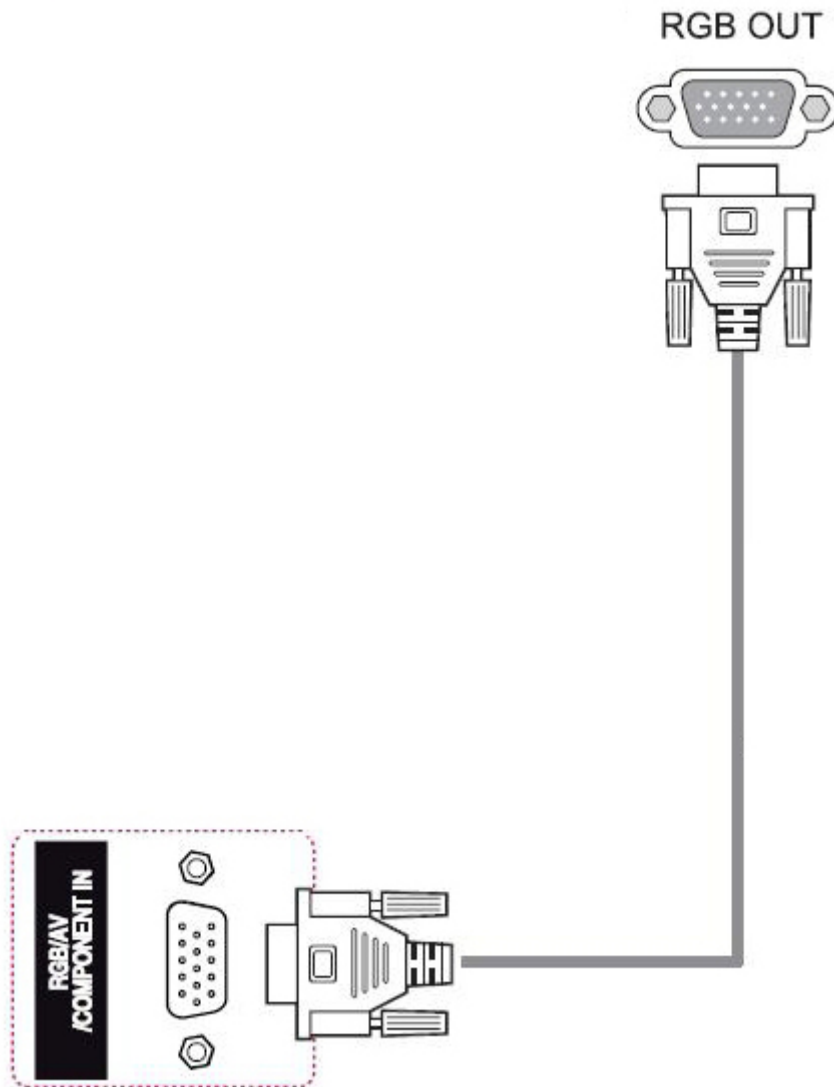

If you will be connecting this display to another display via RGB/VGA (daisy chain), plug one end of a second RGB/VGA cable into the Output RGB/VGA connector on the display and plug the other end of RGB/VGA cable into the Input RGB/VGA connector on the next display in chain. RGB/VGA connection can have multiple displays (up to 6) connected to a single player/computer using the tile mode. For more information, see [Connecting multiple displays to one player on page 19](#).

DisplayPort connection

Transmits digital video signal from your computer to the display. Connect the computer and the display with a DisplayPort cable as shown the following illustration. Select Display IN. The audio in cable is not provided with the display.

If you will be connecting this display to another display via DisplayPort (daisy chain), plug one end of a second DisplayPort cable into the DP-OUT connector on the display and plug the other end of DisplayPort cable into the DP-IN connector on the next display in chain. For more information, see [Connecting multiple displays to one player on page 19](#).

Back of the product

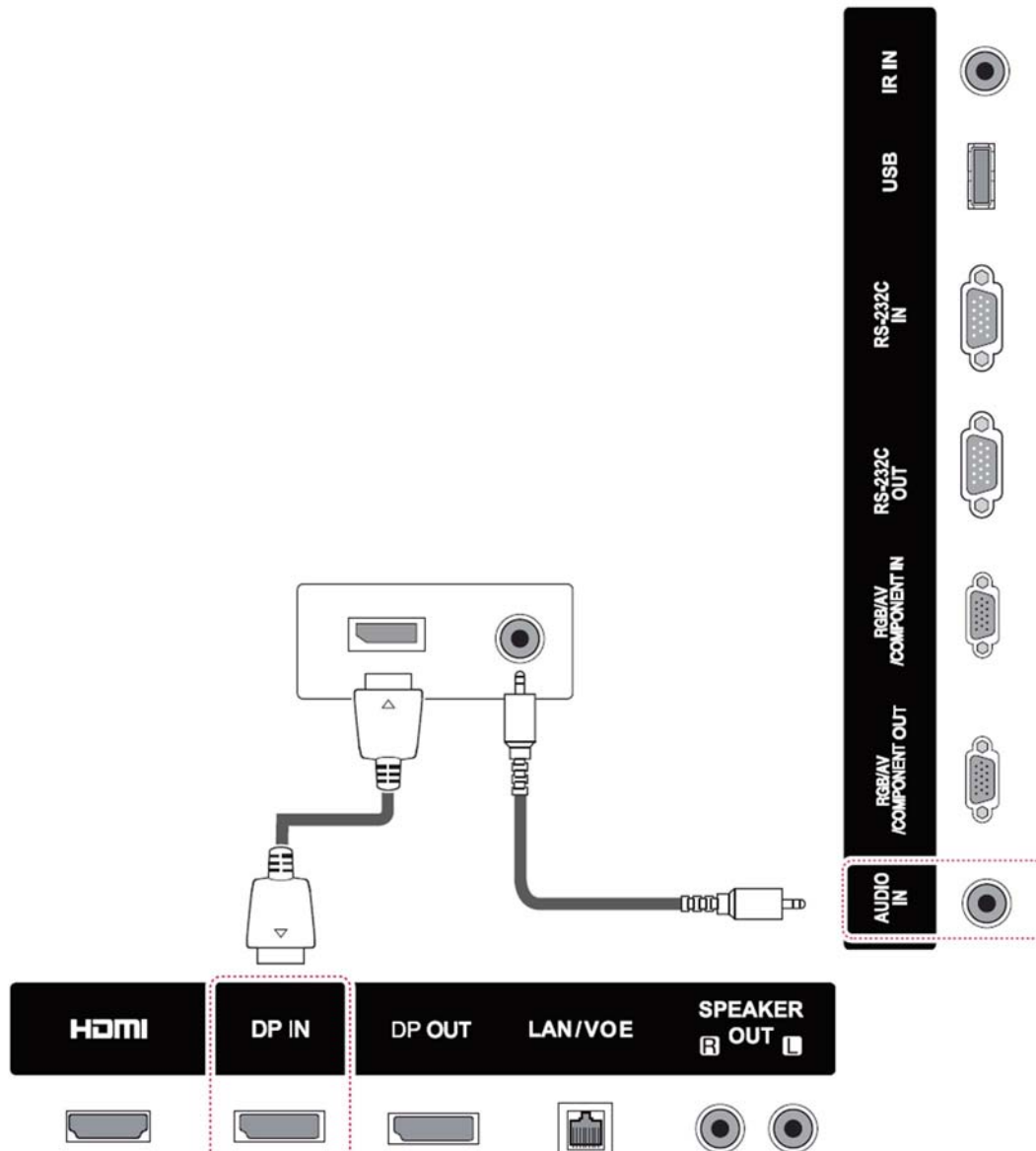

HDMI connection

Transmits the digital video and audio signals from your computer to the display. Connect the computer and the display with an HDMI cable as shown in the following illustration. Select HDMI input.

Back of the product

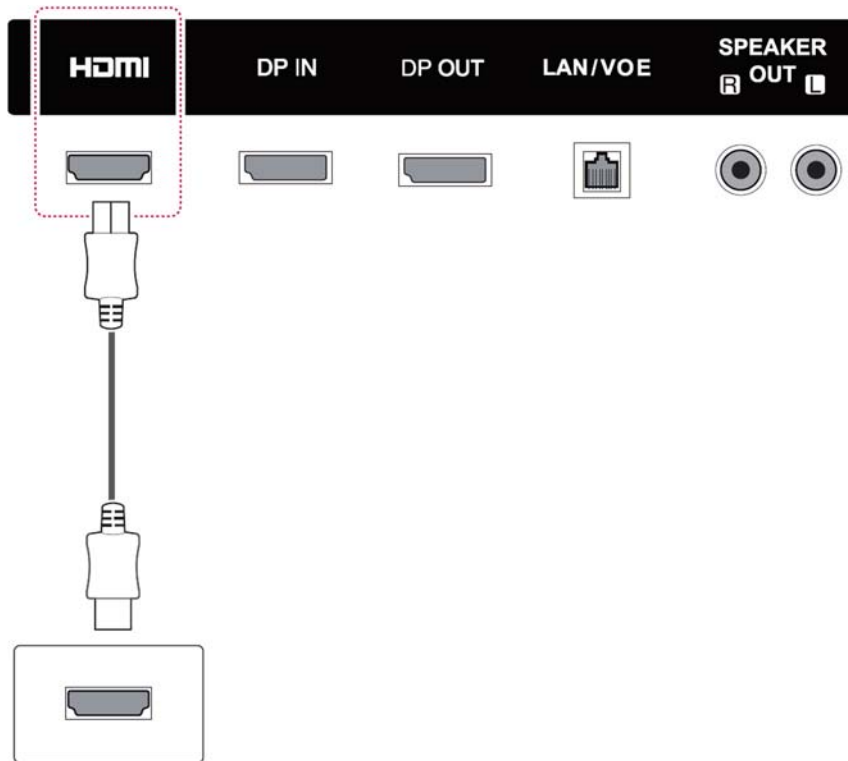

NOTE: Use a high Speed HDMI cable. High speed HDMI cables can handle definition beyond 1080p.

Check the computer environment if you cannot hear audio in HDMI mode. Some computers require you to manually change the default audio output to HDMI.

If you want to use HDMI-PC mode, you must set the input label to PC mode.

When HDMI PC is used, a compatibility problem might occur.

IR receiver connection

Allows the use of a wired remote or IR receiver extension. The IR cable is provided with the display.

Back of the product

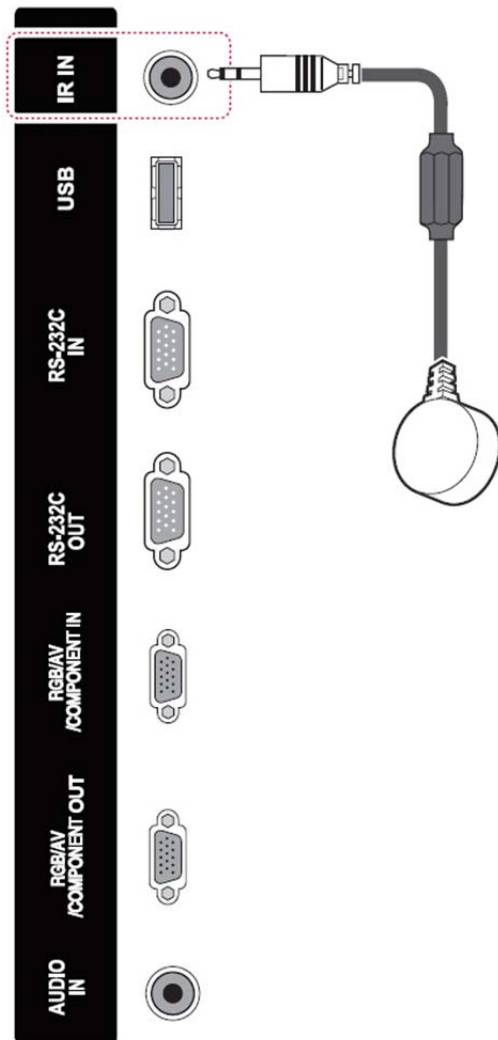

 **NOTE:** Make sure the power cable is disconnected.

LAN/VOE connection

Connecting the display using LAN/VOE

- ▲ To connect the display to a network, plug your CAT-5 network cable into the Ethernet port.



The Ethernet cable from the display can connect to a media player/computer, a router (switch), or an Intranet. A network connection enables the use of the Video Over Ethernet software to assign a media player to drive the display. The connection also allows the HP Network Sign Manager program, running on a networked media player/computer, to send command data.

Connect the Ethernet cable using one of the following connections:

- **Computer Direct Connection**—Connect the LAN cable to the LAN port on the display and to the LAN port on the media player/computer (1).
- **Router**—Connect the LAN cable to the LAN port on the display and to a LAN port on the router (2).
- **Intranet**—Connect the LAN cable to the LAN port on the display and to the Intranet network via an access point (3).

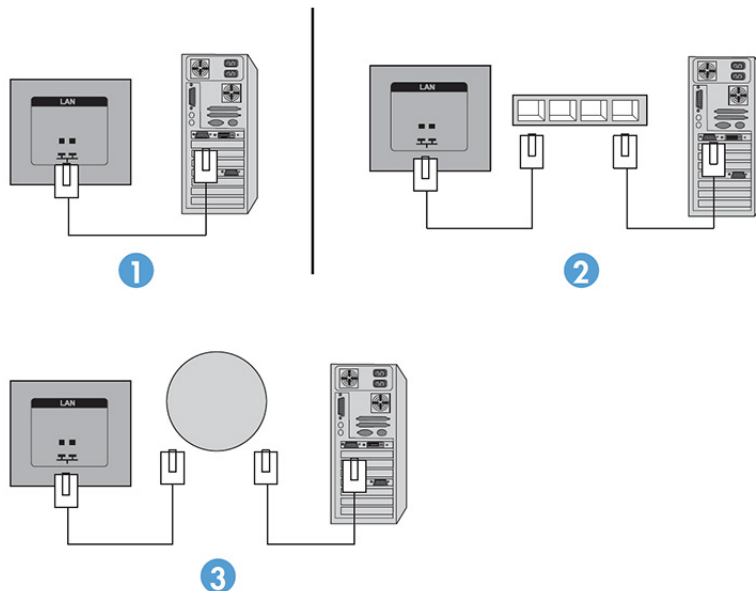

Connecting multiple displays to one player

Multiple displays may be connected to a single media player/computer two different ways, using Video Over Ethernet or using Tile Mode with VGA or DisplayPort video inputs.

Connecting multiple displays with Video Over Ethernet (VOE)

To connect multiple displays to a single media player/computer, each display must be connected to the same sub-network as the media player/computer. The input source of each display must be set to VOE. With VOE, displays are connected to media players/computer by establishing an association between the media player/computer and one or more displays on the network with the VOE software that runs in the media player/computer. Up to 12 displays may be associated with a single media player/computer (See the *VOE Users Guide* provided with the display for more detail). When multiple displays are associated with a single media player/computer, the displays may be mirrored (a single desktop image displays on all the displays simultaneously).



The image may be extended across all the displays simultaneously using the View Span “Display Resolution” dialog box.

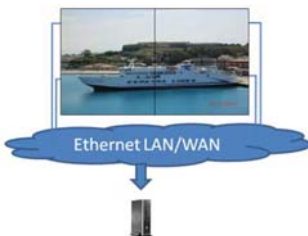

The displays may be treated by an application as though there were up to 12 individual displays connected to 12 graphic adaptor heads on the media player/computer.



The association of up to 12 displays is the technical limit, and depending upon the complexity of the desktop image to be displayed (playing flash, or streaming video), the number of displays which can be associated with acceptable video performance may be less than 12 (See the *Video Over Ethernet User Guide* for more detail).

Connecting multiple displays with Tile Mode

The recommended cable routing for daisy chain in Tile Mode is to start with the upper left display and connect across the upper tier of displays going from left to right to the last display in that tier. Then cable from the upper right display to the display just below it and connect across from right to left to the last display on the left. Continue this back and forth, top to bottom cable route for all the tiers in the wall as indicated in the next figure.

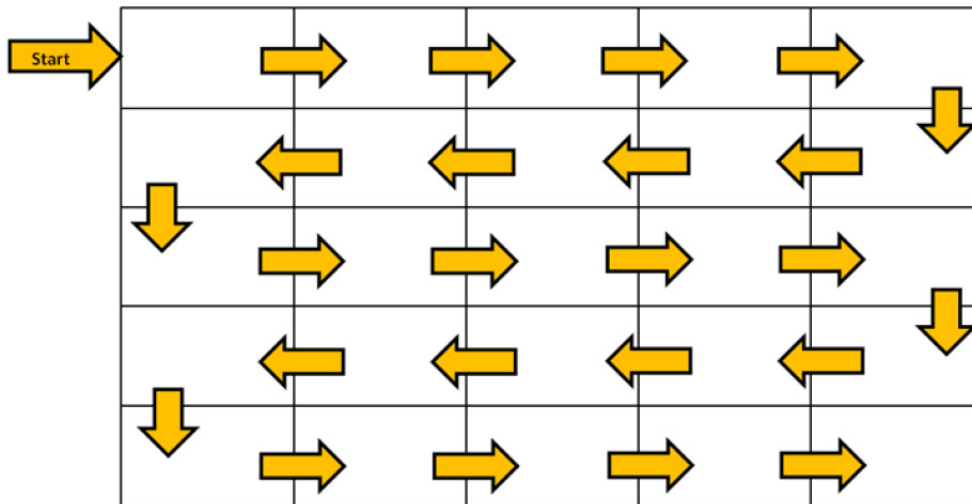

Multiple displays (up to 25 for DP and 6 for RGB/VGA) may be connected to a single media player/computer using Tile Mode. Multiple displays in Tile Mode are only supported with either DisplayPort or VGA video input sources. When connecting the multiple displays, the media player/computer is connected to the first display only with either a DisplayPort or VGA connection. All the subsequent displays are connected to each other via daisy chain using either the DP OUT connector from one display to the DP IN connector of the next display, or using the VGA OUT connector from one display to the VGA IN connector of the next display. All displays must be connected with the same video source, either DisplayPort or VGA. When using Tile mode to connect multiple displays, only one desktop image may be displayed across all the tiled displays.



To remotely manage and control multiple displays in Tile Mode when using either VGA or DisplayPort video source, either a RS-232 or Network connection may be used with the HP Network Sign Manager.

If using the RS-232 interface, the displays must be daisy chained with RS-232 cables. Attach one end of a RS-232 cable to the RS-232 Input connector of the first display and connect to the serial connector of the media player/computer. Then attach one end of an RS-232 cable to the RS-232 Output connector and the other end to the RS-232 Input connector of the next display and continue to connect the RS-232 cables between each display in the tiled matrix.

If using a Network connection, just attach each display to a network hub or access point using a CAT-5 cable, and HP Network Sign Manager will locate each network attached display. The HP Network Sign Manager will allow users to select any display or assigned group of displays to manage and control. If the display is already attached to the network for VOE, there is no further action required. The HP Network Sign Manager will detect the displays via its search function (See the *HP Network Sign Manager Users Guide* provided with the display for more details).

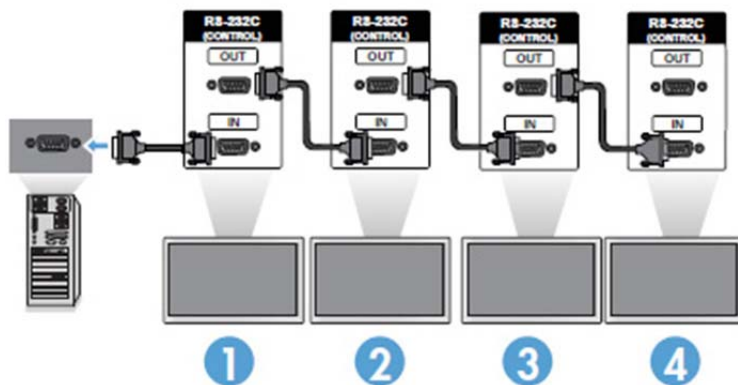

Multiple displays may also be controlled and managed with the IR Remote Control.

NOTE: The number of displays that can be connected by daisy chain to one media player/computer might vary depending on the signal status and cable loss. If the signal status is good, and there is no cable loss, it is possible to connect up to 25 displays for DP and 12 displays for RGB/VGA in a daisy chain from one media player/computer.

If you are going to play video that is copy protected with High-bandwidth Digital Content Protection (HDCP), you must use DisplayPort as the video source, and you are limited to a maximum of six displays in the daisy chain which can support HDCP.

When using Tile Mode, the display ID can be set in the display OSD with the IR Remote Control, the display control panel, or for Network attached displays, the display ID can be set with the HP Network Sign Manager software (See the *HP Network Sign Manager User Guide* provided with the display for more details).

Adjusting the screen

Selecting an image mode

Display images in its optimized settings by selecting one of the preset image modes.

1. Press **MENU** to access the main menus.
2. Press the Navigation buttons to scroll to **PICTURE** and press **OK**.
3. Press the Navigation buttons to scroll to **Picture Mode** and press **OK**.
4. Press the Navigation buttons to scroll to an image mode you want and press **OK**.

Option	Description
Vivid	Adjusts the video image by enhancing the contrast, brightness, Color, and sharpness.
Standard	Adjusts the image for the normal environment.
Cinema	Optimizes the video image for a cinematic look to enjoy videos.
Sport	Optimizes the video image for high and dynamic actions by emphasizing primary Colors such as white, grass, or sky blue.
Game	Optimizes the video image to enjoy dynamic image when playing a game.

5. When you are finished, press **EXIT**. When you return to the previous menu, press **BACK**.

Customizing image options

Customize basic and advanced options of each image mode for the best screen performance.

1. Press **MENU** to access the main menus.
2. Press the Navigation buttons to scroll to **PICTURE** and press **OK**.
3. Press the Navigation buttons to scroll to **Picture Mode** and press **OK**.
4. Press the Navigation buttons to scroll to an image mode you want and press **OK**.
5. Select and adjust the following options, and then press **OK**.

Option	Description
Backlight	Adjusts the brightness of the screen by controlling the LED backlight. If you decrease the brightness level, the screen becomes darker and the power consumption will be reduced without any video signal loss.
Contrast	Increases or decreases the gradient of the video signal. You may use Contrast when the bright part of the picture is saturated.
Brightness	Adjusts the base level of the signal in the picture. You may use Brightness when the dark part of the picture is saturated.
Sharpness	Adjusts the level of crispness in the edges between the light and dark areas of the picture. The lower the level, the softer the image.
Color	Adjusts intensity of all colors.
Tint	Adjusts the balance between red and green levels.
Color temp.	Set to warm to enhance hotter Colors such as red, or set to cool to make picture bluish.

Advanced Control	Customizes the advanced options.
Picture Reset	Restores the options to the default setting.

- When you are finished, press **EXIT**. When you return to the previous menu, press **BACK**.

Customizing computer display options

Customize options of each image mode for the best image quality.

This function works in the following mode: RGB[PC] mode.

- Press **MENU** to access the main menus.
- Press the Navigation buttons to scroll to **PICTURE** and press **OK**.
- Press the Navigation buttons to scroll to **Screen** and press **OK**.
- Select and adjust following options, and then press **OK**.

Option	Description
Resolution	Selects a proper resolution. See Customizing settings on page 28 .
Auto Config.	Sets to adjust the screen position, clock, and phase automatically. The displayed image may be unstable for a few seconds while the configuration is in progress.
Position/ Size/Phase	Adjusts the options when the picture is not clear, especially when characters are shaky, after the auto configuration.
Reset	Restores the options to the default setting.

- When you are finished, press **EXIT**. When you return to the previous menu, press **BACK**.

Adjusting sound

Selecting a sound mode

Play the sound in its optimized settings by selecting one of the preset sound modes.

- Press **MENU** to access the main menus.
- Press the Navigation buttons to scroll to **AUDIO** and press **OK**.
- Press the Navigation buttons to scroll to **Sound Mode** and press **OK**.
- Press the Navigation buttons to scroll to an image mode you want and press **OK**.

Mode	Description
Standard	Select when you want standard quality sound.
Music	Select when you listen to music.
Cinema	Select when you watch videos.
Sport	Select when you watch sports events.
Game	Select when you want to enjoy dynamic sound when playing a game.

- When you are finished, press **EXIT**. When you return to the previous menu, press **BACK**.

Customizing sound options

Customize options of each sound mode for the best sound quality.

1. Press **MENU** to access the main menus.
2. Press the Navigation buttons to scroll to **AUDIO** and press **OK**.
3. Press the Navigation buttons to scroll to **Sound Mode** and press **OK**.
4. Press the Navigation buttons to scroll to an image mode you want and press **OK**.
5. Select and adjust following options, and then press **OK**.

Option	Description
Infinite sound	Provides 5.1 channel stereo sound from two speakers.
Treble	Controls the dominant sounds in the output. When you turn up the treble, it will increase the output to the higher frequency range.
Bass	Makes the output sound softer. If the bass is increased, the frequency of the output also increases.
Reset	Resets the sound mode to the default setting.

6. When you are finished, press **EXIT**. When you return to the previous menu, press **BACK**.

Using additional options

Using the input list

Selecting an input source

1. Press **INPUT** to access the input source list.
2. Press the Navigation buttons to scroll to one of the input sources and press **OK**.

Input Source	Description
AV	Watch the contents in a DVD or other external devices, or through a digital set-top box.
Component	Watch the contents in a DVD or other external devices, or through a digital set-top box.
RGB	View a computer display on the screen.
HDMI	Watch contents in a computer, DVD, or digital set-top box or other high definition devices.
DisplayPort	Watch contents in a computer, DVD or digital set-top box other high definition devices.
VOE	Watch contents through the Ethernet port.
USB	Plays the multimedia files saved in the USB.

Adjusting aspect ratio

 **CAUTION:** All models are not suitable for applications that exhibit static, stationary, or fixed images. Static images may cause image retention damage that may appear as stains or watermarks on the screen. The warranty does not cover displays that are in use for applications that exhibit static, stationary, or fixed images for long periods or for 24-hours per day that result in image retention damage. To avoid image retention damage, turn off the display when it is not in use or use a power management setting, if supported by your system, to turn off the display when the system is idle.

 **NOTE:** You can also change the image size by accessing the main menus.

Just Scan mode operates when a video signal has resolution of 720p or higher.

MODE	Component	RGB PC	DisplayPort		HDMI	
			DTV	PC	DTV	PC
ARC						
16:9	0	0	0	0	0	0
Just Scan	0	X	0	X	0	X
1:1	X	0	X	0	X	0
4:3	0	0	0	0	0	0
Zoom	0	X	0	X	0	X
Cinema Zoom	0	X	0	X	0	X

16:9 : This selection will allow you to adjust the picture horizontally, in linear proportion, to fill the entire screen (useful for viewing 4:3 formatted DVDs).

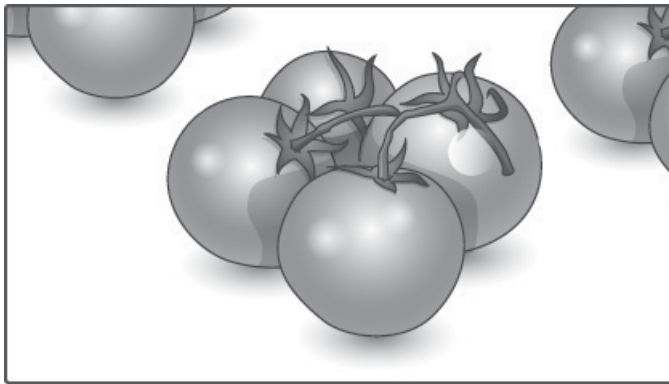

Just Scan : This Selection will allow you to view the best quality picture without loss of the original picture in high resolution image.

 **NOTE:** If there is noise in original picture, you can see the noise at the edge.

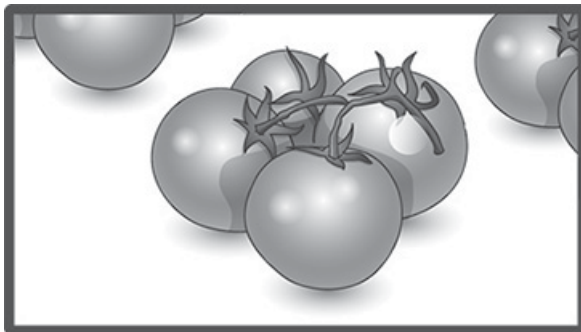

1:1 : The aspect ratio is not adjusted from the original. (Only Display Port PC, HDMI PC, RGB PC)

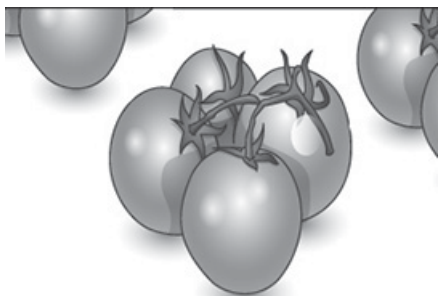

4:3 : This selection will allow you to view a picture with an original 4:3 aspect ratio, black bars will appear on both the left and right of the screen.

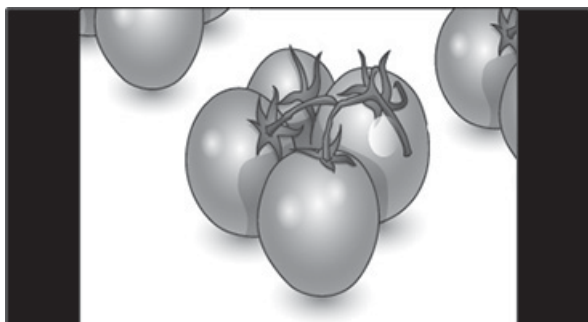

Zoom : This selection will allow you to view the picture without any alteration, while filling the entire screen. However, the top and bottom of the picture will be cropped.

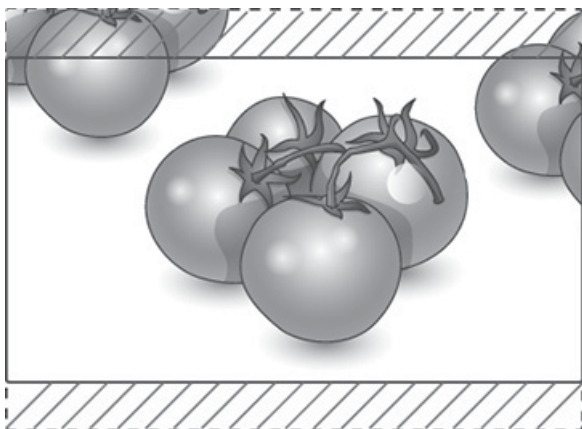

Cinema Zoom : Choose Cinema Zoom when you want to enlarge the picture in correct proportion.
Note: When enlarging or reducing the picture, the image may become distorted.

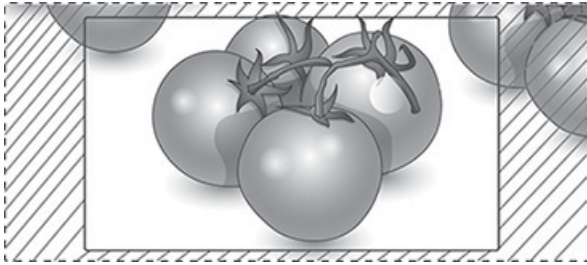

6 Customizing settings

Accessing main menus

1. Press **MENU** to access the main menus.
2. Press the Navigation buttons to scroll to one of the following menus and press **OK**.
3. Press the Navigation buttons to scroll to the setting or option you want and press **OK**.
4. When you are finished, press **EXIT**. When you return to the previous menu, press **BACK**.

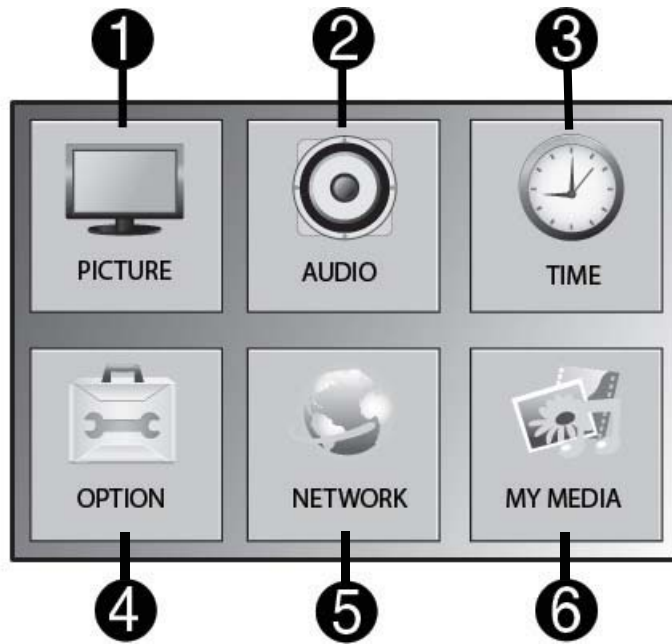

Item	Function	Description
(1)	PICTURE	Adjusts the image size, quality, or effect
(2)	AUDIO	Adjusts the sound quality, effect, or volume level.
(3)	TIME	Sets the time, date, or Timer feature.
(4)	OPTION	Customizes the general settings
(5)	NETWORK	Sets up the network.
(6)	MY MEDIA	Display and play video, photo and music content stored on your USB.

PICTURE settings

1. Press **MENU** to access the main menus.
2. Press the Navigation buttons to scroll to **PICTURE** and press **OK**.
3. Press the Navigation buttons to scroll to the setting or option you want and press **OK**.
4. When you are finished, press **EXIT**. When you return to the previous menu, press **BACK**.

Setting	Description
Aspect Ratio	Changes the image size to view images at its optimal size.
Energy Saving	Sets to automatically adjust the screen brightness corresponding to the surroundings. Level Off: Disables Energy Saving function. Minimum/Medium/Maximum: Selects the brightness level of the LED backlight. Screen Off: The screen turns off in 3 seconds.
Smart Energy Saving	Adjusts the LED backlight and contrast depending on the screen brightness. Level Off: Disables the Smart Energy Saving function. On: Enables the Smart Energy Saving function to save power consumption as much as the value set in the smart energy saving rate.
Picture Mode	Selects one of the preset image modes or customizes options in each mode for the best display screen performance. You are also able to customize advanced options of each mode. The available preset picture modes vary depending on the display. Mode Vivid: Adjusts the video image by enhancing the contrast, brightness, Color, and sharpness. Standard: Adjusts the image for the normal environment. Cinema: Optimizes the video image for a cinematic look to enjoy videos. Sport: Optimizes the video image for high and dynamic actions by emphasizing primary Colors such as white, grass, or sky blue. Game: Optimizes the video image for a fast gaming screen such as computers or games.
SCREEN (In RGB Mode Only)	Customizes the computer display options in RGB mode. Option Resolution: Selects a proper resolution. See Customizing settings on page 28 . Auto Configure: Sets to adjust the screen position, clock, and phase automatically. The displayed image may be unstable for a few seconds while the configuration is in progress. Position/Size/Phase: Adjusts the options when the picture is not clear, especially when characters are shaky, after the auto configuration. Reset: Restores the options to the default setting.

Picture Mode options

Setting	Description
Backlight	Adjusts the brightness of the screen by controlling the LED backlight. If you decrease the brightness level, the screen becomes darker and the power consumption will be reduced without any video signal loss.
Contrast	Increases or decreases the gradient of the video signal. You may use Contrast when the bright part of the picture is saturated.
Brightness	Adjusts the base level of the signal in the picture. You may use Brightness when the dark part of the picture is saturated.
Sharpness	Adjusts the level of crispness in the edges between the light and dark areas of the picture. The lower the level, the softer the image.
Color	Adjusts intensity of all colors.
Tint	Adjusts the balance between red and green levels.
Color Temp	Set to warm to enhance hotter Colors such as red, or set to cool to make picture bluish.
Advanced Control	Customizes the advanced options. Refer to the Advanced image options.
Picture Reset	Restores the options to the default setting.



NOTE: If the **Picture Mode** setting in the Picture menu is set to Vivid, Standard, Cinema, Sport or Game the subsequent menus will be automatically set.

You cannot adjust color and tint in the RGB/ HDMI-PC/ DisplayPort PC mode.

When using the Smart Energy Saving function, the screen may look saturated in the white area of a still image.

If Energy Saving is set to Minimum, Medium, or Maximum, the Smart Energy Saving function is disabled.

Advanced control

Setting	Description
Dynamic Contrast (Off/High/ Medium/ Low)	Adjusts the contrast to keep it at the best level according to the brightness of the screen. The picture is improved by making bright parts brighter and dark parts darker. (Function works in the following mode - Component, HDMI-DTV, DisplayPort-DTV)
Dynamic Color (Off/High/Low)	Adjusts screen Colors so that they look livelier, richer and clearer. This feature enhances hue, saturation and luminance so that red, blue, green and white look more vivid. (Function works in the following mode - Component, HDMI-DTV, DisplayPort-DTV)
Clear White (Off/High/Low)	Make the white area of screen brighter and more white.
Skin Color (-5 to 5)	It detects the skin area of video and adjusts it to express a natural skin color.
Noise Reduction (Off/High/ Medium/Low)	Reduces screen noise without compromising video quality. (Function works in the following mode - Component, HDMI-DTV, DisplayPort-DTV)
Digital Noise Reduction (Off/High/ Medium/Low)	This option reduces the noise produced while creating digital video signals.
Gamma (High/Medium/ Low)	Set your own gamma value. On the display, high gamma values display whitish images and low gamma values display high contrast images.
Advanced Control	Low: The picture of the screen gets darker.

High: The picture of the screen gets brighter.

Set black level of the screen to proper level. (Function works in the following mode - Component, HDMI-DTV, DisplayPort-DTV)

AUDIO settings

1. Press **MENU** to access the main menus.
2. Press the Navigation buttons to scroll to **AUDIO** and press **OK**.
3. Press the Navigation buttons to scroll to the setting or option you want and press **OK**.
To return to the previous level, press **BACK**.
4. When you are finished, press **EXIT**. When you return to the previous menu, press **BACK**.

The available audio settings are as follows:

Setting	Description
Clear Voice II	By differentiating the human sound range from others, it helps users listen to human voices better.
Balance	Adjusts balance between the left and right speakers according to your room environment.
Sound Mode	<p>The best sound tone quality will be selected automatically depending on the video type that you are currently watching.</p> <p>Mode</p> <p>Standard: The most commanding and natural audio.</p> <p>Music: Select this option to enjoy the original sound when listening to the music.</p> <p>Cinema: Select this option to enjoy sublime sound.</p> <p>Sport: Select this option to watch sports broadcasting.</p> <p>Game: To enjoy dynamic sound when playing a game.</p> <p>NOTE: If sound quality or volume is not at the level you want, it is recommended to use a separate home theater system or amplifier to cope with different user environments.</p> <p>Option</p> <p>Infinite Sound: Provides 5.1 channel stereo sound from two speakers.</p> <p>Treble: Controls the dominant sounds in the output. When you turn up the treble, it will increase the output to the higher frequency range.</p> <p>Bass: Makes the output sound softer. When you turn up the bass, it will increase the output to the lower Frequency.</p> <p>Reset: Resets the sound mode to the default setting.</p>
Digital Audio Input	HDMI/Display Port: Outputs the sound of digital signal from HDMI through the display speaker. Audio In: Outputs the sound through the display speaker by connecting HDMI to the Audio In port.
Speaker	<p>ON: Enables sound to the display speaker. (* The display speaker is sold separately.)</p> <p>OFF: Disables sound to the display speaker. Use this option when using an external sound device.</p>

TIME settings

1. Press **MENU** to access the main menus.
2. Press the Navigation buttons to scroll to **TIME** and press **OK**.
3. Press the Navigation buttons to scroll to the setting or option you want and press **OK**.
To return to the previous level, press **BACK**.
4. When you are finished, press **EXIT**. When you return to the previous menu, press **BACK**.

The available time settings are as follows:

Setting	Description
Clock	Sets the time feature.
On/Off Timer	Sets the time to turn on or off the display.
Sleep Timer	Sets the length of time until the display turns off. When you turn the display off and turn it on again, the Sleep Timer will be set to off.
Power On Delay	When connecting multiple displays and turning the power on, the displays are turned on individually to prevent overload.
Auto off	If Auto off is active and there is no input signal, the set switches to off mode automatically after 15 minutes.
Automatic Standby	If you do not use the display for more than 4 hours, it will be in standby mode automatically.



NOTE: Off Time/ On Time can be saved for up to seven schedules; the display is turned on or off at the preset time in the schedule list. If multiple preset times are stored in the schedule list, this function works at the nearest time from the current time.

Once the on or off time is set, these functions operate daily at the preset time.

The scheduled power-on and power-off functions work properly only when the device time is set correctly.

When the scheduled power-on and power-off times are the same, the power-off time has priority over the power-on time if the set is turned on, and vice versa if the set is turned off.

OPTION settings

1. Press **MENU** to access the main menus.
2. Press the Navigation buttons to scroll to **OPTION** and press **OK**.
3. Press the Navigation buttons to scroll to the setting or option you want and press **OK**.
To return to the previous level, press **BACK**.
4. When you are finished, press **EXIT**. When you return to the previous menu, press **BACK**.

The available option settings are as follows:

Setting	Description
Language	To choose the language in which the control names are displayed.
ISM Method	<p>A frozen or still picture from a computer/video game displayed on the screen for prolonged periods could result in a image burn remaining even when you change the image. Avoid allowing a fixed image to remain on the screen for a long period of time.</p> <p>Setting</p> <p>Normal: Leave on normal if you do not foresee image burn as being a problem.</p> <p>Orbiter: May help prevent image burn. However, it is best not to allow any fixed image to remain on the screen. To avoid a permanent image on the screen, the screen will move every 2 minutes.</p> <p>Inversion: This function inverts the panel color of the screen. The panel color is automatically inverted every 30 minutes.</p> <p>White Wash: White wash fills the screen with solid white. This helps removes permanent images burned into the screen. A permanent image may be impossible to clear entirely with white wash.</p>
DPM Select	A user can choose to turn the power saving mode on / off.
Auto-Switch Input	<p>If there is no input signal, it automatically switches to another input with signal.</p> <p>Setting</p> <p>Off: Stops auto switch of the input source.</p> <p>Auto: Switches to another input source with video signal if no video signal comes from the current input source.</p> <p>Manual: Selects the priority of input source for auto switch. When several input sources are found, the input source with a higher priority will be selected.</p>
Factory Reset	Select this option to return to the default factory settings.
Set ID	You can assign a unique Set ID NO (name assignment) to each product when several products are connected for display. Specify the number (1 to 255) using the button and exit. Use the assigned Set ID to individually control each product using the Product Control Program.
Tile Mode	<p>Tile Mode:</p> <p>To use this function:</p> <ul style="list-style-type: none"> • Must connect with multiple displays. • Must be in a function that can be connected to DisplayPort Cable and distributor. The tile mode must be set after identifying the display alignment and ID. Only after pressing the SET button the adjustments made to the settings will be saved. • Tile mode : column x row (c = 1 to 15 r = 1 to 15) • 15 x 15 available.

- Configuration define an array of displays showing a single image (up to 25 DisplayPort and 12 RGB/VGA).

Auto Config: Sets to adjust the screen position, clock, and phase automatically. The displayed image may be unstable for a few seconds while the configuration is in progress.

Position: Moving the screen position horizontally and vertically.

Size: Adjust the horizontal and vertical size of the screen taking into account the size of the bezel.

Natural: Allows the image to retain proportionality across the array by compensating for the width of the mullion (the distance between the active display area to the active display area of the adjacent display in the array).

Reset: Function to initialize and release Tile. All Tile setting are released when selecting Tile reset and the screen returns to Full screen.

PIP/PBP

Displays videos or photos stored in a USB device on a single display by dividing it into the main and sub screens.

Option

Mode: Sets the type of secondary screen.

- *OFF: Disables the secondary screen.
- *PIP (Picture In Picture): Displays the secondary screen in the main screen.
- *PBP (Picture By Picture): Displays the secondary screen next to the main screen.

Position: Adjusts the position of the sub screen (top left, bottom left, top right, bottom right) The default value is the bottom right.

Size: Adjusts the size of the sub screen (Size 0 to 10). The default size of PIP (Size: 0) is 480x270; the maximum size 10 is 960x540.

NOTE: The Position and Size options are enabled only in PIP mode.

Key Lock

Disenables or enables rear side control keys. If Key Lock is on, the display controls are disable (rear side key function).

Product/Service Info

Displays the model name, software version, serial number, IP address, MAC address and home page.

Portrait Mode

Rotate OSD clockwise (90°)

Option

90°: Rotate OSD clockwise 90°.

Tile Mode

This display can be tiled with additional displays to create a large tiled display.

- Off: When the Tile Mode option is disabled.
- 1x2: When using 2 displays.



Tile ID

- 2x2: When using 4 displays.

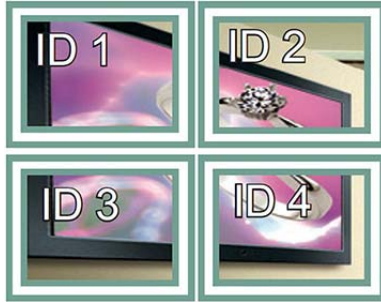

- 3x3: When using 9 displays.

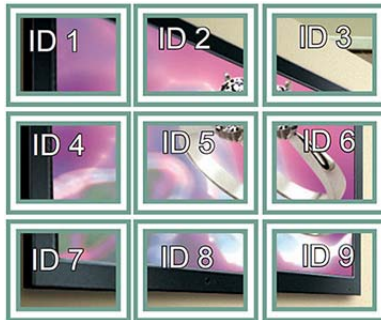

- 4x4: When using 16 displays.



- 5x5: When using 25 displays.



Tile Mode – Natural mode

When active, the part of the image that would normally be displayed in the gap between the displays is omitted.

Before



After



PIP/PBP

Displays videos or photos stored in a USB device on a single display by dividing it into the main and sub screens.

Mode

*PIP (Picture In Picture): Displays the Sub screen in the main screen.

*PBP (Picture By Picture): Displays the Sub screen next to the main screen.

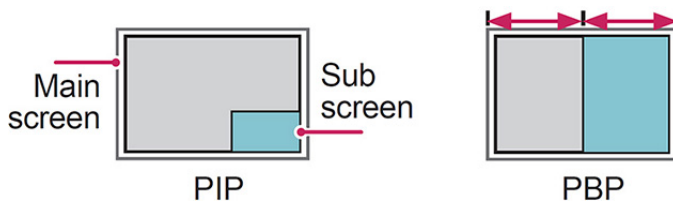

Position

Adjusts the position of the subscreen (top left, bottom left, top right, bottom right).

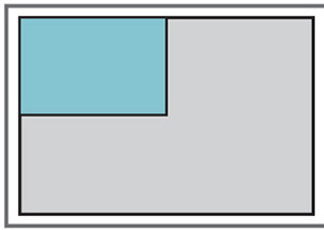

top left

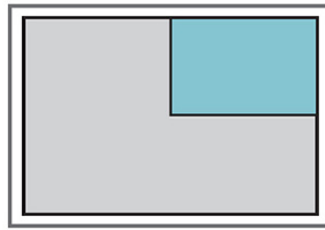

top right



bottom left



bottom right

Size

Adjusts the size of the subscreen (Size 0-10).

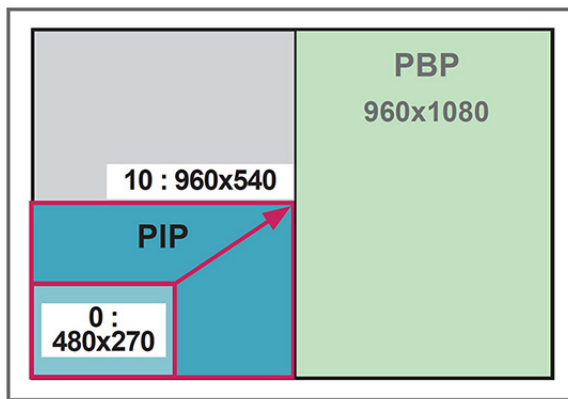

< 1920x1080 >



NOTE: The subscreen is only supported when using the USB device.

You can only change the size and position in PIP mode.

With PBP selected, the Aspect Ratio option in the PICTURE menu is disabled (Fixed as 16:9).

While running the PBP function, the Tile Mode function does not work.

You must select the output sound before running the PIP or PBP functions. (Select either Main or Sub.)

If you fail to select Main or Sub from the sound selection box, and if the OSD disappears after either a period of time or when the Exit or Back key is pressed, the PIP/PBP subscreen is not activated.

You cannot change the sound while running the PIP or PBP functions. If you want to change the sound, restart PIP/PBP.

The picture quality of the subscreen is set according to the values selected in the main menu, not the USB device.

When the power is turned off/on, the PIP/PBP mode is disabled.

If you play videos you selected in PIP/PBP mode, the videos will play back repeatedly in succession.

The buttons below work in PIP mode:

Button	Photo	Movie
<	o	x
>	o	x
▶	x	o
■	x	x
▶▶	x	o
◀◀	x	o
	x	o

Picture ID

Picture ID is used to change the settings of a specific display using a single IR receiver for multivision. Communication is possible between a set with an IR receiver and other sets using audio cables. Each set is identified by a set ID. If you assign the Picture ID using the remote control, only displays with the same Picture ID and Set ID can be controlled remotely.

1. Press the red ON button on the remote control
2. If you press the left/right buttons or press the ON button repeatedly, the Picture ID cycles through OFF and 0 to 4. Assign the ID you want.

If you assign the Set ID to each set with multi-vision, and then assign the Picture ID using the red button on the remote control, the key command is displayed for the set with the same Set ID and Picture ID. A set with different Set IDs and Picture IDs cannot be controlled by IR signals.

 **NOTE:** For example, if the Picture ID is assigned to 2, the upper right display (Set ID: 2) can be controlled by IR signals.

For each set, you can change the settings for the PICTURE, AUDIO, TIME, NETWORK and MY MEDIA menus or the hot keys on the remote control.

If you press the green OFF button for Picture IDs, the Picture IDs for all sets are turned off. If you then press any button on the remote control, all sets will start working again.

Picture ID will be disabled while using the MY MEDIA menu.

NETWORK settings

1. Press **MENU** to access the main menus.
2. Press the Navigation buttons to scroll to **NETWORK** and press **OK**.
3. Press the Navigation buttons to scroll to the setting or option you want and press **OK**.
To return to the previous level, press **BACK**.
4. When you are finished, press **EXIT**. When you return to the previous menu, press **BACK**.

The available option settings are as follows:

Setting	Description
---------	-------------

Network Setting	Configure the network settings.
Network Status	Display the network status. <ul style="list-style-type: none">• Internet is connected : Externally connected• Network is connected : Only internally connected• Not connected : When there is no network connection
VOE IP Settings	Sets the video over Ethernet IP address.
VOE Setup	These fields are recognized by the Video Over Ethernet software. <p>Display Name – Give this display a name up to 32 alphanumeric characters long for reference through the VOE software.</p> <p>Display Location – Identify this display's physical location in a way meaningful to you. Use up to 32 alphanumeric characters.</p> <p>Product Name – Automatically shows either LD4235 or LD4735.</p> <p>Player Name – The computer name of a computer/media player running VOE software whose output is to be played on this display. You can enter such a name. The VOE software will enter a name when it assigns a video source to this display.</p>

 **CAUTION:** When setting the Player Name, input delay may occur if you press the buttons on the remote control continuously.

7 Making connections

Connect various external devices to the ports on the display back panel.

1. Find an external device you want to connect to your display shown on the following illustration.
2. Check the connection type of the external device.
3. Go to the appropriate illustration and check the connection details.

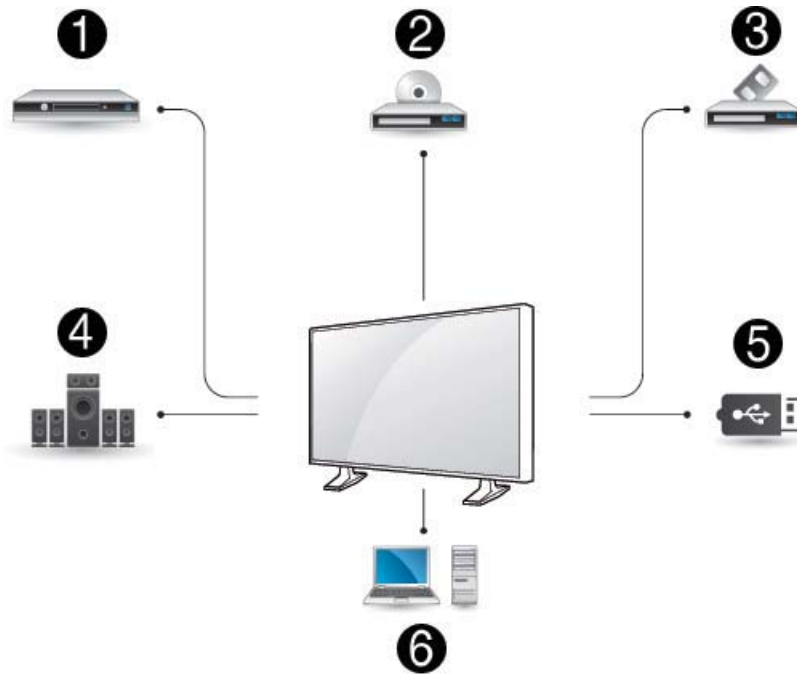

Item	Source	Reference	Item	Source	Reference
(1)	Computer	HDMI connection on page 42 DisplayPort connection on page 41 Connecting to the LAN on page 44	(4)	HD receiver	HDMI connection on page 42 DisplayPort connection on page 41 Component connection on page 43
(2)	USB	Connecting to a USB on page 44	(5)	DVD	HDMI connection on page 42 DisplayPort connection on page 41 Component connection on page 43
(3)	Speakers	Component connection on page 43	(6)	VCR	Component connection on page 43

 **NOTE:** For sound, you must connect an optional speaker.

Connecting to a Computer, HD receiver, DVD, or VCR

Connect a HD receiver, DVD, or VCR to the display and select an appropriate input mode.

DisplayPort connection

Transmits the digital video signal from an external device to the display. Connect the external device and the display with the DisplayPort cable as shown in the following illustration. To transmit an audio signal, connect an optional audio cable.

Back of the product:

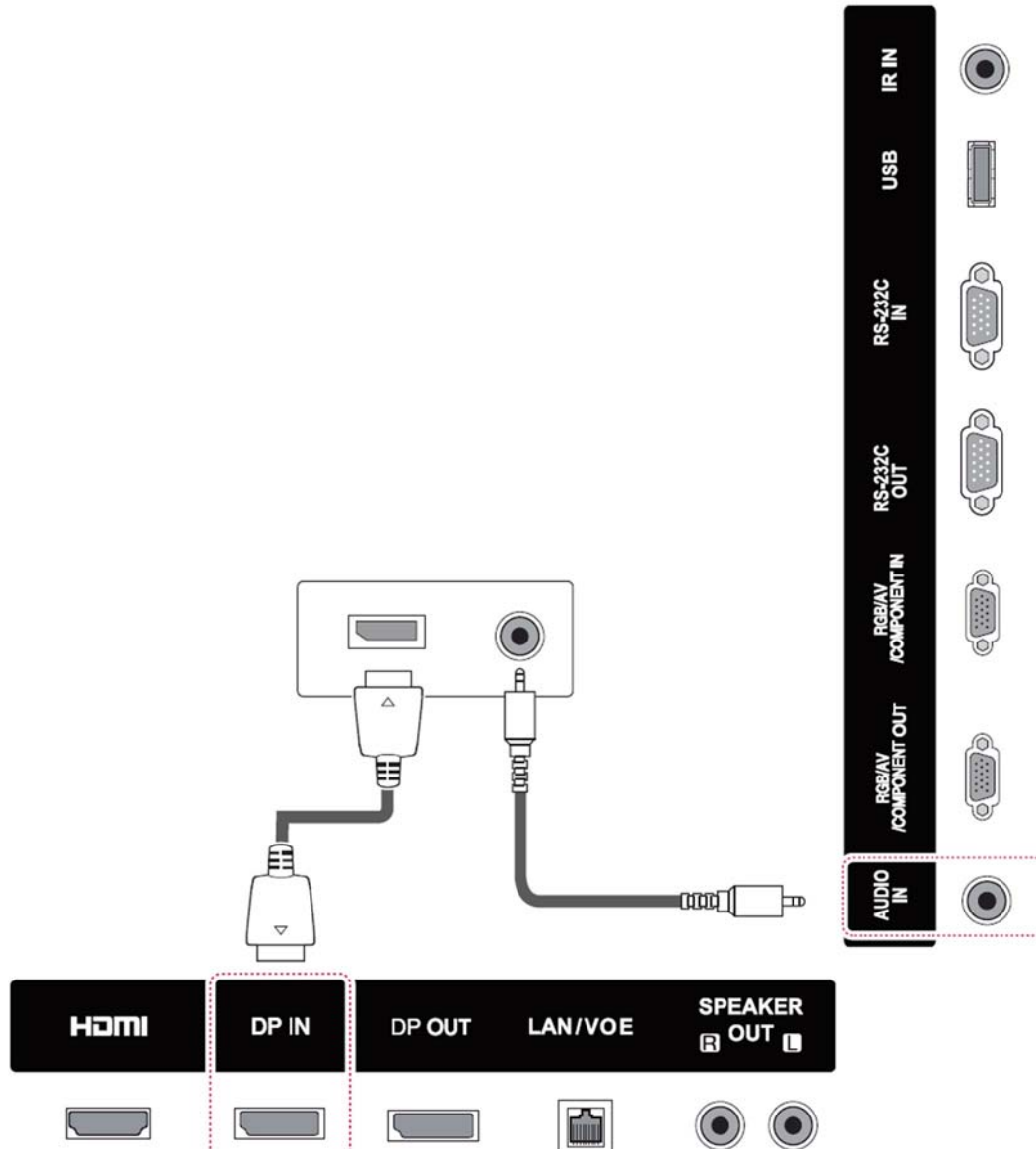

HDMI connection

Transmits the digital video and audio signals from an external device to the display. Connect the external device and the display with the HDMI cable as shown on the following illustration.

Back of the product:

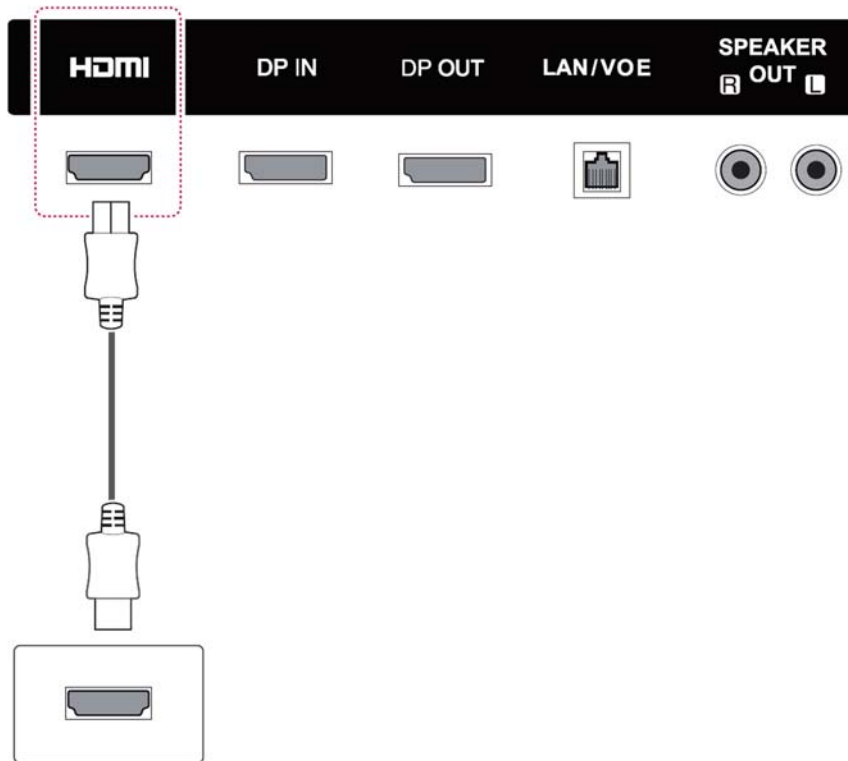

 **NOTE:** Use a High Speed HDMI Cable.

High Speed HDMI Cables are tested to carry an HD signal up to 1080p and higher.

Component connection

Transmits the analog video and audio signals from an external device to the display. Connect the external device and the display with the 15 pin signal to RCA cable as shown on the following illustration. To display images by using progressive scan, make sure to use the component cable.

The VGA/RCA cable and audio-in cable are not provided with the display.

Back of the product:

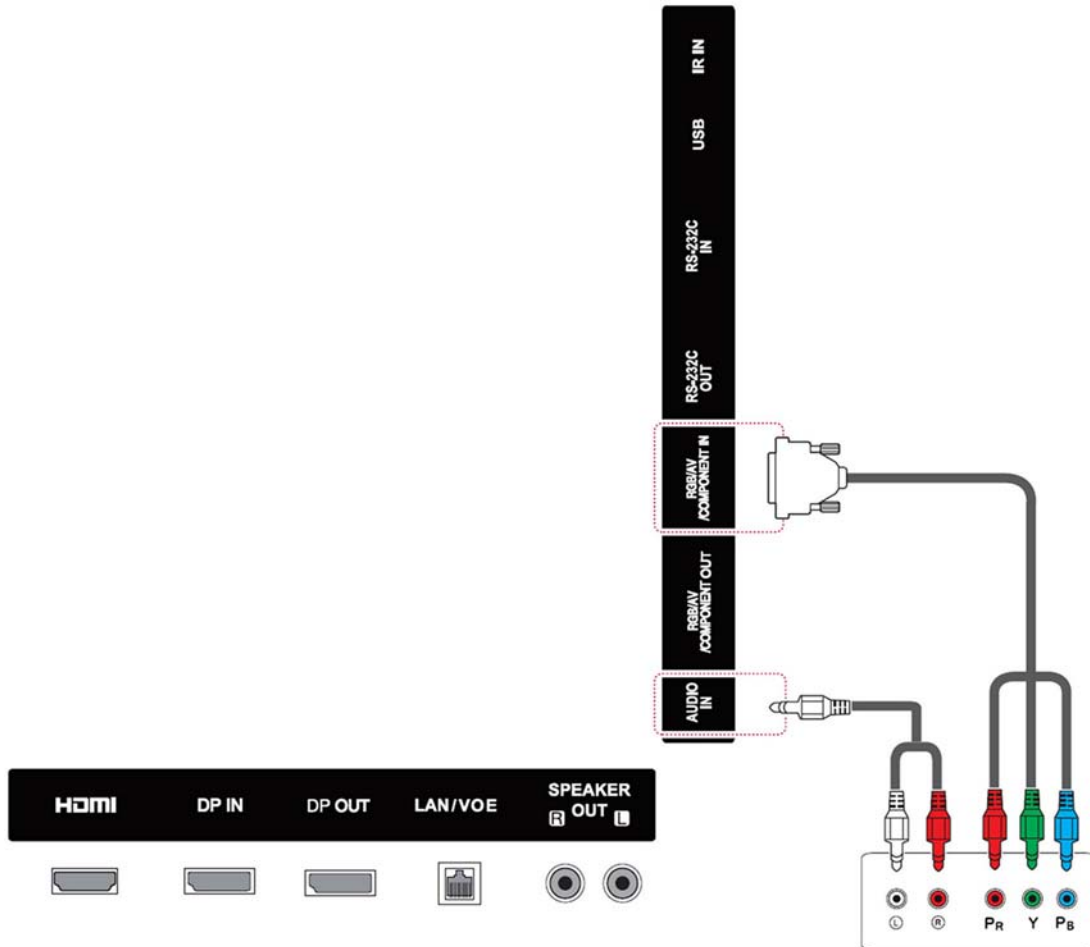

NOTE: When connecting to the Component port using the shared interface, the port must match up to the input source. Otherwise, noise may occur.

Connecting to the LAN

- a. Using a router (switch).

Connect one end of the LAN cable (1) to the display and the other end to the router (2). Connect the second LAN cable to the router (3) and the other end of the LAN cable to a computer (4).

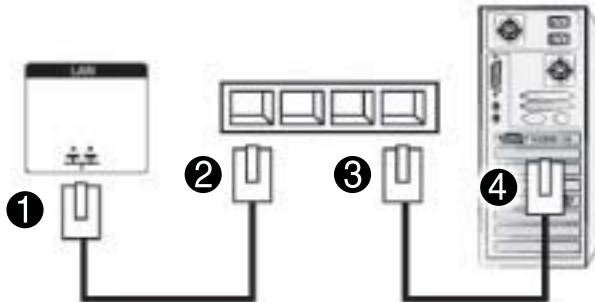

- b. Using the Internet.

Connect one end of the LAN cable (1) to the display and the other end to the network (2). Connect the second LAN cable to the network (3) and the other end of the LAN cable to a computer (4).

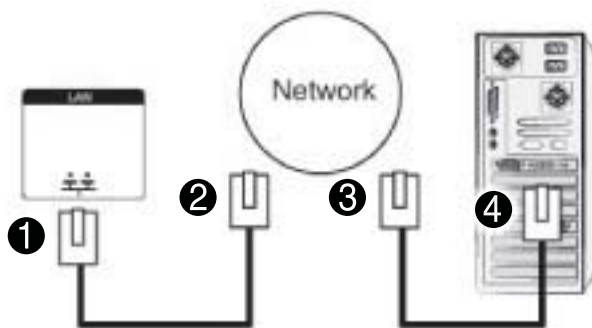

Connecting to a USB

Connect a USB storage device such as a USB flash memory, external hard drive, MP3 player or a USB memory card reader to the display and access the USB menu to use various multimedia files.

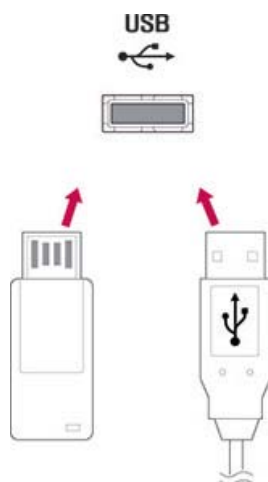

Daisy chain displays

Use this function to digital video signal from a computer on multiple displays.

1. Connect a signal input cable (DisplayPort cable) to the DP IN port of the first display.
2. Connect one end of the signal input cable to the computer.
3. Connect one end of a signal input cable to the DP OUT port of the first display and the other end to the DP IN of the second display.

DisplayPort cable

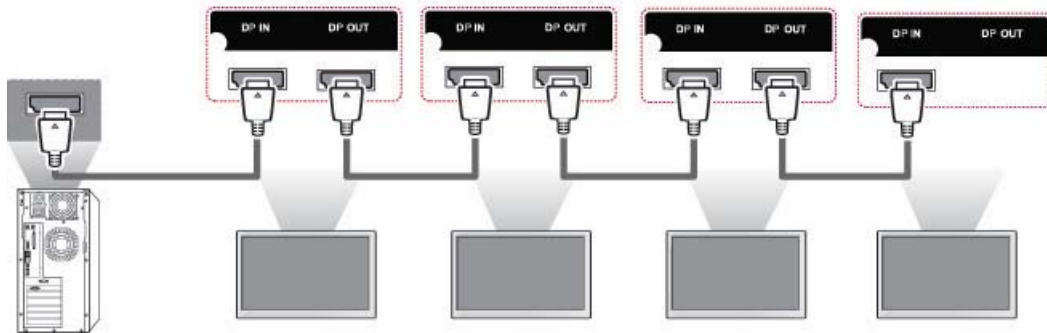

NOTE: The number of displays that can be connected to one output may vary depending on signal status and cable loss. If the signal status is good, and there is no cable loss, it is possible to connect up to 9 displays. If you want to connect more than this number of displays, it is recommended to use a distributor.

When multi-connecting in/out cascade format, no loss cables are recommended.

DP OUT does not work when connecting to a third-party product.

8 Setting up the display for music, videos, and photos

Connect the display to a local area network (LAN) via the LAN port as shown in the following illustration and set up the network settings. The display only supports wired network connection. After making a physical connection, a small number of networks may require the display network settings to be adjusted. For most networks, the display will connect automatically without any adjustments.

For detail information, check your router manual.

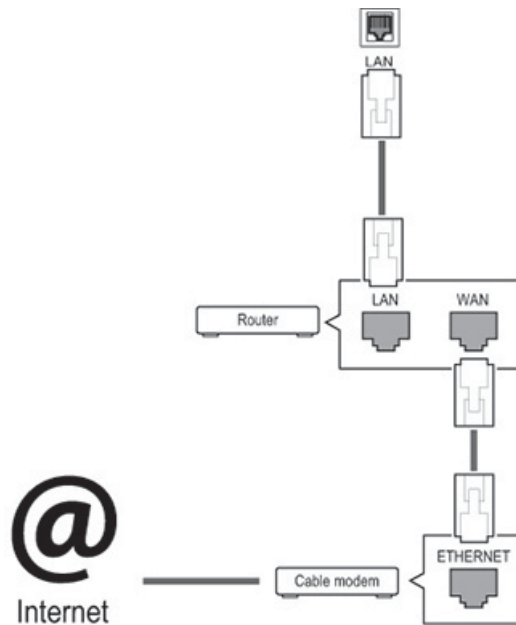

CAUTION: Do not connect a modular phone cable to the LAN port.

Since there are various connection methods, please follow the specifications of your telecommunication carrier.

To set up the network settings (if your display connected automatically, running setup again will not disrupt the connection):

1. Press **MENU** to access the main menus.
2. Press the Navigation buttons to scroll to **NETWORK** and press **OK**.
3. Press the Navigation buttons to select **Network Setting** and press **OK**.
4. If you already set Network Setting, select **Resetting**. The new connection settings resets the current network settings.
5. Select **IP Auto Setting** or **IP Manual Setting**.

- If selecting **IP Manual Setting**, press the Navigation and Number buttons. IP addresses will need to be input manually.
- **IP Auto Setting**: Select this if there is a DHCP (Dynamic Host Configuration Protocol) server (router) on the local area network (LAN) via wired connection, the display will automatically be allocated an IP address. If you're using a broadband router that has a DHCP server function, the IP address will automatically be determined.

6. When you are finished, press **EXIT**.

 **CAUTION:** The network setting menu will not be available until the display is connected to a physical network.

Since there are various connection methods, HP recommends that you follow the specifications of your telecommunication carrier.

 **NOTE:** If you want to access the Internet directly on your display, the internet connection should always be on.

If you cannot access the Internet, check the network conditions from a computer on your network.

When you use Network Setting, check the LAN cable or check if DHCP in the router is turned on.

If you do not complete the network settings, the network may not work properly.

Tips for network setting

- Use a standard LAN cable with this display. Use a Cat5 or better with a RJ45 connector.
- Many network connection problems during set up can often be fixed by resetting the router. After connecting the display to the network, quickly power off and/or disconnect the power cable of the network router. Then power on and/or connect the power cable again.
- HP is not responsible for any malfunction of the display and/or the internet connection feature due to communication errors/malfunctions associated with your internet connection, or other connected equipment.
- HP is not responsible for problems within your internet connection.
- You may experience undesired results if the network connection speed does not meet the requirements of the content being accessed.
- Some internet connection operations may not be possible due to certain restrictions associated with your Internet connection
- Any internet fees, including connection charges, without limitation, are your responsibility.
- A 10 Base-T or 100 Base-TX LAN port is required when using a wired connection to this display. If your internet service does not allow for such a connection, you will not be able to connect the display.

Network status

1. Press **MENU** to access the main menus.
2. Press the Navigation buttons to scroll to **NETWORK** and press **OK**.
3. Press the Navigation buttons to select **Network Status**.
4. Press **OK** to check the network status.
5. When you are finished, press **EXIT**.

Option	Description
Setting	Return to the network setting menu.
Test	Test the current network status after setting the network.
Close	Return to the previous menu.

Connecting USB storage devices

You can use USB flash memory devices for content playback and multimedia features in the USB built-in player.

Connect a USB flash memory or USB memory card reader to the display as shown on the following illustration. The My media screen appears.

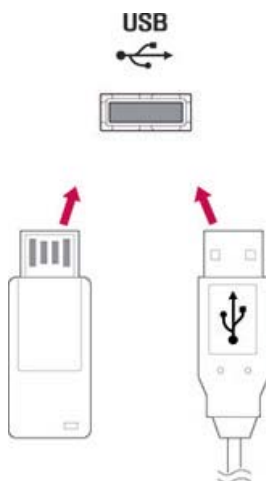

CAUTION: Do not turn the display off or remove a USB storage device while the EMF (My media) menu is activated, as this could result in loss of files or damage to the USB storage device.

Back up your files saved on a USB storage device frequently, as you may lose or damage the files and this may be not covered by the warranty.

Tips for using USB storage devices

- Only a USB storage device is recognizable.
- If the USB storage device is connected through a USB hub, the device is not recognizable.
- A USB storage device using an automatic recognition program may not be recognized.
- A USB storage device that uses its own driver will not be recognized.

- The recognition speed of a USB storage device may depend on each device.
- Do not turn off the display or unplug the USB device when the connected USB storage device is working. When such a device is suddenly separated or unplugged, the stored files or the USB storage device may be damaged.
- Only use a USB storage device that has normal music files, image files or video files.
- Use only a USB storage device that was formatted as a FAT32 file system, NTFS file system by with the Windows operating system. In case of a storage device formatted with a different utility program that is not supported by Windows, it may not be recognized.
- Connect power to a USB storage device (over 0.5 A) that requires an external power supply. If not, the device may not be recognized.
- Connect a USB storage device with the cable included by the device maker.
- Some USB storage devices may not be supported or operate smoothly.
- File alignment method of USB storage devices can recognize up to 100 English characters.
- Be sure to back up important files since data stored on a USB memory device may be damaged. We will not be responsible for any data loss.
- If the USB HDD does not have an external power source, the USB device may not be detected. So be sure to connect the external power source. Please use a power adaptor for an external power source.
- If your USB memory device has multiple partitions, or if you use a USB multi-card reader, you can use up to 4 partitions or USB memory devices.
- If a USB memory device is connected to a USB multi-card reader, its volume data may not be detected.
- If the USB memory device does not work properly, disconnect and reconnect it.
- How fast a USB memory device is detected differs from device to device.
- If the USB is connected in Standby Mode, that drive will automatically be loaded when the display is turned on.
- The recommended capacity is 1 TB or less for a USB external hard disk and 32 GB or less for USB memory.
- Any device with more than the recommended capacity may not work properly.
- If a USB external hard disk with a “Energy Saving” function does not work, turn the hard disk off and on again to make it work properly.
- USB storage devices below USB 2.0 are supported as well. But they may not work properly with videos.
- A maximum of 999 folders or files can be recognized under one folder.
- It is recommended you use a certified USB storage device and cable. Otherwise, a USB storage device may not be detected or a playback error may occur.
- A USB 3.0 storage device may not work.

Browsing files

Access the photo, music, or video lists and browse files.

1. Connect a USB storage device.
2. Press **MENU** to access the main menus.
3. Press the Navigation buttons to scroll to **My Media** and press **OK**.
4. Press the Navigation buttons to choose from **Movie List**, **Photo List**, or **Music List** and press **OK**.

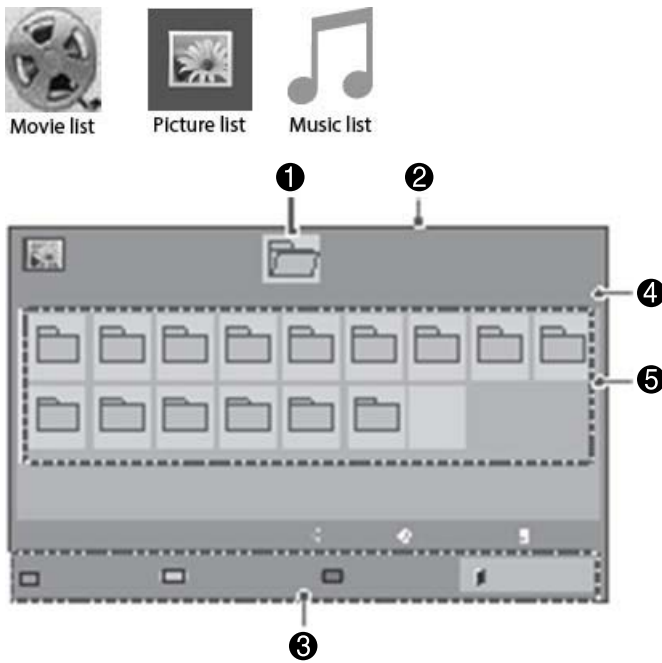

Item	Description
(1)	Moves to upper level folder.
(2)	Current page/Total pages.
(3)	Corresponding buttons on the remote control.
(4)	Current page/total pages of contents under the folder focused on (1).
(5)	Contents under the folder focused on (1).

Button	Description
Green button	Press the green button to toggle between Photo List > Music List , Music List > Movie List or Movie List > Photo List .
Yellow button	A method to view as either large thumbnail folder or listing.
Blue button	Convert to Mark Mode.

Supported file format

Type	Supported file format
Movie	<p>DAT,MPG,MPEG,VOB,AVI,MP4,MKV,TS,TRP,TP,ASF,WMV,FLV)</p> <p>Movie (*.mpg/*.mpeg/*.dat/*.ts/*.trp/*.tp/*.vob/*.mp4/*.mov/*.mkv/*.avi/*.asf/*.wmv/*.flv/*.avi(motion-jpeg)/*.mp4(motion-jpeg)/*.mkv(motion-jpeg))supporting file</p> <p>Video format : Xvid1.00, Xvid1.01, Xvid1.02, Xvid1.03, Xvid1.10 beta-1/beta-2, Mpeg-1, Mpeg-2, Mpeg-4, H.264/AVC, VC1, JPEG, Sorenson H.263</p> <p>Audio format : Dolby Digital, AAC, Mpeg, MP3, LPCM, HE-AAC, ADPCM, WMA</p> <p>Bit rate : within 32 kbps to 320 kbps(MP3)</p> <p>External Subtitle format : *.smi/*.srt/*.sub (MicroDVD,Subviewer1.0/2.0)/*.ass/*.ssa/*.txt(TMPlayer)/*</p> <p>Internal Subtitle format : only, XSUB</p>
Photo	<p>JPEG Baseline : 64 x 64 to 15360 x 8640</p> <p>Progressive : 64 x 64 to 1920 x 1440</p> <ul style="list-style-type: none"> You can play JPEG files only Non-supported files are displayed in the form of predefined icon. <p>File extensions: .jpg, .jpeg, .jpe</p> <p>Supported file format:</p> <ul style="list-style-type: none"> SOF0: baseline SOF1: Extend Sequential SOF2: Progressive <p>Photo size:</p> <ul style="list-style-type: none"> Min: 64 x 64 Max: Normal Type: 15360 (W) x 8640 (H) Progressive Type: 1920 (W) x 1440 (H)
Music	<p>MP3</p> <p>Bit rate 32 to 320</p> <ul style="list-style-type: none"> Sampling rate MPEG1 Layer3 : 32 kHz, 44.1 kHz, 48 kHz Sampling rate MPEG2 Layer3 : 16 kHz, 22.05 kHz, 24 kHz Sampling rate MPEG2.5 Layer3 : 8 kHz, 11.025 kHz, 12 kHz
Content	<p>File Extensions : *.cts/ *.cse</p> <p>Movie</p> <p>File Extensions: *.mpg/*.mpeg/*.dat/*.ts/*.trp/*.tp/*.vob/*.mp4/*.mov/*.mkv/*.avi/*.asf/*.wmv/*.avi(motion JPEG)/*.mp4(motion JPEG)/*.mkv(motion JPEG)</p> <p>Video format: MPEG1, MPEG2, MPEG4,H.264/ AVC, Xvid 1.00,Xvid 1.01, Xvid 1.02, Xvid 1.03,Xvid 1.10-beta1/2, JPEG, VC1(WVC1/WMV3)</p> <p>Audio format: MP2,MP3,Dolby Digital, LPCM, AAC, HE-AAC,LPCM, ADPCM, WMA, MP3</p> <p>Photo: JPEG JPG PNG BMP</p> <p>Supported file format:</p>

- SOF0: baseline
- SOF1: Extend Sequential
- SOF2: Progressive

Photo size:

- Min: 64 x 64
- Max: 136 x 768

Music: MP3

Bit rate: 32 kbps to 320 kbps

Sampling rate:

- 32 kHz, 44.1 kHz, 48 kHz (MPEG1 L3)
- 16 kHz, 22.05 kHz, 24 kHz (MPEG2 L3)
- 8kHz, 11.025 kHz, 12 kHz (MPEG2.5 L3)

Playing videos

Your display shows all of the video files saved in a USB storage device or shared folder on a computer.

1. Press the Navigation buttons to scroll to **My Media** and press **OK**.
2. Press the Navigation buttons to scroll to **Movie List** and press **OK**.
3. Press the Navigation buttons to scroll to a folder you want and press **OK**.
4. Press the Navigation buttons to scroll to a file you want and press **OK**.

Menu	Description
Play marked	Returns to the selected video file.
Mark All	Mark all video files on the screen.
Unmark All	Deselect all marked video files.
Exit Mark Mode	Exit the Mark Mode.

5. Play a video.







NOTE: Non-supported files are displayed in the preview image by icon only

Abnormal files are displayed in the form of a bitmap .

6. Control playback by using the following buttons.

Button	Description
	Stops the playback.
	Plays a video.
	Pauses or resumes the playback.
	Scans backward in a file.

	Scans forward in a file.
MENU	Show the Option menu.
	Hide the menu on the full-sized screen.
	Return to Movie List .
< or >	Skips to specific points in a file during playback. The time of a specific point will appear on the status bar. In some files, this function may not work properly.
	Press the ENERGY SAVING button repeatedly to increase the brightness of your screen.

Tips for playing video files

- Some user-created subtitles may not work properly.
- Some special characters are not supported in subtitles.
- HTML tags are not supported in subtitles
- Subtitles in languages other than the supported languages are not available.
- The screen may suffer temporary interruptions (image stoppage, faster playback, etc.) when the audio language is changed.
- A damaged video file may not be played correctly, or some player functions may not be usable.
- Video files produced with some encoders may not be played correctly.
- If the video and audio structure of recorded file is not interleaved, either video or audio is outputted.
- HD videos with a maximum of 1920x1080@25/30P or 1280x720@50/60P are supported, depending on the frame.
- Videos with resolutions higher than 1920x1080@25/30P or 1280x720@50/60P may not work properly depending on the frame.
- Video files other than the specified types and formats may not work properly.
- Max bitrate of playable video file is 20 Mbps. (only, Motion JPEG : 10 Mbps).
- We do not guarantee smooth playback of profiles encoded level 4.1 or higher in H.264/ AVC.
- DTS Audio codec is not supported.
- A video file more than 30 GB in file size is not supported for playback.
- A video file name and its subtitle file name must be identical for it to be displayed.
- Playing a video via a USB connection that does not support high speed may not work properly
- Files encoded with GMC (Global Motion Compensation) may not be played.
- When you are watching the video by Movie List function, you can adjust an image by Energy Saving key on the remote control.

Video options

1. Press **MENU** to access the **Pop-Up** menus.
2. Press the Navigation buttons to scroll to **Set Video Play**, **Set Video**. or **Set Audio** and press **OK**.



NOTE: Option values changed in **Movie List** do not affect **Photo List** and **Music List**.

Option value changed in **Photo List** and **Music List** are changed likewise in **Photo List** and **Music List** excluding **Movie List**.

When replaying the video file after stopping, you can play from where it stopped previously.

When you select **Set Video Play**:

1. Press the Navigation buttons to scroll to show the **Picture Size, Audio Language, Subtitle Language** or **Repeat**.
2. Press the Navigation buttons to scroll to make appropriate adjustments.

Menu	Description
Picture Size	Selects your desired picture format during video play.
Audio Language	Changes the Language Group of the audio during video play. This option cannot be selected for files with a single audio track.
Subtitle Language	Turn on/off the subtitle.
Language	Activated for SMI subtitle and can select the language within the subtitle.
Code Page	Can select the font for subtitle. When set to default, same font as general menu will be used.
Sync	Adjusts the time synchronization of the subtitle from -10 secs to +10 secs by steps of 0.5 secs during video play.
Position	Changes the position of the subtitle either up or down during video play.
Size	Selects your desired Subtitle size during video play.
Repeat	Turn on/off repeat function of video playback. When turned on, the file within the folder will be played back repeatedly. Even when the repeated playback is turned off, it can run the playback if the file name is similar to the previous file.

Code Page	Description
Latin1	English, Spanish, French, German, Italian, Swedish, Finnish, Dutch, Portuguese, Danish, Romanian, Norwegian, Albanian, Gaelic, Welsh, Irish, Catalan, Valencian
Latin2	Bosnian, Polish, Croatian, Czech, Slovak, Slovenian, Serbian, Hungarian
Latin4	Estonian, Latvian, Lithuanian
Cyrillic	Bulgarian, Macedonian, Russian, Ukrainian, Kazakh
Greek	Greek
Turkish	Turkish
Korean	Korean



NOTE: Only 10,000 sync blocks are supported within the subtitle file.

When playing a video, you can adjust the Picture Size by pressing the ARC button.

Subtitles in your language are only supported when the OSD menu is also in this language.

The code page options may be disabled depending on the language of the subtitle files.

Select the appropriate code page for the subtitle files.

When you select **Set Video:**

- ▲ Press the Navigation buttons to scroll to make appropriate adjustments.

When you select **Set Audio:**

1. Press the Navigation buttons to scroll to show the **Sound Mode, Clear Voice II, or Balance.**
2. Press the Navigation buttons to scroll to make appropriate adjustments.

Viewing photos

View image files saved in a USB storage device. The displays on the screen may differ from the model.

1. Press the Navigation buttons to scroll to **My Media** and press **OK.**
2. Press the Navigation buttons to scroll to **Photo List** and press **OK.**
3. Press the Navigation buttons to scroll to a folder you want and press **OK.**
4. Press the Navigation buttons to scroll to a file you want and press **OK.**

Menu	Description
View marked	Display the selected photo file.
Mark All	Mark all photo files on the screen.
Unmark All	Deselect all marked photo files.
Exit Mark Mode	Exit the Mark Mode.

5. View photos.



NOTE: Non-supported files are displayed the preview image by icon only.

Abnormal files are displayed in bitmap form.

Using photo options

Use the following options while viewing photos.

Option	Description
Slideshow	Starts or stops a slideshow with selected photos. If there are no selected photos, all photos saved in the current folder display during a slideshow. To set a slideshow speed, select Option.
BGM	Turns the background music (BGM) on or off. To set the background music folder, select Option. You can adjust Option by MENU button on the remote control.
	Rotates photos clockwise (90°, 180°, 270°, 360°). NOTE: The supported photo size is limited. You cannot rotate a photo if the resolution of the rotated width is larger than the supported resolution size.



View the photo by zoom in 2, 4 times.

NOTE: Photos with a resolution of 960x540 or less cannot be enlarged.



Press the **ENERGY SAVING** button repeatedly to change the brightness of your screen.

MENU

- **Slide Speed:** Selects a slideshow speed (Fast, Medium, Slow).
- **TransitionEffect:** Set the view mode of the slideshow.
- **BGM:** Selects a music folder for the background music.

NOTE: You cannot change the music folder while the background music is playing. You can only select the MP3 folder saved on the device that currently displays the photo.



Hides the option window. To display the options, press **OK**.



Return to **Photo List**.

Photo options

1. Press **MENU** to show the **Option** menus.
2. Press the Navigation buttons to scroll to **Set Photo View**, **Set Video**, or **Set Audio** and press **OK**.



NOTE: Option values changed in **Movie List** do not affect **Photo List** and **Music List**.



Option value changed in **Photo List** and **Music List** are changed likewise in **Photo List** and **Music List** excluding **Movie List**.

When replaying the video file after stopping, you can play from where it stopped previously.

When you select **Set Photo View**:

1. Press the Navigation buttons to scroll to show the **Slide Speed**, **Transition Effect**, or **BGM**.
2. Press the Navigation buttons to scroll to make appropriate adjustments.

Transition Effect Option

Option	Description
Sliding	Pushes the current slide out of view as it plays to the next slide. 
Stairs	Pushes the current slide in a staircase shape as it plays to the next slide. 
Door Open/Close	Pushes the current slide like opening or closing the door as it plays to the next slide. 
Shutter	Pushes the current slide like drawing or pulling down the blind as it plays to the next slide



Fade In

Fades the slide out slowly before playing to the next slide.



When you select **Set Video**:

- ▲ Press the Navigation buttons to scroll to make appropriate adjustments.

When you select **Set Audio**:

1. Press the Navigation buttons to scroll to show the **Sound Mode**, **Clear Voice II**, or **Balance**.
2. Press the Navigation buttons to scroll to make appropriate adjustments.

Listening to music

 **NOTE:** Speakers must be installed on the display to listen to audio.





1. Press the Navigation buttons to scroll to **My Media** and press **OK**.
2. Press the Navigation buttons to scroll to **Music List** and press **OK**.
3. Press the Navigation buttons to scroll to a folder you want and press **OK**.
4. Press the Navigation buttons to scroll to a file you want and press **OK**.

Menu	Description
Play marked	Display the selected music file.
Mark All	Mark all music files on the screen.
Unmark All	Deselect all marked music files.
Exit Mark Mode	Exit the Mark Mode.

5. Play music.
6. Control playback by using the following buttons.

Button	Description
■	Stops playing back the file and moves back to the music list.
▶	Plays a music file.
	Pauses or resumes playback.
◀◀	Skips to the previous file.
▶▶	Skips to the next file.
◀◀	When playing, when you press the << button, the previous music file will be played. When you press the >> button, the next music file will be played.

or

	
Green button	Start playing the selected music files and then move to the Music List .
	Press the ENERGY SAVING button repeatedly to increase the brightness of your screen.
MENU	Show the Option menu.
	Hides the option window. To display the options, press OK .
	When you press the EXIT button while the Music player is displayed, only the music will be stopped and the player will not return to normal viewing. When you press the EXIT button while the music is stopped or while the music player is hidden, the player will return to normal viewing.
< or >	When using the < or > button during playback a cursor indicating forward or backward.

Tips for playing music files

- This display does not support the ID3 Tag embedded MP3 files.





 **NOTE:** Non-supported files are displayed in the preview image by icon only .

Abnormal files are displayed as bitmaps .

A damaged or corrupted music does not play but displays 00:00 in playtime.

A music downloaded from a paid service with copyright protection does not start but displays inappropriate information in playtime.

If you press OK or  buttons, audio and screen saver is stopped.

The PLAY () , Pause () , ) , ) buttons on the remote control are also available in this mode.

You can use the  button to select the next music and the  button to select the previous music.

Music options

1. Press **MENU** to access the **Pop-Up** menus.
2. Press the Navigation buttons to scroll to **Set Audio Play** or **Set Audio** and press **OK**.

 **NOTE:** Option values changed in **Movie List** do not affect **Photo List** and **Music List**.

Option value changed in **Photo List** and **Music List** are changed likewise in **Photo List** and **Music List** excluding **Movie List**.

When you select **Set Audio Play**:

1. Press the Navigation buttons to scroll to show **Repeat** or **Random**.
2. Press the Navigation buttons to scroll to make appropriate adjustments.

When you select **Set Audio**:

1. Press the Navigation buttons to scroll to show the **Sound Mode**, **Clear Voice II**, or **Balance**.
2. Press the Navigation buttons to scroll to make appropriate adjustments.

Using PIP/PBP

Displays videos or photos stored in a USB device on a single display by dividing it into the main and sub screens.

1. Press the MENU button to move to **OPTION** and press **OK**.
2. Press PIP/PBP to select PIP or PBP and then press **OK**.

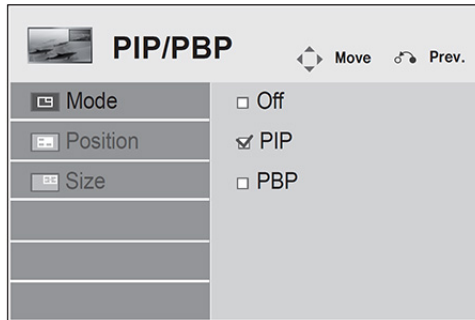

3. Select **Movie List** or **Photo List** from **My Media**. (With **PIP/PBP** selected, the **Music List** is deactivated.)



4. Select a file you want and then press **OK**.

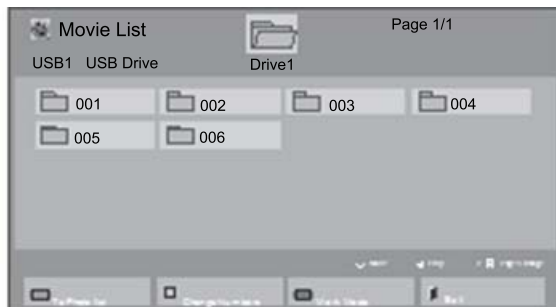

5. Select the PIP or PBP icon from the play list.



6. Select either **Main** or **Sub** for sound. You must select the output sound before running the PIP or PBP function.
7. The sub screen is displayed on the main screen.



9 Troubleshooting

No image is displayed.

Cause	Solution
Is the product power cord connected?	See if the power cord is properly connected to the outlet.
Does the 'Out of range' message appear?	The signal from the computer (video card) is out of the vertical or horizontal frequency range of the product. Adjust the frequency range using the following specifications: Maximum resolution RGB : 1920 x 1080 @ 60 Hz HDMI/DisplayPort : 1920 x 1080 @ 60 Hz
Does the 'Check signal cable' message appear?	The signal cable between computer and product is not connected. Check the signal cable. Press the INPUT menu in the remote Control to check the input signal.

'Unknown Product' message appears when the product is connected.

Cause	Solution
Did you install the driver?	See if the plug & play function is supported by referring to the video card user manual.

The screen image looks abnormal.

Cause	Solution
Is the screen position wrong?	D-Sub analog signal - Press the AUTO button in the remote control to automatically select the optimal screen status that fits into the current mode. If adjustment is not satisfactory, use the Position OSD menu. See if the video card resolution and frequency are supported by the product. If the frequency is out of range, set to the recommended resolution in the Control Panel Display Setting menu.
Do thin lines appear on the background screen?	D-Sub analog signal - Press the AUTO button in the remote control to automatically select an optimal screen status that fits into the current mode. If adjustment is not satisfactory, use the Clock OSD menu.
Horizontal noise appears or the characters look blurred.	D-Sub analog signal - Press the AUTO button in the remote control to automatically select an optimal screen status that fits into the current mode. If adjustment is not satisfactory, use the Phase OSD menu.
The screen is displayed abnormally.	The proper input signal is not connected to the signal port. Connect the signal cable that matches with the source input signal.

After-image appears on the product.

Cause	Solution
After-image appears when the product is turned off.	If you use a fixed image for a long time, the pixels may be damaged quickly. Use the screen-saver function. When a dark image is displayed on the screen after an image with high contrast (black and white or gray), this may cause image sticking. This is normal for LCD screen.

The audio function does not work.

Cause	Solution
No sound?	See if the audio cable is connected properly. Adjust the volume. See if the sound is set properly.
Sound is too dull.	Select the appropriate equalize sound.
Sound is too low.	Adjust the volume.

Screen color is abnormal.

Cause	Solution
Screen has poor color resolution (16 colors).	Set the number of colors to more than 24 bits (true color) Select Control Panel - Display - Settings - Color Table menu in Windows.
Screen color is unstable or mono-colored.	Check the connection status of the signal cable. Or, reinsert the computer video card.
Do black spots appear on the screen?	Several pixels (red, green, white or black color) may appear on the screen, which can be attributable to the unique characteristics of the LCD panel. It is not a malfunction of the LCD.

The operation does not work normally.

Cause	Solution
The power suddenly turned off.	Is the sleep timer set? Check the power control settings. Power interrupted.

10 Specifications

42-inch models

LCD Panel	Screen type	1064.67 mm Wide (42 inch) TFT (Thin Film Transistor) LCD (Liquid Crystal Display) Panel. Visible diagonal size : 1064.67 mm
	Pixel pitch	0.4833 mm (H) x 0.4833 mm (V)
Video Signal	Max resolution	RGB : 1920 x 1080 @ 60 Hz HDMI/ DisplayPort : 1920 x 1080 @ 60 Hz It may not be supported depending on the OS or video card type.
	Recommended resolution	RGB : 1920 x 1080 @ 60 Hz HDMI/ DisplayPort : 1920 x 1080 @ 60 Hz It may not be supported depending on the OS or video card type.
	Horizontal frequency	30 kHz to 83 kHz
	Vertical frequency	50 Hz to 60 Hz
	Synchronization type	Separate Sync, Composite Sync, Digital
Input connector		15-pin D-Sub type, HDMI (digital), Component, RS-232C, LAN, DisplayPort, USB
Power	Rated voltage	AC 100-240 V~ 50/60 Hz 1.3 A
	Power consumption	On Mode : 90 W Typ Sleep Mode (if WOL is off) : ≤ 0.5 W Sleep Mode (if WOL is on) : ≤ 2.0 W Off Mode : ≤ 0.5 W
Environmental conditions	Operating Temperature	0°C to 40°C
	Operating Humidity	10% to 80%
	Storage Temperature	-20°C to 60°C
	Storage Humidity	5% to 95%
Dimensions	W x H x D, weight) (no stand or speakers)	962.2 mm x 560.8 mm x 77 mm 37.88 in x 22.08 in x 3.03 in 12.8 kg 28.22 lbs
	(stand, no speakers)	962.2 mm x 636.5 mm x 297.7 mm 37.88 in x 25.06 in x 11.72 in 14.1 kg 31.09 lbs

(no stand, with speakers)	962.2 mm x 560.8 mm x 100.1 mm 37.88 in x 22.08 in x 3.94 in 13.55 kg 29.87 lbs
(with stand and speakers)	962.2 mm x 636.5 mm x 297.7 mm 37.88 in x 25.06 in x 11.72 in 14.1 kg 31.09 lbs

For models that support speakers:

Audio	RMS Audio Output	10 W + 10 W (R + L)
	Input Sensitivity	0.7 V _{rms}
	Speaker Impedance	8 Ω

Dimensions

 **NOTE:** Product specifications may change without prior notice due to upgrade of product functions.

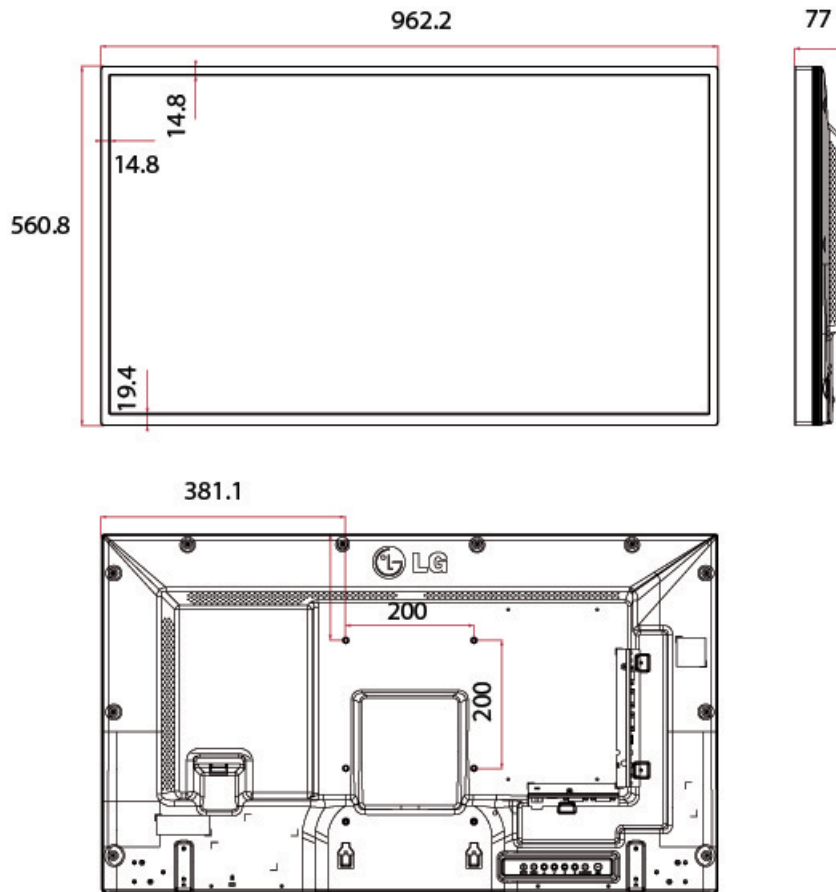

4-M6 wall mounting screws

Depth 10.0 mm (Max)

47-inch models

LCD Panel	Screen type	1192.78 mm Wide (47 inch) TFT (Thin Film Transistor) LCD (Liquid Crystal Display) Panel. Visible diagonal size : 1192.78 mm
	Pixel pitch	0.5415 mm (H) x 0.5415 mm (V)
Video Signal	Max resolution	RGB : 1920 x 1080 @ 60 Hz HDMI/ DisplayPort : 1920 x 1080 @ 60 Hz It may not be supported depending on the OS or video card type.
	Recommended resolution	RGB : 1920 x 1080 @ 60 Hz HDMI/ DisplayPort : 1920 x 1080 @ 60 Hz It may not be supported depending on the OS or video card type.
	Horizontal frequency	30 kHz to 83 kHz
	Vertical frequency	50 Hz to 60 Hz
	Synchronization type	Separate Sync, Composite Sync, Digital
	Input connector	
Power	Rated voltage	AC 100-240 V~ 50/60 Hz 1.3 A
	Power consumption	On Mode : 95 W Typ Sleep Mode (if WOL is off) : ≤ 0.5 W Sleep Mode (if WOL is on) : ≤ 2.0 W Off Mode : ≤ 0.5 W
	Environmental conditions	
	Operating Temperature	0°C to 40°C
	Operating Humidity	10% to 80%
	Storage Temperature	-20°C to 60°C
	Storage Humidity	5% to 95%
Dimensions	W x H x D, weight	1074.3 mm x 624 mm x 78.6 mm
	(not including stand or speakers)	42.3 in x 24.57 in x 3.10 in 15.5 kg 34.17 lbs
	(with stand, no speakers)	1074.3 mm x 699.9 mm x 298.3 mm 42.3 in x 27.56 in x 11.74 in 16.8 kg 37.03 lbs
	(no stand, with speakers)	1074.3 mm x 624 mm x 101.6 mm 42.3 in x 24.57 in x 4.0 in 16.25 kg

	35.83 lbs
(with stand, and speakers)	1074.3 mm x 699.9 mm x 298.3 mm
	42.3 in x 27.56 in x 11.74 in
	17.55 kg
	38.69 lbs

For models that support speakers:

Audio	RMS Audio Output	10 W + 10 W (R + L)
	Input Sensitivity	0.7 Vrms
	Speaker Impedance	8 Ω

Dimensions

 **NOTE:** Product specifications may change without prior notice due to upgrade of product functions.

Dimensions

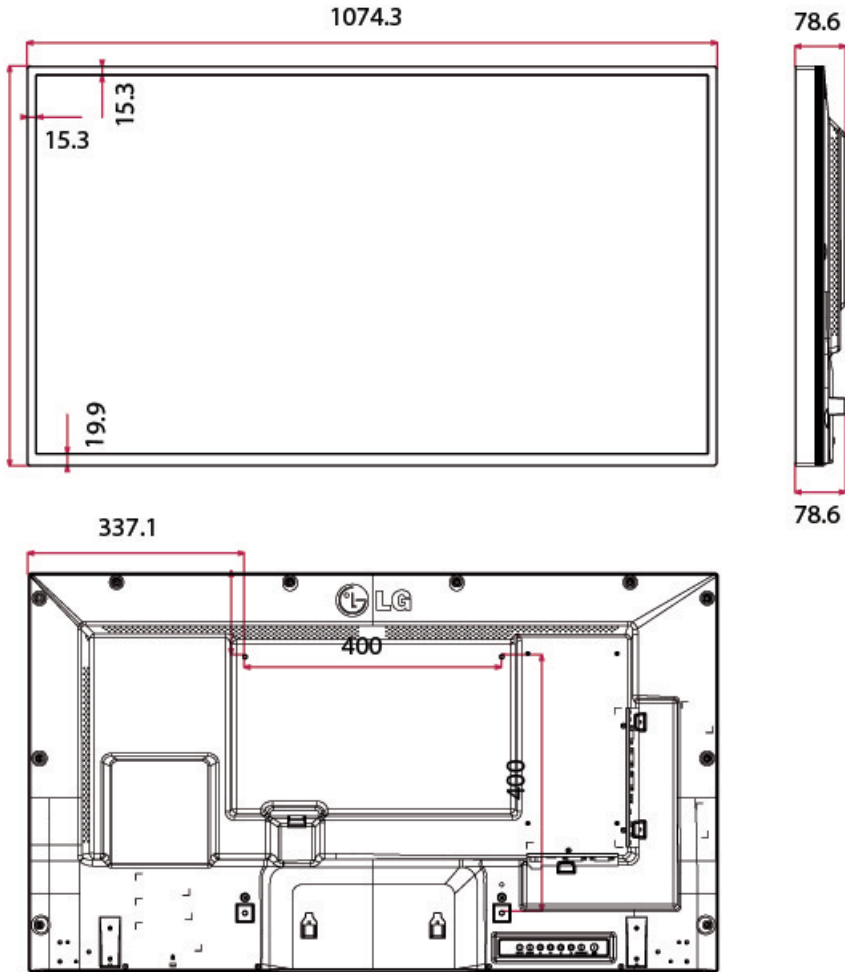

4-M6 wall mounting screws

Depth 20.0 mm (Max)

Recognizing preset display resolutions

The display resolutions listed below are the most commonly used modes and are set as factory defaults. This display automatically recognizes these preset modes and they will appear properly sized and centered on the screen.

Preset	Pixel format	Horizontal Frequency (Hz)	Vertical Frequency (Hz)
1	640 x 480	31.469	59.940
*2	720 x 400	31.469	70.087
3	800 x 600	37.879	60.317
4	1024 x 768	48.363	60.004
5	1280 x 720	45.000	60.000
6	1280 x 800	49.702	59.810
7	1280 x 1024	63.981	60.020
8	1440 x 900	55.469	59.901
9	1600 x 900	60.000	60.000
10	1680 x 1050	65.290	59.954
11	1920 x 1080	67.5	60.00

*RGB mode only

DTV mode

Resolution	Component	HDMI/DisplayPort (DTV)
480i	o	x
576i	o	x
480p	o	o
576p	o	o
720p	o	o
1080i	o	o
1080p	o	o

 **NOTE:** HDMI/DisplayPort input mode may identified in PC resolution: 640 x 480 / 60 Hz, 1280 x 720 / 60 Hz, 1920 x 1080 / 60 Hz or DTV resolutions: 480p, 720p, 1080p.



 **NOTE:** Vertical frequency: To enable the user to watch the product display, screen image should be changed tens of times every second like a fluorescent lamp. The vertical frequency or refresh rate is the times of image display per second. The unit is Hz.

Horizontal frequency: The horizontal interval is the time to display one vertical line. When 1 is divided by the horizontal interval, the number of horizontal lines displayed every second can be tabulated as the horizontal frequency. The unit is kHz.

IR codes

All models do not support the HDMI/USB function.

Some key codes are not supported depending on the model.

Code (Hexa)	Function	Note
95	Energy Saving	R/C BUTTON
08	 POWER	R/C BUTTON (ON/OFF)
0B	INPUT	R/C BUTTON
C4	Display On	R/C BUTTON
C5	Display Off	R/C BUTTON
43	MENU	R/C BUTTON
40	UP (^)	R/C BUTTON
41	Down (v)	R/C BUTTON
07	Left (<)	R/C BUTTON
06	Right (>)	R/C BUTTON
44	OK	R/C BUTTON
28	BACK 	R/C BUTTON

5B	EXIT	R/C BUTTON
4D	PSM	R/C BUTTON
02	Volume (+)	R/C BUTTON
03	Volume (-)	R/C BUTTON
09	MUTE	R/C BUTTON
E0	Bright ^ (Page Up)	R/C BUTTON
E1	Bright v (Page Down)	R/C BUTTON
10 to 19	Number key 0 to 9	R/C BUTTON
72	Red key (ID ON)	R/C BUTTON
71	Green key (ID OFF)	R/C BUTTON
63	Yellow key	R/C BUTTON
61	Blue key	R/C BUTTON
7B	TILE	R/C BUTTON
76	ARC (4:3)	R/C BUTTON
77	ARC (16:9)	R/C BUTTON
AF	ARC (ZOOM)	R/C BUTTON
79	ARC (MARK)	R/C BUTTON
99	Auto config	R/C BUTTON
B1	■	R/C BUTTON
B0	▶	R/C BUTTON
BA		R/C BUTTON
8F	◀◀	R/C BUTTON
8E	▶▶	R/C BUTTON

11 Agency regulatory notices

Federal Communications Commission notice

This equipment has been tested and found to comply with the limits for a Class B digital device, pursuant to Part 15 of the FCC Rules. These limits are designed to provide reasonable protection against harmful interference in a residential installation. This equipment generates, uses, and can radiate radio frequency energy and, if not installed and used in accordance with the instructions, may cause harmful interference to radio communications. However, there is no guarantee that interference will not occur in a particular installation. If this equipment does cause harmful interference to radio or television reception, which can be determined by turning the equipment off and on, the user is encouraged to try to correct the interference by one or more of the following measures:

- Reorient or relocate the receiving antenna.
- Increase the separation between the equipment and the receiver.
- Connect the equipment into an outlet on a circuit different from that to which the receiver is connected.
- Consult the dealer or an experienced radio or television technician for help.

Modifications

The FCC requires the user to be notified that any changes or modifications made to this device that are not expressly approved by Hewlett Packard Company may void the user's authority to operate the equipment.

Cables

Connections to this device must be made with shielded cables with metallic RFI/EMI connector hoods to maintain compliance with FCC Rules and Regulations.

Declaration of Conformity for products marked with the FCC logo (United States only)

This device complies with Part 15 of the FCC Rules. Operation is subject to the following two conditions:

1. This device may not cause harmful interference.
2. This device must accept any interference received, including interference that may cause undesired operation.

For questions regarding the product, contact:

Hewlett Packard Company

P. O. Box 692000, Mail Stop 530113

Houston, Texas 77269-2000

Or, call 1-800-HP-INVENT (1-800 474-6836)

For questions regarding this FCC declaration, contact:

Hewlett Packard Company

P. O. Box 692000, Mail Stop 510101

Houston, Texas 77269-2000

Or, call (281) 514-3333

To identify this product, refer to the Part, Series, or Model number found on the product.

Canadian notice

This Class B digital apparatus meets all requirements of the Canadian Interference-Causing Equipment Regulations.

Avis Canadien

Cet appareil numérique de la classe B respecte toutes les exigences du Règlement sur le matériel brouilleur du Canada.

European Union regulatory notice



Products bearing the CE marking comply with the following EU Directives:

- Low Voltage Directive 2006/95/EC
- EMC Directive 2004/108/EC
- Ecodesign Directive 2009/125/EC, where applicable

CE compliance of this product is valid if powered with the correct CE-marked AC adapter provided by HP.

Compliance with these directives implies conformity to applicable harmonized European standards (European Norms) that are listed in the EU Declaration of Conformity issued by HP for this product or product family and available (in English only) either within the product documentation or at the following web site: www.hp.eu/certificates (type the product number in the search field).

The compliance is indicated by one of the following conformity markings placed on the product:

	For non-telecommunications products and for EU harmonized telecommunications products, such as Bluetooth® within power class below 10mW.
	For EU non-harmonized telecommunications products (If applicable, a 4-digit notified body number is inserted between CE and !).

Please refer to the regulatory label provided on the product.

The point of contact for regulatory matters is: Hewlett-Packard GmbH, Dept./MS: HQ-TRE, Herrenberger Strasse 140, 71034 Boeblingen, GERMANY.

German ergonomics notice

HP products which bear the “GS” approval mark, when forming part of a system comprising HP brand computers, keyboards and monitors that bear the “GS” approval mark, meet the applicable ergonomic requirements. The installation guides included with the products provide configuration information.

Japanese notice

この装置は、クラスB情報技術装置です。この装置は、家庭環境で使用することを目的としていますが、この装置がラジオやテレビジョン受信機に近接して使用されると、受信障害を引き起こすことがあります。取扱説明書に従って正しい取り扱いをして下さい。

VCCI-B

Korean notice

B급 기기
(가정용 방송통신기기)

이 기기는 가정용(B급)으로 전자파적합등록을 한 기기로서 주로 가정에서 사용하는 것을 목적으로 하며, 모든 지역에서 사용할 수 있습니다.

Power cord set requirements

The display power supply is provided with Automatic Line Switching (ALS). This feature allows the display to operate on input voltages between 100–120V or 200–240V.

The power cord set (flexible cord or wall plug) received with the display meets the requirements for use in the country where you purchased the equipment.

If you need to obtain a power cord for a different country, you should purchase a power cord that is approved for use in that country.

The power cord must be rated for the product and for the voltage and current marked on the product's electrical ratings label. The voltage and current rating of the cord should be greater than the voltage and current rating marked on the product. In addition, the cross-sectional area of the wire must be a minimum of 0.75 mm² or 18 AWG, and the length of the cord must be between 6 feet (1.8 m) and 12 feet (3.6 m). If you have questions about the type of power cord to use, contact an authorized HP service provider.

A power cord should be routed so that it is not likely to be walked on or pinched by items placed upon it or against it. Particular attention should be paid to the plug, electrical outlet, and the point where the cord exits from the product.

Japanese power cord requirements

For use in Japan, use only the power cord received with this product.

 **CAUTION:** Do not use the power cord received with this product on any other products.

Product environmental notices

Materials disposal

This HP product contains mercury in the fluorescent lamp in the display LCD that might require special handling at end-of-life.

Disposal of this material can be regulated because of environmental considerations. For disposal or recycling information, contact the local authorities or the Electronic Industries Alliance (EIA) www.eiae.org.

Disposal of waste equipment by users in private households in the European Union



This symbol on the product or on its packaging indicates that this product must not be disposed of with your household waste. Instead, it is your responsibility to dispose of your waste equipment by handing it over to a designated collection point for the recycling or waste electrical and electronic equipment. The separate collection and recycling of your waste equipment at the time of disposal will help to conserve natural resources and ensure that it is recycled in a manner that protects human health and the environment. For more information about where you can drop off your waste equipment for recycling, please contact the local city office, the household waste disposal service or the shop where you purchased the product.

Chemical substances

HP is committed to providing our customers with information about the chemical substances in our products as needed to comply with legal requirements such as REACH (Regulation EC No 1907/2006 of the European Parliament and Council). A chemical information report for this product can be found at www.hp.com/go/reach.

HP recycling program

HP encourages customers to recycle used electronic hardware, HP original print cartridges, and rechargeable batteries. For more information about recycling programs, go to www.hp.com/recycle.

Restriction of Hazardous Substances (RoHS)

A Japanese regulatory requirement, defined by specification JIS C 0950, 2005, mandates that manufacturers provide Material Content Declarations for certain categories of electronic products offered for sale after July 1, 2006. To view the JIS C 0950 material declaration for this product, visit www.hp.com/go/jisc0950.

2008年、日本における製品含有表示方法、JISC0950が公示されました。製造事業者は、2006年7月1日以降に販売される電気・電子機器の特定化学物質の含有につきまして情報提供を義務付けられました。製品の部材表示につきましては、www.hp.com/go/jisc0950を参照してください。

有毒有害物质/元素的名称及含量表

根据中国
《电子信息产品污染控制管理办法》

液晶显示器

部件名称	有毒有害物质和元素					
	铅 (Pb)	汞 (Hg)	镉 (Cd)	六价铬 (Cr(VI))	多溴联苯 (PBB)	多溴二苯醚 (PBDE)
液晶显示器显示面板	X	X	○	○	○	○
机箱/其它	X	○	○	○	○	○

CRT 显示器

部件名称	有毒有害物质和元素					
	铅 (Pb)	汞 (Hg)	镉 (Cd)	六价铬 (Cr(VI))	多溴联苯 (PBB)	多溴二苯醚 (PBDE)
阴极射线管	X	○	○	○	○	○
机箱/其它	X	○	○	○	○	○

O: 表示该有毒或有害物质在该部件所有均质材料中的含量均在 SJ/T11363-2006 标准规定的限量要求以下。

X: 表示该有毒或有害物质至少在该部件所用的某一均质材料中的含量超出 SJ/T11363-2006 标准规定的限量要求。

表中标有“X”的所有部件都符合欧盟 RoHS 法规——“欧洲议会和欧盟理事会 2003 年 1 月 27 日关于电子电器设备中限制使用某些有害物质的 2002/95/EC 号指令”。

注: 环保使用期限的参考标识取决于产品正常工作的温度和湿度等条件。

Turkey EEE regulation

In Conformity with the EEE Regulation

EEE Yönetmeliğine Uygundur

Ukraine Restriction of Hazardous Substances

Обладнання відповідає вимогам Технічного регламенту щодо обмеження використання деяких небезпечних речовин в електричному та електронному обладнанні, затвердженого постановою Кабінету Міністрів України від 3 грудня 2008 № 1057.

The equipment complies with requirements of the Technical Regulation, approved by the Resolution of Cabinet of Ministry of Ukraine as of December 3, 2008, in terms of restrictions for the use of certain dangerous substances in electrical and electronic equipment.

12 Controlling multiple products

Use this method to connect several products to a single computer. You can control several products at a time by connecting them to a single computer.

In the Option menu, Set ID must be between 1 and 255 without being duplicated.

Connecting the cable

Connect the RS-232C cable as shown.

The RS-232C protocol is used for communication between the computer and product. You can turn the product on/off, select an input source or adjust the OSD menu from your computer.

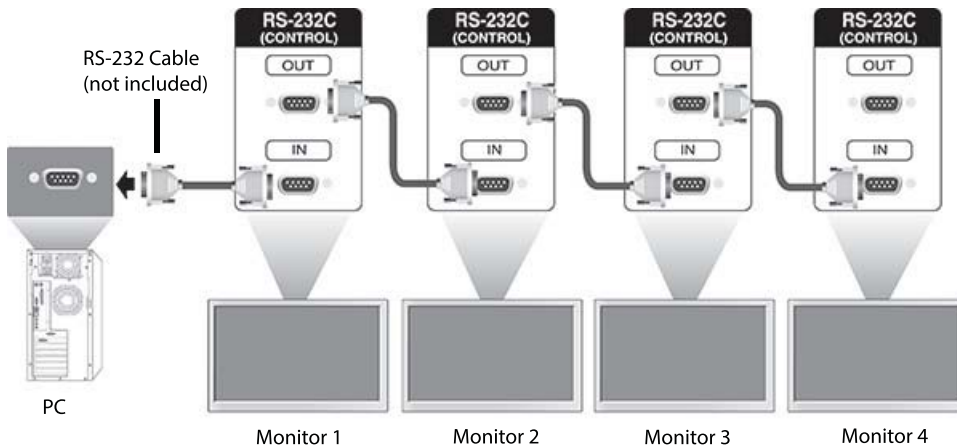

RS-232C configurations

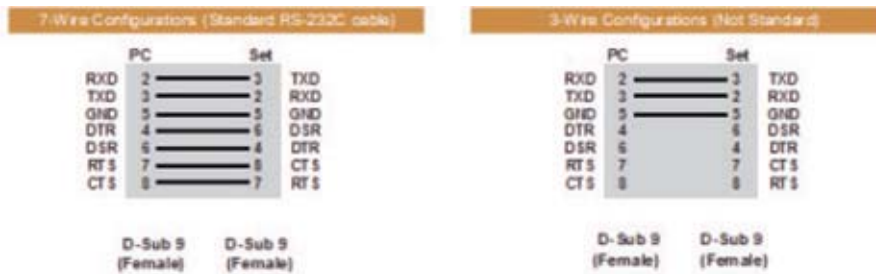

Communication parameter

Baud Rate: 9600 baud Rate (UART)

Data Length: 8 bit

Parity Bit: None

Stop Bit: 1 bit

Flow Control: None

Communication Code: ASCII code

Use a crossed (reverse) cable

Command reference list

	Command		Data (Hexadecimal)
	1	2	
01. Power	k	a	00 to 01
02. Input Select	x	b	Refer to 'Input Select'
03. Aspect Ratio	k	c	Refer to 'Aspect Ratio'
04. Energy Saving	j	q	Refer to 'Energy Saving'
05. Picture mode	d	x	Refer to 'Picture Mode'
06. Contrast	k	g	00 to 64
07. Brightness	k	h	00 to 64
08. Sharpness	k	k	00 to 64
09. Color	k	l	00 to 64
10. Tint	k	j	00 to 64
11. Color Temperature	x	u	00 to 64
12. H Position	f	q	00 to 64
13. V Position	f	r	00 to 64
14. H Size	f	s	00 to 64
15. Auto configuration	j	u	01
16. Balance	k	t	00 to 64
17. Sound mode	d	y	Refer to 'Sound Mode'
18. Treble	k	r	00 to 64
19. Bass	k	s	00 to 64
20. Speaker	d	v	00 to 01
21. Volume Mute	k	e	00 to 01
22. Volume Control	k	f	00 to 64

23. Time 1 (Years/Months/Days)	f	a	Refer to 'Time 1'
24. Time 2 (Hours/Minutes/Seconds)	f	x	Refer to 'Time 2'
25. Off Timer (Repeat mode/Time)	f	e	Refer to 'Off Timer'
26. On Timer (Repeat mode/Time)	f	d	Refer to 'On Timer'
27. On Timer Input	f	u	Refer to 'On Timer Input'
28. Sleep Time	f	f	00 to 08
29. Power On Delay	f	h	00 to 64
30. Automatic Standby	m	n	00 to 01
31. Auto Off	f	g	00 to 01
32. Language	f	l	Refer to 'Language'
33. ISM Mode	j	p	Refer to 'ISM Method'
34. Auto-Switch Select	m	l	00H to 02H
35. Auto-Switch Input Select	m	j	Refer to 'Auto-Switch Input Select.'
36. Reset	f	K	00 to 03
37. Tile Mode	d	d	00 to FF
38. Tile Mode Check	d	z	FF
39. Tile ID	d	l	Refer to 'Tile ID'
40. Tile H Position	d	e	00 to 32
41. Tile V Position	d	f	00 to 32
42. Tile H Size	d	g	00 to 32
43. Tile V Size	d	h	00 to 32
44. Natural Mode (In Tile mode)	d	j	00 to 01
45. DPM Select	f	j	00 to 01
46. Temperature Value	d	n	FF
47. Remote Lock/Key Lock	k	m	00 to 01
48. Key	m	c	Refer to 'Key'
49. OSD Select	k	l	00 to 01
50. Elapsed Time Return	d	l	FF
51. Serial No. Check	f	y	FF
52. S/W Version	f	z	FF
53. White Balance Red Gain	j	m	00 to FE
54. White Balance Green Gain	j	n	00 to FE
55. White Balance Blue Gain	j	o	00 to FE
56. Backlight	m	g	00 to 64



NOTE: During USB operations such as EMF, all commands except Power(k a) and Key(m c) are not executed and treated as NG.

Transmission / Receiving protocol

Transmission

[Command1][Command2][][Set ID][][Data][Cr]

- * [Command1]: First command to control the set.
- * [Command2]: Second command to control the set.
- * [Set ID]: Set ID with which you want to communicate. Enter [Set ID] = '00(0x00)' to communicate with all sets regardless of their Set ID numbers.
- * [Data]: Information passed to the set.
- * [Data1]: Information passed to the set.
- * [Data2]: Information passed to the set.
- * [Data3]: Information passed to the set.
- * [Cr]: Carriage Return. ASCII code '0x0D'.
- * []: ASCII code space '0x20'

Acknowledgement

[Command2][][Set ID][][OK/NG][Data][x]

- * When the product receives data normally, it sends an acknowledgement (ACK) in the format above. If data is in read mode, it indicates the data that shows the current status. If data is in read mode, it simply indicates the data that is sent from the computer.
- * If a command is sent with Set ID '00' (=0x00), the data is reflected to all display and they do send an acknowledgement (ACK).
- * If the data value 'FF' is sent in control mode via RS-232C, the current setting value of a function can be checked (only for some functions).
- * Some commands are not supported depending on the model.

01. Power (Command: k a)

To control the Power On/Off the display.

Transmission

[k][a][][Set ID][][Data][Cr]

Data

00 : Off

01 : On

Acknowledgement

[a][][Set ID][][OK/NG][Data][x]

* Only when the display is fully powered on, the Acknowledgement signal is returned properly. * There may be a certain time of delay between the Transmission and Acknowledgement signals.

02. Input Select (Command: x b)

To select the Input Source for display.

Transmission

[x][b][][Set ID][][Data][Cr]

Data

20: Input (AV)

40: Component

60: RGB

70: VOE(PC)

80: VOE(DTV)

90: HDMI(HDMI1)(DTV)

A0: HDMI(HDMI1)(PC)

C0: Display Port(DTV)

D0: Display Port(PC)

91: HDMI2/SDI(DTV)

A1: HDMI2/SDI(PC)

Acknowledgement

[b][][Set ID][][OK/NG][Data][x]

*Some input signals may not be supported depending on the model.

03. Aspect Ratio (Command: k c)

To adjust the screen format.

Transmission

[k][c][][Set ID][][Data][Cr]

Data

01: 4:3

04: Zoom

09: Just scan (720p or more)

(Component, HDMI/ Display Port DTV)

* RGB, HDMI/Display Port PC mode

(1:1)

10 to 1F: Cinema Zoom 1 to 16

(AV, Component, HDMI DTV)

* Available data types differ depending on the input signal. For more information, see the aspect ratio section of this guide.

* The aspect ratio may differ depending on the model's input configuration.

Acknowledgement

[c][][Set ID][][OK/NG][Data][x]

04. Energy Saving (Command: j q)

To set the Energy Saving function.

Transmission

[j][q][][Set ID][][Data][Cr]

Data

00: Off

01: Minimum

02: Medium

03: Maximum

04: Auto

05: Screen Off

Acknowledgement

[q][][Set ID][][OK/NG][Data][x]

** It may not be supported depending on the model.

05. Picture Mode (Command: d x)

To select the Picture Mode.

Transmission

[d][x][][Set ID][][Data][Cr]

Data

00: Vivid

01: Standard

02: Cinema

03: Sport

04: Game

Acknowledgement

[x][][Set ID][][OK/NG][Data][x]

06. Contrast (Command: k g)

To adjust the screen contrast.

Transmission

[k][g][][Set ID][][Data][Cr]

Acknowledgement

[g][][Set ID][][OK/NG][Data][x]

07. Brightness (Command: k h)

To adjust the screen brightness.

Transmission

[k][h][][Set ID][][Data][Cr]

Data

00 to 64: Brightness 0 to 100

Acknowledgement

[h][][Set ID][][OK/NG][Data][x]

08. Sharpness (Command: k k)

To adjust the screen sharpness.

* This function is available only in AV/Component input.

Transmission

[k][k][][Set ID][][Data][Cr]

Data

00 to 64: Sharpness 0 to 100

Acknowledgement

[k][][Set ID][][OK/NG][Data][x]

09. Color (Command: k i)

To adjust the screen color.

* This function is available only in AV/Component input.

Transmission

Data

[k][i][][Set ID][][Data][Cr]

00 to 64: Color 0 to 100

Acknowledgement

[i][][Set ID][][OK/NG][Data][x]

10. Tint (Command: k j)

To adjust the screen tint.

* This function is available only in AV/Component input.

Transmission

[k][j][][Set ID][][Data][Cr]

Data

00 to 64: Tint R50 to G50

Acknowledgement

[j][][Set ID][][OK/NG][Data][x]

11. Color Temperature (Command: x u)

To adjust the screen Color Temperature.

Transmission

[x][u][][Set ID][][Data][Cr]

Data

00 to 64: Warm 50 to Cool 50

Acknowledgement

[u][][Set ID][][OK/NG][Data][x]

12. H Position (Command: f q)

To adjust the screen Horizontal Position.

* This function is available only when the Tile Mode is set to Off.

* The operational range varies depending on the RGB input resolution (Only available for RGB-PC input.)

Transmission

[f][q][][Set ID][][Data][Cr]

Data

00 to 64: min. -50 (Left) to max. 50 (Right)

Acknowledgement

[q][][Set ID][][OK/NG][Data][x]

13. V Position (Command: f r)

To adjust the screen Vertical Position.

* This function is available only when the Tile Mode is set to Off.

* The operational range varies depending on the RGB input resolution (Only available for RGB-PC input.)

Transmission

[f][r][][Set ID][][Data][Cr]

Data

00 to 64: min. -50 (Bottom) to max. 50 (Top)

Acknowledgement

[r][][Set ID][][OK/NG][Data][x]

14. H Size (Command: f s)

To adjust the screen Horizontal Size.

* This function is available only when the Tile Mode is set to Off.

* The operational range varies depending on the RGB input resolution (Only available for RGB-PC input.)

Transmission

[f][s][][Set ID][][Data][Cr]

Data

00 - 64: Min. -50 (Reduce) - Max. 50 (Expand)

Acknowledgement

[s][][Set ID][][OK/NG][Data][x]

15. Auto Configuration (Command: j u)

To adjust the picture position and minimize image shaking automatically.

(Only available for RGB-PC input.)

Transmission

[j][u][][Set ID][][Data][Cr]

Data

01 : Set

Acknowledgement

[u][][Set ID][][OK/NG][Data][x]

16. Balance (Command: k t)

To adjust the sound balance.

Transmission

[k][t][][Set ID][][Data][Cr]

Data

00 to 64: Left 50 to Right 50

Acknowledgement

[t][][Set ID][][OK/NG][Data][x]

17. Sound Mode (Command: d y)

To adjust the sound mode.

Transmission

[d][y][][Set ID][][Data][Cr]

Data

01: Standard

02: Music

03: Cinema

04: Sport

05: Game

Acknowledgement

[y][][Set ID][][OK/NG][Data][x]

18. Treble (Command: k r)

To adjust the Treble values.

Transmission

[k][r][][Set ID][][Data][Cr]

Data

00 to 64: Treble 0 to 100

Acknowledgement

[r][][Set ID][][OK/NG][Data][x]

19. Bass (Command: k s)

To adjust the Bass values.

Transmission

[k][s][][Set ID][][Data][Cr]

Data

00 to 64: Bass 0 to 100

Acknowledgement

[s][][Set ID][][OK/NG][Data][x]

20. Speaker (Command: d v)

To select the speaker on/off.

Transmission

[d][v][][Set ID][][Data][Cr]

Data

00: Off

01: On

Acknowledgement

[v][][Set ID][][OK/NG][Data][x]

21. Volume Mute (Command: k e)

To control the Volume Mute on/off.

Transmission

[k][e][][Set ID][][Data][Cr]

Data

00 : Mute (Volume Off)

01 : Current volume (Volume On)

Acknowledgement

[e][][Set ID][][OK/NG][Data][x]

22. Volume Control (Command: k f)

To set the playback volume.

Transmission

[k][f][][Set ID][][Data][Cr]

Data

00 to 64: Volume 0 to 100

Acknowledgement

[f][][Set ID][][OK/NG][Data][x]

23. Time 1 (Year/ Month/ Day) (Command: f a)

To set the Time 1 (Year/ Month/ Day) values.

Transmission

[f][a][][Set ID][][Data1][][Data2][][Data3][Cr]

Data1

00 to 14: 2010 to 2030

Data2

01 to 0C: January to December

Data3

01 to 1F: 1 to 31

* Enter "fa [Set ID] ff" for checking Time 1 (Year/ Month/ Day) values.

Acknowledgement

[a][][Set ID][][OK/NG][Data1][Data2][Data3][x]

24. Time 2 (Hour/ Minute/ Second) (Command: f x)

To set the Time 2 (Hour/ Minute/ Second) values.

Transmission

[f][x][][Set ID][][Data1][][Data2][][Data3][Cr]

Data1

00 to 17: 00 to 23 hours

Data2

00 to 3B: 00 to 59 minutes

Data3

00 to 3B: 00 to 59 seconds

* Enter “fx [Set ID] ff” for checking Time 2(Hour/ Minute/ Second) values.

** This command won't work if Time 1(Year/ Month/ Day) has not been set in advance.

Acknowledgement

[x][][Set ID][][OK/NG][Data1][Data2][Data3][x]

25. Off Timer(Repeat Mode/ Time) (Command: f e)

To set the Off Timer(Repeat Mode/ Time) function.

Transmission

[f][e][][Set ID][][Data1][][Data2][][Data3][Cr]

Data1

1. f1h to f7h (Read data)

F1: Read the 1st Off Time data

F2: Read the 2nd Off Time data

F3: Read the 3rd Off Time data

F4: Read the 4th Off Time data

F5: Read the 5th Off Time data

F6: Read the 6th Off Time data

F7: Read the 7th Off Time data

2. e1h-e7h (Delete one index), e0h (Delete all indexes)

E0: Delete all Off Time data

E1: Delete the 1st Off Time data

E2: Delete the 2nd Off Time data

E3: Delete the 3rd Off Time data

E4: Delete the 4th Off Time data

E5: Delete the 5th Off Time data

E6: Delete the 6th Off Time data

E7: Delete the 7th Off Time data

3. 01h to 06h (Set the day of week for Off Time)

00: Off

01: Once

02: Daily

03: Monday to Friday
04: Monday to Saturday
05: Saturday to Sunday
06. Sunday
07. Monday
08. Tuesday
09. Wednesday
0A. Thursday
0B. Friday
0C. Saturday

Data2

00 to 17: 00 to 23 Hours

Data3

00 to 3B: 00 to 59 Minutes

* To read or delete the Off Time list, set FFH for [Data2] and [Data3].

(Example 1: fe 01 f1 ff ff - Read the 1st Off Time data.)

(Example 2: fe 01 e1 ff ff - Delete the 1st Off Time data.)

(Example 3: fe 01 04 02 03 - Set the Off Time to "Monday to Saturday, 02:03".)

* This function is supported only when 1 (Year/Month/ Day) and 2 (Hour/Minute/Second) are set.

Acknowledgement

[e][][Set ID][][OK/NG][Data1][Data2][Data3][x]

26. On Timer(Repeat Mode/ Time) (Command: f d)

To set the On Timer(Repeat mode/ Time) function.

Transmission

[f][d][][Set ID][][Data1][][Data2][][Data3][Cr]

Data1

1. f1h to f7h (Read data)

F1: Read the 1st On Time data

F2: Read the 2nd On Time data

F3: Read the 3rd On Time data

F4: Read the 4th On Time data

F5: Read the 5th On Time data

F6: Read the 6th On Time data

F7: Read the 7th On Time data

2. e1h-e7h (Delete one index), e0h (Delete all indexes)

E0: Delete all Off Time data

E1: Delete the 1st On Time data

E2: Delete the 2nd On Time data

E3: Delete the 3rd On Time data

E4: Delete the 4th On Time data

E5: Delete the 5th On Time data

E6: Delete the 6th On Time data

E7: Delete the 7th On Time data

3. 01h to 06h (Set the day of week for On Time)

00: Off

01: Once

02: Daily

03: Monday to Friday

04: Monday to Saturday

05: Saturday to Sunday

06: Sunday

07: Monday

08: Tuesday

09: Wednesday

0A: Thursday

0B: Friday

0C: Saturday

Data2

00 to 17: 00 to 23 Hours

Data3

00 to 3B: 00 to 59 Minutes

* To read or delete the On Time list, set FFH for [Data2] and [Data3].

(Example 1: fe 01 f1 ff ff - Read the 1st On Time data.)

(Example 2: fe 01 e1 ff ff - Delete the 1st On Time data.)

(Example 3: fe 01 04 02 03 - Set the On Time to "Monday to Saturday, 02:03".)

* This function is supported only when 1 (Year/Month/ Day) and 2 (Hour/Minute/Second) are set.

Acknowledgement

[e][][Set ID][][OK/NG][Data1][Data2][Data3][x]

27. On Timer Input (Command: f u)

To select an external input for the current On Time setting and add a new schedule or change the existing schedule.

Transmission

[f][u][][Set ID][][Data1][Cr]

[f][u][][Set ID][][Data1][Data2][Cr]

Data (Add schedule)

20: Input (AV)

40: Component

60: RGB

90: HDMI (HDMI1)

C0: Display Port

91: HDMI2/SDI

Data1 (Change schedule)

1. f1h to f4h (Read data)

F1: Select the 1st schedule input

F2: Select the 2nd schedule input

F3: Select the 3rd schedule input

F4: Select the 4th schedule input

F5: Select the 5th schedule input

F6: Select the 6th schedule input

F7: Select the 7th schedule input

Data2

20: Input (AV)

40: Component

60: RGB

90: HDMI (HDMI1)

C0: Display Port

91: HDMI2/SDI

* To read the schedule input, enter FFH for [Data2].

(Example 1: fu 01 60 - Move each schedule input down one row and save the 1st schedule input in RGB mode.)

(Example 2: fu 01 f1 ff - Read the 1st schedule input.)

(Example 3: fu 01 f3 20 - Change the 3rd data schedule input to the current On Time and AV input.)

* This function is supported only when 1 (Year/Month/ Day), 2 (Hour/Minute/Second), On Time (Repeat Mode/ Time) are set.

** It may not be supported depending on the model.

Acknowledgement

[u][][Set ID][][OK/NG][Data][x]

[u][][Set ID][][OK/NG][Data1][Data2][x]

28. Sleep Time (Command: f f)

To set the Sleep Time.

Transmission

[f][f][][Set ID][][Data][Cr]

Data

00: Off (Sleep Timer off)

01: 10 min.

02: 20 min.

03: 30 min.

04: 60 min.

05: 90 min.

06: 120 min.

07: 180 min.

08: 240 min.

Acknowledgement

[f][][Set ID][][OK/NG][Data][x]

29. Power On Delay (Command: f h)

To set the schedule delay when the power is turned on. (Unit: Second)

Transmission

[f][h][][Set ID][][Data][Cr]

Data

00 to 64: min. 0 to max. 100 (sec.)

Acknowledgement

[h][][Set ID][][OK/NG][Data][x]

30. Automatic Standby (Command: m n)

To set the Automatic Standby function.

Transmission

[m][n][][Set ID][][Data][Cr]

Data

00: Off (No off after 4 hours)

01: 4 Hours (Off after 4 hours)

Acknowledgement

[n][][Set ID][][OK/NG][Data][x]

31. Auto Off (Command: f g)

To set the Auto Off function.

Transmission

[f][g][][Set ID][][Data][Cr]

Data

00: Off (No off after 15 minutes)

01: 15 min.(Off after 15 minutes)

Acknowledgement

[g][][Set ID][][OK/NG][Data][x]

32. Language (Command: f i)

To set the language for OSD.

Transmission

[f][i][][Set ID][][Data][Cr]

Data

00: Czech

01: Danish

02: German

03: English

04: Spanish (EU)

05: Greek

06: French

07: Italian

08: Dutch

09: Norwegian

0A: Portuguese

0B: Portuguese (BR)

0C: Russian

0D: Finnish

0E: Swedish

0F: Korean

10: Chinese (Mandarin)

11: Japanese

12: Yue Chinese (Cantonese)

Acknowledgement

[i][Set ID][OK/NG][Data][x]

33. ISM mode (Command: j p)

To select ISM method for avoiding having a fixed image remain on screen.

Transmission

[j][p][Set ID][Data][Cr]

Data

01: Inversion

02: Orbiter

04: White Wash

08: Normal

Acknowledgement

[p][Set ID][OK/NG][Data][x]

34. Auto-Switch Input Select (Command: m i)

To set the Auto-Switch Input function.

Transmission

[m][i][Set ID][Data][Cr]

Data

00: Off

01: Auto

02: Manual

Acknowledgement

[i][Set ID][OK/NG][Data][x]

35. Auto-Switch Input Select (Command: m j)

To select the input source for auto switch.

* This command is only available when the Auto-Switch Input (auto) mode is set to Custom.

Transmission

[m][j][Set ID][Data1][Data2][Data3][Cr][Data4][Data5][Cr]

Data

1 to 5 (Priority 1 to 5)

60: RGB

90: HDMI(HDMI1)

C0: Display Port

91: HDMI2/SDI

* The number of data items differs depending on the model.

Acknowledgement

[j][][SetID][][OK/NG][Data1][Data2][Data3][Data4] [][Data5][x]

36. Reset (Command: f k)

To execute the Picture, Screen, Audio and Factory reset function.

Transmission

[f][k][][Set ID][][Data][Cr]

Data

00: Picture Reset

01: Screen Reset

02: Factory Reset

03: Audio Reset

Acknowledgement

[k][][Set ID][][OK/NG][Data][x]

37. Tile Mode (Command: d d)

To set a Tile Mode and Tile Column/ Row values.

Transmission

[d][d][][Set ID][][Data][Cr]

Data

00 to FF: 1st byte - Tile Row

2nd byte - Tile Column

*00, 01, 10, 11 means Tile Mode Off.

Acknowledgement

[d][][Set ID][][OK/NG][Data][x]

** It may not be supported depending on the model.

38. Tile Mode Check (Command: d z)

To check Tile Mode status.

Transmission

[d][z][][Set ID][][Data][Cr]

Data

FF: Check Tile Mode status.

** It may not be supported depending on the model.

Acknowledgement

[z][][Set ID][][OK/NG][Data1][Data2][Data3][x]

Data1 00: Tile Mode Off

01: Tile Mode On

Data2 00 to 0F: Tile Row

Data3 00 to 0F: Tile Column

39. Tile ID (Command: d i)

To set Tile ID.

Transmission

[d][i][][Set ID][][Data][Cr]

Data

01 to E1: Tile ID 01 to 225**

FF: Check Tile ID

** Data could not be set over (Tile Column) x (Tile Row).

** It may not be supported depending on the model.

Acknowledgement

[i][][Set ID][][OK/NG][Data][x]

*NG will be return if data is over (Tile Column) x (Tile Row), except 0xFF.

40. Tile H Position (Command: d e)

To adjust the Tile Horizontal position.

* This function is available only when the Natural option of the Tile Mode is set to Off while the Tile Mode set to On.

Transmission

[d][e][][Set ID][][Data][Cr]

Data

00 to 32: -50 (Left) to 0 (Right)

*Left/Right values depend on Tile H size.

** It may not be supported depending on the model.

Acknowledgement

[e][][Set ID][][OK/NG][Data][x]

41. Tile V Position (Command: d f)

To adjust the Tile Vertical position.

* This function is available only when the Natural option of the Tile Mode is set to Off while the Tile Mode set to On.

Transmission

[d][f][][Set ID][][Data][Cr]

Data

0 to 32: 0 (Bottom) to 50 (Top)

* Bottom/Top values depend on Tile Vertical size.

** It may not be supported depending on the model.

Acknowledgement

[f][][Set ID][][OK/NG][Data][x]

42. Tile H Size (Command: d g)

To adjust the Tile Horizontal size.

*Set Tile H Position to 0x32 before setting Tile H Size.

* This function is available only when the Natural option of the Tile Mode is set to Off while the Tile Mode set to On.

Transmission

[d][g][][Set ID][][Data][Cr]

Data

00 to 32: 0 to 50

Acknowledgement

[g][][Set ID][][OK/NG][Data][x]

43. Tile V Size (Command: d h)

To adjust the Tile Vertical size.

*Set Tile V Position to 0x00 before setting Tile V Size.

* This function is available only when the Natural option of the Tile Mode is set to Off while the Tile Mode set to On.

Transmission

[d][h][][Set ID][][Data][Cr]

Data

00 to 32: 0 to 50

** It may not be supported depending on the model.

Acknowledgement

[h][][Set ID][][OK/NG][Data][x]

44. Natural Mode (In Tile Mode) (Command : d j)

To display the image naturally, the part of the image that would normally be displayed in the gap between the displays is omitted.

Transmission

[d][j][][Set ID][][Data][Cr]

Data

00: Off

01: On

Acknowledgement

[j][][Set ID][][OK/NG][Data][x]

45. DPM Select (Command: f j)

To set the DPM (Display Power Management) function.

Transmission

[f][j][][Set ID][][Data][Cr]

Data

00: Off

01: On

Acknowledgement

[j][][Set ID][][OK/NG][Data][x]

46. Temperature Value (Command: d n)

To check the inside temperature value.

Transmission

[d][n][][Set ID][][Data][Cr]

Data

FF: Check the status

Acknowledgement

[n][][Set ID][][OK/NG][Data][x]

* Temperature is displayed in hexadecimal.

47. Remote Controller Lock/ Key Lock (Command: k m)

When the remote control and front keys are locked in standby mode, the power cannot be turned on using the remote control or front power button.

Transmission

[k][m][][Set ID][][Data][Cr]

Data

00: Off (Lock Off)

01: On (Lock On)

* Display will not be turned on by power on key of remote controller and front panel control keys, if key is locked on in standby mode.

Acknowledgement

[m][][Set ID][][OK/NG][Data][x]

48. Key (Command: m c)

To send a key code of the IR remote control.

Transmission

[m][c][][Set ID][][Data][Cr]

Data

IR_KEY_CODE

Acknowledgement

[c][][Set ID][][OK/NG][Data][x]

For a key code, see the IR Code.

* Some key codes are not supported depending on the model.

49. OSD Select (Command: k l)

To select OSD (On Screen Display) on/off.

Transmission

[k][l][][Set ID][][Data][Cr]

Data

00: Off

01: On

Acknowledgement

[l][][Set ID][][OK/NG][Data][x]

50. Elapsed time return (Command: d l)

To check the panel used time.

Transmission

[d][l][][Set ID][][Data][Cr]

Data

FF: Read the status

Acknowledgement

[l][][Set ID][][OK/NG][Data][x]

* Returned data means used hours in hexadecimal.

51. Serial No. Check (Command: f y)

To check the Serial Numbers.

Transmission

[f][y][][Set ID][][Data][Cr]

Data

FF: Check the product Serial Number

Acknowledgement

[y][][Set ID][][OK/NG][Data][x]

* Data is ASCII code.

52. S/W Version (Command: f z)

To check the Software Version.

Transmission

[f][z][][Set ID][][Data][Cr]

Data

FF: Check the Software version

Acknowledgement

[z][][Set ID][][OK/NG][Data][x]

53. White Balance Red Gain (Command: j m)

To set the White Balance Red Gain.

Transmission

[j][m][][Set ID][][Data][Cr]

Data

00 to FE: Red Gain 0 to 254

Acknowledgement

[m][][Set ID][][OK/NG][Data][x]

54. White Balance Green Gain (Command: j n)

To set the White Balance Green Gain.

Transmission

[j][n][][Set ID][][Data][Cr]

Data

00 to FE: Green Gain 0 to 254

Acknowledgement

[n][][Set ID][][OK/NG][Data][x]

55. White Balance Blue Gain (Command: j o)

To set the White Balance Blue Gain.

Transmission

[j][o][][Set ID][][Data][Cr]

Data

00 to FE: Blue Gain 0 to 254

Acknowledgement

[o][][Set ID][][OK/NG][Data][x]

56. Backlight (Command: m g)

To adjust the screen backlight.

Transmission

[m][g][][Set ID][][Data][Cr]

Data

00 to 64: Backlight 0 to 100

Acknowledgement

[g][][set ID][][OK/NG][Data][x]

** It may not be supported depending on the model.