



# User Guide

© Copyright 2014 Hewlett-Packard Development Company, L.P.

AMD is a trademark of Advanced Micro Devices, Inc. Intel is a trademark of Intel Corporation in the U.S. and other countries. Microsoft and Windows are U.S. registered trademarks of the Microsoft group of companies.

The information contained herein is subject to change without notice. The only warranties for HP products and services are set forth in the express warranty statements accompanying such products and services. Nothing herein should be construed as constituting an additional warranty. HP shall not be liable for technical or editorial errors or omissions contained herein.

Second Edition: November 2014

First Edition: May 2014

Document Part Number: 779499-002

### Product notice

This guide describes features that are common to most models. Some features may not be available on your computer.

Not all features are available in all editions of Windows. This computer may require upgraded and/or separately purchased hardware, drivers and/or software to take full advantage of Windows functionality. Go to <http://www.microsoft.com> for details.

To access the latest user guide, go to <http://www.hp.com/support>, and select your country. Select **Drivers & Downloads**, and then follow the on-screen instructions.

### Software terms

By installing, copying, downloading, or otherwise using any software product preinstalled on this computer, you agree to be bound by the terms of the HP End User License Agreement (EULA). If you do not accept these license terms, your sole remedy is to return the entire unused product (hardware and software) within 14 days for a full refund subject to the refund policy of your seller.

For any further information or to request a full refund of the price of the computer, please contact your seller.

## Safety warning notice

---

 **WARNING!** To reduce the possibility of heat-related injuries or of overheating the computer, do not place the computer directly on your lap or obstruct the computer air vents. Use the computer only on a hard, flat surface. Do not allow another hard surface, such as an adjoining optional printer, or a soft surface, such as pillows or rugs or clothing, to block airflow. Also, do not allow the AC adapter to come into contact with the skin or a soft surface, such as pillows or rugs or clothing, during operation. The computer and the AC adapter comply with the user-accessible surface temperature limits defined by the International Standard for Safety of Information Technology Equipment (IEC 60950).

---



## Processor configuration setting (select models only)

---

 **IMPORTANT:** Select computer models are configured with an Intel® Pentium® N35xx series or a Celeron® N28xx/N29xx series processor and a Windows® operating system. Do not change the processor configuration setting in msconfig.exe from 4 or 2 processors to 1 processor. If you do so, your computer will not restart. You will have to perform a factory reset to restore the original settings.

---



---

# Table of contents

<b>1 Starting right</b> .....	<b>1</b>
Visit the HP Apps Store .....	1
Best practices .....	1
Fun things to do .....	1
More HP resources .....	3
<b>2 Getting to know your computer</b> .....	<b>5</b>
Finding your hardware and software information .....	5
Locating hardware .....	5
Locating software .....	5
Right side .....	6
Left side .....	7
Display .....	8
Top .....	9
TouchPad .....	9
Lights .....	10
Buttons and speakers .....	11
Keys .....	12
Bottom .....	13
Labels .....	14
<b>3 Connecting to a network</b> .....	<b>15</b>
Connecting to a wireless network .....	15
Using the wireless controls .....	15
Using the wireless button .....	15
Using operating system controls .....	15
Sharing data and drives and accessing software .....	16
Using a WLAN .....	16
Using an Internet service provider .....	16
Setting up a WLAN .....	17
Configuring a wireless router .....	17
Protecting your WLAN .....	17
Connecting to a WLAN .....	18
Connecting to a wired network .....	18
Connecting to a local area network (LAN) .....	18

<b>4 Enjoying entertainment features</b>	<b>20</b>
Multimedia features	20
Using the webcam	21
Using audio	21
Connecting speakers	22
Connecting headphones and microphones	22
Using Beats Audio	22
Accessing Beats Audio Control Panel	22
Enabling and disabling Beats Audio	22
Testing your audio features	22
Using video	23
Connecting video devices by using an HDMI cable	23
Setting up HDMI audio	24
Discovering and connecting to Miracast-compatible wireless displays (select AMD models only)	24
Discovering and connecting to Miracast-compatible wireless displays (select Intel models only)	24
<b>5 Navigating the screen</b>	<b>26</b>
Using the TouchPad and gestures	26
Tapping	27
Scrolling	28
2-finger pinch zoom	29
2-finger click	30
Rotating (select models only)	31
Edge swipes	32
Display and select a charm	32
Display the Customize icon	33
Switch between open apps	34
Using touch screen gestures (select models only)	34
One-finger slide	34
Tapping	36
Scrolling	36
2-finger pinch zoom	37
Rotating (select models only)	37
Edge swipes	38
Right-edge swipe	38
Left-edge swipe	38
Top-edge swipe and bottom-edge swipe	39
Using the keyboard and mouse	39
Using the keys	39



Using the action keys .....	39
Using Windows shortcut keys .....	40
Using the hot keys .....	40
<b>6 Managing power .....</b>	<b>42</b>
Initiating Sleep and Hibernation .....	42
Manually initiating and exiting Sleep .....	43
Manually initiating and exiting Hibernation (select models only) .....	43
Setting password protection on wakeup .....	43
Using the power meter and power settings .....	44
Running on battery power .....	44
User-replaceable battery .....	44
Finding battery information .....	45
Conserving battery power .....	45
Identifying low battery levels .....	45
Resolving a low battery level .....	46
Resolving a low battery level when external power is available .....	46
Resolving a low battery level when no power source is available .....	46
Resolving a low battery level when the computer cannot exit Hibernation .....	46
Storing a user-replaceable battery .....	46
Disposing of a user-replaceable battery .....	46
Replacing a user-replaceable battery .....	47
Running on external AC power .....	47
Troubleshooting power problems .....	47
HP CoolSense .....	48
Refreshing your software content with Intel Smart Connect Technology (select models only) .....	48
Shutting down (turning off) the computer .....	48
Hybrid Graphics and AMD Dual Graphics (select models only) .....	49
Using Hybrid Graphics (select models only) .....	49
Using AMD Dual Graphics (select models only) .....	50
<b>7 Maintaining your computer .....</b>	<b>51</b>
Improving performance .....	51
Handling drives .....	51
Using HP 3D DriveGuard (select models only) .....	51
Identifying HP 3D DriveGuard status .....	52
Using Disk Defragmenter .....	52
Using Disk Cleanup .....	52
Adding or replacing memory modules .....	52
Updating programs and drivers .....	55
Cleaning your computer .....	55

Cleaning procedures .....	56
Cleaning the display (All-in-Ones or Notebooks) .....	56
Cleaning the sides or cover .....	56
Cleaning the TouchPad, keyboard, or mouse .....	56
Traveling with or shipping your computer .....	57
<b>8 Securing your computer and information .....</b>	<b>58</b>
Using passwords .....	58
Setting Windows passwords .....	59
Setting Setup Utility (BIOS) passwords .....	59
Using Internet security software .....	59
Using antivirus software .....	60
Using firewall software .....	60
Installing software updates .....	60
Installing critical security updates .....	60
Installing HP and third-party software updates .....	60
Securing your wireless network .....	61
Backing up your software applications and information .....	61
Using an optional security cable lock .....	61
<b>9 Using Setup Utility (BIOS) and HP PC Hardware Diagnostics (UEFI) .....</b>	<b>62</b>
Starting Setup Utility (BIOS) .....	62
Updating the BIOS .....	62
Determining the BIOS version .....	62
Downloading a BIOS update .....	63
Using HP PC Hardware Diagnostics (UEFI) .....	63
Downloading HP PC Hardware Diagnostics (UEFI) to a USB device .....	64
<b>10 Backing up, restoring, and recovering .....</b>	<b>65</b>
Creating recovery media and backups .....	65
Creating HP Recovery media .....	65
Restore and recovery .....	66
Recovering using HP Recovery Manager .....	67
What you need to know .....	67
Using the HP Recovery partition (select models only) .....	67
Using HP Recovery media to recover .....	68
Changing the computer boot order .....	68
Removing the HP Recovery partition (select models only) .....	68

<b>11 Specifications</b> .....	<b>69</b>
Input power .....	69
Operating environment .....	69
<b>12 Electrostatic Discharge</b> .....	<b>71</b>
<b>13 Accessibility</b> .....	<b>72</b>
Supported assistive technologies .....	72
Contacting support .....	72
<b>Index</b> .....	<b>73</b>



---

# 1 Starting right

This computer is a powerful tool designed to enhance your work and entertainment. Read this chapter to learn about best practices after you set up your computer, fun things to do with your computer, and where to find additional HP resources.

## Visit the HP Apps Store

The HP Apps Store offers a wide choice of popular games, entertainment and music apps, productivity apps, and apps exclusive to HP that you can download to the Start screen. The selection is updated regularly and includes regional content and country-specific offers. Be sure to check the HP Apps Store frequently for new and updated features.

---

 **IMPORTANT:** You must be connected to the Internet to access the HP Apps Store.

 **NOTE:** **HP Picks** is available in select countries only.

---

To view and download an app:

1. From the Start screen, select the **Store** app.
2. Select **HP picks** to view all the available apps.
3. Select the app you want to download, and then follow the on-screen instructions. When the download is complete, the app appears on the All apps screen.

## Best practices

After you set up and register the computer, we recommend the following steps to get the most out of your smart investment:

- If you haven't already done so, connect to a wired or wireless network. See details in [Connecting to a network on page 15](#).
- Become familiar with the computer hardware and software. For more information, see [Getting to know your computer on page 5](#) and [Enjoying entertainment features on page 20](#).
- Update or purchase antivirus software. See [Using antivirus software on page 60](#).
- Back up your hard drive by creating recovery discs or a recovery flash drive. See [Backing up, restoring, and recovering on page 65](#).

## Fun things to do

- You know that you can watch a YouTube video on the computer. But did you know that you can also connect your computer to a TV or gaming console? For more information, see [Connecting video devices by using an HDMI cable on page 23](#).
- You know that you can listen to music on the computer. But did you know that you can also stream live radio to the computer and listen to music or talk radio from all over the world? See [Using audio on page 21](#).

- Experience music the way the artist intended, with deep controlled bass and clear, pure sound. See [Using Beats Audio on page 22](#).
- Use the TouchPad and the new Windows® touch gestures for smooth control of images and pages of text. See [Using the TouchPad and gestures on page 26](#).

## More HP resources

You have already used *Setup Instructions* to turn on the computer and locate this guide. To locate resources that provide product details, how-to information, and more, use this table.

Resource	Contents
<i>Setup Instructions</i>	<ul style="list-style-type: none"><li>• Overview of computer setup and features</li></ul>
Help and Support  To access Help and Support, from the Start screen, type <code>help</code> , and then from the Search window, select <b>Help and Support</b> . For U.S. support, go to <a href="http://www.hp.com/go/contactHP">http://www.hp.com/go/contactHP</a> . For worldwide support, go to <a href="http://welcome.hp.com/country/us/en/wwcontact_us.html">http://welcome.hp.com/country/us/en/wwcontact_us.html</a> .	<ul style="list-style-type: none"><li>• A broad range of how-to information and troubleshooting tips</li></ul>
Worldwide support  To get support in your language, go to <a href="http://welcome.hp.com/country/us/en/wwcontact_us.html">http://welcome.hp.com/country/us/en/wwcontact_us.html</a> .	<ul style="list-style-type: none"><li>• Online chat with an HP technician</li><li>• Support telephone numbers</li><li>• HP service center locations</li></ul>
<i>Safety &amp; Comfort Guide</i>  To access this guide: <ol style="list-style-type: none"><li>1. From the Start screen, type <code>support</code>, and then select the <b>HP Support Assistant</b> app.</li><li>2. Select <b>My computer</b>, and then select <b>User guides</b>.</li></ol> <p>– or –</p> Go to <a href="http://www.hp.com/ergo">http://www.hp.com/ergo</a> .	<ul style="list-style-type: none"><li>• Proper workstation setup</li><li>• Guidelines for posture and work habits that increase your comfort and decrease your risk of injury</li><li>• Electrical and mechanical safety information</li></ul>
<i>Regulatory, Safety and Environmental Notices</i>  To access this guide: <p>▲ From the Start screen, type <code>support</code>, and then select the <b>HP Support Assistant</b> app.</p>	<ul style="list-style-type: none"><li>• Important regulatory notices, including proper battery disposal information</li></ul>
<i>Limited Warranty*</i>  To access this guide: <ol style="list-style-type: none"><li>1. From the Start screen, type <code>support</code>, and then select the <b>HP Support Assistant</b> app.</li><li>2. Select <b>My computer</b>, and then select <b>Warranty and services</b>.</li></ol> <p>– or –</p> Go to <a href="http://www.hp.com/go/orderdocuments">http://www.hp.com/go/orderdocuments</a> .	<ul style="list-style-type: none"><li>• Specific warranty information about this computer</li></ul>

\*You can find the expressly provided HP Limited Warranty applicable to your product located with the user guides on your computer and/or on the CD/DVD provided in the box. In some countries/regions, HP may provide a printed HP Limited Warranty in the box. For countries/regions where the warranty is not provided in printed format, you may request a printed copy from <http://www.hp.com/go/orderdocuments> or write to:

- **North America:** Hewlett-Packard, MS POD, 11311 Chinden Blvd., Boise, ID 83714, USA
- **Europe, Middle East, Africa:** Hewlett-Packard, POD, Via G. Di Vittorio, 9, 20063, Cernusco s/Naviglio (MI), Italy
- **Asia Pacific:** Hewlett-Packard, POD, P.O. Box 200, Alexandra Post Office, Singapore 911507

---

**Resource****Contents**

---

When you request a printed copy of your warranty, please include your product number, warranty period (found on your service label), name, and postal address.

**IMPORTANT:** Do NOT return your HP product to the addresses above. For U.S. support, go to <http://www.hp.com/go/contactHP>. For worldwide support, go to [http://welcome.hp.com/country/us/en/wwcontact\\_us.html](http://welcome.hp.com/country/us/en/wwcontact_us.html).

---



---

## 2 Getting to know your computer

### Finding your hardware and software information

#### Locating hardware

To find out what hardware is installed on your computer:

1. From the Start screen, type `control panel`, and then select **Control Panel**.
2. Select **System and Security**, select **System**, and then click **Device Manager** in the left column.

A list displays all the devices installed on your computer.

To find out information about system hardware components and the system BIOS version number, press `fn+esc`.





#### Locating software

To find out what software is installed on your computer:

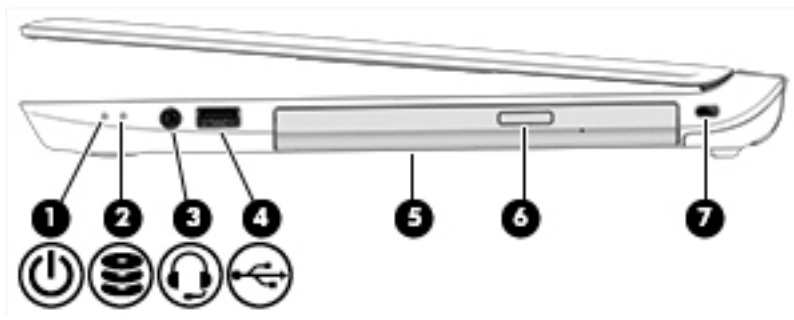
- ▲ From the Start screen, click the down arrow in the lower-left corner of the screen.

## Right side





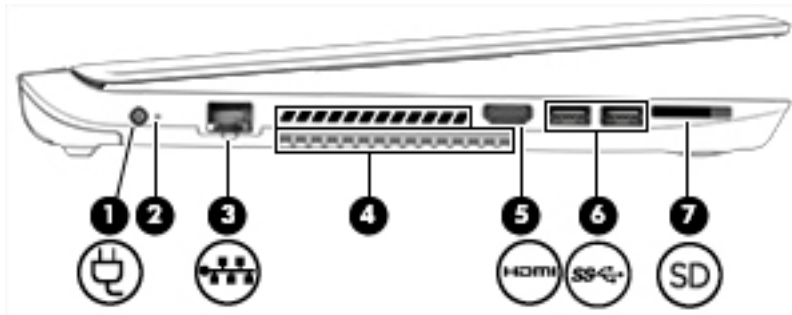

Component	Description
(1)  Power light	<ul style="list-style-type: none"> <li>On: The computer is on.</li> <li>Blinking: The computer is in the Sleep state, a power-saving state. The computer shuts off power to the display and other unneeded components.</li> <li>Off: The computer is off or in Hibernation. Hibernation is a power-saving state that uses the least amount of power.</li> </ul>
(2)  Hard drive light	<ul style="list-style-type: none"> <li>Blinking white: The hard drive is being accessed.</li> <li>Amber: HP 3D DriveGuard has temporarily parked the hard drive.</li> </ul> <p><b>NOTE:</b> For information about HP 3D DriveGuard, see <a href="#">Using HP 3D DriveGuard (select models only) on page 51</a>.</p>
(3)  Audio-out (headphone)/Audio-in (microphone) jack	<p>Connects optional powered stereo speakers, headphones, earbuds, a headset, or a television audio cable. Also connects an optional headset microphone. This jack does not support optional microphone-only devices.</p> <p><b>WARNING!</b> To reduce the risk of personal injury, adjust the volume before putting on headphones, earbuds, or a headset. For additional safety information, refer to the <i>Regulatory, Safety, and Environmental Notices</i>. To access this guide, from the Start screen, type <code>support</code>, and then select the <b>HP Support Assistant</b> app.</p> <p><b>NOTE:</b> When a device is connected to the jack, the computer speakers are disabled.</p> <p><b>NOTE:</b> Be sure that the device cable has a 4-conductor connector that supports both audio-out (headphone) and audio-in (microphone).</p>
(4)  USB 2.0 port	<p>Connects an optional USB device, such as a keyboard, mouse, external drive, printer, scanner or USB hub.</p>
(5) Optical drive	<p>Depending on your computer model, reads an optical disc or reads and writes to an optical disc.</p> <p><b>NOTE:</b> For disc compatibility information, go to the Help and Support web page (see <a href="#">More HP resources on page 3</a>). Follow the web page instructions to select your computer model. Select <b>Drivers &amp; Downloads</b>, and then follow the on-screen instructions.</p>

Component		Description
(6)	Optical drive eject button	Releases the disc tray.
(7)	 Security cable slot	Attaches an optional security cable to the computer.  <b>NOTE:</b> The security cable is designed to act as a deterrent, but it may not prevent the computer from being mishandled or stolen.

## Left side



Component		Description
(1)	Power connector	Connects an AC adapter.
(2)	AC adapter light	<ul style="list-style-type: none"> <li>On: The AC adapter is connected and the battery is charged.</li> <li>Off: The computer is using battery power.</li> </ul>
(3)	 RJ-45 (network) jack	Connects a network cable.
(4)	Vents (2)	Enable airflow to cool internal components.  <b>NOTE:</b> The computer fan starts up automatically to cool internal components and prevent overheating. It is normal for the internal fan to cycle on and off during routine operation.
(5)	 HDMI port	Connects an optional video or audio device, such as a high-definition television, any compatible digital or audio component, or a high-speed HDMI device.
(6)	 USB 3.0 ports (2)	Connect an optional USB device, such as a keyboard, mouse, external drive, printer, scanner or USB hub.
(7)	 Memory card reader	<p>Reads optional memory cards that store, manage, share, or access information.</p> <p>To insert a card:</p> <p>Hold the card label-side up, with connectors facing the slot, insert the card into the slot, and then push in on the card until it is firmly seated.</p> <p>To remove a card:</p> <p>Press in on the card it until it pops out.</p>

## Display



Component	Description
(1) Internal display switch	Turns off the display and initiates Sleep if the display is closed while the power is on.  <b>NOTE:</b> The internal display switch is not visible from the outside of the computer.
(2) WLAN antennas* (select models only)	Send and receive wireless signals to communicate with wireless local area networks (WLANs).
(3) WLAN antennas*	Send and receive wireless signals to communicate with wireless local area networks (WLANs).
(4) Internal microphones	Record sound.
(5) Webcam light	On: The webcam is in use.
(6) Webcam	Records video and captures photographs. Some models allow you to video conference and chat online using streaming video.  To use the webcam, from the Start screen, type <code>camera</code> , and then select <b>Camera</b> from the list of applications.

\*The antennas are not visible from the outside of the computer. For optimal transmission, keep the areas immediately around the antennas free from obstructions. For wireless regulatory notices, see the section of the *Regulatory, Safety, and Environmental Notices* that applies to your country or region. To access this guide, from the Start screen, type `support`, and then select the **HP Support Assistant** app.

# Top

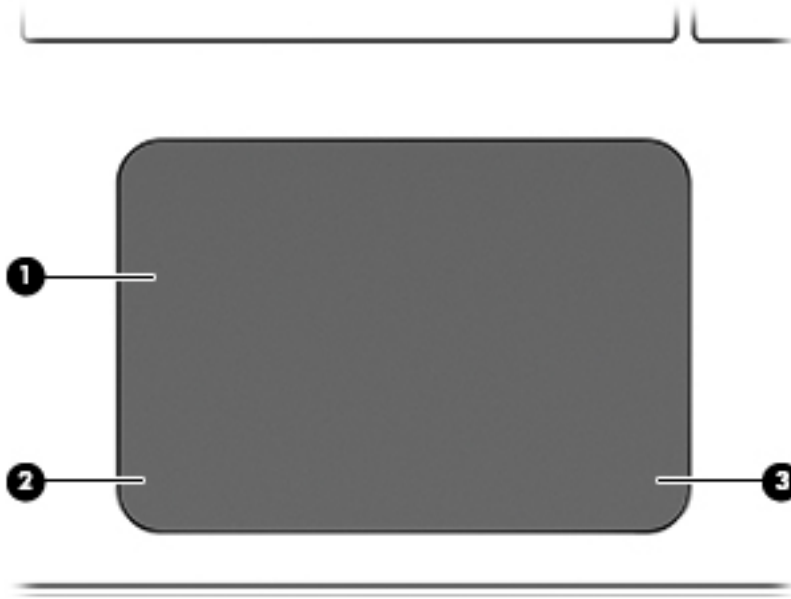

## TouchPad

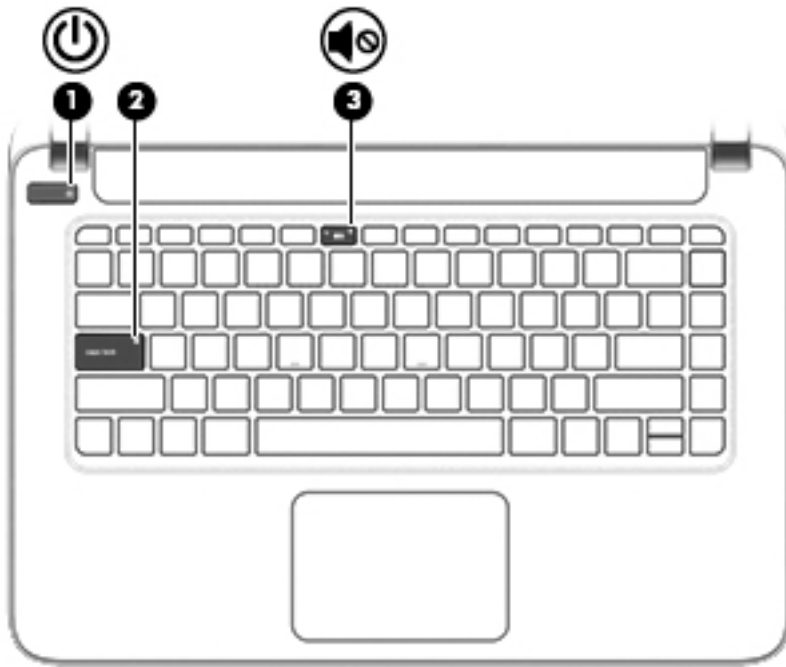

Component	Description
(1) TouchPad zone	Reads your finger gestures to move the pointer or activate items on the screen. <b>NOTE:</b> The TouchPad also supports edge-swipe gestures. For more information, see <a href="#">Edge swipes on page 32</a> .
(2) Left TouchPad button	Functions like the left button on an external mouse.
(3) Right TouchPad button	Functions like the right button on an external mouse.

## Lights



Component	Description
(1)  Power light	<ul style="list-style-type: none"><li>• On: The computer is on.</li><li>• Blinking: The computer is in the Sleep state, a power-saving state. The computer shuts off power to the display and other unneeded components.</li><li>• Off: The computer is off or in Hibernation. Hibernation is a power-saving state that uses the least amount of power.</li></ul>
(2) Caps lock light	On: Caps lock is on, which switches the keys to all capital letters.
(3)  Mute light	<ul style="list-style-type: none"><li>• Amber: Computer sound is off.</li><li>• Off: Computer sound is on.</li></ul>

## Buttons and speakers

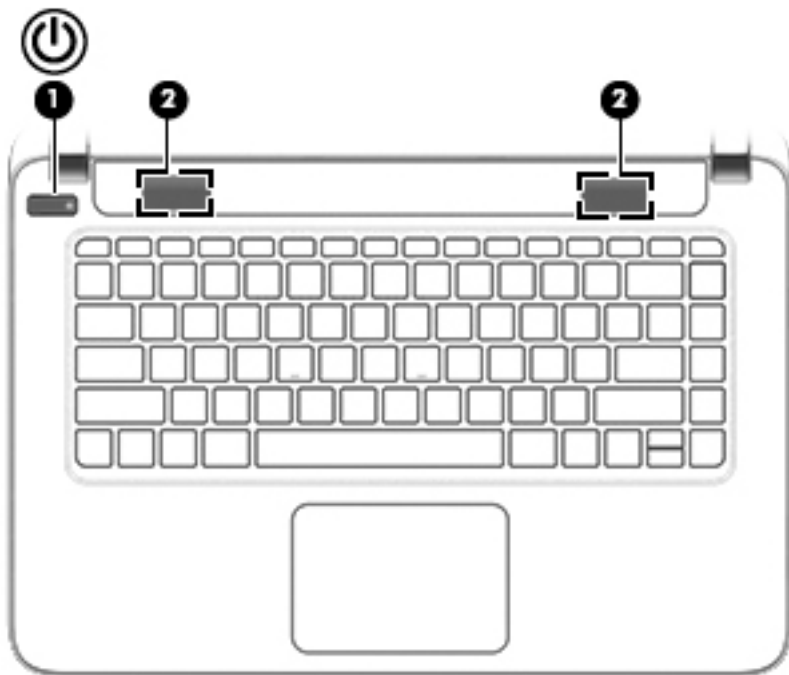

Component	Description
(1)  Power button	<ul style="list-style-type: none"><li>• When the computer is off, press the button to turn on the computer.</li><li>• When the computer is on, press the button briefly to initiate Sleep.</li><li>• When the computer is in the Sleep state, press the button briefly to exit Sleep.</li><li>• When the computer is in Hibernation, press the button briefly to exit Hibernation.</li></ul> <p><b>CAUTION:</b> Pressing and holding down the power button will result in the loss of unsaved information.</p> <p>If the computer has stopped responding and Windows shutdown procedures are ineffective, press and hold the power button down for at least 5 seconds to turn off the computer.</p> <p>To learn more about your power settings, see your power options. From the Start screen, type <code>power</code>, select <b>Power and sleep settings</b>, and then select <b>Power and sleep</b> from the list of applications.</p>
(2) Speakers	Produce sound.

## Keys

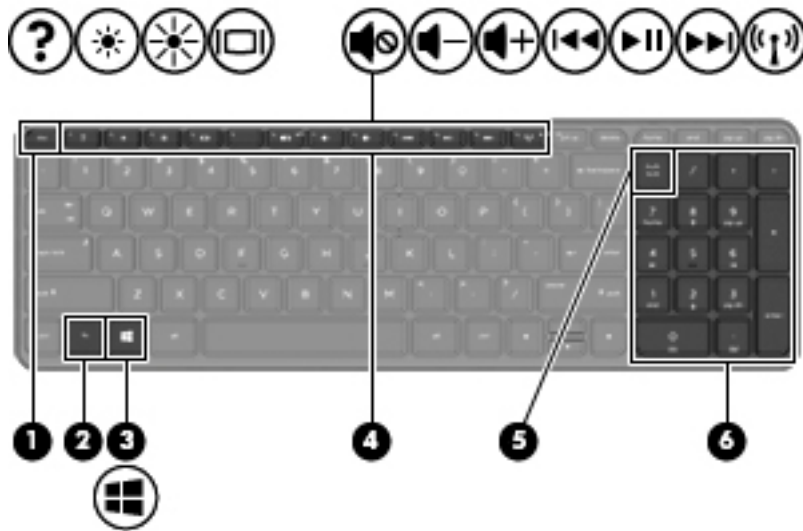





Component	Description
(1) <code>esc</code> key	Displays system information when pressed in combination with the <code>fn</code> key.
(2) <code>fn</code> key	Executes frequently used system functions when pressed in combination with the <code>esc</code> key, or on select models, the <code>b</code> key or the <code>spacebar</code> .
(3)  Windows key	Returns you to the Start screen from an open app or the Windows desktop.  <b>NOTE:</b> Pressing the Windows key again will return you to the previous screen.
(4) Action keys	Execute frequently used system functions.  <b>NOTE:</b> On select models, the <code>f5</code> action key turns the radiance backlight keyboard feature off or on.

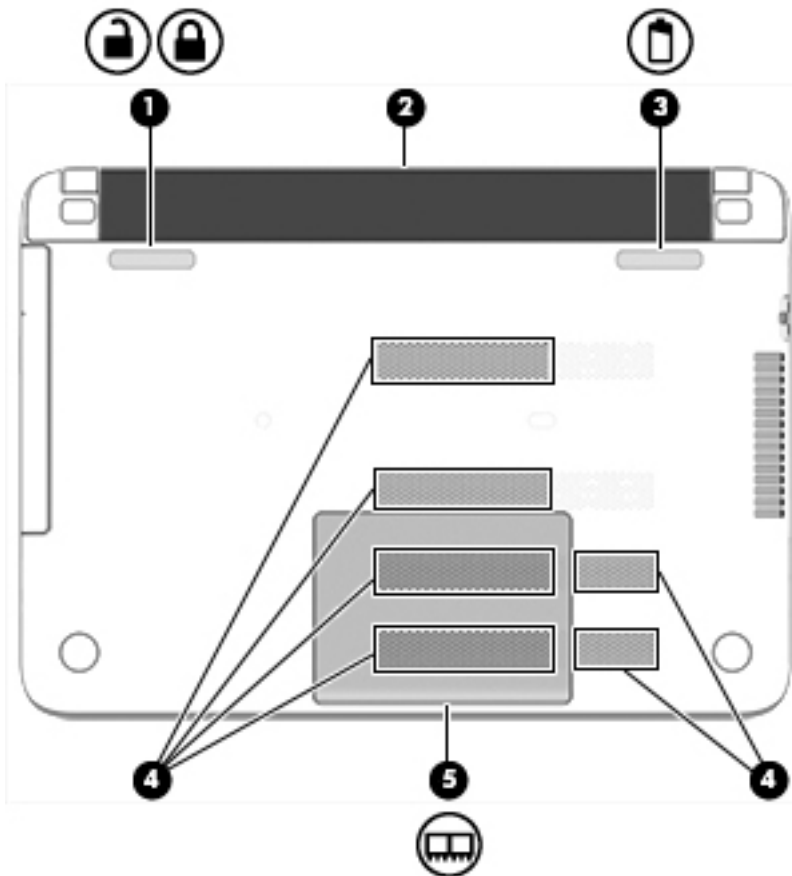

## Bottom



Component	Description
(1) 	Battery lock Locks the battery in the battery bay.
	
(2)	Battery bay Holds the battery.
(3) 	Battery release latch Releases the battery.
(4)	Vents (6) Enable airflow to cool internal components.  <b>NOTE:</b> The computer fan starts up automatically to cool internal components and prevent overheating. It is normal for the internal fan to cycle on and off during routine operation.
(5) 	Service door Provides access to the memory module slots.

# Labels

The labels affixed to the computer provide information you may need when you troubleshoot system problems or travel internationally with the computer.

 **IMPORTANT:** All labels described in this section will be located in one of 3 places depending on your computer model: affixed to the bottom of the computer, located in the battery bay, or under the service door.

- Service label—Provides important information to identify your computer. When contacting support, you will probably be asked for the serial number, and possibly for the product number or the model number. Locate these numbers before you contact support.

Your service label will resemble one of the examples shown below. Refer to the illustration that most closely matches the service label on your computer.



---

## Component

---

- (1) Serial number
  - (2) Product number
  - (3) Warranty period
  - (4) Model number (select models only)
- 

- Microsoft Certificate of Authenticity label (select models only prior to Windows 8)—Contains the Windows Product Key. You may need the Product Key to update or troubleshoot the operating system. HP platforms preinstalled with Windows 8 or Windows 8.1 do not have the physical label, but have a Digital Product Key electronically installed.

 **NOTE:** This Digital Product Key is automatically recognized and activated by Microsoft Operating Systems on a reinstall of the Windows 8 or Windows 8.1 operating system with HP-approved recovery methods.

- Regulatory label(s)—Provide(s) regulatory information about the computer.
- Wireless certification label(s)—Provide(s) information about optional wireless devices and the approval markings for the countries or regions in which the devices have been approved for use.

---

## 3 Connecting to a network

Your computer can travel with you wherever you go. But even at home, you can explore the globe and access information from millions of websites using your computer and a wired or wireless network connection. This chapter will help you get connected to that world.

### Connecting to a wireless network

Wireless technology transfers data across radio waves instead of wires. Your computer may be equipped with one or more of the following wireless devices:

- Wireless local area network (WLAN) device—Connects the computer to wireless local area networks (commonly referred to as Wi-Fi networks, wireless LANs, or WLANs) in corporate offices, your home, and public places such as airports, restaurants, coffee shops, hotels, and universities. In a WLAN, the mobile wireless device in your computer communicates with a wireless router or a wireless access point.

For more information about wireless technology, the Internet, and networking, see the information and website links provided in Help and Support. From the Start screen, type `help`, and then select **Help and Support**.

### Using the wireless controls

You can control the wireless devices in your computer using one or more of these features:

- Wireless button, wireless switch, wireless key, or airplane mode key (referred to in this chapter as the wireless button) (select models only)
- Operating system controls

### Using the wireless button

The computer has a wireless button, one or more wireless devices, and, on select models, one or two wireless lights. All the wireless devices on your computer are enabled at the factory, and if your computer has a wireless light, the wireless light is on (white) when you turn on the computer.

The wireless light indicates the overall power state of your wireless devices, not the status of individual devices. If the wireless light is white, at least one wireless device is on. If the wireless light is off, all wireless devices are off.



**NOTE:** On some models, the wireless light is amber when all wireless devices are off.

Because the wireless devices are enabled at the factory, you can use the wireless button to turn on or turn off the wireless devices simultaneously.

### Using operating system controls

The Network and Sharing Center allows you to set up a connection or network, connect to a network, and diagnose and repair network problems.

To use operating system controls:

1. From the Start screen, type `control panel`, and then select **Control Panel**.
2. Select **Network and Internet**, and then select **Network and Sharing Center**.

For more information, from the Start screen, type `help`, and then select **Help and Support**.

## Sharing data and drives and accessing software

When your computer is part of a network, you are not limited to using only the information that is stored in your computer. Network computers can exchange software and data with each other.



**NOTE:** When a disc like a DVD movie or game is copy-protected, it cannot be shared.

To share folders or content on the same network:

1. From the Windows desktop, open **File Explorer**.
2. From **This PC**, click a folder with content you want to share. Select **Share** from the navigation bar at the top of the window, and then click **Specific people**.
3. Type a name in the **File Sharing** box, and then click **Add**.
4. Click **Share** and then follow the on-screen instructions.

To share drives on the same network:

1. From the Windows desktop, right-click the network status icon in the notification area, at the far right of the taskbar.
2. Select **Open Network and Sharing Center**.
3. Under **View your active networks**, select an active network.
4. Select **Change advanced sharing settings** to set sharing options for privacy, network discovery, file and printer sharing or other network options.

## Using a WLAN

With a WLAN device, you can access a wireless local area network (WLAN), which is composed of other computers and accessories that are linked by a wireless router or a wireless access point.



**NOTE:** The terms *wireless router* and *wireless access point* are often used interchangeably.

- A large-scale WLAN, such as a corporate or public WLAN, typically uses wireless access points that can accommodate a large number of computers and accessories and can separate critical network functions.
- A home or small office WLAN typically uses a wireless router, which allows several wireless and wired computers to share an Internet connection, a printer, and files without requiring additional pieces of hardware or software.

To use the WLAN device in your computer, you must connect to a WLAN infrastructure (provided through a service provider or a public or corporate network).

## Using an Internet service provider

When you are setting up Internet access in your home, you must establish an account with an Internet service provider (ISP). To purchase Internet service and a modem, contact a local ISP. The ISP will help set up the modem, install a network cable to connect your wireless router to the modem, and test the Internet service.

---

 **NOTE:** Your ISP will give you a user ID and a password to use for Internet access. Record this information and store it in a safe place.

---

## Setting up a WLAN

To set up a WLAN and connect to the Internet, you need the following equipment:

- A broadband modem (either DSL or cable) **(1)** and high-speed Internet service purchased from an Internet service provider
- A wireless router **(2)** (purchased separately)
- A wireless computer **(3)**

---

 **NOTE:** Some modems have a built-in wireless router. Check with your ISP to determine what type of modem you have.

---

The illustration below shows an example of a wireless network installation that is connected to the Internet.



As your network grows, additional wireless and wired computers can be connected to the network to access the Internet.

For help in setting up your WLAN, see the information provided by your router manufacturer or your ISP.

## Configuring a wireless router

For help in configuring a wireless router, see the information provided by your router manufacturer or your ISP.

---

 **NOTE:** It is recommended that you initially connect your new wireless computer to the router by using the network cable provided with the router. When the computer successfully connects to the Internet, disconnect the cable, and access the Internet through your wireless network.

---

## Protecting your WLAN

When you set up a WLAN or access an existing WLAN, always enable security features to protect your network from unauthorized access. WLANs in public areas (hotspots) like coffee shops and airports may not provide any security. If you are concerned about the security of your computer when connected to a hotspot, limit your network activities to email that is not confidential and basic Internet surfing.

Wireless radio signals travel outside the network, so other WLAN devices can pick up unprotected signals. Take the following precautions to protect your WLAN:

- Use a firewall.

A firewall checks information and requests that are sent to your network, and discards any suspicious items. Firewalls are available in both software and hardware. Some networks use a combination of both types.

- Use wireless encryption.

Wireless encryption uses security settings to encrypt and decrypt data that is transmitted over the network. For more information, from the Start screen, type `help`, and then select **Help and Support**.

## Connecting to a WLAN

To connect to the WLAN, follow these steps:

1. Be sure that the WLAN device is on. If the device is on, the wireless light is white. If the wireless light is off, press the wireless button.

---

 **NOTE:** On some models, the wireless light is amber when all wireless devices are off.

---

2. From the Start screen, point to the far-right upper or lower corner of the screen to display the charms.
3. Select **Settings**, and then click the network status icon.
4. Select your WLAN from the list.
5. Click **Connect**.

If the WLAN is a security-enabled WLAN, you are prompted to enter a security code. Type the code, and then click **Sign in** to complete the connection.

---

 **NOTE:** If no WLANs are listed, you may be out of range of a wireless router or access point.

---

 **NOTE:** If you do not see the WLAN you want to connect to, from the Windows desktop, right-click the network status icon, and then select **Open Network and Sharing Center**. Click **Set up a new connection or network**. A list of options is displayed, allowing you to manually search for and connect to a network or to create a new network connection.

---

6. Follow the on-screen instructions to complete the connection.

After the connection is made, place the mouse pointer over the network status icon in the notification area, at the far right of the taskbar, to verify the name and status of the connection.

---

 **NOTE:** The functional range (how far your wireless signals travel) depends on WLAN implementation, router manufacturer, and interference from other electronic devices or structural barriers such as walls and floors.

---

## Connecting to a wired network

### Connecting to a local area network (LAN)

Use a LAN connection if you want to connect the computer directly to a router in your home (instead of working wirelessly), or if you want to connect to an existing network at your office.

Connecting to a LAN requires an 8-pin, RJ-45 (network) cable.

To connect the network cable, follow these steps:

1. Plug the network cable into the network jack **(1)** on the computer.

2. Plug the other end of the network cable into a network wall jack (2) or router.

 **NOTE:** If the network cable contains noise suppression circuitry (3), which prevents interference from TV and radio reception, orient the circuitry end of the cable toward the computer.

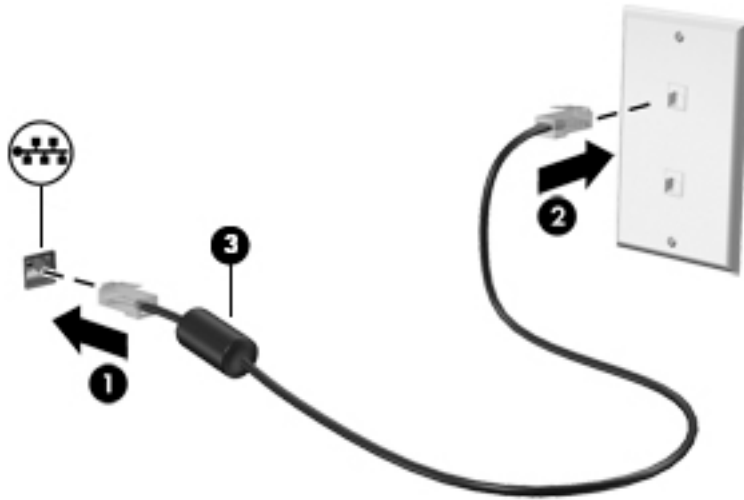

# 4 Enjoying entertainment features

Use your HP computer as an entertainment hub to socialize via the webcam, enjoy and manage your music, and download and watch movies. Or, to make your computer an even more powerful entertainment center, connect external devices like a monitor, projector, or TV, or speakers and headphones.





## Multimedia features

Here are some of the entertainment features on your computer.



Component		Description
(1)	Internal microphones (2)	Record sound.
(2)	Webcam light	On: The webcam is in use.
(3)	Webcam	Records video and captures photographs. Some models allow you to video conference and chat online using streaming video.  From the Start screen, type <code>camera</code> , and then select <b>Camera</b> from the list of applications.
(4)	Speakers	Produce sound.
(5)	Optical drive	Depending on your computer model, reads an optical disc or reads and writes to an optical disc.



Component	Description
	<p><b>NOTE:</b> For disc compatibility information, go to the Help and Support web page (see <a href="#">More HP resources on page 3</a>). Follow the web page instructions to select your computer model. Select <b>Drivers &amp; Downloads</b>, and then follow the on-screen instructions.</p>
(6) 	<p>USB 2.0 port</p> <p>Connects an optional USB device, such as a keyboard, mouse, external drive, printer, scanner or USB hub.</p>
(7) 	<p>Audio-out (headphone)/Audio-in (microphone) jack</p> <p>Connects optional powered stereo speakers, headphones, earbuds, a headset, or a television audio cable. Also connects an optional headset microphone. This jack does not support optional microphone-only devices.</p> <p><b>WARNING!</b> To reduce the risk of personal injury, adjust the volume before putting on headphones, earbuds, or a headset. For additional safety information, refer to the <i>Regulatory, Safety, and Environmental Notices</i>. To access this guide, from the Start screen, type <code>support</code>, and then select the <b>HP Support Assistant</b> app.</p> <p><b>NOTE:</b> When a device is connected to the jack, the computer speakers are disabled.</p> <p><b>NOTE:</b> Be sure that the device cable has a 4-conductor connector that supports both audio-out (headphone) and audio-in (microphone).</p>
(8) 	<p>USB 3.0 ports</p> <p>Each USB 3.0 port connects an optional USB device, such as a keyboard, mouse, external drive, printer, scanner or USB hub.</p>
(9) 	<p>HDMI port</p> <p>Connects an optional video or audio device, such as a high-definition television, any compatible digital or audio component, or a high-speed HDMI device.</p>
(10) 	<p>RJ-45 (network) jack</p> <p>Connects a network cable.</p>

## Using the webcam

The computer has an integrated webcam that records video and captures photographs. Some models may allow you to video conference and chat online using streaming video.

- ▲ To start the webcam, from the Start screen, type `camera`, and then select **Camera** from the list of applications.

For details about using the webcam, go to Help and Support. From the Start screen, type `help`, and then select **Help and Support**.

## Using audio

On your computer, or on select models using an external optical drive, you can play music CDs, download and listen to music, stream audio content from the web (including radio), record audio, or mix audio and video to create multimedia. To enhance your listening enjoyment, attach external audio devices such as speakers or headphones.

## Connecting speakers

You can attach wired speakers to your computer by connecting them to a USB port or to the audio-out (headphone)/audio-in (microphone) jack on your computer or on a docking station.

To connect wireless speakers to your computer, follow the device manufacturer's instructions. To connect high-definition speakers to the computer, see [Setting up HDMI audio on page 24](#). Before connecting speakers, lower the volume setting.

## Connecting headphones and microphones

You can connect wired headphones or headsets to the audio-out (headphone)/audio-in (microphone) jack on your computer. Many headsets with integrated microphones are commercially available.

To connect *wireless* headphones or headsets to your computer, follow the device manufacturer's instructions.

---

**⚠ WARNING!** To reduce the risk of personal injury, lower the volume setting before putting on headphones, earbuds, or a headset. For additional safety information, see the *Regulatory, Safety and Environmental Notices*. To access this guide, from the Start screen, type `support`, and then select the **HP Support Assistant** app.

---

## Using Beats Audio

Beats Audio is an enhanced audio feature that provides a deep, controlled bass while maintaining a clear sound. You can experience Beats Audio through the computer's internal speakers, through external speakers connected to a USB port, or through Beats Audio headphones connected to the headphone jack.

### Accessing Beats Audio Control Panel

Use Beats Audio Control Panel to view and manually control audio and bass settings.

- ▲ From Start screen, type `control panel`, select **Control Panel**, select **Hardware and Sound**, and then select **Beats Audio Control Panel**.

### Enabling and disabling Beats Audio

- ▲ To enable or disable Beats Audio, press the `fn` key in combination with the `b` key.

## Testing your audio features

To check the audio functions on your computer, follow these steps:

1. From the Start screen, type `control panel`, and then select **Control Panel**.
2. Select **Hardware and Sound**, and then select **Sound**.
3. When the Sound window opens, select the **Sounds** tab. Under **Program Events**, select any sound event, such as a beep or alarm, and then click **Test**.

You should hear sound through the speakers or through connected headphones.

To check the recording functions on your computer, follow these steps:

1. From the Start screen, type `sound`, and then select **Sound Recorder**.
2. Click **Start Recording** and speak into the microphone.

3. Save the file to your desktop.
4. Open a multimedia program and play the recording.

To confirm or change the audio settings on your computer, follow these steps:

1. From the Start screen, type `control panel`, and then select **Control Panel**.
2. Select **Hardware and Sound**, and then select **Sound**.

## Using video

Your computer is a powerful video device that enables you to watch streaming video from your favorite websites and download video and movies to watch on your computer when you are not connected to a network.

To enhance your viewing enjoyment, use one of the video ports on the computer to connect an external monitor, projector, or TV.

---

 **IMPORTANT:** Be sure that the external device is connected to the correct port on the computer, using the correct cable. Check the device manufacturer's instructions.

---

## Connecting video devices by using an HDMI cable

---

 **NOTE:** To connect an HDMI device to your computer, you need an HDMI cable, sold separately.

---

To see the computer screen image on a high-definition TV or monitor, connect the high-definition device according to the following instructions.

1. Connect one end of the HDMI cable to the HDMI port on the computer.

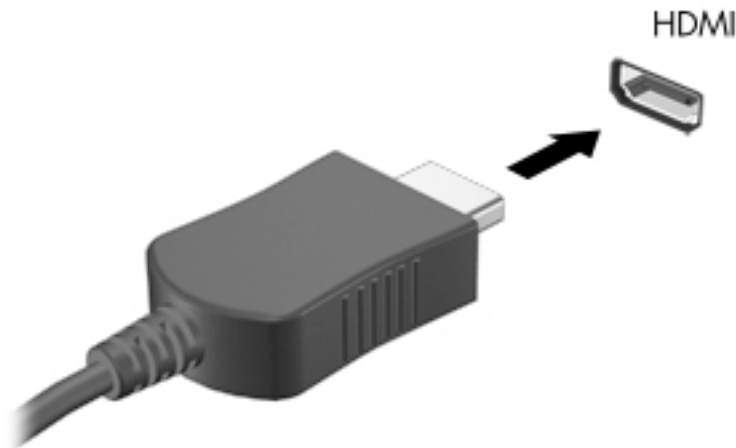

2. Connect the other end of the cable to the high-definition TV or monitor.
3. Press **f4** to alternate the computer screen image between 4 display states:
  - **PC screen only:** View the screen image on the computer only.
  - **Duplicate:** View the screen image simultaneously on both the computer and the external device.

- **Extend:** View the screen image extended across both the computer and the external device.
- **Second screen only:** View the screen image on the external device only.

Each time you press **f4**, the display state changes.

---

 **NOTE:** For best results, especially if you choose the “Extend” option, adjust the screen resolution of the external device, as follows. From the Start screen, type `control panel`, and then select **Control Panel**. Select **Appearance and Personalization**. Under **Display**, select **Adjust screen resolution**.

---

## Setting up HDMI audio

HDMI is the only video interface that supports high-definition video and audio. After you connect an HDMI TV to the computer, you can then turn on HDMI audio by following these steps:

1. From the Windows desktop, right-click the **Speakers** icon in the notification area, at the far right of the taskbar, and then select **Playback devices**.
2. On the **Playback** tab, select the name of the digital output device.
3. Click **Set Default**, and then click **OK**.

To return the audio stream to the computer speakers:

1. From the Windows desktop, right-click the **Speakers** icon in the notification area, at the far right of the taskbar, and then click **Playback devices**.
2. On the **Playback** tab, click **Speakers**.
3. Click **Set Default**, and then click **OK**.

## Discovering and connecting to Miracast-compatible wireless displays (select AMD models only)

To discover and connect to Miracast-compatible wireless displays without leaving your current apps, follow the steps below.

To open Miracast:

- ▲ Point to the upper-right or lower-right corner of the Start screen to display the charms, click **Devices**, click **Project**, and then follow the on-screen instructions.

– or –

From the Start screen, click the **HP Quick Access to Miracast** icon, and then follow the on-screen instructions.

## Discovering and connecting to Miracast-compatible wireless displays (select Intel models only)

Use Intel wireless display apps to wirelessly project individual files such as photos, music, or videos, or to duplicate your entire computer screen to a TV or a secondary display device.

Intel WiDi, a premium Miracast solution, makes it easy and seamless to pair your secondary display device; provides for full-screen duplication; and improves speed, quality, and scaling. Intel WiDi Media Share enables easy multitasking and provides tools to select and flick individual media files to your secondary display device.

Open the apps by following these steps:

1. To open the Intel WiDi connection app, from the Start screen, type `Intel WiDi`. Follow the on-screen instructions to pair your secondary display device and make display state choices. Use the **WiDi Connect** function to initiate a connection.
2. To open the Intel Media Share app, from the Start screen, type `Intel WiDi Media Share`. Follow the on-screen instructions to flick and share your media files to a secondary display device.

---

## 5 Navigating the screen

You can navigate the computer screen in the following ways:

- Touch gestures
- Keyboard and mouse

Touch gestures can be used on your computer's TouchPad or on a touch screen (select models only).

---

 **NOTE:** An external USB mouse (purchased separately) can be connected to one of the USB ports on the computer.

---

Select computer models have special action keys or hot key functions on the keyboard to perform routine tasks.

### Using the TouchPad and gestures

The TouchPad allows you to navigate the computer screen and control the pointer by using simple finger movements. You can customize the touch gestures by changing settings, button configurations, click speed, and pointer options. You can also view demonstrations of TouchPad gestures.

From the Start screen, type `control panel`, select **Control Panel**, and then select **Hardware and Sound**. Under **Devices and Printers**, select **Mouse**.

---

 **TIP:** Use the left and right buttons on the TouchPad as you would use the corresponding buttons on an external mouse.

---

 **NOTE:** TouchPad gestures are not supported in all apps.

---

## Tapping

To make an on-screen selection, use the tap function on the TouchPad.

- Point to an item on the screen, and then tap one finger on the TouchPad zone to make a selection. Double-tap an item to open it.



## Scrolling

Scrolling is useful for moving up, down, or sideways on a page or image.

- Place two fingers slightly apart on the TouchPad zone and then drag them up, down, left, or right.

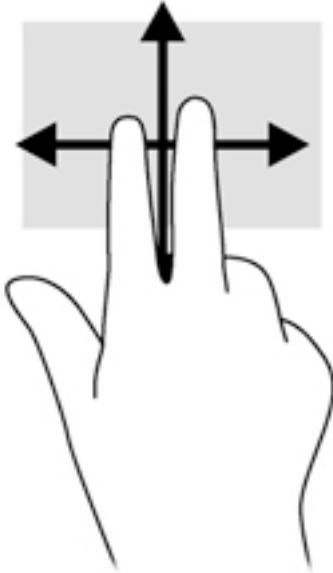



## 2-finger pinch zoom

2-finger pinch zoom allows you to zoom out or in on images or text.

- Zoom out by placing two fingers apart on the TouchPad zone and then moving your fingers together.
- Zoom in by placing two fingers together on the TouchPad zone and then moving your fingers apart.

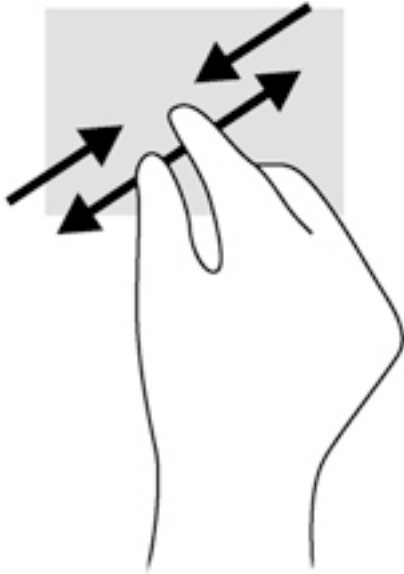

## 2-finger click

2-finger click allows you to make menu selections for an object on the screen.

---

 **NOTE:** Using 2-finger click is the same action as using right-click with the mouse.

---

- Place two fingers on the TouchPad zone and press down to open the options menu for the selected object.



## Rotating (select models only)

Rotating allows you to turn items such as photos.

- Point to an object, and then anchor the forefinger of your left hand in the TouchPad zone. Using your right hand, slide your forefinger in a sweeping motion from 12 o'clock to 3 o'clock. To reverse the rotation, move your forefinger from 3 o'clock to 12 o'clock.

---

 **NOTE:** Rotate is intended for specific apps where you can manipulate an object or image. Rotate may not be functional for all apps.

---

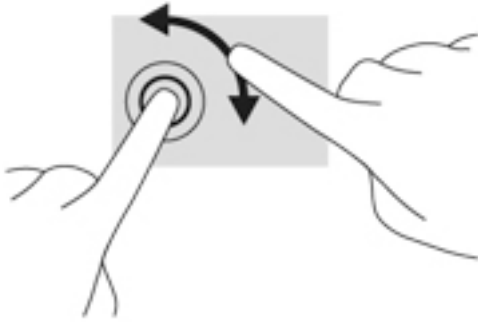

## Edge swipes

Edge swipes allow you to perform tasks such as changing settings and finding or using apps.

### Display and select a charm

With the charms, you can search, share, start apps, access devices, or change settings.

1. With your finger, swipe from the right side of the TouchPad.

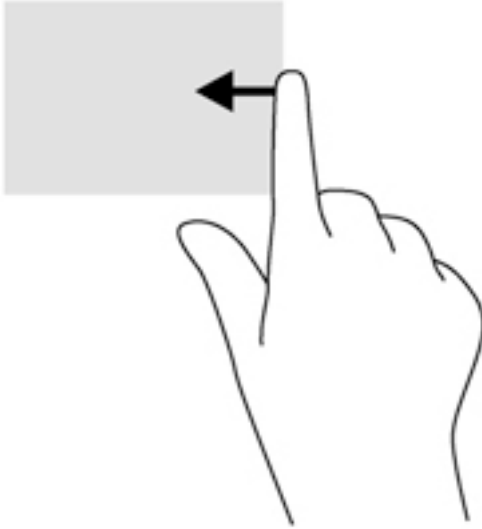

2. Scroll up or down to switch between the charms, and then select the charm you want to open.

## Display the Customize icon

The top-edge swipe allows you to display the Customize icon at the bottom of the Start screen. Customize allows you to move, resize, pin and unpin apps.

---

 **IMPORTANT:** When an app is active, the top-edge gesture varies depending on the app.

---

- Swipe your finger gently from the top edge of the TouchPad zone to reveal the **Customize** icon.

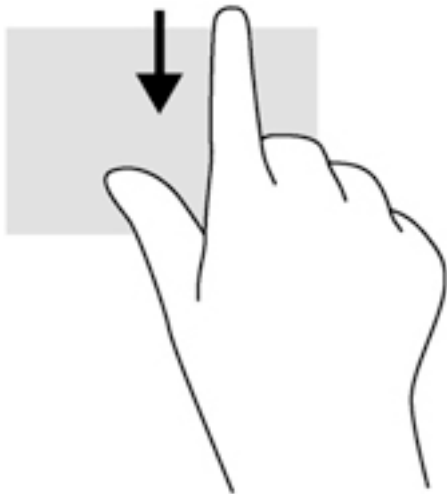

## Switch between open apps

The left-edge swipe accesses your recently opened apps so that you can switch between them quickly.

- Swipe your finger gently from the left edge of the TouchPad.



## Using touch screen gestures (select models only)

A touch screen computer allows you to control items on the screen directly with your fingers.

---

 **TIP:** On touch screen computers, you can perform the gestures on the screen or on the TouchPad. You can also perform on-screen actions with the keyboard and mouse.

---

### One-finger slide

The one-finger slide is mostly used to pan or scroll through lists and pages, but you can use it for other interactions, too, such as moving an object.

- To scroll across the screen, lightly slide one finger across the screen in the direction you want to move.

---

 **NOTE:** When many apps are displayed on the Start screen, you can slide your finger to move the screen left or right.

---

- To drag, press and hold an object, and then drag the object to move it.

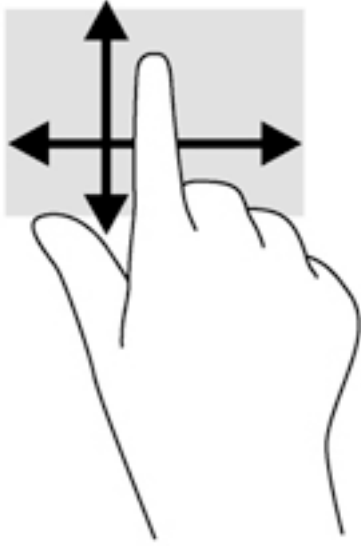

## Tapping

To make an on-screen selection, use the tap function.

- Use one finger to tap an object on the screen to make a selection. Double-tap an item to open it.



## Scrolling

Scrolling is useful for moving the pointer up, down, left, or right on a page or image.

- Place two fingers on the screen and then drag them in an up, down, left, or right motion.

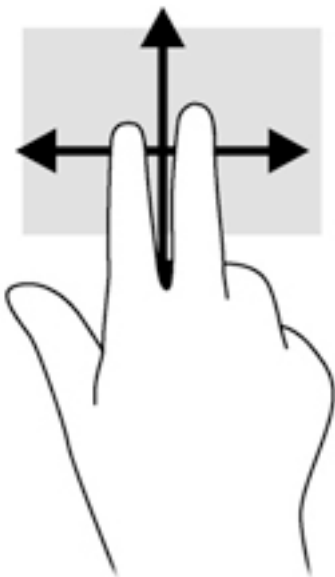



## 2-finger pinch zoom

2-finger pinch zoom allows you to zoom out or in on images or text.

- Zoom out by placing two fingers apart on the screen and then moving your fingers together.
- Zoom in by placing two fingers together on the screen and then moving your fingers apart.

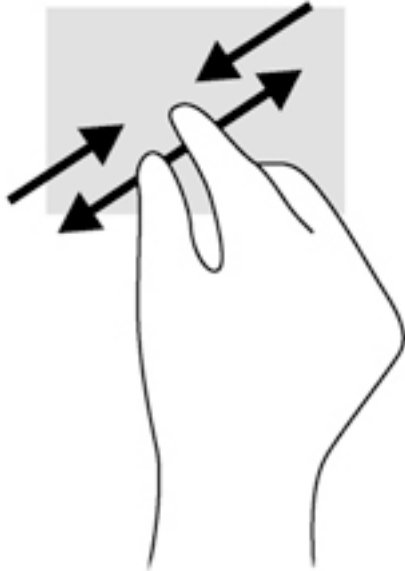

## Rotating (select models only)

Rotating allows you to turn items such as photos.

- Anchor the forefinger of your left hand on the object you want to rotate. Using your right hand, slide your forefinger around in a sweeping motion from 12 o'clock to 3 o'clock. To reverse the rotation, move your forefinger from 3 o'clock to 12 o'clock.

---

 **NOTE:** Rotate is intended for specific apps where you can manipulate an object or image. Rotate may not be functional for all apps.

---

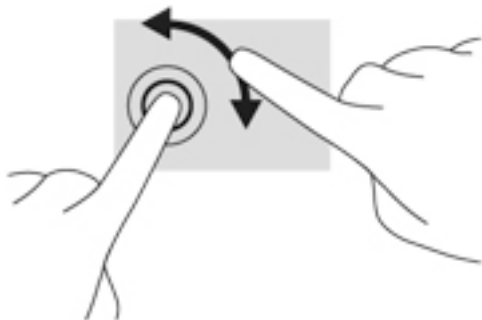

## Edge swipes

With edge swipes you can perform tasks such as changing settings and finding or using apps.

### Right-edge swipe

The right-edge swipe reveals the charms, which let you search, share, start apps, access devices, or change settings.

- Gently swipe your finger inward from the right edge of the display onto the screen to reveal the charms.

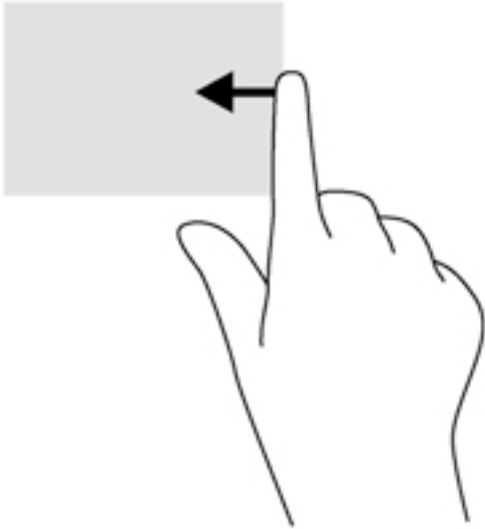

### Left-edge swipe

The left-edge swipe reveals your open apps so that you can switch to them quickly.

- Gently swipe your finger inward from the left edge of the display to switch between apps. Without lifting your finger, swipe back toward the left edge to reveal all open apps.

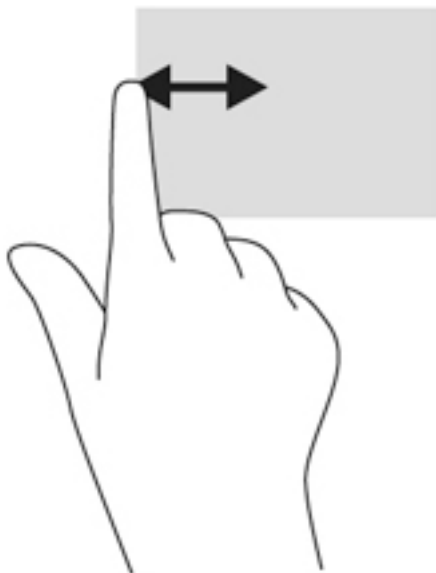

## Top-edge swipe and bottom-edge swipe

The top-edge swipe or bottom-edge swipe displays app command options that allow you to customize apps.

---

 **IMPORTANT:** When an app is open, the top-edge gesture varies depending on the app.

---

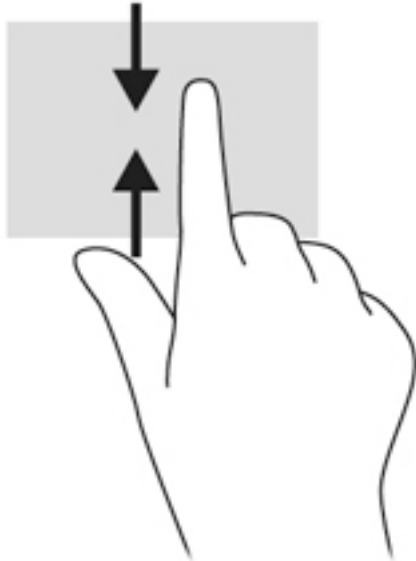

- Gently swipe your finger from the top edge or the bottom edge to reveal the app command options.



## Using the keyboard and mouse

The keyboard and mouse allow you to type, select items, scroll and to perform the same functions as you do using touch gestures. The keyboard also allows you to use action keys and hot keys to perform specific functions.

---

 **TIP:** The Windows key  on the keyboard allows you to quickly return to the Start screen from an open app or the Windows desktop. Pressing the Windows key again will return you to the previous screen.

 **NOTE:** Depending on the country or region, your keyboard may have different keys and keyboard functions than those discussed in this section.

---

## Using the keys

You can quickly access information or perform functions by using certain keys and key combinations.

### Using the action keys

An action key performs an assigned function. The icon on each of the function keys illustrates the assigned function for that key.

To use an action key function, press and hold the key.











---

 **CAUTION:** Use extreme care when making changes in Setup Utility (BIOS). Errors can prevent the computer from operating properly.

---

The action key feature is enabled at the factory. You can disable this feature in Setup Utility (BIOS). See [Using Setup Utility \(BIOS\) and HP PC Hardware Diagnostics \(UEFI\) on page 62](#) for instructions on opening Setup Utility (BIOS), and then follow the instructions at the bottom of the screen.

After you have disabled the action key feature, you can still perform each function by pressing the **fn** key in combination with the appropriate action key.

Icon	Key	Description
	<b>f1</b>	Opens Help and Support, which provides tutorials, information about the Windows operating system and your computer, answers to questions, and updates to your computer.  Help and Support also provides automated troubleshooting tools and access to support.
	<b>f2</b>	Decreases the screen brightness incrementally as long as you hold down the key.
	<b>f3</b>	Increases the screen brightness incrementally as long as you hold down the key.
	<b>f4</b>	Switches the screen image between display devices connected to the system. For example, if a monitor is connected to the computer, repeatedly pressing this key alternates the screen image from the computer display to the monitor display to a simultaneous display on both the computer and the monitor.
	<b>f6</b>	Mutes or restores speaker sound.
	<b>f7</b>	Decreases speaker volume incrementally as long as you hold down the key.
	<b>f8</b>	Increases speaker volume incrementally as long as you hold down the key.
	<b>f9</b>	Plays the previous track of an audio CD or the previous section of a DVD or a BD.
	<b>f10</b>	Begins, pauses, or resumes playback of an audio CD, a DVD, or a BD.
	<b>f11</b>	Plays the next track of an audio CD or the next section of a DVD or a BD.
	<b>f12</b>	Turns the Airplane mode and wireless feature on or off.  <b>NOTE:</b> A wireless network must be set up before a wireless connection is possible.

## Using Windows shortcut keys

Windows provides shortcuts so that you can perform actions quickly. Press the Windows key  alone or in combination with a specific key to perform a designated action.

## Using the hot keys

A hot key is a combination of the **fn** key and the **esc** key, the **b** key, or the **spacebar**.

To use a hot key:

- ▲ Briefly press the **fn** key, and then briefly press the second key of the combination.

---

## 6 Managing power

Your computer can operate on either battery power or external power. When the computer is running on battery power only and an AC power source is not available to charge the battery, it is important to monitor and conserve the battery charge. Your computer supports an optimal power plan to manage how your computer uses and conserves power so that computer performance is balanced with power conservation.

### Initiating Sleep and Hibernation

Windows has two power-saving states, Sleep and Hibernation.

- **Sleep**—The Sleep state is automatically initiated after a period of inactivity when running on battery power or on external power. Your work is saved to memory, allowing you to resume your work very quickly. You can also initiate Sleep manually. For more information, see [Manually initiating and exiting Sleep on page 43](#).
- **Hibernation**—The Hibernation state is automatically initiated if the battery reaches a critical level. In the Hibernation state, your work is saved to a hibernation file and the computer powers down.

---

 **NOTE:** You can manually initiate Hibernation. See [Manually initiating and exiting Sleep on page 43](#) and [Manually initiating and exiting Hibernation \(select models only\) on page 43](#).

---

 **CAUTION:** To reduce the risk of possible audio and video degradation, loss of audio or video playback functionality, or loss of information, do not initiate Sleep while reading from or writing to a disc or an external media card.

 **NOTE:** You cannot initiate any type of networking connection or perform any computer functions while the computer is in the Sleep state or in Hibernation.

---

## Manually initiating and exiting Sleep

You can initiate Sleep in any of the following ways:

- Close the display.
- From the Start screen, point to the upper-right or lower-right corner of the screen to reveal the charms. Click **Settings**, click the **Power** icon, and then click **Sleep**.

To exit Sleep:

- Briefly press the power button.
- If the display is closed, open the display.
- Press a key on the keyboard.
- Tap or swipe the TouchPad.

When the computer exits Sleep, the power lights turn on and your work returns to the screen.



**NOTE:** If you have set a password to be required on wakeup, you must enter your Windows password before the computer will return to the screen.

## Manually initiating and exiting Hibernation (select models only)

You can enable user-initiated Hibernation and change other power settings and timeouts using Power Options.

1. From the Start screen, type `power options`, then select **Power options**.
2. In the left pane, click **Choose what the power button does**.
3. Click **Change Settings that are currently unavailable**.
4. In the **When I press the power button** area, select **Hibernate**.
5. Click **Save changes**.

When the computer exits Hibernation, the power lights turn on and your work returns to the screen.



**NOTE:** If you have set a password to be required on wakeup, you must enter your Windows password before your work will return to the screen.

## Setting password protection on wakeup

To set the computer to prompt for a password when the computer exits Sleep or Hibernation, follow these steps:

1. From the Start screen, type `power options`, then select **Power options**.
2. In the left pane, click **Require a password on wakeup**.
3. Click **Change Settings that are currently unavailable**.
4. Click **Require a password (recommended)**.



**NOTE:** If you need to create a user account password or change your current user account password, click **Create or change your user account password**, and then follow the on-screen instructions. If you do not need to create or change a user account password, go to step 5.

5. Click **Save changes**.

## Using the power meter and power settings

The power meter is located on the Windows desktop. The power meter allows you to quickly access power settings and view the remaining battery charge.

- To reveal the percentage of remaining battery charge and the current power plan, on the Windows desktop, point over the power meter icon.
- To use Power Options, click the power meter icon and select an item from the list. From the Start screen, you can also type `power options`, and then select **Power Options**.

Different power meter icons indicate whether the computer is running on battery or external power. The icon also reveals a message if the battery has reached a low or critical battery level.

## Running on battery power

When a charged battery is in the computer and the computer is not plugged into external power, the computer runs on battery power. The battery in the computer slowly discharges when the computer is off and unplugged from external power.

Computer battery life varies, depending on power management settings, programs running on the computer, screen brightness, external devices connected to the computer, and other factors.

## User-replaceable battery

---

 **WARNING!** To reduce potential safety issues, use only the user-replaceable battery provided with the computer, a replacement battery provided by HP, or a compatible battery purchased from HP.

 **CAUTION:** Removing a user-replaceable battery that is the sole power source for the computer can cause loss of information. To prevent loss of information, save your work or shut down the computer through Windows before removing the battery.

---

1. Turn the computer upside down on a flat surface.
2. Slide the battery lock latch **(1)** and then slide the battery release latch **(2)** to release the battery.

 **NOTE:** The battery release latch automatically returns to its original position.

---



3. Pivot the battery (3) upward and remove it from the computer (4).

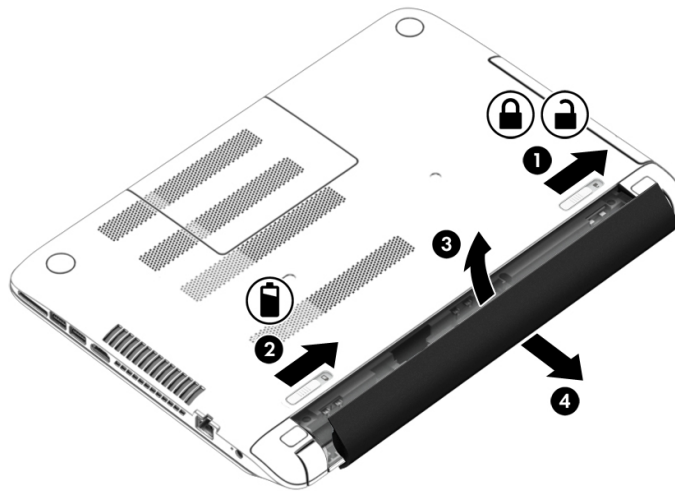

## Finding battery information

To monitor the status of your battery, or if the battery is no longer holding a charge, run Battery Check in HP Support Assistant. To access battery information, from the Start screen, type `support`, select the **HP Support Assistant** app, and then select **Battery and performance**.

HP Support Assistant provides the following tools and information about the battery:

- Battery test
- Information about battery types, specifications, life cycles, and capacity

## Conserving battery power

Tips for conserving battery power and maximizing battery life:

- Lower the brightness on the display.
- Select the **Power saver** setting in Power Options.
- Remove a user-replaceable battery from the computer if it will not be used or charged for more than 2 weeks.
- Turn off wireless devices when you are not using them.
- Disconnect unused external devices that are not plugged into an external power source, such as an external hard drive connected to a USB port.
- Stop, disable, or remove any external media cards that you are not using.
- Before you leave your work, initiate Sleep or shut down the computer.

## Identifying low battery levels

When a battery that is the sole power source for the computer reaches a low or critical battery level, the following behavior occurs:

- The battery light (select models only) indicates a low or critical battery level.

– or –

- The power meter icon on the Windows desktop shows a low or critical battery notification.



**NOTE:** For additional information about the power meter, see [Using the power meter and power settings on page 44](#).

The computer takes the following actions for a critical battery level:

- If Hibernation is disabled and the computer is on or in the Sleep state, the computer remains briefly in the Sleep state, and then shuts down and loses any unsaved information.
- If Hibernation is enabled and the computer is on or in the Sleep state, the computer initiates Hibernation.

## Resolving a low battery level

### Resolving a low battery level when external power is available

- Connect an AC adapter.
- Connect an optional docking or expansion device.
- Connect an optional power adapter purchased as an accessory from HP.

### Resolving a low battery level when no power source is available

Save your work and shut down the computer.

### Resolving a low battery level when the computer cannot exit Hibernation

When the computer lacks sufficient power to exit Hibernation, follow these steps:

1. Replace the discharged user-replaceable battery with a charged battery, or connect the AC adapter to the computer and to external power.
2. Exit Hibernation by pressing the power button.

## Storing a user-replaceable battery

**CAUTION:** To reduce the risk of damage to a battery, do not expose it to high temperatures for extended periods of time.

If a computer will be unused and unplugged from external power for more than 2 weeks, remove the battery and store it separately in a cool, dry place to prolong the battery charge.

A stored battery should be checked every 6 months. If the capacity is less than 50 percent, recharge the battery before returning it to storage.

## Disposing of a user-replaceable battery

**WARNING!** To reduce the risk of fire or burns, do not disassemble, crush, or puncture; do not short external contacts; do not dispose of in fire or water.

See the *Regulatory, Safety and Environmental Notices* for proper battery disposal. To access this guide, from the Start screen, type `support`, and then select the **HP Support Assistant** app.

## Replacing a user-replaceable battery

Battery Check in HP Support Assistant notifies you to replace the battery when an internal cell is not charging properly or when the battery storage capacity has reached a weak condition. If the battery is possibly covered by an HP warranty, instructions include a warranty ID. A message refers you to the HP website for more information about ordering a replacement battery.

## Running on external AC power

For information about connecting to AC power, refer to the *Setup Instructions* poster provided in the computer box.

The computer does not use battery power when the computer is connected to AC external power with an approved AC adapter or an optional docking/expansion device.

---

**⚠ WARNING!** To reduce potential safety issues, use only the AC adapter provided with the computer, a replacement AC adapter provided by HP, or a compatible AC adapter purchased from HP.

---

Connect the computer to external AC power under any of the following conditions:

---

**⚠ WARNING!** Do not charge the computer battery while you are onboard aircraft.

---

- When charging or calibrating a battery
- When installing or modifying system software
- When writing information to a disc (select models only)
- When running Disk Defragmenter on computers with internal hard drives
- When performing a backup or recovery

When you connect the computer to external AC power:

- The battery begins to charge.
- The screen brightness increases.
- The power meter icon on the Windows desktop changes appearance.

When you disconnect external AC power, the following events occur:

- The computer switches to battery power.
- The screen brightness automatically decreases to save battery life.
- The power meter icon on the Windows desktop changes appearance.

## Troubleshooting power problems

Test the AC adapter if the computer exhibits any of the following symptoms when it is connected to AC power:

- The computer does not turn on.
- The display does not turn on.
- The power lights are off.

To test the AC adapter:

1. Shut down the computer.
2. Connect the AC adapter to the computer, and then plug it into an AC outlet.
3. Turn on the computer.
  - If the power lights turn *on*, the AC adapter is working properly.
  - If the power lights remain *off*, check the connection from the AC adapter to the computer and the connection from the AC adapter to the AC outlet to be sure that the connections are secure.
  - If the connections are secure and the power lights remain *off*, the AC adapter is not functioning and should be replaced.

Contact support for information about obtaining a replacement AC power adapter.

## HP CoolSense

HP CoolSense  automatically detects when the computer is not on a horizontal surface and adjusts performance and fan settings to keep the surface temperature of your computer at the optimum level of comfort.

When HP CoolSense is off, the position of the computer is not detected and the performance and fan options remain at the factory setting. As a result, the surface temperature of the computer might be higher than it would be with HP CoolSense on.

To turn CoolSense off or on, follow these steps:

- ▲ From the Start screen, type `coolsense`, and then select **HP CoolSense**.

## Refreshing your software content with Intel Smart Connect Technology (select models only)

When the computer is in the Sleep state, Intel® Smart Connect Technology periodically causes the computer to exit Sleep. If a network connection is available, Smart Connect updates open apps such as your email inboxes, social network sites, and news pages and then returns the computer to the Sleep state. Smart Connect also syncs content that you have created offline, such as emails. When the computer exits Sleep, you have immediate access to your updated information.

- ▲ To enable this feature or manually adjust the settings, from the Start screen, type `smart`, and then select Intel® Smart Connect Technology.

## Shutting down (turning off) the computer

---

 **CAUTION:** Unsaved information is lost when the computer shuts down. Be sure to save your work before shutting down the computer.

---

The Shut down command closes all open programs, including the operating system, and then turns off the display and computer.

Shut down the computer under any of the following conditions:

- When you need to replace the battery or access components inside the computer
- When you are connecting an external hardware device that does not connect to a USB or video port
- When the computer will be unused and disconnected from external power for an extended period

Although you can turn off the computer with the power button, the recommended procedure is to use the Windows Shut down command:

---

 **NOTE:** If the computer is in the Sleep state or in Hibernation, you must first exit Sleep or Hibernation before shutdown is possible by briefly pressing the power button.

---

1. Save your work and close all open programs.
2. From the Start screen, point to the upper-right or lower-right corner of the screen to reveal the charms.
3. Click **Settings**, click the **Power** icon, and then click **Shut down**.

– or –

Right-click the **Start** button in the lower-left corner of the screen, select **Shut down or sign out**, and then select **Shut down**.

If the computer is unresponsive and you are unable to use the preceding shutdown procedures, try the following emergency procedures in the sequence provided:

- Press **ctrl+alt+delete**, click the **Power** icon, and then select **Shut Down**.
- Press and hold the power button for at least 5 seconds.
- Disconnect the computer from external power.
- On models with a user-replaceable battery, remove the battery.

## Hybrid Graphics and AMD Dual Graphics (select models only)

Select computers are equipped with either the Hybrid Graphics feature or the AMD Dual Graphics feature.

---

 **NOTE:** To determine whether Hybrid Graphics or AMD Dual Graphics is installed on your computer, see your notebook graphics processor configuration and software Help.

---

Both Hybrid Graphics and AMD Dual Graphics offer two modes for processing graphics:

- High Performance mode—Applications assigned to this mode run on the higher-performance graphics processing unit (GPU) for optimal performance.
- Power Saving mode—Applications assigned to this mode run on the lower-performance GPU to conserve battery power.

### Using Hybrid Graphics (select models only)

The Hybrid Graphics feature allows an application to run in either High Performance mode or Power Saving mode, based on the application's graphics-processing demands. Typically, 3D and gaming applications run on the higher-performance GPU, and applications with lightweight graphics-processing demands run on the lower-performance GPU. You can change the mode an application uses (High Performance or Power Saving) through the Hybrid Graphics control panel.



---

**NOTE:** Due to hardware limitations, some applications can be run in only one of the two modes.

---

For more information, see your Hybrid Graphics software Help.

## Using AMD Dual Graphics (select models only)

The AMD Dual Graphics feature allows the AMD accelerated processing unit (APU) and the discrete AMD graphics card to work together. When AMD Dual Graphics is enabled, graphics performance improves over the performance available using only one of the graphics devices. This improvement applies to DirectX versions 10 or 11 (DX10 and DX11) applications operating in full-screen mode. In windowed mode or when running non-DX10/11 applications, the system operates in a manner similar to Hybrid Graphics.

For more information, see the AMD Dual Graphics software Help.

---

# 7 Maintaining your computer

It is important to perform regular maintenance to keep your computer in optimal condition by using tools like Disk Defragmenter and Disk Cleanup. This chapter also includes ways to update programs and drivers, steps to clean the computer, and tips for traveling with (or shipping) the computer.

## Improving performance

You can improve the performance of your computer by performing regular maintenance tasks with tools such as Disk Defragmenter and Disk Cleanup.

## Handling drives

Observe these precautions when handling drives:

- Before removing or installing a drive, shut down the computer. If you are unsure whether the computer is off, in the Sleep state, or in Hibernation, turn the computer on, and then shut it down.
- Before handling a drive, discharge static electricity by touching a grounded surface.
- Do not touch the connector pins on a removable drive or on the computer.
- Do not use excessive force when inserting a drive into a drive bay.
- If a drive must be mailed, place the drive in a bubble-pack mailer or other suitable protective packaging and label the package “FRAGILE.”
- Avoid exposing a drive to magnetic fields. Security devices with magnetic fields include airport walk-through devices and security wands. Airport conveyer belts and similar security devices that check carry-on baggage use X-rays instead of magnetism and do not damage drives.
- Remove media from a drive before removing the drive from the drive bay, or traveling with, shipping, or storing a drive.
- Do not type on the keyboard or move the computer while an optical drive is writing to a disc. The write process is sensitive to vibration.
- Before you move a computer that is connected to an external hard drive, initiate Sleep and allow the screen to clear, or properly disconnect the external hard drive.

## Using HP 3D DriveGuard (select models only)

HP 3D DriveGuard protects a hard drive by parking the drive and halting data requests under either of the following conditions:

- You drop the computer.
- You move the computer with the display closed while the computer is running on battery power.

A short time after the end of one of these events, HP 3D DriveGuard returns the hard drive to normal operation.

 **NOTE:** Because solid state drives (SSDs) lack moving parts, they do not require HP 3D DriveGuard protection.

 **NOTE:** A hard drive in a primary hard drive bay or a secondary hard drive bay is protected by HP 3D DriveGuard. A hard drive installed in an optional docking device or connected to a USB port is not protected by HP 3D DriveGuard.

---

For more information, see the HP 3D DriveGuard software Help.

## Identifying HP 3D DriveGuard status

The hard drive light on the computer changes color to show that the drive in a primary hard drive bay and/or the drive in a secondary hard drive bay (select models only) is parked. To determine whether a drive is currently protected or whether it is parked, view the icon on the Windows desktop in the notification area, at the far right of the taskbar, or in the Mobility Center.

## Using Disk Defragmenter

As you use your computer over time, the files on the hard drive become fragmented. A fragmented drive means data on your drive is not contiguous (sequential) and, because of this, the hard drive works harder to locate files, thus slowing down the computer. Disk Defragmenter consolidates (or physically reorganizes) the fragmented files and folders on the hard drive so that the system can run more efficiently.

 **NOTE:** It is not necessary to run Disk Defragmenter on solid-state drives.

---

After you start Disk Defragmenter, it works without supervision. However, depending on the size of your hard drive and the number of fragmented files, Disk Defragmenter may take more than an hour to complete.

HP recommends defragmenting your hard drive at least once a month. You may set Disk Defragmenter to run on a monthly schedule, but you can defragment your computer manually at any time.

To run Disk Defragmenter:

1. Connect the computer to AC power.
2. From the Start screen, type `disk`.
3. Follow the on-screen instructions.

For additional information, access the Disk Defragmenter software Help.

## Using Disk Cleanup

Disk Cleanup searches the hard drive for unnecessary files that you can safely delete to free up disk space and help the computer run more efficiently.

To run Disk Cleanup:

1. From the Start screen, select **disk**, and then select **Manage your apps to free up disk space**.
2. Follow the on-screen instructions.

## Adding or replacing memory modules

Adding memory can help improve your computer's performance. Your computer is like your physical work area. The hard drive is the filing cabinet where you store your work and the memory is the desk where you work. When your memory isn't big enough to hold all your work easily, like a desk overflowing with work, your productivity slows down. A great solution to improve performance is to expand the amount of memory you have in your computer.





The computer has either one or two memory module slots. The memory module slots are located on the bottom of the computer under the service door. The memory capacity of the computer can be upgraded by adding a memory module or replacing the existing memory module in one of the memory module slots.

---

 **NOTE:** Before adding or replacing a memory module, make sure the computer has the most recent BIOS version, and update the BIOS if needed. See [Updating the BIOS on page 62](#).

 **CAUTION:** Failure to update the computer to the latest BIOS prior to installing or replacing a memory module may result in various system problems.

 **WARNING!** To reduce the risk of electric shock and damage to the equipment, unplug the power cord and remove all batteries before installing a memory module.

 **CAUTION:** Electrostatic discharge (ESD) can damage electronic components. Before beginning any procedure, ensure that you are discharged of static electricity by touching a grounded metal object.

 **NOTE:** If you are adding or replacing the memory module in your computer with a single memory module, insert the memory module into the slot closest to the system board.

 **NOTE:** To use a dual-channel configuration with a second memory module, be sure that both memory modules are identical.

---

To add or replace a memory module:

---

 **CAUTION:** To prevent information loss or an unresponsive system:

Shut down the computer before adding or replacing memory modules. Do not remove a memory module while the computer is on, in the Sleep state, or in Hibernation.

If you are not sure whether the computer is off or in Hibernation, turn the computer on by pressing the power button. Then shut down the computer through the operating system.

---

1. Save your work and shut down the computer.
2. Disconnect all external devices connected to the computer.
3. Unplug the power cord from the AC outlet.
4. Turn the computer upside down on a flat surface.
5. Remove the battery from the computer (see [User-replaceable battery on page 44](#)).
6. Remove the service door from the computer.
7. If you are replacing a memory module, remove the existing memory module:
  - a. Pull away the retention clips (1) on each side of the memory module.  
The memory module tilts up.

- b. Grasp the edge of the memory module (2), and then gently pull the module out of the memory module slot.

---

**CAUTION:** To prevent damage to the memory module, hold the memory module by the edges only. Do not touch the components on the memory module.

---

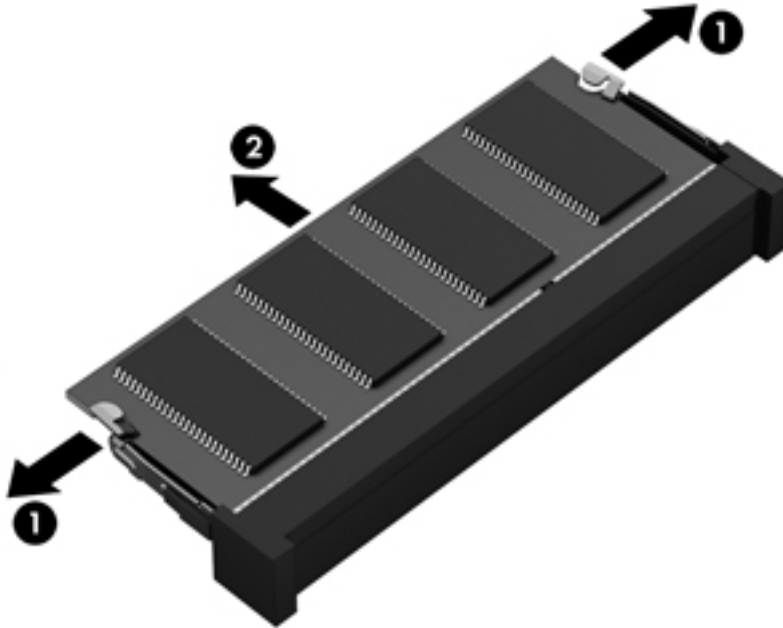

---

**NOTE:** To protect a memory module after removal, place it in an electrostatic-safe container.

---

8. Insert a new memory module:

**CAUTION:** To prevent damage to the memory module, hold the memory module by the edges only. Do not touch the components on the memory module.

---

- a. Align the notched edge (1) of the memory module with the tab in the memory module slot.
- b. With the memory module at a 45-degree angle from the surface of the memory module compartment, press the module into the memory module slot (2) until it is seated.
- c. Gently press the memory module (3) down, applying pressure to both the left and right edges of the module, until the retention clips snap into place.

---

**CAUTION:** To prevent damage to the memory module, be sure that you do not bend the module.

---

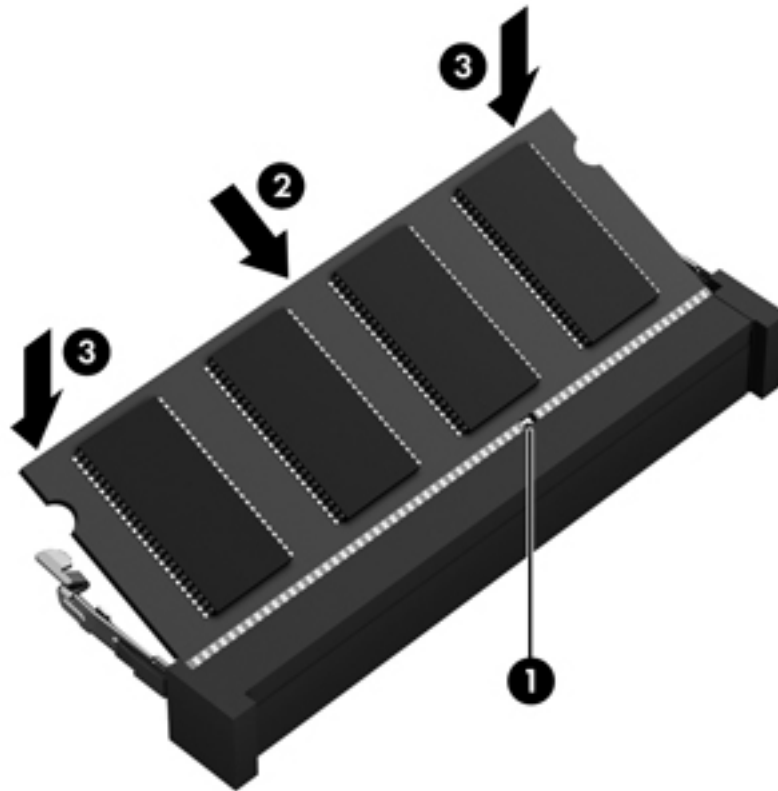

9. Replace the service door.
10. Replace the battery.
11. Turn the computer right-side up, and then reconnect external power and external devices.
12. Turn on the computer.

## Updating programs and drivers

HP recommends that you update your programs and drivers on a regular basis. Updates can resolve issues and bring new features and options to your computer. For example, older graphics components might not work well with the most recent gaming software. Without the latest driver, you would not be getting the most out of your equipment.

Go to <http://www.hp.com/support> to download the latest versions of HP programs and drivers. In addition, register to receive automatic update notifications when they become available.

If you would like to update your program and drivers, follow these instructions:

1. From the Start screen, type `support`, and then select the **HP Support Assistant** app.
2. Click **Updates and tune-ups**, and then click **Check for HP updates now**.
3. Follow the on-screen instructions.

## Cleaning your computer

Use the following products to safely clean your computer:

- Dimethyl benzyl ammonium chloride 0.3 percent maximum concentration (for example, disposable wipes, which come in a variety of brands).
- Alcohol-free glass-cleaning fluid
- Water with mild soap solution
- Dry microfiber cleaning cloth or a chamois (static-free cloth without oil)
- Static-free cloth wipes

---

**⚠ CAUTION:** Avoid strong cleaning solvents that can permanently damage your computer. If you are not sure that a cleaning product is safe for your computer, check the product contents to make sure that ingredients such as alcohol, acetone, ammonium chloride, methylene chloride, and hydrocarbons are not included in the product.

---

Fibrous materials, such as paper towels, can scratch the computer. Over time, dirt particles and cleaning agents can get trapped in the scratches.

## Cleaning procedures

Follow the procedures in this section to safely clean your computer.

---

**⚠ WARNING!** To prevent electric shock or damage to components, do not attempt to clean your computer while it is turned on.

- Turn off the computer.
- Disconnect AC power.
- Disconnect all powered external devices.

**⚠ CAUTION:** To prevent damage to internal components, do not spray cleaning agents or liquids directly on any computer surface. Liquids dripped on the surface can permanently damage internal components.

---

## Cleaning the display (All-in-Ones or Notebooks)

Gently wipe the display using a soft, lint-free cloth moistened with an alcohol-free glass cleaner. Be sure that the display is dry before closing the display.

## Cleaning the sides or cover

To clean the sides or cover, use a soft microfiber cloth or chamois moistened with one of the cleaning solutions listed previously or use an acceptable disposable wipe.

---

**📝 NOTE:** When cleaning the cover of the computer, use a circular motion to aid in removing dirt and debris.

---

## Cleaning the TouchPad, keyboard, or mouse

---

**⚠ WARNING!** To reduce the risk of electric shock or damage to internal components, do not use a vacuum cleaner attachment to clean the keyboard. A vacuum cleaner can deposit household debris on the keyboard surface.

**⚠ CAUTION:** To prevent damage to internal components, do not allow liquids to drip between the keys.

---

- To clean the TouchPad, keyboard, or mouse, use a soft microfiber cloth or a chamois moistened with one of the cleaning solutions listed previously or use an acceptable disposable wipe.
- To prevent keys from sticking and to remove dust, lint, and particles from the keyboard, use a can of compressed air with a straw extension.

## Traveling with or shipping your computer

If you have to travel with or ship your computer, here are some tips to keep in mind to keep your equipment safe.

- Prepare the computer for traveling or shipping:
  - Back up your information to an external drive.
  - Remove all discs and all external media cards, such as memory cards.
  - Turn off and then disconnect all external devices.
  - Shut down the computer.
- Take along a backup of your information. Keep the backup separate from the computer.
- When traveling by air, carry the computer as hand luggage; do not check it in with the rest of your luggage.

---

**⚠ CAUTION:** Avoid exposing a drive to magnetic fields. Security devices with magnetic fields include airport walk-through devices and security wands. Airport conveyer belts and similar security devices that check carry-on baggage use X-rays instead of magnetism and do not damage drives.

---

- If you plan to use the computer during a flight, listen for the in-flight announcement that tells you when you are allowed to use your computer. In-flight computer use is at the discretion of the airline.
- If you are shipping the computer or a drive, use suitable protective packaging and label the package “FRAGILE.”
- If the computer has a wireless device installed, the use of these devices may be restricted in some environments. Such restrictions may apply aboard aircraft, in hospitals, near explosives, and in hazardous locations. If you are uncertain of the policy that applies to the use of a particular device, ask for authorization to use your computer before you turn it on.
- If you are traveling internationally, follow these suggestions:
  - Check the computer-related customs regulations for each country or region on your itinerary.
  - Check the power cord and adapter requirements for each location in which you plan to use the computer. Voltage, frequency, and plug configurations vary.

---

**⚠ WARNING!** To reduce the risk of electric shock, fire, or damage to the equipment, do not attempt to power the computer with a voltage converter kit sold for appliances.

---

# 8 Securing your computer and information

Computer security is essential for protecting the confidentiality, integrity, and availability of your information. Standard security solutions provided by the Windows operating system, HP applications, the non-Windows Setup Utility (BIOS), and other third-party software can help protect your computer from a variety of risks, such as viruses, worms, and other types of malicious code.



**IMPORTANT:** Some security features listed in this chapter may not be available on your computer.

Computer risk	Security feature
Unauthorized use of the computer	Power-on password
Computer viruses	Antivirus software
Unauthorized access to data	Firewall software
Unauthorized access to Setup Utility (BIOS) settings and other system identification information	Administrator password
Ongoing or future threats to the computer	Software updates
Unauthorized access to a Windows user account	User password
Unauthorized removal of the computer	Security cable lock

## Using passwords

A password is a group of characters that you choose to secure your computer information and to protect online transactions. Several types of passwords can be set. For example, when you set up your computer for the first time, you were asked to create a user password to secure your computer. Additional passwords can be set in Windows or in the HP Setup Utility (BIOS) that is preinstalled on your computer.

You may find it helpful to use the same password for a Setup Utility (BIOS) feature and for a Windows security feature.

Use the following tips for creating and saving passwords:

- To reduce the risk of being locked out of the computer, record each password and store it in a secure place away from the computer. Do not store passwords in a file on the computer.
- When creating passwords, follow requirements set by the program.
- Change your passwords at least every three months.
- An ideal password is long and has letters, punctuation, symbols, and numbers.
- Before you send your computer for service, back up your files, delete confidential files, and then remove all password settings.

For additional information about Windows passwords, such as screen-saver passwords, from the Start screen, type `support`, and then select the **HP Support Assistant** app.

## Setting Windows passwords

Password	Function
User password	Protects access to a Windows user account.
Administrator password	Protects administrator-level access to computer contents.  <b>NOTE:</b> This password cannot be used to access Setup Utility (BIOS) contents.

## Setting Setup Utility (BIOS) passwords

Password	Function
Administrator password	<ul style="list-style-type: none"><li>• Must be entered each time you access Setup Utility (BIOS).</li><li>• If you forget your administrator password, you cannot access Setup Utility (BIOS).</li></ul> <p><b>NOTE:</b> The administrator password can be used in place of the power-on password.</p> <p><b>NOTE:</b> Your administrator password is not interchangeable with an administrator password set in Windows, nor is it revealed as it is set, entered, changed, or deleted.</p> <p><b>NOTE:</b> If you enter the power-on password at the first password check, you must enter the administrator password to access Setup Utility (BIOS).</p>
Power-on password	<ul style="list-style-type: none"><li>• Must be entered each time you turn on or restart the computer.</li><li>• If you forget your power-on password, you cannot turn on or restart the computer.</li></ul> <p><b>NOTE:</b> The administrator password can be used in place of the power-on password.</p> <p><b>NOTE:</b> A power-on password is not revealed as it is set, entered, changed, or deleted.</p>

To set, change, or delete an administrator or power-on password in Setup Utility (BIOS):

1. To start Setup Utility (BIOS), turn on or restart the computer, quickly press **esc**, and then press **f10**.
2. Use the arrow keys to select **Security**, and then follow the on-screen instructions.

Your changes take effect when the computer restarts.

## Using Internet security software

When you use your computer to access email, a network, or the Internet, you potentially expose your computer to computer viruses, spyware, and other online threats. To help protect your computer, Internet security software that includes antivirus and firewall features may be preinstalled on your computer as a trial offer. To provide ongoing protection against newly discovered viruses and other security risks, security software must be kept up to date. It is strongly recommended that you upgrade

the security software trial offer or purchase the software of your choice in order to fully protect your computer.

## Using antivirus software

Computer viruses can disable programs, utilities, or the operating system, or cause them to function abnormally. Antivirus software can detect most viruses, destroy them, and in most cases, repair any damage they have caused.

To provide ongoing protection against newly discovered viruses, antivirus software must be kept up to date.

An antivirus program may be preinstalled on your computer. It is strongly recommended that you use the antivirus program of your choice in order to fully protect your computer.

For more information about computer viruses, from the Start screen, type `support`, and then select the **HP Support Assistant** app.

## Using firewall software

Firewalls are designed to prevent unauthorized access to a system or network. A firewall can be software you install on your computer and/or network, or it can be a combination of both hardware and software.

There are two types of firewalls to consider:

- Host-based firewalls—Software that protects only the computer it is installed on.
- Network-based firewalls—Installed between your DSL or cable modem and your home network to protect all the computers on the network.

When a firewall is installed on a system, all data sent to and from the system is monitored and compared with a set of user-defined security criteria. Any data that does not meet those criteria is blocked.

## Installing software updates

HP, Windows, and third-party software installed on your computer should be regularly updated to correct security problems and improve software performance. For more information, see [Updating programs and drivers on page 55](#).

## Installing critical security updates

---

 **CAUTION:** Microsoft sends out alerts regarding critical updates. To protect the computer from security breaches and computer viruses, install all critical updates from Microsoft as soon as you receive an alert.

---

You can choose whether updates are installed automatically. To change the settings, from the Start screen, type `control panel`, and then select **Control Panel**. Select **System and Security**, select **Windows Update**, select **Change settings**, and then follow the on-screen instructions.

## Installing HP and third-party software updates

HP recommends that you regularly update the software and drivers that were originally installed on your computer. To download the latest versions, go to <http://www.hp.com/support>. At this location, you can also register to receive automatic update notifications when they become available.



If you have installed third-party software after you purchased your computer, regularly update the software. Software companies provide software updates to their products to correct security problems and improve functionality of the software.

## Securing your wireless network

When you set up your wireless network, always enable security features. For more information, see [Protecting your WLAN on page 17](#).

## Backing up your software applications and information

Regularly back up your software applications and information to protect them from being permanently lost or damaged through a virus attack or a software or hardware failure. For more information, see [Backing up, restoring, and recovering on page 65](#).

## Using an optional security cable lock

A security cable lock, which is purchased separately, is designed to act as a deterrent, but it may not prevent the computer from being mishandled or stolen. Security cable locks are only one of several methods that should be employed as part of a complete security solution to help maximize theft protection.

The security cable slot on your computer may look slightly different from the illustration in this section. For the location of the security cable slot on your computer, see [Getting to know your computer on page 5](#).

1. Loop the security cable lock around a secured object.
2. Insert the key (1) into the security cable lock (2).
3. Insert the security cable lock into the security cable slot on the computer (3), and then lock the security cable lock with the key.

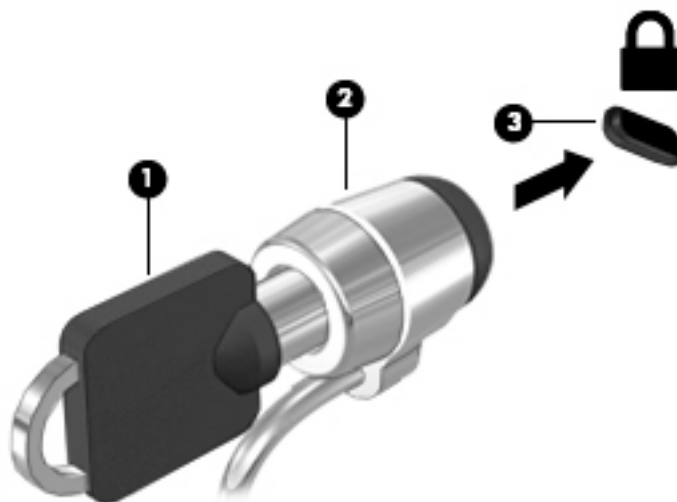

4. Remove the key and keep it in a safe place.

---

# 9 Using Setup Utility (BIOS) and HP PC Hardware Diagnostics (UEFI)

Setup Utility, or Basic Input/Output System (BIOS), controls communication between all the input and output devices on the system (such as disk drives, display, keyboard, mouse, and printer). Setup Utility (BIOS) includes settings for the types of devices installed, the startup sequence of the computer, and the amount of system and extended memory.

## Starting Setup Utility (BIOS)

To start Setup Utility (BIOS), turn on or restart the computer, quickly press **esc**, and then press **f10**.

---

 **NOTE:** Use extreme care when making changes in Setup Utility (BIOS). Errors can prevent the computer from operating properly.

---

## Updating the BIOS

Updated versions of the BIOS may be available on the HP website.

Most BIOS updates on the HP website are packaged in compressed files called *SoftPaqs*.

Some download packages contain a file named *Readme.txt*, which contains information regarding installing and troubleshooting the file.

## Determining the BIOS version

To determine whether available BIOS updates contain later BIOS versions than those currently installed on the computer, you need to know the version of the system BIOS currently installed.

BIOS version information (also known as *ROM date* and *System BIOS*) can be revealed by pressing **fn+esc** (if you are already in Windows) or by using Setup Utility (BIOS).

1. Start Setup Utility (BIOS) (see [Starting Setup Utility \(BIOS\) on page 62](#)).
2. Use the arrow keys to select **Main**, and then make note of your current BIOS version.
3. To exit Setup Utility (BIOS) without saving your changes, use the arrow keys to select **Exit**, select **Exit Discarding Changes**, and then press **enter**.
4. Select **Yes**.

## Downloading a BIOS update

 **CAUTION:** To reduce the risk of damage to the computer or an unsuccessful installation, download and install a BIOS update only when the computer is connected to reliable external power using the AC adapter. Do not download or install a BIOS update while the computer is running on battery power, docked in an optional docking device, or connected to an optional power source. During the download and installation, follow these instructions:

Do not disconnect power from the computer by unplugging the power cord from the AC outlet.

Do not shut down the computer or initiate Sleep.

Do not insert, remove, connect, or disconnect any device, cable, or cord.

1. From the Start screen, type `support`, and then select the **HP Support Assistant** app.
2. Click **Updates and tune-ups**, and then click **Check for HP updates now**.
3. Follow the on-screen instructions.
4. At the download area, follow these steps:
  - a. Identify the most recent BIOS update and compare it to the BIOS version currently installed on your computer. If the update is more recent than your BIOS, make a note of the date, name, or other identifier. You may need this information to locate the update later, after it has been downloaded to your hard drive.
  - b. Follow the on-screen instructions to download your selection to the hard drive.

If the update is more recent than your BIOS, make a note of the path to the location on your hard drive where the BIOS update is downloaded. You will need to access this path when you are ready to install the update.

 **NOTE:** If you connect your computer to a network, consult the network administrator before installing any software updates, especially system BIOS updates.

BIOS installation procedures vary. Follow any instructions that are revealed on the screen after the download is complete. If no instructions are revealed, follow these steps:

1. From the Start screen, type `file`, and then select **File Explorer**.
2. Click your hard drive designation. The hard drive designation is typically Local Disk (C:).
3. Using the hard drive path you recorded earlier, open the folder on your hard drive that contains the update.
4. Double-click the file that has an `.exe` extension (for example, `filename.exe`).

The BIOS installation begins.
5. Complete the installation by following the on-screen instructions.

 **NOTE:** After a message on the screen reports a successful installation, you can delete the downloaded file from your hard drive.

## Using HP PC Hardware Diagnostics (UEFI)

HP PC Hardware Diagnostics is a Unified Extensible Firmware Interface (UEFI) that allows you to run diagnostic tests to determine whether the computer hardware is functioning properly. The tool runs outside the operating system so that it can isolate hardware failures from issues that are caused by the operating system or other software components.

To start HP PC Hardware Diagnostics UEFI:

1. Turn on or restart the computer, quickly press **esc**, and then press **f2**.

The BIOS searches three places for the diagnostic tools, in the following order:

- a. Connected USB drive



**NOTE:** To download the HP PC Hardware Diagnostics (UEFI) tool to a USB drive, see [Downloading HP PC Hardware Diagnostics \(UEFI\) to a USB device on page 64](#).

- b. Hard drive
- c. BIOS

2. When the diagnostic tool opens, use the keyboard arrow keys to select the type of diagnostic test you want to run, and then follow the on-screen instructions.



**NOTE:** If you need to stop a diagnostic test, press **esc**.

## Downloading HP PC Hardware Diagnostics (UEFI) to a USB device



**NOTE:** Instructions for downloading HP PC Hardware Diagnostics (UEFI) are provided in English only.

There are two options to download HP PC Hardware Diagnostics to a USB device:

**Option 1: HP PC Diagnostics homepage**— Provides access to the latest UEFI version

1. Go to <http://hp.com/go/techcenter/pcdiags>.
2. Click the **UEFI Download** link, and then select **Run**.

**Option 2: Support and Drivers page**—Provides downloads for a specific product for earlier and later versions

1. Go to <http://www.hp.com>.
2. Point to **Support**, located at the top of the page, and then click **Download Drivers**.
3. In the text box, enter the product name, and then click **Go**.

– or –

Click **Find Now** to let HP automatically detect your product.

4. Select your computer model, and then select your operating system.
5. In the **Diagnostic** section, click **HP UEFI Support Environment**.

– or –

Click **Download**, and then select **Run**.

---

# 10 Backing up, restoring, and recovering

This chapter provides information about the following processes:

- Creating recovery media and backups
- Restoring and recovering your system

## Creating recovery media and backups

1. After you successfully set up the computer, create HP Recovery media. This step creates a backup of the HP Recovery partition on the computer. The backup can be used to reinstall the original operating system in cases where the hard drive is corrupted or has been replaced.

HP Recovery media you create will provide the following recovery options:

- **System Recovery**—Reinstalls the original operating system and the programs that were installed at the factory.
- **Minimized Image Recovery**—Reinstalls the operating system and all hardware-related drivers and software, but not other software applications.
- **Factory Reset**—Restores the computer to its original factory state by deleting all information from the hard drive and re-creating the partitions. Then it reinstalls the operating system and the software that was installed at the factory.

See [Creating HP Recovery media on page 65](#).

2. Use the Windows tools to create system restore points and create backups of personal information. For more information and steps, see Help and Support. From the Start screen, type `help`, and then select **Help and Support**.

## Creating HP Recovery media

HP Recovery Manager is a software program that offers a way to create recovery media after you successfully set up the computer. HP Recovery media can be used to perform system recovery if the hard drive becomes corrupted. System recovery reinstalls the original operating system and the software programs installed at the factory, and then configures the settings for the programs. HP Recovery media can also be used to customize the system or restore the factory image if you replace the hard drive.

- Only one set of HP Recovery media can be created. Handle these recovery tools carefully, and keep them in a safe place.
- HP Recovery Manager examines the computer and determines the required storage capacity for the blank USB flash drive or the number of blank DVD discs that will be required.
- To create recovery discs, your computer must have an optical drive with DVD writer capability, and you must use only high-quality blank DVD-R, DVD+R, DVD-R DL, or DVD+R DL discs. Do not use rewritable discs such as CD±RW, DVD±RW, double-layer DVD±RW, or BD-RE (rewritable Blu-ray) discs; they are not compatible with HP Recovery Manager software. Or instead you can use a high-quality blank USB flash drive.
- If your computer does not include an integrated optical drive with DVD writer capability, but you would like to create DVD recovery media, you can use an external optical drive (purchased

separately) to create recovery discs, or you can obtain recovery discs for your computer from support. See the *Worldwide Telephone Numbers* booklet included with the computer. You can also find contact information from the HP website. Go to <http://www.hp.com/support>, select your country or region, and follow the on-screen instructions. If you use an external optical drive, it must be connected directly to a USB port on the computer; the drive cannot be connected to a USB port on an external device, such as a USB hub.

- Be sure that the computer is connected to AC power before you begin creating the recovery media.
- The creation process can take up to an hour or more. Do not interrupt the creation process.
- If necessary, you can exit the program before you have finished creating all of the recovery DVDs. HP Recovery Manager will finish burning the current DVD. The next time you start HP Recovery Manager, you will be prompted to continue, and the remaining discs will be burned.

To create HP Recovery media:



---

**IMPORTANT:** For tablets, connect to the keyboard dock before beginning these steps (select models only).

---

1. From the Start screen, type `recovery`, and then select **HP Recovery Manager**.
2. Select **Recovery Media Creation**, and then follow the on-screen instructions.

If you ever need to recover the system, see [Recovering using HP Recovery Manager on page 67](#).

## Restore and recovery

There are several options for recovering your system. Choose the method that best matches your situation and level of expertise:

- Windows offers several options for restoring from backup, refreshing the computer, and resetting the computer to its original state. For more information and steps, see Help and Support. From the Start screen, type `help`, and then select **Help and Support**.
- If you need to correct a problem with a preinstalled application or driver, use the Drivers and Applications Reinstall option of HP Recovery Manager to reinstall the individual application or driver.

From the Start screen, type `recovery`, select **HP Recovery Manager**, select **Drivers and Applications Reinstall**, and then follow the on-screen instructions.

- If you want to reset your computer using a minimized image, you can choose the HP Minimized Image Recovery option from the HP Recovery partition (select models only) or HP Recovery media. Minimized Image Recovery installs only drivers and hardware-enabling applications. Other applications included in the image continue to be available for installation through the Drivers and Applications Reinstall option in HP Recovery Manager.

For more information, see [Recovering using HP Recovery Manager on page 67](#).

- If you want to recover the computer's original factory partitioning and content, you can choose the System Recovery option from the HP Recovery partition (select models only) or use the HP Recovery media that you have created. For more information, see [Recovering using HP Recovery Manager on page 67](#). If you have not already created recovery media, see [Creating HP Recovery media on page 65](#).

- If you have replaced the hard drive, you can use the Factory Reset option of HP Recovery media to restore the factory image to the replacement drive. For more information, see [Recovering using HP Recovery Manager on page 67](#).
- If you wish to remove the recovery partition to reclaim hard drive space, HP Recovery Manager offers the Remove Recovery Partition option.

For more information, see [Removing the HP Recovery partition \(select models only\) on page 68](#).

## Recovering using HP Recovery Manager

HP Recovery Manager software allows you to recover the computer to its original factory state by using the HP Recovery media that you created or by using the HP Recovery partition (select models only). If you have not already created recovery media, see [Creating HP Recovery media on page 65](#).

Using HP Recovery media, you can choose from one of the following recovery options:

- System Recovery—Reinstalls the original operating system, and then configures the settings for the programs that were installed at the factory.
- Minimized Image Recovery (select models only)—Reinstalls the operating system and all hardware-related drivers and software, but not other software applications.
- Factory Reset—Restores the computer to its original factory state by deleting all information from the hard drive and re-creating the partitions. Then it reinstalls the operating system and the software that was installed at the factory.

The HP Recovery partition (select models only) allows System Recovery and Minimized Image Recovery.

## What you need to know

- HP Recovery Manager recovers only software that was installed at the factory. For software not provided with this computer, you must either download the software from the manufacturer's website or reinstall the software from the media provided by the manufacturer.
- Recovery through HP Recovery Manager should be used as a final attempt to correct computer issues.
- HP Recovery media must be used if the computer hard drive fails. If you have not already created recovery media, see [Creating HP Recovery media on page 65](#).
- To use the Factory Reset option, you must use HP Recovery media. If you have not already created recovery media, see [Creating HP Recovery media on page 65](#).
- If the HP Recovery media does not work, you can obtain recovery media for your system from support. See the *Worldwide Telephone Numbers* booklet included with the computer. You can also find contact information from the HP website. Go to <http://www.hp.com/support>, select your country or region, and follow the on-screen instructions.



---

**IMPORTANT:** HP Recovery Manager does not automatically provide backups of your personal data. Before beginning recovery, back up any personal data you wish to retain.

---

## Using the HP Recovery partition (select models only)

The HP Recovery partition (select models only) allows you to perform a system recovery or minimized image recovery without the need for recovery discs or a recovery USB flash drive. This type of recovery can only be used if the hard drive is still working.

To start HP Recovery Manager from the HP Recovery partition:

---

 **IMPORTANT:** For tablets, connect to the keyboard dock before beginning these steps (select models only).

---

1. Press **f11** while the computer boots.  
– or –  
Press and hold **f11** as you press the power button.
2. Select **Troubleshoot** from the boot options menu.
3. Select **Recovery Manager**, and then follow the on-screen instructions.

## Using HP Recovery media to recover

You can use HP Recovery media to recover the original system. This method can be used if your system does not have an HP Recovery partition or if the hard drive is not working properly.

1. If possible, back up all personal files.
2. Insert the HP Recovery media that you created, and then restart the computer.

---

 **NOTE:** If the computer does not automatically restart in HP Recovery Manager, change the computer boot order. See [Changing the computer boot order on page 68](#).

---

3. Follow the on-screen instructions.

## Changing the computer boot order

If computer does not restart in HP Recovery Manager, you can change the computer boot order, which is the order of devices listed in BIOS where the computer looks for startup information. You can change the selection for an optical drive or a USB flash drive.

To change the boot order:

1. Insert the HP Recovery media you created.
2. Restart the computer, quickly press **esc**, and then press **f9** for boot options.
3. Select the optical drive or USB flash drive you want to boot from.
4. Follow the on-screen instructions.

## Removing the HP Recovery partition (select models only)

HP Recovery Manager software allows you to remove the HP Recovery partition to free up hard drive space.

---

 **IMPORTANT:** After you remove the HP Recovery partition, you can no longer use the Windows Refresh option or the Windows option to remove everything and reinstall Windows. In addition, you will not be able to perform System Recovery or Minimized Image Recovery from the HP Recovery partition. So before you remove the Recovery partition, create HP Recovery media; see [Creating HP Recovery media on page 65](#).

---

Follow these steps to remove the HP Recovery partition:

1. From the Start screen, type `recovery`, and then select **HP Recovery Manager**.
2. Select **Remove Recovery Partition**, and then follow the on-screen instructions.



# 11 Specifications

## Input power

The power information in this section may be helpful if you plan to travel internationally with the computer.

The computer operates on DC power, which can be supplied by an AC or a DC power source. The AC power source must be rated at 100–240 V, 50–60 Hz. Although the computer can be powered from a standalone DC power source, it should be powered only with an AC adapter or a DC power source supplied and approved by HP for use with this computer.

The computer can operate on DC power within the following specifications. Operating voltage and current varies by platform.

Input power	Rating
Operating voltage and current	19.5 V dc @ 2.31 A – 45 W
	19.5 V dc @ 3.33 A – 65 W
	19.5 V dc @ 4.62 A – 90 W
DC plug of external HP power supply	

 **NOTE:** This product is designed for IT power systems in Norway with phase-to-phase voltage not exceeding 240 V rms.

 **NOTE:** The computer operating voltage and current can be found on the system regulatory label.

## Operating environment

Factor	Metric	U.S.
<b>Temperature</b>		
Operating	5°C to 35°C	41°F to 95°F
Nonoperating	-20°C to 60°C	-4°F to 140°F
<b>Relative humidity</b> (noncondensing)		
Operating	10% to 90%	10% to 90%
Nonoperating	5% to 95%	5% to 95%
<b>Maximum altitude</b> (unpressurized)		

Operating	<b>-15 m to 3,048 m</b>	-50 ft to 10,000 ft
Nonoperating	<b>-15 m to 12,192 m</b>	-50 ft to 40,000 ft

---

## 12 Electrostatic Discharge

Electrostatic discharge is the release of static electricity when two objects come into contact—for example, the shock you receive when you walk across the carpet and touch a metal door knob.

A discharge of static electricity from fingers or other electrostatic conductors may damage electronic components. To prevent damage to the computer, damage to a drive, or loss of information, observe these precautions:

- If removal or installation instructions direct you to unplug the computer, first be sure that it is properly grounded, and then remove the cover.
- Keep components in their electrostatic-safe containers until you are ready to install them.
- Avoid touching pins, leads, and circuitry. Handle electronic components as little as possible.
- Use nonmagnetic tools.
- Before handling components, discharge static electricity by touching an unpainted metal surface of the component.
- If you remove a component, place it in an electrostatic-safe container.

---

# 13 Accessibility

HP designs, produces, and markets products and services that can be used by everyone, including people with disabilities, either on a stand-alone basis or with appropriate assistive devices.

## Supported assistive technologies

HP products support a wide variety of operating system assistive technologies and can be configured to work with additional assistive technologies. Use the Search feature on your device to locate more information about assistive features.



**NOTE:** For additional information about a particular assistive technology product, contact customer support for that product.

---

## Contacting support

We are constantly refining the accessibility of our products and services and welcome feedback from users. If you have an issue with a product or would like to tell us about accessibility features that have helped you, please contact us at (888) 259-5707, Monday through Friday, 6 a.m. to 9 p.m. Mountain Time. If you are deaf or hard-of-hearing and use TRS/VRS/WebCapTel, contact us if you require technical support or have accessibility questions by calling (877) 656-7058, Monday through Friday, 6 a.m. to 9 p.m. Mountain Time.

---

# Index

## Symbols/Numerics

2-finger pinch zoom TouchPad gesture 29, 37

## A

AC adapter 7  
AC adapter, testing 47  
accessibility 72  
action keys  
    decrease screen brightness 40  
    Help and Support 40  
    identifying 12  
    increase screen brightness 40  
    next track or section 40  
    play, pause, resume 40  
    previous track or section 40  
    switch screen image 40  
    volume down 40  
    volume mute 40  
    volume up 40  
    wireless 40  
airport security devices 51  
AMD Dual Graphics 49  
antivirus software, using 60  
assistive technologies, supported 72  
audio features, testing 22  
audio-out (headphone)/audio-in (microphone) jack 6, 21

## B

backing up software and information 61  
backups 65  
battery  
    discharging 45  
    disposing 46  
    low battery levels 45  
    replacing 47  
    storing 46  
battery cover, identifying 13  
battery information, finding 45  
battery lock, identifying 13  
battery power 44

battery release latch 13  
battery temperature 46  
Beats Audio 22  
Beats Audio Control Panel 22  
Beats Audio hot key 22  
BIOS  
    determining version 62  
    downloading an update 63  
    updating 62  
Bluetooth label 14  
boot order  
    changing HP Recovery Manager 68  
bottom 14  
buttons  
    left TouchPad 9  
    power 11  
    right TouchPad 9

## C

caps lock light, identifying 10  
caring for your computer 55  
cleaning your computer 55  
components  
    bottom 13  
    display 8  
    left side 7  
    right side 6  
    top 9  
computer, traveling 46  
connecting to a WLAN 18  
connector, power 7  
contacting support 72  
corporate WLAN connection 18  
critical battery level 46  
critical security updates, installing 60

## D

deleted files  
    restoring 66  
Disk Cleanup software 52  
Disk Defragmenter software 52

## E

edge swipe gestures 38  
edge—swipe gestures  
    top-edge swipe 39  
electrostatic discharge 71  
esc key, identifying 12  
external AC power, using 47

## F

firewall software 60  
fn key, identifying 12, 40  
Fun things to do 1

## G

graphics  
    AMD Dual Graphics 49  
    Hybrid Graphics 49

## H

hard drive  
    HP 3D DriveGuard 51  
hard drive light 6  
HDMI  
    configuring audio 24  
HDMI port  
    connecting 23  
    identifying 7, 21  
headphones and microphones, connecting 22  
Hibernation  
    exiting 43  
    initiated during critical battery level 46  
    initiating 43  
high-definition devices, connecting 23, 24  
hot keys  
    description 40  
    using 41  
HP 3D DriveGuard 51  
HP and third-party software updates, installing 60

- HP PC Hardware Diagnostics (UEFI)
    - downloading 64
    - using 63
  - HP Recovery Manager
    - correcting boot problems 68
    - starting 68
  - HP Recovery media
    - creating 65
    - recovery 68
  - HP Recovery partition
    - recovery 67
    - removing 68
  - Hybrid Graphics 49
- I**
- input power 69
  - installing
    - critical security updates 60
    - optional security cable lock 61
  - internal display switch, identifying 8
  - internal microphones, identifying 8, 20
  - Internet connection setup 17
  - Internet security software, using 59
- J**
- jacks
    - audio-out (headphone)/audio-in (microphone) 6, 21
    - network 7, 21
    - RJ-45 (network) 7, 21
- K**
- keyboard hot keys, identifying 40
  - keys
    - action 12
    - esc 12
    - fn 12
    - Windows 12
- L**
- labels
    - Bluetooth 14
    - Microsoft Certificate of Authenticity 14
    - regulatory 14
    - serial number 14
    - service 14
    - wireless certification 14
    - WLAN 14
  - LAN, connecting 18
  - latch, battery release 13
  - left-edge swipe 38
  - lights
    - AC adapter 7
    - caps lock 10
    - hard drive 6
    - mute 10
    - power 6, 10
  - low battery level 45
- M**
- maintenance
    - Disk Cleanup 52
    - Disk Defragmenter 52
  - memory card reader, identifying 7
  - memory card, identifying 7
  - memory module
    - identifying 13
    - inserting 54
    - removing 53
    - replacing 52
  - memory module service door, removing 53
  - minimized image
    - creating 67
  - minimized image recovery 67
  - Miracast 24
  - mouse, external
    - setting preferences 26
  - mute light, identifying 10
- N**
- network jack, identifying 7, 21
- O**
- operating environment 69
  - optical drive, identifying 6, 7, 20
  - original system recovery 67
- P**
- passwords
    - Setup Utility (BIOS) 59
    - Windows 59
  - ports
    - HDMI 7, 21, 23
    - Miracast 24
    - USB 2.0 6
    - USB 3.0 7, 21
  - power
    - battery 44
    - power button, identifying 11
    - power connector, identifying 7
    - power lights, identifying 6, 10
    - product name and number, computer 14
    - public WLAN connection 18
- R**
- recovery
    - discs 65, 68
    - HP Recovery Manager 67
    - media 68
    - options 66
    - starting 68
    - supported discs 65
    - system 67
    - USB flash drive 68
    - using HP Recovery media 66
  - recovery media
    - creating 65
    - creating using HP Recovery Manager 66
  - recovery partition
    - removing 68
  - regulatory information
    - regulatory label 14
    - wireless certification labels 14
  - restore
    - Windows File History 66
  - right-edge swipe 38
  - RJ-45 (network) jack, identifying 7, 21
  - rotating TouchPad gesture 31
- S**
- scrolling TouchPad gesture 28
  - security cable lock, installing 61
  - security cable slot, identifying 7
  - security, wireless 17
  - serial number 14
  - serial number, computer 14
  - service labels
    - locating 14
  - setting password protection on
    - wakeup 43
  - setup of WLAN 17

- Setup Utility (BIOS) passwords 59
- shipping the computer 57
- shutdown 48
- Sleep
  - exiting 43
  - initiating 43
- slots
  - memory card reader 7
  - security cable 7
- software
  - Disk Cleanup 52
  - Disk Defragmenter 52
- software updates, installing 60
- speakers
  - connecting 22
  - identifying 11, 20
- storing a battery 46
- supported discs
  - recovery 65
- system recovery 67
- system restore point
  - creating 65

## T

- temperature 46
- testing an AC adapter 47
- testing audio features 22
- Touch screen
  - using 34
- Touch screen gestures 38, 39
  - edge-swipe gestures 38
  - one-finger slide 34
  - rotating 37
  - scrolling 36
  - tapping 36
- TouchPad
  - buttons 9
- TouchPad gestures
  - 2-finger pinch zoom 29, 37
  - rotating 31
  - scrolling 28
- TouchPad zone, identifying 9
- traveling with the computer 14, 46, 57
- turning off the computer 48

## U

- unresponsive system 48
- USB 2.0 port, identifying 6

- USB 3.0 port, identifying 7
- USB 3.0 ports, identifying 21
- using external AC power 47
- using passwords 58

## V

- vents, identifying 7, 13
- video 23

## W

- webcam
  - identifying 8, 20
  - using 21
- webcam light, identifying 8, 20
- Windows
  - File History 66
  - restoring files 66
  - system restore point 65
- Windows key, identifying 12
- Windows passwords 59
- Wireless Assistant software 15
- wireless button 15
- wireless certification label 14
- wireless controls
  - button 15
  - operating system 15
  - Wireless Assistant software 15
- wireless light 15
- wireless network (WLAN)
  - connecting 18
  - corporate WLAN connection 18
  - equipment needed 17
  - functional range 18
  - public WLAN connection 18
  - security 17
  - using 16
- wireless network, securing 61
- WLAN antennas, identifying 8
- WLAN device 14, 16
- WLAN label 14