

User Guide

© Copyright 2012 - 2014 Hewlett-Packard Development Company, L.P.

Bluetooth is a trademark owned by its proprietor and used by Hewlett-Packard Company under license.

The information contained herein is subject to change without notice. The only warranties for HP products and services are set forth in the express warranty statements accompanying such products and services. Nothing herein should be construed as constituting an additional warranty. HP shall not be liable for technical or editorial errors or omissions contained herein.

Fourth Edition: September 2014

First Edition: November 2012

Document Part Number: 709332-004

Product notice

This guide describes features that are common to most models. Some features may not be available on your computer.

To access the latest user guide, go to <http://www.hp.com/support>, and select your country. Select **Drivers & Downloads**, and then follow the on-screen instructions.

Software terms

By installing, copying, downloading, or otherwise using any software product preinstalled on this computer, you agree to be bound by the terms of the HP End User License Agreement (EULA). If you do not accept these license terms, your sole remedy is to return the entire unused product (hardware and software) within 14 days for a refund subject to the refund policy of your place of purchase.

For any further information or for requesting a full refund of the computer, please contact your local point of sale (the seller).

Safety warning notice

 **WARNING!** To reduce the possibility of heat-related injuries or of overheating the computer, do not place the computer directly on your lap or obstruct the computer air vents. Use the computer only on a hard, flat surface. Do not allow another hard surface, such as an adjoining optional printer, or a soft surface, such as pillows or rugs or clothing, to block airflow. Also, do not allow the AC adapter to come into contact with the skin or a soft surface, such as pillows or rugs or clothing, during operation. The computer and the AC adapter comply with the user-accessible surface temperature limits defined by the International Standard for Safety of Information Technology Equipment (IEC 60950-1).

Table of contents

1 Starting right	1
Best practices	1
Fun things to do	1
More HP resources	2
Finding your hardware and software information	3
2 Connecting to a network	4
Connecting to a wireless network	4
Identifying wireless and network status icons	4
Using the wireless controls	4
Using the wireless button	4
Using operating system controls	5
Using a WLAN	5
Using an Internet service provider	5
Setting up a WLAN	5
Configuring a wireless router	6
Protecting your WLAN	6
Connecting to a WLAN	7
Using Bluetooth wireless devices	7
Connecting to a wired network	7
Connecting to a local area network (LAN)	8
3 Enjoying entertainment features	9
Using the webcam	9
Using audio	9
Connecting speakers	9
Connecting headphones	9
Connecting a microphone	9
Checking the sound	10
Using video	10
Connecting a VGA monitor or projector	10
DisplayPort	12
Connecting an HDMI TV or monitor	12
Configuring audio settings (with HDMI TV)	13

4 Using the keyboard and pointing devices	14
Using the action keys	14
Using the TouchPad	15
Navigating	15
Selecting	16
Using TouchPad gestures	16
Horizontal scrolling	16
Edge scrolling	17
5 Managing power	18
Shutting down the computer	18
Setting power options	18
Using power-saving states	18
Initiating and exiting Suspend	19
Initiating and exiting Hibernation or Hybrid Sleep (select models only)	19
Using the Power icon	20
Using Power Settings	20
Viewing the current Power Settings	20
Changing the current Power Settings	20
Running on battery power	20
Factory-sealed battery (select models only)	20
Removing a user-replaceable battery (select models only)	21
Displaying the remaining battery charge	21
Charging a battery	21
Maximizing battery life	21
Managing low battery levels	22
Identifying low battery levels	22
Resolving a low battery level	22
Resolving a low battery level when external power is available	22
Resolving a low battery level when a charged battery is available ...	22
Conserving battery power	22
Storing a battery	22
Disposing of a used battery	23
Replacing the battery	23
Using external AC power	23
Testing an AC adapter	23
6 Managing and sharing information	25
Using a USB device	25
Connecting a USB device	25

Removing a USB device	26
Inserting and removing a digital storage card	27
Using optical drives	28
Inserting an optical disc	28
Tray-load	28
Slot-load	29
Removing an optical disc	29
Tray-load	29
When the disc tray opens normally	29
When the disc tray fails to open normally	30
Slot-load	31
7 Maintaining your computer	32
Updating programs and drivers	32
Cleaning your computer	32
Cleaning procedures	32
Cleaning the display (All-in-Ones or Notebooks)	33
Cleaning the sides or cover	33
Cleaning the TouchPad, keyboard, or mouse	33
Traveling with or shipping your computer	33
8 Securing your computer and information	35
Protecting the computer	35
Using passwords	35
Setting passwords in the operating system	36
Setting passwords in Setup Utility (BIOS) and Computer Setup	36
Managing an administrator password	36
Entering an administrator password	37
Managing a power-on password	37
Entering a power-on password	37
Using Internet security software	37
Using antivirus software	37
Using firewall software	37
Securing your wireless network	38
Backing up your software applications and information	38
Using an optional security cable lock	38
9 Using Setup Utility (BIOS) and HP PC Hardware Diagnostics (UEFI)	40
Starting Setup Utility	40
Using Setup Utility	40

Changing the language of Setup Utility	40
Navigating and selecting in Setup Utility	40
Displaying system information	41
Restoring factory default settings in Setup Utility	41
Exiting Setup Utility	41
Using HP PC Hardware Diagnostics (UEFI)	41
Downloading HP PC Hardware Diagnostics (UEFI) to a USB device	42
10 Backing up, restoring, and recovering	43
Creating a restore image	43
Creating restore image on DVDs	43
Creating a restore image on a USB device	43
Restoring the original factory state	44
Backing up your data files	44
Restoring your data files	45
11 Support	46
Contacting support	46
Labels	46
12 Specifications	48
Input power	48
Operating environment	49
13 Electrostatic Discharge	50
14 Accessibility	51
Supported assistive technologies	51
Contacting support	51
Index	52

1 Starting right

 **IMPORTANT:** The Ubuntu operating system installed on this computer does not support some of the features that are available on other operating systems. For example, Ubuntu may not support switchable or dual graphics, touchscreen, WWAN, Fingerprint reader, Bluray, Trusted Platform Module, GPS and drives such as M.2 SSD and mSATA. Ubuntu also does not fully support Bluetooth.

This computer is a powerful tool designed to enhance your work and entertainment. To get the most out of your computer, read this chapter to learn about best practices after setup, fun things to do with your computer, and where to go to get more HP resources.

Best practices

To protect your smart investment, after you set up and register the computer, we recommend the following steps:

- Back up your hard drive by creating recovery discs or a recovery flash drive. See [Backing up, restoring, and recovering on page 43](#).
- If you haven't already done so, connect to a wired or wireless network. See details in [Connecting to a network on page 4](#).
- Become familiar with the computer hardware and software. Go to [Finding your hardware and software information on page 3](#) and [Enjoying entertainment features on page 9](#) for information.
- Update or purchase antivirus software. Learn more at [Using antivirus software on page 37](#).

Fun things to do

- You know you can watch a YouTube video on the computer. But did you know that you can also connect your computer to a TV and watch the video on TV? For more information, see [Connecting an HDMI TV or monitor on page 12](#).
- You know you can listen to music on the computer. But did you know that you can also stream live radio to the computer and listen to music or talk radio from all over the world? See [Using audio on page 9](#).
- You know you can create a powerful presentation with your computer. But did you know you can also connect to a projector to share your ideas with a group? See [Connecting a VGA monitor or projector on page 10](#).

More HP resources

You have already used *Setup Instructions* to turn on the computer and locate this guide. For product details, how-to information, and more, use this table.

Resource	Contents
<i>Setup Instructions</i>	<ul style="list-style-type: none">• Overview of computer setup and features.
<i>Ubuntu Desktop Guide</i> To access this guide, press the f1 key.	<ul style="list-style-type: none">• A broad range of how-to information and troubleshooting tips.
<i>Safety & Comfort Guide</i> To access this guide, double-click the HP Documents icon located on the desktop, or go to http://www.hp.com/ergo .	<ul style="list-style-type: none">• Proper workstation setup.• Guidelines for posture and work habits that increase your comfort and decrease your risk of injury.• Electrical and mechanical safety information.
Worldwide support To get support in your language, go to http://welcome.hp.com/country/us/en/wwcontact_us.html .	<ul style="list-style-type: none">• Chat online with an HP technician.• Email support.• Find worldwide support telephone numbers.• Locate HP service center locations.
<i>Regulatory, Safety and Environmental Notices</i> To access this guide, double-click the HP Documents icon located on the desktop.	<ul style="list-style-type: none">• Important regulatory notices, including proper battery disposal information.
<i>Limited Warranty*</i> To access the warranty, double-click the HP Documents icon located on the desktop, or go to http://www.hp.com/go/orderdocuments .	<ul style="list-style-type: none">• Specific warranty information about this computer.

*You can find the expressly provided HP Limited Warranty applicable to your product located with the user guides on your computer and/or on the CD/DVD provided in the box. In some countries/regions, HP may provide a printed HP Limited Warranty in the box. For countries/regions where the warranty is not provided in printed format, you may request a printed copy from <http://www.hp.com/go/orderdocuments> or write to:

- **North America:** Hewlett-Packard, MS POD, 11311 Chinden Blvd., Boise, ID 83714, USA
- **Europe, Middle East, Africa:** Hewlett-Packard, POD, Via G. Di Vittorio, 9, 20063, Cernusco s/Naviglio (MI), Italy
- **Asia Pacific:** Hewlett-Packard, POD, P.O. Box 200, Alexandra Post Office, Singapore 911507

When you request a printed copy of your warranty, please include your product part number, warranty period (found on your service label), name, and postal address.

IMPORTANT: Do not return your HP product to the addresses above. For U.S. support, go to <http://www.hp.com/go/contactHP>. For worldwide support, go to http://welcome.hp.com/country/us/en/wwcontact_us.html.

Finding your hardware and software information

1. Click the **System menu** icon at the far right of the top panel, and then click **System Settings**.
2. Select the **Details** icon from the **System** section.

The Overview displays all the devices installed in your computer, including optical drives, solid-state drives (SSDs), or a secondary hard drive.

To find out what software is included on your computer:

1. Click the **Ubuntu Software Center** button located on the left side of the desktop in the **Launcher**, and then click **Installed** at the top of the window to display software categories.
2. Click a software category to display the installed software for that category.

2 Connecting to a network



Your computer can travel with you wherever you go. But even at home, you can explore the globe and access information from millions of websites using your computer and a wired or wireless network connection. This chapter will help you get connected to that world.

Connecting to a wireless network

Wireless technology transfers data across radio waves instead of wires. Your computer may be equipped with one or more of the following wireless devices:

- **Wireless local area network (WLAN) device**—Connects the computer to wireless local area networks (commonly referred to as Wi-Fi networks, wireless LANs, or WLANs) in corporate offices, your home, and public places such as airports, restaurants, coffee shops, hotels, and universities. In a WLAN, the mobile wireless device in your computer communicates with a wireless router or a wireless access point.
- **Bluetooth® device**—Creates a personal area network (PAN) to connect to other Bluetooth-enabled devices, such as computers, phones, printers, headsets, speakers, and cameras. In a PAN, each device communicates directly with other devices, and devices must be relatively close together—typically within 10 meters (approximately 33 feet) of each other.

Identifying wireless and network status icons

Icon	Name	Description
	Wireless (connected)	Indicates that one or more wireless devices are on.
	Network Connection (connected)	Indicates that the wired network is connected and active. If both wired and wireless connections are active, the operating system uses the wired connection because it is faster.
	Network Connection (disconnected)	Indicates that wired and wireless networks are not connected.

Using the wireless controls

You can control the wireless devices in your computer using one or more of these features:

- Wireless button, wireless switch, wireless key, or airplane mode key (referred to in this chapter as the wireless button) (select models only)
- Operating system controls

Using the wireless button

Depending on your model, the computer may have a wireless button, one or more wireless devices, and one or more wireless lights. All of the wireless devices on your computer are enabled at the factory, so the wireless light is on (white) when you turn on the computer.

The wireless light indicates the overall power state of your wireless devices, not the status of individual devices. If the wireless light is white, at least one wireless device is on. If the wireless light is amber, all wireless devices are off.

Because the wireless devices are enabled at the factory, you can use the wireless button to turn on or turn off the wireless devices simultaneously. Individual wireless devices can be controlled by clicking on the **Network menu** icon  at the far right of the top panel, and then clicking **Edit Connections**.

Using operating system controls

To enable or disable a wireless or wired network device:

1. Click the **Network menu** icon at the far right of the top panel.
2. To enable or disable one of the following devices, select or clear one of the following options:
 - **Enable Networking** (all network devices)
 - **Enable Wireless**

Using a WLAN

With a WLAN device, you can access a wireless local area network (WLAN), which is composed of other computers and accessories that are linked by a wireless router or a wireless access point.

 **NOTE:** When creating a wireless connection or allowing access to users in a network, you are prompted for the root password.

 **NOTE:** The terms *wireless router* and *wireless access point* are often used interchangeably.

- A large-scale WLAN, such as a corporate or public WLAN, typically uses wireless access points that can accommodate a large number of computers and accessories and can separate critical network functions.
- A home or small office WLAN typically uses a wireless router, which allows several wireless and wired computers to share an Internet connection, a printer, and files without requiring additional pieces of hardware or software.

To use the WLAN device in your computer, you must connect to a WLAN infrastructure (provided through a service provider or a public or corporate network).

Using an Internet service provider

When you are setting up Internet access in your home, you must establish an account with an Internet service provider (ISP). To purchase Internet service and a modem, contact a local ISP. The ISP will help set up the modem, install a network cable to connect your wireless computer to the modem, and test the Internet service.

 **NOTE:** Your ISP will give you a user ID and a password to use for Internet access. Record this information and store it in a safe place.

Setting up a WLAN

To set up a WLAN and connect to the Internet, you need the following equipment:

- A broadband modem (either DSL or cable) (1) and high-speed Internet service purchased from an Internet service provider
- A wireless router (2) (purchased separately)
- A wireless computer (3)

 **NOTE:** Some modems have a built-in wireless router. Check with your ISP to determine what type of modem you have.

The illustration below shows an example of a wireless network installation that is connected to the Internet.



As your network grows, additional wireless and wired computers can be connected to the network to access the Internet.

For help in setting up your WLAN, see the information provided by your router manufacturer or your ISP.

Configuring a wireless router

For help in setting up a WLAN, see the information provided by your router manufacturer or your ISP.

 **NOTE:** It is recommended that you initially connect your new wireless computer to the router by using the network cable provided with the router. When the computer successfully connects to the Internet, disconnect the cable, and access the Internet through your wireless network.

Protecting your WLAN

When you set up a WLAN or access an existing WLAN, always enable security features to protect your network from unauthorized access. WLANs in public areas (hotspots) like coffee shops and airports may not provide any security. If you are concerned about the security of your computer in a hotspot, limit your network activities to email that is not confidential and to basic Internet surfing.

Wireless radio signals travel outside the network, so other WLAN devices can pick up unprotected signals. Take the following precautions to protect your WLAN:

- Use a firewall.

A firewall checks both data and requests for data that are sent to your network, and discards any suspicious items. Firewalls are available in both software and hardware. Some networks use a combination of both types. Ubuntu does not include firewall software, but you can download Gufw, a free firewall utility that Ubuntu provides. For information on how to download and install Gufw, refer to [Using firewall software on page 37](#).

- Use wireless encryption.

Wireless encryption uses security settings to encrypt and decrypt data that is transmitted over the network.

Connecting to a WLAN

To connect to the WLAN, follow these steps:

1. Be sure that the WLAN device is on. If the device is on, the wireless light is white. If the wireless light is amber, press the wireless button.
2. Click the **Network menu** icon at the far right of the top panel.

Available wireless networks are listed under **Wireless Networks**.

3. Click the desired wireless network.

If the network is a security-enabled WLAN, you are prompted to enter a network security code. Type the code, and then click **OK** to complete the connection.

 **NOTE:** To connect to a network that is not automatically detected, click the **Network menu** icon and select **Connect to Hidden Wireless Network**. Enter the ESSID information, and set encryption parameters.

 **NOTE:** If no WLANs are listed, and your network is not hidden, you are out of range of a wireless router or access point.

If you do not see the network you want to connect to, click the **Network menu** icon at the far right of the top panel, and click **Edit Connections**.

 **NOTE:** The functional range (how far your wireless signals travel) depends on WLAN implementation, router manufacturer, and interference from other electronic devices or structural barriers such as walls and floors.

Using Bluetooth wireless devices

Your computer may have a Bluetooth device depending on the model. A Bluetooth device provides short-range wireless communications that replace the physical cable connections that traditionally link electronic devices such as the following:

- Computers (desktop, notebook, PDA)
- Phones (cellular, cordless, smart phone)
- Imaging devices (printer, camera)
- Audio devices (headset, speakers)
- Mouse

Bluetooth devices provide peer-to-peer capability that allows you to set up a personal area network (PAN) of Bluetooth devices. For information about configuring and using Bluetooth devices, see the Bluetooth software Help.

Connecting to a wired network

Connecting to a LAN requires an 8-pin, RJ-45 network cable.

 **WARNING!** To reduce the risk of electric shock, fire, or damage to the equipment, do not plug a modem cable or telephone cable into an RJ-45 (network) jack.

Connecting to a local area network (LAN)

Use a LAN connection if you want to connect the computer directly to a router in your home (instead of working wirelessly), or if you want to connect to an existing wired network at your office.

To connect the network cable, follow these steps:

1. Plug the network cable into the network jack **(1)** on the computer.
2. Plug the other end of the network cable into a network wall jack **(2)** or router.

 **NOTE:** If the network cable contains noise suppression circuitry **(3)**, which prevents interference from TV and radio reception, orient the circuitry end of the cable toward the computer.

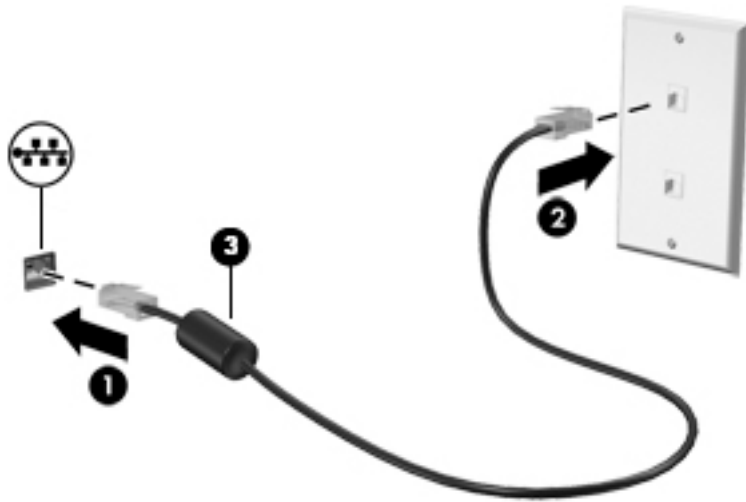

3 Enjoying entertainment features

Use your HP computer as an entertainment hub to socialize via the webcam, enjoy and manage your music, and download and watch movies. Or, to make your computer an even more powerful entertainment center, connect external devices like a monitor, a projector, a TV, speakers, headphones, and, on select models, high-definition devices. You can also use the webcam with applications like Google Hangouts and Skype.

Using the webcam

Your computer may have an integrated webcam. A webcam is a powerful social networking tool that allows you to communicate up close with friends and colleagues next door or on the other side of the world. With the webcam, you can stream video with your instant messaging software, and with the preinstalled software, Camera, you can take still photos.

Using audio

On HP computers that include an optical drive, you can play music CDs, download and listen to music, stream audio content from the web (including radio), record audio, or mix audio and video to create multimedia. To enhance your listening enjoyment, attach external audio devices such as speakers or headphones.

Connecting speakers

You can attach wired speakers to your computer by connecting them to USB ports (or the audio-out jack) on your computer or on a docking station.

To connect *wireless* speakers to your computer, follow the device manufacturer's instructions. To connect high-definition speakers to the computer, see [Configuring audio settings \(with HDMI TV\) on page 13](#). Before connecting audio devices, be sure to adjust the volume.

Connecting headphones

You can connect wired headphones to the headphone jack on your computer.

To connect *wireless* headphones to your computer, follow the device manufacturer's instructions.

 **WARNING!** To reduce the risk of personal injury, adjust the volume before putting on headphones, earbuds, or a headset. For additional safety information, see the *Regulatory, Safety and Environmental Notices*.

Connecting a microphone

To record audio, connect a microphone to the microphone jack on the computer. For best results when recording, speak directly into the microphone in a setting free of background noise.

Checking the sound

To check the system sound on your computer, follow these steps:

1. Click the **System menu** icon at the far right of the top panel, and then click **System Settings > Sound** icon.
2. Click the **Sound Effects** tab, and then select one of the sound options under **Choose an alert sound** to test each sound.

To check the recording functions of the computer, follow these steps:

1. Click the **System menu** icon at the far right of the top panel, and then click **System Settings > Sound** icon.
2. Click the **Input** tab, and then select **Line in** or **Internal Microphone** from the **Record sound from** panel on the left side of the window.
3. Adjust the input volume by moving the **Input volume** slider to the desired setting.

 **NOTE:** For best results when recording, speak directly into the microphone in a setting free of background noise.

To confirm or change the audio settings on your computer, click the **Sound menu** icon at the right of the top panel.

Using video

Your HP computer is a powerful video device that enables you to watch streaming video from your favorite websites and download video and movies to watch on your computer, without needing to access a network.

To enhance your viewing enjoyment, use one of the video ports on the computer to connect an external monitor, projector, or TV. Most computers have a video graphics array (VGA) port, which connects analog video devices. Some computers have a DisplayPort, which connects an optional digital display device, such as a high-performance monitor or projector. Also, some computers have a high-definition multimedia interface (HDMI) port, which allows you to connect a high-definition monitor or TV.

 **IMPORTANT:** Be sure that the external device is connected to the correct port on the computer, using the correct cable. Check the device manufacturer's instructions if you have questions.

Connecting a VGA monitor or projector

To see the computer screen image on an external VGA monitor or projected for a presentation, connect a monitor or projector to the computer's VGA port.

 **NOTE:** Adjust the screen resolution of the external device. Click the **System menu** icon at the far right of the top panel, click **Displays**, and then select a resolution from the drop-down menu next to **Resolution**. Select the display on which to display Launcher from the drop-down menu next to **Launcher placement**. Click **Apply** to apply any changes.

To connect a monitor or projector:

1. Connect the VGA cable from the monitor or projector to the VGA port on the computer as shown.

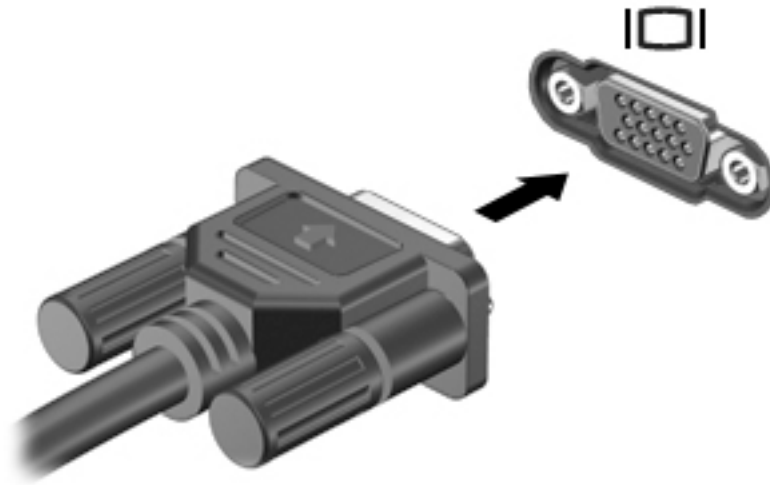

2. Press **f4** to alternate the screen image between four display states:

 **NOTE:** Depending on your model, the function key for this operation may vary.

- **Laptop display only:** View the screen image on the computer only.
- **Mirror displays:** View the screen image simultaneously on *both* the computer and external device.
- **Extend:** View the screen image extended across *both* the computer and external device.
- **External monitor only:** View the screen image on the external device only.

Each time you press **f4**, the display state changes.

If your external monitor is not detected after pressing **f4**, follow these steps:

1. Click the **System menu** icon at the far right of the top panel, and then click **Displays**.
2. Click the **Detect Displays** button.
3. Slide the **On/Off** slider button to **On** beneath the display layout. If the default monitor is not detected, set the resolution and the refresh rate using your external monitor specifications. Change the rotation if desired. If the display requires mirroring, click the **Mirror Displays** check box.
4. After the settings are configured, click **Apply**, and then click **OK**.

DisplayPort

The DisplayPort connects the computer to a video or audio device, such as a high-definition television, or to any compatible digital or audio component. The DisplayPort delivers higher performance than the VGA external monitor port and improves digital connectivity.

 **NOTE:** To transmit video and/or audio signals through the DisplayPort, you need a DisplayPort cable (purchased separately).

 **NOTE:** One DisplayPort device can be connected to the DisplayPort port on the computer. The information displayed on the computer screen can be simultaneously displayed on the DisplayPort device.

To connect a video or audio device to the DisplayPort:

1. Connect one end of the DisplayPort cable to the DisplayPort port on the computer.

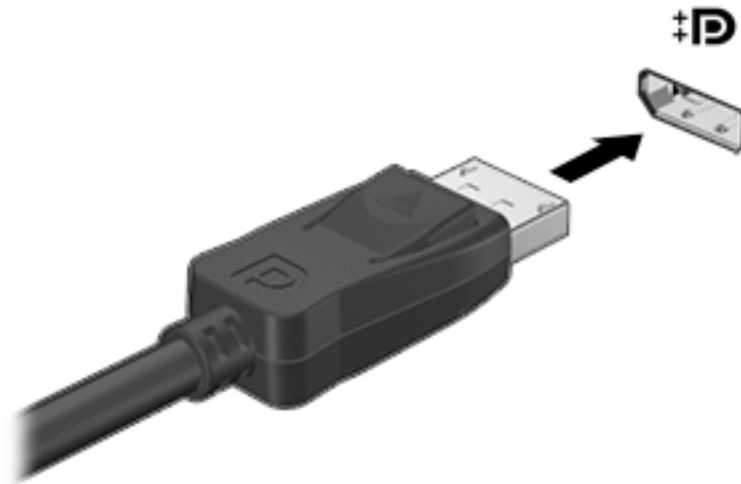

2. Connect the other end of the cable to the video device, and then see the device manufacturer's instructions for additional information.

 **NOTE:** To remove the device cable, press down on the connector release button.

Connecting an HDMI TV or monitor

To see the computer screen image on a high-definition TV or monitor, connect the high-definition device according to the following instructions.

To connect an HDMI device to your computer, you need an HDMI cable, sold separately.

 **NOTE:** Adjust the screen resolution of the external device, especially if you choose the “Extend” option. Click the **System menu** icon at the far right of the top panel, click **Displays** and then select a resolution from the drop-down menu next to **Resolution** for best results.

To connect a high-definition TV or monitor to your computer:

1. Connect one end of the HDMI cable to the HDMI port on the computer.

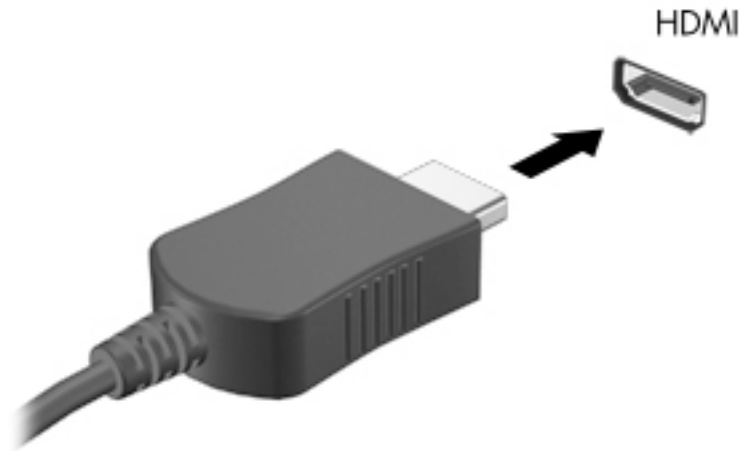

2. Connect the other end of the cable to the high-definition TV or monitor.
3. Press **f4** to alternate the computer screen image between four display states:
 - **Laptop display only:** View the screen image on the computer only.
 - **Mirror displays:** View the screen image simultaneously on *both* the computer and external device.
 - **Extend:** View the screen image extended across *both* the computer and external device.
 - **External monitor only:** View the screen image on the external device only.

Each time you press **f4**, the display state changes.

Configuring audio settings (with HDMI TV)

HDMI is the only video interface that supports high-definition video and audio. After you connect an HDMI TV to the computer, you can then turn on HDMI audio by following these steps:

1. Click the **Sound menu** icon at the right of the top panel, and then click **Sound Settings**.
2. On the **Output** tab, click **Internal Audio Digital Stereo (HDMI)**.
3. Close the Sound window.

To return the audio stream to the computer speakers, follow these steps:

1. Click the **Sound menu** icon at the far right of the top panel, and then click **Sound Settings**.
2. On the **Output** tab, click **Internal Audio Analog Stereo**.
3. Close the Sound window.

4 Using the keyboard and pointing devices

Your computer allows easy on-screen navigation with a keyboard and pointing device. Select models also have action keys or hot key shortcuts that enable you to do common tasks. The TouchPad enables you to perform on-screen functions similar to those you perform with an external mouse.

To explore the pointing device features and to select preferred settings:

1. Click the **System menu** icon at the far right of the top panel, and then click **System Settings**.
2. Click **Mouse and Touchpad**.

Use an external USB mouse (purchased separately) by connecting it to one of the USB ports on the computer.

 **NOTE:** Depending on the country or region, your keyboard may have different keys and keyboard functions than those discussed in this section.

Using the action keys

An action key performs an assigned function. The icons depicted on the **f1** through **f12** keys illustrate the assigned function for that key. Typically, the **f5** key launches the file browser and displays the contents of the Home Folder.





 **NOTE:** This section describes action keys that are common to most models. Some action keys may not be available on your computer.











To use an action key function, press the key.

 **CAUTION:** Use extreme care when making changes in Setup Utility. Errors can prevent the computer from operating properly.

The action key feature is enabled at the factory. You can disable this feature in Setup Utility (BIOS). See [Using Setup Utility \(BIOS\) and HP PC Hardware Diagnostics \(UEFI\) on page 40](#) for instructions on opening Setup Utility (BIOS), and then follow the instructions at the bottom of the screen.

After you have disabled the action key feature, you can still perform each function by pressing the **fn** key in combination with the appropriate action key.

Icon	Description
	Launches the <i>Ubuntu Desktop Guide</i> .
	Decreases the screen brightness incrementally as long as you hold down the key.
	Increases the screen brightness incrementally as long as you hold down the key.
	Switches the screen image between display devices connected to the system. For example, if a monitor is connected to the computer, each time you press this key, the screen image alternates

Icon	Description
	<p>from the computer display to the monitor display to a simultaneous display on both the computer and the monitor.</p> <p>Most external monitors receive video information from the computer using the external VGA video standard. This key can also alternate images among other devices that are receiving video information from the computer.</p>
	Plays the previous track of an audio CD or the previous section of a DVD.
	Begins, pauses, or resumes playback of an audio CD or a DVD.
	Plays the next track of an audio CD or the next section of a DVD.
	Decreases speaker volume incrementally as long as you hold down the key.
	Increases speaker volume incrementally as long as you hold down the key.
	Mutes or restores speaker sound.
	Mutes the microphone.
	<p>Turns the keyboard backlight on and off.</p> <p>NOTE: The keyboard backlight is turned on at the factory. To extend battery life, turn off the keyboard backlight.</p>
	<p>Turns the wireless feature on or off. This button appears on select models only.</p> <p>NOTE: A wireless network must be set up before a wireless connection is possible.</p>
	<p>Turns the airplane mode and wireless feature on or off.</p> <p>NOTE: A wireless network must be set up before a wireless connection is possible.</p>

Using the TouchPad

The TouchPad allows you to navigate the computer with simple finger movements.

Navigating

To move the on-screen pointer, slide one finger across the TouchPad in the direction you want the pointer to go.

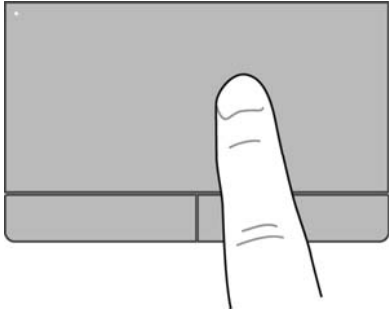

To click, double-click, and drag using your TouchPad:

1. Click the **System menu** icon at the far right of the top panel, and then click **System Settings > Mouse and Touchpad**.
2. Select the gesture that you want to turn on or off.
3. Click the x in the top left corner to close the window.

Selecting

Use the left and right TouchPad buttons as you would use the corresponding buttons on an external mouse.

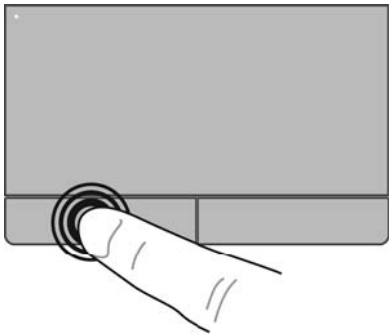

Using TouchPad gestures

To use TouchPad gestures, place two fingers on the TouchPad at the same time or use the edges of the TouchPad.

 **NOTE:** TouchPad gestures are not supported in all programs.

Horizontal scrolling

Horizontal scrolling is useful for moving up, down, or sideways on a page or image. To scroll, place two fingers slightly apart on the TouchPad, and then drag them across the TouchPad in an up, down, left, or right motion.

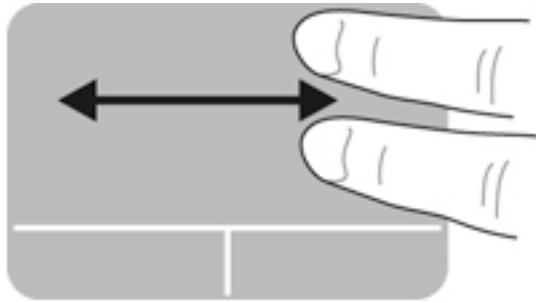
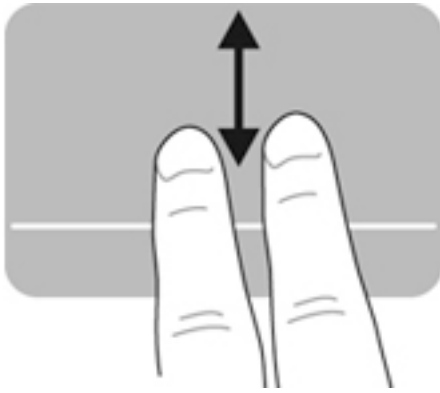

Edge scrolling

Edge scrolling allows you to scroll using the edge of the TouchPad. When this is selected, slide your finger up and down the right side of your TouchPad to scroll vertically. When horizontal scrolling has been enabled, you can move your finger left and right along the bottom of the TouchPad to scroll horizontally.

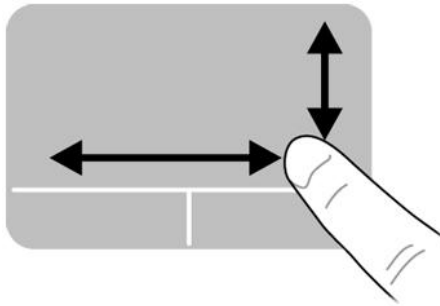
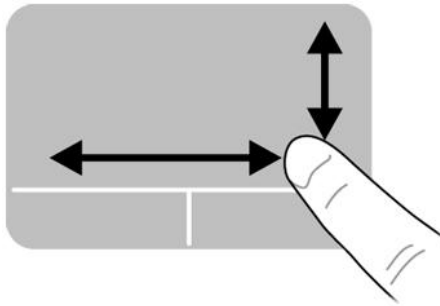

5 Managing power

Your computer can operate on either battery power or external power. When the computer is only running on battery power and an AC power source is not available to charge the battery, it is important to monitor and conserve the battery charge.

Shutting down the computer

 **CAUTION:** Unsaved information is lost when the computer is shut down.

The shutdown command closes all open programs, including the operating system, and then turns off the display and the computer.

Shut down the computer under any of the following conditions:

- When you need to replace the battery or to access components inside the computer
- When you are connecting an external hardware device that does not connect to a USB port
- When the computer will be unused and disconnected from external power for an extended period

To shut down the computer, follow these steps:

 **NOTE:** If the computer is in the Suspend state or in Hibernation, you must first exit Suspend or Hibernation before shutdown is possible.

1. Save your work and close all open programs.
2. Click the **System menu** icon at the far right of the top panel, and then click **Shut Down > Shut Down**.

If the computer is unresponsive and you are unable to use the preceding shutdown procedure, try the following emergency procedures in the sequence provided:

- Press and hold the power button for at least 5 seconds.
- Disconnect the computer from external power, and then remove the battery if the computer includes a user-replaceable battery.

Setting power options

Using power-saving states

 **NOTE:** The Hibernation and Hybrid Sleep power saving states are available on select models only.

The computer has two power-saving states enabled at the factory: Suspend and either Hibernation or Hybrid Sleep.

When Suspend is initiated, the power lights blink and the screen clears. Your work is saved to memory, letting you exit the Suspend state faster than exiting Hibernation. If the computer is in the Suspend state for an extended period or if the battery reaches a critical level while in the Suspend state, the computer initiates Hibernation.

When Hibernation is initiated, your work is saved to a hibernation file on the hard drive and the computer turns off.

When Hybrid Sleep is initiated, the state of your computer, including your work, is saved to memory and the hard drive simultaneously. When you exit Hybrid Sleep, your computer resumes to the previous state.

 **CAUTION:** To prevent possible audio and video degradation, loss of audio or video playback functionality, or loss of information, do not initiate Suspend, Hibernation, or Hybrid Sleep while reading from or writing to a disc or an external media card.

 **NOTE:** You cannot initiate any type of networking connection or perform any computer functions while the computer is in the Suspend state, Hibernation, or Hybrid Sleep.

Initiating and exiting Suspend

The system is set at the factory to initiate Suspend after a period of inactivity when running on battery power or on external power.

Power settings and timeouts can be changed by clicking the **System menu** icon at the far right of the top panel, and then clicking **System Settings > Power** icon.

With the computer on, you can initiate Suspend in any of the following ways:

- Briefly press the power button.
- Close the display.

 **NOTE:** This method works only when the computer is running on battery power.

- Click the **System menu** icon at the far right of the top panel, and then click **Suspend**.

To exit Suspend:

- ▲ Briefly press the power button.

When the computer exits Suspend, the power lights turn on and your work returns to the screen where you stopped working.

Initiating and exiting Hibernation or Hybrid Sleep (select models only)

The system is set at the factory to initiate Hibernation or Hybrid Sleep after a period of inactivity when running on battery power or on external power, or when the battery reaches a critical level.

Power settings and timeouts can be changed by clicking the **System menu** icon at the far right of the top panel, and then clicking **System Settings > Power** icon.

With the computer on, you can initiate Hibernation in the following ways:

- Briefly press the power button and click **Hibernate**.
- Click the **System menu** icon at the far right of the top panel, and then click **Hibernate**.

To exit Hibernation:

- ▲ Briefly press the power button.

When the computer exits Hibernation, the power lights turn on and your work returns to the screen where you stopped working.

Using the Power icon

The **Power** icon is located in the System Settings folder. The **Power** icon allows you to access power settings, view remaining battery charge, and select a different power plan.

- To display the percentage of remaining battery charge when the computer is running on battery power, click the **System menu** icon at the far right of the top panel, and then click **System Settings > Power** icon.
- To display the battery charge time when the computer is connected to external power, click the **Battery menu** icon at the right of the top panel.
- To access power settings, click the **System menu** icon at the far right of the top panel, and then click **System Settings > Power** icon.

Using Power Settings

Power Settings is a collection of system settings that manages how the computer uses power. You can customize Power Settings to help you conserve power or maximize performance.

Viewing the current Power Settings

- ▲ Click the **System menu** icon at the far right of the top panel, and then click **System Settings > Power** icon.

 **NOTE:** To quickly access power settings, you can also click the **Battery menu** icon at the right of the top panel, and then click **Power Settings**.

Changing the current Power Settings

1. Click the **System menu** icon at the far right of the top panel, and then click **System Settings > Power** icon.
2. Change the settings under **On battery power** and **When plugged in**, as needed.

Running on battery power

When a charged battery is in the computer and the computer is not plugged into external power, the computer runs on battery power. If the computer has a charged battery installed and the AC adapter is disconnected from the computer, the computer automatically switches to battery power and the screen brightness decreases to conserve battery life. The battery in the computer slowly discharges when the computer is off and unplugged from external power.

Computer battery life varies, depending on power management settings, programs running on the computer, screen brightness, external devices connected to the computer, and other factors.

Factory-sealed battery (select models only)

The battery(ies) in this product cannot be easily replaced by users themselves. Removing or replacing the battery could affect your warranty coverage. If a battery is no longer holding a charge, contact support.

When a battery has reached the end of its useful life, do not dispose of the battery in general household waste. Follow the local laws and regulations in your area for battery disposal.

For information regarding battery type, refer to the Quick Setup section of the printed Setup Instructions poster that came with your computer.

Removing a user-replaceable battery (select models only)

-
- ⚠ **WARNING!** To reduce potential safety issues, use only the user-replaceable battery provided with the computer, a replacement battery provided by HP, or a compatible battery purchased from HP.
 - ⚠ **CAUTION:** Removing a user-replaceable battery that is the sole power source for the computer can cause loss of information. To prevent loss of information, save your work or shut down the computer before removing the battery.
-

For information regarding battery type, refer to the Quick Setup section of the printed Setup Instructions poster that came with your computer.

Displaying the remaining battery charge

- ▲ Click the **Battery menu** icon at the right of the top panel.

Charging a battery

-
- ⚠ **WARNING!** Do not charge the computer battery while you are aboard aircraft.
-

The battery charges whenever the computer is plugged into external power through an AC adapter or an optional power adapter.

The battery charges whether the computer is off or in use, but it charges faster when the computer is off.

Charging may take longer if a battery is new, has been unused for 2 weeks or more, or is much warmer or cooler than room temperature.

To prolong battery life and optimize the accuracy of battery charge displays, follow these recommendations:

- If you are charging a new battery, charge it fully before turning on the computer.

 **NOTE:** If the computer is on while the battery is charging, the battery meter in the notification area may show 100 percent charge before the battery is fully charged.

- Allow the battery to discharge below 5 percent of a full charge through normal use before charging it.
- If the battery has been unused for one month or more, calibrate the battery instead of simply charging it.

Maximizing battery life

To maximize battery life:

1. Click the **Battery menu** icon in the top panel, and then click **Power Settings**.
2. Under **On battery power**:
 - Select **30 minutes** from the drop-down menu to the right of **Suspend when inactive for**.
 - Select the **Hibernate** or **Power off** option to the right of **When power is critically low**.
 - Select the **Suspend** option to the right of **When the lid is closed**.
3. Click **Close**.

Managing low battery levels

The information in this section describes the alerts and system responses set at the factory. Some low-battery alerts and system responses can be changed using power settings. Changes set using power settings do not affect lights.

Identifying low battery levels

When a battery that is the sole power source for the computer reaches a low or critical level, the following behavior occurs:

- When in Suspend state, the computer remains briefly in Suspend state, and then shuts down and loses any unsaved information.

Resolving a low battery level

Resolving a low battery level when external power is available

- ▲ Connect one of the following devices:
 - AC adapter
 - Optional power adapter purchased as an accessory from HP

Resolving a low battery level when a charged battery is available

1. Turn off the computer.
2. Replace the discharged battery with a charged battery.
3. Turn on the computer.

Conserving battery power

- Turn off wireless and local area network (LAN) connections and exit modem applications when you are not using them.
- Disconnect unused external devices that are not plugged into an external power source.
- Stop, disable, or remove any external media cards that you are not using.
- Decrease screen brightness.
- Initiate Suspend, or shut down when you are not using the computer.

Storing a battery

 **CAUTION:** To reduce the risk of damage to a battery, do not expose it to high temperatures for extended periods of time.

If a computer will be unused and unplugged from external power for more than 2 weeks, remove the battery and store it separately.

To prolong the charge of a stored battery, place it in a cool, dry place.

 **NOTE:** A stored battery should be checked every 6 months. If the capacity is less than 50 percent, recharge the battery before returning it to storage.

Calibrate a battery before using it if it has been stored for one month or more.

Disposing of a used battery

 **WARNING!** To reduce the risk of fire or burns, do not disassemble, crush, or puncture; do not short external contacts; do not dispose of in fire or water.

Refer to the *Regulatory, Safety and Environmental Notices* for battery disposal information.

Replacing the battery

Computer battery life varies, depending on power management settings, programs running on the computer, screen brightness, external devices connected to the computer, and other factors.

You can find details about the battery by clicking the **Battery menu** icon at the right of the top panel.

 **NOTE:** To ensure that you always have battery power when you need it, HP recommends purchasing a new battery when the storage capacity indicator turns green-yellow.

Using external AC power

 **NOTE:** For information on connecting to AC power, refer to the *Setup Instructions* poster provided in the computer box.

The computer does not use battery power when the computer is connected to AC external power with an approved AC adapter or an optional docking/expansion device.

 **WARNING!** To reduce potential safety issues, use only the AC adapter provided with the computer, a replacement AC adapter provided by HP, or a compatible AC adapter purchased from HP.

Connect the computer to external AC power under any of the following conditions:

 **WARNING!** Do not charge the battery while you are aboard aircraft.

- When you are charging or calibrating a battery
- When you are installing or modifying system software
- When writing information to a disc (select models only)
- When performing a backup or recovery

When you connect the computer to external AC power, the following events occur:

- The battery begins to charge.
- If the computer is turned on, the **Battery menu** icon in the top panel changes appearance.

When you disconnect external AC power, the following events occur:

- The computer switches to battery power.
- The screen brightness is automatically decreased to save battery life.

Testing an AC adapter

Test the AC adapter if the computer exhibits any of the following symptoms when it is connected to AC power:

- The computer does not turn on.
- The display does not turn on.
- The power lights are off.

To test the AC adapter:

1. Shut down the computer.
2. Remove the battery from the computer.
3. Connect the AC adapter to the computer, and then plug it into an AC outlet.
4. Turn on the computer.
 - If the power lights turn *on*, the AC adapter is functioning properly.
 - If the power lights remain *off*, check the connection from the AC adapter to the computer and the connection from the AC adapter to the AC outlet to make sure the connections are secure.
 - If the connections are secure and the power lights remain *off*, the AC adapter is not functioning and should be replaced.

Contact support for information on obtaining a replacement AC power adapter.

6 Managing and sharing information

Drives are digital storage devices or solid-state drives that help you store, manage, share, and access information. Your computer has an internal hard drive that stores your software and operating system, as well as providing storage for all of your personal files. Some computers also have a built-in optical drive that allows you to read or write to a CD or DVD.

For added capacity or functionality, connect an external drive (purchased separately), such as an optical drive or hard drive, or insert a digital storage card to import information directly from your phone or camera. A Universal Serial Bus (USB) flash drive, connected to the USB port on your computer, also allows quick data transfer. Some devices use the computer's power to run; others have their own power source. Some devices come with software that must be installed.

 **NOTE:** For information about connecting external wireless devices, see [Connecting to a network on page 4](#).

 **NOTE:** For more information about required software and drivers, or to learn which computer port to use, see the manufacturer's instructions.

Using a USB device

Most computers have more than one USB port, because this versatile interface allows you to connect numerous kinds of external devices, such as a USB keyboard, mouse, external drive, printer, scanner, or USB hub, to your computer.

Your computer may have more than one type of USB port. Be sure to purchase devices that are compatible with your computer.

Type	Description
USB 2.0	Transfers data at 60 MB/s.
USB 3.0	Transfers data at 640 MB/s. USB 3.0 ports, also known as SuperSpeed ports, are also compatible with USB 1.0 and 2.0 devices.

Connecting a USB device

 **CAUTION:** To reduce the risk of damage to a USB connector, use minimal force to connect the device.

 Connect the USB cable for the device to the USB port.

 **NOTE:** The USB port on your computer may look slightly different from the illustration in this section.



Removing a USB device

CAUTION: To reduce the risk of damage to a USB connector, do not pull on the cable to remove the USB device.

CAUTION: Use the following procedure to safely remove the USB device.

1. To remove a USB device, save your information and close all programs associated with the device.
2. Open **File Browser** by selecting the **Home Folder** located on the left side of the desktop in the **Launcher**.
3. Click the **Eject** icon next to the device name in the **Devices** list on the left pane of File Browser. The USB device icon disappears from the list and the device can be safely removed.
4. Remove the device.

Inserting and removing a digital storage card

To insert a digital storage card:

⚠ CAUTION: To reduce the risk of damage to the digital card connectors, use minimal force to insert a digital card.

1. Hold the card label-side up, with the connectors facing the computer.
2. Insert the card into the digital storage slot, and then press in on the card until it is firmly seated.

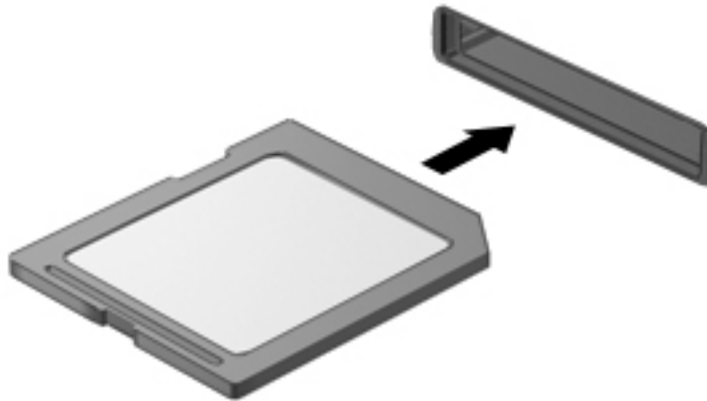

To remove a digital storage card:

⚠ CAUTION: To reduce the risk of loss of data or an unresponsive system, use the following procedure to safely remove the digital card.

1. Save your information and close all programs associated with the digital card.
2. Open File Browser from the **Home Folder** located on the left side of the desktop in the **Launcher**.
3. Click the **Eject** icon next to the digital card name in the **Devices** list on the left pane of File Browser. The USB device icon disappears from the list and the device can be safely removed.

📝 NOTE: You are prompted that it is safe to remove the hardware device.

4. Press in on the card (1), and then remove it from the slot (2).

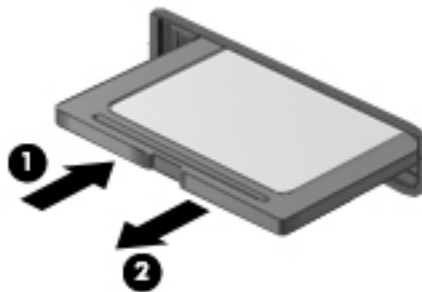

📝 NOTE: If the card is not ejected, pull the card out of the slot.

Using optical drives

An optical disc drive uses laser light to read or store large amounts of information. Some drives can only read information, but others can also write (burn) information onto a blank disc.

Use these tips for best performance of your optical drive:

- When the battery is the only source of power, be sure the battery is sufficiently charged before writing to media.
- Do not type on the keyboard or move the computer while an optical drive is writing to a disc. The write process is sensitive to vibration.
- Make sure you have installed the latest software updates for the drive.
- If the disc you are using is not clean, wipe it with a dry, lint-free, soft cloth.

Your computer may include an optical drive that supports one or more of the following disc technologies:

- CD—A compact disc stores data that is read by a laser from the optical disc drive. The following CD formats are available:
 - CD-Recordable (CD-R), which allows the computer to read information and to record information one time on the CD. Once the information is recorded on the CD-R disc, it cannot be changed or erased; it is permanent.
 - CD-Re-Writable (CD-RW), which allows you to read information and record information many times to the CD. Information on the CD can be erased.
- DVD—A digital video disc is a high-capacity optical disc. It can store more information than a CD. A double-sided DVD can store up to 17 GB. The following DVD formats are available:
 - DVD-Recordable (DVD-R or DVD+R), which allows the computer to read information and to record information one time on the DVD. After the information is recorded on the disc, it cannot be changed or erased; it is permanent. The DVDs can be used in DVD±R drives.
 - DVD-Re-Writable (DVD-RW or DVD+RW), which allows the computer to read information and record information many times to the disc. Information on the disc can be erased. The DVDs can be used in DVD±R drives.

Inserting an optical disc

Tray-load

1. Turn on the computer.
2. Press the release button **(1)** on the drive bezel to release the disc tray.
3. Pull out the tray **(2)**.
4. Hold the disc by the edges to avoid touching the flat surfaces and position the disc label-side up over the tray spindle.



NOTE: If the tray is not fully accessible, tilt the disc carefully to position it over the spindle.

5. Gently press the disc (3) down onto the tray spindle until the disc snaps into place.

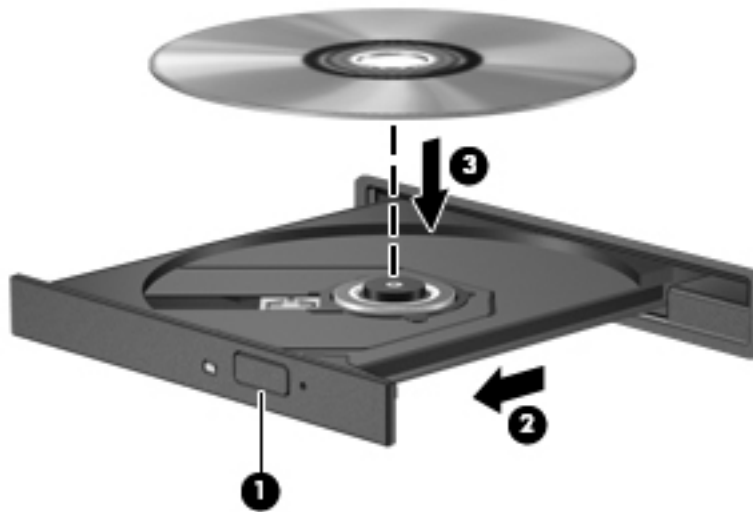

6. Close the disc tray.

 **NOTE:** After you insert a disc, a short pause is normal. If you have not selected a media player, an AutoPlay dialog box opens. It prompts you to select how you want to use the media content.

Slot-load

 **CAUTION:** Do not insert 8-cm optical discs into a slot-load optical drive. It may cause damage to the optical drive.

1. Turn on the computer.
2. Hold the disc by the edges to avoid touching the flat surfaces and position the disc label-side up.
3. Gently slide the disc into the slot-load optical drive.



Removing an optical disc

Tray-load

There are 2 ways to remove a disc, depending on whether the disc tray opens normally or not.

When the disc tray opens normally

1. Press the release button (1) on the drive bezel to release the disc tray, and then gently pull out the tray (2) until it stops.

2. Remove the disc **(3)** from the tray by gently pressing down on the spindle while lifting the outer edges of the disc. Hold the disc by the edges and avoid touching the flat surfaces.

 **NOTE:** If the tray is not fully accessible, tilt the disc carefully as you remove it.

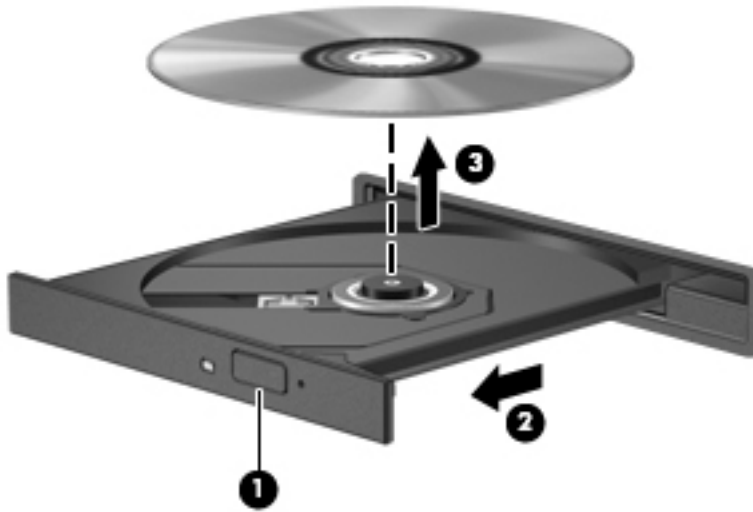

3. Close the disc tray and place the disc in a protective case.

When the disc tray fails to open normally

1. Insert the end of a paper clip **(1)** into the release access in the front bezel of the drive.
2. Press in gently on the paper clip until the tray is released, and then pull out the tray **(2)** until it stops.

3. Remove the disc (3) from the tray by gently pressing down on the spindle while lifting the outer edges of the disc. Hold the disc by the edges and avoid touching the flat surfaces.



NOTE: If the tray is not fully accessible, tilt the disc carefully as you remove it.

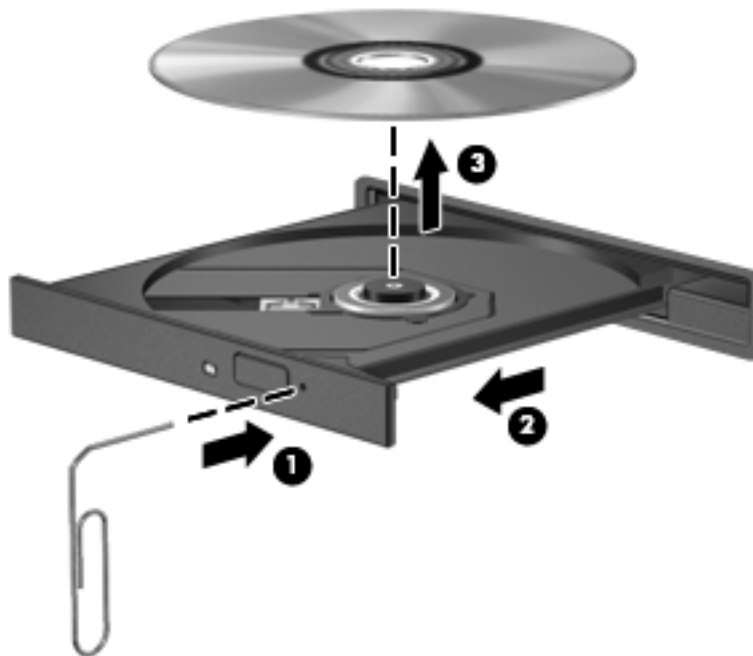

4. Close the disc tray and place the disc in a protective case.

Slot-load

1. Press the release button (1) next to the drive.
2. Remove the disc (2) by holding it by the edges, and avoid touching the flat surfaces.



3. Place the disc in a protective case.

7 Maintaining your computer

Updating programs and drivers

HP recommends that you update your programs and drivers on a regular basis to the latest versions. Updates can resolve issues and bring new features and options to your computer. Technology is always changing, and updating programs and drivers allows your computer to run the latest technology available. For example, older graphics components might not work well with the most recent gaming software. Without the latest driver, you would not be getting the most out of your equipment.

Go to <http://www.hp.com/support> to download the latest versions of HP programs and drivers. In addition, register to receive automatic update notifications when they become available.

To set your computer to receive free automatic Ubuntu updates:

1. Click **About this computer** at the far right of the top panel. Click **Install updates** to check for updates that are available for your computer.
2. In the Update Manager window, click the **Check** button to check for new software updates.
3. Click the box next to each update that you want to install, and then click the **Install Updates** button.
4. Click **Close** after the updates have been installed.

 **NOTE:** To change the settings for software updates, click the **Settings** button on the bottom of the Update Manager window.

Cleaning your computer

Use the following products to safely clean your computer:

- Dimethyl benzyl ammonium chloride 0.3 percent maximum concentration (for example, disposable wipes, which come in a variety of brands).
- Alcohol-free glass-cleaning fluid
- Water with mild soap solution
- Dry microfiber cleaning cloth or a chamois (static-free cloth without oil)
- Static-free cloth wipes

 **CAUTION:** Avoid strong cleaning solvents that can permanently damage your computer. If you are not sure that a cleaning product is safe for your computer, check the product contents to make sure that ingredients such as alcohol, acetone, ammonium chloride, methylene chloride, and hydrocarbons are not included in the product.

Fibrous materials, such as paper towels, can scratch the computer. Over time, dirt particles and cleaning agents can get trapped in the scratches.

Cleaning procedures

Follow the procedures in this section to safely clean your computer.

⚠ WARNING! To prevent electric shock or damage to components, do not attempt to clean your computer while it is turned on.

- Turn off the computer.
- Disconnect AC power.
- Disconnect all powered external devices.

⚠ CAUTION: To prevent damage to internal components, do not spray cleaning agents or liquids directly on any computer surface. Liquids dripped on the surface can permanently damage internal components.

Cleaning the display (All-in-Ones or Notebooks)

Gently wipe the display using a soft, lint-free cloth moistened with an alcohol-free glass cleaner. Be sure that the display is dry before closing the display.

Cleaning the sides or cover

To clean the sides or cover, use a soft microfiber cloth or chamois moistened with one of the cleaning solutions listed previously or use an acceptable disposable wipe.

📝 NOTE: When cleaning the cover of the computer, use a circular motion to aid in removing dirt and debris.

Cleaning the TouchPad, keyboard, or mouse

⚠ WARNING! To reduce the risk of electric shock or damage to internal components, do not use a vacuum cleaner attachment to clean the keyboard. A vacuum cleaner can deposit household debris on the keyboard surface.

⚠ CAUTION: To prevent damage to internal components, do not allow liquids to drip between the keys.

- To clean the TouchPad, keyboard, or mouse, use a soft microfiber cloth or a chamois moistened with one of the cleaning solutions listed previously or use an acceptable disposable wipe.
- To prevent keys from sticking and to remove dust, lint, and particles from the keyboard, use a can of compressed air with a straw extension.

Traveling with or shipping your computer

If you have to travel with or ship your computer, here are some tips to keep your equipment safe.

- Prepare the computer for traveling or shipping:
 - Back up your information to an external drive.
 - Remove all discs and all external media cards, such as digital storage cards, from the computer.
 - Turn off, and then disconnect all external devices.
 - Remove any media from the drive before removing the drive from a drive bay.

⚠ CAUTION: Perform this action before shipping, storing, or traveling with a drive. This will help reduce the risk of damage to the computer, damage to a drive, or loss of information.

- Shut down the computer.
- Take along a backup of your information. Keep the backup separate from the computer.
- When traveling by air, carry the computer as hand luggage; do not check it in with the rest of your luggage.

⚠ CAUTION: Avoid exposing a drive to magnetic fields. Security devices with magnetic fields include airport walk-through devices and security wands. Airport conveyer belts and similar security devices that check carry-on baggage use X-rays instead of magnetism and do not damage drives.

- If you plan to use the computer during a flight, listen for the in-flight announcement that tells you when you are allowed to use your computer. In-flight computer use is at the discretion of the airline.
- If the computer will be unused and disconnected from external power for more than 2 weeks, remove the battery and store it separately.
- If you are shipping the computer or a drive, use suitable protective packaging and label the package “FRAGILE.”
- If the computer has a wireless device installed, the use of these devices may be restricted in some environments. Such restrictions may apply onboard aircraft, in hospitals, near explosives, and in hazardous locations. If you are uncertain of the policy that applies to the use of a particular device, ask for authorization to use your computer before you turn it on.
- If you are traveling internationally, follow these suggestions:
 - Check the computer-related customs regulations for each country or region on your itinerary.
 - Check the power cord and adapter requirements for each location in which you plan to use the computer. Voltage, frequency, and plug configurations vary.

⚠ WARNING! To reduce the risk of electric shock, fire, or damage to the equipment, do not attempt to power the computer with a voltage converter kit sold for appliances.

8 Securing your computer and information

Protecting the computer

 **NOTE:** Security solutions are designed to act as deterrents, but they may not deter software attacks or prevent the computer from being mishandled or stolen.

Security features provided with your computer can protect the computer, personal information, and data from a variety of risks. The way you use your computer will determine which security features you need to use.

The operating system offers certain security features. Additional security features are listed in the following table. Most of these additional security features can be configured in Setup Utility.

To protect against	Use this security feature
Unauthorized use of the computer	Power-on authentication using passwords
Unauthorized access to Setup Utility (f10)	Administrator password in Setup Utility*
Unauthorized access to data	<ul style="list-style-type: none">• Firewall software (not installed in the Ubuntu operating system by default)• Operating system updates
Unauthorized access to Setup Utility settings and other system identification information	Administrator password in Setup Utility*
Unauthorized removal of the computer	Security cable slot (used with an optional security cable)

*Setup Utility is a utility accessed by pressing **f10** when the computer is turned on or restarted. When using Setup Utility, you must use the keys on your computer to navigate and make selections.

Using passwords

A password is a group of characters that you choose to secure your computer information. Several types of passwords can be set, depending on how you want to control access to your information. Passwords can be set in the operating system or in Setup Utility, which is preinstalled on the computer.

 **NOTE:** To reduce the risk of being locked out of the computer, record each password and store it in a secure place.

Setting passwords in the operating system

Operating system passwords	Function
Root password	Protects access to an operating system root-level account.
User password	Protects access to an operating system user account.

Setting passwords in Setup Utility (BIOS) and Computer Setup

Password Type	Function
Administrator password or BIOS administrator password*	<ul style="list-style-type: none">Protects access to Setup Utility or Computer Setup.After this password is set, it must be entered each time you access Setup Utility or Computer Setup. <p>CAUTION: If you forget your administrator password, you cannot access Setup Utility or Computer Setup.</p> <p>NOTE: The administrator password can be used in place of the power-on password.</p> <p>NOTE: Your administrator password is not displayed as it is set, entered, changed, or deleted.</p> <p>NOTE: If you enter the power-on password at the first password check before the “Press the ESC key for Startup Menu” message is displayed, you must enter the administrator password to access Setup Utility or Computer Setup.</p>
Power-on password*	<ul style="list-style-type: none">Protects access to the computer contents.After this password is set, it must be entered each time you turn on or restart the computer, or exit Hibernation. <p>CAUTION: If you forget your power-on password, you cannot turn on or restart the computer, or exit Hibernation.</p> <p>NOTE: The administrator password can be used in place of the power-on password.</p> <p>NOTE: A power-on password is not displayed as it is set, entered, changed, or deleted.</p>

*For details about each of these passwords, refer to the following topics.

Managing an administrator password

To set, change, or delete this password, follow these steps:

1. Open Setup Utility or Computer Setup by turning on or restarting the computer. While the “Press the ESC key for Startup Menu” message is displayed in the lower-left corner of the screen, press **esc**. When the Startup Menu is displayed, press **f10**.
2. Select **Security**, and then follow the on-screen instructions.

Your changes take effect when the computer restarts.

Entering an administrator password

At the **Enter Password** prompt, type your administrator password, and then press **enter**. After 3 unsuccessful attempts to enter the administrator password, you must restart the computer and try again.

Managing a power-on password

To set, change, or delete this password, follow these steps:

1. Open Setup Utility by turning on or restarting the computer. While the “Press the ESC key for Startup Menu” message is displayed in the lower-left corner of the screen, press **esc**. When the Startup Menu is displayed, press **f10**.
2. Use the arrow keys to select **Security > Set Power-On Password**, and then press **enter**.
 - To set a power-on password, type your password in the **Enter New Password** and **Confirm New Password** fields, and then press **enter**.
 - To change a power-on password, type your current password in the **Enter Current Password** field, type a new password in the **Enter New Password** and **Confirm New Password** fields, and then press **enter**.
 - To delete a power-on password, type your current password in the **Enter Current Password** field, and then press **enter** 4 times.
3. To save your changes and exit Setup Utility, use the arrow keys to select **Exit > Exit Saving Changes**.

Your changes take effect when the computer restarts.

Entering a power-on password

At the **Enter Password** prompt, type your password, and then press **enter**. After 3 unsuccessful attempts to enter the password, you must restart the computer and try again.

Using Internet security software

When you use your computer to access email, a network, or the Internet, you potentially expose your computer to computer viruses, spyware, and other online threats. To help protect your computer, Internet security software that includes antivirus and firewall features can be installed. To provide ongoing protection against newly discovered viruses and other security risks, security software must be kept up to date. It is strongly recommended that you purchase the software of your choice in order to fully protect your computer.

Using antivirus software

Computer viruses can disable programs, utilities, or the operating system, or cause them to function abnormally. Antivirus software can detect most viruses, destroy them, and in most cases, repair any damage they have caused.

Using firewall software

Firewalls are designed to prevent unauthorized access to a system or network. The Ubuntu operating system ships with no open ports; therefore, it does not include a firewall utility in the base operating system. However, you may use the Ubuntu Software Center, located in the **Launcher** on the left side of the desktop, to download Gufw, a free Ubuntu firewall utility.

To install Gufw:

1. Click on the **Ubuntu Software Center** folder located in the **Launcher** on the left side of the desktop.
2. Enter **Gufw** in the search bar and press **enter**.
3. Double-click the **Firewall Configuration** icon, and then click the **Install** button.
4. Follow the on-screen instructions.

To view or modify firewall settings after installing Gufw:

1. Select **Ubuntu Software Center** from the **Launcher** on the left side of the desktop, and then click **Gufw**.



NOTE: When accessing Gufw, you are prompted for the root password.

2. Follow the on-screen instructions.



NOTE: Under some circumstances a firewall can block access to Internet games, interfere with printer or file sharing on a network, or block authorized email attachments. To temporarily resolve the problem, disable the firewall, perform the task that you want to perform, and then reenable the firewall immediately. To permanently resolve the problem, you must reconfigure the firewall.

Securing your wireless network

When you set up your wireless network, always enable security features. For more information, see [Protecting your WLAN on page 6](#).

Backing up your software applications and information

Regularly back up your software applications and information to protect them from being permanently lost or damaged through a virus attack or a software or hardware failure. For more information, see [Backing up, restoring, and recovering on page 43](#).

Using an optional security cable lock

A security cable lock, which is purchased separately, is designed to act as a deterrent, but it may not prevent the computer from being mishandled or stolen. Security cable locks are only one of several methods that should be employed as part of a complete security solution to help maximize theft protection.

The security cable slot on your computer may look slightly different from the illustration in this section.

1. Loop the security cable lock around a secured object.
2. Insert the key **(1)** into the security cable lock **(2)**.

3. Insert the security cable lock into the security cable slot on the computer (3), and then lock the security cable lock with the key.

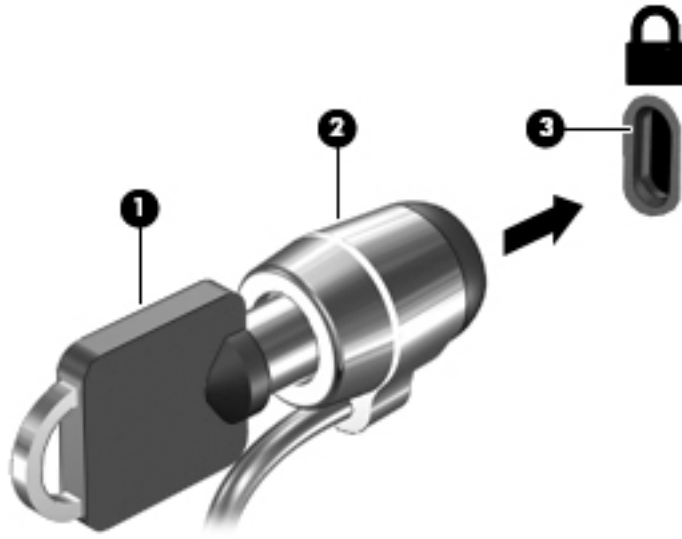

4. Remove the key and keep it in a safe place.

9 Using Setup Utility (BIOS) and HP PC Hardware Diagnostics (UEFI)

Setup Utility, or Basic Input/Output System (BIOS), controls communication between all the input and output devices on the system (such as disk drives, display, keyboard, mouse, and printer). Setup Utility includes settings for the types of peripherals installed, the startup sequence of the computer, and the amount of system and extended memory.

 **NOTE:** Use extreme care when making changes in Setup Utility. Errors can prevent the computer from operating properly.

Starting Setup Utility

- ▲ Turn on or restart the computer. While the “Press the ESC key for Startup Menu” message is displayed in the lower-left corner of the screen, press **esc**. When the Startup Menu is displayed, press **f10**.

Using Setup Utility

Changing the language of Setup Utility

1. Start Setup Utility.
2. Use the arrow keys to select **System Configuration > Language**, and then press **enter**.
3. Use the arrow keys to select a language, and then press **enter**.
4. When a confirmation prompt with your language selected is displayed, press **enter**.
5. To save your change and exit Setup Utility, use the arrow keys to select **Exit > Exit Saving Changes**, and then press **enter**.

Your change takes effect immediately.

Navigating and selecting in Setup Utility

Setup Utility does not support the TouchPad. Navigation and selection are by keystroke.

- To choose a menu or a menu item, use the arrow keys.
- To choose an item in a list or to toggle a field—for example an Enable/Disable field—use either the arrow keys or **f5** and **f6**.
- To select an item, press **enter**.
- To close a text box or return to the menu display, press **esc**.
- To display additional navigation and selection information while Setup Utility is open, press **f1**.

Displaying system information

1. Start Setup Utility.
2. Select the **Main** menu. System information such as the system time and date, and identification information about the computer is displayed.
3. To exit Setup Utility without changing any settings:
 - Use the arrow keys to select **Exit > Ignore Changes and Exit**, and then press **enter**.
 - Or-
 - Use the arrow keys to select **Exit > Exit Discarding Changes**. Click **Yes**, and then press **enter**.

Restoring factory default settings in Setup Utility

1. Start Setup Utility.
2. Use the arrow keys to select **Exit > Load Setup Defaults**, and then press **enter**.
3. When the Setup Confirmation is displayed, press **enter**.
4. To save your change and exit Setup Utility, use the arrow keys to select **Exit > Exit Saving Changes**, and then press **enter**.

The Setup Utility factory settings take effect when the computer restarts.



NOTE: Your password, security, and language settings are not changed when you restore the factory settings.

Exiting Setup Utility

- To exit Setup Utility and save your changes from the current session:

If the Setup Utility menus are not visible, press **esc** to return to the menu display. Then use the arrow keys to select **Exit > Exit Saving Changes**, and then press **enter**.
- To exit Setup Utility without saving your changes from the current session:
 - Use the arrow keys to select **Exit > Ignore Changes and Exit**, and then press **enter**.
 - Or-
 - Use the arrow keys to select **Exit > Exit Discarding Changes**. Click **Yes**, and then press **enter**.

Using HP PC Hardware Diagnostics (UEFI)

HP PC Hardware Diagnostics is a Unified Extensible Firmware Interface (UEFI) that allows you to run diagnostic tests to determine whether the computer hardware is functioning properly. The tool runs outside the operating system so that it can isolate hardware failures from issues that are caused by the operating system or other software components.

To start HP PC Hardware Diagnostics UEFI:

1. Turn on or restart the computer, quickly press **esc**, and then press **f2**.

The BIOS searches two places for the diagnostic tools, in the following order:

- a. Connected USB drive

 **NOTE:** To download the HP PC Hardware Diagnostics (UEFI) tool to a USB drive, see [Downloading HP PC Hardware Diagnostics \(UEFI\) to a USB device on page 42](#).

b. BIOS

2. When the diagnostic tool opens, use the keyboard arrow keys to select the type of diagnostic test you want to run, and then follow the on-screen instructions.

 **NOTE:** If you need to stop a diagnostic test, press *esc*.

Downloading HP PC Hardware Diagnostics (UEFI) to a USB device

 **NOTE:** Instructions for downloading HP PC Hardware Diagnostics (UEFI) are provided in English only and you must use a Windows computer to download and create the HP UEFI support environment because only .exe files are offered.

There are two options to download HP PC Hardware Diagnostics to a USB device:

Option 1: HP PC Diagnostics homepage— Provides access to the latest UEFI version

1. Go to <http://hp.com/go/techcenter/pcdiags>.
2. Click the **UEFI Download** link, and then select **Run**.

Option 2: Support and Drivers page—Provides downloads for a specific product for earlier and later versions

1. Go to <http://www.hp.com>.
2. Point to **Support**, located at the top of the page, and then click **Download Drivers**.
3. In the text box, enter the product name, and then click **Go**.

– or –

Click **Find Now** to let HP automatically detect your product.

4. Select your computer model, and then select your operating system.
5. In the **Diagnostic** section, click **HP UEFI Support Environment**.

– or –

Click **Download**, and then select **Run**.

10 Backing up, restoring, and recovering

Recovery after a system failure is as good as your most recent backup. As you add new software and data files, you should continue to back up your system on a regular basis to maintain a reasonably current backup.

Creating a restore image

The Recovery Media Creator allows you to repair or restore the computer to its original factory state. You can create restore image DVDs using DVD±RW optical drives. You can also create a restore image on a USB device.

 **CAUTION:** Using Restore completely erases hard drive contents and reformats the hard drive. All files you have created and any software installed on the computer are permanently removed. The recovery tool reinstalls the original operating system and programs and drivers that were installed at the factory. Software, drivers, and updates not installed at the factory must be manually reinstalled. Your data files and personal files must be restored from a backup.

 **NOTE:** HP recommends that you create the restore image in the event of a system failure.

Creating restore image on DVDs

You can use Recovery Media Creator or the restore creation software to create a set of system restore discs using blank, writable DVDs (DVD-R or DVD+R). HP recommends using blank DVD+R discs from a manufacturer you trust, because these recovery DVDs are so important. HP recommends having up to 3 blank DVD+R discs available for the restore image. If you use more than one disc, label each disc with the order in which it was created. Numbering the discs will ensure that you have them in the correct order if you need to restore the computer to its original factory state.

To create restore DVDs using the Recovery Media Creator:

1. Click the **Dash Home** icon at the far left of the top panel, and then enter `recovery` in the Search box. Select **Recovery Media Creator**.
2. On the **Please choose media type** window, click the **DVD** icon.
3. Follow the on-screen instructions.

To create restore DVDs using the restore creation software:

1. Click the **System menu** icon at the far right of the top panel, and then click **System Settings > Backup**.
2. Select **Storage** from the panel on the left side of the window, click the down-arrow next to **Backup Location**, select the Local Folder, and then click the **Choose Folder** button. Select the DVD from the panel on the left side of the window, and click **OK**.
3. Select **Overview** from the panel on the left side of the window, and then click **Back Up Now**.
4. Follow the on-screen instructions.

Creating a restore image on a USB device

 **NOTE:** Be sure AC power is connected to the computer before you begin this procedure.

You can use Recovery Media Creator or the restore creation software to create a system restore image on a USB device. Verify the exact amount of free space on your storage device before you begin the creation process. For most models, you will need at least 4GB of free space on the USB device. However, depending on the drivers and software installed on your computer, you may need slightly more than 4 GB of space. **HP recommends that you use an 8 GB USB device or above for best results.**

 **IMPORTANT:** Remember to insert your USB device into the USB port on the computer before starting this procedure.

To create a restore USB device using the Recovery Media Creator:

1. Click the **Dash Home** icon at the far left of the top panel, and then enter `recovery` in the Search box. Select **Recovery Media Creator**.
2. On the **Please choose media type** window, click the **USB** icon.
3. Follow the on-screen instructions.

To create a restore USB device using restore creation software:

1. Click the **System menu** icon at the far right of the top panel, and then click **System Settings > Backup**.
2. Select **Storage** from the panel on the left side of the window, click the down-arrow next to **Backup Location**, select the Local Folder, and then click the **Choose Folder** button. Select the USB device from the panel on the left side of the window, and click **OK**.
3. Select **Overview** from the panel on the left side of the window, and then click **Backup Now**.
4. Follow the on-screen instructions.

Restoring the original factory state

 **NOTE:** Be sure AC power is connected to the computer before you begin this procedure.

To use the restore image on DVDs or a USB device to restore your computer to the original factory state:

1. If possible, back up all personal files.
2. Shut down the computer.
3. Be sure the first restore DVD or USB device is connected to the computer.
4. Restart the computer.
5. When system boots, press **F9** to enter boot device selection, and then select the device containing the restore image.
6. Click **Restore entire hard drive**, and then click **Continue**.
7. Follow the on-screen instructions.

 **NOTE:** If you are unable to boot (start up) your computer, and you did not create a system recovery disc, you must purchase an *Ubuntu Operating System* DVD to reinstall the operating system. For additional information, refer to the *Worldwide Telephone Numbers* booklet.

Backing up your data files

The Deja Dup Restore Tool allows you to back up your data files.

You should back up your data files on a regular schedule to maintain a current backup. You can manually back up your information to an optional external drive, a network drive, or discs. Be sure to back up your data at the following times:

- At regularly scheduled times
- Before the computer is repaired or restored
- Before you add or modify hardware or software

To back up your home directory files using the Deja Dup Backup Tool:

 **NOTE:** Before you back up your information, be sure you have designated a location to save the backup files.

1. Click the **System menu** icon at the far right of the top panel, and then click **System Settings > Backup** icon.
2. Select **Folders** from the panel on the left side of the window, and beneath **Folders to back up**, select the folders to back up.
3. Select **Storage** from the panel on the left side of the window, click the down-arrow next to **Backup Location**, and select your designated back up location from the drop-down list.
4. Select **Overview** from the panel on the left side of the window, and then click **Back Up Now**.

 **NOTE:** You may also back up to cloud storage services provided by various companies. For a small fee, they will keep your backup for you. A cloud service is recommended, since it is an easy way to keep your backups off-site and safe.

Restoring your data files

The Deja Dup Restore Tool allows you to restore your data files.

 **NOTE:** Be sure AC power is connected to the computer before you begin this procedure.

To restore your data from your backup files:

1. Click the **System menu** icon at the far right of the top panel, and then click **System Settings > Backup** icon.
2. Click **Restore**, select the location of the backup files and the folder name, and then click **Forward**.
3. Under **Restore from When?**, select the date of the files to be restored, and then click **Forward**.
4. Select the location and folder where the files are to be restored, and then click **Forward**.
5. Follow the instructions on the screen.
6. Click **Restore** to start restoring the files, or click **Cancel** to cancel the operation.

11 Support

Contacting support

 **NOTE:** To access the *Ubuntu Desktop Guide*, press the **f1** key.

If the information provided in this user guide or in the *Ubuntu Desktop Guide* does not answer your questions, you can contact support. For U.S. support, go to <http://www.hp.com/go/contactHP>. For worldwide support, go to http://welcome.hp.com/country/us/en/wwcontact_us.html.

Here you can:

- Chat online with an HP technician.

 **NOTE:** When support chat is not available in a particular language, it is available in English.

- E-mail HP support.
- Find support telephone numbers.
- Locate an HP service center.

Labels

The labels affixed to the computer provide information you may need when you troubleshoot system problems or travel internationally with the computer.

 **IMPORTANT:** All labels described in this section will be located in one of 3 places depending on your computer model: affixed to the bottom of the computer, located in the battery bay, or under the service door.

- Service label—Provides important information to identify your computer. When contacting support, you will probably be asked for the serial number, and possibly for the product number or the model number. Locate these numbers before you contact support.

Your service label will resemble one of the examples shown below. Refer to the illustration that most closely matches the service label on your computer.



Component

(1) Serial number

(2) Product number

Component

(3) Warranty period

(4) Model number (select models only)

- Regulatory label(s)—Provide(s) regulatory information about the computer.
- Wireless certification label(s)—Provide(s) information about optional wireless devices and the approval markings for the countries or regions in which the devices have been approved for use.

12 Specifications

Input power

The power information in this section may be helpful if you plan to travel internationally with the computer.

The computer operates on DC power, which can be supplied by an AC or a DC power source. The AC power source must be rated at 100–240 V, 50–60 Hz. Although the computer can be powered from a standalone DC power source, it should be powered only with an AC adapter or a DC power source supplied and approved by HP for use with this computer.

The computer can operate on DC power within the following specifications. Operating voltage and current varies by platform.

Input power	Rating
Operating voltage and current	19 V dc @ 2.1 A - 40 W
	19.5 V dc @ 2.31 A - 45 W
	19.5 V dc @ 3.33 A - 65 W
	19.5 V dc @ 4.62 A - 90 W
	19.5 V @ 6.15 A - 120 W
	19.5 V @ 7.69 A - 150 W
	19.5 V dc @ 10.25 A -- Slim 200 W
	19.5 V dc @ 11.79 A -- Slim 230 W

DC plug of external HP power supply



 **NOTE:** This product is designed for IT power systems in Norway with phase-to-phase voltage not exceeding 240 V rms.

 **NOTE:** The computer operating voltage and current can be found on the system regulatory label.

Operating environment

Factor	Metric	U.S.
Temperature		
Operating	5°C to 35°C	41°F to 95°F
Nonoperating	-20°C to 60°C	-4°F to 140°F
Relative humidity (noncondensing)		
Operating	10% to 90%	10% to 90%
Nonoperating	5% to 95%	5% to 95%
Maximum altitude (unpressurized)		
Operating	-15 m to 3,048 m	-50 ft to 10,000 ft
Nonoperating	-15 m to 12,192 m	-50 ft to 40,000 ft

13 Electrostatic Discharge

Electrostatic discharge is the release of static electricity when two objects come into contact—for example, the shock you receive when you walk across the carpet and touch a metal door knob.

A discharge of static electricity from fingers or other electrostatic conductors may damage electronic components. To prevent damage to the computer, damage to a drive, or loss of information, observe these precautions:

- If removal or installation instructions direct you to unplug the computer, unplug it after being properly grounded and before removing a cover.
- Keep components in their electrostatic-safe containers until you are ready to install them.
- Avoid touching pins, leads, and circuitry. Handle electronic components as little as possible.
- Use nonmagnetic tools.
- Before handling components, discharge static electricity by touching an unpainted metal surface of the component.
- If you remove a component, place it in an electrostatic-safe container.

If you need more information about static electricity or assistance with component removal or installation, contact support.

14 Accessibility

HP designs, produces, and markets products and services that can be used by everyone, including people with disabilities, either on a stand-alone basis or with appropriate assistive devices.

Supported assistive technologies

HP products support a wide variety of operating system assistive technologies and can be configured to work with additional assistive technologies. Use the Search feature on your device to locate more information about assistive features.

 **NOTE:** For additional information about a particular assistive technology product, contact customer support for that product.

Contacting support

We are constantly refining the accessibility of our products and services and welcome feedback from users. If you have an issue with a product or would like to tell us about accessibility features that have helped you, please contact us at (888) 259-5707, Monday through Friday, 6 A.M. to 9 P.M. Mountain Time. If you are deaf or hard-of-hearing and use TRS/VRS/WebCapTel, contact us if you require technical support or have accessibility questions by calling (877) 656-7058, Monday through Friday, 6:00 a.m. to 9:00 p.m. Mountain Time.

Index

- A**
 - accessibility 51
 - administrator password
 - creating 36
 - entering 37
 - managing 36
 - antivirus software, using 37
 - audio functions, checking 10
- B**
 - backing up software and information 38
 - backups 43
 - battery
 - charging 21
 - conserving power 22
 - disposing 23
 - life 21
 - low battery levels 22
 - power 20
 - storing 22
 - temperature 22
 - best practices 1
 - Bluetooth device 4, 7
 - Bluetooth label 47
 - bottom 47
- C**
 - cables
 - DisplayPort 12
 - HDMI 12
 - USB 25
 - VGA 10
 - caring for your computer 32
 - charging batteries 21
 - checking audio functions 10
 - cleaning your computer 32
 - configuring audio for HDMI 13
 - connecting to a WLAN 7
 - conservation, power 22
 - corporate WLAN connection 7
 - critical battery level 22
- D**
 - default settings, restoring 41
 - digital card
 - inserting 27
 - DisplayPort
 - connecting 12
 - drive media 19
- E**
 - electrostatic discharge 50
 - entering a power-on password 37
 - entering an administrator password 37
 - external monitor port 10
- F**
 - factory settings, restoring 41
 - fun things to do 1
- H**
 - HDMI
 - configuring audio 13
 - HDMI port
 - connecting 12
 - Hibernation
 - exiting 19
 - initiated during critical battery level 22
 - initiating 19
 - high-definition devices,
 - connecting 12
 - HP PC Hardware Diagnostics (UEFI)
 - downloading 42
 - using 41
 - hubs 25
- I**
 - icons
 - network 4
 - wired network 4
 - wireless 4
 - input power 48
 - installing
 - optional security cable lock 38
 - Internet connection setup 5
- Internet security software, using 37
- L**
 - labels
 - Bluetooth 47
 - regulatory 47
 - serial number 46
 - service 46
 - wireless certification 47
 - WLAN 47
 - low battery level 22
- M**
 - managing a power-on password 37
 - managing an administrator password 36
 - mouse, external
 - setting preferences 14
- N**
 - network connection icons 4
- O**
 - operating environment 49
 - operating system 18
 - operating system, passwords set in 36
 - optical disc
 - inserting 28
 - removing 29
- P**
 - passwords
 - set in operating system 36
 - set in Setup Utility 36
 - ports
 - DisplayPort 12
 - external monitor 10
 - HDMI 12
 - VGA 10
 - power, conserving 22
 - power-on password
 - creating 37

- entering 37
- managing 37
- product name and number,
 - computer 46
- public WLAN connection 7

R

- readable media 19
- regulatory information
 - regulatory label 47
 - wireless certification labels 47

S

- scrolling TouchPad gesture 16, 17
- security cable lock, installing 38
- security, wireless 6
- serial number 46
- serial number, computer 46
- service labels
 - locating 46
- setup of WLAN 5
- Setup Utility
 - changing the language 40
 - displaying system information 41
 - exiting 41
 - navigating 40
 - passwords set in 36
 - restoring default settings 41
 - selecting 40
 - starting 40
- shipping the computer 33
- shutdown 18
- slot-load optical drive 29
- storing battery 22
- Suspend
 - exiting 19
 - initiating 19
- system information, displaying 41

T

- temperature 22
- TouchPad
 - using 15
- TouchPad gestures 17
 - scrolling 16
- traveling with the computer 22, 33, 47
- tray-load optical drive 28
- turning off the computer 18

U

- unresponsive system 18
- USB cable, connecting 25
- USB devices
 - connecting 25
 - description 25
 - removing 26
- USB hubs 25

V

- VGA port, connecting 10
- video 10

W

- webcam 9
- Wireless Assistant software 4
- wireless button 4
- wireless certification label 47
- wireless controls
 - button 4
 - operating system 4
 - Wireless Assistant software 4
- wireless icon 4
- wireless light 4
- wireless network (WLAN)
 - connecting 7
 - corporate WLAN connection 7
 - equipment needed 5
 - functional range 7
 - public WLAN connection 7
 - security 6
 - using 5
- wireless network, securing 38
- WLAN device 5, 47
- WLAN label 47
- writable media 19